



# ***taranto***



LINEA LIVIANA **2023**



## Nuestros Productos

### Junta Tapa de Culata

- ▶ Eliminación del retorque en juntas terminación 07 y 08.
- ▶ Mayor resistencia mecánica y térmica.
- ▶ Compuestos sellantes especiales que aseguran la máxima estanqueidad.
- ▶ Utilización de materiales ecológicos.



### Juego de Juntas para Motor



- ▶ Juego completo de reparación de motor con retenes.
- ▶ Empleo de materiales específicos a los distintos usos (Líquidos refrigerantes, aceites lubricantes, etc.)
- ▶ Compuestos sellantes que aseguran la máxima estanqueidad en los motores.
- ▶ Uso de materiales ecológicos.

### Retenes



- ▶ Excelente sellabilidad.
- ▶ Óptimo desempeño funcional en distintos medios.
- ▶ Óptima resistencia al desgaste.
- ▶ Facilidad de montaje.
- ▶ Larga vida útil.

### Tornillos de Culata

- ▶ Indispensable para el buen funcionamiento del motor.
- ▶ Diseñados para resistir altas sollicitaciones.
- ▶ Resisten las altas temperaturas.



# INDICE - CATALOGO VEHICULAR

## INDEX - AUTOMOTIVE CATALOG

En este Catalogo usted puede encontrar todos los artículos para las aplicaciones en las líneas vehicular, pesada y asiáticas. Para facilitar su búsqueda Taranto le ofrece dos metodologías distintas de búsqueda:

In this Catalog you can find all the articles for the applications in light lines, heavy duty lines and asiatic models. To facilitate your search Taranto offers two different methodologies:

### > SIMBOLOS - Symbols

## 11 INDICE ORDENADO POR REFERENCIA TARANTO

Index ordered by Taranto references.



Catálogo Vehicular  
Automotive Catalog



Catálogo Línea Asiática  
Asiatic Catalog



Catálogo Línea Pesada  
Heavy Duty Catalog

### TABLA DE REFERENCIAS / REFERENCE TABLE

Ref. PÁGINA				Ref. PÁGINA				Ref. PÁGINA				Ref. PÁGINA				Ref. PÁGINA			
TARANTO	LIVIANO	PESADO	ASIATICO	TARANTO	LIVIANO	PESADO	ASIATICO	TARANTO	LIVIANO	PESADO	ASIATICO	TARANTO	LIVIANO	PESADO	ASIATICO	TARANTO	LIVIANO	PESADO	ASIATICO
140000	148			222700	549			241000	39			252400	177			280000	68		
150000	388			222800	550			241100	40			252700	178			280100	69	13	
150100	389			223000	551			241200	41			252800	180			280200	70		
150200	390			223300	552			241300	42			252900	181			280300	71		
150300	391			223400	553			241400	43			253000	183			280400	72		93
200000	23			223500	554			241500	44			260000	184			280500	73		
200200	24			223800	555			241600	45			260100	185			280600	74		
200300	25			223900	556			241700	46			260200	186			280700	75		
200400	26	11		224000	557			241800	47			260300	187			280800	76		
200500	27			224200	558			241900	48			260400	188			281100	77	14	
200600	28	12		224300	559			242000	49			260500	189			281200	78		
200800	29			230000	560			242100	50			260600	190			281300	79		
200900	30			230100	561			242200	51			260700	191			281400	80		
210000		05		230200	562			242300	52			260800	192			281500	81		
210100		06		230300	563			242500	53			260900	193			281600	82		
210200		07		230400	119			242700	54			261100	194			281700	83		
210300		08		230500	564			242800	55			270000	195			281800	84		
210400		15		230600	565			242900	56			270100	197			281900	85		
210500		16		230700	566			243300	57			270200	199			282000	86		
210600		17		230800	120			243400	58			270300	200			282100	87		
210700		18		230900	567			243500	59			270400	202			282200	88		
210800		09		231100	568			244000	60			270500	204			282300	89		
210900	147			231200	569			244100	61			270600	205			282400	90		
220000	114			231300	570			244200	62			270700	206			282500	91		
220100	115			231400	571			244300	63			270900	207			282600	92		
220300	532			231500	572			244400	64			271100	208			290000	93		
220400	533			231600	573			244500	65			271200	210			290100	94		
220500	116			232400	574			244600	66			271300	211			290200	95		
220600	534			232600	575			244700	67			271500	212			290300	96		
220700	117	47		233000	576			250000	157			271800	213			290600	97		
220800	535			233100	577			250100	158			271900	214			290700	98		
220900	118			233200	578			250200	159			272000	215			290800	99		
221000	536			233300	579			250400	160			272100	216			290900	100		
221100	537			233400	580			250500	162			272200	217			291000	101		
221400	538			233500	581			250600	164			272300	218			291100	102		
221500	539			233900	582			250700	166			272400	219			291200	103		
221600	540			234000	583			250800	167			272500	220			291300	104		
221700	541			240000	31			250900	168			272600	221			291400	105		
221800	542			240100	32			251000	169			272700	222			291700	106		
221900	543			240200	33			251100	170			272800	223			291800	107		
222000	544			240300	34			251400	172			272900	224			291900	108		
222100	545			240400	35			251700	173			273000	225			300000	241		
222200	546			240700	36			252000	174			273500	226			300100	242		
222500	547			240800	37			252100	175			273600	227			300200	243		
222600	548			240900	38			252300	176			273700	228			300300	244		

# INDICE - CATALOGO VEHICULAR

## INDEX - AUTOMOTIVE CATALOG

TABLA DE REFERENCIAS / REFERENCE TABLE

Ref.				Ref.				Ref.				Ref.				Ref.			
TARANTO		PÁGINA		TARANTO		PÁGINA		TARANTO		PÁGINA		TARANTO		PÁGINA		TARANTO		PÁGINA	
LIVIANO	PESADO	ASIATICO	LIVIANO	PESADO	ASIATICO	LIVIANO	PESADO	ASIATICO	LIVIANO	PESADO	ASIATICO	LIVIANO	PESADO	ASIATICO	LIVIANO	PESADO	ASIATICO		
300400	245		320700	294		340300	334		410000	376	218	461100	425						
300500	246		320800		172	340400	335		410100		219	461200	426						
300600	247		320900	295		340500	336		410200		220	461500	427						
300700	248		321000	296		340600	337		410300		221	470000	428						
300800	249		321100	297		340700	338		410400		222	470200	429						
300900	250		321200	298		340800	339		410500		223	470300	430						
301000	251		321300	299		340900	340		410600	377	224	470400	431						
301100	252		321400	300		350000		125	410700		225	470500	432						
301200	253		321500	301		350100		126	410800	378	226	470600	433						
301400	254		321600	302		350200		127	410900	379	227	470700	434						
301500	255		321700	303		350300		128	420000		228	470800	435						
301700	256		321800	304		350400		130	420100		229	470900	436						
301800	257		321900	305		350500	348		420200		230	471000	437						
301900	258		322000	306		350600		132	420400		231	471200	438						
302000	259		322100	307		350800		134	420600	380	232	471300	439						
302100	260		322200	308		350900		135	422000		233	471400	440						
302200	261		322300	309		351000		137	423000		01	471500	441						
302300	262		322400	310		351100	349		423100		02	471700	442						
302400	263		322500	311		351200	350		423200		03	471800	443						
302500	264		322600	312		351300	351		430000	365		471900	444						
302700	265		322700	313		351500	352		430600	366		472000	445						
302800	266		322800	314		351600	353		430800	367		472100	446						
302900	267		322900	315		351700	354		440000		179	472200	447						
303000	268		323200	316		351800	355		440100		180	472300	448						
303100	269		323300	317		352000		138	450000	392		500000	453						
303200	270		323700	318		352100	356		450100	394		500100	454						
303300	271		323900	319		352200		139	450200	395		500200	449						
303400	272		324000	320		352400	357		450300	397		500300	451						
303500	273		324100	321		353200	358		450400	399		500400	521						
303600	274		324300	322		360000		141	450500	401		500600	452						
303800	275		324400	323		360100	359	142	450600	403		510000	121						
303900	276		324600	324		360200		143	450800	404		510100	122						
310000	277		324700	325		360300		144	450900	406		510200	123						
310100	278		324800	326		360400		145	451200	407		510400	124						
310200	279		324900	327		360500	360		451300	408		510500	125						
310300	280		325100	328		360800		147	451500	409		510700	126						
310400	368	167	325200	329		370100	361		451600	410		510800	127						
310500		169	325400	330		400000	373	201	451700	411		510900	128						
310600	281		330000		76	400100		202	451800	420		520100	129						
310700	282		330100		77	400200		203	451900	412		520200	130						
310800	283		330200		78	400300	374	204	452000	413		520300	522						
310900	284		330300	331		400400		205	452100	414		520400	523						
311000	285		330400		173	400500		206	452200	415		520500	131						
311100	286	75	330500	370		400600		207	460100	416		520600	132						
311200	287		330600	371		400700		208	460200	417		520800	133						
320000	288		330700		174	400800		209	460300	418		520900	134						
320100	289		330800		176	400900		210	460400	419		521000	135						
320200	290		331100	372		401000	375	211	460500	420		521100	136						
320300	291		331200		177	401100		212	460600	421		521200	137						
320400		171	331300		178	401500		213	460700	422		521400	138						
320500	292		340100	332		401600		214	460800	423		521500	139						
320600	293		340200	333		401700		216	460900	424		521600	140						

# INDICE - CATALOGO VEHICULAR

## INDEX - AUTOMOTIVE CATALOG

**TABLA DE REFERENCIAS / REFERENCE TABLE**

Ref.	Página			Ref.	Página			Ref.	Página			Ref.	Página						
	TARANTO	LIVIANO	PESADO		ASIATICO	TARANTO	LIVIANO		PESADO	ASIATICO	TARANTO		LIVIANO	PESADO	ASIATICO	TARANTO	LIVIANO	PESADO	ASIATICO
521700	141			581300	506			770500		112	130	862900			39	901400			234
521800	142			581400	507			770600		113	131	863000			40	901500			235
521900	143			581700	508			770700		114	132	863100			41	901600			236
522000	144			581800	509			770800		115	133	863200			42	901700			237
522100	145			582100	510			800000		61		863300			43	901800			238
523000	146			582200	511			800100		63		863400			44	901900		181	239
540000	461			582300	512			800200		64		863500			45	902000		182	240
540100	462			582400	513			800300		65		863600			46	902100			241
540200	463			650000		31		800500		67		863700			47	902200			242
540300	464			650100		32		800600		69		863800			48	902300			243
540400	465			650200		33		800800		71		863900			49	902500			244
540500	466			650300		34		800900		72		864000			50	902600			245
540900	586			650400		35		801000		74		864100			51	902900			246
550000	467			650500		36		810000		235		864200			52	903400			247
550400	468			650600		37		810100		236		864300			53	903500			248
550500	469			650700		38		810200		238		864400			54	903600			249
550600	470			650800		39		810300		240		864500			55	903700			250
550700	471			650900		40		810400		242		864600			56	903800			251
550800	472			651000		41		810500		244		864700			57	904000			252
550900	473			660000		43		810600		245		864800			58	904100			253
560000	474			660100		44		810700		246		864900			59	904500			254
560100	475			660200		45		810800		247		865000			60	904600			255
560200	476			700000		49		850000		87		865100			61	904700			256
560300	477			700100		50		850100		88		870000		19		904800			257
560400	478			700200		51		850200		89		870100		21		904900		183	258
560500	479			700300		52		850300		90		870200		23		905000			259
560600	480			700400		53		850400		91		870500		25		905100			260
560700	481			700500		54		850500		92		870600		26		905200			261
560800	482			700600		55		850600		93		870700		27		905300			262
570000	483			700700		56		850700		94		870800		28		905400			263
570100	484			700800		57		860000	517			870900		29		905500			264
570200	485			700900		58		860100	518			871000		30		905600			265
570300	486			710100		59		860200			19	880000		255		905700			266
570400	487			710200		60		860300			20	880100		257		905800			267
570500	488			750000		79		860400			21	880200		259		905900		184	268
570600	489			750100		80		860500			22	880300		261		906000			269
570900	490			750200		81		860600			23	880400		263		906100			270
571000	491			760000		95	113	860700			24	880500		265		906200			271
571100	492			760100		97	115	860800			25	880600		267		906300			272
571200	493			760200		98	116	860900			26	880700		269		906400			273
571300	494			760300		99	117	861000			27	880800		271		906500			274
571400	495			760400		100	118	861100			28	890100	585			906600			275
580000	496			760500		101	119	861200			29	890600	519			906700		185	276
580100	497			760600		102	120	861300			30	900000		229		906800		186	277
580200	498			760700		103	121	861400			31	900100		230		906900			278
580400	499			760800		104	122	861500			32	900200		335		907000		187	279
580500	500			760900		105	123	861600			33	900500		231		907100		188	280
580600	501			770000		107	125	861900			34	900600		232		907200		189	281
580700	502			770100		108	126	862300			35	900700		01		907300		190	282
580900	503			770200		109	127	862500			36	900800		02		907400		191	283
581000	504			770300		110	128	862700			37	900900		99		907500			284
581200	505			770400		111	129	862800			38	901300		233		907600			285

# INDICE - CATALOGO VEHICULAR

## INDEX - AUTOMOTIVE CATALOG

TABLA DE REFERENCIAS / REFERENCE TABLE

Ref. Página				Ref. Página				Ref. Página				Ref. Página				Ref. Página			
TARANTO	LIVIANO	PESADO	ASIATICO	TARANTO	LIVIANO	PESADO	ASIATICO	TARANTO	LIVIANO	PESADO	ASIATICO	TARANTO	LIVIANO	PESADO	ASIATICO	TARANTO	LIVIANO	PESADO	ASIATICO
907700			286	921900			341	950200	03			964400			208	974400		121	163
907800		192	287	922100			342	950300			170	964500			209	974500		122	164
907900		193	288	922200			343	950400			380	964600			210	974600		123	165
908000			289	922300			344	950500			301	964700		154	211	974700			166
908200		194	290	922400			346	950600			171	964800			212	980000	04		
908300		195	291	922500			347	950700			172	964900			213	980200	05		
908400		196	292	922800			348	950800			173	965000			214	980500	06		
908500		197	293	922900			349	951000			302	965100		155	215	981100	07		
908600		198	294	923000			350	951100			303	965200		156	216	981200	08		
908700		199	295	923300			351	951200			304	965300		157	217	981300	09		
908800			296	923500			352	951400			305	965400		158	218	981400	10		
910000			100	923600			353	951500			306	965500		159	219	981500	11		
910100			101	923900			354	951600			174	965600		160	220	981700	12		
910200			315	924000			355	951700			175	965700		161	221	981900	13		
910300			316	924100			356	951800			307	965900		162	222	982000	14		
910400			317	924300			357	951900			308	966000		163	223	990000			63
910500			167	924400		251	358	952000			309	966100		164	224	990300			64
910600			336	924500		252	359	952100			310	966200		165	225	990400			65
910700			168	924600			360	952400			311	966300		166	226	990500			66
910900		249	299	924700			361	952500			312	966400			227	990600			67
911000			102	924800			362	952600			313	970000			381	990700			68
911100			103	924900			363	960000			176	970300			135	990800			69
911200			104	925000			364	961000			177	970400			228	990900			70
911300			105	925100			365	961100			178	970500	341			991000			71
911400			106	925200			366	961200			179	970600	342			991100			72
911500			107	925300		253	367	961300			180	970700	343			991300			73
911700			108	925400			368	961500			181	971000			136	991400			74
911800			109	925700			369	961700			182	971100			137	991500			75
912000			110	925900			370	961800			183	971200		117	138	991600			76
912100			111	926100			371	961900			184	971300			139	991700			77
912200			112	926200			372	962100			185	971400			140	991800			78
916000			318	926400			373	962200			186	971500			141	991900			79
916100			319	926500		254	374	962300			187	971600			142	992100			80
916200			320	926600			375	962400			188	971800			143	992200			81
916300			321	926700			376	962500			189	972500			144	992300			82
916400			322	926800			377	962600			190	972600			145	992400			83
916500			323	927000			378	962700			191	972700			146	992500			84
916600			324	930100			94	962800		149	192	972800			147	992600			85
916700			325	930300			95	962900			193	972900			148	992700			86
916800			326	930500			96	963000			194	973000			149	992800			87
916900			327	930600			97	963100		150	195	973100			150	993000			03
917000			328	930700			379	963200			196	973200			151	993100			04
917100			329	940000			07	963300			197	973300			152	993200			05
917200			330	940100			08	963400			198	973400			153	993400			06
917300			331	948000			09	963500			199	973500			154	995000			88
920000			297	948100			10	963600			200	973600			155	995100		83	89
920100			337	948200			11	963700			201	973700			156	995200		84	90
920200			298	948300			12	963800			202	973800			157	995300		85	91
920400			338	948600			13	963900			203	973900			158				
920500			339	948700			14	964000			204	974000			159				
920600			169	949000			15	964100		151	205	974100		118	160				
920700			333	950000			16	964200		152	206	974200		119	161				
921800			340	950100			17	964300		153	207	974300		120	162				

# INDICE - CATALOGO VEHICULAR

## INDEX - AUTOMOTIVE CATALOG

A continuación presentamos nuestro índice ordenado por marca y cilindrada, para las aplicaciones en las líneas vehicular, pesada y asiáticas.  
Below we present our index ordered by brand and cylinder capacity, for applications in vehicular, heavy and Asian lines.

## 2 | INDICE ORDENADOS POR CM<sup>3</sup>.

Index ordered by cm<sup>3</sup>.

ACURA						
Ref.	Modelo/Model	Cm <sup>3</sup>	Motor/Engine			
863000	EL 2000/...	1396cc.	D14Z1/Z2 (SOHC) 16V 90HP Ø75		40	
860500	Integra 1986/89	1590cc.	D16A1 (DOHC) 16V 110HP Ø75		22	
863300	Integra VTEC 1992/93	1678cc.	B17A1 (DOHC) 16V 160HP Ø81		43	
863300	Integra, Integra Coupe 1993/01	1797cc.	F18C1 170HP - F18C2 200HP (DOHC) 16V Ø81		43	
864000	Integra GS/RS/LS 1995/95	1834cc.	B18B1 (DOHC) 16V 140HP Ø81		50	
860900	CL VTEC 1997/98	2156cc.	F22B8 (SOHC) 16V 150HP Ø80		26	
864800	CL VTEC 1997/98	2997cc.	J30A1 203HP (SOHC) 24V V6 Ø86		58	
864900	Legend 1991/96	3206cc.	C32A1 (SOHC) V6 24V 205HP Ø90		59	
AGCO/SISU						
423000	MF Case-IH CS 68/75 - Challenger, Valtra A65/A75, 305/355/365/405/455 465/555/565/600/700 SISU 320D, 320DS, 836640356	3300cc.	320D/DS 33/69HP Ø108			01
423100	MF4292/4297, Valtra A950/A990 (4x2, 4x4), BM100/BM110 (4x2, 4x4)	4400cc.	420DS Agco Sisu Power 117/120/129HP Ø108			02
423200	MF Case-IH CS/CVX 120/130/150, CVX 1135/1145/1155/1170/1190, Valtra 8000	6600cc.	620D/DS 147/189HP Ø108			03
AGRALE						
330500	Agrale TD, Micro/Buses livianos 2000/...	2796cc.	MWM 4.07 CA 131HP Ø93	370		
870800	AM100-E, AM150-E, AM200-E 2013/...	2776cc.	ISF2.8 (SOHC) 16V 150/156HP Ø94			28
330800	Camión TX 1600 1983/...	2942cc.	D229-3 72HP Ø102			176
330400	7000/7500/8500	4300cc.	4.10 X10 90HP - 4.10T/TCA 133/167HP Ø103			173
331200	8500/9200 - Commom Rail	4800cc.	4.12TCE (OHV) 8V 150/180HP Ø105			177
ALFA ROMEO						
270600	145/146/155/156 Twin Spark 16V 1996/...	1598cc.	676.01 (DOHC) 16V 120HP Ø82	205		
271800	145/146 Twin Spark 1996/..., 156 Twin Spark 1997/...	1598cc.	321.02 - 676.01 (DOHC) 16V 120HP Ø82	213		
273908	159, Spider Turbo 2009/...	1742cc.	939B1 200HP (DOHC) 16V Ø83	156		
270600	145 Twin Spark 1996/...	1747cc.	671.06/99 - 322.01 (DOHC) 16V 140/144HP Ø82	205		
271800	145/146/156 Twin Spark 1997/..., GTV Twin Spark 1998/00, Spider Twin Spark 1998/00	1747cc.	322.01 (DOHC) 16V 144HP Ø82	213		
291000	159 2005/...	1796cc.	939A4 (DOHC) 16V 140HP Ø80,5	101		
252100	156 TD 1997/00, 145 TD, 146 TD 1999/...	1910cc.	323.02 (SOHC) 8V 105HP Ø82	175		
252608	147 JTD 2000/..., 156JTD 2001/...	1910cc.	192B1/192A5/937A4/937A5 140HP 937A5 140/150HP 937A6 170HP (DOHC) 16V Ø82	151		
270000	146 TD 1994/99, 155 TD 1993/97	1929cc.	675.01 - 336.01 (SOHC) 8V 90HP Ø82.6	195		
500400	75TD 1984/92	1995cc.	VM80A (OHV) 8V 95HP Ø88	521		
500400	75TD 1989/92, 90TD 1984/97	2393cc.	VM81A (OHV) 8V 110HP Ø92	521		
500400	155TD 1993/97, 164TD 1987/92, 1992/98	2499cc.	VM84A 114HP - VM08B/VM07B 125HP VM31B/VM32B 125HP (OHV) 8V Ø92	521		
271007	166 1998/00 - 2000/..., GTV 1996/00 - 2001/..., Spider 2001/...	2959cc.	161.02/05 - 343.01 218/226HP 361.01 220HP Ø93	154		
271007	147, GTV 2003/...	3179cc.	932A 250HP - 936A6 240HP Ø93	154		
ASIA MOTORS						
900700	Towner 1993/...	843cc.	40HP (SOHC) 6V Ø70			01
900900	Roesta 1993/...	2184cc.	R2 72HP Ø86			99
900800	Topic, Hi-Topic 1993/...	2701cc.	SS 75HP (OHV) 8V Ø96			02
AUDI						
220400	4000, 80, 4E, 100, Fox 1979/83, Coupe 1980/81	1588cc.	YH/YP/YT/YK/YW/YS/YZ/VY/VZ 75110HP Ø79.5	533		
223207	80D/80TD/90TD 1985/91	1588cc.	JK/RA/SB/CY (SOHC) 8V 54/70/80HP Ø76.5	527		
230100	80 D/TD 1981/85	1588cc.	CR/JK/CY/JR (SOHC) 8V 54/70HP Ø76.5	561		
224107/8	A3 2000/...	1595cc.	AVU (SOHC) 8V 100HP Ø81	527		

# INDICE - CATALOGO VEICULAR

## INDEX - AUTOMOTIVE CATALOG

### AUDI

Ref.	Modelo/Model	Cm³	Motor/Engine			
230300	80 1993/95	1595cc.	ADA/ABM (SOHC) 8V 71/100HP Ø81	563		
233300	A3 FSI 2003/...	1598cc	BAG/BLP/BLF (DOHC) 16V 115HP Ø76,5	579		
220400	4000 1981/83	1715cc.	WT 79HP Ø79.5	533		
221700	A3 Turbo 1996/..., A3/A3 Quattro 1998/..., A6 1997/...	1781cc.	AJP/AGU/AQA 125/150HP - AJQ/APP 180HP Ø81	541		
221800	A4/A4 Turbo 1994/..., A6/A6 Turbo 1995/..., Cabrio 1997/..., A6 Quattro 1999/...	1781cc.	AEB/AJL/ANB 150/180HP AFY/ADR 125HP Ø81	542		
232908	TT TFSI - A3 FSI 2007/...	1798cc.	BYT/BZB/CDAA (DOHC) 16V	530		
223400	A3 TDI 1996/99	<b>DIESEL</b> 1896cc.	AGR (SOHC) 8V 90/110HP Ø79.5	553		
223500	A4 TDI 2000/... - 2004/..., A6 TDI 2001/...	<b>DIESEL</b> 1896cc.	ATJ/BKE/AVF/AWX 8V 115/130HP Ø79.5	554		
230900	A4 D/TDI 1994/96-1997/00, A6 TDI, CabrioTDI 1994/96, 80TDI 1991/94	<b>DIESEL</b> 1896cc.	1Z/AFF/AHH/AFN/AVG/AHU 75/90/110HP Ø79.5	567		
232400	A3, A5 TDI 2009/..., A4, Q5 QUATTRO TDI 2009/...	<b>DIESEL</b> 1968cc.	CJCB/CMEA/CAGA/CBEA/CGLA 143/163HP Ø81	574		
222500	80 Quattro, 100 1993/95, 80 1991/95, 100 1993/94	1984cc.	ABK/ABT/AE (SOHC) 8V 90/101/115HP Ø82.5	547		
222600	80 Quattro, Coupe 1990/93, 100 1990/93	1984cc.	AAD/ABK/AE (SOHC) 8V 101/115HP Ø82.5	548		
232908	TT TFSI 2006/... A3/A4/A5 2008/... Q5/A4 2009/...	1984cc.	CCTA/CDNB/CBFA/CAEA 180/200HP Ø82,5	530		
233200	A3/A4/A5/Q5 TFSI 2008/... - A4/A5 Quattro 2010/...	1984cc.	CDNB/CDNC/CAEB/CBFA 180/211HP Ø82,5	578		
222200	80/80 Quattro, Coupe 1983/86, 90/100 1984/88	1994cc.	JS/HP/SK/KP (SOHC) 10V 113/115HP Ø81	546		
222200	100/200, Coupe, 90/90 Quattro 1984/91	2226cc.	KZ/KU/HY/KV (SOHC) 10V 115/137/165HP Ø81	546		
222700	100, 200 Avant, 100 Avant, Coupe, Cabriolet 1985/...	2309cc.	NF (SOHC) 10V 100/136HP Ø82.5	549		
222800	80/90 1985/94, Cabrio, Coupe 1990/95, A6 1994/..., Coupe Quattro 1985/95 80 Quattro 1991/94, 90 Quattro 1987/91	2309cc.	AAR/NG (SOHC) 10V 133HP Ø82.5	550		
223000	80 1991/1994, 80/80 Quattro, Cabriolet, 100/ 100 Quattro 1992/94, A4/A4 Quattro, A6/A6 Quattro 1994/... - Coupe 1991/95	2598cc.	ACZ/ABC (SOHC) V6 12V 144/150HP Ø82.5	551		
223000	100/100 Quattro, 80/80 Quattro, Coupe 1990/94, A4/A4 Quattro, A6/A6 Quattro 1994/..., Cabriolet 1991/94	2771cc.	AAH/ABC/AEJ (SOHC) V6 12 V 163/174HP Ø82.5	551		
232808	A6/A8 FSI 2006/...	2773cc.	BDX/CCDA/CCEA V6 190/209/220HP Ø84.5	530		
232808	Q7/Q5 Quattro - A8 Quattro 2010/... - A5 Cabriolet/Coupe 2011/... A4/A8/A6 Quattro 2012/...	2995cc.	CJTC/CJTB/CMDA/CNAA/CTTA/CTWA/CTWB CTUC/CTVA 272/310/333HP V6 24V Ø84.5	530		
232808	A4 - A6 - A8 2005/... - A4 - A6 Quattro 2006/...	3123cc.	BKH/AUK/BPK/BKH/BYU V6 24V 255HP Ø84.5	530		
232508	A3 2005/..., TT 2006/...	3189cc.	BUB 184/250HP VR6 (DOHC) 24V Ø84	530		
232508	TT 2003/06, A3 2004/05	3189cc.	BHE/BPF/BDB 250HP VR6 (DOHC) 24V Ø84	530		
232308	A8 TDI 2000/02	3328cc.	AKF 224HP Ø78.3	530		
232708	Q7 2006/...	3597cc.	BHK/VR6 V6 (DOHC) 24V 280HP Ø89	530		
232207	A8 1995/98	3697cc.	AEW/AKJ 230HP (DOHC) V8 32V Ø84,5	530		
232308	A8 TDI 2003/05	3936cc.	275HP Ø78.3	530		
232308	A8 TDI 2005 - Q7 2007/09	4134cc.	BMC/BTR/BVN 320/326HP	530		
232207	A8 1991/93, 100 1992/94, S6 1994/96	4172cc.	ABH 280HP AEC/ABZ 290/299HP V8 32V Ø84,5	530		

### BEDFORD

210800	C14 - J17/J27/J37 1962/64	<b>DIESEL</b> 3285cc.	200D 62HP Ø98.3			09
210000	J6 1961/71	<b>DIESEL</b> 4927cc.	300D 97HP Ø98.3			05
210200	C50 Turbo 1971/79	<b>DIESEL</b> 4927cc.	300DX 97HP Ø98.3			07
210300	J6 1956/61	<b>DIESEL</b> 4927cc.	300D 97HP Ø98.3			08
210100	350H, C60, 714 1971/79	<b>DIESEL</b> 5755cc.	350D - CD600 137HP Ø106.36			06

### BMW

981400	1500 1962/86, 1502	1499cc.	M10 B15 (SOHC) 8V 70HP Ø84	10		
981400	316 (E21) 1975/84, 1600 (E6), 1602, 1600 Ti (E10) 1600 GT	1573cc.	M10 B16 (SOHC) 8V 73/84/90/103HP Ø84	10		
980307	316i 1993/98	1596cc.	M43 (164E2) (SOHC) 8V 102HP Ø84	01		
981100	318TDS 1994/99, 318 Compact TDS 1995/00	<b>DIESEL</b> 1670cc.	M41D (174T1) (SOHC) 8V 90HP Ø80	07		
980707	318/518 1975/80	1766cc.	M10 (SOHC) 8V 98HP Ø89	01		
981400	1800 1963/68	1773cc.	M10 (SOHC) 8V 90HP Ø84	10		
980307	318i 1987/93, 518i 1989/94	1796cc.	M40 (184E1) (SOHC) 8V 113HP Ø84	01		
981807	318is, 318 ti 1993/95	1796cc.	M42 (184S1) (DOHC) 16V 140HP Ø84	02		



# INDICE - CATALOGO VEHICULAR

## INDEX - AUTOMOTIVE CATALOG

### BMW

Ref.	Modelo/Model	Cm <sup>3</sup>	Motor/Engine			
982000	316i, 316ci Coupe, 316ti 2000/...	1796cc.	N42B18A (VALVETRONIC) - N40B16A 115HP Ø84	14		
950200	320, 520 1977/82	1990cc.	M20 (SOHC) 12V 122HP Ø80	03		
980000	520i 1982/90, 1987/90, 320i 1982/93 - 1988/91	1990cc.	M20 (206KA) 125/129HP - 206EE 130HP Ø80	04		
980707	320/520 1972/78 - 1978	1990cc.	M10 (SOHC) 8V 109/105HP Ø89	01		
981700	520i, 320i 1989/92	1991cc.	M50 (206S1) (DOHC) 24V 150HP Ø80	12		
982000	318ti, 318ci Cabrio, 318ci Coupe 2000/... - 320is 2001/..., 318ci Cabrio, 318ci Coupe, 318ti 2003/..., X3i 2003/..., Z4i 2004/...	1995cc.	N42B20A (VALVETRONIC) - N46B20A/B20C 143HP - N46B20B 150HP Ø84 (DOHC) 16V	14		
982008	318i 2004/07	1995cc.	N46B20BD (VALVETRONIC) 16V 150HP Ø84	02		
950200	323i 1977/82	2315cc.	M20 (SOHC) 12V 142HP Ø80	03		
980000	323i 1982/86	<b>DIESEL</b> 2315cc.	M20 (236EE) (SOHC) 12V 139/150HP Ø80	04		
980500	324 D 1985/90, 524 D 1986/87, 324 TD 1987/93, 524 TD 1982/87	2443cc.	M21(246D/DA) 86HP M21 (246TB/TA) 115HP Ø80	06		
980107	325i Base 1987/93, 325i, 325ix 1985/93, 325ix Base, 325 KAT 1988/91	2494cc.	M20 168HP - M20 (256E1/E2/K1/K2) 171HP Ø84	01		
981900	323i, 523i 1995/99, 323 ti 1999/00	2494cc.	M52 B25 (256S3/S4) (DOHC) 24V 163/170HP Ø84	13		
981500	523i 2005/..., 323i, 325i, 325xi, X3i, Z4i 2006/...	2497cc.	N52B25A 177/218HP Ø82 (DOHC) 24V	11		
982108	323i, 523i, 325i, 325xi, 525xi 2004/...	<b>DIESEL</b> 2497cc.	N52B25A (DOHC) 24V 177/218HP Ø82	02		
980200	325 TD 1991/92, 525 TDS 1990/92	<b>DIESEL</b> 2498cc.	M51 (256T1) 115HP - M51 (256T1-L) 143HP Ø80	05		
981200	725 TDS 1995/..., 325 TD/TDS, 525 TD/TDS 1994/...	2498cc.	M51 (256T1/T1-L) 115/143HP 143HP Ø80	08		
980107	325e 1983/86 - 525e 1987/90	2693cc.	M20 (276KA/KB) (SOHC) 12V 123HP Ø84	01		
981900	328i 1995/99, 528i 1995/00, 728i 1995/01, Z3 Coupe 1998/00, Z3 Roaster 1996/00	2793cc.	M52 B28 (256S1/S2) (DOHC) 24V 193HP Ø84	13		
980907	530i KAT 1988/91- 730i KAT 1986/92	2986cc.	M30 (306KA) (SOHC) 12V 188HP Ø89	01		
982207	730i, 530i 1992/96	2997cc.	M60 (308S1) (DOHC) V8 32V 218HP Ø84	02		

### CATERPILLAR

960550	Caterpillar	<b>DIESEL</b>	3054 - 4 Cilindros			I-26
960551	Caterpillar	<b>DIESEL</b>	3056 - 6 Cilindros			I-26
960548	Caterpillar Motoniveladora	<b>DIESEL</b>	6969cc. 3304 - 4 Cilindros Ø120.65			I-26
960549	Caterpillar Motoniveladora	<b>DIESEL</b>	10453cc. 3306 - 6 Cilindros Ø120.65			I-26

### CHERY

993000	QQ 2003/...	796cc.	SQR 372 F (DOHC) 12V 70HP Ø72		03	
993100	QQ3, IQ, Sweet	1097cc.	SQR 472 F (DOHC) 16V 90HP Ø72		04	
993400	Face 2011/...	1297cc.	473 H (DOHC) 16V 83HP Ø73		06	
993200	Tiggo 2010/...	1971cc.	Acteco S9R 484F (DOHC) 16V 125HP Ø83.5		05	



### CHEVROLET/GM/OPEL/VAUXHALL

282500	Spark 2003/06, Aveo 2006/...	995cc.	B10S (SOHC) 8V 63HP Ø68.5	91		
240900	Corsa 1.0 EFI, B10 NZ 1994/...	996cc.	OHC 60HP Ø71	38		
241200	Celta 2000/...	999cc.	MPFI (SOHC) 8V 60HP Ø71.1	41		
243300	Celta, Classic, Corsa 2003/...	999cc.	MPFI VHC 60HP Ø71.1	57		
244200	Prisma, Onix	999cc.	SPE/4 80HP Ø71,1	62		
244600	Onix 2020/...	999cc.	Ecotec 1.0 (DOHC) 12V 82HP Ø74	66		
244700	Onix, Tracker 2020/...	999cc.	Ecotec 1.0 (DOHC) 12V 116HP Ø74	67		
280500	Corsa 1998/...	999cc.	MPFI (DOHC) 16V 68HP Ø71.1	73		
240900	Corsa B 1993/97	1196cc.	C12NZ - 12NZ - X12SZ 45HP Ø72	38		
241100	Corsa A 1990/93, Kadett E 1986/91, Nova 1985/...	1196cc.	12NV - 12ST 54/55HP Ø77.8	40		
241300	Kadett D, Kadett E 1979/86, Cavalier, Astra 1980/85	1297cc.	13N/S - 13NS/SC 60/70/75HP Ø75	42		
291400	Aveo 2008/..., Aveo, Volt 2011/..., Cruze 2011/..., 2013/...	1362cc.	LUV - ECOTEC (DOHC) 16V 138/140HP Ø72.5	105		
240400	Corsa 1.4 EFI	1389cc.	C14 NV/NZ (SOHC) 8V 60/75HP Ø76.5	35		
241000	Celta MPFI 2004/...	1389cc.	C14E Familia I 85HP Ø77.6	39		
244000	Corsa 1.4 Econoflex, Classic, Agile, Celta 2006/2009 - 2009/...	1389cc.	X14SE/Y14NE - MPFI (SOHC) 8V 90/92HP Ø77,6	60		
244300	Prisma, Onix	1389cc.	SPE/4 106HP Ø77,6	63		
282300	Corsa 2002/04	1389cc.	Z14XE - Ecotec (DOHC) 16V 90HP Ø73.4	89		
200800	Chevette 1973/89	1393cc.	GMC 85 45HP Ø82	29		

# INDICE - CATALOGO VEHICULAR

## INDEX - AUTOMOTIVE CATALOG



### CHEVROLET/GM/OPEL/VAUXHALL

Ref.	Modelo/Model	Cm³	Motor/Engine			
291400	Aveo 2008/..., Aveo, Volt 2011/..., Cruze 2011/..., 2013/...	1398cc.	ECOTEC (DOHC) 16V 100/149HP Ø73.4	105		
291000	Aveo 2009/...	1399cc.	F14D4 (DOHC) 16V 101HP Ø73.4	101		
291700	Cruze, Tracker, Astra 2017/..., Equinox 2020/...	1399cc.	LE2 Ecotec (DOHC) 16V 150HP Ø73,8	106		
242607	Corsa A/D/TD 1987/92, Kadett E TD 1984/91, Nova 1991/96	<b>DIESEL</b> 1488cc.	15D (4EC1) - 15TD (4TEC1) 50/67/72HP Ø76	17		
291700	Cruze, Tracker, Astra 2017/..., Equinox 2020/...	1490cc.	LE2 Ecotec (DOHC) 16V 150HP Ø73,8	106		
240300	Monza, Kadett 1981/86	1598cc.	CN16 - 16SH 90HP Ø80.3	34		
240400	Corsa 1.6 MPFI, Ascona C 1986/88, Astra, Vectra A 1991/97, Corsa A GSI, Nova 1987/93, Kadett E 1986/91, Cavalier 1988/94	1598cc.	C16LZ/NZ/SV - E16ASE 75/82HP - X16SZ 71HP 16NZ/SV (SOHC) 8V 75/82HP Ø79	35		
242300	GM Corsa, Vectra, Kadett 1999/...	1598cc.	C1.6 SE - X16 SZR 8V 100/75HP Ø79	52		
242407	Kadett D, Kadett E 1984/86, Ascona C, Kadett E 1986/89, Ascona C, Belmont Cavalier 1982/86	<b>DIESEL</b> 1598cc.	16D 54HP - 16DA 60HP Ø80	17		
280600	Corsa, Opel, Tigra, Astra, Vectra 1993/...	1598cc.	C16XE - C16XEL (DOHC) 16V 109HP Ø79	74		
290100	Nubira 2003/05, Aveo MPI (103HP) 2004/...	1598cc.	F16 D3 (DOHC) 16V 103/109HP Ø79	94		
200800	Chevette 1973/89	1599cc.	GMC 98 71HP Ø82	29		
242500	Corsa, Astra G DTI, Corsa C DI, Combo Tour TD 2000/...	<b>DIESEL</b> 1686cc.	Y17 DT/DTL (DOHC) 16V 65/75HP Ø79	53		
280200	Corsa D, Combo D 1997/..., Vectra TD 1991/96, Astra TD 1994/97	<b>DIESEL</b> 1686cc.	4EE1 - 4EE1T 60/82HP Ø79	70		
241600	Astra 1991/94, Vectra A 1989/95, Astra Max 1990/..., Belmont 1989/91	<b>DIESEL</b> 1699cc.	17D/DR (SOHC) 8V 57/60HP Ø82.5	45		
241700	Astra TD, Astra F TD 1994/97	<b>DIESEL</b> 1699cc.	17DTL 68HP Ø82.5	46		
243500	Astra TD 1994/97, Astra GTD 1998/00 - Motor 14555260 08/1994	<b>DIESEL</b> 1699cc.	X17 DTL (SOHC) 8V 68HP Ø82.5	59		
241800	Corsa II, Meriva 2003/...	1781cc.	L79 (DOHC) 16V 122HP 80.5	47		
200200	Opel K180 1974/79	1790cc.	K180 Ø90.49	24		
240000	Monza 1.8 SLE/SEE, Kadett, Rekord 1983/...	1796cc.	C18N S/E 75/90HP Ø84.8	31		
240200	Monza 1996/..., Astra 1991/..., Kadett 1986/91, Ascona 1986/88, Vectra 1988/95, Blazer	1796cc.	C18NE FII 90HP Ø84.8	33		
242200	Corsa, Meriva 2003	1796cc.	GM Powertrain 102HP Ø80.5	51		
244100	Spin, Cobalt 2012/...	1796cc.	N18XFN 108HP Ø80.5	61		
244500	Spin, Cobalt 2017/...	1796cc.	SPE/4 111HP Ø80.5	65		
280000	Monza - Kadett 1986/91, Astra 1991/97 - Vectra 1989/95	1796cc.	C18NE/NV - C18NZ 90HP Ø84.5	68		
281600	Astra 2000/03	1796cc.	Z18XE ECOTEC (DOHC) 16V 120HP Ø80.5	82		
291000	Cruze 2008/..., Astra H, Zafira B 2004/..., Signum, Vectra C 2006/..., Insignia 2008/...	1796cc.	F18D4 - Z18XER - A18XER 16V 141HP Ø80.5	101		
291200	Astra MPFI 1999/...	1796cc.	MPFI 8V 110HP Ø84.8	103		
252608	Astra, Vectra 2004/..., Zafira 2005/...	<b>DIESEL</b> 1910cc.	Z19DTH (DOHC) 16V 143/150HP Ø82	18		
291100	Epica, Opra 2006/11, Captiva, Tosca 2007/..., Cruze 2009/..., Antara 2006/10	<b>DIESEL</b> 1991cc.	Z20S/DMH 150HP - Z20DM 121/126HP 16V Ø83	102		
290700	Astra, Vectra, Omega, Zafira, Opel	<b>DIESEL</b> 1995cc.	X20 DTL-DTH (SOHC) 16V 82/100HP Ø84	98		
582300	Vivaro CDTI 2006/08 - 2008/...	<b>DIESEL</b> 1995cc.	M9R 780/782/784/786/788 16V 90/114HP Ø84	512		
470800	Tracker 2001/04	<b>DIESEL</b> 1997cc.	108HP (SOHC) 8V Ø85	435		
240200	Kadett 1986/91, Ascona 1986/88, Vectra 1988/95	1998cc.	C20NE 115/130HP Ø86	33		
241500	Omega MPFI, Vectra MPFI 1992/98	1998cc.	OHC (SOHC) 8V 110/115/130HP Ø86	44		
241500	Frontera 1991/95, Calibra, Cavalier, Kadett 1986/91, Astra 1991/96, Omega A 1986/94	1998cc.	C20NE/SEH/SER/NEF 8V 100/115/130HP Ø86	44		
280700	Astra 1995/..., Omega B, Calibra 1994/...	1998cc.	X20XEV (DOHC) 16V 136HP Ø86	75		
281900	Astra 1995/98, Opra, Zafira 1998/...	1998cc.	X20 XEV (DOHC) 16V 128/136HP Ø86	85		
290800	Vectra, Astra, Calibra, Zafira 1994/..., Astra 1998/...	1998cc.	X20 XEV (DOHC) 16V 128/136HP Ø86	99		
290900	Vectra 1994/96, Calibra 1989/97, Kadett E 1987/91, Vectra Turbo 1993/95	1998cc.	C20XE 136/150HP - C20LET 204HP 16V Ø86	100		
291800	Cobalt 2008/10, Astra 2012/...	1998cc.	LNF - Ecotec I4 264HP Ø86 (DOHC) 16V	107		
241400	Vectra 1997/...	2000cc.	MPFI (SOHC) 8V 116HP Ø86	43		
290700	Vectra, Zafira, Omega, Frontera, Sintra	<b>DIESEL</b> 2171cc.	X22 DTH (SOHC) 16V 115/116HP Ø84	98		
281800	Cavalier 1998/03	2190cc.	LN2 (OHV) 8V 120HP Ø89	84		
290200	Lumina, Cavalier 1987/97, SS10 1997/99	2190cc.	LN2 (OHV) 8V 120HP Ø89	95		
290300	Lumina, Cavalier 1994/97	2190cc.	LM3 120HP Ø89	96		
242000	S10, Blazer, Omega 1994/...	2198cc.	MPFI/EFI (OHC) 8V 106HP Ø86	49		
243608	Pointiac 2002/...	2198cc.	Z22YH (DOHC) 16V 155HP Ø86	18		

# INDICE - CATALOGO VEHICULAR

## INDEX - AUTOMOTIVE CATALOG



### CHEVROLET/GM/OPEL/VAUXHALL

Ref.	Modelo/Model	Cm <sup>3</sup>	Motor/Engine			
282100	Cavalier, Malibu, HHR, Astra, Zafira, Vectra, Pontiac Sunfire, Grand Am 2000/03	2198cc.	Z22SE - L61 147HP Ø86 (DOHC) 16V	87		
290800	Vectra 1998/..., Sintra 1996/99	2198cc.	X22 XE (DOHC) 16V 139/141HP Ø86	99		
241400	Vectra 1997/...	2200cc.	MPFI (SOHC) 8V 123HP Ø86	43		
290407	Cavalier 1994/02	2200cc.	C134	21		
280400	Luv, Pick Up 1986/92, Campo .../1992, Brava 1990/94	2254cc.	4ZD1 (SOHC) 8V 88HP Ø89.3	72	93	
290000	Captiva 2008/...	2384cc.	LE5 (DOHC) 16V 174HP Ø88	93		
282400	Pontiac Sunfire, Grand Am, Malibu, Cavalier Z24, 1996/04 - Alero 1999/...	2392cc.	LD9 (DOHC) 16V 141/152HP Ø90	90		
243400	Astra 2004/..., S10 2005/..., Vectra 2006/...	2405cc.	Powertrain 147HP Ø87.5	58		
244400	Blazer, S10	2405cc.	C24SE (SOHC) 8V 147HP Ø87.5	64		
240100	Opala 153 1969/73, Opala A10 80/84/610 1976/...	2475cc.	GM 153 Ø101.6	32		
240800	Opala, C10, A10 1974/..., Comodoro, Caravan, A10 1980/84	2475cc.	GM151 90HP Ø101.6	37		
981200	Omega B TD 1994/96	<b>DIESEL</b> 2498cc.	U25TD/X25TD (SOHC) 12V 130HP Ø80	08		
240700	Pick Up Luv	<b>DIESEL</b> 2499cc.	4JA1 (OHV) 8V 76HP Ø93	36		
520300	Frontera A TD 1995/98	<b>DIESEL</b> 2499cc.	VM41B 115HP Ø92	522		
242900	Pontiac Vin E 1988/92	2500cc.	L4 - 151	56		
430000	Blazer TDI, S10TDI 1995/...	<b>DIESEL</b> 2507cc.	95HP Ø90.7	365		
291300	S10, Trail Blazer 2013/...	<b>DIESEL</b> 2776cc.	VM - CTDI 180HP Ø94	104		
291900	S10, Trail Blazer 2013/...	<b>DIESEL</b> 2776cc.	VM - CTDI 200HP Ø94	108		
330500	S10 TD, Blazer TD 2000/...	<b>DIESEL</b> 2796cc.	Sprint 4.07 CA (SOHC) 12V 125HP Ø93	370		
331100	Blazer, S10 2000/...	<b>DIESEL</b> 2796cc.	Sprint 4,07 TCA Commom Rail 12V 132HP Ø93	372		
241900	Cutlass, Century, Eurosport, Cavalier 1989/94	2800cc.	172 V6 2da. Generación / Cabeza de Aluminio	48		
242800	Citation, Celebrity, Century 1982/86	2800cc.	172 V6 Carburados	55		
243908	Vectra C DTI , Signum C DTI 2003/08 - 2005/09	<b>DIESEL</b> 2958cc.	Y30DT/Z30DT 177/184HP (DOHC) V6 24V Ø87.5	18		
291608	Captiva 2010/18	2997cc.	LF1, LFW V6 24V 150HP inyeccion directa	21		
241900	Cutlass, Century, Eurosport, Cavalier 1989/94	3100cc.	172 V6 2da. Generación / Cabeza de Aluminio	48		
281700	Malibu 2000/03	3136cc.	LG8 (OHV) V6 8V 171HP Ø89	83		
282200	Malibu 1997/99	3136cc.	LG8 (OHV) V6 12V 170HP Ø89	88		
200000	400 1964/72	3185cc.	194 Ø90.48	23		
282000	Venture, Impala, Monte Carlo, Alero, Gran Am, Aztek, Silhouette, Trans Sport 2000/03	3350cc.	LA1 (OHV) V6 12V 170HP Ø92	86		
282600	Venture 1997/99	3350cc.	LA1 (OHV) V6 12V 185HP Ø92	92		
200900	Chevrolet 3 ½ - Chevrolet 3 9/16 1939/53	3540cc.	216 - 224 - 235 Ø88.9	30		
200900	Chevrolet 3 ½ - Chevrolet 3 9/16 1939/53	3674cc.	216 - 224 - 235 Ø90.5	30		
200000	Super 1964/69, RS Malibu	3769cc.	230 Ø98.43	23		
200400	Apache C10 3.9/16, Camión 4400 1957/..., Bel Air, Impala 1953/62	3851cc.	235 130HP Ø90.48	26	11	
401000	Vehicular GM D20	<b>DIESEL</b> 3860cc.	Q20B4 (OHV) 12V Iny. Directa 70HP Ø98.4	375	211	
410600	GM D10/20/40 Aspirado Turbo	<b>DIESEL</b> 3860cc.	Q20B4.236 (OHV) 12V Iny. Directa 70HP Ø98.4	377	224	
280300	D20/D40, Pick Up D20	<b>DIESEL</b> 3990cc.	Maxion S4 102HP Ø100	71		
200000	Pick Up Chevy 1969/79	4047cc.	250 Ø98.43	23		
200300	Pick Up C10 1989/...	4097cc.	250 Ø98.47	25		
200500	Silverado, Pick Up 7B 1980/..., Cheyenne 1979/81	4097cc.	250 Ø98.43	27		
281300	Trail Blazer 2002/06	4160cc.	Atlas LL8 - L6 (DOHC) 24V 275HP Ø94	79		
330600	GM Silverado 3500HD 1997/..., Grand Blazer 1998/...	<b>DIESEL</b> 4200cc.	Sprint 6.07 TD 167HP Turbo Interc. 198HP Ø93	371		
200600	Camión 3 3/4 6500 1954/62, C10, C 14, C60 BR 1969/...	4277cc.	261 142HP Ø95.25	28	12	
290600	Capriche, Impala, Regal, Blazer MPFI 1996/98	4294cc.	262 V6 180/193HP Ø101.6	97		
242100	Pick Up 1988/93	4300cc.	262 V6	50		
242700	Pick Up 1986/92	4300cc.	262 TK V6 Ø101.6	54		
281400	Vortec, Silverado, Sierra, Suburban, Tahoe Yukon 2001/03	4800cc.	LY2 (OHV) 16V 295HP Ø96	80		
281400	Vortec, Silverado, Sierra, Suburban, Tahoe Yukon 2001/03	5300cc.	L59 (OHV) 16V 295HP Ø96	80		
280100	283/302/307/327 Carb., 327, 350 No Corvette, 350, Pick Up y Medianos, Camiones	5735cc.	GM C350 V8 Ø101.6	69	13	
280800	350 1986/93 No Corvette, Pick Up, Camiónes 350 1986/95	5735cc.	C350L V8 Ø101.6	76		

# INDICE - CATALOGO VEHICULAR

## INDEX - AUTOMOTIVE CATALOG

### CHEVROLET/GM/OPEL/VAUXHALL

Ref.	Modelo/Model	Cm³	Motor/Engine			
281100	Truck 1996/01, Vortec Vin R	5735cc.	C350 V8 Ø101.6	77		14
410900	Brasil D60 - D70 <span style="float: right;">DIESEL</span>	5840cc.	6-357 Veh 120HP - Agr. 91HP - Ind. 108HP Ø104	379		227
281500	Vortec, Silverado, Sierra, Suburban, Tahoe Yukon, Express, Pick Up 2500/3500 2001/03	5967cc.	LQ4 325HP Ø101.6	81		
281200	Silverado, GMC Sierra 2500/3500HD, Suburban GMC Yukon XL, Avalanche 2500 Kodiak 2001/04	8123cc.	L18 V8 550HP Ø108	78		

### CHRYSLER/DODGE/JEEP

220100	D1500, GT90, GT100 - Paikan 1971/...	1498cc.	Hillman 72HP Ø86	115		
273700	Renegade	1598cc.	E.torq Evo 110HP Ø80.5	228		
230400	Neón 1997/99	1796cc.	122 CID (SOHC) 16V 116HP Ø83	119		
220100	D1800 - Paikan 1971/...	1798cc.	Hillman 110HP Ø86	115		
961500	Vista - Colt 1992/94	1834cc.	4G93 (SOHC) 16V 120HP Ø81	113	181	
253000	Renegade 2015/... <span style="float: right;">DIESEL</span>	1956cc.	Multijet TD (DOHC) 16V 170HP Ø83	183		
460300	JPX <span style="float: right;">DIESEL</span>	1995cc.	XUD9 (SOHC) 8V 65/69HP Ø83	418		
550600	Wrangler 1983/86	1995cc.	J5R (SOHC) 8V Ø88	470		
230400	Neón, Cirrus, Stratus, Voyager 1996/01	1996cc.	ECB/420H (SOHC) 16V 132HP Ø87.5	119		
230800	Neón, Sebring, Avenger 1995/...	1996cc.	4A20 (DOHC) 16V 130/140HP Ø87.5	120		
521000	Neon 2000/05	1996cc.	ECB (SOHC) 16V 135HP Ø87,5	135		
521100	PT Crusier 2002/05	1996cc.	ECC (DOHC) 16V 150HP Ø87,5	136		
560000	Jeep Wagoneer TD 1984/95, Comanche TD 1986/88 <span style="float: right;">DIESEL</span>	2068cc.	852/J8S (SOHC) 8V 65/86HP Ø86	474		
520200	135 (EDR) Lebaron, Spirit, Shadow, Voyager, Phantom, Caravan, Daytona 1982/98	2213cc.	135 (EDR) (SOHC) 8V 177HP Ø87.5	130		
521200	Lebaron, Daytona Turbo 1989/...	2213cc.	135 (EDR) (SOHC) 8V 177HP Ø87.5	137		
910500	Pick Up Power Ram 50 TD 1983/85 <span style="float: right;">DIESEL</span>	2346cc.	4D55T (SOHC) 8V 67HP Ø91	113	167	
523000	Jeep Avenger, Patriot, Caliber, Compass, Sebring, Stratus 2007/... Journey, Compass 2009/...	2360cc.	ED3 - GEMA (DOHC) 16V 170/174HP Ø88	146		
521400	Stratus, Cirrus, Plymouth Breeze, Caravan, Grand Caravan, Grand Voyager 1995/00	2429cc.	EDZ (DOHC) 16V 150HP Ø87.5	138		
521500	Stratus 2002/6	2429cc.	EDZ (DOHC) 16V 150HP Ø87.5	139		
522100	PT Cruiser 2002/05	2429cc.	EDZ (DOHC) 16V 150HP Ø87.5	145		
510400	Dakota, Pick Up, Jeep Cherokee, Comanche, Wrangler, Renegade 1991/96	2464cc.	D150 121HP Ø98.4	124		
540000	Jeep Continental, Bergantín 1954/74	2470cc.	4L - 151 80HP Ø84.14	461		
520600	Stratus, Avenger, Sebring, Cirrus 1995/99	2497cc.	150 (H00) (SOHC) V6 24V 167HP Ø83.5	132		
500400	Voyager TD, Grand Voyager TD 1992/94 <span style="float: right;">DIESEL</span>	2499cc.	HR425CLI (M00) (OHV) 8V 118HP Ø92	521		
520300	Dakota TD, Grand Voyager TD 1995/..., Cherokee, Grand Cherokee TD 1997/... <span style="float: right;">DIESEL</span>	2499cc.	VM425TD (OHV) 8V 114/115HP Ø92	522		
520200	EDM (K00) Caravan, Grand Caravan, Grand Voyager, Saratoga 1986/95 EDT Voyager, Caravan, Lebaron, Daytona 1989/92	2501cc.	EDM (K00) 99/101HP - EDT 150HP Ø87.5 (SOHC) 8V	130		
521200	Voyager, Caravan, Saratoga, Lebaron, Daytona Turbo 1989/...	2501cc.	153 (EDT) (SOHC) 8V 150HP Ø87.5	137		
520800	Pick Up, Lebaron, Caravan 1981/89	2555cc.	G54B (SOHC) 12V 103HP Ø91.1	133		
964800	Pick Up D50, Colt 1978/80	2555cc.	4G54B (SOHC) 8V Ø91.1	113	212	
964900	Pick Up 1982/...	2555cc.	4G54B (SOHC) 8V Ø91.1	113	213	
352400	Grand Cherokee TD 2002/... <span style="float: right;">DIESEL</span>	2685cc.	ENF (DOHC) 20V 163HP Ø88	357		
220000	Valiant I/II/III/IV D100, D2800, Polara, Coronado, RT 1964/79	2788cc.	170 130HP Ø86.36	114		
540200	Utilitario, Jeep T80 1966/73	2966cc.	OHC 181 4B - 300/300S/380 Ø84.94	463		
520900	Pick Up, Caravan 1987/96, Spirit, Daytona 1990/93	2972cc.	6G72-181CID (SOHC) V6 12V 143HP Ø92	134		
520400	Jeep Cherokee, Grand Cherokee, Dakota, Caravan 2001/... <span style="float: right;">DIESEL</span>	3100cc.	VM531TD 142HP Ø92	523		
352808	Crossfire 2004/...	3199cc.	EGX/EGZ 218HP V6 18V Ø89,9	110		
510000	Caravan, Grand Caravan, Imperial, Voyager, New Yorker, Town & Country 1990/99	3301cc.	201 (R00) (OHV) V6 12V 152/162HP Ø93	121		
400000	D100/D200 1987/... <span style="float: right;">DIESEL</span>	3336cc.	4.203-P4-192Z (OHV) 8V 71HP Ø91.49	373		201
522000	Concorde, New Yorker LHS	3518cc.	EGE (DOHC) V6 24V 214HP Ø96	144		
220000	Valiant I/II/III/IV D100, Polara, Coronado, RT 1964/79	3687cc.	225 130HP Ø86,36	114		
521800	Dakota, Ram 1500, Durango 2000/09, Jeep Liberty, Grand Cherokee 2002/09	3701cc.	EKG (SOHC) V6 12V 210HP Ø93	142		
540100	Estanciera, Baqueano, Continental 1955/...	3705cc.	L226 110HP Ø84.14	462		

# INDICE - CATALOGO VEHICULAR

## INDEX - AUTOMOTIVE CATALOG

### CHRYSLER/DODGE/JEEP

Ref.	Modelo/Model	Cm <sup>3</sup>	Motor/Engine			
510100	Caravan, Grand Caravan, Voyager, New Yorker, Imperial, Town & Country 1991/99	3778cc.	231 (L00) (OHV) V6 12V 162/166HP Ø96	122		
521600	Voyager 2002/06 - Pacifica 2004/07	3778cc.	EGH (OHV) V6 12V 162HP Ø96	140		
510500	Dakota Pick Up 1996/...	3908cc.	EHC (OHV) V6 12V 174HP Ø99,3	12		
520100	Pick Up V6 1987/91	3910cc.	239 CID V6 130HP Ø99,31	129		
220700	Continental 3 3/8 - 3 7/16, D100/200/400/500 1951/64	3956cc.	241 95HP Ø85,73	117		47
220900	Grand Cherokee Laredo, Cherokee Sport, Comanche, Wagoneer, Wrangler 1986/91	3960cc.	240 - 242/L 185HP Ø98,4	118		
220700	Continental 3 3/8 - 3 7/16, D100/200/400/500 1951/64	4106cc.	251 100HP Ø87,31	117		47
510800	Grand Wagoneer 1984/88, Pick Up 1981/88, Scrambler 1981/86, Jeep CJ/DJ 1981/86	4200cc.	258 AMC Jeep 170HP Ø95,25	127		
510900	Wrangler, Jeep YJ 1986/90	4200cc.	258 AMC Jeep 170HP Ø95,25	128		
521700	Dakota, Ram 1500 2000/11, Grand Cherokee 1999/09, Aspen, Commander 2006/09	4698cc.	V8 Magnum 235HP Ø93	141		
400100	DP 400/500 1964/...	<b>DIESEL</b> 5004cc.	6.305 (SOHC) 12V Cadenero 100HP Ø91,44			202
440100	Camión 1978/...	<b>DIESEL</b> 5100cc.	D225-6 102HP Ø95			180
220500	GTX, Coupe 1970/...	5210cc.	318 V8 202HP Ø99,31	116		
510200	Barracuda, Super Bee 1970/74	5210cc.	318 LA V8 202HP Ø99,3	123		
510700	Grand Cherokee 1993/...	5210cc.	318 V8 215/223HP Ø99,3	126		
521900	Ram 2500/3500, Ram Quad, Charger, Jeep Comander, 300C, Grand Cherokee, Aspen	5645cc.	EZB - Hemi (OHV) V8 16V 345HP Ø99,5	143		
400200	DP 600/800 1968/...	<b>DIESEL</b> 5798cc.	6.354-2 140HP Ø98,47			203
400400	D600/800 1976/...	<b>DIESEL</b> 5798cc.	6.354-4 (OHV) 12V Turbo 172HP Ø98,42			205
400900	DP 600/800	<b>DIESEL</b> 5798cc.	6.354-1 (OHV) 12V 135HP Ø98,43			210
410900	P700D/ P900	<b>DIESEL</b> 5840cc.	6-357 Veh. 120HP - Agr. 91HP - Ind. 108HP Ø104			227
870100	Truck 359 1989/93, Ram 2007/...	<b>DIESEL</b> 5883cc.	6B (SOHC) 12V 330HP Ø102			21
520500	Charger, Dart GTS, Le Baron, Cordoba, Monaco, Super Bee, Camiónes Ligeros D350/D600 1979/92	5899cc.	360 (OHV) V8 16V - Con Carburador y T.B.I	131		

### CIMARRON

210500	1986/...	<b>DIESEL</b> 3283cc.	3300D 89HP Ø98,42			16
210400	1976/85	<b>DIESEL</b> 3285cc.	3300D 88HP Ø98,3			15
210600	1979/85	<b>DIESEL</b> 3840cc.	3800D 99HP Ø106,4			17
210700	1986/...	<b>DIESEL</b> 3840cc.	3800D 99HP Ø106,4			18

### CITROËN

150000	2CV, AZ, AZAM, AZN, AZU, AZUB 1966/68	425cc.	A 79/0 (OHV) 4V 24HP Ø66	388		
150100	2CV, AZL 1968/69	425cc.	A 79/1 (OHV) 4V 28HP Ø66	389		
150200	3CV 1969/78	602cc.	M28/0 - M28/1 (OHV) 4V 35HP Ø74	390		
150300	Ami 8, Mehari, Dyane, 3CV	602cc.	M28/0 - M28/1 (OHV) 4V 33HP Ø74	391		
460500	C15 1985/..., Visa 10 1986/88	954cc.	108C Ø70	420		
451500	C15 1988/..., AX 10 1986/..., Saxo 1996/...	954cc.	TU9 - TU9M (SOHC) 8V 41/45/50HP Ø70	409		
451800	Visa 11 1978/85, C15 1984/85	1124cc.	109/5 - 109/K 57HP Ø72	420		
451500	Saxo, Berlingo, ZX 1996/...	1124cc.	TU1M 6 (SOHC) 8V 0HP Ø72	409		
451700	AX11 1986/97 - BX 11 - C15 1988/... - ZX 1991/98	1124cc.	TU1M/MZ (SOHC) 8V 55HP Ø72	411		
460500	Visa 11, C15 1985/...	1124cc.	109/5 - 109/K 57HP Ø72	420		
460700	AX 11, BX 11, C15 1986/..., ZX 1991/95	1124cc.	TU1M/MZ (SOHC) 8V 55HP Ø72	422		
472100	C4, C4 Grand Picasso 2014/..., C3 Picasso, DS3/DS4 2015/..., C4 Picasso 2016/...	1199cc.	EB2DT/DTS 110/130HP (DOHC) 12V Ø75	446		
451800	Visa Super X 1981/83	1219cc.	129/5 64HP Ø75	420		
460700	AX Sport 1987/91	1294cc.	TU24/M4A (SOHC) 8V 94HP Ø75	422		
451600	AX14, BX14 1991/..., ZX 1994/..., AX GT 1993/..., C15 1991/...	1360cc.	TU3F/TU3FM/TU3F2C (SOHC) 8V 75/80HP Ø75	410		
451700	BX 14, C15 1988/..., Saxo, Xsara, Berlingo 1996/..., AX 14, AX GT 1986/..., ZX 1991/98	1360cc.	TU3M/S/A/MC/JP (SOHC) 8V 70/75/80/85HP Ø75	411		
451800	Visa GT, BX 14 1982/85	1360cc.	150 70/72HP Ø75	420		
452200	C2/C3, C3 Pluriel 2002/..., Berlingo 1997/...	1360cc.	TU3JP (KFW) TU3-2 (K5A) 75HP (SOHC) 8V Ø75	415		
460500	Visa GT, Bx14 1985/...	1360cc.	150 70/72HP Ø75	420		
460700	BX 14, C15 1988/..., Saxo, Berlingo, Xsara 1996/..., AX 14, AX GT 1986/..., ZX 1991/98	1360cc.	TU3MC/JP/A (SOHC) 8V 70/75/80/85HP Ø75	422		
470400	AX 14 1988/94	<b>DIESEL</b> 1360cc.	TUD3 (K9A) (SOHC) 8V 52HP Ø75	431		

# INDICE - CATALOGO VEHICULAR

## INDEX - AUTOMOTIVE CATALOG

### CITROËN

Ref.	Modelo/Model	Cm³	Motor/Engine			
471700	C3 Picasso, C3 2009/..., DS3 2010/...	1397cc.	EP3 (8FS/FP) - EP3C (8F01) 16V 95HP Ø77	422		
302100	C3/C2 HDI, Xsara HDI 2002/... <b>DIESEL</b>	1398cc.	DV4TD (8HZ/8HX) 70HP (SOHC) 8V Ø74	260		
472200	C3 2012/...	1499cc.	TU4M (SOHC) 8V 89/93HP Ø75	447		
470300	AX 15 1994/97, Saxo 1996/... <b>DIESEL</b>	1527cc.	TUD5 (VJY) (SOHC) 8V 55/58HP Ø77	430		
471300	Xsara, Picasso TD 1999/..., C4/C5 TD 2004/... <b>DIESEL</b>	1560cc.	DV6TED4(9HY/Z) (DOHC) 16V 104HP Ø75	439		
472300	C3 HDI, DS3 HDI 2009/... <b>DIESEL</b>	1560cc.	DV6C 92HP - DV6DTE 112HP (SOHC) 8V Ø75	448		
451200	BX16 1985/90, BX 16 GTI 1991/93, Visa GTI 1985/...	1580cc.	XU5J/CP 75/105HP - XU5JA 115HP 8V Ø83	407		
452100	Berlingo, C3 Pluriel, Xsara 2000/..., C2, C3 2002/... - 2004/...	1587cc.	TU5JP4 (NFU/N6A) (DOHC) 16V 109HP Ø78.5	414		
470500	ZX, Saxo 1996/..., Xsara 1997/...	1587cc.	TU5JP (SOHC) 8V 90HP Ø78.5	432		
471700	C4/C4 Coupe, C4/C3 Picasso 2008/..., Berlingo, C3 2009/..., DS3 2010/...	1598cc.	EP6 (5FW/5FS) - EP6C (5F01) 16V 120HP Ø77	442		
471800	C4, C4 Grand Picasso, C4 Picasso 2008/..., C5, C5 Tourer 2009/..., DS3 2010/...	1598cc.	EP6DT/CDT (5FX/5FR/5F04) 150/156HP Ø77	443		
460100	Xantia 1997/01, Xsara 1997/...	1761cc.	XU7JP/JB (SOHC) 8V 90/103HP Ø83	416		
460800	Xsara 1997/..., Xantia 1995/96, Xantia 1997/2001, ZX 1997/98	1761cc.	XU7JP4 (DOHC) 16V 112HP Ø83	423		
461100	Berlingo 1997/...	1761cc.	XU7JB (SOHC) 8V 90HP Ø83	425		
470700	BX 17 TD 1988/94 <b>DIESEL</b>	1769cc.	XUD7TE (SOHC) 8V 90HP Ø80	434		
470900	C15 1994/..., Berlingo 1996/99, Xsara 1997/..., ZX 1991/94 <b>DIESEL</b>	1769cc.	XUD7 (161A/A9A) (SOHC) 8V 60HP Ø80	436		
470600	Berlingo, Jumpy, Xsara 1998/..., C5, Xsara, Jumpy 2000/... <b>DIESEL</b>	1868cc.	DW8 (WJZ/WJY) (SOHC) 8V 71HP Ø82.2	433		
451200	BX19, BX 19 GTI 1984/93	1905cc.	XU92S 96HP XU9J1 104HP (SOHC) 8V Ø83	407		
451407	BX GTI 1987/93	1905cc.	XU9J4 (DOHC) 16V 160HP Ø83	382		
460200	BX19 1984/93, BX19 GTI 1983/93	1905cc.	XU92C (SOHC) 8V 96/104/125HP Ø83	417		
460300	Xantia, Dispatch, Jumper, Jumpy 1993/99, Berlingo 1996/99, Xsara 1997/... <b>DIESEL</b>	1905cc.	XUD9 (SOHC) 8V 69HP Ø83	418		
460900	Xantia, ZX TD 1993/..., Dispatch, Jumper, Jumpy TD 1995/..., Xsara TD 1997/... <b>DIESEL</b>	1905cc.	XUD9TE/TF (DHX) (SOHC) 8V 90/92HP Ø83	424		
461307	Dispatch, Relay, Jumpy, Xsara 1995/99, Berlingo, ZX 1994/98, Jumper <b>DIESEL</b>	1905cc.	XUD9/XUD9A (D9B/DJY/HV/JZ) 69/71HP Ø83	384		
470800	Xantia, Jumper, Xsara HDI 1998/..., Berlingo, Evasion, Xsara Picasso HDI, Dispatch, Jumper HDI 1999/..., Jumpy, Xsara, C5 HDI 2000/... <b>DIESEL</b>	1997cc.	DW10TD(RHV/RHY/RHX/RHZ) 90/94/110HP DW10TD/ATED 90/110HP (SOHC) 8V Ø85	435		
471200	Jumpy, Dispatch, Xsara, Evasion 1998/..., C5/C5 HPI 2001/..., C8 2002/..., C4 2004/..., Xsara Picasso	1997cc.	EW10J4 (RFN-RLZ) 136/147HP Ø85 (DOHC) 16V	438		
471400	C4/C5 HDI 2004/..., C4 Picasso HDI, C8 HDI 2006/..., C4 HDI FAP 2007/... <b>DIESEL</b>	1997cc.	DW10BTE4 (RHR) 136HP Ø85 (DOHC) 16V	440		
471500	Evasion HDI 2000/..., C8 HDI, Jumpy HDI 2002/... <b>DIESEL</b>	1997cc.	DW10ATED4 (RHW/RHM/RHT) 109HP Ø85	441		
471900	C5 - C5 HDI - C5 Tourer HDI 2009/... - C4 Picasso - C4 Grand Picasso 2010/... <b>DIESEL</b>	1997cc.	DW10CTED4 (DOHC) 16V 163HP Ø85	444		
472000	C4, C5 2005/..., C4 Grand Picasso 2006/..., C4 Picasso, Jumpy III 2007/...	1997cc.	EW10A (RFJ/RFH) (DOHC) 16V 136/140HP Ø85	445		
451300	XM 1989/94 - 1990/93	1998cc.	XU10M 107HP - XU102C 115HP (SOHC) 8V Ø86	408		
451900	ZX 1992/96, Xantia 1993/98	1998cc.	XU10J2C (SOHC) 8V 123HP Ø86	412		
460600	ZX 1992/..., Xantia 1993/98	1998cc.	XU10J2C (SOHC) 8V 123HP Ø86	421		
470200	ZX 1992/97, Xantia 1993/95	1998cc.	XU10J4 (DOHC) 16V 155 Ø86	429		
471000	Xantia 1995/01, Xsara 1998/00, Evasion, Synergie 1998/...	1998cc.	XU10J4R (RFV) (DOHC) 16V 132/135HP Ø86	437		
461500	XM TD 1989/00, Xantia TD 1995/98, Dispatch TD, Evasion TD, Jumper TD <b>DIESEL</b> Jumpy TD, Synergie1996/99	2088cc.	XUD11ATE(P8A) - XUD11BTE (PHZ/P8C) (SOHC) 12V 110HP Ø85	427		
471500	C5 HDI 2001/..., C8 HDI 2002/... <b>DIESEL</b>	2179cc.	DW12TED4 (DOHC) 16V 130/133HP Ø85	441		
324800	Jumper HDI 2006/... <b>DIESEL</b>	2198cc.	4HU/4HV (P22DTE) 101/120HP Ø86	326		
452000	Jumper TDI, Relay TDI 1997/... <b>DIESEL</b>	2445cc.	DJ5TED (THX) (SOHC) 8V 107HP Ø92	413		
470000	Jumper D/TD, XM TD, Relay D/TD1994/97 <b>DIESEL</b>	2445cc.	DJ5/T (T8A/THZ-T9A) - DK5ATE 103/130HP Ø92	428		
452308	C5 2000/... - C8 2002/... - C6 2005/...	2946cc.	ES9J4S (XFW/XFX) 204/210HP	383		

### CUMMINS

870800	ISF Series - Camiones, Pick Up <b>DIESEL</b>	2776cc.	ISF2.8 (SOHC) 16V 150/156HP Ø94			28
870900	ISF Series, Camiones, Ómnibus, Pick-Up <b>DIESEL</b>	3759cc.	ISF3.8 (OHV) 16V 148HP Ø102			29
870000	Serie B <b>DIESEL</b>	3900cc.	4B - 4BT - 4BTA 100/130HP Ø102			19
870500	Bus, Agrale, Euro III/IV, Electrónico 2003/... <b>DIESEL</b>	3920cc.	ISBe (OHV) 16V 150/170HP Ø102			25
800800	ISB 2004/... <b>DIESEL</b>	5883cc.	ISBe 6 (OHV) 24V 275HP Ø102			71
870100	Serie B <b>DIESEL</b>	5900cc.	6B - 6BT - 6BTA (SOHC) 12V 180/205HP Ø102			21

# INDICE - CATALOGO VEICULAR

## INDEX - AUTOMOTIVE CATALOG

### CUMMINS

Ref.	Modelo/Model		Cm <sup>3</sup>	Motor/Engine			
870600	Serie C 1832/2632	DIESEL	8270cc.	ISCe6 24V 315HP Ø114			26
870200	Serie C - Bus, Camión, Agrícola	DIESEL	8300cc.	6C - 6CT - CTA (SOHC) 12V 254/294HP Ø114			23
870307	Serie C - Bus	DIESEL	8300cc.	6C - 6CT - CTA 254/294HP Ø114			I-28
873208	Camiones, FT95.500 V 1994/98, 95 XF 530 1997/...	DIESEL	14016cc.	NT855 (OHV) 24V 340HP Ø140			I-29
870700	ISX Series	DIESEL	14951cc.	ISX (DOHC) 24V 380/540HP Ø137			27
871000	ISX Series - 400, 425, 450, 460, 470, 475	DIESEL	14951cc.	ISX (DOHC) 24V 405/475HP Ø137			30
871308	Excavadora, Tractor 7950, 7980	DIESEL	18942cc.	QSK19 (OHV) 24V 6 cilindros 532HP Ø159			I-29

### DACIA

571000	Logan 2006/...		1390cc.	K7J-714 75HP Ø79.5 (SOHC) 8V	491		
560200	TXL 1310/1410		1397cc.	TXL (SOHC) 8V 60HP Ø76	476		
571000	Sandero 2008/..., Logan 2004/...		1598cc.	K7M 710/718/810/814 (SOHC) 8V 90HP Ø79.5	491		

### DAEWOO

940000	Matiz 1998/..., Tico 1996/..., Damas 1981/..., Spark 2003/06		796cc.	F8CV (SOHC) 6V 52HP Ø68.5			07
282500	Matiz 2003/06		995cc.	B10S (SOHC) 8V 63HP Ø68.5	91		
282500	Kalos 2002/...		1148cc.	F12S3 (SOHC) 8V 71/72HP Ø68.5	91		
290100	Kalos 2004/...		1399cc.	F14 D3 (DOHC) 16V 94HP Ø77.9	94		
240400	Cielo,- Espero 1994/97		1498cc.	G15MF (SOHC) 8V 78/75HP Ø76.5	35		
240400	Lemans, Racer 1989/...		1598cc.	OHC (SOHC) 8V 75HP Ø79	35		
290100	Nubira 2003/05 - Lacetti 2004/...		1598cc.	F16 D3 (DOHC) 16V 109HP Ø79	94		
940100	Aranos, Espero, Prince 1993/97, Leganza 1997/...		1796cc.	C18LE (SOHC) 8V 95HP Ø86			08
291100	Epica 2006/... - Captiva - Toscana 2007/...	DIESEL	1991cc.	Z20S 150HP (SOHC) 16V Ø83	102		
940100	Espero, Prince 1993/97, Leganza 1997/..., Magnus 2001/... Espero, Lemans, Prince, Leganza MPFI/TBI 1991/...		1998cc.	C20LE 97/105HP - C20NE 110/116HP Ø86 (SOHC) 8V			08
241500	Lemans, Racer 1989/97, Aranos 1995/..., Nubira II 1999/...		1998cc.	C20LE - C20NE (SOHC) 8V 97/110/116 Ø86	44		
280700	Leganza 1997/..., Nubira1997/..., Nubira II 1999/..., Magnus 2001/...		1998cc.	X20SED (DOHC) 16V 134/136/148HP Ø86	75		
280700	Leganza 1998/...		2198cc.	X20SED (DOHC) 140HP Ø86	75		

### DAF

420600	Va 200, VS 200 1986/...		1994cc.	TN44 Ø 84,4	380		232
873208	FT95.500 V 1994/98, 95 XF 530 1997/...		14016cc.	F373M - VF390M (OHV) 24V 507/530HP Ø140			I-29

### DAIHATSU

950000	55 Wide Cab, Max Cuore, Cab Van 1977/...		547cc.	AB - 20/30 (SOHC) 4V Ø71.76			16
948000	Mira 1992/96, Coure 1984/95		659cc.	EF (SOHC) 6V 47HP Ø68			09
948100	Hi-Jet 1986/89, Van 850 1991/...		843cc.	CD (SOHC) 6V 39HP Ø70			10
948000	Mira 1992/96, Coure 1984/95		846cc.	ED (SOHC) 6V 41HP Ø68			09
948200	Coure 1986/99, Mira 1986/95		846cc.	ED10 (SOHC) 6V 41HP Ø66.6			11
948300	Move, Coure 1998/02, Sirion 2002/...		989cc.	EJ-DE (DOHC) 12V 56HP Ø72			12
950100	Charade 1981/...		993cc.	CB - CB 12/37 (SOHC) 6V 40HP Ø76			17
948600	Charade 1988/...		1295cc.	HC (SOHC) 16V 84/90HP Ø76			13
949000	Charade 1988/...		1295cc.	HC (SOHC) 16V 84/90HP Ø76			15
948700	YRV 2000/07		1298cc.	K3-VET (DOHC) 16V 140HP Ø72			14
970000	Charmant 1978/80		1588cc.	2T 8V 74HP Ø85			381
948600	Charade 1988/...		1589cc.	HDE (SOHC) 16V 105HP Ø76			13
970000	Delta Wide 1978/80		1770cc.	13T 8V 95HP Ø85			381
920500	Delta Wide 1983/88	DIESEL	1839cc.	1C (SOHC) 8V 68HP Ø83			339
900200	Delta Wide 1982/...	DIESEL	1839cc.	1C (SOHC) 8V 84HP Ø83			335
920400	Delta Wide D/TD 1985/91	DIESEL	1975cc.	2C/2CT (SOHC) 8V 73/91HP Ø86			338
923500	Rocky 1993/01		2237cc.	4Y (OHV) 8V Ø91			352
900405	Delta 1980/88	DIESEL	2977cc.	B (OHV) 8V 85HP Ø95			I-31



### DATSUN

950905	280 ZX		2753cc.	L28E/ET 17HP0 Ø86			I-32
--------	--------	--	---------	-------------------	--	--	------

# INDICE - CATALOGO VEHICULAR

## INDEX - AUTOMOTIVE CATALOG

### DEUTZ

Ref.	Modelo/Model		Cm <sup>3</sup>	Motor/Engine			
650000	Tractor A40	DIESEL	2660cc.	F2L 514 (SOHC) 4V 56HP Ø110			31
650200	Tractor 69/75 A 46, 74/78 A65 1969/75	DIESEL	2908cc.	AF 2L 1114 46HP AF 2L 2114 50HP Ø115			33
660000	Tractor 1978/81	DIESEL	3064cc.	B-F3L 913 Ø102			43
650200	Tractor 69/75 A 46, 74/78 A65 1969/75	DIESEL	3167cc.	A F 2L 2114 Ø120			33
650300	Tractor A55 1959/69	DIESEL	3990cc.	F3L 514 (OHV) 6V 50HP Ø110			34
660100	Agrale 4-913, Turbo 4-913 1978/...	DIESEL	4086cc.	F4L 913 (OHV) 8V 87HP Ø102			44
650600	Tractor A65 1969/78	DIESEL	4363cc.	A-F3L 1114 115HP			37
650600	Tractor A65 1969/78	DIESEL	4750cc.	A-F3L 2114 120HP			37
660200	Tractor 1978/...	DIESEL	5106cc.	B-F5L 913 Ø102			45
650400	Tractor 470 1959/69	DIESEL	5320cc.	F4L 514 (OHV) 8V 65HP Ø110			35
650700	Tractor A85 1969/78	DIESEL	5817cc.	A-F4L 1114 Ø115			38
650100	DD1000, DD9000 Camión, Tractor 1978/81	DIESEL	6128cc.	F6L 913 (OHV) 12V 130HP Ø102			32
650700	Tractor A85 1969/78	DIESEL	6333cc.	A-F4L 2114 Ø120			38
650500	Tractor A110 1959/69	DIESEL	7980cc.	F6L 514 (OHV) 12V Ø110			36
650800	Tractor A130, A144 1969/78, Bus Turbo	DIESEL	8725cc.	A-F6L 1114 (OHV) 12V Ø115			39
650800	Tractor, A130, A144 1969/78, Bus Turbo	DIESEL	9500cc.	B-F6L 2114 (OHV) 12V Ø120			39
650900	200 D16, 200 D19, 200 D2M, 200 RS, 210 EV 120, Tractor 5020 1969/77	DIESEL	11309cc.	F8L - 413 V8 16V Ø120			40
651000	Estacionarios 0302 6472, AY 0148-00, 0301 7177 UY 0147-00, Vehicular Ómnibus, Camiones, 0302 6545 AY 0148-00, 0301 7177 UY 0147-00	DIESEL	11309cc.	F8L - 413F V8 16V Ø125			41

### DI TELLA

210900	Morris, Riley, Traveller 1500, Pick Up, Argenta 1500 1960/66		1489cc.	Ø73.02	147		
210900	Magnette 1622, Morris 1650, Magnette 1960/66		1622cc.	Ø76.20	147		

### DKW

140000	Graciela, Auto Unión 1000S 1953/67		900cc.	Wartburg 44HP Ø73.5	148		
140000	Graciela, Auto Unión 1000S 1953/67		992cc.	Wartburg 50HP Ø73.5	148		

### DYNAPAC

330800	Cilindro Vibratorio CHF 44 1983/...	DIESEL	2942cc.	D229-3 (SOHC) 6V 72HP Ø102			176
--------	-------------------------------------	--------	---------	----------------------------	--	--	-----

### FIAT

250100	600 (E.R.D), 770 Coupe, 800 Spider 1962/76		767cc.	100D - 170R (OHV) 8V 32HP Ø62	158		
250800	133, Berlina de Lujo 1977/82, 850, 850 Van 1965/76		843cc.	100R 32HP Ø62.5 - 100G 37HP (OHV) 8V Ø65	167		
273808	500 2009/..., Panda 2012/... - 2015/...		875cc.	312A2 86HP - 312A5/A7 80HP (SOHC) 6V Ø80.5	155		
273808	500 2012/...		875cc.	199B6 105HP (SOHC) 6V Ø80.5	155		
250800	Uno 45 1974/..., 127 Especial 1983/88		903cc.	146A (OHV) 8V 45HP Ø65	167		
251000	Uno 1994/00		994cc.	146A2 41HP (SOHC) 8V Ø70	169		
270200	Palio 1.0 ED/EDX MPI 96		994cc.	ED/EDX MPI (SOHC) 8V 48/61HP Ø76	199		
260700	Uno Mille, Palio, Siena 1983/...		994cc.	146B (SOHC) 8V 48/61HP Ø76	191		
251000	Panda 1986/..., Uno 1989/95, Uno 1998/...		999cc.	156A2/A3 (SOHC) 8V 30/45HP Ø70	169		
270500	Uno, Palio, Siena, Mille Fire		999cc.	Fire MPI (SOHC) 8V 50HP Ø70	204		
270700	Palio, Siena, Palio Weekend, Palio Novo, Novo Siena, Doblo		999cc.	Fire 1714130 (DOHC) 16V 70HP Ø71	206		
272200	Palio, Siena Generación III, Uno Fase II 2010/...		999cc.	Fire EVO (SOHC) 8V 73/75HP Ø70	217		
272900	Argo, Mobi, Uno 2018/...		999cc.	Firefly (SOHC) 16V 77HP Ø70	224		
260500	147, Oggi, Panorama, Uno, Premio Trend		1049cc.	127AB (OHV) 8V 206 60/70HP Ø76	189		
250000	1100/103 1961/64		1089cc.	65HP Ø68.5	157		
251000	Panda 1995/96, Palio 2001/...		1108cc.	176B2 - 178B9 54HP (SOHC) 8V Ø70	169		
250400	128, 147, Spazio, Brio, Ritmo 60, Strada 60 1971/...		1116cc.	128A (SOHC) 8V 55/60HP Ø80	160		
251700	Punto 60 Cabrio 1995/99, Palio 75, Siena 1996/..., Punto 60, Punto Selecta 1993/99		1242cc.	176B4/176B1/176A7 60HP - 178B5 73HP Ø70.8	173		
270700	Palio, Siena, Palio Weekend, Palio Novo, Novo Siena, Doblo		1242cc.	Fire 188.A5 (DOHC) 16V 80HP Ø71	206		
271900	Fire 1.3, Fiorino, 500 2007/...		1242cc.	350 A1 (SOHC) 8V 70HP Ø72	214		
272500	Palio 2002/..., Siena 2005/..., Punto 2003/..., Idea, Stilo 2004/..., Doblo 2010/...		1242cc.	178D7 (DOHC) 16V 80HP Ø72	220		
273600	Mobi BZ 2016/...		1242cc.	Fire (SOHC) 8V 70HP Ø72	227		



# INDICE - CATALOGO VEICULAR

## INDEX - AUTOMOTIVE CATALOG

### FIAT

Ref.	Modelo/Model	Cm <sup>3</sup>	Motor/Engine			
252508	Palio, Panda JTDM, Siena JTD 2002/..., Idea JTD 2004/..., Cinquecento 500, Fiorino JTDM 2007/..., 500 JTD 2009/... <b>DIESEL</b>	1248cc.	188A9 - 196A1/A2 - 199B1 (DOHC) 16V 70/75/95HP Ø69.6	150		
271500	Punto ELX JTD 2003/..., Strada Trekking Fase III JTD 2010/... <b>DIESEL</b>	1248cc.	188A9 (DOHC) 16V 70HP Ø69.6	212		
250500	128, Europa, 147, Spazio 1971/81	1290cc.	128A1 (SOHC) 8V 73HP Ø86.4	162		
260500	147, Oggi, Panorama, Uno, Premio Trend	1300cc.	127AB (OHV) 8V 2C 60/70HP Ø76	189		
270500	Uno, Palio, Siena, Mille Fire	1300cc.	Fire MPI (SOHC) 8V 75HP Ø70.8	204		
250500	Regata 70, Ritmo Strada 65, Uno 70, lava, TV, 147 Sorpasso Fiorino 1982/...	1301cc.	138B2 (SOHC) 8V 68/70HP Ø86.4	162		
260000	147, Duna, Fiorino, Spazio, Uno 1985/... <b>DIESEL</b>	1301cc.	4TD - 146B (SOHC) 8V 45HP Ø76.1	184		
273000	Argo, Cronos 2018/...	1332cc.	Firefly (SOHC) 8V 99HP Ø70	225		
452200	Qubo, Fiorino Qubo	1360cc.	(SOHC) 8V 75HP Ø75	415		
271200	Palio, Siena, Strada	1368cc.	Fire (SOHC) 8V 80/81HP Ø72	210		
271900	Fire 1.4 ELX, Evo 2010/..., Idea 2003/..., Palio Fase II/III 2007/13, Grande Punto 2005/..., Siena Generación III MPI 2002/..., Linea 2007/..., Strada Fase II, Uno 2013/19 (MXI)	1368cc.	169 A4 - Fire Evo (SOHC) 8V 77/80/82HP Ø72	214		
272400	500, Punto, Bravo, Doblo, Punto T-Jet 2009/...	1368cc.	198A4/199A8/955A6/A8 (DOHC) 16V 105HP Ø72	219		
272500	Palio 2002/..., Siena 2005/..., Punto 2003/..., Idea, Stilo 2004/..., Doblo 2010/...	1368cc.	183A1/192B2 (DOHC) 16V 95HP Ø72	220		
272500	500L 2007/...	1368cc.	Fire (DOHC) 16V 95HP Ø70,8	220		
273600	Fiorino XMF 2016/18	1368cc.	Fire Evo (SOHC) 8V 80HP Ø72	227		
271407	Bravo 1995/..., Marea 1996/00	1370cc.	182 A3 (SOHC) 12V 80HP Ø82	154		
260200	Spazio, Duna, Tipo, Uno, Vivace, Palio, Siena 1988/91, Fiorino 1993/95	1372cc.	160A1 - 146C1/5 67/72HP - 159A2 78HP Ø80.5	186		
222407	Palio 2001/..., Siena 2002/... <b>DIESEL</b>	1461cc.	178E5 (SOHC) 8V 84HP Ø83	149		
250200	1500 Berlina, Familiar, Multicarga 1963/69	1481cc.	115C (OHV) 8V 72HP Ø77	159		
270200	Palio 1.5 EL MPI 96	1495cc.	EL MPI (SOHC) 8V 76HP Ø76	199		
250500	Ritmo Strada 75, Ritmo Strada 85 1978/82	1498cc.	138A2-A4 75/85HP (SOHC) 8V Ø86.4	162		
250600	128 Regatta'85, Ritmo 1986/90, Duna, Uno, Super Europa 1983/..., Elba, Premio, Fiorino	1498cc.	138C3 75/85HP (DOHC) 8V Ø86.4	164		
252205/7	Regata 75 i.e, Ritmo 75 i.e, UNO 75 i.e 1986/90, Fiorino i.e 1988/93	1498cc.	149A5/C1 - 138C3 - 483C3 75HP Ø86.4	150		
260300	Duna, Uno, Regatta, Palio, Siena, Premio, Elba, Tipo, Fiorino 1988/...	1581cc.	Sevel - 146C6 - 159A3 - 160A2 76/78/88HP Ø86.4	187		
260900	Palio, Siena, Tipo, Bravo, Marea, Multipla 1999/...	1581cc.	182A4/A6 - 186A3/A4 (DOHC) 16V 103HP Ø86.4	193		
250900	Regata 100S 1985/...	1585cc.	149A (SOHC) 8V 100HP Ø84	168		
261100	Palio, Siena, Marea, Multipla 2001/...	1596cc.	182B6 - 178E7 103HP Ø77 (DOHC) 16V	194		
273500	Tipo 2017/...	1598cc.	E.torq Evo (SOHC) 16V 110HP Ø76	226		
272000	Idea Essence, Idea Sporting, Idea Adventure, Siena Fase III Essence, Strada Fase III/IV Adventure, Palio Wend Fase III/IV Adventure, Adventure 2010/..., Punto Essence 2011/...	1598cc.	E.torq 178D20.11 - 178D22.11 (SOHC) 16V 115HP Ø77	215		
272600	Grand Siena 2012/..., Idea 2011/16, Palio 2012/..., Punto 2013/17, Strada 2013/..	1598cc.	E.torq (SOHC) 16V 115/117HP Ø77	221		
250200	1600 Berlina, Coupe 1969/72	1600cc.	115C (OHV) 8V 76HP Ø78	159		
250700	125 (Bialbero), Berlina, Sport Multicarga, Mirafiori 1972/74	1608cc.	125AB - 125A 110HP Ø80	166		
260400	Duna, Uno, Regatta, Fiorino 1985/... <b>DIESEL</b>	1697cc.	149B - 146B (SOHC) 8V 60HP Ø82.6	188		
270000	Fiorino, Uno, Tipo, Palio, Ducato D/TD <b>DIESEL</b>	1697cc.	149B - 176A (SOHC) 8V 58/69HP Ø82.6	195		
272100	Fiat Punto, Idea, Linea 2011/..	1747cc.	Fiat E-Torq (SOHC) 16V 130HP Ø81	216		
272300	Marea 1996/..., Brava, Bravo 1995/...	1747cc.	182A2 (DOHC) 16V 113HP Ø82	218		
273700	Argo, Cronos 2017/...	1747cc.	E.torq Evo (SOHC) 16V 130HP Ø76	228		
272600	Grand Siena 2012/..., Idea 2011/16, Palio 2012/..., Punto 2013/17, Strada 2013/..	1747cc.	E.torq (SOHC) 16V 130HP Ø77	221		
272700	Argo, Bravo 2011/16, Doblo 2010/..., Idea 2011/16, Linea 2009/16, Palio 2013/..., Punto 2013/17, Strada 2013/..	1747cc.	E.torq (SOHC) 16V 135/139HP Ø80,5	222		
260100	Tempra, Tipo 1992/95	1756cc.	835C (DOHC) 8V 105HP Ø84	185		
241800	Palio Fase II 2004/...	1781cc.	ALX (DOHC) 16V 122HP 80.5	47		
242200	Stylo, Strada Working, Adventure, Palio 2003	1796cc.	OHC-171190 MPFI 8V 102HP Ø80.5	51		
252300	Palio, Stilo, Palio Flex, Strada, Siena Flex 2003/..., Idea Adventura HLX, G2/G3 2006/...	1796cc.	OHC-171190/17241C1 - G2/G3 105/110HP Ø80.5	176		
291000	Croma 2005/...	1796cc.	939A4 (DOHC) 16V 140HP Ø80,5	101		
272800	Linea 2008/15	1896cc.	310A4011 Torque 16V 130/132HP Ø86	223		
460900	Ducato TD 1994/..., Scudo TD 1995/01 <b>DIESEL</b>	1905cc.	D8B/DHX (SOHC) 8V 92HP Ø83	424		

# INDICE - CATALOGO VEHICULAR

## INDEX - AUTOMOTIVE CATALOG

### FIAT

Ref.	Modelo/Model		Cm³	Motor/Engine			
461307	Escudo, Ducato 1994/01	DIESEL	1905cc.	D9B/DJY 68/69HP Ø83	156		
252000	Brava, Bravo TD 1996/99, Marengo TD, Marea TD	DIESEL	1910cc.	182A8/A7 (SOHC) 8V 75/100HP Ø82	174		
252100	Brava, Bravo TD, Multipla TD, Marea TD 1998/...	DIESEL	1910cc.	182B4 (SOHC) 8V 105HP Ø82	175		
252400	Marea JTD 2000/02, Stilo JTD, Idea JTD, Punto 2003/..., Palio JTD 2002/...	DIESEL	1910cc.	186A6 - 192A1/3 - 188 B2 80/110/115HP Ø82	177		
252608	Stilo JTD 2001/..., Bravo JTD 2007/...	DIESEL	1910cc.	937A5 150HP (DOHC) 16V 140HP Ø82	151		
270000	Tipo, Tempra, Palio, Siena TD	DIESEL	1929cc.	160D - 280A1 (SOHC) 8V 65/90HP Ø82.6	195		
253000	Toro 2016/...	DIESEL	1956cc.	Multijet TD (DOHC) 16V 170HP Ø83	183		
260100	Regatta 2000, Bialbero, Tempra 1989/...		1987cc.	154C (DOHC) 8V 90/110HP Ø84	185		
260600	Tempra 1992/..., Tipo i.e. 1989/93, Croma i.e. 1993/..., Coupe i.e. Turbo 1994/...		1995cc.	160A 126HP - 154E 140HP - 836A 145HP 16V Ø84	190		
260800	Tempra i.e., Tipo i.e., Croma i.e., Croma i.e. Turbo 1992/95		1995cc.	154C4 153HP - 159A6 115HP - 834B.146 8V Ø84	192		
270900	Marea 1996/98 - 1998/..., Coupe 1996/01, Bravo 1995/98		1998cc.	182A1 147HP - 182B3/B7 147/155HP Ø82	207		
271300	Bravo, Coupe, Marea 1998/01		1998cc.	182B7 - 182B3 (DOHC) 20V 155HP Ø82	211		
461500	Ulysse TD 1996/99	DIESEL	2088cc.	P8C (XUD11ATE/L) (SOHC) 12V 109HP Ø86	427		
324800	Ducato 2006/...	DIESEL	2198cc.	4HU 101HP Ø86	326		
252800	Ducato JTD 2002/... - 2006/...	DIESEL	2286cc.	F1AE (DOHC) 16V 110/120/127HP Ø88	180		
523000	Freemont 2012/...		2360cc.	ED3 - GEMA (DOHC) 16V 170/174HP Ø88	146		
251807	Marea TD 1996/99	DIESEL	2387cc.	185A2 124HP Ø82	150		
251400	Ducato TD 1985/...	DIESEL	2445cc.	8140.21 (SOHC) 8V 92HP Ø93	172		
270400	Nuovo Ducato 1989/94	DIESEL	2445cc.	8140.67 (SOHC) 8V 55HP Ø93	202		
270807	131/132 1978/..., Argenta 1981/..., Ducato 1981/89	DIESEL	2445cc.	8144.61 53HP Ø93	153		
271707	Marea 1991/...		2445cc.	160HP Ø83	154		
270100	Ducato TD 1990/94, Ducato TDS 1994/96, Ducato TDSE 1996/...	DIESEL	2499cc.	8140.27 103HP - 8140.47R/X230 110/116HP Ø93	197		
270400	Ducato 1994/...	DIESEL	2499cc.	8140.67X230 85HP Ø93	202		
252900	Ducato JTD 2006/09	DIESEL	2798cc.	8140.43S Euro III (SOHC) 8V 122/125HP Ø94.4	181		
251100	Ducato 14, Ducato 18 Maxi, Ducato 14D, Ducato 18D Maxi 1998/...	DIESEL	2799cc.	8140.63 (SOHC) 8V 87/89HP Ø94.4	170		
270300	Ducato 14TDS, Ducato Maxi 18TDS 1996/...	DIESEL	2799cc.	8140.43 (SOHC) 8V 122HP Ø94.4	200		
452308	Ulysse 2002/...		2946cc.	ES9J4S (XFW) 207HP (DOHC) V6 24V Ø87	156		

### FIAT IVECO

252800	Cargo, Maxicargo, Furgon, Multijet 2010/...	DIESEL	2286cc.	F1AE (DOHC) 16V 110/120/127HP Ø88	180		
251400	Daily TD 1985/89	DIESEL	2445cc.	8140.21 (SOHC) 8V 92HP Ø93	172		
270807	Daily 1979/...	DIESEL	2445cc.	8140.61 Ø93	153		
251400	Daily TD 1987/89	DIESEL	2499cc.	8140.27 (SOHC) 8V 103HP Ø93	172		
270100	Daily Turbo 1990/...	DIESEL	2499cc.	8140.27S 103HP - 8140.47/S/R 112/116HP Ø93	197		
270400	Daily 30.8 - 35.8 1996/...	DIESEL	2499cc.	8140.67F37 (SOHC) 8V 82HP Ø93	202		
252900	Daily 35.13, 35.13 4x4, 38.13, 40.13, 50.13, 60.13, 70.13 2005/10	DIESEL	2798cc.	8140.43S Euro III (SOHC) 8V 122/125HP Ø94.4	181		
251100	Daily 30.8 - Daily 35.8 1996/...	DIESEL	2799cc.	8140.63 Iny. Indirecta (SOHC) 8V Ø94.4	170		
271100	Daily 35.10 - 49.12 1996/... - 45.10/49.10/40.10, Daily 49.12 - 60.12 Intercooler	DIESEL	2799cc.	8140.23 - 8140.43 (SOHC) 8V 99/122HP Ø94.4	208		
252700	Daily, 40 S14, 3.0 HPI, Euro III TD, 55 C16, 3.0 HPI, Euro III TD 2008/...	DIESEL	2998cc.	8210 - 42E2 - F1CE 0481 16V 136/155HP Ø95.8	178		
800407	Tractor 780/880 1976/...	DIESEL	3666cc.	8045.04 Ø103			I-32
800300	Camión 150 N Turbo AU130, Eurocargo 150 E23/E20	DIESEL	5861cc.	8060.25 177HP - 8060.45/45S 207HP Ø104			65
800600	75/80/85/95/100/120/130/150/170 E15 Turbo 1991/..., 80/85/100/120/130/135 150/170 E18 Turbo 1991/..., 80/90/100/E21, 135/150/170/180/E23	DIESEL	5861cc.	8060.25 143/177HP - 8060.45/S Eurocargo 207/277HP (OHV) 12V Ø104			69
800800	Eurocargo 80 E18/E21, 90 E18/E21 Tector, Commonrail Turbo Intercooler EDC 130 E18, 120 E24/E28, 150 E18 2004/...	DIESEL	5880cc.	170E22 - F4AE0681D (OHV) 24V TDI- EDC 180/210HP Ø102			71
800900	Cursor 8 - Eurotech (E24/31/35), Eurotrakker (E24/27/31/35-T27/31/33/35/36) Stralis (S27/30/31/33/35/36), Euromover (E24), Cavallino 2007/...	DIESEL	8000cc.	F2BE0681 - F2BE3681 E4 - Turbo Intercooler 310HP (SOHC) 24V Ø115			72
801108	Eurotech Cursor 10 190/260/440 E40 2001/..., Stralis 2002/...	DIESEL	10308cc.	F3AE Turbo Interc. (SOHC) 24V 400/450HP Ø125			I-32
800200	Camión Bus 341A, 221, 221H, 619 NP 1965/66, 693 N/N1 - T/T1 1965/68	DIESEL	12883cc.	221- 8210.01 240HP Ø135			64
801000	Cursor 13 - Euro Stard 260E48, 440E46/48, Stralis 260/440S44, 190/260 440S48/260/440S50/54/56, Eurotrakker 190/260/340/380E38/E44-400	DIESEL	13000cc.	F3BE3681A Turbo Intercooler 380/420HP Ø135			74

# INDICE - CATALOGO VEHICULAR

## INDEX - AUTOMOTIVE CATALOG

### FIAT IVECO

Ref.	Modelo/Model	Cm <sup>3</sup>	Motor/Engine			
800000	Camión 619N1, 697N TB, Bus 391, 691, 319N, Bus 221A 1970/... <span style="float: right;">DIESEL</span>	13798cc.	8210.02 (OHV) 12V 260HP Ø137			61
800500	Euro Trakker, Euro Star, Euro Tech 1989/..., 180E42, 190E31/42/36, 240E42/36 <span style="float: right;">DIESEL</span> 260E37/42/36, 400E31/37/42, 410E37/42, 440E37/42, 720E31, 380E31 1991/...	13798cc.	8210.42L LE2 370HP - 8210.42K KE2 420HP 8210.22.800 310HP (SOHC) 12V Ø137			67

### FIAT PESADO

710200	Motor Arranque, Tractor 1955/74 <span style="float: right;">DIESEL</span>	665cc.	Motorino 55/60/788R Ø75			60
700600	Tractor U25 1957/62, Tractor 211R 1962/65 <span style="float: right;">DIESEL</span>	1135cc.	U25 - 211R - CD Ø85			55
700900	Tractor 411R/411T, 431R 1959/85 <span style="float: right;">DIESEL</span>	2270cc.	615 40HP Ø85			58
710305	Tractor <span style="float: right;">DIESEL</span>	2592cc.	480-540T 100HP			I-31
440000	850E <span style="float: right;">DIESEL</span>	2977cc.	D225-4 68HP Ø95			179
700300	Tractor Someca, CN3 1961/70 <span style="float: right;">DIESEL</span>	3421cc.	650 - 700 Ø110			52
700800	Tractor 400 E.V.U, 500, Super 600E, 480 1969/80 <span style="float: right;">DIESEL</span>	3421cc.	CN3 Ø110			57
710405	Tractor Camiónes <span style="float: right;">DIESEL</span>	3455cc.	640-670-680 100HP			I-31
700400	Tractor Someca, Leoncino 1950/... <span style="float: right;">DIESEL</span>	3456cc.	DA - 50 - 40 Ø100			53
710505	Tractor, Camiónes 780/780DT/765C/766/855 <span style="float: right;">DIESEL</span>	3663cc.	780/780DT Ø103			I-31
700800	Tractor 400 E.V.U, 500, Super 600E, 480 1969/80 <span style="float: right;">DIESEL</span>	3705cc.	CN4 Ø110			57
310400	Escavadora FB80 <span style="float: right;">DIESEL</span>	3922cc.	D229-4 (SOHC) 8V 96HP Ø102			167
700000	Tractor Someca 1965/74 <span style="float: right;">DIESEL</span>	4156cc.	M45 - 450 - 55 Super Son Ø105			49
700300	Someca M45/M50, Super Som 55/46A, Tigrotto 1969/... <span style="float: right;">DIESEL</span>	4397cc.	CO3 Ø108			52
440100	Tractor AD7B, 980E, S90 <span style="float: right;">DIESEL</span>	5100cc.	D225-6 102HP Ø95			180
700500	Tractor, CO3 1971/80 <span style="float: right;">DIESEL</span>	5401cc.	700E - 800E - CO3 - 640 - 740 90/106HP Ø115			54
310500	Tractor S90, FE105, FA120, FE105B <span style="float: right;">DIESEL</span>	5883cc.	D229-6 145HP Turbo 160HP Ø102			169
700700	Tractor 1955/... <span style="float: right;">DIESEL</span>	6546cc.	60 RL Ø122			56
700100	Tractor 1962/69 <span style="float: right;">DIESEL</span>	6872cc.	780 - R - AE Ø125			50
700200	Tractor - CP3 1972/80 <span style="float: right;">DIESEL</span>	7412cc.	840 - 900 - 1100 - CP3 - 900E 165HP Ø110			51
710100	Camión 1964/83 <span style="float: right;">DIESEL</span>	7412cc.	673N - CP - 840 - 900 Ø110			59
800100	Camión 203 <span style="float: right;">DIESEL</span>	10676cc.	682 N2 MK3 Ø125			63

### FORD

301307	Fiesta 1976/88	957cc.	OHV (HCS) 40/45HP Ø73.96	230		
310700	Escort Hobby 1.0 1993/...	997cc.	CHT/AE Ø70.3	282		
321700	Ka 2016/...	997cc.	Ti-VCT Eco Boost (DOHC) 12V 85HP Ø71.9	303		
311000	Ka 1997/99, Fiesta 1996/99 53HP, Fiesta 1988/95 45HP	999cc.	OHV (HCS) Endura 45/53HP Ø68.7	285		
325100	Fiesta 2016/...	999cc.	Eco Boost (DOHC) 12V 125HP Ø71.9	328		
340100	Fiesta, Ka 1999/...	999cc.	Zetec Rocam ZL (SOHC) 8V 65HP Ø68.69	332		
301307	Fiesta 1976/88, Escort 1982/88	1118cc.	OHV (HCS) 53/55HP Ø73.96	230		
252508	Ka TDCI 2008/... <span style="float: right;">DIESEL</span>	1248cc.	FD4 (DOHC) 16V 75HP Ø69.6	229		
301307	Combi Van, Escort 1986/88	1297cc.	OHV (BL13H) 60HP Ø73.96	230		
310800	Fiesta 1988/95, Courier 1991/... (cárter de aluminio)	1297cc.	OHV (HCS) Endura 60HP Ø73.96	283		
310800	Fiesta, Ka (cárter de acero)	1299cc.	OHV (HCS) Endura 50/60HP Ø73.96	283		
310800	Escort, Fiesta, Courier, Ka (cárter de aluminio) 1995/...,	1299cc.	OHV (HCS) Endura 50/60HP Ø73.96	283		
310700	Escort 1.3 1983/...	1300cc.	CHT/AE Ø71.5	282		
320600	Corcel 1971/77, Corcel II 1978/83	1300cc.	CHT 73HP Ø77	293		
320900	Fiesta SE, Courier, Puma 1996/...	1388cc.	Zetec SE 16V 90/75HP Ø76	295		
321400	Fiesta VI 2008/... - B-Max 2012/... - Fusion 2002/... - 2010/...	1388cc.	FXJA/FXJB/FXJC/RTJA/RTJB 80/90HP 16V Ø76	300		
301000	Escort 1986/98, Orion 1986/94	1392cc.	HL14G/CF/EFI (OHV) 8V 73/75HP Ø77.2	251		
302100	Fiesta, Eco Sport TD 2003/... , Duratorq TDCI <span style="float: right;">DIESEL</span>	1398cc.	F6JA - F6JB 68HP (SOHC) 8V Ø74	260		
320600	Belina, Coupe GT 1.4 BR	1400cc.	CHT Ø77	293		
325400	Territory 2021/...	1490cc.	JX4G15 Eco Boost (DOHC) 16V 150HP Ø79	330		
325200	Eco Sport, Fiesta 2016/...	1497cc.	Dragon - Eco Boost (DOHC) 12V 137HP Ø84	329		
321600	Ka 2016/...	1499cc.	Sigma 104HP (DOHC) 16V Ø79	302		
324600	Ka 2016/...	1499cc.	Sigma (DOHC) 16V 104HP Ø79	324		

# INDICE - CATALOGO VEHICULAR

## INDEX - AUTOMOTIVE CATALOG

### FORD

Ref.	Modelo/Model	Cm³	Motor/Engine			
300700	Escort, Saveiro, Gol, Corcel II, Del Rey, Scala, Pampa 1983/..., Belina, Verona 1989/...	1555cc.	CHT/AE (SOHC) 8V 73HP Ø77	248		
310600	Corcel II 1979/83, Belina II, Pampa 1982/83, Del Rey 1981/83, Scala 1983/...	1555cc.	CHT 73HP Ø77	281		
471300	Focus C-Max TDCI 2003/..., Fusion TDCI 2004/... <b>DIESEL</b>	1560cc.	G8DA 90HP - Duratorq 109HP (DOHC) 16V Ø75	439		
330905	Capri, Cortina, Sierra, Transit, Pick Up, Granada 1973/...	1593cc.	OHC TL16L/TL16H/TL16G 63/73/90HP Ø87.65	237		
321600	Fiesta, Fusión 2003/..., Focus 2004/..., C-Max 2007/...	1596cc.	L4 Sigma - HWDA/HWDB - FYJA 100HP 16V Ø79	302		
324600	Fiesta 2010, Focus 2013	1596cc.	Sigma (DOHC) 16V 115HP Ø79	324		
325307	Kuga 2013/14, Mondeo, Focus 2010/15, C-Max, Grand C-Max, Galaxy 2010/19	1596cc.	Eco Boost (DOHC) 16V 150HP Ø79	237		
300600	Sierra 1.6L 1984/...	1597cc.	OHC 75HP Ø81.3	247		
301100	Fiesta i, Orion i 1989/92, Escort, Escort XR3, Fiesta XR2 1980/85, Escort XR3i 1985/90	1597cc.	CHV 90HP - CVH 79/105HP Ø80	252		
301200	Mondeo 1993/...	1597cc.	ZETEC (DOHC) 16V 90HP Ø76	253		
301400	Escort, Orion 1992/..., Fiesta 1994/95	1597cc.	ZETEC (DOHC) 16V 90HP Ø76	254		
340200	Ka 1997/..., Fiesta 1999/..., Escort, Eco Sport, Focus, Courier 2003/... <b>DIESEL</b>	1598cc.	Zetec Rocam ZL (SOHC) 8V 95/105/110HP Ø82	333		
320000	Sierra TD 1988/91, Escort D, Fiesta D, Orion D 1989/90 <b>DIESEL</b>	1753cc.	D1.8TI 75HP - D18NA 60HP Ø82.5	288		
320000	Escort, Fiesta, Orion D 1990/92, Pick Up , Sierra TD, Courier, Courier, Fiesta Orion D, Pick Up, Sierra, Escort, Orion, Mondeo TD 1992/94 <b>DIESEL</b>	1753cc.	D1.8TI/TI 75/90HP - D18NA 60HP Ø82.5	288		
340300	Focus 1998/..., Fiesta TD di 2000/..., Focus TD ci 2001/..., Focus di 1999/...	1753cc.	Lynx 75/90HP - Duratorq 115HP (SOHC) 8V Ø82.5	334		
322200	Courier 1972/82	1769cc.	110 Ø78	308		
220600	Del Rey, Belina, Escort, Scala, Pampa 1989/..., Verona, Royale, Versailles 1990/96	1781cc.	AP (SOHC) 8V 85/87HP Ø81	534		
301500	Focus 1998/...	1796cc.	ZETEC E (DOHC) 16V 116HP Ø80.6	255		
303300	Focus 1998/04, Transit 2002/...	1796cc.	ZETEC-E SFI (DOHC) 16V 116HP Ø80.6	271		
320300	Escort, Fiesta, Orion, Fiesta XR2, Escort RX3i 1992/...	1796cc.	ZETEC (DOHC) 16V 105/115HP Ø80.6	291		
321300	Mondeo 1993/...	1796cc.	ZETEC (DOHC) 16V 115HP Ø80.6	299		
223500	Galaxy TDI 2000/... <b>DIESEL</b>	1896cc.	AUY (SOHC) 8V 115HP Ø79,5	554		
230900	Galaxy TDI 1995/... - 1997/... <b>DIESEL</b>	1896cc.	VW19N (1Z/AHU) - VW19P (AFN) 90/110HP Ø79.5	567		
322200	Courier 1972/82	1970cc.	121 Ø78	308		
230000	Galaxy, Versailles, Verona, Escort 1992/96	1984cc.	Audi 827 (SOHC) 8V 107/115HP Ø82.5	560		
302900	Focus 1999/02, Maverich 2000/..., Cougar 1999/...	1989cc.	YF/EDBA/BB/BC/BD 16V 124/131HP Ø84.8	267		
320500	Escort	1989cc.	ZETEC (DOHC) 16V 136HP Ø84.8	292		
321500	Mondeo 1993/01	1989cc.	ZETEC (DOHC) 16V 136HP Ø84.8	301		
323107	Escort 1997/01, Focus USA 2003/...	1989cc.	121 (SOHC) 8V 110HP Ø84.8"	235		
340800	Contour 1994/...	1989cc.	ZETEC 16V 126HP Ø83	339		
300300	Taurus L, GXL, Ghia 1974/...	1990cc.	OHC (SOHC) 8V 63HP Ø90.8	244		
303600	Ranger, Pinto, Taurus, Sierra, Capri, Granada 1974/86	1993cc.	L4 122 (SOHC) 8V 72HP Ø96	274		
340005	Granada, Transit, Escorpio, Sierra, Capri, Taurus 1970/...	1993cc.	OHC TL20L/H 102/105HP Ø91	237		
303200	Mondeo TDCI, Transit TDI/Ci 00/02 - 2002/... , Mondeo III 2002/02, Transit DI <b>DIESEL</b>	1998cc.	HJBA/B/C - F3FA/F1FA 85/125HP Duratorq Ø86	270		
324300	Contour 1996/98, Mystique 1994/95, Escort ZX2 1998/...	1998cc.	4L 121 P.C.D. VIN "3" ZETEC 16V 138HP Ø84,8	322		
471400	C-Max TDCI 2003/..., Focus TDCI, Galaxy TDCI, S-Max 2006/..., Mondeo TDCI <b>DIESEL</b>	1998cc.	DURATORQ (20DD0X)	440		
	C-Max TDCI, Focus TDCI 2007/...		110/115/130/135/140HP Ø85 (DOHC) 16V			
471500	Focus C-Max TDCI 2003/... <b>DIESEL</b>	1998cc.	G6DA/G6DC (DOHC) 16V 135HP Ø85	441		
302200	Mondeo 2001/..., Eco Sport 2003/..., Ranger 2001/..., Focus, Focus EXE	1999cc.	CJBA - Duratec HE/EFI 143/145HP 16V Ø87.5	261		
302400	Mondeo 2001/..., Eco Sport 2003/..., Ranger 2001/..., Focus, Focus EXE	1999cc.	CJBA - Duratec HE/EFI 143/145HP 16V Ø87.5	263		
303400	Focus 2011/..., Mondeo 2013/...	1999cc.	MGDA Duratec (DOHC) 16V 170HP Ø87.5	272		
303900	Fusión 2016/..., Bronco 2021/..., Maverick 2022/...	1999cc.	Ecoboost 16V 248HP 87.5	276		
322200	Courier 1972/82	2000cc.	123 Ø78	308		
300800	A, AA 1928/31	2100cc.	24HP Ø98.4	249		
973600	Probe 1989/91	2184cc.	F2 (SOHC) 12V 147HP Ø86	240	155	
324800	Ranger XL 4X2 / 4X4 <b>DIESEL</b>	2198cc.	Puma TDCi 2.2L 125HP Ø86	326		
324800	Transit TDCi 2006/... <b>DIESEL</b>	2198cc.	CVRA/CVRB/CVRC 125/155HP Ø86	326		
302400	Maverick 2003/...	2261cc.	154HP Ø87.5	263		
340600	Mustang, Ranger 1993/94, Ranger 1995/97 Pick Up 1989/...	2298cc.	F140L (SOHC) 106HP Ø96	337		

# INDICE - CATALOGO VEHICULAR

## INDEX - AUTOMOTIVE CATALOG

### FORD

Ref.	Modelo/Model	Cm <sup>3</sup>	Motor/Engine			
300400	Taurus, Sierra, XR4, Falcon 1974/..., SP/Ghia, Maverick 1975/79, Mustang 1980/...	2299cc.	OHC 100/114HP Ø96	245		
301700	Ghia 1991/..., Topaz 1989/94	2300cc.	140 F.I	256		
301800	Topaz, GS/GLX 1984/88	2300cc.	140 Carburado	257		
303600	Ranger, Pinto, Taurus, Sierra, Capri, Granada 1974/86	2302cc	L4 140 (SOHC) 8V 86HP Ø96	274		
910500	Bronco II TD, Ranger 2WD 1985/...	<b>DIESEL</b> 2346cc.	4D55T 8V 67HP Ø91	240	167	
302000	Transit TD 2000/...	2402cc.	Duratorq (DOHC) 16V 120/125HP Ø89.9	259		
302500	Mystique, Contour 1995/00, Mondeo 1994/00, Mondeo III 2000/...	2495cc.	Duratec - LCBD V6 24V (DOHC) 170HP Ø81.6	264		
303500	Mondeo III 2002/...	2495cc.	AJ25 - LDBE V6 (DOHC) 24V 170HP Ø81.6	273		
303800	Ranger 2011/...	2495cc.	GBVAF/GBVAL/GBVAK (DOHC) 16V 166HP Ø89	275		
330300	Transit, Transit D/DI 1985/99	<b>DIESEL</b> 2496cc.	4EB/BC/CA/FB 70/80HP - 4HC/EA 100HP Ø93.64	331		
971907	Probe 1992/95	2497cc.	KL 170HP (DOHC) V6 24V Ø84.5	240		
500400	Scorpio TDI, Granada TDI 1993/94, Falcon 1988/...	<b>DIESEL</b> 2499cc.	SCB (OHV) 8V 115HP Ø92	521		
520300	Scorpio TDI SCC/SCD 1994/98	<b>DIESEL</b> 2499cc.	SCC/SCD (OHV) 8V 115/125HP Ø92	522		
971600	Ranger D, Ranger TD 1998/...	<b>DIESEL</b> 2499cc.	WL/WLT (SOHC) 12V 78/108HP Ø93	240	142	
302300	Pick Up, Ranger 1997/...	2500cc.	EFI - NAI4 (SOHC) 117HP Ø96	262		
430000	Ranger TDI 1995/...	<b>DIESEL</b> 2507cc.	95HP Ø90.7	365		
324700	Focus, C-Max, S-Max, Mondeo, Kuga 2005/... - 2007/...	2522cc.	Duratec-VCT (25KDDTD) 220/226/300HP Ø83	325		
303000	Mondeo II 1994/00	2544cc.	Duratec SEA (DOHC) 24V 170/173HP Ø82.4	268		
920200	Maverick TD 1992/99	<b>DIESEL</b> 2663cc.	TD27T (SOHC) 8V 100/125HP Ø96	240	298	
430600	Ranger TD BR 2000-2002/...	<b>DIESEL</b> 2758cc.	Power Stroke 135HP Ø93	366		
870800	F350 2014/...	<b>DIESEL</b> 2776cc.	ISF2.8 (SOHC) 16V 150HP Ø94	240		28
300900	Falcon 4B, STD, De Luxe, Futura, Rural 1962/68	2780cc.	170 4B 84HP Ø88.9	250		
230700	Galaxy 1995/00	2792cc.	AAA/AMY DOHC) V6 12V 174HP Ø81	566		
322400	Bronco, Granada, Capri 1983/86	2792cc.	171 (OHV) V6 12V 160HP Ø93	310		
430800	Ranger 3.0I, 4 x 4, Full BR Intercooler 2005/8	<b>DIESEL</b> 2798cc.	NGD 3.0 E (SOHC) 16V 163HP Ø96	367		
310900	Ford V6 (USA) Ranger, Bronco II 1988/92, Sierra V6 B4A/B/C 1989/93, Granada BRC 1986/93	2933cc.	177/BRC (SOHC) V6 12V 150HP Ø93	284		
973900	Ranger 2002/07	<b>DIESEL</b> 2953cc.	(SOHC) 12V 156HP Ø96	240	158	
303100	Mondeo V6, ST 2.20 2003/...	2967cc.	Duratec V6 - MEBA V6 (DOHC) 24V 226HP Ø89	269		
322900	Escape 2001/04	2967cc.	Duratec V6 RFF - MEBA 3.0I 200HP Ø89	315		
323700	Ranger 1996/01	2968cc.	Vulcan (SOHC) V6 12V 147HP Ø89	318		
300000	Falcon, F100, Fairlane 1969/...	3052cc.	187 - 7B (OHV) 12V 108HP Ø90.62	241		
300900	Falcon 4B, STD, De Luxe, Futura, Rural 1962/68	3052cc.	187 4B 96HP Ø90.42	250		
300000	Falcon, F100, Fairlane 1969/...	3075cc.	188 - 7B (OHV) 12V 108HP Ø93.47	241		
324900	Ranger XLS/XLT 4x2-4x4 TDCi 2013/...	<b>DIESEL</b> 3198cc.	Puma TDCi I5 eTGV 3.2L 200HP Ø90	327		
400000	F100, Falcon 1970/...	<b>DIESEL</b> 3336cc.	4.203-P4-192Z (OHV) 8V 71HP Ø91.49	373		201
410000	F100	<b>DIESEL</b> 3336cc.	4.203 Potenciado (OHV) 8V 71HP Ø91.44	376		218
300000	Falcon, F100, Fairlane 1969/...	3618cc.	221 - 7B (OHV) 12V 108HP Ø93.47	241		
300100	Falcon SP, Sprint 1973/...	3618cc.	221 Sprint 7B (OHV) 12V 132HP Ø93.47	242		
310000	Falcon, Pick Up 1989/...	3618cc.	Max Econo 106HP Ø93.47	277		
870900	Pick Up	<b>DIESEL</b> 3759cc.	ISF3.8 (OHV) 16V 148HP Ø102	240		29
322300	Thunderbird, Cougar Super Cargado 1988/93	3797cc.	232 (OHV) V6 12V 140/205HP Ø97	309		
323200	Windstar 1995/96	3797cc.	232 (OHV) V6 12V 130HP Ø96.8	316		
323300	Windstar 1997/98	3797cc.	Essex (OHV) V6 12V 155HP Ø96.8	317		
323900	Windstar 1998/...	3797cc.	Essex (OHV) V6 12V 145HP Ø96.8	319		
324000	Windstar 1999/00	3797cc.	Essex (OHV) V6 12V 200HP Ø96.8	320		
324100	Windstar 2001/03	3797cc.	Essex (OHV) V6 12V 200HP Ø96.8	321		
301900	V6 3.8 (USA) Mustang, Taurus, Sable, Thunderbird, Cougar 1985/87	3811cc.	232 V6 130HP Ø96.8	258		
320200	V6 3.8 (USA) Mustang, Taurus, Sable, Thunderbird, Cougar	3811cc.	230 (232) V6 130HP Ø96.8	290		
870000	F100 1998/...	<b>DIESEL</b> 3900cc.	4B - 4BT - 4BTA 100/130HP Ø102	239		19

# INDICE - CATALOGO VEHICULAR

## INDEX - AUTOMOTIVE CATALOG

### FORD

Ref.	Modelo/Model	Cm³	Motor/Engine			
870500	F100 2006/..., Common Rail	3920cc.	ISBe (OHV) 16V 150/170HP Ø102	240		
310400	F100 1993/95, F1000 1994/96	<b>DIESEL</b> 3922cc.	D229-4 (SOHC) 8V 96HP Ø102	368	25	
320100	Explorer, Ranger, Navajo 1991/..., Bronco II 1990/91	<b>DIESEL</b> 3996cc.	244 CID (SOHC) V6 12V 147/165HP Ø100.4	289	167	
323508	Explorer 4WD 1996/..., Mustang 2004/10	4009cc.	C40VSEX (OHV) V6 12V 162HP Ø100,4	236		
324400	Econoline, F150 1997/9	4195cc.	Essex V6 202HP Ø96,8	323		
330600	F100 GMC Turbo 1999/	<b>DIESEL</b> 4200cc.	Sprint 6.07 TD 167/198HP Turb Intercooler Ø93	371		
321800	Galaxy 500, Fairlane, Falcon, Maverich, Mustang, Grand Marquis, F150/F250 1965/84	4300cc.	260 (OHV) V8 16V Ø96	304		
300200	F100, F350, F600, Fairlane 1961/70	4458cc.	272 V8 F1 170HP Ø92	243		
302700	E-Series - Mustang, Grand Marquis, Crown Victoria, Pick Up F250 1997/99	4600cc.	Triton 281V8 (SOHC) 16V 180HP Ø92	265		
302800	E-Series - Mustang, Grand Marquis, Crown Victoria, Pick Up F250 2000/03	4600cc.	Triton 281V8 (SOHC) 16V 180HP Ø92	266		
322500	E-Series - F-Series, Expedition, Triton 1997/99	4600cc.	Triton 281 (SOHC) V8 12V 180HP Ø92	311		
322600	Triton 2000/03, E-Series, F-Series, Expedition	4600cc.	281 (SOHC) V8 12V 180HP Ø92	312		
340700	Town Car, Grand Marquis 1991/95, LTD Crown, Cougar, Thunderbird 1994/95	4600cc.	281 CID (SOHC) 16V 180HP Ø92	338		
300200	F100, F350, F600, Fairlane 1961/70	4785cc.	292 V8 F1 170HP Ø95.25	243		
300500	F100/350/600, Fairlane 1/8, LTD 500, Fase II 1969/76	4785cc.	V8 FII 180HP Ø95.25	246		
321800	Galaxy 500, Fairlane, Falcon, Maverich, Mustang, Grand Marquis, F150/F250 1965/84	4800cc.	289 (OHV) V8 16V Ø96	304		
340900	F100, F150 1991/...	4900cc.	300 CID Inyección 145HP Ø101.6	340		
310200	Econoline, Delivery 1980/...	4917cc.	(OHV) 12V 145HP Ø101.09	279		
310100	Ranger 1989/..., Galaxy, Maverick 1976/83	4942cc.	F302 (SOHC) V8 16V Ø101.6	278		
320700	Cougar, Continental, Granada, Fairmont, Thunderbird	5000cc.	F302 V8 Ø101.6	294		
321000	F100/F250/F350, Mustang, Thunderbird, Bronco 1983/96	5000cc.	F302L (OHV) V8 Ø101.6	296		
321200	F250/F350, Mustang	5000cc.	F351W (OHV) V8 16V Ø101.6	298		
321800	Galaxy 500, Fairlane, Falcon, Maverich, Mustang, Grand Marquis, F150/F250 1965/84	5000cc.	302 (OHV) V8 16V Ø96	304		
321900	Cougar, Thunderbird, F200/F350 1991/95	5000cc.	302 (OHV) V8 16V Ø96	305		
322100	Grand Marquis, Galaxy, Camiónes, Mustang, F250/F350/FB600 1969/84	5000cc.	351 (OHV) V8 16V Ø101.6	307		
400300	F100 1974/...	<b>DIESEL</b> 5004cc.	6PF - 305 (SOHC) 12V 102HP Ø91.44	374	204	
310300	Fairlane 500, Galaxy 500, Monterey, Thunderbird, Mustang 1960/71	5400cc.	390 CID V8 Ø102	280		
311100	Galaxie, Mustang, Torino 1964/78	5400cc.	330 V8	286	75	
311200	V8 1964/72	5400cc.	350 V8	287		
322500	E-Series - F-Series, Expedition, Triton 1997/99	5408cc.	Triton 330 (SOHC) V8 12V 260HP Ø92	311		
322600	Triton 2000/03, E-Series, F-Series, Expedition	5408cc.	330 (SOHC) V8 12V 260HP Ø92	312		
322000	F250/F350/F600, Microbus (Chasis) 1984/91	5500cc.	335 (OHV) V8 16V Ø101.6	306		
321100	F100/F250/F350, Bronco 1985/95	5800cc.	F351WL (OHV) V8 16V Ø101.6	297		
322000	F250/F350/F600, Microbus (Chasis) 1984/91	5800cc.	351 (OHV) V8 16V Ø101.6	306		
322700	Triton F-450 1997/99, Excursion, E-Series, F-Series Super Duty	6760cc.	Triton (SOHC) V10 20V 310HP Ø90	313		
322800	F-450 2000/03, Excursion, E-Series, F-Series Super Duty	6760cc.	Triton (SOHC) V10 20V 310HP Ø92	314		
340400	F100/F250/F350, Econoline 250/350 1985/87	7500cc.	F460L V8 Ø110	335		
340500	Monterey, Torino, Cougar, Continental, Mark III/IV/V 1988/94	7500cc.	460 CID V8 Ø110	336		



### FORD PESADO

870800	F350, F4000 2014/...	<b>DIESEL</b> 2776cc.	ISF2.8 (SOHC) 16V 150HP Ø94			28
310400	F4000 1992/93, F2000 1980/..., FB4000 1985/...	<b>DIESEL</b> 3922cc.	D229-4 (SOHC) 8V 96HP Ø102			167
330000	Tractor 4600/4110/4140/4190/4200/4400/4410 1965/74, 4610/H/SU 1981/90	<b>DIESEL</b> 3294cc.	BSD 332 - 333/H 81HP Ø111.8			76
870000	F4000 2000/..., Cargo 915, Euro II	<b>DIESEL</b> 3900cc.	4B - 4BT - 4BTA 100/130HP Ø102			19
320400	Camión F4000 1986/...	<b>DIESEL</b> 4156cc.	D226-4 (OHV) 8V 82HP Ø105			171
330100	5610/5030/5110/5610/5900/6600/6700/7000/7100/7200	<b>DIESEL</b> 4196cc.	BSD 442 - 256 72HP Ø111.8			77
330400	Euro I/II/III	<b>DIESEL</b> 4300cc.	4.10 X10 90HP - 4.10T/TCA 133/167HP Ø103			173
330100	6410/6610/6710/7600/7700	<b>DIESEL</b> 4385cc.	BSD 444 80HP Ø111.8			77
330100	6810/7410/7610/7710	<b>DIESEL</b> 4392cc.	BSD 444T 82HP Ø111.8			77
330100	F2000/F4000, FB4000, Tractor 6600/6610	<b>DIESEL</b> 4393cc.	268 82/87HP Ø111.8			77
400100	F350/600	<b>DIESEL</b> 5004cc.	6.305 Cadenero (SOHC) 12V 100HP Ø91.44			202

# INDICE - CATALOGO VEHICULAR

## INDEX - AUTOMOTIVE CATALOG

### FORD PESADO

Ref.	Modelo/Model		Cm <sup>3</sup>	Motor/Engine			
400300	F350/600 1974/...	DIESEL	5004cc.	6PF - 305 102HP Ø91.44			204
410100	F600	DIESEL	5004cc.	6PF - 305 Potenciado 100HP Ø91.49			219
400200	F600/700	DIESEL	5798cc.	6.354-2 (OHV) 12V 140HP Ø98.47			203
400400	F7000 Camiónes - Ford pesados y semi-pesados	DIESEL	5798cc.	6.354-4 Turbo (OHV) 12V 172HP Ø98.42			205
400900	F600/700	DIESEL	5798cc.	6.354-1 (OHV) 12V 135HP Ø98.43			210
410900	F600/F750/F1100/F6000/F7500/F11000	DIESEL	5840cc.	6-357 Veh. 120HP - Ag. 91HP - Ind. 108HP Ø104			227
420000	F400/F600/F7000/F11000/F12000/F13000	DIESEL	5840cc.	6-358 Veh. 133HP - Ag. 118HP - Ind. 127HP Ø104			228
310500	F14000/F4000 1994/96, Cargo, F12000/F14000 1985/...	DIESEL	5883cc.	D229-6 145HP Turbo 160HP Ø102			169
870100	F14000 Turbo, F4000 1999/..., 1416 Euro I, Dodge Truck 359 1989/93	DIESEL	5900cc.	6B - 6BT - 6BTA (SOHC) 12V 180/205HP Ø102			21
311100	Camión 1964/78	DIESEL	5900cc.	351 V8			75
311100	Camión 1964/78	DIESEL	6400cc.	391 V8			75
650100	F7000 1978/81	DIESEL	6128cc.	F6L 913 (OHV) 12V 130HP Ø102			32
330700	F14000 1995/98, Euro I/II	DIESEL	6450cc.	6.10 X10 139HP - 6.10T/TCA 201/250HP Ø103			174
330200	7810/7910/8210/8530 1988/..., 8630/8750/8830 1992/...	DIESEL	6572cc.	Fase I-II Cargo 6.6/7.8 Simple/Turbo 110HP			78
870600	2632-E/2932-E/4432-E/4532-E/5032-E - CARGO 2003/...	DIESEL	8270cc.	ISCe6 24V 315HP Ø114			26
870200	Cargo 1722/1730/2625 1998/..., F14000 1999/...	DIESEL	8300cc.	6C - 6CT - CTA (SOHC) 12V 254/294HP Ø114			23
870307	Cargo 1722 - 1730 - 2625 1998/... - F14000 1999/...	DIESEL	8300cc.	6C - 6CT - CTA 254/294HP Ø114			I-34

### FOTON

870800	Aumark 2000/3000/4000/5000/6000/7000 2012/...	DIESEL	2776cc.	ISF2.8 (SOHC) 16V 126HP Ø94			28
--------	---	--------	---------	-----------------------------	--	--	----

### HANOMAG



750100	Tractor, D28LA/D28 1950/55	DIESEL	2800cc.	R25 - L28 - R35 - R40 - R435 Brillant Ø90			80
750200	Brillant, Tractor, D28C 1965/71	DIESEL	2800cc.	R40 25e - R57 - R46 Ø90			81
750000	Tractor, D57 1963/...	DIESEL	5702cc.	R45/55/60/75 Ø110			79

### HONDA

861100	Civic 1975/79		1169cc.	EB1 (SOHC) 8V 60HP Ø70			28
861100	Civic 1975/79		1238cc.	EB2/3 (SOHC) 8V 60HP Ø72			28
861100	Civic Van 1979/82, Civic, Ballade 1982/...		1335cc.	EN (SOHC) 8V 70HP Ø72			28
862300	Fit BR 2003/..., City 2004/..., Jazz 2005/...		1339cc.	I-DSI Twin Spark - L13A3/A5 8V 82HP Ø73			35
860300	Civic CVCC 1987/90		1343cc.	D13B1/B2 (SOHC) 16V 75/90HP Ø75			20
862208	Logo 1999/02		1343cc.	D13B7 (SOHC) 8V 65HP Ø75			I-34
863000	Civic 2000/...		1396cc.	D14Z1/Z2 (SOHC) 16V 90HP Ø75			40
863400	Civic 1500 1984/89		1488cc.	EW (SOHC) 12V 85HP Ø74			44
860300	CRX 1988/91		1493cc.	D15B6 (SOHC) 16V 90HP Ø75			20
863000	Civic VTEC-E 1995/97 - Civic VTEC 1996/... - Civic Aerodeck VTEC 1998/...		1493cc.	D15Z3/Z6/Z8 (SOHC) 16V 89/114HP Ø75			40
863100	CRX 1988/91		1493cc.	D15B6 (SOHC) 16V 90HP Ø75			41
863200	Civic VTEC 1992/96		1493cc.	D15B1/B2 (SOHC) 16V 100HP Ø75			42
862500	Fit VTEC 2007/..., Jazz VTEC 2006/..., City VTEC 2005/...		1496cc.	L15A1 81/107HP - L15A6 105HP 16V Ø73			36
865100	City 2009/13, Fit, WT-V 2014/16		1496cc.	L15A8/Z3/Z9 (OHV) 16V 116HP Ø73			61
864600	Civic, Accord, CR-V 2017/...		1498cc.	AP2T (DOHC) 16V 173HP Ø73			56
860400	Civic Coupe VTEC 1994/95, Civic Del Sol VTEC, Civic VTEC 1991/97		1590cc.	D16Z6/Z7/Z9 (SOHC) 16V 125HP Ø75			21
860500	Civic CRX, Integra 1985/87		1590cc.	ZC1 - ZV (DOHC) 16V 120HP Ø75			22
863000	Civic CX/DX/LX/SI/HX/EX - Civic del Sol - Civic coupe - CRX - Civic VTEC-E 1996/...		1590cc.	D16Y2/6/7 116/114HP - D16Y5/8 115/125HP Ø75			40
863200	Civic CRX .../1992		1590cc.	D16A7 (SOHC) 16V 110HP Ø75			42
863500	Civic CRX VTEC - Del Sol VTEC 1992/95		1590cc.	D15Z6/Z7 (SOHC) 16V Ø75			45
863600	HR-V VTEC 1999/05, Civic V Aerodeck VTEC 1998/00		1590cc.	D16W5 124HP D16W4 125HP (SOHC) 16V Ø75			46
863700	Civic 1996/...		1590cc.	D16Y8 (SOHC) 16V 125HP Ø75			47
861900	Civic VTEC 1999/02		1595cc.	B16A2 (DOHC) 16V 150/160HP Ø81			34
863300	Civic VTI VTEC - Civic del Sol VTEC - CRX VT VTEC 1991/00		1595cc.	B16A1/A2/A3 (DOHC) 16V 150/160HP Ø81			43
863800	Accord 1984/85		1598cc.	EZ1 (SOHC) 12V 95HP Ø80			48
863900	Accord 1976/79		1599cc.	EF (SOHC) 12V 82HP Ø74			49

# INDICE - CATALOGO VEICULAR

## INDEX - AUTOMOTIVE CATALOG

HONDA						
Ref.	Modelo/Model	Cm³	Motor/Engine			
860600	Accord 1980/81	1602cc.	EP (SOHC) 8V 90HP Ø77		23	
860700	Accord, Quinet 1981/...	1602cc.	EP (SOHC) 12V 90HP Ø77		24	
861600	Civic Coupe 2001/05	1668cc.	D17A8 (SOHC) 16V 125HP Ø75		33	
860600	Prelude, Accord 1980/81	1750cc.	EK (SOHC) 8V 95HP Ø77		23	
860700	Accord, Prelude, Vigor 1982/...	1750cc.	EK - EL (SOHC) 12V 97HP Ø77		24	
863300	Civic VTI VTEC 1997/00	1797cc.	B18C1 (DOHC) 16V 170HP Ø81		43	
862700	Civic Sedan, Coupe 2006/11	1799cc.	R18A1/A2 (SOHC) 16V 140HP Ø81		37	
863800	Accord 1984/85, Prelude 1984/85	1829cc.	ES/ET1 (SOHC) 12V 130HP Ø80		48	
864000	Integra 1990/93 - 1994/95	1834cc.	B18A1 (DOHC) 16V 140HP Ø81		50	
860800	Accord 1993/...	1850cc.	F18A3 (SOHC) 16V 116HP Ø85		25	
860900	Accord VTEC 1999/...	1850cc.	F18B2 - F18B3 (SOHC) 16V 136HP Ø85		26	
864100	Accord 1986/89, Prelude 1987, Accord (Automatic) 1986/89	1955cc.	A20A1/A3/A4 (SOHC) 12V 102/116/166HP Ø82.8		51	
864200	Prelude III 1987/92	1958cc.	B20A3/A4 (SOHC) 12V 109/114HP Ø81		52	
864300	Prelude III 1987/92	1958cc.	B20A5/A7/A9 (DOHC) 16V 137/150HP Ø81		53	
861400	CR-V 1997/98, CR-V 1999/...	1973cc.	B20B2/B3 128HP - B20Z1/Z3/Z9 128/147HP Ø84		31	
860200	Civic TD 1997/99, Accord TD 1996/00	1994cc.	20T2R - 20T2N (SOHC) 8V 86/105HP Ø84.5	<b>DIESEL</b>	19	
860800	Accord 1993/...	1997cc.	F20Z1 131HP - F20Z2 (SOHC) 116HP 16V Ø85		25	
860900	Accord VTEC 1998/..., Accord Coupe VTEC 1998/..., Accord Aerodeck, Coupe 1994/97	1997cc.	F20B3 16V 137HP - F20B5 - F20B6 147HP Ø85		26	
862800	CR-V 2002/06, Civic VI/VII VTEC 2003/..., Integra VTEC 2002/...	1998cc.	K20A (I-VTEC) 150HP - K20A3 155/160HP Ø86		38	
862900	Accord, Accord Tourer 2003/06, Stepwagon VTEC 2005/...	1998cc.	K20A6 (DOHC) 16V 155HP Ø86		39	
864400	Stream VTEC 2001/...	1998cc.	K20A1 (DOHC) 16V 156HP Ø86		54	
864500	Civic Type-r VTEC 2001/05, Integra Type-r VTEC 2004/...	1998cc.	K20A2 (DOHC) 16V 200HP Ø86		55	
864700	Prelude 1990/92	2056cc.	B21A1 (DOHC) 16V 137HP Ø83		57	
860900	Prelude VTEC, Accord Wagon 1994/98, Accord Aerodeck, Coupe, Wagon 1994/97	2156cc.	F22B1 130/145/150HP - F22B4/B5/B8 150HP Ø85		26	
861200	Prelude VTEC 1993/96, Accord 1991/98	2157cc.	H22A1/A2 (DOHC) 16V 185HP Ø87		29	
861300	Prelude VTEC 1997/..., Prelude Type VTEC 1997/00	2157cc.	H22A4/A6/A8 185HP - H22A5 195HP 16V Ø87		30	
861500	Accord, Prelude, Accord Typer R 1998/...	2157cc.	H22A4/A5/A7 (DOHC) 16V 212HP Ø87		32	
861000	Accord, Prelude 1992/96	2259cc.	H23A1/2/3 (DOHC) 16V 158/160HP Ø87		27	
862800	CR-V EX/LX/SE VTEC 2002/06, CR-V II VTEC 2002/06, CR-V III VTEC 2007/...	2354cc.	K24A1 (DOHC) 16V 160/170HP Ø86		38	
864800	Accord VTEC, Accord Coupe VTEC 1998/02, Accord VII Coupe VTEC 1998/00	2997cc.	J30A1/A2 200/207HP (SOHC) 24V V6 Ø86		58	
864900	Legend - Legend Coupe 1991/96	3206cc.	C32A2 (SOHC) V6 24V 200HP Ø90		59	
865000	Shuttle 2000/02, Odyssey 2000/... - 2002/204	3471cc.	J35A1/A2 233/247HP (SOHC) 24V V6 Ø89		60	
HYUNDAI						
991300	Atos 1993/97	800cc.	G4HB (SOHC) 8V Ø63		73	
990600	HB20 2012/...	998cc.	Kappa FFV (DOHC) 12V 75/80HP Ø71		67	
990000	Santra 1997/..., Atos 1998/...	999cc.	G4HC (SOHC) 12V 56HP Ø66		63	
990300	Atos 2003/..., Santra 2003/05	1086cc.	G4HD (SOHC) 12V 63HP Ø67		64	
990500	Atos 2006/10	1086cc.	G4HG (SOHC) 12V 62HP Ø67		66	
991400	Excel, Pony 1986/95	1468cc.	G4AJ (SOHC) 8V 74/84HP G4J 77/84HP Ø75.5		74	
990400	Verna 2000/02	1495cc.	G4EK (SOHC) 12V 92HP Ø75.5		65	
991500	Accent, Elantra 1999/..., Coupe 1992/95	1495cc.	G4K/E 90/92HP - G4EK 67HP (SOHC) 12V Ø75.5		75	
991600	Accent 1996/...	1495cc.	G4K (DOHC) 16V 99HP Ø75.5		76	
990800	Elantra 2006/..., Getz 2009/..., HB20, i30, Veloster 2012/...	1591cc.	Gamma FFV (DOHC) 16V 122/128HP Ø77		69	
991700	Lantra 1990/95	1595cc.	G4CR (DOHC) 16V 104/112HP Ø82.3		77	
991800	Elantra, Lantra 1993/95	1595cc.	G4CR (DOHC) 16V 104/112HP Ø82.3		78	
991900	Lantra, Elantra, Coupe 1995/00	1599cc.	G4DR (DOHC) 16V 84/114HP Ø77.4		79	
990107	Coupe 1997/... - Elantra .../1998	1599cc.	G4DR (DOHC) 16V 84/114HP Ø77.4		1-37	
992100	Lantra 1995/97, Elantra 1996/01, Coupe 1996/01, Tiburon 1996/97	1795cc.	G4DM 128HP - G4GM 95HP (DOHC) 16V Ø82		80	
992200	Sonata 1988/96	1795cc.	G4M (SOHC) 8V 95HP Ø80.5		81	
991700	Elantra, Lantra 1993/95	1836cc.	G4CN (DOHC) 16V 124HP Ø81.5		77	



# INDICE - CATALOGO VEHICULAR

## INDEX - AUTOMOTIVE CATALOG

### HYUNDAI

Ref.	Modelo/Model	Cm <sup>3</sup>	Motor/Engine			
991800	Elantra, Lantra 1993/95	1836cc.	G4CN (DOHC) 16V 124HP Ø81.5		78	
461307	Lantra 1998/... <b>DIESEL</b>	1905cc.	XUD9 68HP Ø83	384	I-37	
460300	Lantra 1998/... <b>DIESEL</b>	1905cc.	XUD9 (SOHC) 8V 68HP Ø83	418	I-36	
990700	i30 2007/..., Tucson 2004/11	1975cc.	G4GC (DOHC) 16V 144HP Ø82		68	
992100	Coupe 1996/99, Tiburon 1997/..., Lantra 1997/00	1975cc.	G4GF (DOHC) 16V 138/140HP Ø82		80	
992300	Sonata TCI, Tucson TCI 2005/... <b>DIESEL</b>	1991cc.	D4EA (SOHC) 16V 143HP Ø83		82	
992400	Tucson TCI 2005/09 <b>DIESEL</b>	1991cc.	D4EA (SOHC) 16V 112HP Ø83		83	
911500	Tucson TCI 2004/..., Trajet CRDI, Elantra CRDI, Santa Fe CRDI 2000/05 <b>DIESEL</b>	1995cc.	D4EA (SOHC) 16V 112HP Ø83		107	
992500	Sonata 1994/99	1997cc.	G4CP (DOHC) 16V 136/139HP Ø85		84	
992600	Trajet 2000/04, Santa Fe 2000/05, Sonata 2001/04	1997cc.	G4JP (DOHC) 16V 136HP Ø85		85	
992700	Sonata 1989/93, H100 1993/..., H1 1997/00	2351cc.	G4CS (SOHC) 8V 110/115HP Ø86,5		86	
910500	H100 D 1996/98, H100TD 1998/..., H1 - H1 TD 1997/... <b>DIESEL</b>	2476cc.	D4BA/BAX 8V 75HP - D4BH/BF 80/85HP Ø91.1		167	
910500	H1 1997/..., H100D 1998/... <b>DIESEL</b>	2607cc.	D4BB (SOHC) 8V 85HP Ø91.1		167	
991000	Santa Fe GL/GLS/FX 2001/06, Sonata GL/GLS/LX 2001/05 - 2005/..., Coupe 2001/07	2656cc.	G6BA (DOHC) V6 24V 167/170HP Ø86.7		71	
991100	Santa Fe GLS 2005/..., Santa Fe 2005/10	2656cc.	G6EA (DOHC) V6 24V 189HP Ø86.7		72	
992800	Sonata 1992/..., Galloper 1998/...	2972cc.	G6AT (SOHC) V6 12V 161HP Ø91.1		87	
995000	Sonata, Galloper 1999/...	2972cc.	G6CT (DOHC) V6 24V 197HP Ø91.1		88	
995100	Mighty, County - Turbo Intercooler <b>DIESEL</b>	3298cc.	D4AL (SOHC) 8V 120HP Ø100		89	83
995200	Mighty, County - Aspirado <b>DIESEL</b>	3568cc.	D4AF (SOHC) 8V 96HP Ø104		90	84
990900	Veracruz, Genesis 2008/...	3778cc.	G6DA (DOHC) V6 24V 264HP Ø96		70	
995300	Mighty, County - Turbo Intercooler <b>DIESEL</b>	3907cc.	D4DA (SOHC) 8V 155HP Ø104		91	85

### IKA

540000	Jeep Continental, Bergantín 1954/74	2470cc.	4L - 151 80HP Ø84.14	461		
540200	Torino, Rambler, Utilitario, Gladiator, Jeep T80 1966/73	2966cc.	OHC 181 4B - 300/300S/380 Ø84.94	463		
540400	Rambler, Torino Tornado 300SL, Gladiator 1966/73	2966cc.	OHC 181/230/300 140/160HP Ø84.94	465		
540100	Estanciera, Baqueano, Gladiator, Continental, Kaiser Carabela, Manhattan 1955/..., Bergantín Super 1954/67	3705cc.	L226 110HP Ø84.14	462		
540300	Torino 1973/...	3770cc.	OHC 181/230/300/380 7B Ø84.94	464		
540500	Torino Tornado Reforma 1972/74	3770cc.	OHC 4B 180HP Ø84.94	466		

### INDENOR

500200	404, T4B, T5B, Rastrojero 1972/... <b>DIESEL</b>	1948cc.	XD/XDP 4.88 50/59HP Ø88	449		
500907	Indenor <b>DIESEL</b>	1948cc.	XD 4.88 con rebaje 50/59HP Ø88	387		
500600	504 1980/..., J7/J9 1980/87 <b>DIESEL</b>	2112cc.	XD-XDP 4.90 59HP Ø90	452		
500707	Indenor 1972/... <b>DIESEL</b>	2112cc.	XD3 76/90HP Ø94	387		
450400	XD2 504D 1976/93, 505D 1979/82, 505TD 1981/..., 604TD 1978/83, J7D1977/..., J9D 1980/... <b>DIESEL</b>	2304cc.	XD2 - XD2P 70/73HP Ø94	399		
450400	XD3 504 1987/..., 505 1982/93, J9 1986/94 <b>DIESEL</b>	2498cc.	XD3 - X3DP 76/90HP Ø94	399		
500300	Pick Up, Camiónes Livianos 1976/... <b>DIESEL</b>	3168cc.	XDP 6.90 95HP Ø90	451		



### ISUZU

242607	I- Mark 1987/... <b>DIESEL</b>	1468cc.	4EC1 50HP Ø76	17	I-40	
242607	Gemini 1987/..., I-Mark, Gemini TD 1988/... <b>DIESEL</b>	1488cc.	4EC1- T4EC1 50/76HP Ø76	17	I-40	
860900	Oasis 1995/97	2156cc.	RJ1 (SOHC) 16V 140HP Ø82		26	
280400	Luv, Pick Up, Trooper II 1986/95, Impulse	2254cc.	4ZD1 (SOHC) 8V 88HP Ø89.3	72	93	
240700	Trooper 1988/92 <b>DIESEL</b>	2499cc.	4JA1 76HP Ø93	36	I-40	
240700	Trooper, Trooper TD 1988/92 <b>DIESEL</b>	2771cc.	4JB1 - 4JB1T 87 /102 HP Ø93	36	I-40	
930500	Tropper, Tropper TD 1988/92 <b>DIESEL</b>	2771cc.	4JB1-T (OHV) 8V 87/102HP Ø93		96	
930300	Tropper TD, Campo TD 1991/... <b>DIESEL</b>	3059cc.	4JG2 82HP (SOHC) 8V Ø95.4		95	
930300	Tropper TD, Campo TD 1991/... <b>DIESEL</b>	3059cc.	4JG2T 109HP (SOHC) 8V Ø95.4		95	
930600	Tropper TD 1991/98, Monterey TD, Campo D 1992/..., Brava TD 1993/... <b>DIESEL</b>	3059cc.	4JG2 105HP - 4JG2T/TC 114/125HP Ø95.4		97	
930100	ELF 250 1982/..., ELF 350 1984/..., ELF 350, ELF 250 1984/... <b>DIESEL</b>	3268cc.	4BC2 - 4BD1 (OHV) 8V 87/88HP Ø102		94	

# INDICE - CATALOGO VEHICULAR

## INDEX - AUTOMOTIVE CATALOG

### JOHN DEERE

Ref.	Modelo/Model		Cm <sup>3</sup>	Motor/Engine			
850000	1030/1035/1520/1530/204/302 1973/...	DIESEL	2696cc.	3164D Ø102			87
850100	Tractor Equipos Viales 2120/2030/2035/2270/2280/2340, JD310/401/440/450/480 1974/...,2130/2135/1640/1840/2140/JD4400/540B/550/555 1980/...	DIESEL	3590cc.	4219 D 81HP Ø102			88
850100	Tractor Equipos Viales 2120/2030/2035/2270/2280/2340 - JD310/401/440/450/480 1974/...-2130/2135/1640/1840/2140/JD4400/540B/550/555 1980/...	DIESEL	3918cc.	4239 D/T 81HP Ø102			88
850100	450/480 1974/...-2130/2135/1640/1840/2140/JD4400/540B/550/555 1980/...	DIESEL	3918cc.	4239 D/T 81HP Ø102			88
850700	Motores Agrícolas e Industriales	DIESEL	4500cc.	4540TJ31 107HP - 4045DJ31 74HP Ø106			94
850300	3420, J10, 4420, 570, Tractor Motoniveladora 1972/...	DIESEL	4976cc.	303 85HP Ø98.04			90
850300	3420, J10, 4420, 570, Tractor Motoniveladora 1972/...	DIESEL	5393cc.	329 87HP Ø102			90
850200	Tractor Motoniveladora 6329D, 3120/3130/3135/2840/630/730/JD303/444/540/570/482/6359D, 3140/3040/3640/4040/960/975/2940/3050/3350/3650	DIESEL	5395cc.	6.329D 87HP Ø102			89
850600	6505/6605/6615/7500, Power Tech, MUM, Power Tech, Gen Set	DIESEL	5395cc.	6068TJ31/32/61 - 6068HJ63 150/178HP Ø106			93
850200	Tractor Motoniveladora 6329D, 3120/3130/3135/2840/630/730/JD303/444/540/570/482/6359D, 3140/3040/3640/4040/960/975/2940/3050/3350/3650	DIESEL	5877cc.	6.359D 87HP Ø106.5			89
850400	3350/3550/6500/6600/7500, Cosechadora 1075 1991/...	DIESEL	5879cc.	6359D 110/125HP Ø106.5			91
850500	730, Tractor 375 1960/74	DIESEL	6156cc.	Ø155.58			92

### KIA

911200	Picanto 2004/12		1086cc.	G4HG (SOHC) 12V 65HP Ø67			104
971300	Pride 1995/...		1323cc.	B3 (SOHC) 16V 73HP Ø71			139
911100	Sephia 1996/...		1498cc.	B5 (DOHC) 16V 105HP Ø78			103
911700	Mentor, Sephia I/II, Suma I/II, Spectra 2003/...		1593cc.	G6D (DOHC) 16V 108HP Ø78			108
911800	Sephia 1996/99		1593cc.	B6ZE (DOHC) 16V Ø78			109
912308	Rio 2002/05		1594cc.	S6D (DOHC) 16V 105HP			I-42
990700	Sportage 2004/06, Cerato 2004/...		1975cc.	G4GC 144HP Ø82			68
911500	Carens II CRDI 2002/06	DIESEL	1995cc.	D4EA (SOHC) 16V 112HP Ø83			107
910100	Sportage TD 1996/...	DIESEL	1998cc.	RF 8V 83HP Ø86			101
900900	Besta 1992/97	DIESEL	2184cc.	R2 72HP Ø86			99
910700	Pregio, K2500 2001/05, Bongo 2006/...	DIESEL	2476cc.	D4BH (SOHC) 8V 94/97HP Ø91 (SOHC) 8V			168
911300	Sorento CRDI 2010/...	DIESEL	2497cc.	D4CB (DOHC) 16V 140HP Ø91			105
912000	Canival 1996/...		2497cc.	KRV6 (DOHC) 24V 165HP Ø80			110
991000	Optima LX/SE/EX 2002/06, Magentis 2002/07		2656cc.	G6BA (DOHC) V6 24V 175HP Ø86.7			71
912100	K2700 1998/00, Pregio 1998/02, Besta GS 2000/..., Bongo 2008/...	DIESEL	2665cc.	J2 (SOHC) 8V 78/83HP Ø94.5			111
912200	K2700 1998/00, Pregio 1998/02, Besta GS 2000/..., Bongo 2008/...	DIESEL	2665cc.	J2 (SOHC) 8V 78/83HP Ø94.5			112
910000	Besta 1993/...	DIESEL	2700cc.	VN 81HP Ø96			100
911000	Besta GS, Besta GS Grand 2000/...	DIESEL	2956cc.	JTA (SOHC) 8V 85HP Ø98			102
990900	Sorento 2007/..., Cadenza 2010/...		3470cc.	G6DC (DOHC) V6 24V 249HP Ø96			70
911400	Amanti, Opirus 2003/...		3497cc.	6GCU (DOHC) V6 24V 200/203HP Ø93			106

### KOMATSU

760100	Tractor, Autoelevador	DIESEL	2800cc.	4D94-E 8V 40HP Ø93			115 97
760200	Tractor, Autoelevador	DIESEL	2800cc.	4D94-E 8V 40HP Ø94			116 98
760000	Tractor, Autoelevador	DIESEL	2940cc.	4D94 8V 39HP Ø104			113 95
760300	Tractor, Autoelevador	DIESEL	2940cc.	4D94 8V 39HP Ø104			117 99
760400	Tractor, Autoelevador	DIESEL	3260cc.	4D95L 8V 54/65HP Ø96			118 100
760500	Tractor, Autoelevador	DIESEL	3260cc.	4D95 8V 54HP Ø96			119 101
760600	Tractor, Autoelevador	DIESEL	4330cc.	4D105-5 63/66HP Ø112			120 102
760700	Tractor, Autoelevador	DIESEL	4330cc.	4D105-3 63HP Ø111			121 103
760800	Tractor, Excavadora	DIESEL	4890cc.	6D95 71HP Ø97			122 104
760900	Tractor, Autoelevador	DIESEL	4890cc.	6D95 71HP Ø94			123 105

### KUBOTA

770000	Maquinaria Agrícola D722	DIESEL	719cc.	3D66 6V 20HP Ø86			125 107
770200	Maquinaria Agrícola D722	DIESEL	719cc.	3D66 6V 20HP Ø77			127 109

# INDICE - CATALOGO VEHICULAR

## INDEX - AUTOMOTIVE CATALOG

### KUBOTA

Ref.	Modelo/Model		Cm <sup>3</sup>	Motor/Engine			
770100	Maquinaria Agrícola D905	DIESEL	898cc.	3D72 6V Ø72		126	108
770400	Maquinaria Agrícola V1205	DIESEL	1200cc.	4D72 8V Ø72.5		129	111
770300	Maquinaria Agrícola D1402	DIESEL	1395cc.	3D85 6V 35HP Ø77		128	110
770500	Maquinaria Agrícola V1502	DIESEL	1498cc.	4D76 8V 46HP Ø77		130	112
770600	Maquinaria Agrícola V2203	DIESEL	2197cc.	4D87 8V 46HP Ø88		131	113
770700	Maquinaria Agrícola V2203	DIESEL	2197cc.	4D87 8V 46HP Ø88		132	114
770800	Maquinaria Agrícola V3300	DIESEL	3318cc.	4D98T 12V Ø98		133	115

### LADA

970600	2101/2102 1970/...		1198cc.	OHC 60HP Ø76		342	
970600	2103/2107 1972/...		1452cc.	OHC 75HP Ø76		342	
970500	2106/2107/2121, Niva 2121 1976/..., Aleko 2141 1990/...		1568cc.	BA3 78HP Ø79		341	
970700	Vaz 21213, Niva 21213 1994/...		1690cc.	17LTBI (SOHC) 8V 80HP Ø82		343	
460300	Niva 2121, Aleko 1990/...	DIESEL	1905cc.	XUD9 (SOHC) 8V 65/68HP Ø83		418	
290900	110 GTi 1996/...		1998cc.	C20XE (DOHC) 16V 150HP Ø86		100	

### LANCIA

251700	Ypsilon 1996/00		1242cc.	840A3 (SOHC) 8V 60HP Ø70.8		173	
270700	Ypsilon 2000/...		1242cc.	Fire 188.A5 (DOHC) 16V 80HP Ø71		206	
272500	Ypsilon 2003/...		1242cc.	178D7 (DOHC) 16V 80HP Ø72		220	
252508	Musa JTD 2004/..., Ypsilon JTD 2004/...	DIESEL	1248cc.	188A9 69HP 199A2 75HP(DOHC) 16V Ø69.6		150	
250500	Prisma 1983/..., Delta 1986/92		1301cc.	831B (SOHC) 8V 75HP Ø86.4		162	
271900	Musa 2004/...		1368cc.	169 A4.000 (SOHC) 8V 75HP Ø72		214	
272500	Ypsilon 2003/...		1368cc.	183A1/192B2 (DOHC) 16V 95HP Ø72		220	
271407	Ypsilon 1995/01		1370cc.	840 A2 (SOHC) 12V 80HP Ø82		154	
250500	Prisma, Delta 1978/81		1498cc.	(SOHC) 8V 80HP Ø86.4		162	
250600	Delta, Prisma 1986/...		1498cc.	831B1 (DOHC) 8Vv 80/82HP Ø86.4		164	
252205/7	Delta i.e, Prisma i.e 1986/89, Delta, Prisma 1986/92		1498cc.	831B1 75/80HP - M202 82HP Ø86.4		150	
260300	Dedra 1989/93		1581cc.	835A (SOHC) 8V 80/90HP Ø86.4		187	
260900	Delta, Dedra, Lybra 1996/...		1581cc.	182A4 103HP - 182A6 90HP (DOHC) 16V Ø86.4		193	
261100	Lybra 2000/05		1596cc.	182B6 103HP Ø77 (DOHC) 16V		194	
273908	Delta 2009/...		1742cc.	939B1 200HP (DOHC) 16V Ø83		156	
260100	Delta, Dedra 1993/99	DIESEL	1756cc.	835C 90/105HP - 836A 90/101HP (DOHC) 8V Ø84		185	
260400	Prisma 1986/91	DIESEL	1929cc.	831D (SOHC) 8V 65HP Ø82.6		188	
270000	Delta, Dedra TD 1994/99		1929cc.	160D (SOHC) 8V 90HP Ø82.6		195	
260100	Thema, Delta Turbo 1987/94	DIESEL	1995cc.	831C 177HP - 834B 115HP (DOHC) 8V Ø84		185	
471500	Phedra JTD, Zeta JTD 2000/...		1997cc.	DW10JATED4 (RHW) - RHM 110HP Ø85		441	
270900	Kappa 1994/01 - 1996/02		1998cc.	838A1/A6 - 182B7 (DOHC) 20V 145/155HP Ø82		207	
271300	Kappa 1994/01	DIESEL	1998cc.	838A1 (DOHC) 20V 145HP Ø82		211	
461500	Zeta TD 1996/00	DIESEL	2088cc.	P8C (SOHC) 12V 109HP Ø85		427	
471500	Phedra JTD 2002/...	DIESEL	2179cc.	DW12TED4 (4HW) (DOHC) 16V 130HP Ø85		441	
251807	Kappa TD 1994/00		2387cc.	838A3 - 838A7 124HP Ø82		150	
271707	Kappa - Kappa Coupe 1998/...		2445cc.	838B2 175HP Ø83		154	
452308	Phedra 2002/...		2946cc.	ES9J4S (XFW) 204HP (DOHC) V6 24V Ø87		156	

### LEYLAND

420600	Sherpa 185/200/215/220/230/240/250/255 1986/94	DIESEL	1994cc.	Prima 65 64HP Ø84.45		380	232
--------	--	--------	---------	----------------------	--	-----	-----

### MAHINDRA

930007	Tractor 255DI - 265DI - Pick Up	DIESEL	1300cc.	25HP Ø89.9		I-44	I-38
930007	Tractor 255DI - 265DI - Pick Up	DIESEL	1800cc.	25HP Ø89.9		I-44	I-38
930007	Tractor 255DI - 265DI - Pick Up	DIESEL	2500cc.	25HP Ø89.9		I-44	I-38

### MAXION INTERNATIONAL

430000	Range Rover TDI, Discovery TDI, Defender TDI 1990/98, Sprinter TDI 1997/...	DIESEL	2495cc.	200/300 TDI 112HP Ø90.5		365	
--------	---	--------	---------	-------------------------	--	-----	--

# INDICE - CATALOGO VEHICULAR

## INDEX - AUTOMOTIVE CATALOG

### MAXION INTERNATIONAL

Ref.	Modelo/Model		Cm <sup>3</sup>	Motor/Engine			
430000	Ranger TDI 1995/..., Blazer TDI, S10TDI 1995/...	DIESEL	2507cc.	95HP Ø90.7	365		
430600	Ranger TD BR 2000-2002/....	DIESEL	2758cc.	Power Stroke 135HP Ø93	366		
430800	Ranger 3.0l, 4 x 4, Full BR Intercooler 2005/8	DIESEL	2798cc.	NGD 3.0 E (SOHC) 16V 163HP Ø96	367		
410600	GM D10, F350, VW6.80, Case 550	DIESEL	3860cc.	4.236 (OHV) 8V Iny. Directa 70HP Ø98.4	377		224
280300	GM D20/D40, Pick Up D20	DIESEL	3990cc.	Maxion S4 102HP Ø100	70		
401100	MF290/292/610/620	DIESEL	4100cc.	P4000-4000T 72/86HP Ø100			212

### MAZDA

972005	345 22/29		1296cc.	E3 (SOHC) 8V 60HP Ø77			I-46
971300	121/323 1992/94		1323cc.	B3 (SOHC) 16V 73HP Ø71			139
974700	323 1991/94, 121, Familia 1992/94		1323cc.	B3 (SOHC) 16V 67HP Ø71			166
971000	323, Familia, Pick Up 1978/80		1415cc.	UC (SOHC) 8V 70HP Ø77			136
971500	Protege, 323 1994/98		1489cc.	Z5 (DOHC) 16V 90/92HP Ø75.3			141
972108	323, Protege 1994/98 - 323 1994/2004		1489cc.	Z5 90/92HP Z5-DE 86/96HP (DOHC) 16V Ø75,3			I-46
970300	818 1972/77		1490cc.	NA (SOHC) 8V 100HP Ø78			135
972005	323 1980/87, Familia 1983/84		1490cc.	E5 (SOHC) 8V 85HP Ø77			I-46
970300	616/626, Capella, B1600 1971/77, Capella, Pick Up 1978/..., E1600 1982/84		1586cc.	NA (SOHC) 8V 75HP Ø78			135
972500	Tierra 1998/...		1594cc.	ZM (DOHC) 16V 88/110HP Ø78.5			144
971400	323, MX-3 1989/94, Familia 1986/89		1597cc.	B6 (SOHC) 8V 84HP Ø78			140
971707	323 1986/94, Familia 1987/94	DIESEL	1720cc	PN (DOHC) 8V 55HP Ø78			I-46
972600	929 1974/78, 121, Capella, Cosmo, Luce, 616 1975/78		1769cc.	VC (SOHC) 8V 100HP Ø80			145
971800	626, Capella, E1800 1982/87		1789cc.	F8 (SOHC) 8V 90/100HP Ø86			143
972800	Familia 323, BG8P 1990/...		1839cc.	BP-ZE (DOHC) 16V 105/115HP Ø83			147
972900	Familia Laser, 323 1990/...		1839cc.	BP (DOHC) 16V Ø83			148
973200	626 1991/97 - MX-6 1994/97		1840cc.	FP (DOHC) 16V 105HP Ø83			151
973000	Anfini M6, Cronos 1991/..., MX-3 1992/99		1845cc.	K8 (DOHC) V6 24V 133HP Ø75			149
972700	626, 929, B2000, Capella, Cosmo 1978/80		1970cc.	MA (SOHC) 8V 110HP Ø80			146
973100	Pick Up 1971/...		1985cc.	VA (OHV) 8V 45HP Ø83			150
973200	MX-6 1994/97, 626 1989/97- 1993/96		1991cc.	FS (DOHC) 16V 117HP Ø83			151
973300	Xedos 6 1991/97, Afini, Cronos 1994/97, 323 1994/99		1995cc.	KF (DOHC) V6 24V 140/144HP Ø86			152
910100	626TD 1993/97, 323D 1998/...	DIESEL	1998cc.	RF - CX 8V 75/82HP Ø86			101
971800	626, Capella, E2000 1982/87, B2000 1985/88 - 1991/96		1998cc.	FE (SOHC) 8V 90/120HP Ø86			143
973400	626 1986/92 - 929 1987/...		1998cc.	FE (SOHC) 12V 109HP Ø86			153
973500	323D 1998/...	DIESEL	1998cc.	RF (SOHC) 8V 71HP Ø86			154
973600	926, 929 1986/...		1998cc.	FE (SOHC) 12V 103HP Ø86			155
302200	Mazda 6 2002/....		1999cc.	LF (DOHC) 16V 141HP Ø87.5	261		I-44
302400	Mazda 6 2002/..., Mazda 3 2003/...		1999cc.	LF (DOHC) 16V 105/141HP Ø87.5	263		I-45
900900	E 2200 1984/86, B 2200 1985/87	DIESEL	2184cc.	R2 64/71HP Ø86			99
973400	Capella, Pick Up 1988/..., 626, MX-6 1988/92		2184cc.	F2 (SOHC) 12V 147HP Ø86			153
973600	626, MX-6 1988/92, Capella, Luce 1988/92		2184cc.	F2 (SOHC) 12V 147HP Ø86			155
973700	Pick Up, B2200, Luce 1979/...	DIESEL	2209cc.	S2 (SOHC) 8V 70HP Ø89			156
302200	Mazda 6 - MPV 2002/....		2261cc.	L3 (DOHC) 16V 104/166HP Ø87.5	261		I-44
971907/8	Xedos 9 1993/95, Millenia 1994/00, 626, MX6 1993/98, Xedos, Milenia 1995/...		2497cc.	KL/KLD (DOHC) V6 24V 165/170HP Ø84.5			I-46
971600	B2500 2002/..., MPV TDI 1996/...	DIESEL	2499cc.	WL (SOHC) 12V 115HP Ø93			142
971100	Camión, Pick Up T2500, Autoelevador Yale 1980/...	DIESEL	2522cc.	XA/XB/S5/WE5 8V 77HP Ø89			137
973800	MPV, B2600 1989/...		2605cc.	G6-E (SOHC) 12V 124HP Ø92			157
973900	B2000 2000/...	DIESEL	2892cc.	W9 (SOHC) 12V Ø94			158
974000	Luce, 929 1987/...		2954cc.	JE-ZE (DOHC) V6 18V 157/167HP Ø89			159
971200	Pick Up, Camión T3000 1985/..., Autoelevador Yale 1984/...	DIESEL	2977cc.	HA/WEF 8V 86HP Ø95			138 117
974100	Truck T3000 1981/84	DIESEL	2977cc.	HA 8V 86HP Ø95			160 118
974200	Truck E3000 1978/81	DIESEL	2977cc.	HA 8V 86HP Ø95			161 119

# INDICE - CATALOGO VEHICULAR

## INDEX - AUTOMOTIVE CATALOG

### MAZDA

Ref.	Modelo/Model	Cm <sup>3</sup>	Motor/Engine			
974300	Truck T3500 1984/...	<b>DIESEL</b> 3455cc.	SL (OHV) 8V Ø103		162	120
974400	Truck T3500 1984/...	<b>DIESEL</b> 3455cc.	SL-T (OHV) 8V 116HP Ø103		163	121
974500	Truck T4000	<b>DIESEL</b> 4021cc.	TF (OHV) 8V Ø105.5		164	122
974600	Truck T4500	<b>DIESEL</b> 4553cc.	TM (OHV) 8V Ø109		165	123

### MERCEDES BENZ

370008	Clase A 140 1997/...	1397cc.	M166.940 82/102HP Ø80	347		
370008	Clase A 160 1997/..., Vaneo 2001/...	1598cc.	M166.961 82/102HP Ø80	347		
582508	Vito 2014/...	<b>DIESEL</b> 1598cc.	622 (DOHC) 16V 88/114HP Ø80	347		
351408	A170 CDI 1998/01, Vaneo TD 2001/...	<b>DIESEL</b> 1689cc.	OM668.940/941 (DOHC) 16V 90HP Ø90	345		
350500	170DA/170DB/170DS/170SD/180D/180DB/O 319D/L405/L406	<b>DIESEL</b> 1767cc.	OM 636.916/918/919/931/930/934 40/45HP Ø75	348		
370100	C180/C160/C200/CLK200 2002/..., E200 2003/..., C230, SLK200 2004/...	1796cc.	MB271 (DOHC 16V) 122/143/163/192HP Ø82	361		
351700	190E 1990/93	1797cc.	MB102.910/919 (SOHC) 8V 108HP Ø89	354		
351600	L307/200D/N1300/MB90/ L307/MB100/L406D/L408D/0309D/306D/306DG/200D	<b>DIESEL</b> 1988cc.	OM 615 (SOHC) 8V 55/60HP Ø87	353		
351700	190 1982/84, 190E 1985/93, 200 1984/93	1996cc.	MB102.921/922/962 (SOHC) 8V 105/122HP Ø89	354		
360500	E200D, C200D, 200D/TD 1984/93	<b>DIESEL</b> 1997cc.	MB601.911/912/913 (SOHC) 8V 72/75HP Ø87	360		
352100	Sprinter 2009/...	<b>DIESEL</b> 2143cc.	OM651 (DOHC) 16V 170/204HP Ø83	356		
353200	E200, C220 2002/..., CLC200/220 2005/..., Viano 2003/..., C220 CDI 2004/...	<b>DIESEL</b> 2148cc.	OM 646 102/122/150HP (DOHC) 16V Ø88	358		
351200	Sprinter 413 CDI 411/413/313/611/981 2000/..., C200-CDI 611.961/960 1998/... Vito 108/110/112 CDI, Sprinter 208/211/213 CDI 611.980	<b>DIESEL</b> 2151cc.	OM 611 - CDI 611.960/961 100/125HP 611.980 100/112HP (DOHC) 16V Ø88 lny. Directa	350		
360500	190D 1984/...	<b>DIESEL</b> 2197cc.	MB601.921 (SOHC) 8V 72HP Ø87	360		
352808	C240, E240 1997/03	2398cc.	MB112.910/911 V6 18V 170HP Ø83,2	346		
360100	240D/TD 1973/..., 207/307/407/507/510D, L406/407DG, 0309D 1977/..., 240GD 1976/87, MB100/200/300/400/180D/150/170	<b>DIESEL</b> 2404cc.	OM 616.912/934/960/916/940/961/963 (SOHC) 8V 65/72HP Ø91	359		142
430000	Sprinter TDI 1997/...	<b>DIESEL</b> 2495cc.	95HP Ø90.5	365		
352400	E270, ML270, CLK270, C270/G270 CDI, Sprinter CDI 1999/... - 2002/...	<b>DIESEL</b> 2685cc.	OM612 156/163/170HP Ø88 (DOHC) 20V	357		
230700	V280 1998/...	2792cc.	MB104.900 (DOHC) V6 12V 174HP Ø81	566		
352507	300/280 1992/..., SL280/C280/S280/E280 1993/...	2799cc.	MB104 193/197/204HP (DOHC) 24V Ø88,5	346		
352808	E320/G320/S320/SL320 1996/... - C320/E320 2000/...	2799cc.	MB112 215/218/224HP V6 18V Ø89,9	346		
351100	Sprinter T1N 1995/99, 290 TD, E290 GTD 1994/...	<b>DIESEL</b> 2874cc.	OM 602.980/982/983 (SOHC) 10V 122/129HP Ø89	349		
351300	210D/310D/410D/G290/290GD 1992/...	<b>DIESEL</b> 2874cc.	MB602.940/942/947 (SOHC) 10V 95/98HP Ø89	351		
352400	C30 CDI AMG 2002/...	<b>DIESEL</b> 2950cc.	OM 612.990 231HP Ø88 (DOHC) 20V	357		
352507	300CE/300E/300TE/300SL 1989/...	2960cc.	MB104.980 220HP MB104.981 231HP Ø88,5	346		
351500	300 Turbo 1985/93, E300 Turbo 1993/96, 300GD 1989/93	<b>DIESEL</b> 2996cc.	OM603.931/950/960/963 (SOHC) 10V 143HP Ø87	352		
351800	300 GD, 300 GD (4 x 4), 209D/309D/ 409D/240D, 300D/CD/TD 1974/89	<b>DIESEL</b> 2998cc.	OM 617.910/913/931/932 80/88HP Ø91	355		
352507	300SE 1991/..., 320CE/320E/320TE 1992/..., SL320/E320 1993/... G320/E320 1995/... S320 1999/...	3199cc.	MB104.990/991 231HP MB104.992/995 220HP MB104.994 228/231HP - MB104.996 211HP Ø89,9	346		
352507	30SL 1992/..., 300CE/300E/300TE 1993/...	3314cc.	MB104.981 231HP - MB104.980 251HP Ø88,5	346		
352507	300 TE 1994/96	3606cc.	MB104.992 272HP (DOHC) 24V Ø89,9	346		
350100	MB L608 D/Unimog 1966/...	<b>DIESEL</b> 3786cc.	OM 314 (OHV) 8V 85HP Ø97			126
350800	711D/811D/609D/614D/709D/809D, OM364 Aspirado 1987/...	<b>DIESEL</b> 3971cc.	OM 364 (OHV) 8V 90/115HP Ø97.5			134
352607	400E/400SE/400SEL 1991/..., 400A/E4001992/95	4196cc.	MB119.971/975 285/279HP V8 32V Ø92	346		
351000	Vario 614/814/815/810 -Atego 712/714/715/717/812/814/815/817/917/1017 1214/1215/1217/1317/1517	<b>DIESEL</b> 4250cc.	OM 904 LA - OM 904 LA IMO Electronico (OHV) 12V 75/125HP Ø102			137
352708	ML430 1998/05	4266cc.	MB113.942 (DOHC) V6 24V 272HP Ø89,9	346		
350000	MB 3500, L3250/L3500 1949/52	<b>DIESEL</b> 4580cc.	L911 OM311/312 98HP Ø90			125
353007/8	Unimog U 2002/..., Atego 2 2004/..., Accelo, Atron 2012/...	<b>DIESEL</b> 4801cc.	OM924 218/156/185HP (OHV) 12V Ø106			I-40
352708	ML500 2001/05 - 2005/11 G5001998/...	4966cc.	MB113 215/218/225HP (DOHC) V6 24V Ø89,9	346		
352607	S500/E500/500E/500SE/500SEL 1991/...	4973cc.	MB119.972/974 320HP MB119.970 326HP Ø92	346		
350200	MB 1112/1114/0140/L1112/L1514 1957/...	<b>DIESEL</b> 5100cc.	OM 321 (SOHC) 12V 108HP Ø95			127
350300	MB 1114, 0140 1972/..., OM 352 Turbinado 1981/..., OM 352 Aspirado 1981/...	<b>DIESEL</b> 5675cc.	OM 352 (OHV) 12V 100HP Ø97			128

# INDICE - CATALOGO VEHICULAR

## INDEX - AUTOMOTIVE CATALOG

### MERCEDES BENZ

Ref.	Modelo/Model	Cm <sup>3</sup>	Motor/Engine			
350400	MB 1517 Turbo 0170, L911, L1518 1978/... <span style="float: right;">DIESEL</span>	5675cc.	OM 352A (OHV) 12V 130HP Ø97			130
360200	Turbinado Aspirado 1981/... <span style="float: right;">DIESEL</span>	5675cc.	OM352 - OM352A (OHV) 12V Ø97			143
352200	MB 1518 desde 1991/... - Motor Híbrido. (Con junta tapa lateral de goma) <span style="float: right;">DIESEL</span>	5765cc.	OM 352 130HP - OM 352A Turbo 156HP Ø97			139
350900	OH1215/1315/1316/1319/1320/1420/1615, Aspirado Turbo 1620, OHL1621 OS1318, L1915/1314/1318/1365/2018/3611R/2214/2217 <span style="float: right;">DIESEL</span>	5957cc.	OM 366 138HP - OM 366A/LA 170HP Euro Ecológico Ø97.50			135
352000	Atego I 925/1225/1228/1325/1328/1525/1528/1823/1828/2523/2528 1998/... <span style="float: right;">DIESEL</span>	6370cc.	OM906 LA 18V Electrónico 231/245/279HP Ø102			138
353107/8	Atego 2 2007/..., Axor 2 2004/..., Conecto 2001/..., Tourino 2003/..., Integro 2006/... <span style="float: right;">DIESEL</span>	7201cc.	OM 926 (OHV) 18V 256/286/305/326HP Ø106			I-40
350600	MB 1521/1526 1985/87 <span style="float: right;">DIESEL</span>	9650cc.	OM 355-5 (OHV) 20V 84HP Ø128			132
360000	1630/1632/1633, MB485.980, MB489.960/961, MB475.907/950, MB954/976 MB979/982/984/986/989/991/994/997/998 <span style="float: right;">DIESEL</span>	9973cc.	OM449A/LA - HLA 5 cilindros (OHV) 10V 180/200HP Ø128			141
360400	0371, Bus 1926 1985/... <span style="float: right;">DIESEL</span>	11580cc.	OM 355-6 230HP Ø128			145
360300	O372/O400/L1395/1939/1941 1973/... <span style="float: right;">DIESEL</span>	11967cc.	OM 447-6 (OHV) 12V 250/300HP Ø128			144
360800	OM457LA/LAIII/HLA/HLA III, OM457.933/938/940/944/949, OM458.960 OM970/980/938CAM, O400BUS Camión LS1938, LK/LS/L2638, <span style="float: right;">DIESEL</span>	11967cc.	OM457 Electrónico - 252 - 456PS 24V 355/380HP Ø128			147
360800	Axor 2035/40/44, 2540/44, 2640/44, 3340/44 4140/44" <span style="float: right;">DIESEL</span>	11967cc.	OM457 Electrónico 24V 355/380HP Ø128			147
361208	Citaro, Travego, Conecto, Axor, Turismo 1998/... <span style="float: right;">DIESEL</span>	11967cc.	OM457 - OM458 (OHC)			I-40
361308	Actros MP4 2011/... <span style="float: right;">DIESEL</span>	12809cc.	OM471.900 422HP (DOHC) 24V			I-41

### MINI

981300	One Coupe (Mini R50) 2000/01, Cooper Coupe (Mini R50) 2000/01	1598cc.	W10B16A 90/116HP Ø77	09		
--------	---	---------	----------------------	----	--	--



### MITSUBISHI

950700	L100, Minicab 1977/83	550cc.	2G 23 28HP Ø70			172
962200	Minicab 800 1986/...	796cc.	3G83 (SOHC) 6V 45HP Ø65			186
962300	Varica 1100 1988/...	1062cc.	4G82 (SOHC) 8V 57HP Ø65			187
962600	Lancer 1973/76	1187cc.	4G42 (OHV) 8V 68HP Ø75			190
950300	Lancer 1977/78	1238cc.	4G36 (SOHC) 8V 73HP Ø73			170
961900	Colt, Lancer 1977/..., Mirage 1979/83	1244cc.	4G11B (SOHC) 8V 72HP Ø69.5			184
962400	Galant 1969/70 - Colt 1969/71	1289cc.	4G30 (SOHC) 8V 87HP Ø73			188
961608	Colt, Lancer 1996/01	1298cc.	4G13 (SOHC) 12V 55HP Ø71			I-50
962500	Colt, Carisma 2001/04, Lancer 2001/08	1299cc.	4G13 (SOHC) 16V 55/82HP Ø71			189
962900	Colt, Lancer, Mirage 1990/96	1299cc.	4G13 (SOHC) 12V 75HP Ø71			193
962600	Delica Colt 1400 1971/79, Galant 1971/73	1378cc.	4G41 (OHV) 8V 85HP Ø76.5			190
962700	Colt 1978/86, Lancer 1978/84, Tredia 1983/84	1414cc.	4G12B (SOHC) 8V 80/82HP Ø74			191
962800	Tractor, Autoelevador <span style="float: right;">DIESEL</span>	1415cc.	K4E 8V 33HP Ø77			192 149
950300	Lancer, Celeste 1977/..., L300 1980/81	1439cc.	4G33 (SOHC) 8V 82/85HP Ø73			170
962400	Galant, Lancer, Colt 1970/75	1439cc.	4G33 (SOHC) 8V 92HP Ø73			188
962900	Colt, Lancer, Mirage 1991/95, Proton 1990/...	1468cc.	4G15/4G15B (SOHC) 12V 90/92HP Ø75.5			193
963000	Lancer, Mirage 1993/...	1468cc.	4G15B (SOHC) 12V 92HP Ø75.5			194
961608	Carisma 1995/...	1497cc.	4G15 (SOHC) 12V Ø75.5			I-50
963100	Tractor, Autoelevador <span style="float: right;">DIESEL</span>	1500cc.	S4L (OHV) 8V 16/37HP Ø78			195 150
963200	Lancer 1998/..., Space Star 1998/06	1584cc.	4G18 (SOHC) 16V 98HP Ø76			196
963300	Mirage 1991/92, Colt, Lancer 1988/89, Lancer, Mirage Turbo 1988/...	1596cc.	4G61 122HP 4G61T 135HP (DOHC) 16V Ø82.3			197
950800	L200, Celeste A144, Lancer A174, Galant A161 1979/81	1597cc.	G32B (SOHC) 8V 86/100HP Ø77			173
961500	Lancer, Colt 1992/...	1597cc.	4G92 (SOHC) 16V 113HP Ø81			181
961700	Lancer, Colt 1983/90, Mirage 1983/... <span style="float: right;">DIESEL</span>	1795cc.	4D65 (SOHC) 8V 58/60HP Ø80.5			182
963400	Galant, Eterna, Lancer, Delica, Cordia 1980/84	1795cc.	4G62B (SOHC) 8V 100HP Ø80.5			198
951600	Pajero iO 1998/...	1799cc.	4G93 (SOHC) 16V 92HP Ø81			174
961800	Pajero IO 1988/...	1799cc.	4G93 (SOHC) 16V 92HP Ø81			183
951600	Eto Carisma 1995/99, Mirage 1997/07, Langer 2001/07, Pajero iO, Pajero Jr 2002/...	1834cc.	4G93 (SOHC) 16V 113HP Ø81			174
963500	Colt, Lancer 1993/95, Carisma, Virage, Galant 1995/...	1834cc.	4G93K (DOHC) 16V 140HP Ø81			199
963600	Eterna, Sava 1989/..., Colt, Lancer 1989/1992	1836cc.	4G67 (DOHC) 16V 136HP Ø82.3			200

# INDICE - CATALOGO VEHICULAR

## INDEX - AUTOMOTIVE CATALOG

### MITSUBISHI

Ref.	Modelo/Model	Cm <sup>3</sup>	Motor/Engine			
963700	Galant, Colt 1975/77	1855cc.	4G15B/G51B (SOHC) 8V 97HP Ø84		201	
580900	Carisma TD 1997/...	<b>DIESEL</b> 1870cc.	F8QT (SOHC) 8V 90HP Ø80	503	I-48	
581608	Space Star TD 2001/..., Carisma 1999/...	<b>DIESEL</b> 1870cc.	F9Q1 - F9Q2 (SOHC) 8V 102HP Ø80	460	I-48	
963700	Celeste, Sigma 1975/78, Galant, Colt 1976/78, Challenger, Sapporo 1977/78	1995cc.	4G52/G52B (SOHC) 8V 105HP Ø84		201	
950600	Sapporo, Super Touring, Super Saloon, Galant L200/L300 1980/93	1997cc.	G63B (SOHC) 8V 100/110HP Ø85		171	
963800	Galant, Freeca 1998/..., Space Runner GDI 1999/...	1997cc.	4G63 (SOHC) 16V 136HP Ø85		202	
963900	Galant, Freeca 1998/..., Outlander, Lancer 2003/...	1997cc.	4G63 (DOHC) 16V 126/135HP Ø85		203	
964000	Eterna, Sava, Colt, Mirage 1989/..., Galant 1987/92, Eclipse 1989/92	1997cc.	4G63 144HP - 4G63BK/4G63T 150HP Ø85		204	
964100	Tractor, Autoelevador	1997cc.	4G63 (SOHC) 8V 105/112HP Ø85		205	151
951700	ASX 2010/... - Lancer 2012/... - Outlander 2012/...	1998cc.	4B11 (DOHC) 16V 118HP Ø86		175	
961300	Lancer D/TD 1992/97, Galant D/TD 1992/...	<b>DIESEL</b> 1998cc.	4D68 68HP - 4D68T 90HP (SOHC) 8V Ø82.7		180	
961800	Pajero TR4 Flex 2002/..., Montero IO - Pajero IO 2001/...	1999cc.	4G64 (SOHC) 16V 131/136HP Ø81.5		183	
964300	Tractor, Canter	<b>DIESEL</b> 2080cc.	4DQ7 8V Ø89		207	153
964200	Tractor, Canter	<b>DIESEL</b> 2084cc.	4DQ5 8V 40HP Ø86		206	152
910500	Canter, L200, L300, Montero, Pajero 1982/86	<b>DIESEL</b> 2346cc.	4D55T (SOHC) 8V 67/84HP Ø91		167	
964400	Galant 1993/...	2350cc.	4G64BK (DOHC) 16V 141HP Ø86.5		208	
964500	Galant, Wagon 1985/92, L200, Pick Up, Space Wagon 1989/92, Pajero, Shogun 1991/93	2350cc.	4G64B (SOHC) 8V 102/112HP Ø86.5		209	
964600	Fortis, Zinger, Fuzion 2005/07	2351cc.	4G64 (SOHC) 16V 132HP Ø86.5		210	
962008	Outlander 2003/06, Galant 2005/09	2378cc.	4G69 (SOHC) 16V 160/163HP Ø87		I-50	
910500	L 200 1987/..., Canter T35 1987/98, Pajero, Montero 1986/...	<b>DIESEL</b> 2476cc.	4D56T (SOHC) 8V 70/75/84HP Ø91		167	
910700	L200, Pajero, Montero, Nativa 2001/...	<b>DIESEL</b> 2476cc.	4D56T (SOHC) 8V 115HP Ø91		168	
964700	Tractor, Autoelevador	<b>DIESEL</b> 2477cc.	S4E 8V Ø95		211	154
964800	Sapporo, Galant, Colt, Eterna 1978/80	2555cc.	4G54B (SOHC) 8V Ø91.1		212	
964900	Galant 1982/...	2555cc.	4G54B (SOHC) 8V Ø91.1		213	
965000	Jeep, Rosa Bus, Canter 1971/81	<b>DIESEL</b> 2659cc.	4DR5 (SOHC) 8V 80HP Ø92		214	
965100	Canter Serie FB3 1985/93	<b>DIESEL</b> 2659cc.	4DR51 (SOHC) 8V 80HP Ø92		215	155
965100	Truck 2.8 Serie FB308 1985/89	<b>DIESEL</b> 2800cc.	4DR51 (SOHC) 8V Ø92		215	155
970400	Nativa TD 1999/..., Montero, Pajero, Shogun TDI 1995/...	<b>DIESEL</b> 2835cc.	4M40TD 125HP Ø95		228	
965200	Tractor, Autoelevador	<b>DIESEL</b> 2960cc.	S4E2 8V Ø100		216	156
960000	Montero Sport, Pajero, Soghun 1995/99	2972cc.	6G72 (SOHC) V6 24V 178HP Ø91.1		176	
960807	Galant, Debonair, Montero, Shogun, Pajero, Pick Up	2972cc.	6G72 (DOHC) V6 24V 141/150/177HP Ø91.1		I-49	
961000	Montero Sport, Pajero Sport 1995/99, Soghun 1995/99	2972cc.	6G72 (SOHC) V6 24V 203HP Ø91.1		177	
962100	Montero III TD 2000/..., Pajero TD 2001/...	<b>DIESEL</b> 3200cc.	4M41T (DOHC) 16V 165/175HP Ø98.5		185	
920600	Canter, Rosa Bus 1978/... - 1983/...	<b>DIESEL</b> 3298cc.	4D30 - 4D31 (SOHC) 8V 90HP Ø100		169	
965300	Tractor, Autoelevador	<b>DIESEL</b> 3331cc.	S4S 8V 39HP Ø94		217	157
961100	Montero, Debonair 1993/..., Shogun, Pajero 1994/...	3497cc.	6G74DN (DOHC) V6 24V 215/260HP Ø93		178	
961200	Montero Sport, Pajero Sport 1997/...	3497cc.	6G74 (SOHC) V6 24V 203/245HP Ø93		179	
966400	Montero, Endeavor 2003/..., Pajero 2007/..., Eclipse 2008/...	3828cc.	6G75 (SOHC) V6 24V 215/250HP Ø95		227	
965400	Tractor, Autoelevador	<b>DIESEL</b> 3900cc.	S6E 12V		218	158
965500	Tractor	<b>DIESEL</b> 4249cc.	S4K Ø102		219	159
965600	Canter 1992/96	<b>DIESEL</b> 4948cc.	6D31T 12V 145HP Ø100		220	160
965700	Tractor, Autoelevador	<b>DIESEL</b> 4996cc.	S6S 12V		221	161
966100	Tractor, Autoelevador	<b>DIESEL</b> 6380cc.	S6KT Ø102		224	164
965900	6000 Bus, 6000 Truck 1984/92 (FK115/FK215/FK415/FK425/FK515)	<b>DIESEL</b> 6557cc.	6D14T 12V Ø110		222	162
966000	6900 Bus 1982/88 (MK116F/MM116H/MM516H), 6900 Truck 1984/92 (FK116/FK215/FK216/FM316)	<b>DIESEL</b> 6919cc.	6D15 12V Ø118		223	163
966200	Bus, Truck (FK416/FK516) 1988/...	<b>DIESEL</b> 7545cc.	6D16A Ø118		225	165
966300	Camión FP418/FV418/FS428, Bus FB418 T850 1988/...	<b>DIESEL</b> 11149cc.	6D22T (OHV) 12V 260/310HP Ø93		226	166

### MWM

331007	D-226-2	<b>DIESEL</b> 2078cc.	D-226-2 (2 cilindros) 40HP Ø105	I-43		
--------	---------	-----------------------	---------------------------------	------	--	--

# INDICE - CATALOGO VEHICULAR

## INDEX - AUTOMOTIVE CATALOG

### MWM

Ref.	Modelo/Model	Cm <sup>3</sup>	Motor/Engine			
310400	F100/F1000/F4000 1993/96, F2000 80/..., FB4000 1985/..., Escavadora FB80 <b>DIESEL</b>	3922cc.	D229-4 96HP Ø102	368		167
310500	F14000/F4000 1994/96, F12000/F14000 1985/..., Tractor S90, FE105, FA120 <b>DIESEL</b>	5883cc.	D229-6 145HP Turbo 160HP Ø102			169
320400	Tractor 86-ID, Camión F4000 1986/..., Tractor 85 1986/... <b>DIESEL</b>	4156cc.	D226-4 (OHV) 8V 82HP Ø105			171
320800	Tractor 65ID, Valmet 62ID 1970/76 <b>DIESEL</b>	2550cc.	D225-3 50HP Ø95			172
330400	7000/7500/8500 - Euro I/II/III - 7100/8120/8140/8150/13150 <b>DIESEL</b>	4300cc.	4.10 X10 90HP - 4.10T/TCA 133/167HP Ø103			173
330500	Agrale TD, Micro/Buses 2000/... <b>DIESEL</b>	2796cc.	MWM 4.07 CA 131HP Ø93	370		
330600	Silverado 3500HD 1997/..., Grand Blazer 1998/..., F100 GMC Turbo 1999/... <b>DIESEL</b>	4200cc.	Sprint 6.07 TD 167HP Intercooler 198HP Ø93	371		
330700	13180/15180/16210 - F14000 1995/98, Euro I/II <b>DIESEL</b>	6450cc.	6.10 X10 139HP - 6.10T/TCA 201/250HP Ø103			174
330800	Camión TX 1600 1983/... - Autoelevador, E300, Tractor 68 1983/... <b>DIESEL</b>	2942cc.	D229-3 (SOHC) 6V 72HP Ø102			176
331100	Blazer, S10 2000/..., LT TDI Electronico 2002/06 <b>DIESEL</b>	2796cc.	Sprint 4.07 TCA Commom Rail 12V 132HP Ø93	372		
331200	Agrale 8500/9200, Constelation 13.180E/15.180E <b>DIESEL</b>	4800cc.	4.12TCE Commom Rail 150/180HP Ø105			177
331300	26.260E/31.260E/17.260EOT/17.210EOD, VM210/260/310 <b>DIESEL</b>	7118cc.	6.12 TCE 210/260/310HP Common Rail Ø105			178
440000	850E <b>DIESEL</b>	2977cc.	D225-4 68HP Ø95			179
440000	Tractor 85ID 1970/76 <b>DIESEL</b>	3400cc.	D225-4 68HP Ø95			179
440100	Camión 1978/... - Tractor AD7B, 980E, S90 - Tractor Valmet 110 ID <b>DIESEL</b>	5100cc.	D225-6 102HP Ø95			180

### NISSAN



903207	March 1982/..., Micra 1988/... <b>DIESEL</b>	988cc.	MA10 (SOHC) 8V 55HP Ø68			I-57
903207	March, Micra 1986/... <b>DIESEL</b>	1235cc.	MA12 (SOHC) 8V 60HP Ø71			I-57
901600	Sunny 1990/..., Sentra 1993/... <b>DIESEL</b>	1295cc.	GA13DS (DOHC) 16V 79HP Ø73.6			236
901700	Sunny 1990/95 <b>DIESEL</b>	1392cc.	GA14DS (DOHC) 16V 82HP Ø73.6			237
904100	Almera 1995/00, Sunny 1995/... <b>DIESEL</b>	1392cc.	GA14DE (DOHC) 16V 87HP Ø73.6			253
902600	Datsun Sedan, Estaquitas, Guayin, Pick Up 1970/84 <b>DIESEL</b>	1483cc.	J15 (OHV) 8V 77HP Ø78			245
901800	Sunny, Vanette 1980/... <b>DIESEL</b>	1487cc.	A15 73/85HP Ø76			238
920000	Samuray, Sedan, Ninja, Guayin 1984/94 <b>DIESEL</b>	1487cc.	E15 (SOHC) 8V 85HP Ø76			297
901900	Tractor <b>DIESEL</b>	1500cc.	H15 8V Ø76			239 181
902000	Tractor, Autoelevador <b>DIESEL</b>	1500cc.	SD15 6V Ø83			240 182
470300	Micra 1997/... <b>DIESEL</b>	1527cc.	TUD5 (VJZ) (SOHC) 8V 58HP Ø77	430		I-55
902600	Datsun Sedan, Estaquitas, Guayin, Pick Up 1970/84 <b>DIESEL</b>	1567cc.	J16 (OHV) 8V 80HP Ø78			245
901007	510 1968/73 - 521 1969/72 <b>DIESEL</b>	1597cc.	L16 (SOHC) 8V 100HP Ø83			I-56
902100	Sentra 1991/94, Tsubame, Tsuru, Vanette Cargo 1993/97 <b>DIESEL</b>	1597cc.	GA16DE/DNE (DOHC) 16V 97/105HP Ø76			241
902900	Tsuru, Sentra 1997/06 <b>DIESEL</b>	1597cc.	GA16DNE (DOHC) 16V 97HP Ø76			246
903700	Sunny, Sentra, Primera 2000/... <b>DIESEL</b>	1597cc.	QG16DE (DOHC) 16V 109HP Ø76			250
920000	Sentra, Tsuru 1984/94 <b>DIESEL</b>	1597cc.	E16 (SOHC) 8V 105HP Ø76			297
571100	Micra 2005/10, Tiida 2007/12, Versa 2016/... <b>DIESEL</b>	1598cc.	HR16DE (DOHC) 16V 111/120HP Ø78	492		I-55
908800	Micra 2002/09, Tiida 2005/..., Bluebird, Versa, March 2006/... <b>DIESEL</b>	1598cc.	HR16DE 110/115HP Ø78 (DOHC) 16V			296
903007	Sunny 1986/89, Pulsar 1987/... <b>DIESEL</b>	1598cc.	CA16DE (DOHC) 16V 122HP Ø78			I-57
902000	Tractor, Autoelevador <b>DIESEL</b>	1600cc.	SD16 6V Ø83			240 182
902407	Sentra 1983/87, Pulsar 1986/..., Cherry, Sunny 1982/89 <b>DIESEL</b>	1680cc.	CD 17 54/61HP Ø80			I-57
903800	Sunny, Bluebird 1998/..., Almera, Pulsar 2000/... <b>DIESEL</b>	1769cc.	QG18DE (DOHC) 16V 114/126HP Ø80			251
901007	skyline - violet - silvia 1976/81 <b>DIESEL</b>	1770cc.	L18/18S (SOHC) 8V 105HP 85			I-56
903400	Tiida 2007/08 <b>DIESEL</b>	1797cc.	MR18DE (DOHC) 16V 124HP Ø84			247
902200	Pick Up, Sacura, Estaquitas, Ichi Van 1981/93, Samuray Guayin 1982/84 <b>DIESEL</b>	1800cc.	J18 8V Ø80.5			242
903007	200 SX Turbo 1989/93, Sunny Turbo 1988/..., Sunny, Pulsar 1988/... <b>DIESEL</b>	1809cc.	CA18DET 16V Turbo 169HP - CA18DE 125HP Ø83			I-57
904500	Bluebird Serie U13 1993/... <b>DIESEL</b>	1838cc.	SR18DE (DOHC) 16V 125HP Ø83			254
581608	Interstar, Primera, Primastar 2002/... <b>DIESEL</b>	1870cc.	F9Q 100/120HP (SOHC) 8V Ø80	460		I-55
900000	Bluebird, Vanette 1980/84 <b>DIESEL</b>	1952cc.	LD20 (SOHC) 8V 60HP Ø85			229
901007	Violet - 200SX 1976/80 <b>DIESEL</b>	1952cc.	L20B (SOHC) 8V 105HP Ø85			I-56
904600	Pick Up D21 1986/88 <b>DIESEL</b>	1952cc.	Z20 (SOHC) 8V 87HP Ø85			255
904700	Bluebird 1983/... <b>DIESEL</b>	1974cc.	CA20S (SOHC) 8V 105HP Ø84.5			256
904800	Primera, Pulsar, Sunny 1991/96, Almera 1995/98 <b>DIESEL</b>	1974cc.	CD20 (SOHC) 8V 75HP Ø84.5			257



# INDICE - CATALOGO VEHICULAR



## INDEX - AUTOMOTIVE CATALOG

### NISSAN

Ref.	Modelo/Model	Cm <sup>3</sup>	Motor/Engine			
900600	Cedric 1965/74, Junior, Caball, Clipper, Cabstar 1965/82, Forklift 1967/82, Caravan	1982cc.	H20 (OHV) 8V 92HP Ø87.2		232	
904900	Autoelevador 1983/...	1982cc.	H20-II (DOHC) 8V 92HP Ø87.2		258	
905000	Cedric 1979/83 <b>DIESEL</b>	1991cc.	SD20 (OHV) 8V 59HP Ø83		259	
903500	X-Trail 2001/..., Primera 2002/...	1998cc	QR20DE (DOHC) 16V 149/150HP Ø89		248	
903107	Primera 1990/96, Sunny GTI Turbo 1990/94, Serena 1992/96	1998cc.	SR20DE 125/150HP - SR20DET 220HP 16V Ø86		1-57	
905100	Datsun Truck 1989/99, Atlas 1990/99, Caravan 1990/99	1998cc.	NA20 (SOHC) 8V 99HP Ø87		260	
905200	Laurel 1985/...	1998cc.	RB20E (SOHC) 12V 96/110HP Ø78		261	
905000	Cabstar, Homer, Clipper 1979/82, Pick UP 720, Cedric 1979/80 <b>DIESEL</b>	2164cc.	SD22 (OHV) 8V 65HP Ø83		259	
905300	Cedric, Cabstar, Pick Up 720 1979/82 <b>DIESEL</b>	2164cc.	SD22 (OHV) 8V 65HP Ø83		262	
904208	X-Trail TD 2001/... <b>DIESEL</b>	2184cc.	YD22DDTi (DOHC) 16V 114HP Ø86		1-58	
905400	Ad Van 1998/..., Sunny 1999/... <b>DIESEL</b>	2184cc.	YD22DD (DOHC) 16V 110HP Ø86		263	
905500	Vanette Cargo 1995/... - Serena 1994/... <b>DIESEL</b>	2283cc.	LD23 (SOHC) 8V 75HP Ø87		264	
900305	Cabstar, Homer 1982/..., Urvan 1984/88 <b>DIESEL</b>	2289cc.	SD23 (OHV) 8V 68HP Ø84		1-55	
905600	Urvan, Cabstar 1987/90 <b>DIESEL</b>	2289cc.	TD23 8V 69HP Ø89		265	
902300	Vanette, Urvan, Chocolate 1987/...	2389cc.	Z24I (SOHC) 8V 103HP Ø89		243	
902500	Ichi Van 1991/94, Pick Up, Terrano II, Van 1989/...	2389cc.	KA24E - KA24S (SOHC) 12V 124/133HP Ø89		244	
903600	Urvan, Urvan 2000/03, King-Cab 2001/..., X-Terra, Frontier, Altima 2000/01	2389cc.	KA24DE 139/150HP Ø89 (DOHC) 16V		249	
905700	Skyline, Blue Bird, Datsun 810 1977/83	2393cc.	L24E (SOHC) 12V 130HP Ø83		266	
906000	Cedric, Fairlady 1970/72, 810 1977/81	2393cc.	L24/L24E (SOHC) 12V 130/140HP Ø83		269	
905800	Skyline 1985/...	2428cc.	RB24S (SOHC) 12V 139HP Ø86		267	
905900	Tractor, Autoelevador	2472cc.	H25 (DOHC) 8V 62HP Ø92		268	184
581800	Primastar 2002/... <b>DIESEL</b>	2484cc	G9U-730 (DOHC) 16V 90HP Ø87	509	1-55	
903500	X-Trail, Altima, Sentra 2002/..., Maxima 2004/...	2488cc	QR25DE (DOHC) 16V 165/177HP Ø89		248	
904000	King-Cab TD 2001/..., Hardbody 2006/... <b>DIESEL</b>	2488cc	YD25DDTi (DOHC) 16V 133/172HP Ø89		252	
900305	Cabstar, Homer 1968/72, Pick Up 720 1984/89 <b>DIESEL</b>	2488cc.	SD25 (OHV) 8V 68/72HP Ø84		1-55	
581800	Interstar 2002/... <b>DIESEL</b>	2499cc.	G9U-720/724/750/754 (DOHC) 16V 90HP Ø87	509	1-55	
906000	Datsun, Skyline 1977/83, Cedric, Fairlady, Laurel 1972/75	2565cc.	L26S (SOHC) 12V 150HP Ø83		269	
920200	Pathfinder D, Terrano D 1986/..., Terrano TD 1989/92 <b>DIESEL</b>	2663cc.	TD27 85HP TD27T 100HP (SOHC) 8V Ø96		298	
906100	Laurel, Cedric, Fairlady 1975/80, 280 Z 1979/80, Patrol 1980/...	2753cc.	L28S 140HP L28E/L28ES 139HP (SOHC) 12V Ø86		270	
950905	280Z 1981/83	2753cc.	L28E/ET 145HP Ø86		1-62	
900100	Laurel, Cedric, Maxime, 810, 280C 1980/... <b>DIESEL</b>	2793cc.	LD28 (SOHC) 12V 84HP Ø84.5		230	
330500	Frontier - X Terra 2003/06 <b>DIESEL</b>	2796cc	Sprint 4.07 CA (SOHC) 12V 132HP Ø93	370	1-55	
331100	Frontier TD, Xterra electrónico 2007/... <b>DIESEL</b>	2796cc	VW28Ti (SOHC) 12V 132HP Ø93	372	1-55	
906200	Laurel, Gloria 1985/89, Pick Up 1987/94, Patrol 1989/96 <b>DIESEL</b>	2825cc.	RD28T (SOHC) 12V 74/101HP Ø85		271	
906300	Patrol TD 1989/96, Y60 1985/... <b>DIESEL</b>	2825cc.	RD28T (SOHC) 12V 116HP Ø85		272	
906400	Cabstar DTI 2006/... <b>DIESEL</b>	2953cc.	Z30DDTi (DOHC) 16V 158HP Ø96		273	
906700	Tractor 1992/..., Condor 1992/94 <b>DIESEL</b>	2953cc.	BD30 8V 86HP Ø96		276	185
900500	Pick Up, Eco T100, Cabstar 1973/... <b>DIESEL</b>	2956cc.	ED30 (OHV) 8V 76HP Ø109		231	
901300	Pathfinder, Terrano 1987/95, Quest, Maxima 1990/98	2960cc.	V30E - VG30E (SOHC) V6 12V 148/170HP Ø87		233	
905800	Skyline, Patrol 1989/93	2962cc.	RB30S (SOHC) 12V 147HP Ø86		267	
906500	Maxima 1995/99, Cefiro 1995/... <b>DIESEL</b>	2988cc.	VQ30DE (DOHC) V6 24V 193HP Ø93		274	
906600	Maxima 2000/..., Cefiro 1998/... <b>DIESEL</b>	2988cc.	VQ30DE (DOHC) V6 24V 241HP Ø93		275	
906800	Trade 1993/96, Cabstar 1998/01 <b>DIESEL</b>	3000cc.	BD30-Ti (OHV) 8V 86HP Ø96		277	186
906900	Frontier, Terrano 1997/... <b>DIESEL</b>	3153cc.	QD32 (OHV) 8V 103HP Ø99.2		278	
907000	Truck 1980/..., Patrol 1982/89 <b>DIESEL</b>	3246cc.	SD33 (OHV) 12V 95/100HP Ø83		279	187
907100	Truck 1986/..., Patrol 1983/... <b>DIESEL</b>	3246cc.	SD33T (OHV) 12V 115HP Ø83		280	188
901400	Máxima Q x 4 1997/..., Pathfinder 1996/..., Frontier 1998/... <b>DIESEL</b>	3274cc.	VG33E (SOHC) V6 12V 168/170HP Ø87		234	
900500	Pick Up, Eco T100, Cabstar 1973/... <b>DIESEL</b>	3298cc.	ED33 (OHV) 8V 84HP Ø109		231	
907200	Atlas 1984/86, Truck 1984/... <b>DIESEL</b>	3298cc.	FD33 8V 99HP Ø108		281	189
907300	Atlas 1983/86, Civilian 1984/88, Truck 1984/... <b>DIESEL</b>	3298cc.	FD33T 8V 118HP Ø108		282	190

# INDICE - CATALOGO VEHICULAR



## INDEX - AUTOMOTIVE CATALOG

NISSAN							
Ref.	Modelo/Model		Cm <sup>3</sup>	Motor/Engine			
907308	Truck 3500, Atlas 1986/91	DIESEL	3460cc.	FD35T Ø102,5		I-61	I-44
901500	Pathfinder, Cefiro, Qx4 2000/01		3498cc.	VQ35DE (DOHC) V6 24V 220HP Ø95.5		235	
907500	Patrol, Safari 1991/...		4169cc.	TB42S (OHV) 12V 170HP Ø96		284	
907600	Patrol, Safari 1988/..., Safari Pick Up 1999/...	DIESEL	4169cc.	TD42 (SOHC) 12V 161HP Ø96		285	
907700	Safari, Civilian, Patrol 1995/...	DIESEL	4169cc.	TD42T (SOHC) 12V 143HP Ø96		286	
907800	Atlas, Condor 1993/...	DIESEL	4214cc.	FD42 8V 123HP Ø109		287	192
907800	Atlas, Condor 1993/...	DIESEL	4617cc.	FD46 8V 133HP Ø109		287	192
907900	Atlas, Condor 1995/...	DIESEL	4617cc.	FD46 (DOHC) 8V 113HP Ø109		288	193
908000	Patrol, Safari 2000/...		4800cc.	TB48E (DOHC) 24V 248HP Ø99.5		289	
907400	Camión 5700 1978/...	DIESEL	5654cc.	ED6 (SOHC) 12V Ø109		283	191
908200	Camión 5700 1980/...	DIESEL	5654cc.	FD6 (SOHC) 12V 170HP Ø108		290	194
908300	Camión 5700 1975/83	DIESEL	5654cc.	FD6T (SOHC) 12V 175HP Ø108		291	195
908400	Camión, Bus 1977/...	DIESEL	6842cc.	ND6 (SOHC) 12V 133HP Ø110		292	196
908500	Camión, Bus 1992/95	DIESEL	9160cc.	NF6T 12V 300HP Ø120		293	197
908600	Camión, Bus 1969/...	DIESEL	10308cc.	PD6 (SOHC) 12V 200/300HP Ø125		294	198
908700	Camión, Bus 1970/...	DIESEL	10308cc.	PD6T (SOHC) 12V 260/300HP Ø127		295	199
PERKINS/MASSEY FERGUSON							
420600	4.20 Marino D/TD 1986/..	DIESEL	1994cc.	Prima 65/80T 58/80HP Ø84.5		380	232
420400	MF50/50X/55X/135/200/235/250, MF 135/515	DIESEL	2360cc.	3.152 (OHV) 6V 42HP Ø89			231
400500	Tractor Víñatero	DIESEL	2362cc.	P3 - 152 42HP Ø91.44			2006
422000	MF133/135/148/230/235/240/254/353, Industrial MF40, Agrícola/Marino	DIESEL	2500cc.	D3.152 - G3.152-D3.152/4 Iny. Dir. 100HP Ø91.40			233
410200	MF50 Tractor, MF50X/55X, MF135/200/235/250	DIESEL	2502cc.	P3 - 152 42HP Ø91.44			220
420400	MF50/50X/55X/135/200/235/250, MF 135/515	DIESEL	2502cc.	3.152 (OHV) 6V 42HP Ø91.44			231
423000	Case-IH CS 68/75 - Challenger	DIESEL	3300cc.	320D/DS 33/69HP Ø108			01
410500	Tractor MF65X, MF40B/65/155/158/165/260/155/164C, CBC1000	DIESEL	3330cc.	D4.203/AD4.203 Iny. Directa 71HP Ø91.4			223
410800	Pick Up, Camiónes livianos	DIESEL	3330cc.	T 4.33 Turbo Iny. Directa 91/95HP Ø91.46	378		226
400000	D100/D200 1987/... - F100, Falcon 1970/...	DIESEL	3336cc.	4.203-P4-192Z (OHV) 8V 71HP Ø91.49	373		201
400700	Tractor M165, 265	DIESEL	3336cc.	MF165 - 265 71HP Ø91.49			208
410000	F100	DIESEL	3336cc.	4.203 Potenciado (OHV) 8V 71HP Ø91.44	376		218
410300	Potenciado	DIESEL	3336cc.	MF265 Potenciado 71HP Ø91.44			221
420100	Tractor 8 BR	DIESEL	3336cc.	4.203 - 8 BR Iny. Indirecta 71HP Ø91.49			229
401000	Vehicular GM D20	DIESEL	3860cc.	Q20B4 (OHV) 8V Iny. Directa 70HP Ø98.4	375		211
410600	GM D10, F350, VW6.80, Case 550, GM D10/20/40 Aspirado Turbo	DIESEL	3860cc.	4.236 (OHV) 8V 70HP Ø98.4	377		224
420200	Case 580H	DIESEL	3860cc.	4.236 Iny. Directa 70HP Ø98.4			230
401500	Phaser 90, Phaser 110T, Phaser 120 Ti, 4.40, T4.40, C4.40, MF6130/40/50	DIESEL	3993cc.	1004.4 86HP 1004.4T/TW 91HP (OHV) 8V Ø100			213
410600	MF220, F290, Tractor MF85X	DIESEL	4070cc.	4.248 (OHV) 8V 70HP Ø101	377		224
410700	Agrícola, Case 580H, MF85, MF270/275/285/290, MF220/220A, Hyster H110	DIESEL	4070cc.	A4 - 248 75HP Ø100			225
420200	Case 580H	DIESEL	4070cc.	4.248 Iny. Directa 100HP Ø100			230
401100	MF290/292/610/620	DIESEL	4100cc.	P4000-4000T 72/86HP Ø100			212
320400	Tractor 85 1986/...	DIESEL	4156cc.	D226-4 (OHV) 8V 82HP Ø105			171
423100	MF4292, MF4297, Challenger	DIESEL	4400cc.	420DS Agco Sisu Power 110/120/129HP Ø108			02
400100	DP 400/500 1964/... - F350/600	DIESEL	5004cc.	6.305 Cadenero (SOHC) 12V 100HP Ø91.44			202
400300	F100/F350/600 1974/...	DIESEL	5004cc.	6PF - 305 (SOHC) 12V/102HP Ø91.44	374		204
400600	Tractor - PF	DIESEL	5004cc.	6PF - MF1175 100HP Ø91.44			207
410100	F600	DIESEL	5004cc.	6PF - 305 Potenciado 100HP Ø91.49			219
400200	DP 600/800 1968/... - F600/700	DIESEL	5798cc.	6.354-2 (OHV) 12V 140HP Ø98.47			203
400400	D600/800 1976/... - F7000 Camiónes - Ford pesados y semi-pesados	DIESEL	5798cc.	6.354-4 Turbo (OHV) 12V 172HP Ø98.42			205
400800	Tractor 1095/1098/1195/1215	DIESEL	5798cc.	140HP (OHV) 12V Ø98.3			209
400900	DP 600/800 - F600/700	DIESEL	5798cc.	6.354-1 (OHV) 12V 135HP Ø98.43			210
401700	1095/1098/1195/1215 1970/..., Tractores, Estancieros, Grúas, Rodantes	DIESEL	5798cc.	6.354-2 (OHV) 12V Turbo Ø98.47			216

# INDICE - CATALOGO VEICULAR

## INDEX - AUTOMOTIVE CATALOG

### PERKINS/MASSEY FERGUSON

Ref.	Modelo/Model		Cm <sup>3</sup>	Motor/Engine			
410400	Tractor MF1215/1218	<b>DIESEL</b>	5798cc.	T6.354-4 (OHV) 12V 172HP Ø98.63			222
410900	MF3366	<b>DIESEL</b>	5840cc.	6-357 Veh. 120HP - Ag. 91HP - Ind. 108HP Ø104			227
420000	MF 400C	<b>DIESEL</b>	5840cc.	6-358 Veh. 133HP - Ag. 118HP - Ind. 127HP Ø104			228
401600	Phaser 125, MF396/399/630/640/3085/6160/6170 - Phaser 160Ti, MF660/3114 3125/3625/3635/3655/6189/6190/8110/8120/8130 - Phaser 180Ti, C,60/6,60 1989/...	<b>DIESEL</b>	5985cc.	1006.6/C/T/TW (OHV) 12V 131/152HP Ø100			214
423200	Case-IH CS/CVX 120, 130, 150 - CVX 1135,1145,1155,1170,1190 Valtra 8000	<b>DIESEL</b>	6600cc.	620D/DS 147/189HP Ø108			03
420508	D170 - P 200/260/270/320 - MF RX 100T	<b>DIESEL</b>	8850cc..	510 -540 V8 Ø108 170/183HP			I-47

### PEUGEOT

451500	205 1987/93, 106 1991/...		954cc.	TU9/M/MZ/K (SOHC) 8V 41/45/50HP Ø70	409		
451800	104 1972/86, 205 1983/86		954cc.	XV3 - XV5 - XV8 45HP Ø70	420		
460500	104, 205 1986/87		954cc.	XV8 45HP Ø70	420		
581000	206 2000/...		999cc.	D4D (DOHC) 16V 70HP Ø69	504		
451800	104 1975/86, 205 1983/86		1124cc.	XW3 - XW7 57HP Ø72	420		
451500	106, 306, Partner 1996/...		1124cc.	TU1M (SOHC) 8V 54HP Ø72	409		
451700	106 1991/..., 306 1993/97, 205 1987/96, 309 1990/93		1124cc.	TU1/K/Z/M (SOHC) 8V 55/60HP Ø72	411		
460500	205 1986/87, 104 1986/...		1124cc.	XW7 55/57hp Ø72	420		
460700	106 1991/..., 306 1993/97, 205 1987/96, 309 1990/93		1124cc.	TU1M/K/Z (SOHC) 8V 55/60HP	422		
472100	208 2012/..., 108 2014/..., 2008, 3008, 5008 2013/..., Partner 2016/...		1199cc.	EB2DTS/DT 110/130HP(DOHC) 12V Ø75	446		
451800	104 1980/84		1219cc.	XZ5 57HP Ø75	420		
450900	403/7 1959/66		1290cc.	7CV 52HP Ø75	406		
460700	205 Rallye 1988/93		1294cc.	TU24 (SOHC) 8V 102HP Ø75	422		
451600	106 1991/96, 309 1992/93, 405 1993/94, 205 1991/93		1360cc.	TU3F2/FM/MC/J2/Z (SOHC) 8V 75/94HP Ø75	410		
451700	106 1991/..., 206 1998/..., 306 1993/..., 405, 205 1987/96, 309 1988/93, Partner 1996/...		1360cc.	TU3/A/S/K/M/JP/MC (SOHC) 8V 65/75/80HP Ø75	411		
451800	104 1982/86, 205 1983/86		1360cc.	XY6B/XY8 - XY6B/XY7 70HP Ø75	420		
452200	206, 307 2001/..., Partner 2005/..., 207 Compact		1360cc.	TU3JP (KFW/K6D) (SOHC) 8V 75HP Ø75	415		
460500	205 1986/87		1360cc.	XY6B - XY7/XY8 70HP Ø75	420		
460700	Partner 1996/..., 306 1993/..., 106 1991/..., 205, 405 1987/96, 309 1988/93, 206 1998/...		1360cc.	TU3JP/S/M/MC/K/A - TU3.2 65/70/75/80HP Ø75	422		
470400	106 1992/95	<b>DIESEL</b>	1360cc.	TUD3 (SOHC) 8V 50HP Ø75	431		
471700	207, 207 SW, 308, 308 SW 2007/...		1397cc.	EP3 (8FS) - EP3 (DOHC) 16V 95HP Ø77	442		
302100	206 TDI, 307 HDI 2001/...	<b>DIESEL</b>	1398cc.	DV4TD (8HZ/8HX) 68HP (SOHC) 8V Ø74	260		
471300	207 Compact	<b>DIESEL</b>	1398cc.	DV6TED4 70HP (DOHC) 16V Ø75	439		
450900	403/8 1955/67		1468cc.	8CV 55/58 Ø80	406		
472200	208 2012/...		1499cc.	TU4M (SOHC) 8V 89/93HP Ø75	447		
470300	106 1994/...	<b>DIESEL</b>	1527cc.	TUD5 (VJZ) (SOHC) 8V 55/58HP Ø77	430		
471300	307 HDI, 407 TD 2004/...	<b>DIESEL</b>	1560cc.	DV6TED4 109HP - DV6TED4 (9HZ) 108HP Ø75	439		
472300	Partner, 308, 207 HDI, 308 HDI 2009/..., 3008 2009/..., 5008 2010/...	<b>DIESEL</b>	1560cc.	DV6C - DV6DTE 112HP (SOHC) 8V Ø75	448		
451200	305 1982/91, 205 1984/96, 309 1985/93, 405 1987/95		1580cc.	XU5 75/90HP - XU51C/52C 75/89HP 8V Ø83	407		
452100	206, 307, Partner 2000/..., 207 SW, 207 Compact		1587cc.	TU5JP4 (NFU/N6A) (DOHC) 16V 109HP Ø78.5	414		
470500	106 1994/..., 306 1993/..., 206 1998/...		1587cc.	TU5JP/J2 (SOHC) 8V 90/103HP Ø78.5	432		
471700	207, 207 SW, 308, 308 SW 2007/..., Partner 2008/..., 3008, 5008 2009/...		1598cc.	EP6 (5FW) EP6C (5F01) (DOHC) 16V 120HP Ø77	442		
471800	207, 207 CC, 308, 308 SW 2007/..., 3008 2009/..., 508, 508 SW, 5008, RCZ 2010/...		1598cc.	EP6DT/CDT/DTS150/156/163HP (DOHC) 16V Ø77	443		
450000	404 1962/80		1618cc.	XC7-XC7P (OHV) 8V 59HP Ø84	392		
450100	504 GLS/GLSE 1969/80		1657cc.	XC7-XC6A (OHV) 8V 59HP Ø85	394		
460100	306 1993/..., 405, 406 1992/..., 406 1997/...		1761cc.	XU7JP-XU7JB (SOHC) 8V 90/103HP Ø83	416		
460800	306 1997/..., 406 1995/96, 406 1997/...		1761cc.	XU7JP4 (DOHC) 16V 112HP Ø83	423		
461100	Partner 1997/...		1761cc.	XU7JB (SOHC) 8V 90HP Ø83	425		
470700	205 TD 1990/96, 405 TD 1988/94, 309 TD 1990/93	<b>DIESEL</b>	1769cc.	XUD7T/TE (SOHC) 8V 78/90HP Ø80	434		
470900	205/309 1983/96, 306 1993/..., Partner 1996/...	<b>DIESEL</b>	1769cc.	XUD7 (SOHC) 8V 60HP Ø80	436		
450200	504 XE/XL/XSE 1973/78		1796cc.	XC7 - XM7 (OHV) 8V 69/70HP Ø85	395		

# INDICE - CATALOGO VEHICULAR

## INDEX - AUTOMOTIVE CATALOG

### PEUGEOT

Ref.	Modelo/Model	Cm³	Motor/Engine			
470600	206, 306 1998/..., Expert, Partner 1999/... <b>DIESEL</b>	1868cc.	DW8 (WJZ/WJY) (SOHC) 8V 71HP Ø82.2	433		
451200	205, 309 1986/94, 305 1983/91, 405 1987/93	1905cc.	XU9 (SOHC) 8V 98/110/125/130HP Ø83	407		
451407	309 1989/93, 405 1987/95	1905cc.	XU9J4 (DOHC) 16V 147/155/160HP Ø83	382		
460200	306, 405, 309GT, 305GTX 1986/93	1905cc.	XU92C (SOHC) 8V 98/102HP Ø83	417		
460300	306 1993/99, 405 1988/95, 1995/..., 305, 309 1982/93, 205, Express 1987/94, Boxer, Expert, Partner 1995/... <b>DIESEL</b>	1905cc.	XUD9 (SOHC) 8V 64/69/71/90HP Ø83	418		
460900	306/405 TD 1992/97, 406 TD 1995/99, 806TD, Expert TD, Boxer TD 1995/... <b>DIESEL</b>	1905cc.	XUD9TE/SD/TF/UTF (SOHC) 8V 76/90/92HP Ø83	424		
461307	306, 405, Boxer, Partner, Expert 1995/... <b>DIESEL</b>	1905cc.	XUD9 (SOHC) 12V 65/69HP Ø83	384		
500200	404, T4B, T5B, Rastrojero 1972/... <b>DIESEL</b>	1948cc.	XD/XDP 4.88 50/59HP Ø88	449		
450300	504 TN/GES/XNA 1976/80	1971cc.	XN1 - XN2 (OHV) 8V 78/85HP Ø88	397		
450500	505, 9R, J9/J5 1980/92	1971cc.	GR/SR - XN1/XN2 (OHV) 8V 85HP Ø88	401		
450600	505 1983/86, 504 1970/84, 604 1982/86	1971cc.	XN2 - XN6 (OHV) 8V 105HP Ø88	403		
450800	505 1987/...	1971cc.	XN1 - XNA - Gamma (OHV) 8V 90HP Ø88	404		
461200	505 Inyección ZEJ 1979/...	1995cc.	ZEJ (SOHC) 8V 110HP Ø88	426		
470800	206/306/406/806 HDI, Boxer, Expert, Partner HDI 1998/..., 307, 607 2000/... <b>DIESEL</b>	1997cc.	DW10TD/ATED 90/110HP (SOHC) 8V Ø85	435		
471108	307, 407, 807 2005/..., 308, Expert 2007/... <b>DIESEL</b>	1997cc.	EW10J4 (DOHC) 16V 140 Ø85	386		
471200	206/307/406/806/807, Expert 2000/..., 406 HPI, 607 2001/..., 407 2004/...	1997cc.	EW10J4 (RFN-RLZ) (DOHC) 16V 136/140HP Ø85	438		
471400	307 HDI FAP 2003/..., 407 HDI 2004/..., Expert HDI 2007/..., 807 HDI 2006/... <b>DIESEL</b>	1997cc.	DW10BTED4 (RHR/RHK) (DOHC) 16V 136HP Ø85	440		
471500	806 HDI, Expert HDI 1999/..., 807 HDI 2000/... <b>DIESEL</b>	1997cc.	DW10ATED4 (RHW/RHT) 109HP Ø85	441		
472000	307, 407, 807 2005/..., Expert 2007/..., 408 2011/...	1997cc.	EW10A (RFJ/RFH) (DOHC) 16V 136/140HP Ø85	445		
471900	308 HDI - 308 SW HDI 2007/... - 308 CC HDI - 407 Coupe HDI - 3008 HDI 407 HDI - 407 SW HDI - 5008 HDI - Expert Tepee - Expert 3 2009/... - RCZ HDI 2010/... <b>DIESEL</b>	1997cc.	DW10CTED4 (RH02/RHH) 150/163HP (DOHC) 16V Ø85	444		
451300	605 1989/98	1998cc.	XU10M/J2 107HP XU102C 114HP (SOHC) 8V Ø86	408		
451900	405 1992/..., 306 1993/...	1998cc.	XU10J2C (RFX) (SOHC) 8V 123HP Ø86	412		
460400	406, 605, 806 Turbo 1996/...	1998cc.	XU10J2TE (SOHC) 8V150HP Ø86	419		
460600	405 1992/..., 306 1993/...	1998cc.	XU10J2C (SOHC) 8V 123HP Ø86	421		
470200	405 MI, 405 TI Turbo 1992/95, 306 1993/...	1998cc.	XU10J4/J4TE (DOHC) 16V 155/200HP Ø86	429		
471000	406, 605 1995/..., 306 1997/..., 806 1998/01	1998cc.	XU10J4R - XU10J4R (RFV) 16V 132/135HP Ø86	437		
461500	605 TD 1990/98 - 1995/98, 406 TD 1995/..., 806 TD 1996/... <b>DIESEL</b>	2088cc.	XUD11ATE/BTE (SOHC) 12V 110HP Ø85	427		
500600	504 1980/..., J7/J9 1980/87, Adaptables Pick Up <b>DIESEL</b>	2112cc.	XD-XDP 4.90 59HP Ø90	452		
461200	505 GTI ZDJ 1982/91	2165cc.	ZDJ (SOHC) 8V 123HP Ø88	426		
471500	607 HDI, 406 HDI 2000/..., 807 HDI 2002/... <b>DIESEL</b>	2179cc.	DW12TED4 (4HX) (DOHC) 16V 133HP Ø85	441		
324800	Boxer HDI 2006/... <b>DIESEL</b>	2198cc.	4HU/4HV (P22DTE) 101/120HP Ø86	326		
450400	XD2 504D 1976/93, 505TD 1981/..., 505D, 604TD, JTD 1978/83, J9D 1980/... <b>DIESEL</b>	2304cc.	XD2 - XD2P (OHV) 8V 70/73HP Ø94	399		
452000	Boxer TDI 1997/... <b>DIESEL</b>	2445cc.	DJ5TED (THX) (SOHC) 8V 107HP Ø92	413		
470000	Boxer D/TD 1994/..., 605 TD 1995/99 <b>DIESEL</b>	2445cc.	DJ5/T (T9A/T8A/THZ) 86/103HP - DK5ATE 130HP	428		
450400	XD3 504 1987/..., 505 1982/93, J9 1986/94 <b>DIESEL</b>	2498cc.	XD3 - X3DP (OHV) 8V 76/90HP Ø94	399		
452507	504 Cabriolet - 604 1974/83	2664cc.	ZM (SOHC) 12V 110HP Ø88	383		
252900	Boxer TDI/HDI 2001/09 <b>DIESEL</b>	2798cc.	8140.43 Euro II - 8140.43S Euro III 125HP Ø94.4	181		
452607	604 1983/87 - 505 1987/90	2849cc.	ZNJ (SOHC) 12V 155/169HP Ø91	383		
452308	406 1999/... - 607 - 807 2000/... - 407 2004/...	2946cc.	ES9J4S 204/210HP - ES9A (XFV) 211HP Ø87	383		
500300	Pick Up, Camiónes Livianos 1976/... <b>DIESEL</b>	3168cc.	XDP 6.90 95HP Ø90	451		

### RASTROJERO

500000	Pick Up, NP6 1955/66 <b>DIESEL</b>	1758cc.	Borgward D4M 42HP Ø78	453		
500100	Pick Up, Kombi, Frontal, NC62/NP66, P63/P64, C66/P67 1964/71 <b>DIESEL</b>	1797cc.	Borgward D301 - E1D 52HP Ø78	454		
500200	404, T4B, T5B, Rastrojero 1972/... <b>DIESEL</b>	1948cc.	XD/XDP 4.88 50/59HP Ø88	449		



### RENAULT

550000	Gordini, Floride, Dauphine 4L - 4F 1960/64	845cc.	670-04/05 Ø58	467		
560300	R5 1973/84	845cc.	839.01 - 800.10 (OHV) 8V 39HP Ø58	477		
580200	Express, Super Cinco 1985/93	956cc.	C1C 700/706 (OHV) 8V 41HP Ø65	498		

# INDICE - CATALOGO VEHICULAR

## INDEX - AUTOMOTIVE CATALOG



### RENAULT

Ref.	Modelo/Model	Cm <sup>3</sup>	Motor/Engine			
571200	Kwid 2017	999cc.	B4D (DOHC) 12V 66HP Ø70	493		
571400	Sandero II y Logan 2017/...	999cc.	B4D 409 (DOHC) 12V 66HP Ø70	495		
581000	Clio 2000/... - Kangoo 2003/...	999cc.	D4D (DOHC) 16V 68/70HP Ø69	504		
580200	R9, R11 1981/89, Super Cinco 1985/93, Clio, Express 1990/93	1108cc.	C1E 688/752/756 (OHV) 8V 45/49HP Ø70	498		
581700	Twingo 2004/..., Clio II 2005/...	1149cc.	D4F 708/728 (SOHC) 16V 75HP Ø69	508		
570500	Twingo 1996/..., Clio 1995/..., Kangoo 1997/..., D7D, Twingo 2001/...	1149cc.	D7F/D7D 734 I/300/700/701/710 55/60HP Ø69	488		
581000	Clio II, Kangoo .../00, Twingo, Clio II, Kangoo 2001/...	1149cc.	D4D 700/712/720 - D4F 702/706/712 75HP Ø69	504		
560800	E5F/E7F Clio, R19 1990/98	1171cc.	E5F/E7F (SOHC) 8V 55/60HP Ø75.8	482		
570000	Twingo, Clio, Express 1992/...	1239cc.	C3G (OHV) 8V 55HP Ø74	483		
550400	R12/R4L/4S/R6/R4 1970/..., R12TS/R15 1972/75	1289cc.	688.01/10-810.88 54HP Ø73	468		
580500	R12, R12TS 1969/75, R12, R15 1976/80, R5 1974/84, Rodeo 1980/81, Estafette 1974/81	1289cc.	810.02/05/09 (OHV) 8V 54/63HP Ø73	500		
580600	Super Cinco, R11, R9 Turbo 1984/93	1289cc.	C1J 782/788/760/764 (OHV) 8V 57HP Ø76	501		
560800	E6J/E7J Clio, R19, Express 1990/95, Kangoo 2001/..., Megane 1995/97	1390cc.	E6J/E7J Energy (SOHC) 8V 77/80HP Ø75.8	482		
570900	K4J - Clio II 2001/..., Scenic 1999/..., Megane II 2003/...	1390cc.	K4J (DOHC) 16V 95/98HP Ø79.5	490		
571000	Sandero 2008/..., Logan 2004/...	1390cc.	K7J 710/714 (SOHC) 8V 75HP Ø79.5	491		
550500	R12TS/R5TX 1976/80	1397cc.	847 (OHV) 8V 63/68HP Ø76	469		
550700	R9 1981/89, R11 1983/89, R19/R21 1988/93, Super Cinco 1985/93	1397cc.	C1J/C2J 60/67HP (OHV) 8V Turbo 104/110HP Ø76	471		
550800	R12/R18, Junior, Trafic 1982/...	1397cc.	847 (OHV) 8V 48HP Ø76	472		
581200	Clio II DCI 2001/... Series 700/702/704/710, Symbol Kangoo DCI 2001/... Series 700/702, Megane DCI 2002/... Series 722/728/729/704/710	1461cc.	K9K DCI (SOHC) 8V 65/80/82HP Ø76	505		
581300	Megane II, Sandero DCI, Sandero Stepway DCI, Symbol DCI, Logan 2006/...	1461cc.	K9K DCI (SOHC) 8V 68/100HP Ø76	506		
550900	R9/R11/R12/R18/R19 1988/...	1565cc.	C1L - C2L Carburador Ø77	473		
580700	Express 1987/96, Super Cinco 1988/96, R9, R11 1988/89	1595cc.	F8M 720/730/736/760 (SOHC) 8V 55HP Ø78	502		
560500	R19, Clio, Express 1996/98	1597cc.	C3L Inyección 74HP Ø76	479		
570200	Megane Scenic RN, Clio 1998/..., Clio II 1998/05, Sandero 2007/..., Symbol	1598cc.	K7M - 744 (SOHC) 8V 75/90/95HP Ø79.5	485		
570900	K4M - Clio, Scenic, Megane, Symbol Laguna 1998/00, Logan 2007/..., Fluence, Duster, Logan, Sandero Stepway, Kangoo 2015/..., Duster 2016/...	1598cc.	K4M (DOHC) 16V 106/110HP Ø79.5	490		
571000	Sandero, Logan 2007/... - 2010/...	1598cc.	K7M-714 84HP, K7M-800 95HP (SOHC) 8V Ø79.5	491		
571100	Capture 2016/...	1598cc.	H4M (DOHC) 16V 111/120HP Ø78	492		
571300	Logan 2007/13, Sandero 2007/14, Symbol 2009/12, Logan II 2014/19, Sandero II 2015/19	1598cc.	K7M - Flex (SOHC) 8V 90HP Ø79.5	494		
582508	Koleos II 2016/..., Megane III, Scenic III 2011/..., Megane IV 2015/...	1598cc.	RM9 (DOHC) 16V 90/95/130HP Ø80	460		
580807	Trafic - Fuego - R18 1978/... - Fuego 1980/85 - R12/R15/R16/R18/R20/R17 1972/...	1647cc.	841,705 - 843,105/110/115/123 79/92HP Ø79	459		
560100	R19 1989/95, R11 1986/89, Clio 1990/93, R21, Trafic, Super Cinco 1986/94	1721cc.	F2N - F3N (SOHC) 8V 75/92HP Ø81	475		
570100	Clio 1991/97, R19 1989/96	1764cc.	F7P 700/704 133/137HP - 720/722 135/140HP Ø82	484		
580400	Clio 1991/97, R19 1989/96	1764cc.	F7P 700/704 133/137HP - 720/722 135/140HP Ø82	499		
580000	Laguna 1998/..., Laguna, Scenic, Megane, Kangoo 2001/...	1783cc.	F4P 16V (DOHC) 120HP Ø82.7	496		
560400	R19, Clio, Laguna 1991/98	1794cc.	F3P Inyección (SOHC) 8V 90/96HP Ø82.7	478		
560600	R9, Express, Clio, Kangoo, Trafic, Scenic, Megane	1870cc.	F8Q (SOHC) 8V 65HP Ø80	480		
560700	R9, Express, Clio, Kangoo, Trafic, Scenic, Megane	1870cc.	F8Q (SOHC) 8V 65HP Ø80 (cárter de aluminio)	481		
570300	Megane DTI, RN, RT, Laguna 716/730/734/750, Scenic 736, Espace 722 99/..., Kangoo 2000/..., Megane Coupe DTI 731 2000/...	1870cc.	F9Q Turbo (SOHC) 8V 80/100HP Ø80 Inyección Directa	486		
580100	Clio II 630/632/662, Kangoo 630/632/662, Rodeo Trafic 600/606 1998/..., Express 644/648 1997/..., Scenic 1999/..., Megane 1997/...	1870cc.	F8Q (SOHC) 8V 65HP Ø80 Inyección Indirecta	497		
580900	R19 DT 1991/96, Megane DT 1996/97, Scenic DT 19986/...	1870cc.	F8Q 740/741/768/784/786 (SOHC) 8V 90HP Ø80	503		
581608	Laguna DCI, Trafic DTI, Kangoo, Master II DTI, Megane DTI, Espace DTI	1870cc.	F9Q 80/110HP (SOHC) 8V Ø80	460		
570600	Laguna N7Q/700/704 1994/99, Safrane N7Q/710/711 1996/99, Space N7Q 1996/...	1948cc.	N7Q (DOHC) 16V 138/140HP Ø83	489		
550600	Master 1981/93, R18, Fuego 1981/86, Trafic, R21/R25 1983/94, Espace 1984/97	1995cc.	829 - J5R/J6R/ J7R 80/105/110/120HP Ø88	470		
582300	Espace IV 2006/..., Laguna II .../2005, Megane II 2006/10, Koleos	1995cc.	M9R 700/740 (DOHC) 16V 150HP Ø84	512		
570100	Clio, Clio Williams 1993/..., Megane Coupe 1995/99, Spider Sport 1993/...	1998cc.	F7R 700/710/714 (DOHC) 16V 147/150HP Ø82	484		
570400	Megane RT, Scenic, Laguna RT, RXE	1998cc.	F3R 722/796/729 (SOHC) 8V 115HP Ø82.7	487		

# INDICE - CATALOGO VEHICULAR

## INDEX - AUTOMOTIVE CATALOG

### RENAULT

Ref.	Modelo/Model		Cm <sup>3</sup>	Motor/Engine			
580000	Megane, Scenic, Espace, Grand Espace, Laguna, Master, Trafic 1999/..., Clio II Sport 2001/..., Duster 2011/...	DIESEL	1998cc.	F4R (DOHC) 16V 140/169HP Ø82.7	496		
582200	Fluence, Megan III 2001/...	DIESEL	1998cc.	M4R 714 (DOHC) 16V Ø84	511		
560000	R18 1981/86, R21 1984/97, Trafic, Master 1981/97	DIESEL	2068cc.	121 (SOHC) 8V 80HP Ø86	474		
550600	R25 1984/92, R18 1985/..., R21, Espace 1986/97, Trafic, Master 1989/..., Fuego	DIESEL	2165cc.	851 - J7T (SOHC) 8V 95/107/115/120HP Ø88	470		
581400	Laguna D 706/790, Laguna TD 752/792/794 96/..., Laguna TD 760/740 1997/...	DIESEL	2188cc.	G8T D/TD (SOHC) 12V 85/115HP Ø87	507		
581507	Laguna 1996/98	DIESEL	2188cc.	GT8 752/792 12V 85HP Ø87	460		
582400	Master III DCI 2010/...		2298cc.	M9T 670/676/680/690/692/698 125/146HP Ø85	513		
251400	B90 1986/88		2445cc.	8140.21 (SOHC) 8V 92HP Ø93	172		
270807	Master 1981/88		2445cc.	S8U 730/731 52HP Ø93	455		
452607	R25 Turbo - Alpine Turbo 1986/92		2458cc.	Z7U-700/702/734 181/205HP Ø91	455		
581800	Master 2001/..., Trafic 2003/...	DIESEL	2463cc.	G9U-720/724/730/750/754 16V 115HP Ø87	509		
582100	Koleos 4x2/4x4		2488cc.	2TR (DOHC) 16V 170HP Ø89	510		
270400	Master 1990/... - 1998/..., Trafic 1990/...	DIESEL	2499cc.	S8U 742/748/770/772/758/780 55/75/80HP Ø93	202		
452507	R25 1984/91		2664cc.	Z7V-708/709 144HP Ø88	455		
252900	Jumper HDI 2001/09	DIESEL	2798cc.	8140.43 Euro II - 8140.43S Euro III 125HP Ø94.4	181		
270300	Master TD 1998/...	DIESEL	2799cc.	S9W 700/702 (SOHC) 8V 115HP Ø94.4	200		
452607	R25 1987/89		2849cc.	Z7W-702/706/707 150HP Ø91	455		
452308	Avatime, Clio II Sport 2000/..., Laguna 2001/...		2946cc.	L7X-721/722/731 (DOHC) V6 24V 207/226HP Ø87	455		
243908	Espace IV DCI 2002/06	DIESEL	2958cc.	P9X-701 (DOHC) V6 24V 180HP Ø87.5	455		
581107	Laguna, Safrane, Espace 1992/98		2963cc.	Z7X 167/170HP V6 Ø93	459		

### ROVER

860000	Metro, 111 1990/94, 111 1995/98		1120cc.	11K2A/D (SOHC) 8V 60HP Ø75	517		
470400	114, Metro 1992/94	DIESEL	1361cc.	TUD3 (K9A) (SOHC) 8V 52HP Ø75	431		
860000	Metro, 114/214 1990/94 - 1995/99		1396cc.	14K2A/D (SOHC) 8V 75HP Ø75	517		
860100	214/414 1995/99, 25, 45 1999/...		1396cc.	14K16 (DOHC) 16V 103HP Ø75	518		
470300	115TD 1995/98	DIESEL	1527cc.	TUD5 (VJZ) (SOHC) 8V 58HP Ø77	430		
860100	216/416 1996/99, 25, 45 1999/...		1589cc.	K16 (DOHC) 16V 111HP Ø80	518		
860300	216/416 1989/92		1590cc.	D16A7 (SOHC) 16V 116HP Ø75		20	
860400	216/416 1992/94		1590cc.	D16A6 (SOHC) 16V 111HP Ø75		21	
470700	218 TD, 418 TD 1991/96, Tourer TD 1996/...	DIESEL	1769cc.	XUD7T/TE (SOHC) 8V 88HP Ø80	434		
860100	200 Vi 218 Coupe 1995/...		1796cc.	18K16 (DOHC) 16V 120/145HP Ø80	518		
860800	618 1996/99		1850cc.	F18A3 (SOHC) 16V 115HP Ø85		25	
460300	218, 418 1991/96	DIESEL	1905cc.	XUD9A (SOHC) 8V 67HP Ø83	418		
420600	Maestro D/TD 1986/95 - Montego TD 1988/95	DIESEL	1994cc.	Prima 65/80T 64/80HP Ø84.5	380	232	
860200	Freelander TCIE 1997/00, 620, 220/420/620TD 1995/99, 25TD, 45TD 1999/...	DIESEL	1994cc.	20T 8V 97HP - 20T2N 105HP (SOHC) 8V Ø84.5		19	
890600	820, 820i, 820Si 16V Inyección Multipunto 1986/90		1994cc.	20HD - M16 (DOHC) 16V 103/120HP Ø84.45	519		
860800	620, 620 SI 1993/97		1997cc.	F20Z1 131HP - F20Z2 (SOHC) 115HP 16V Ø85		25	
861000	623 1993/97		2259cc.	H23A3 (DOHC) 16V 158HP Ø87		27	
500400	Range Rover TD 1986/89	DIESEL	2393cc.	VM492HT (OHV) 8V 113HP Ø92	521		
430000	Range Rover TDI, Discovery TDI, Defender TDI 1990/94 - 1994/98	DIESEL	2495cc.	200/300 TDI 112HP Ø90.5	365		
912000	825 1996/...		2497cc.	KV6 (DOHC) 24V 175HP Ø80		110	
981200	Range Rover Turbo 1994/02	DIESEL	2498cc.	D256TM (SOHC) 12V 136HP Ø80	08		
500400	Range Rover TD 1989/92	DIESEL	2499cc.	HR924HR (OHV) 8V 121HP Ø92	521		
520300	825 TD 1996/99	DIESEL	2499cc.	VM425TD (OHV) 8V 121HP Ø92	522		
323508	Discovery III 4x4 2004/09		4009cc.	406PN 212HP - 40VSER 214HP V6 12V Ø100.4	236		



### SCANIA

810600	P94, R94 1996/...	DIESEL	8974cc.	DSC9, DS19 (OHV) 12V 220/310HP Ø115			245
810300	P94 - R94 1996/...	DIESEL	9000cc.	DSC9 (OHV) 12V 220/310HP Ø115			240
810500	Series P/G/R/T - Serie K, G340, R340, P340, R380, P380 2004/...	DIESEL	10600cc.	DC11.08 340HP (OHV) 24V Ø127			244

# INDICE - CATALOGO VEHICULAR

## INDEX - AUTOMOTIVE CATALOG

### SCANIA

Ref.	Modelo/Model	Cm <sup>3</sup>	Motor/Engine			
810400	Serie4 Camión, 114C/114L 1994/04, 114G 2001/08 <span style="background-color: #ccc; padding: 2px;">DIESEL</span>	10641cc.	DC 11.07 (OHV) 24V 329HP Ø127			242
810700	Serie4 Camión, Tractor, 114C/L 1999/04, 114G 2001/08, BusK 114 1997/07 <span style="background-color: #ccc; padding: 2px;">DIESEL</span>	10641cc	DC 11.07 (OHV) 24V 329HP Ø127			246
810000	Camión, Omnibús L75/76, L/LB/LBS110/L111/LB111/LS111/LT111 LBS111/LBT111 1974/...	11020cc.	D11 - DS11 (OHV) 12V 280/333HP Ø127			235
810100	LB110/LBS110/L111/LS111/LT111/LBS111/LBT111/G112/L112/R112/T112 P113/P113HK/R113/R113HK/T113/K113CBL/K113GLP/K113TLB/K113TLP <span style="background-color: #ccc; padding: 2px;">DIESEL</span>	11020cc.	D11 - DS11 - DSC11 (OHV) 12V 272/354HP Ø127			236
810400	Serie4- Tractor, Camiones, Bus 124C 400/420, 124L 400, 124G 420, Bus K124 T124C/L 400/420 1996/08, 124L 420 2001/08, T124G 400/420, BusK420 2010/... <span style="background-color: #ccc; padding: 2px;">DIESEL</span>	11700cc.	DC12.01/03 400HP - DC12.09 - DSC12.05/06 420HP (OHV) 24V Ø127			242
810700	Serie4 Camión, 114G, 114L 2005/08 <span style="background-color: #ccc; padding: 2px;">DIESEL</span>	11705cc.	DC 12.07 (OHV) 24V 379HP Ø127			246
810400	Serie4- Tractor, Camiones, Bus 124C 440/470, 124L 440/470 1999/08 124G 400/420, T124L 470 1996/08, 124G 440/470 1999/04 <span style="background-color: #ccc; padding: 2px;">DIESEL</span>	11716cc.	DT12.08 441HP - DT12.02 469HP (OHV) 24V Ø127			242
810500	G340/380/420, R340, P340/380, R380 2004/..., Bus Irizar Century 420, Bus K340/420 2006/..., Bus K380, Omni Express 380, P420, G420 2008/... <span style="background-color: #ccc; padding: 2px;">DIESEL</span>	11700cc.	DC12.10 340HP - DC12.13 380HP - DC12.06/12 420HP (OHV) 24V Ø127			244
810500	P380/420, R380/420/470/480, G420 2004/..., G470 2005/..., Bus K380 <span style="background-color: #ccc; padding: 2px;">DIESEL</span>	11716cc.	DC12 (OHV) 24V Ø127			244
810800	Serie4 Camión, P124, R124, T124 1996/01 - 124C, T124C, T124G 1995/08 <span style="background-color: #ccc; padding: 2px;">DIESEL</span>	11716cc.	DSC 12.01/02 (OHV) 24V 360/420HP Ø127			247
810200	R142-T142-R143-T143-R144-T144 <span style="background-color: #ccc; padding: 2px;">DIESEL</span>	14190cc.	D14 - DS14 - DSC14 V8 16V 400/500HP Ø127			238

### SEAT

250800	Marbella 1989/94, 133 1974/78, 850 1964/78, Panda 1980/...	843cc.	08NCA (OHV) 8V 35/45/52HP Ø65	167		
250800	127, Panda 45 1972/..., Ibiza, Terra 1989/93	903cc.	08NCA - 09NCA - 164A 40/45HP (OHV) 8V Ø65	167		
223608	Ibiza, Cordoba 1996/99, Arosa, Cordoba, Ibiza 1999/02	999cc.	AER/ALL/ALD/ANV 50HP Ø67.1	527		
224608	Arosa, Cordoba, Ibiza 1999/02	999cc.	ALD/ANV 50HP Ø67,1	528		
230600	Ibiza, Cordoba 1996/...	999cc.	AER/ALL (SOHC) 8V 50HP Ø67.1	565		
233100	Mii 2011/...	999cc.	CHYA (DOHC) 12V 60/75HP Ø74,5	577		
222000	Ibiza 1993/94	1043cc.	AAU (SOHC) 8V 45HP Ø75	544		
222307	Malaga 1985/93, Ronda 1983/86	1193cc.	021A1 - 021C1 (SOHC) 8V 62/71HP Ø75	526		
232008	Ibiza 2007/8	1198cc.	BBM (SOHC) 6V 60HP Ø76,5	530		
222000	Ibiza 1993/94 - 1993/99	1272cc.	2G/AAV (SOHC) 8V 54HP Ø75	544		
224608	Cordoba, Ibiza 1999/02, Arosa 1999/04, Inca 2000/03	1390cc.	ANW/AUD/ANK/AKK 50/60HP (SOHC) 8V Ø76.5	528		
223708	Ibiza, Cordoba 1996/...	1391cc.	AEX/APQ/AKV/ANX 55/60HP Ø76.5	527		
222407	Malaga 1985/93, Ronda 1984/...	1461cc.	021A2 (SOHC) 8V 85/90HP Ø83	526		
224107/8	Cordoba 2000/...	1595cc.	AUR (SOHC) 8V 100HP Ø81	527		
224300	Ibiza 2001/03, Cordoba 2001/05	1595cc.	APF/AKL/AEH/ANA/ARM (SOHC) 8V 100HP Ø81	559		
223300	Cordoba, Ibiza 1993/94	1598cc.	ABU (SOHC) 8V 75HP Ø76.5	552		
224000	Cordoba, Ibiza 2003/...	1598cc.	BAH (SOHC) 8V 100HP Ø81	557		
223708	Ibiza, Inca 1996/...	1598cc.	AEE/ALM 75HP Ø76.5	527		
250200	1500 1963/71	1600cc.	115C (OHV) 8V 76HP Ø78	159		
222407	Ibiza Sportline 1991/93	1675cc.	021C3 98HP Ø83	526		
221600	Cordoba, Toledo, Ibiza 1994/97	1781cc.	ABS - ADZ (SOHC) 8V 90HP Ø81	540		
221700	Alhambra Turbo 1998/..., Leon Turbo 1998/...	1781cc.	AJH/AJQ/APP Turbo 20V 150/180HP Ø81	541		
223800	Cordoba, Ibiza 1994/97, Toledo GTI 1991/94	1781cc.	ADL/KR/PL (DOHC) 16V 129/139HP Ø81	555		
230300	Ibiza, Cordoba, Toledo 1993/94	1781cc.	ABS (SOHC) 8V 90HP Ø81	563		
232908	Leon - Toledo TSI	1798cc.	CDAA 160HP (DOHC) 16V Ø82,5	530		
233200	Altea TSI - Leon TSI - Toledo TSI 2009/10	1798cc.	CDAA (DOHC) 16V 160HP Ø82,5	578		
223500	Alhambra TDI 2000/... <span style="background-color: #ccc; padding: 2px;">DIESEL</span>	1896cc.	AUY (SOHC) 8V 115HP Ø79,5	554		
230200	Ibiza D/TD, Cordoba 1996/99, Toledo 1997/99 <span style="background-color: #ccc; padding: 2px;">DIESEL</span>	1896cc.	1Y - AAZ (SOHC) 8V 64/75HP Ø79.5	562		
230900	Ibiza SDI/TDI, Cordoba SDI/TDI 1996/..., Toledo TDI, Inca SDI 1994/96 <span style="background-color: #ccc; padding: 2px;">DIESEL</span>	1896cc.	1Z - AFN - AHU - AEY 64/90/110 Ø79.5	567		
232400	Ibiza, Leon, Alhambra TDI 2010/... <span style="background-color: #ccc; padding: 2px;">DIESEL</span>	1968cc.	CFFA 136HP CFHD 143HP (DOHC) 16V Ø81	574		
222908	Toledo - Cordoba - Ibiza - Alhambra 1994/99	1984cc.	ADY - AGG 115HP Ø82.5	526		
223900	Toledo, Ibiza, - Cordoba 1991/94	1984cc.	2E (SOHC) 8V 115HP Ø82.5	556		
221900	Toledo 16V 1994/99, Ibiza, Cordoba 1996/99 - Hasta Motor 031251	1985cc.	ABF (DOHC) 16V 150HP Ø82.5	543		

# INDICE - CATALOGO VEHICULAR

## INDEX - AUTOMOTIVE CATALOG

### SEAT

Ref.	Modelo/Model	Cm <sup>3</sup>	Motor/Engine			
222100	Cordoba, Ibiza, Toledo 1993/99	1985cc.	ABF (DOHC) 16V 150HP Ø82.5	545		
351600	131/132 <span style="background-color: #ccc; padding: 2px;">DIESEL</span>	1988cc.	OM 615 (SOHC) 8V 55HP Ø87	353		

### SHANGHAI

910900	Tractor <span style="background-color: #ccc; padding: 2px;">DIESEL</span>		495A Tracción Simple - 485A 18 Tracción Doble		299	249
--------	---	--	---	--	-----	-----

### SKODA

233100	Citigo 2011/...	999cc.	CHYA/CHYB (DOHC) 12V 60/75HP Ø74,5	577	I-63	
232008	Fabia 2001/04 - 2004/10	1198cc.	AWY/BBM/BMD/CHFA 54/60HP Ø76,5	530	I-63	
233300	Octavia 2004/...	1598cc.	BLF (DOHC) 16V 115HP Ø76,5	579	I-63	
223708	Octavia, Felicia, Pick Up 1996/...	1598cc.	AEE 75HP Ø76.5	527	I-63	
232908	Octavia TSI 2007/...	1798cc.	BZB/CDAA 160/152HP (DOHC) 16V Ø82.5	530	I-63	
233200	Octavia - SuperB - Yeti 2009/...	1798cc.	CDAB (DOHC) 16V 152HP Ø82,5	578	I-63	
223400	Octavia TDI 1996/... <span style="background-color: #ccc; padding: 2px;">DIESEL</span>	1896cc.	AGR/AGP/AHF (SOHC) 8V 68/90/110 Ø79.5	553	I-63	
231100	Octavia 1999/04	1984cc.	APK/AQY/AZH (SOHC) 8V 115HP Ø82.5	568	I-63	

### SMART

380008	Pulse 1996/... - 2001/... - Smart 1998/... - 2001/...	599cc.	Suprex-t (SOHC) 6V 45/54/70HP Ø63,5	347		
380008	City Coupe 2003/04	698cc.	450.300/330/332 (SOHC) 6V 55/64/70HP Ø63.5	347		

### SSANG YOUNG

450400	Korando Family 1993/97 <span style="background-color: #ccc; padding: 2px;">DIESEL</span>	2498cc.	X3DP (OHV) 8V 79HP Ø94	399	I-64	
351100	Korando KJ TDI, Musso MJ TDI 1997/... <span style="background-color: #ccc; padding: 2px;">DIESEL</span>	2874cc.	OM 662 (SOHC) 10V 120HP Ø89	349	I-63	
351300	Korando KJ 1996/..., Musso MJ 1995/... <span style="background-color: #ccc; padding: 2px;">DIESEL</span>	2874cc.	MB602 (SOHC) 10V 95HP Ø89	351	I-63	
352507	Korando, Musso 1996/...	3199cc.	MB162.990 220HP (DOHC) 24V Ø89.9	346	I-63	

### SUBARU

950500	K87/K87L, EK23/EK24, KF1/KT1 1981/...	544cc.	EK 23/24 4V 35HP Ø76			301
951000	Justy, Libero, Sumo 1984/...	997cc.	EF10 (SOHC) 6V 50/55HP Ø78			302
951100	Justy 1987/93, Libero, Sumo 1990/97	1189cc.	EF12 (SOHC) 9V 52/62HP Ø78			303
951200	New Leone, Brat 1975/79	1595cc.	EK 23/24 (SOHC) 8V 82/95HP Ø92			304
951400	New Leone, Brat 1979/...	1781cc.	EA81 (SOHC) 8V 100HP Ø76			305
951500	Leone, XT Coupe 1985/89, Loyale 1990/94	1781cc.	EA82 (SOHC) 8V 90HP Ø92			306
951800	Legacy 1989/...	1820cc.	EJ18 (SOHC) 16V 103/110HP Ø87.9			307
951900	Legacy 1989/...	1994cc.	EJ20GN (DOHC) 16V 200HP Ø92			308
952000	Forester 1998/02, Legacy 1999/02	1994cc.	EJ20T (DOHC) 16V 177/225HP Ø92			309
952100	Legacy, Impreza 1989/...	2212cc.	EJ22E (SOHC) 16V 136HP Ø97			310
952400	Legacy 1996/..., Forester 1997/...	2457cc.	EJ25D (DOHC) 16V 165HP Ø99.5			311
952500	Legacy, Legacy Outback, Legacy Outback Limited 1997/99	2457cc.	EJ25D (DOHC) 16V 165HP Ø99.5			312
952600	Outback, Legacy, Legacy Outback, Legacy Outback Limited 1996/98	2457cc.	EJ25 (DOHC) 16V 155/165/150HP Ø99.5			313

### SUZUKI

916000	Cervo, Alto, Carry, Carol 1988/90	547cc.	F5B (SOHC) 12V 64HP Ø65			318
916000	Alto 1990/94 - 1998/00, Cervo 1990/98, Jimny 1995/98	657cc.	F6A (SOHC) 12V 64HP Ø65			318
916100	Alto 1980/84	795cc.	F8B - AB51 (SOHC) 6V 40HP Ø68.5			319
916200	Jimny, Light Truck 1978/...	797cc.	F8A (SOHC) 8V 41HP Ø62			320
916300	ST100 1983/..., Jimny, Samurai 1982/91, Super Carry 1985/99	970cc.	F10A (SOHC) 8V 40HP Ø65.5			321
916400	Cultus, Sprint, Swift, Forsa 1984/88	993cc.	G10 (SOHC) 6V 50HP Ø74			322
916600	Baleno, Swift 1995/...	993cc.	G10BB (SOHC) 16V 53HP Ø72			324
916500	Wagon R 1997/00	996cc.	K10A (DOHC) 16V 65HP Ø68			323
241200	Fun 2002/...	999cc.	MPFI (SOHC) 8V 60HP Ø71.1	41	I-65	
910400	Swift 1989/94	1298cc.	G13K (DOHC) 16V 115HP Ø74			317
916700	Cultus 1996/...	1298cc.	G13BA (SOHC) 16V 64HP Ø74			325
916800	Wagon, Carry 1998/..., Swift 1998/01, Baleno 1995/00, Jimny 1998/00, Cultus 1993/03	1299cc.	G13BB (SOHC) 16V 76/98HP Ø74			326
910300	Swift, Sidekick, Samurai, Cultus 1985/89	1324cc.	G13A (SOHC) 8V 64/68HP Ø74			316
916900	Ignis 2000/03, Liliana 2001/03, Jimny 2001/02	1328cc.	M13A/M13AWT (DOHC) 16V 83/90HP Ø78			327



# INDICE - CATALOGO VEHICULAR

## INDEX - AUTOMOTIVE CATALOG

### SUZUKI

Ref.	Modelo/Model	Cm <sup>3</sup>	Motor/Engine			
910200	Escudo 1988/88, Vitara 1988/93, Sidekick 1989/95	1590cc.	G16KC/G16A (SOHC) 8V 82HP Ø75		315	
460300	Vitara 1995/96	<b>DIESEL</b> 1905cc.	XUD9 (SOHC) 8V 68HP Ø83		418	I-65
460900	Vitara TD 1996/...	<b>DIESEL</b> 1905cc.	XUD9 TE (SOHC) 8V 75HP Ø83		424	I-65
461307	Vitara 1995/96	<b>DIESEL</b> 1905cc.	XUD9 (SOHC) 8V 68HP Ø83		384	I-65
917000	Vitara, Grand Vitara 1998/05, Aerio 2002/...	1995cc.	J20A (DOHC) 16V 128/140HP Ø84		328	
470800	Vitara HDI, Grand Vitara HDI 2000/...	<b>DIESEL</b> 1997cc.	RHZ (SOHC) 8V 110HP Ø85		435	I-65
910100	Vitara TD 1996/...	<b>DIESEL</b> 1998cc.	RF 71/87HP Ø85		101	
917100	Vitara, Escudo 1995/00	1998cc.	H20A (DOHC) V6 24V 136HP Ø78		329	
917200	Vitara, Grand Vitara 1998/01	2493cc.	H25A (DOHC) V6 24V 144HP Ø84		330	
917300	Grand Vitara, Grand Escudo 2001/05	2736cc.	H27A (DOHC) V6 24V 173HP Ø88		331	

### TATA

920700	Sumo Telcoline TDI	<b>DIESEL</b> 1905cc.	4DL - NA 8V Ø83		333	
--------	--------------------	-----------------------	-----------------	--	-----	--

### TOYOTA

923900	Yaris 1999/03	998cc.	1SZ-FE (DOHC) 16V 68HP Ø69		354	
924600	Yaris 2003/...	998cc.	1SZ-FE (DOHC) 16V 68HP Ø69		360	
923000	Starlet 1984/88	999cc.	1E (SOHC) 12V 54HP Ø70,5		350	
926600	Etios Cross - Avanza	1197cc.	3NR-FE (DOHC) 16V 80HP Ø72.5		375	
924000	Echo Verso 2001/05, Yaris 2001/...	1298cc.	2NZ-FE (DOHC) 16V 85HP Ø75		355	
926908	Yaris 2016/...	1329cc.	1NR-FE (DOHC) 16V 99HP Ø72,5		I-72	
923407	Corolla, Paseo, Starlet 1992/00	1332cc.	4E-FE (DOHC) 16V 88HP Ø74		I-70	
923300	Corolla 1999/...	1398cc.	4ZZ-FE (DOHC) 16V 97HP Ø79		351	
924100	Starlet D 1987/96	<b>DIESEL</b> 1453cc.	1N (SOHC) 8V 54HP Ø74		356	
926600	Etios 2010/..., Etios Liva 2012/..., Yaris 2018/...	1496cc.	2NR-FE (DOHC) 16V 90HP Ø72.5		375	
926908	Yaris 2015/17	1496cc.	2NR-FE (DOHC) 16V 107HP Ø72,5		I-72	
923407	Corolla, Paseo, Starlet 1992/00	1497cc.	5E-FE (DOHC) 16V 90HP Ø74		I-70	
924000	Corolla 2000/07	1497cc.	1NZ-FE (DOHC) 16V 106HP Ø75		355	
922900	Corolla 1992/99, Avensis 1997/00, Sprinter 1991/...	1587cc.	4A-FE (DOHC) 16V 110HP Ø81		349	
924900	Spacio 1998/99	1587cc.	4A-FE (DOHC) 16V 110HP Ø81		363	
970000	Corolla, Corona, Carina, Celica, Town Ace, Camry 1976/80	1588cc.	12TU/2TJ 8V74HP Ø85		381	
950400	Corona 1970/74	1591cc.	7R (OHC) 8V 85HP Ø86		380	
923300	Corolla 1999/..., Avensis 2000/..., Corolla Verso 2001/...	1598cc.	3ZZ-FE (DOHC) 16V 110HP Ø79		351	
950400	Corona, Mark II 1968/70	1707cc.	6R (OHC) 8V 85HP Ø86		380	
924900	Corolla 1992/95 - Corolla DX/LE 1993/97 - Celica 1993/99 - Corolla CE 1997/...	1762cc.	7A-FE (DOHC) 16V 115/125HP Ø81		363	
970000	Carina, Celica, Corona, Corolla, Cressida, Camry, Town Ace 1978/80	1770cc.	3TEU/13TU 8V 95HP Ø85		381	
923300	Corolla 19997/98, Celica, MR2 Spider 1999/05, Rav 4 2000/04, Corolla Verso 2001/... Matrix 2003/08	1794cc.	1ZZ-FE (DOHC) 16V 123/129/135/140HP Ø79		351	
927000	Corolla 2015/...	1798cc.	2ZR-FE (DOHC) 16V 132HP Ø80.5		378	
950400	Corona, Mark II 1973/..., Celica 1976/...	1808cc.	16R (OHC) 8V 95HP Ø88.5		380	
900200	Corolla, Town Ace 1982/83	<b>DIESEL</b> 1839cc.	1C (SOHC) 8V 84HP Ø83		335	
920500	Corolla, Lite-Ace, Town-Ace 1984/88, Camry TD, Vysta TE 1983/85	<b>DIESEL</b> 1839cc.	1CL - 1CTL (SOHC) 8V 80/88HP Ø83		339	
950400	Corona Mark II 1969/74, Celica, Hilux Pick Up 1970/...	1858cc.	8R (OHC) 8V 105HP Ø86		380	
950400	Corona, Cressida, Hi Lux, Carina 1972/..., Celica, Mark II, Hi Ace 1976/...	1968cc.	18R (OHC) 8V 100/110HP Ø88.5		380	
924700	Mark II, Corona, Carina, Hi-Ace, Camry, Cressida, Celica 1979/83	1972cc.	21R-U (SOHC) 8V 105HP Ø84		361	
920400	Town Ace D, Camry D 1989/..., Camry TD 1985/91, Carina II D 1984/92, Carina E TD 1996/..., Corona D, Lite Ace 1983/96	<b>DIESEL</b> 1975cc.	2C/2C-T/2C-TE (SOHC) 8V 73/81/83HP Ø86		338	
930700	Tarago, Previa, RAV4, Avensis Verso TD 2001/05, Picnic TD, Avensis TD 2003/...	<b>DIESEL</b> 1995cc.	1CD-FTV (DOHC) 16V 115HP Ø82.2		379	
923108	Picnic, Avensis Verso, Avensis 2001/...	1998cc.	1AZ-FE/FS (DOHC) 16V 150HP Ø86		I-69	
924300	Hi-Ace 1989/...	1998cc.	1RZ/1RZ-E (SOHC) 8V 101HP Ø86		357	
924400	Autoelevador 1995/00	<b>DIESEL</b> 1998cc.	1DZ II (OHV) 8V 54HP Ø86		358	251
924500	Autoelevador 1998/05	<b>DIESEL</b> 1998cc.	1DZ (OHV) 8V 52HP Ø86		359	252

# INDICE - CATALOGO VEHICULAR

## INDEX - AUTOMOTIVE CATALOG

TOYOTA							
Ref.	Modelo/Model		Cm³	Motor/Engine			
921800	Hi-Ace, Toyo-Ace, Hi-Lux, Crown, Chasser, Cressida, Mark II 1977/85	DIESEL	2188cc.	L (SOHC) 8V 72HP Ø90			340
924800	Dyna, Celica, Hi-Lux, Coaster, Corona, Pick Up 1974/80		2189cc.	20R (SOHC) 8V 100HP Ø88.5			362
923500	Town-Ace 1985/90, Hi-Lux, Van 1989/93, Lite-Ace 1992/95, Dyna 200 1995/...		2237cc.	4Y (OHV) 8V 94HP 4Y-EC 94/98/101HP Ø91			352
922800	Highlander 2000/..., Camry 2002/..., Rav 4, Solara, Avensis, Verso 2003/...		2362cc.	2AZ-FE (DOHC)16V 150/160HP Ø88.5			348
923108	Camry, Previa 2000/...		2362cc.	2AZ-FE (DOHC) 16V 156HP Ø88.5			1-69
923600	Corona, Celica, Hi-Lux, 4 Runer 1985/95		2366cc.	22R 97HP - 22REC (SOHC) 8V 105HP Ø91.9			353
925000	Dyna, Coaster, Hi Lux 1980/84		2366cc.	22R/22REC (SOHC) 8V 100HP Ø92			364
925100	Celica, Corona, Pick Up, Coaster, Hi-Lux 1982/84		2366cc.	22R/22REC (SOHC) 8V 100HP Ø92			365
922500	Celica, Hi-Lux, Corona, 4 Runner 1980/84		2367cc.	22R/REC (OHC) 8V 100HP Ø92			347
925200	Celica, Corona, Pick Up		2367cc.	22R (SOHC) 8V 100HP Ø92			366
926800	Hi Lux, Hi Ace, Innova 2015/...	DIESEL	2393cc.	2GD-FTV (DOHC) 16V 160HP Ø92			377
910600	Hi-Lux, Dyna, Mark II, Corona, Land Cruiser, Hi-Ace, Cressida 1988/...	DIESEL	2446cc.	2L (SOHC) 8V 75/83HP Ø92			336
921900	Hi-Ace, Toyo-Ace, Hi-Lux, Crown, Cressida, Dyane, Land Cruiser 1982/88	DIESEL	2446cc.	2L (SOHC) 8V 75/86HP Ø92			341
926700	Hi Lux, Hi Ace III/IV, Mark II 1988/..., Crown 1989/96, Land Cruiser 1990/95	DIESEL	2446cc.	2L 8V 83HP Ø92			376
926700	Hi Lux, Hi Ace III/IV, Mark II 1988/..., Crown 1989/96, Land Cruiser 1990/95	DIESEL	2446cc.	2LT 8V 90HP Ø92			376
500400	Land Cruiser 70 TD 1987/89	DIESEL	2494cc.	VM66A (OHV) 8V 108HP Ø88	521		1-68
922400	Hi-Lux, Dyna 150TD, Hi-Ace TD 2001/..., Hi-Lux TD, D4D 2005/...	DIESEL	2494cc.	2KD - FTV (DOHC) 16V 88/102HP Ø92			346
500400	Land Cruiser 250 TD 1990/93	DIESEL	2499cc.	VM84A (OHV) 8V 114HP Ø88	521		1-68
926800	Hi Lux, Hi Ace, Innova 2015/...	DIESEL	2755cc.	1GD-FTV (DOHC) 16V 177HP Ø92			377
920100	Hi Lux, Hi Ace, Toyo Ace, Land Cruiser 1988/...	DIESEL	2779cc.	3L (SOHC) 8V 123HP Ø96			337
925300	Tractor 6F, Autoelevador	DIESEL	2953cc.	1Z 5FD/F 59HP Ø96			367 253
925700	Hi-Lux 1994/..., Solara 1995/99, Camry 1996/97, Siena 1997/...		2965cc.	1MZ-FE (DOHC) 24V V6 190HP Ø87.5			369
900405	Coaster, Landcruiser 1980/82, Dyna 1980/88, Toyo Ace 1980/85	DIESEL	2977cc.	B (OHV) 8V 85HP Ø95			1-68
922200	Hi-Lux TD, 4 Runner TD, Land Cruiser TD 1993/96	DIESEL	2982cc.	1KZ-T/TE (SOHC) 8V 125HP Ø96			343
922300	Hi-Lux TD, D4D 2005/..., Land Cruiser 90/120 TD 2000/... - 2002/...	DIESEL	2982cc.	1KD - FTV (DOHC) 16V 163HP Ø96			344
925400	Hi-Lux TD 2005/...	DIESEL	2982cc.	1KD-FTV (DOHC) 16V 163HP Ø96			368
922100	Hi-Lux LN147/152/167/172 1997/..., Hi-Ace LH162/172/174/181 1998/...	DIESEL	2987cc.	5L (SOHC) 8V 88HP Ø99.5			342
925900	Dyna D, Toyo-Ace D 1984/88	DIESEL	3431cc.	13B (OHV) 8V 90HP Ø102			370
925900	Toyo-Ace TD, Dyna TD, Land Cruiser TD 1984/89	DIESEL	3431cc.	13B-T (OHV) 8V 103/123HP Ø102			370
926500	Tractor 1988/...	DIESEL	4430cc.	11Z Ø96			374 254
926400	Land Cruiser 1993/98		4447cc.	1FZ-FE (DOHC) 24V 202HP Ø100			373
926100	Dyna 200, Coaster 1988/...	DIESEL	3661cc.	14B/BT (OHV) 8V 97HP Ø102			371
926200	Coaster TD, Dyna 200 TD 1999/...	DIESEL	4104cc.	15B-FT (OHV) 16V 145HP Ø108			372
VALMET							
320800	Tractor 65ID, Valmet 62ID 1970/76	DIESEL	2550cc.	D225-3 50HP Ø95			172
330800	Autoelevador, E300, Tractor 68 1983/...	DIESEL	2942cc.	D229-3 (SOHC) 6V 72HP Ø102			176
440000	Tractor 85ID 1970/76	DIESEL	3400cc.	D225-4 68HP Ø95			179
320400	Tractor 86-ID	DIESEL	4156cc.	D226-4 (OHV) 8V 82HP Ø105			171
440100	Tractor 110 ID	DIESEL	5100cc.	D225-6 102HP Ø95			180
VALTA							
423000	A65, A75, 305, 355, 365, 405, 455, 465, 555, 565, 600, 700 SISU 320D, 320DS	DIESEL	3300cc.	320D/DS 33/69HP Ø108			01
423100	A950 (4x2, 4x4), A990 (4x2, 4x4), BM100 (4x2, 4x4), BM110 (4x2, 4x4)	DIESEL	4400cc.	420DS Agco Sisu Power 106/116HP Ø108			02
423200	8000	DIESEL	6600cc.	620D/DS 147/189HP Ø108			03
VM-BORGWARD							
500400	75TD 1984/92	DIESEL	1995cc.	VM80A (OHV) 8V 95HP Ø88	521		
500400	75 TD 1989/92, 90TD 1984/97, Range Rover TD 1986/89	DIESEL	2393cc.	VM81A 110HP - VM492HT (OHV) 8V 113HP Ø92	521		
500400	Land Cruiser 70 TD 1987/89	DIESEL	2494cc.	VM66A (OHV) 8V 108HP Ø88	521		
500400	155TD 1993/97, 164TD 1987/92 - 1992/98, Scorpio TDI, Granada TDI 1993/94, Falcon 1988/..., Range Rover TD 1989/92, Land Cruiser 250 TD 1990/93	DIESEL	2499cc.	VM84A 114HP - VM08B/07B - VM31B/32B 125HP HR924HR 121HP (OHV) 8V Ø92	521		
520300	Dakota TD, Grand Voyager TD 1995/..., Grand Cherokee TD,	DIESEL	2499cc.	VM425TD - VM41B (OHV) 8V 114/115HP Ø92	522		

# INDICE - CATALOGO VEHICULAR

## INDEX - AUTOMOTIVE CATALOG

### VM-BORGWARD

Ref.	Modelo/Model	Cm³	Motor/Engine			
520300	Cherokee 1997/..., 825 TD 1996/99	<b>DIESEL</b> 2499cc.	VM425TD - VM41B (OHV) 8V 114/115HP Ø92	522		
520400	Jeep Cherokee, Grand Cherokee, Dakota, Caravan 2001/...	<b>DIESEL</b> 3100cc.	VM531TD (OHV) 8V 142HP Ø92	523		

### VOLARE

870800	Cinco 2016/...	<b>DIESEL</b> 2776cc.	ISF2.8 (SOHC) 16V 150HP Ø94			28
--------	----------------	-----------------------	-----------------------------	--	--	----

### VOLKSWAGEN

310700	Gol 1.0 1993/...	997cc.	CHT/AE Ø70.3	282		
223608	Polo 1996/..., Lupo 1998/...	999cc.	AER/ALL 50HP Ø67.1	527		
224200	Fox 2003/...	999cc.	AQZ - BJE (SOHC) 8V 71/72HP Ø67.1	558		
224608	Lupo 1999/05 - Lupo, Polo 1999/01	999cc.	ALD/ANV/AUC 50HP Ø67,1	528		
230500	Gol 1000, Saveiro 1998/...	999cc.	AT (DOHC) 16V 69HP Ø67.08	564		
230600	Gol 1000, Saveiro, Polo 1995/...	999cc.	AER/ALL (SOHC) 8V 50HP Ø67.1	565		
231200	Gol Power 2002/...	999cc.	AT (SOHC) 8V 50/69HP Ø67.1	569		
231300	Gol Power 2002/...	999cc.	AT (DOHC) 69HP 16V Ø67.08	570		
233100	UP 2011/...	999cc.	CHYA/CHYB (DOHC) 12V 60/75HP Ø74,5	577		
222000	Golf, Jetta 1985/91, Polo 1985/92, 1990/94	1043cc.	HZ/AAK/ACM/AAU (SOHC) 8V 45/50HP Ø75	544		
232008	Polo 2002/07 - 2007/..., Fox 2005/..., 2010/...	1198cc.	AWY/BBM/BMD 55HP CHFA/BBM 60HP Ø76,5	530		
222000	Golf, Jetta, Polo 1985/92 - 1987/94	1272cc.	UN/UN/2G/AAV (SOHC) 8V 55/60/75HP Ø75	544		
220300	Kombi, Escarabajo, Fusca 1969/...	1285cc.	Air Cooler 39/43HP Ø77	532		
223708	Polo 1994/...	1296cc.	ADX 55HP Ø76.5	527		
224000	Fox 2005/..., Polo 2003/05	1390cc.	BKR/BLM (SOHC) 8V 75/86HP Ø76,5	557		
224608	Lupo 1999/... - 2000/05, Polo 1999/01, Caddy 1999/01	1390cc.	ANV/AKP 55HP AUD/AKK 60HP (SOHC) 8V Ø76,5	528		
232600	Gol Power, Kombi 2006/...	1390cc.	EA111 (SOHC) 8V 83HP Ø76,5	575		
233900	Golf TSI 2005/07, Jetta TSI, Tiguan TSI 2006/...	1390cc.	BLG/BMY/BWK/CAVA 16V 140/170HP Ø76,5	582		
222000	Golf, Vento 1991/94	1391cc.	ABD (SOHC) 8V 60HP Ø75	544		
223708	Golf, Vento 1995/98	1391cc.	AEX/APQ 55/60HP Ø76.5	527		
233500	Golf TSI Generación VII	1395cc.	5G1 - BE1 (DOHC) 16 V 150HP Ø74	581		
220400	Passat, Dasher (USA) 1975/80, Caddy, Jetta, Scirocco, Golf, Gacel 1975/84	1457cc.	EH/GH/JB/FT/FV/YP 75/85/110HP Ø79.5	533		
220800	Passat, Golf, Dasher (USA), Scirocco, Rabbit 1974/82	1457cc.	ZC/YJ/FL/FB/FD/FH/FK 65/85HP Ø76.5	535		
220100	1500 1982/...	1498cc.	Hillman 72HP Ø86	115		
300700	Saveiro, Voyage, Logus 1989/...	1555cc.	CHT/AE (SOHC) 8V 73HP Ø77	248		
220400	Golf, Rabbit, Passat, Scirocco, Jetta, Santana 1979/83, Caribe, Atlantic 1977/84	1588cc.	FN/FP/FS/FT/FR/WY/YN/YS/YY 75/110HP Ø79.5	533		
223207	Caddy D, Jetta D/TD, Golf D/TD, Santana D/TD, Passat D/TD, TYP 2/80 Transporter, D/TD 1985/93	<b>DIESEL</b> 1588cc.	CS/JX/JP/CY/JK/RA/SB/CR/SV/1V/ME/JR (SOHC) 8V 49/54/70/80HP Ø76.5	527		
230100	Senda, Saveiro, Caddy, Golf D/TD, Passat, Kombi, Santana 1981/86	<b>DIESEL</b> 1588cc.	CR/JK/JP/JR/JF/JX/CS/CY 49/54/70HP Ø76.5	561		
220600	Gacel, Senda, Voyage, Gol, Santana, Passat, Apollo, Logus 1985/...	1595cc.	AP (SOHC) 70HP Ø81	534		
224107/8	New Beetle, Bora, Golf 2000/...	1595cc.	AYD/AVU (SOHC) 8V 100HP Ø81	527		
224300	Derby, Bora, Passat, Golf 1999/...	1595cc.	APF/AKL/AEH (SOHC) 8V 100HP Ø81	559		
230300	Caddy, Polo 1995/97	1595cc.	1F (SOHC) 8V 75HP Ø81	563		
233300	Golf, Vento 1992/94, Golf FSI, Touran FSI, Passat FSI, Jetta FSI 2005/... Eos FSI - Polo - Crosspolo 2006/...	1598cc.	ABU 75HP - BTS/BLF 105/115HP (DOHC) 16V Ø76,5	579		
223300	Golf, Vento 1992/94	1598cc.	ABU (SOHC) 8V 75HP Ø76.5	552		
224000	Polo, Caddy 1997/01, Gol 2001/... ,Lupo 2004/09, Fox 2005/... , Fox Route, Suran 2006/..., Voyage, Gol Trend	1598cc.	BAH/ BLH/BJA/BPA (SOHC) 8V 100HP Ø76,5	557		
233400	Suran, Suran Cross, Saveiro, Novo Fox, Gol Rallye, Saveiro Cross 2015/...	1598cc.	EA211 (DOHC) 16V 110HP Ø76.3	580		
223708	Vento, Polo 1994/..., Caddy 1997/...	1598cc.	AEA/AEE 75HP Ø76.5	527		
220400	Rabbit, Dasher (USA) 1980/84, Jetta 1981/84, Scirocco 1981/83, Quantum 1982/83, Caribe, Atlantic 1977/84	1714cc.	EN 77/80HP Ø79.5	533		
220600	Gacel, Senda, Voyage, Gol, Santana, Passat, Apollo, Logus 1984/...	1781cc.	AP (SOHC) 8V 70HP Ø81	534		
221400	Transporter T4 1990/92	1781cc.	PD (SOHC) 8V 67HP Ø81	338		
221600	Vento 1992/97, Passat 1991/96	1781cc.	AAM/ABS/ADZ (SOHC) 8V 75/90HP Ø81	540		

# INDICE - CATALOGO VEHICULAR

## INDEX - AUTOMOTIVE CATALOG

### VOLKSWAGEN

Ref.	Modelo/Model	Cm³	Motor/Engine			
221700	New Beetle, Passat Turbo 1999/..., Golf, Sharan Turbo 1997/..., Bora Turbo 2000/...	1781cc.	AGU/ARZ/AJH/AVC 150HP ARG/APT 125HP Ø81	541		
221800	Passat 1996/99 - 1999/..., Passat Turbo 1996/98	1781cc.	AEB/ANB 150HP - AFY/ADR 115HP 20V Ø81	542		
223800	Golf 1989/91, Scirocco 1985/92, Jetta 1986/87, Passat, Corrado 1990/92	1781cc.	KR (DOHC) 16V 130HP Ø81	555		
230300	Golf 1991/99, Vento 1992/97, Polo Classic, Passat 1991/96, Jetta 1994/96	1781cc.	AAM/ABS/ADZ/ADD (SOHC) 8V 75/90HP Ø81	563		
220100	1800 1982/...	1798cc.	Hillman 110HP Ø86	115		
232908	Passat TSI 2007/...	1798cc.	BZB/CDAA/CDAB 160/152HP (DOHC) 16V Ø82.5	530		
233200	Passat TSI 2007/...	1798cc.	CDA/CDAB (DOHC) 16V 152/160HP Ø82,5	578		
231600	Golf, Jetta, Combi Panel 1992/99 (Fuel Injection con sello de válvula de 7 mm)	1800cc.	L4 F.I 90HP Ø91	573		
223400	Bora, Golf SDI/TDI 1997/... <b>DIESEL</b>	1896cc.	ALH/AHF/AGR/AGP 8V 68/90/110HP Ø79.5	553		
223500	Passat TDI 1999/..., Sharan TDI 2000/..., Transporter TDI 2003/... <b>DIESEL</b>	1896cc.	ATJ/AUY 115HP - AXB 105HP - AXC 85HP Ø79.5	554		
230200	Passat TD 1994/96, Golf D/TD, Vento D/TD 1995/98, Polo D, Caddy 1995/... <b>DIESEL</b>	1896cc.	1Y/AAZ/AEY (SOHC) 8V 64/75HP Ø79.5	562		
230900	Golf SDI/TDI 1993/95-1999/..., Vento SDI/TDI 1993/95, Sharan TDI 1995/96, Passat TDI 1993/95-1995/..., Polo TDI/SDI 1995/96, Caddy SDI 1995/... <b>DIESEL</b>	1896cc.	AHU/AVG/AEY/1Z/AFN/AHH (SOHC) 8V 64/90/110HP Ø79.5	567		
232400	Pick Up Amarok TDI 2010/... Inyección directa Common Rail <b>DIESEL</b>	1968cc.	CDBA/CDCA (DOHC) 16V 90/120HP Ø81	574	352	
221400	Transporter T4 1990/03	1969cc.	AAC (SOHC) 8V 84HP Ø81	238		
221000	Golf, Passat 1992/96, Polo 1999/..., Golf Cabrio 1999/02 - Desde Motor 031252	1984cc.	ATU/AWF/AWG/ABA/AKR 115HP Ø82.5	535		
222908	Passat - Golf - Vento 1994/97 - Sharan 1995/...	1984cc.	ADY/AGG/AEP 107/115HP Ø82.5	526		
223900	Golf GTI, Vento, Passat, Corrado 1991/94	1984cc.	2E 115HP Ø82.5	556		
230000	Carat, Quantum, Pointer, Gol, Golf, Santana 1989/...	1984cc.	Audi 827 (SOHC) 8V 107/115HP Ø82.5	560		
231100	Golf, New Beetle 2002/..., Transporter Minibus 2003/..., Caddy 2006/..., Bora 2005/...	1984cc.	BEH/BER/AZG/AXA 115HP - BSX 109HP Ø82.5	568		
232908	Golf, Eos, Tiguan, Passat, Scirocco, Jetta FSI 2007/...	1984cc.	CBFA/CCTA/CAWB/CCTB/CAWA 210HP Ø82.5	530		
233000	Santana 1998/...	1984cc.	AP 8V 107/115HP Ø82.5	576		
233200	Golf FSI, Tiguan FSI, Eos FSI, Passat FSI 2007/..., Scirocco FSI 2008/...	1984cc.	CBFA/CCTA/CCZA/CCTB/CAWB 170/200HP Ø82,5	578		
221900	Golf, Passat 1992/96 - Hasta Motor 031251	1985cc.	ABF (DOHC) 16V 150HP Ø82.5	543		
222100	Golf, Passat, Passat Variant 1992/97	1985cc.	ABF (DOHC) 16V 150HP Ø82.5	545		
231100	Polo BR 2002/...	1985cc.	BBX 116HP Ø82.5	568		
222200	Passat, Santana 1983/88	1994cc.	JS/HP (SOHC) 10V 115HP Ø81	546		
222200	Passat, Quantum 1985/88	2226cc.	KV/HY 115/120/136HP Ø81	546		
923500	Taro 1989/94	2237cc.	4Y (OHV) 8V 94HP Ø91	531	352	
221100	Transporter T4, Transporter Syncro 1992/99, Eurovan, Caravelle 1997/... <b>DIESEL</b>	2370cc.	AAB/AJA (SOHC) 10V 75/78HP Ø79.5	537		
224408	LT28/31/35/40/45/50/55TD 1992/95 - LT TD 1991/95 <b>DIESEL</b>	2383cc.	ACT 70HP - ACL 95HP - CP 75HP Ø76.5	528		
221500	Transporter T4 1998/..., Transporter Syncro TDI 1998/..., LT SDI 1996/... Transporter T4 TDI 1995/99 <b>DIESEL</b>	2459cc.	AJT 88HP AGX 75HP ACV 102HP (SOHC) 10V Ø81	539		
231500	Eurovan 2001/04	2461cc.	AET/APL/AVT/L5 (SOHC) 10V 115HP Ø81	572		
231400	Bora, Vento 2005/09	2480cc.	L5 BGP/BGQ (DOHC) 20V 148/168HP Ø82,5	571		
231908	Passat TDI V6 24V 1998/03 - 2003/05 <b>DIESEL</b>	2496cc.	AFN/AKN/BDG 150/163HP BAU/BDH 179HP Ø78.3	529		
870800	Delivery 4-150, 6-150 <b>DIESEL</b>	2776cc.	ISF2.8 (SOHC) 16V 150HP Ø94			28
230700	Passat VR6 1991/96, Golf VR6, Vento VR6 1992/97, Jetta 1993/...	2792cc.	AAA (DOHC) V6 12V 174HP Ø81	566		
330500	LT TDI 1997/..., Electronico 2002/06 <b>DIESEL</b>	2796cc.	AGK-ATA 125/132HP BCQ 158HP Ø93	370		
331100	LT TDI Electrónico 2002/06 <b>DIESEL</b>	2796cc.	BCQ (SOHC) 12V 158HP Ø93	372		
230700	Passat VR6 1994/96, Golf VR6 1994/97	2862cc.	ABV (DOHC) V6 12V 190HP Ø82	566		
234000	Amarok TDI 2017 <b>DIESEL</b>	2967cc.	DDXA (DOHC) V6 24V 163HP Ø83	583		
232808	Touareg, Touareg TSI 2010/... <b>DIESEL</b>	2995cc.	CJTA/CGFA/CGEA V6 24V 290/333HP Ø84.5	530		
232708	Passat FSI 2005/... <b>DIESEL</b>	3168cc.	AXZ V6 (DOHC) 24V 250HP Ø86	530		
232508	Touareg 2003/06, Golf 2005/..., Eos 2006/..., Golf 2007/..., New Beetle RSI 2000/01	3189cc.	BAA/BMX/BRJ/BUB/CBRA 220/250HP VR6 Ø84	530		
232508	Golf 2002/04, Touareg 2003/06, Phaeton 2003/07, Transporter 2004/...	3189cc.	BFH/BKL/BRK/ADZ/BKJ/BMV 220/240HP Ø84	530		
232708	Passat FSI - Eos - Phaeton - Touareg FSI 2005/... <b>DIESEL</b>	3597cc.	BHK/BHL/BLV VR6 V6 (DOHC) 24V 280HP Ø89	530		
330400	7100/8120/8140/8150/13150 <b>DIESEL</b>	4300cc.	4.10 X10 90HP - 4.10T/TCA 133/167HP Ø103			173
331200	Constellation 13.180E/15.180E - Commom Rail <b>DIESEL</b>	4800cc.	4.12TCE (OHV) 8V 150/180HP Ø105			177
330700	13180/15180/16210 <b>DIESEL</b>	6450cc.	6.10 X10 139HP - 6.10T/TCA 201/250HP Ø103			174

# INDICE - CATALOGO VEHICULAR

## INDEX - AUTOMOTIVE CATALOG

### VOLVO

Ref.	Modelo/Model	Cm³	Motor/Engine			
331300	26.260E/31.260E/17.260EOT/17.210EOD - Common Rail <span style="float: right;">DIESEL</span>	7118cc.	6.12 TCE 210/260/310HP Ø105			178
870600	17220/17300/17310/18310/19320/26320/17250E/19320E/24250E Bus 17260EOT/18320EOT 2003/...	8270cc.	ISCe6 24V 315HP Ø114			26

### VOLVO

580500	66 1973/...	1289cc.	B130/B130S 57HP Ø73	500		
321600	C30, S40, V50 2005/...	1596cc.	B4164S3 (DOHC) 16V 101HP Ø79	302		
570600	S40/V40 B4184S 1995/...	1731cc.	B4184S (DOHC) 16V 115HP Ø83	489		
580900	440TD, 460TD 1994/97, V40TD, S40TD 1996/99 <span style="float: right;">DIESEL</span>	1870cc.	D19T - D4192T (SOHC) 8V 90HP Ø80	503		
581608	S40, V40 TD 2001/...	1870cc.	D4192T3 115HP D4192T4 102HP (SOHC) 8V Ø80	584		
570600	S40/V40 B4204S/T 1996/...	1948cc.	B4204S 140HP - B4204T 160HP (DOHC) 16V Ø83	489		
890007	240/242, 244 GLS, 245GLS 1977/77, 340 GLS, 360 GLT, 360 GLS 1980/84	1986cc.	B19A/B19E 90/117HP Ø89	460		
890007	240/242/244/245/260 1975/...	2127cc.	B21E/B21F/B21FT 136HP Ø92	584		
224408	240/244/245/740/760/780/940/960 TD 1982/93 - 940/960TD 1993/96 - <span style="float: right;">DIESEL</span>	2383cc.	D24T/TIC 112/129HP - D24 82/85HP Ø76,5	584		
890100	S40 II T5, V50 T5 2004/..., S60 I/II, S80 I/II 2003/..., C30 T5 2007/12 <span style="float: right;">DIESEL</span>	2521cc.	B5254 210/300HP (DOHC) 20V Ø83	585		
324700	S40, V50, C70, C30, S80, V70 2004/08 - 2007/...	2551cc.	B524T3/T6/T7/T8 - 200/220/230HP Ø83	325		
452507	260 - 262 - 264 - 365 1975/80	2664cc.	B27E/B27F 114HP Ø88	584		
452607	760 1982/85 - 260/262/264/265 1980/... - 780 1986/91 - 940/9601990/...	2849cc.	B28E/B28F 155HP - B28A 129HP - B280F Ø91	584		
880908	Metrobus 7700 1998/..., FL7 FL 7/230/245/260 1985/99, FL7 FL 7/285/290 1993/99, FM7 FM 7/250/290 1998/01, FS7 FS 718/230 1994/96 <span style="float: right;">DIESEL</span>	6725cc.	TD71F/FA/FAQ/FC/FCQ/FD/FQ/FS/FSQ/G/E/FSO TD73E/ES - D7A/B 260/285HP 12V Ø104.8	584		I-50
331300	VM210/260/310 <span style="float: right;">DIESEL</span>	7118cc.	6.12 TCE 210/260/310HP Common Rail Ø105			178
880000	B58, B10M 1987/...	9600cc.	THD 101 KC (OHV) 12V 273/310HP Ø120.6			255
880100	B58 1980/85 <span style="float: right;">DIESEL</span>	9600cc.	THD 100D (OHV) 12V 230/260HP Ø120.6			257
880200	N10 1980/85 <span style="float: right;">DIESEL</span>	9600cc.	TD 100A (OHV) 12V 230/260HP Ø120.6			259
880300	N10 1985/89 <span style="float: right;">DIESEL</span>	9600cc.	TD 100G - 101G/F (OHV) 12V 273/300HP Ø120.6			261
880500	NL10 1998/ <span style="float: right;">DIESEL</span>	9600cc.	EDC Ø120.6			265
880600	NL10 1989/97 <span style="float: right;">DIESEL</span>	9600cc.	TD 102F - 102FS (OHV) 12V 234/317HP Ø120.6			267
880208	N12 1980/89 <span style="float: right;">DIESEL</span>	11950cc.	TD 121G/120GA 295/360HP - 121F 385HP Ø130.2			I-50
880400	N12 1980/89 <span style="float: right;">DIESEL</span>	11950cc.	TD 121G/120GA 295/360HP - 121F 385HP Ø130.2			263
880700	NL12 1997/... <span style="float: right;">DIESEL</span>	11950cc.	EDC Ø120.6			269
880800	NL12 1989/96 <span style="float: right;">DIESEL</span>	11950cc.	TD 122FS (OHV) 12V 396HP Ø130.2			271

### WILLYS

540900	Jeep, CPW Universal, Rastrojero, 4, 63, 2WD/4WD 1940/74	2199cc.	CJ2A-CJ3A - DJ3A 52HP Ø79.38	586		
--------	---	---------	------------------------------	-----	--	--

### YUE JIN

930100	1041, NJ 41029 1996/...	DIESEL 3268cc.	4BC2 - 4BD1 87/88HP Ø102			94
--------	-------------------------	----------------	--------------------------	--	--	----

- Juntas para Motor
- Retenes
- Elementos De Fijación
- Sistemas De Embrague
- Balancines Y Botadores
- Bobinas De Ignición
- Bombas De Aceite
- Pastas Sellantes
- Herramientas De Instalación
- Articulaciones Axiales
- Extremos de Dirección
- Rótulasde Suspensión
- Bieletas de Suspensión
- Barrasde Dirección
- Brazos Y Parrillas
- Bujes de Suspensión
- Mazas de Rueda
- Juntas Homocinéticas
- Cazoletas



DESCUBRI TODO  
NUESTRO CATALOGO

[www.taranto.com.ar](http://www.taranto.com.ar)

# FORMACION DE CODIGOS

## CODE FORMATION

### ANTIGUA EXPRESIÓN DE CÓDIGO TARANTO

### ANTIGUA EXPRESIÓN DE CÓDIGO TARANTO

FORMADO POR CINCO DÍGITOS

2	2	4	0	0
LINEA	MOD.	TIPO DE JUNTA		

FORMADA POR SEIS DÍGITOS

2	2	0	4	0	0
LINEA	MODELO	TIPO DE JUNTA			

NUEVA REFERENCIA



#### DOS PRIMEROS DÍGITOS

--	--

INDICA EL RUBRO O LINEA AL CUAL PERTENECE EL ARTÍCULO

#### ARTICULOS DE FABRICACION

14 AUTO UNIÓN	57 RENAULT
15 CITROËN	58 RENAULT
20 CHEVROLET - OPEL	62 DETROIT
21 CHEVROLET - BEDFORD	63 CATERPILLAR
CIMARRON - DI TELLA	65 DEUTZ
22 DODGE - CHRYSLER - VW	66 DEUTZ
23 VW - FORD	70 FIAT TRACTORES
24 CHEVROLET - GM	71 FIAT TRACTOR - CAMIÓN
25 FIAT	75 HANOMAG
26 FIAT	76 KOMATSU
27 FIAT	77 KUBOTA
28 CHEVROLET - GM	80 FIAT CAMIONES / IVECO
29 CHEVROLET - GM	81 SCANIA
30 FORD - VW	85 JOHN DEERE
31 FORD - MWM	86 HONDA - ROVER
32 FORD - MWM	87 CUMMINS
33 FORD - MWM	90 ASIA MOTORS - KIA
34 FORD	NISSAN - TOYOTA
35 MERCEDES BENZ	91 KIA - MITSUBISHI
36 MERCEDES BENZ	SUZUKI - TOYOTA
37 MERCEDES BENZ	SHANGAI
38 SMART-MERCEDES	92 TATA - NISSAN
40 PERKINS / MF. / PF	TOYOTA - MITSUBISHI
41 PERKINS / MF.	93 ISUZU - MAHINDRA
42 PERKINS / MF.	TOYOTA
AGCO / SISU	94 DAEWOO - DAIHATSU
43 MAXION	95 DAIHATSU - BMW
44 MWM	MITSUBISHI - TOYOTA
45 PEUGEOT - INDENOR	SUBARU - DATSUN
46 PEUGEOT	96 MITSUBISHI
47 PEUGEOT	97 TOYOTA - MAZDA - LADA
50 RASTROJERO - INDENOR	98 BMW
VM - BORGWARD	99 HYUNDAI - CHERY
51 CHRYSLER	
52 CHRYSLER	
54 IKA - RENAULT - WILLYS	
55 RENAULT	
56 RENAULT - DACIA	

#### TERCER Y CUARTO DÍGITO

--	--

ESPECIFICA E INDICA EL TIPO DE MODELO AL QUE PERTENECE

#### ARTICULOS DE FABRICACION

EJEMPLOS

CITROËN	PERKINS
00 2CV 14HP	00 4-203
01 2CV 18HP	01 6-305
02 3CV	02 6-354 F2
04 AMI 8	03 6PF-305
	04 6-354 F4
	05 P3-152
	06 PF-MF
	07 MF M165-265
	08 MF 1095-1098
	09 6-354 F1
	10 GM D20 3.9
FIAT	PEUGEOT
00 1100	00 404
01 600	01 504 1.6
02 1500	02 504 1.8
03 1600	03 504 2.0
04 128 1100cc.	04 504 XD2
05 128 1300cc.	05 505
06 128 1500cc.	06 505 I
07 125	07 505 XD3
08 133	09 403
09 REGATTA 100S	15 205 1.0
11 DUCATO 2.8	16 106 1.4
20 BRAVO/A TD	17 106 1.2
21 BRAVO/A JTD	18 104 1.2
FORD	RASTROJERO
00 FALCON 7B	00 42 HP
01 FALCON SP	01 52 HP
02 V8 FASE 1	02 INDENOR 4,88
03 TAUNUS 2.0	03 INDENOR 6 CIL
04 TAUNUS 2.3	04 VM/BORGWARD
05 V8 FASE 2	
06 SIERRA 1.6	
08 A/AA	
09 FALCON 4B	
14 ESCORT 1.6	
20 TRANSIT 2.5	
21 FIESTA 1.4	

#### QUINTO Y SEXTO DÍGITO

--	--

DETERMINA EL TIPO DE JUNTA

#### ARTICULOS DE FABRICACION

00 JGO. JUNTA MOTOR
01 JGO. MOTOR SIN TAPA CILINDROS
05 JTA. TAPA CILINDRO
06 JTA. TAPA CILINDRO SUPERMEDIDA
07 JTA. TAPA CILINDRO
08 JTA. TAPA CILINDRO
10 JTA. TAPA DE VÁLVULAS
11 JTA. CÁRTER
12 JTA. DISTRIBUCIÓN
13 JTA. CONTRATAPA DISTRIBUCIÓN
14 JTA. BOMBA DE AGUA
15 JTA. MÚLTIPLE ESCAPE
16 JTA. MÚLTIPLE ESCAPE
17 JTA. MÚLTIPLE ADMISIÓN
18 JTA. SALIDA DE ESCAPE
19 JTA. PLACA DE AGUA
20 JGO. JUNTA CARBURADOR
21 JGO. JUNTA CARBURADOR
22 JGO. JUNTA CARBURADOR
23 JGO. JUNTA CARBURADOR
24 JGO. JUNTA CARBURADOR
25 JTA. BASE CARBURADOR
26 JTA. TAPA CARBURADOR
27 JTA. BOMBA ACEITE A BLOCK
28 JTA. BOMBA DE NAFTA
29 ARANDELA TAPÓN CÁRTER
30 ARANDELA TAPA DE VÁLVULAS
36 JTA. TAPA VÁLVULAS LATERAL
50 JGO. CAJA DE VELOCIDADES
57 JUNTA PALIER
58 JGO. BANCADA CIGÜEÑAL
59 JTA. DIFERENCIAL
60 JTA CÁRTER CGT
70 JGO. SUPLEMENTO CAMISAS
85 SUPLEMENTO DE TAPA
95 JGO. DE JUNTAS SUPERIOR
97 JGO. DE JUNTAS SUPERIOR JTC 07
96 JGO. SUPERIOR SIN JTC

### FORMACIÓN DE CÓDIGOS DE RETENES

#### SEGUNDO Y TERCER DÍGITO

INDICA LA MARCA O LINEA DEL ARTÍCULO

#### CUARTO Y QUINTO DÍGITO

INDICA EL TIPO DE MOTOR

#### SEXTO Y SÉPTIMO DÍGITO

INDICA TIPO DE RETÉN SEGÚN SU APLICACIÓN

#### OCTAVO DÍGITO

INDICA MATERIAL

PRIMER DÍGITO

**R**

INDICA LINEA DE RETENES

**PR**

INDICA LINEA DE PORTA RETENES

14 AUTO UNION	35 MERC. BENZ
15 CITROEN	36 MERC. BENZ
20 CHEVROLET	40 PERKINS - MF
21 CHEVROLET	41 PERKINS - MF
22 DODGE - VW	42 PERKINS
23 VW - FORD	45 PEUGEOT
24 CHEVROLET	INDENOR
25 FIAT	46 PEUGEOT
26 FIAT	50 RASTROJERO
27 FIAT	INDENOR
28 CHEVROLET	54 IKA - RENAULT
30 FORD - VW	JEEP WILLYS
31 FORD - MWM	55 RENAULT
32 FORD	58 RENAULT

EJEMPLOS

CITROËN	FIAT
00 2CV 14HP	05 128 1300cc.
01 2CV 18HP	06 128 1500cc.
02 3CV	07 125
04 AMI 8	08 133
	09 REGATTA 100S
	11 DUCATO 2.8
	20 BRAVO/A TD
	21 BRAVO/A JTD
FIAT	
00 1100	
01 600	
02 1500	
03 1600	
04 128 1100cc.	

00 KIT DE RETENES	56 RUEDA TRAS. INT.
10 GUÍAS DE VÁLVULAS	57 DE PIÑÓN
11 BANCADA	58 RUEDA DEL. EXT.
12 DISTRIBUCIÓN	59 RUEDA DEL. INT.
13 ÁRBOL DE LEVAS	60 SEMI-EJE
15 RET. ADICIONAL	
47 VELOCÍMETRO	
48 SELECTOR CAJA DE VELOCIDAD	
49 EJE CAMBIO	
50 SALIDA DA CAJA	
51 DE DIRECTA	
52 SALIDA DE PALIER	
55 RUEDA TRAS. EXT.	

<b>N - NITRIL</b>
CAUCHO NITRILICO
<b>S - SILICONA</b>
CAUCHO DE SILICONA
<b>P - POLIACRÍLICO</b>
CAUCHO DE POLIACRÍLICO
<b>V - VITÓN</b>
CAUCHO FLUORADO
<b>VF - VIFLON</b>
<b>T - TEFLÓN</b>
POLITETRA FLUOR ETILENO

# SIMBOLOS - MATERIALES

## SYMBOLS - MATERIALS

### SIMBOLOS - SYMBOLS

Descripción de Producto Product description	Simbolos Symbols	Descripción de Producto Product description	Simbolos Symbols	Descripción de Producto Product description	Simbolos Symbols
Jgo. de juntas para motor con retenes Full set gaskets with oil seals		Jgo. tornillos para tapa de cilindros Cylinder head bolts		Suplemento camisa cilindro Camma cylinder gaskets	
Jgo. de juntas para motor sin retenes Head set gaskets without seals		Herramientas especiales para motor Set of special automotive tools		Kit retenes completo Oil Seals (Set)	
Jgo. juntas p/motor sin tapa con retenes Full set gaskets without head with oil seals		Junta tapa de válvulas Valve gaskets		Jgo. retén válvulas Valve seal set	
Jgo. juntas p/motor sin tapa sin retenes Full set gaskets without head without oil seals		Junta para cárter Rear main bearing seals gaskets		Retén bancada Rear cranksht seal	
Jgo. de juntas superior con retenes Head set gaskets with oil seals		Junta tapa distribución Timing cover gaskets		Retén distribución Front cranksht seal	
Jgo. de juntas superior sin retenes Head set gaskets without seals		Junta bomba de agua Water pump and water exit gaskets		Retén árbol de levas Camshaft seal	
Junta tapa cilindro Cylinder head gaskets		Junta múltiple admisión y escape Intake and exhaust manifolds gaskets		Porta retén bancada Rear cranksht seal	
Junta tapa cilindro - No retorqueable Cylinder head gaskets - Non retorqueable		Junta múltiple admisión Intake manifolds gaskets		Porta retén distribución Front cranksht seal	
Junta tapa cilindro izquierda Left Cylinder head gaskets		Junta múltiple escape Exhaust manifolds gaskets		Espesor Thickness	
Junta tapa cilindro derecha Right Cylinder head gaskets		Junta salida escape Exhaust pipe seals gaskets			

### ABREVIATURAS MATERIALES - ABBREVIATION OF MATERIALS

	Descripcion Description		Descripcion Description		Descripcion Description
AC	Acero Inoxidable Stainless Steel	CEL	Celulosa Cellulose	NH	Libre Amianto Comprimido Compressed Asbestos Free
ACO	Acero Cobreado - Libre Amianto - Acero Cobreado Steel Copper - Asbestos Free - Steel Copper	F	Fibra Fiber	MLS	Multilamina Sterling Multisheet Sterling
AL	Aluminio Aluminium	FCH	Ferreflex con respaldo de chapa Ferreflex with tin shoulder	P	Poliacrilico - Retenes con casco de acero Polyacrylic - Oil Seals with steel cap
BAK	Bakelita - Nonasbesto/Bakelita Bakelite - Nonasbesto/Bakelite	FIE	Fieltro Felt	PB	Plomo Lead
CB	Base Celulosa Cellulose Base	GFT	Grafito con alma metálica Graphite with metallic core	PLAST	Plástico Plastic
CG	Corcho y Goma Cork and Rubber	GS	Goma sintética - Nitrilo Synthetic Rubber - Nitrile	S	Silicona - Retenes con casco de acero Silicone - Oil Seals with steel cap
CGT	Corcho y Goma con Tela Cork and Rubber with Cloth	H	Hojalata Tin Plate	SLS	Sterling - Polystrat Sterling - Polystrat
CHA	Chapa/Hojalata sin material blando Tin Plate without soft material	L	Latón - Bronce Brass	SNA	Soga libre de amianto Rope asbestos free
CN	Arandelas blindadas (Cobre - Libre Amianto) Armored washers (Copper - Asbestos Free)	N	Retenes de nítrico con casco de acero Nitrile oil seals with steel cap	T	Teflón Teflon
CNC	Cobre - Libre Amianto - Cobre Copper - Asbestos Free - Copper	NB	Libre Amianto (Beater) Asbestos Free (Beater)	V	Vitón - Retenes con casco de acero Viton - Oil Seals with steel cap
CU	Cobre Copper	NFT	Ferreflex Base Libre Amianto Ferreflex Base Asbestos Free	VS	Varios Miscellaneous

Los números originales también indicados en este catálogo tienen relación únicamente en sentido de informar y verificar. Sírvase usar en sus pedidos, facturas recibos solamente los códigos TARANTO.

Os números originais indicados neste catálogo servem somente para informação e verificação. Utilizar nos pedidos, faturas e recibos somente os códigos TARANTO.

Original part numbers also indicated in this catalog are intended only to inform and verify. Please, indicate only TARANTO reference numbers in your order forms, invoices and shipping notes.

# ARANDELAS - ANILLOS - O´RINGS

## WASHERS - RINGS - O´RINGS

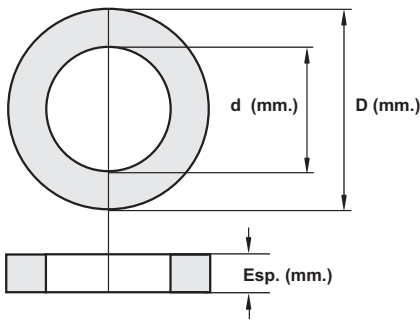

<b>d</b>	Diámetro interior d (mm)	Diâmetro interno d (mm)	Inner diameter d (mm)
<b>D</b>	Diámetro exterior D (mm)	Diâmetro externo D (mm)	Outer diameter D (mm)
<b>Esp.</b>	Espesor Esp.(mm)	Espessura Esp.(mm)	Thickness Esp.(mm)

### FORMACIÓN DE CÓDIGOS DE ARANDELAS

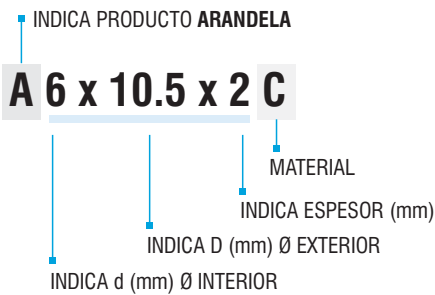

### MATERIALES

<b>AL</b>	ALUMINIO	ALUMÍNIO	ALUMINUM
<b>NH</b>	LIBRE AMIANTO COMPRIMIDO	SEM AMIANTO COMPRIMIDO	ASBESTOS FREE COMPRESSED
<b>C</b>	COBRE	COBRE	COPPER
<b>F</b>	FIBRA	FIBRA	FIBEIRON
<b>H</b>	FERRO	HIERRO	FELT
<b>F</b>	FELTRO	FIELTRO	NYLON
<b>N</b>	NYLON	NYLON	

### ARANDELAS POR DIÁMETRO INTERIOR

MATERIAL							MATERIAL							MATERIAL							MATERIAL														
d (mm)	D (mm)	Esp	AL	NH	C	F	H	L	d (mm)	D (mm)	Esp	AL	NH	C	F	H	L	d (mm)	D (mm)	Esp	AL	NH	C	F	H	L	d (mm)	D (mm)	Esp	AL	NH	C	F	H	L
4	7	1					●		7	17	1.5					●		10	13	1	●						12	17	1.5				●		
4	8	1	●						7	17	1					●		10	14	1.25	●						12	17	2				●		
5	8	1	●		●	●			8.3	11.6	1				●			10	14	1.5	●						12	18	1.5	●		●			
6.5	12	0.5				●			8.5	11.5	1					●			10	14	1			●	●			12	18	1			●		
6.8	13.5	1	●						8.5	12	1				●				10	15	1.5	●						12	18	2			●		
6	10.5	2			●				8	10	1	●							10	15	1			●				12	18	3	●		●		
6	10	1.5		●					8	11	1	●				●			10	16	0.5				●			13	16	0.5	●				
6	10	1	●		●	●			8	12	1	●		●	●				10	16	1	●		●	●			13	16	2			●		
6	10	2						●	8	12	1						●		10	16	2.5			●				13	17	1			●		
6	11	2			●				8	13	1	●		●					10	18	1			●				13	17	2	●				
6	8	0.5				●			8	13	2.5			●					10	18	2	●						13	18	1.5			●		
6	8	1	●		●				8	14	0.5			●					10	19	2			●				13	19	1				●	
6	9	0.5	●			●			8	14	1.5		●	●					10	20	1.5	●						13	20	1	●		●		
6	9	1	●		●	●			8	14	1	●		●					10	20	1			●				13	20	2	●				
6.5	10	1			●				8	18	1.5	●			●				10	20	2			●				13	21	1.5			●		
6.5	12	1			●				8	20	1.5	●							10	21	2			●				13	24	3				●	
7.5	15	2			●				9.4	18	1				●				11	15	1				●			14.5	21	2			●		
7	8.9	1.9					●		9.5	12	1.5	●							11	16	1	●			●			14	17.2	2			●		
7	10	1	●		●	●			9.5	12	1	●							11	17	1.25			●				14	18	1.25	●				
7	11	1			●	●			9.5	14.5	1					●			11	18	1.5	●		●				14	18	1.5			●		
7	12.5	1			●				9.5	20	1			●					11	18	2			●				14	18	1	●		●		
7	12.5	2			●				9.5	20	2			●					12.7	16	1	●						14	18	1.25			●		
7	13	1.5	●						9.7	13	1				●				12.8	22.8	2					●		14	19	1.5			●		
7	13	1			●				9	11	0.8	●							12	14	0.5	●						14	20	1.25	●				
7	13	4				●			9	13	0.5			●					12	15	1.5			●				14	20	1.5	●		●		
7	14	1					●		9	13	1	●							12	15.2	1			●				14	20	1			●		
7	15	1				●			9	13	1			●	●				12	16	1.5	●		●				14	20	2			●		
7	15	1.5			●				9	14	1			●					12	16	1	●		●	●			14	21	1.5			●		
7	15	2			●				9	17	1.5			●					12	17	1	●		●				14	22	1.5			●		



# ARANDELAS - ANILLOS - O´RINGS

## WASHERS - RINGS - O´RINGS

MATERIAL								MATERIAL								MATERIAL								MATERIAL											
d (mm)	D (mm)	Esp	AL	NH	C	F	H	L	d (mm)	D (mm)	Esp	AL	NH	C	F	H	L	d (mm)	D (mm)	Esp	AL	NH	C	F	H	L	d (mm)	D (mm)	Esp	AL	NH	C	F	H	L
14	22	2			●				16	24	1			●				20	26	0.5			●				24	38	1.25	●					
14	24	1.5	●						16	24	1.5	●						20	26	1.5			●				25	29.5	1			●			
14	24	2			●				17	21	0.5			●				20	26	1	●		●				25	29	2			●			
14.7	21	2			●				17	21	1.25			●				20	26	2				●			26	31	2			●			
15.5	17	1.5			●				17	21	1.5			●				20	28	1	●		●				26	32	1.25	●					
15	18	1	●						17	22	1.25	●						21	30	2	●						26	32	2	●					
15	19	1.5	●						17	22	1.5			●				22.5	29	2	●		●				26	34	2	●					
15	20	1			●				17	22	1	●			●			22	26	1.5			●				27	32	1.5			●			
15	21	1.5	●						18	22	1.5	●			●			22	27	1	●						28	34	1.5	●					
15	21	1.5			●				18	22	2			●				22	27	1.25	●						28	36	0.5	●					
15	21	2	●		●				18	23	1.25	●		●				22	27	1.5			●				28	38	1.5			●			
16	19	1.5			●				18	23	1	●		●				22	27	1			●				30	36	2	●		●			
16	20	1	●			●			18	23	2			●				22	28	1.25	●						31	36	1.5	●					
16	20	1.5			●				18	24	1			●				22	28	1.5			●				32	36	0.5			●			
16	21	1.25	●						18	24	1.5			●				22	29	1.5	●						32	36	1			●			
16	21	1.5			●				19	24	1.5	●						22	29	3	●						35	41	2			●			
16	21	1	●						19	26	1.5			●				22	32	1.5			●				36	42	1.5	●					
16	21	2			●				19	27	2	●						24	29	2			●				40	47	1			●			
16	22	1.5	●		●				19.5	27	1	●						24	30	1.5	●						40	60	1.5			●			
16	22	1			●	●			20.5	5.5	1	●						24	32	1.5	●						45	52	2	●					
16	22	2			●				20	24	1.5	●		●				24	32	2	●														

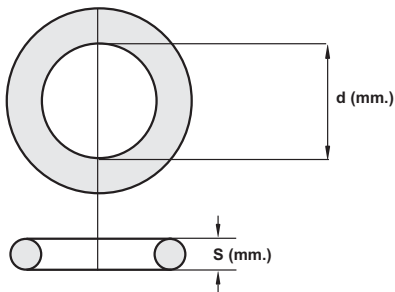

**d** Diámetro interior d (mm)      Diâmetro interno d (mm)      Inner diameter d (mm)  
**S** Sección S (mm)      Seção S (mm)      Section S (mm)

### FORMACIÓN DE CÓDIGOS DE ARANDELAS

INDICA PRODUCTO O´RING

**G 18.77 x 1.78 S**

MATERIAL

INDICA S (mm) SECCION

INDICA d (mm) Ø INTERIOR

### MATERIALES

<b>N</b>	<b>NITRILICO</b>	NITRILICA	NITRILE
<b>S</b>	<b>SILICONA</b>	SILICONE	SILICONE
<b>V</b>	<b>VITÓN</b>	FLUOR ELASTOMERO	FLUORELASTOMERS

### O´RING - SERIE STANDARD

**1.78**  
S (mm)

**2.62**  
S (mm)

MATERIAL				MATERIAL				MATERIAL				MATERIAL				MATERIAL				MATERIAL			
d (mm)	N	S	V	d (mm)	N	S	V	d (mm)	N	S	V	d (mm)	N	S	V	d (mm)	N	S	V	d (mm)	N	S	V
1.42	●			4.47	●			12.42	●			23.52	●			50.52	●			66.4	●		
1.78	●			5.28	●			15.6	●		●	28.3	●			53.7	●			69.57	●		
2.57	●			6.07	●			17.17	●			34.65	●			56.87	●		●	101.32	●		
2.9	●			7.65	●			18.77	●	●		44.17	●			60.05	●						
3.68	●			9.25				21.95	●			47.35	●			63.22	●						
7.59	●			13.11	●			17.12	●			23.47	●			30	●			37.77	●		
9.19	●			13.94	●			18.72	●			26.64	●			31.42	●			39.34	●		
9.5	●			15.54	●			20.30	●			28.24	●			32.99	●			40.94	●		
12.37	●			17.12	●	●		21.89	●			29.82	●			36.17	●	●		34.59	●		

# ARANDELAS - ANILLOS - O RINGS

## WASHERS - RINGS - O RINGS

### O RING - SERIE STANDARD

	MATERIAL				MATERIAL				MATERIAL				MATERIAL				MATERIAL							
	d (mm)	N	S	V	d (mm)	N	S	V	d (mm)	N	S	V	d (mm)	N	S	V	d (mm)	N	S	V				
<b>2.62</b> S (mm)	44.12	●			53.64	●			58.42	●			66.34	●			72.69	●			90	●		
	48.9	●			55.25	●			61.60	●			67.95	●			82.22	●			126.67	●		
	52.07	●			56.82	●			64.77	●			69.52	●			88.57	●			158.42	●		
<b>3.53</b> S (mm)	4.34	●			21.82	●			31.34	●			40.87	●			50.39	●			98.02	●		
	12.29	●			23.39	●			32.92	●			44.04	●			63.09	●			107.54	●		
	13.87	●			26.57	●			36.09	●			45.36	●			66.27	●			110.72	●		
	18.64	●			27.5	●			37.69	●			47.22	●	●		72.62	●			129.77	●		
<b>5.33</b>	37.47	●			46.99	●	●		88.27	●			94.62	●										
	40.64	●			62.87	●			91.44	●			253.37	●										

### O RING - SERIE NO STANDARD

d (mm)		S (mm)		MAT.		d (mm)		S (mm)		MAT.		d (mm)		S (mm)		MAT.		d (mm)		S (mm)		MAT.		d (mm)		S (mm)		MAT.	
N	S	N	S	N	S	N	S	N	S	N	S	N	S	N	S	N	S	N	S	N	S	N	S	N	S	N	S	N	S
2.7	1.2	●		12	3		●	20	4	●		30.5	3.5	●		42	4	●		58	2	●		85	3	●			
4	1	●		12.5	1.5	●		21	1.5	●		31.55	3.72		●	42.2	3	●		60	4	●		85.5	3.35	●			
4	1.5	●		13.1	1.3	●		21	3	●		31.5	3.2	●		43	4		●	60	5	●		90	3	●			
4.47	1.42	●		13.5	3	●		22.1	3.6	●		32	3	●		44	2	●		61.8	3	●		91	1.8	●			
4.5	1	●		14	2	●		22.2	3.5	●		33.5	4.2	●		44	3	●		62	3.5	●		94	3	●			
5.98	1.99	●		14	2.5		●	22.5	2.5	●		34	3	●	●	45	2.5	●		63	3	●		101	4	●			
6	2	●		14	3	●	●	22.5	3	●		34.2	2.5	●		45	3	●		63.5	3		●	102.5	94.5	●			
6.07	1.63	●		16	2	●		23	3	●		35	3.5	●		45	4	●		64	3	●		110	3	●			
7	4.5	●		16	2.5	●		25	4	●		35	4		●	46	3	●		65	2.35		●	110	4.5	●			
7.3	2.4	●		16	4		●	26.2	3	●		36	3	●		46.2	1.9	●		70	3	●		112	4	●			
8	1.5	●		16.5	3		●	28	2	●		36.5	3.2	●		46.3	3	●		74	3	●		114.5	5	●			
8	2.4	●		17	2.2	●		28	4		●	37	3	●		47	4	●		74	3.35	●		115	2		●		
9	2	●		17.5	6	●		28.12	3.5	●		37.47	3	●		47.3	2	●		75	3	●		119	3	●			
9.7	4	●		18	3	●		28.2	2.5	●		38	3	●		48	4	●		76	2.5	●		122	5	●			
10	2.5	●		19.18	2.46	●		28.2	5	●		39	3	●	●	50	4	●		79	1.8	●	●	152	6	●			
10	2.5		●	19.25	2.9	●		29.2	3	●		40	3	●		53.5	3	●		79.5	3		●	168	3.5	●			
11	2.5		●	20	2	●		30	3.5	●		40	5	●		55	2	●		80	3	●		212.15	3	●			
12	2.5	●		20	2.5	●		30.2	3	●		42	3	●		56.4	2	●		82	3.5	●		320	8	●			

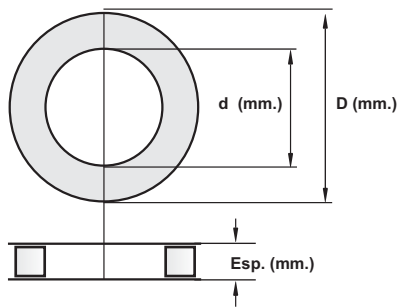

<b>d</b>	Diámetro interior d (mm)	Diámetro interno d (mm)	Inner diameter d (mm)
<b>D</b>	Diámetro exterior D (mm)	Diámetro externo D (mm)	Outer diameter D (mm)
<b>S</b>	Sección S (mm)	Corte S (mm)	Section S (mm)

### ANILLOS

d (mm)	S (mm)	D (mm)	Mat.	d (mm)	S (mm)	D (mm)	Mat.	d (mm)	S (mm)	D (mm)	Mat.	d (mm)	S (mm)	D (mm)	Mat.	d (mm)	S (mm)	D (mm)	Mat.	d (mm)	S (mm)	D (mm)	Mat.
6	3	3	N	10	6	1	N	15	11	3	N	33	22	8	N	46	34	2	N	73	65	5	N
8	4	1	N	15	6	1	N	14,5	11,5	4	N	30	24	3,9	N	46,5	38,5	4	N	82	73	9,7	N
13,8	5	7,8	N	13,8	6,4	8	N	30	15,5	12	N	21	35	13	N	56,5	66,5	6	N	91	82,2	4,7	N
9	5	9,5	N	7,2	11	6	N	24	17	9	N	47,5	41,5	7	N	57	42	3	N	104,2	95	3	N



# taranto

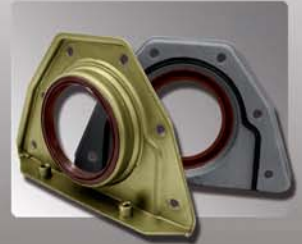

## Retenes Taranto. Un sello de garantía

El permanente desafío que presenta la evolución de los motores de combustión actuales para asegurar el sellado de sus componentes requiere del desarrollo y aplicación de tecnología moderna y eficiente en la fabricación de los retenes. La constante actividad de nuestro Departamento de Ingeniería, aplicada al desarrollo e investigación de nuevos materiales y componentes para lograr la mejor performance de nuestros productos, acompañada de la realización de ensayos de vida y exigentes pruebas específicas que garantizan el perfecto desempeño en los distintos medios funcionales y la utilización de modernas técnicas de diseño aplicada a la construcción de nuevos labios y perfiles hidrodinámicos, permite ofrecer al mercado productos que superan las necesidades de estanqueidad del motor.



### 1 - NUEVOS PERFILES

Facilita el montaje y asegura el agarre.

### 2 - POSICION PREFERENCIAL DEL LABIO

Permite trabajar el labio en posiciones no utilizadas del eje.

### 3 - MODERNOS DISEÑOS

Permite trabajar el labio en una parte del eje no utilizable hasta el momento.

1

3

2







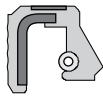
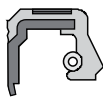
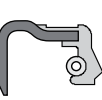
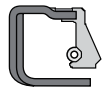

# RETENES - MATERIALES

## OIL SEALS - MATERIALS

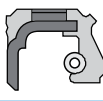
MATERIALES MATERIAIS - MATERIALS	ASTM D1418	ISO 1629	TARANTO	TEMPERATURA Temperature
<b>SILICONA</b> Material para aplicaciones de baja y alta temperatura, muy usado en motores de elevada exigencia y en transmisiones automáticas. No recomendada para aceites EP (Extrema Presión). <b>SILICONE</b> Material para aplicação em baixas e altas temperaturas, muito usado em motores de elevada exigência. Não é recomendada para óleos EP (Extrema Pressão). <b>SILICONE</b> Material for low and high temperature applications, highly recommended for engines and automatic transmission. It should not be used for EP oils (Extreme Pressure).	VMQ	MVQ	S	-50° Ca + 180°C
<b>NITRÍLO</b> Es el material más comúnmente utilizado en sellado para aplicaciones generales. Buena resistencia a la abrasión y a la acción de aceites y grasas minerales. <b>NITRILICA</b> É o material mais comumente utilizado em vedação para aplicações gerais. Tem boa resistência ao atrito e a ação de óleos e graxas minerais. <b>NITRILE</b> It is the most commonly used sealing material for general applications. Good resistance to abrasion and to mineral oils and greases.	NBR	NBR	N	-35° Ca + 110°C
<b>POLIACRÍLICO</b> Recomendado para aplicaciones en motor y especialmente en transmisión con aceites EP. Deformación permanente más elevada. <b>POLIACRÍLICO</b> Recomendado para aplicações em motores e especialmente em transmissões com óleo EP. Deformação permanente mais elevada. <b>ACRYLIC (POLYACRYLATE)</b> Highly recommended for engines and especially in transmission with EP oils. Higher permanent set.	ACM	ACM	P	-30° Ca + 150°C
<b>FLUORELASTOMERO</b> Compuesto para altas exigencias con mejor resistencia a altas temperaturas y ataques químicos. Ofrece duración en servicio muy superior, pero a costo más elevado. <b>FLUORELASTÓMERO</b> Composto para altas exigências com melhor resistência a altas temperaturas e ataques químicos. Oferece duração em serviço muito superior, porém a um custo mais elevado. <b>FLUORELASTOMERS</b> Compound for high demands with better resistance to high temperatures and chemical aggressions. It grants a better duration in service but at higher costs.	FKM	FKM	V	-30° Ca + 200°C
<b>POLITETRAFLUORETILENO</b> Usos de elevada temperatura, gran ataque químico y severas condiciones de fricción. <b>POLITETRAFLUORETILENO</b> Utilizado em ambientes com altas temperaturas e elevado ataque químico, e em condições severas de atrito. <b>POLYTETRAFLUORETHYLENE</b> High temperature uses, great chemical attack and severe friction conditions.	PTFE	PTFE	T	-80° Ca + 250°C
<b>FLUORELASTOMERO / POLITETRAFLUORETILEO</b> Compuesto especial desarrollado por Taranto (Viflón®) para altas exigencias de temperatura, ataque químico e importantes condiciones de fricción. Es la elección ideal entre el tipo V y el tipo T. <b>FLUOROELASTOMER / POLITETRAFLUORETILENO</b> Composto especial desenvolvido pela Taranto (Viflón®) para os requisitos de alta temperatura, gravura e importantes condições por atrito. É a escolha ideal entre o tipo V e T-type <b>FLUOROELASTOMER / POLYTETRAFLUOROETHYLENE</b> Special compound developed by Taranto (Viflón®) or high temperature requirements, chemical attack and important conditions of friction. Is the ideal choice between the V type and T-type	FKM PTFE	FKM PTFE	VF	-30° Ca + 200°C

### DESCRIPCIÓN - TIPO DE RETENES RADIALES

DESCRIÇÃO - TIPO DE RETENES RADIALES | TYPES OIL SEAL - DESCRIPTION

<b>GA</b>	<b>Goma armada</b> Exterior borracha Rubber case	<b>G1A</b>	<b>Exterior goma metal</b> Exterior metal borracha Outer rubber metal	<b>G1</b>	<b>Exterior metal</b> Exterior metlico Outer metal			
<b>G2</b>	<b>Blindado</b> Blindado Armoured	<b>RI</b>	<b>Roscado izquierdo</b> Rosca esquerda Left threaded	<b>RD</b>	<b>Roscado derecho</b> Rosca direita Right threaded			
<b>SR</b>	<b>Sin resorte</b> Sem mola Without sprint	<b>LG</b>	<b>Labio guardapolvo</b> Lábio guarda-pó Dust lip	<b>HD</b>	<b>Hélice derecha</b> Hélice direita Right helix			
<b>HI</b>	<b>Hélice izquierda</b> Hélice esquerda Left helix	<b>ESP</b>	<b>Especial</b> Especial Special	<b>BI</b>	<b>Bidireccional</b> Bidireccional Bi-directional			

# RETENES RADIALES

## OIL SEALS

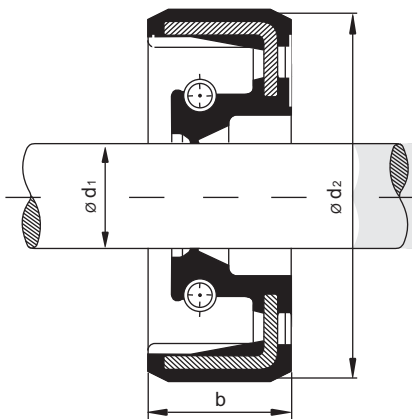

- Diámetro de Eje (d1)
- Altura (b)
- Alojamiento (d2)

- Diâmetro do eixo (d1)
- Altura (b)
- Alojamento (d2)

- Shaft diameter (d1)
- Height housing (b)
- Housing Bore (d2)

### RETENES POR Ø DE EJE - RETENTORES POR DIÂMETRO DO EIXO - DIAMETER HOLDERS OIL SEAL

REF	DE [mm]	DA [mm]	H [mm]	TIPO Type	MATERIAL					
					N	S	P	V	T	VF
R300347	7.90	16.00	6	GA	●					
R550614	8.10	14.30	4.2	U'RING				●		
R550447	8.40	16.00	6.5	GA	●					
R460215	9.50	16.00	4	GALGSR	●					
R550515	12.70	25.40	6.5	GAHI			●			
R223543	13.00	21.90	5/6.5	ESP-GADUO						●
R240048	13.00	26.00	7	GALG	●					
R550051	13.00	26.00	9	GALG	●					
R250148	14.00	24.00	7	ESP	●					
R550451	15.00	26.00	7	GALG	●					
R300748	15.50	28.00	6/15	ESP	●					
R300048	15.70	23.81	4.76	GASR	●					
R550648	16.00	22.80	4.8	GA	●					
R250448	16.00	24.60	9/20	ESP	●					
R450348	17.00	23.00	7	ESP	●					
R300749	17.00	28.00	7/10	GALGHD	●					
R550450	17.00	28.00	7/13	GAHD	●					
R280215	17.50	32.00	6	GALGHD	●		●	●		
R220649	20.00	35.00	7/10.5	GAHD			●			
R240949	21.00	32.00	7.5	G1LGHD	●					
R300751	21.50	40.00	7	GAHD			●			
R250652	22.00	35.00	8	GALG	●					
R250451	22.00	40.00	7/8.5	G2LGHD	●					
R560114	22.00	45.00	7	GALGHI			●	●		
R220349	22.10	40.00	12/17	GALGHD	●					
R400213	22.22	34.92	6.35	GA	●					
R400215	22.22	35.70	9.52	ESP-RD	●					
R260251	22.80	40.00	7/8.5	G2LGHD			●			
R250457	23.00	37.00	13.5	ESP			●			
R550550	24.00	36.00	8/12	GAHD	●					
R250156	25.00	35.00	7	GA	●					
R280415	25.00	40.00	8	GALG-BI	●					
R560113	25.00	42.00	7	GALGHD			●	●		

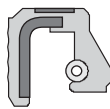

GA



GALG



G1A



G1ALG



G1



G1LG

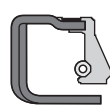

G2



G2LG



G1SRLG



GALGR/D



c/f Con Feltro  
Con feltro/With Felt

REF	DE [mm]	DA [mm]	H [mm]	TIPO Type	MATERIAL					
					N	S	P	V	T	VF
R240415	26.00	42.00	8	G1ALGHD			●	●		
R550660	26.00	42.00	8/17	EGALG	●					
R350315	26.00	45.00	10	G1	●					
R902115	26.00	49.00	9.5/11	ESP			●			
R270515	27.00	37.00	7	G1ALGHD				●		
R860012	27.00	39.50	7	GALGHD			●			
R231313	27.00	42.00	8	G1ALGHD				●		
R470813	27.00	47.00	7	GALGHD					●	
R550951	27.95	56.00	10	GALGHD			●			
R570351	27.95	70.00	10	GALGHD			●			
R320013	28.00	38.00	7	GALGHD			●	●		
R300351	28.00	40.00	8	GALGHD	●					
R570913	28.00	42.00	5	GALGHD					●	
R222313	28.00	42.00	7	GALGHI					●	
R450557	28.00	45.00	8	GAHD			●			
R580013	28.00	47.00	5.5	GALGHD					●	
R250151	28.00	47.00	8	GAHD	●					
R510012	28.50	41.25	6	GALGHD			●			
R300051	28.58	41.20	6.2	G1HD	●					
R250660-1	29.80	50.00	10/13.5	G1ALGHD			●			
R250660	29.80	52.00	10/13.5	G1ALGHI			●			
R200849	29.90	45.00	7	G1HD			●			
R460760	29.90	47.00	11.3	GALGRD c/f			●			
R550615	30.00	40.00	7	GAHD	●		●	●		
R860013	30.00	40.00	7	GA-B		●	●			
R260113	30.00	42.00	7	GALGHD			●	●		
R550413	30.00	42.00	8	GAHI	●		●			
R150012	30.00	42.04	8	GALGHD	●					
R260112	30.00	43.00	8	G1ALGHD			●	●		
R900913	30.00	44.00	7	GALGHD			●			
R270614	30.00	44.00	8	GALGHI					●	
R240713	30.00	45.00	8	GALGHD	●		●			
R250255	30.00	45.00	8	GA	●					

# RETENES RADIALES

## OIL SEALS

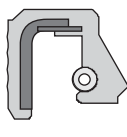
### RETENES POR Ø DE EJE - RETENTORES POR DIÂMETRO DO EIXO - DIAMETER HOLDERS OIL SEAL

REF		DE [mm]	DA [mm]	H [mm]	TIPO Type	MATERIAL							REF		DE [mm]	DA [mm]	H [mm]	TIPO Type	MATERIAL										
						N	S	P	V	T	VF								N	S	P	V	T	VF					
R950512		30.00	46.00	8	GALGHD	●	●						R250158		35.00	52.00	8.8	G1	●										
R570614		30.00	47.00	6	GAHI			●					R240960		35.00	54.00	10/15	G1ALG-BI	●										
R260914		30.00	47.00	7	G1ALGHD			●	●				R810012		35.00	62.00	7	GALG-BI	●										
R340312		30.00	50.00	7.5	GALGRD				●				R926612		36.00	48.00	6					●							
R250413		30.00	52.00	7	GALGRD			●					R920012		36.00	49.00	7	GALGD			●								
R260313		30.00	52.00	7	G1ALGHD	●		●	●				R460213		36.00	50.00	8	GALGHD			●	●							
R252012		31.00	41.00	7	G1ALGHD				●				R550055		36.00	54.00	7	G1	●										
R270615		31.00	41.00	7	GALGHD					●			R550460		36.00	54.00	8/11	E-GALG c/f	●										
R240012		31.00	50.00	8	GALGHD			●	●				R250257		36.00	68.00	10/13	GAHD	●										
R272213		31.00	55.00	7	G1ALGHD					●			R310812		36.51	52.48	8	GALGHD			●								
R200051		31.68	44.45	6.35	G1HD	●							R230513		37.00	47.00	10	GALGHD					●						
R230512		32.00	42.00	7	G1ALGHD			●	●				R520912		37.00	50.00	6	GALGHD			●								
R570512		32.00	44.00	6	GALGHD					●			R302212		37.00	50.00	8	GALGHD					●						
R981312		32.00	45.00	6				●					R230413		38.00	48.00	8	GALGHD	●										
R230412		32.00	45.00	6.5	GALGRD			●					R452113		38.00	50.00	6	GALGHD						●					
R910613		32.00	46.00	6	GALGHD			●					R242513		38.00	50.00	8	-						●					
R282513		32.00	47.00	7				●					R290912		38.00	50.00	8	G1ALGHD						●					
R220412		32.00	47.00	10	GALGHD			●	●				R320913		38.00	52.00	6	GALGHD						●					
R230113		32.00	47.00	10	GALG-BI			●	●				R250155		38.00	52.00	10	G1	●										
R230513		32.0	47.00	10	GALGHD					●			R200859		38.00	52.00	8.5/2.5	ESP-GALG	●										
R950012		32.00	48.00	7	GALGHD	●		●					R300755		38.00	58.50	7	GA-BI	●										
R920014		32.00	50.00	8	GALGHD			●					R300050		38.10	60.30	12.5/19	ESP-RI	●										
R450351		32.00	50.00	10	GAHD			●					R310256		38.10	63.55	12.7	GA	●										
R550012		32.00	50.00	10	GALGHD	●							R970012		38.50	58.00	11	GALGHD	●		●								
R452015		32.00	52.00	7	GALGHI					●			R210912		39.68	58.73	9.46	GALGRD	●										
R250050		32.00	56.00	10	GALGHI	●							R300057		39.68	80.29	7/16	ESP-RD	●										
R250256		32.54	51.43	9.92	GA	●							R540057		39.68	80.29	7/16	ESP-RD	●										
R320912		33.00	47.00	5	GALGHD					●			R340112		39.95	62.00	7.4	GALGHD							●				
R300255		33.33	57.15	12.7	G2	●							R280212		40.00	52.00	6	GALGHD			●	●							
R900912		34.00	48.00	7	GALGHD			●					R420613		40.00	52.00	7	GALGHD			●								
R550455		34.00	52.00	7.5	GA	●							R902112		40.00	52.00	7	GALGHD			●								
R220150		34.92	56.00	10.7	GALGRI	●							R220455		40.00	52.00	7.5	GALG	●										
R420612		35.00	45.00	7	GALGHD			●					R240455		40.00	52.00	8.5	E-GALG	●										
R570612		35.00	47.00	5.5	GALGHD					●			R320055		40.00	55.00	6.5	G1SRLG	●										
R550613		35.00	47.00	7	GAHD			●	●				R270713		40.00	55.00	7	G1ALGHD			●	●							
R240013		35.00	48.00	7	GALGHD			●	●				R300358		40.00	55.00	8	GALG	●										
R300350		35.00	49.70	12.7	G1LGRI	●							R971512		40.00	55.00	8	GALGHD			●								
R470013		35.00	50.00	7	GALG-BI			●	●				R310760		40.00	55.00	9	G1LG-BI	●		●								
R520915		35.00	50.00	8	GALG	●							R920013		40.00	55.00	9	GALGHD			●								
R910513		35.00	50.00	8	GALGHD		●						R250412		40.00	56.00	7	GALGRD	●		●								
R950712		35.00	50.00	8		●							R260312		40.00	56.00	7	G1ALGHD	●		●	●							
R550412		35.00	50.00	9	GALGHD	●		●	●				R450350		40.00	58.00	10	GAHI	●										
R520212		35.00	52.00	8	GALGHD			●					R460760-1		40.00	58.00	10	GALG-BI c/f			●								

c/f Con Feltro  
Con feltro/With Felt

## RETENES POR Ø DE EJE - RETENORES POR DIÁMETRO DO EIXO - DIAMETER HOLDERS OIL SEAL

REF	DE [mm]	DA [mm]	H [mm]	TIPO Type	MATERIAL						
					N	S	P	V	T	VF	
R250012	40.00	60.00	10	GAHD	■						
R470014	40.00	62.00	7	GALGHI				■			
R340115	40.00	62.00	7.4	GALGHD			■	■			
PR320015	40.00	-	-	PORTA				■			
R220359	40.10	52.00	9	ESP-GALG	■						
R320313	42.00	53.00	7	GALGHD			■	■			
R570412	42.00	54.00	6	GALGHD			■	■			
R250112	42.00	56.00	7	ESP-G1	■		■				
R250455	42.00	56.00	7	GA	■						
R300612	42.00	56.00	7	GAHD	■		■	■			
R910612	42.00	60.00	7	GALGHD	■	■					
R450412-1	42.00	60.00	8	GALGHD			■				
R450012	42.00	60.00	10	GALGHD	■		■				
R460212	42.00	62.00	7	GALGHD			■	■			
R800312	42.00	65.00	10	GALGHD			■	■			
R460712	42.00	66.00	8	GALGHD				■			
R500012	42.00	68.00	10/16	GALGHD	■						
R700912	42.00	72.00	10	GALG	■						
R300312	43.41	56.02	9.3	ESP-G1LGHD	■		■				
R910512	44.00	60.00	7	GALGHI	■						
R950312	44.00	60.00	7	GALGHD		■	■				
R220158	44.45	53.97	4.67	GA	■						
R510412	44.45	57.15	9.5	GALGHD		■					
R300012	44.45	60.30	11.11	G1AHD	■		■				
R540912	44.45	61.95	9.52	GAHD	■						
R220112	44.45	63.50	9.52	GAHD	■		■				
R200012	44.47	61.19	9.57	G1LGHD	■		■				
R220355	44.50	62.00	11	GALG-BI	■						
R570613	45.00	57.00	6.5	GALGHD			■	■			
R510812	45.00	57.15	9.5	GALGHD			■				
R250258	45.00	59.00	10	G1	■						
R420614	45.00	60.00	7	GALGHI			■				
R450412-2	45.00	60.00	7	GALGHD			■				
R450158	45.00	60.00	10	GA	■						
R450412	45.00	60.00	10	GALGHD	■		■				
R450055	45.00	62.00	12	GA	■						
R220358	45.00	65.00	8	GALG	■						
R250212	45.00	65.00	10	E-GAHD	■						
R351112	45.00	67.00	8	GALGHD				■			
R922512	45.00	68.00	7	-		■	■				
R950412	45.00	68.00	12	GALG	■						
R500112	45.00	68.00	10/16	GALGHD	■						
R800513	45.00	75.00	10	G1ALGHI				■			

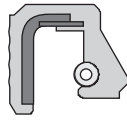

GA



GALG

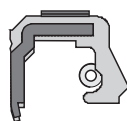

G1A



G1ALG

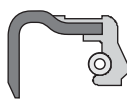

G1

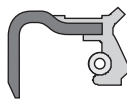

G1LG

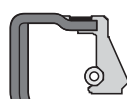

G2

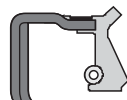

G2LG

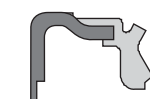

G1SRLG

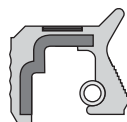

GALGRI/D

c/f Con Feltro  
Con feltro/With Felt

REF	DE [mm]	DA [mm]	H [mm]	TIPO Type	MATERIAL						
					N	S	P	V	T	VF	
R301712	45.00	63.8	10.8	G1ALGHD		■					
R360112	45.00	74.5	12/14.5	E-RD			■				
R272030	45.70	23.30	10.5	ESP			■				
R902512	46.00	58.00	7	GALGHD			■				
R310658	46.00	65.50	7/8.5	G1LG-BI	■						
R250757	46.00	78.00	10	G1LGHD	■						
R550459	46.43	69.78	12.3	GALG	■						
R430013	46.70	62.00	9	GALGHD				■			
R340712	47.00	63.40	8.8	GALGHD				■			
R340412	47.00	65	15	E-G1LGHD				■			
R470015	47.50	62.00	7	GALGHI				■			
R330313	47.60	66.70	11.3	GALGRD				■			
R340512	47.62	65.07	7.95	G1LGHD				■			
R302715	47.63	63.50	8.5/12.3	GALGHD				■			
R300212	47.65	65.05	11.83	G1AHD	■		■				
R310252	47.70	73.10	12.7	ESP	■						
R320712	48.00	65.00	7.85	GALGHD	■						
R150011	48.00	65.00	10	GALGHI	■						
R950212	48.00	65.00	10	GAHD			■	■			
R520812	48.00	68.00	11	GALGHD			■				
R900012	48.00	70.00	9	GALGHD	■		■				
R902312	48.00	70.00	9	GALGHD		■					
R970312	48.00	70.00	12	GALGHD	■						
R220356	48.00	72.00	7/8.5	GALG	■						
R550555	48.70	58.00	8.5	ESP	■						
R460255	48.90	63.00	10.8/12.8	E-GALG-BI			■				
R210012	49.20	65.09	12.7	GALGHD	■						
R300258-1	49.22	63.62	7.26	ESP	■						
R300455	50.00	65.00	9	ESP-G1	■						
R240712	50.00	65.00	10	-	■						
R550612	50.00	68.00	10	GALGRD			■	■			
R922312	50.00	68.00	9.5/12				■				
R270113	50.00	70.00	10	GALGRD			■	■			
R300258	50.80	66.60	6.5	G1SRLG	■						
R550458	50.80	69.85	9.53	GA	■						
R410912	50.90	69.80	9.5	GAHD	■						
R900812	51.00	70.00	11	GALGHD			■				
R324713	51.00	65.00	7					■			
R520312	52.00	68.00	9.5	GALGHD				■			
R450055-1	52.00	75.00	12	GA	■						
R540012	52.38	81.02	11	GALGHD	■						
R450355	53.00	79.00	10	ESP	■						
R220012	53.97	80.96	14.68	E-GARD	■						

# RETENES RADIALES

## OIL SEALS

### RETENES POR Ø DE EJE - RETENORES POR DIÂMETRO DO EIXO - DIAMETER HOLDERS OIL SEAL

REF		DE [mm]	DA [mm]	H [mm]	TIPO Type	MATERIAL					
						N	S	P	V	T	VF
R242512		54.00	82.00	11.45	-			●			
R270612		55.00	68.00	8	GALGHD				●		
R241515		55.00	70.00	8	GALGHI				●		
R270115		55.00	70.00	10	GALGHD				●		
R300759		55.00	70.00	6/10	ESP	●					
R700612		55.00	72.00	10	GALGHD	●					
R810151		55.00	75.00	9	G1LGHD				●		
R510512		55.00	81.00	15.8	G1LGHD			●	●		
PR231411		55.00	-	-	PORTA					●	
R150211		55.95	69.1	10	GAHI	●					
R500412		56.00	80.00	10	GAHD			●			
R430012		57.00	71.00	9	GALGRD				●		
R950511		57.00	77.00	10	GALGHI		●	●			
R850012		57.15	76.20	9.5	GALGHD	●		●			
R850512		57.15	76.20	9.5	GALGHD			●			
R220013		57.15	80.98	11.5	GALGRD			●			
R420112		57.30	76.20	12.7	GALGHD	●					
R430015		57.50	74.00	8	GASRLG	●					
R950011		58.00	74.00	9.5	GALGHI			●			
R310458		58.95	76.00	9	G1SRLG	●					
R550655		60.00	70.00	9.1	ESP	●					
R500211-1		60.00	75.00	5	EXPAN		●				
R581812		60.00	75.00	7	GALGRD				●		
R990011		60.00	75.00	8	GALGHI			●			
R950711		60.00	78.00	10	GALGHI			●			
R940011		60.00	80.00	8	GALGHI		●				
R330012		60.30	82.50	11	G1HD			●			
R400012		60.32	79.36	9.5	GALGHD	●		●	●		
R320111		60.45	76.18	10	GALGHI				●		
R260950		63.00	69.50	11	ESP			●			
R870012		63.50	79.50	9	G1ALGRD				●		●
R200011		64.00	78.00	12	2 PARTES			●			
R200011-1		64.00	78.00	12	2 PARTES		●				
R200011-2		64.00	78.00	12	EXPAN		●				
R450411-1		64.00	80.00	5	EXPAN		●				
R250111		64.00	80.00	8	G1ALGHI	●	●	●	●		
R250811		64.00	80.00	8	G1ALGHD	●		●	●		
R700112		64.00	85.00	12	GAHD	●					
R470012		64.00	88.00	6	GALGHD				●		
PR260911		64.00	81.50	8	PORTA				●		
R922313		65.00	79.00	7				●			
R650112		65.00	85.00	13	G1ALGHD			●			
R350212		65.00	90.00	15	G1LGHD	●					

REF		DE [mm]	DA [mm]	H [mm]	TIPO Type	MATERIAL					
						N	S	P	V	T	VF
R330312		66.67	85.70	10	GALGRD				●		
R320012		66.67	89.30	10	GALGRD			●	●		
R330212		66.70	88.80	11/12.5	G1ALGHD			●			
R350957		68.00	85.00	10	GALGHD			●			
R360057		68.00	85.00	10	GALG	●					
R581813		70.00	85.00	7	GALGRD				●		
R260011		70.00	85.00	8	G1ALGHI			●			
R570511		70.00	86.00	8	GALGHI				●		
R971511		70.00	88.00	11	-				●		
R220311		70.00	90.00	10	GAHI				●		
R270112		70.00	90.00	10	GALGHD			●	●		
R550411		70.00	90.00	10	GALGHI	●		●			
R800012		70.00	90.00	15	G1LGHD			●			
PR270112		70.00	-	-	PORTA					●	
R800812		70.00	100.00	12.5/16							●
R950311		72.00	96.00	9	GALGRI			●			
R270511		74.00	88.00	8	G1ALGRI				●		
R260111		74.00	90.00	10	G1ALGRI			●	●		
PR270511		74.00	-	-	PORTA					●	
PR270711		74.00	-	-	PORTA					●	
PR271911		74.00	-	-	PORTA						●
R870212		75.00	93.00	9/10	G1ALGRD				●	●	
R350858		75.00	95.00	13	GALG	●					
R350612		75.00	100.00	12	G1LGHDI			●			
R970011		75.00	100.00	13	GALGRI			●	●		
R700212		75.00	100.00	17	GALGHD	●					
R200811		75.90	95.00	11.3	GALGH			●			
R241911		76.00	92.00	10	GALGRI			●			
R220111		76.20	95.22	9.32	GARI	●		●			
R510411		76.20	95.25	9.5	GALGHD		●				
R271511		78.00	100.00	9	GALGSRRI				●		●
R460511		78.00	100.00	10	G1ALGHI				●		
R310412		78.00	100.00	13	GALGHD			●	●		
R351012		78.00	104.00	11	GASRRD cff			●			●
R926611		78.00	105.0	7.5	-				●		
R860011		79.00	126.00	1.25	ESPFI			●			
PR320011		79.00	-	16	PORTA					●	
PR291011		79.00	-	-	PORTA					●	
R330311		79.30	99.00	9.8	GALGHI				●		
R340111		79.30	93.00	9						●	
PR340111		79.30	-	-	PORTA					●	●
R300611		79.38	95.25	11.11	GAHI			●	●		
R520811		80.00	96.00	9	GALGRI			●			



*cf* Con Feltro  
Con feltro/With Felt



# RETENES RADIALES

## OIL SEALS

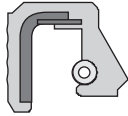
### RETENES POR Ø DE EJE - RETENORES POR DIÂMETRO DO EIXO - DIAMETER HOLDERS OIL SEAL

REF		DE [mm]	DA [mm]	H [mm]	TIPO Type	MATERIAL								REF		DE [mm]	DA [mm]	H [mm]	TIPO Type	MATERIAL								
						N	S	P	V	T	VF	N								S	P	V	T	VF				
R910511		80.00	96.00	9	GALGHI		•							R460211		90.00	110.00	7	GALGRI				•					
R950611		80.00	96.00	9	GALGRI			•						R971811		90.00	110.00	8.5	-		•							
R240411		80.00	98.00	10	G1ALGRI			•	•					R460211-1		90.00	110.00	10	GALGRI				•					
R570011		80.00	100.00	8	GALGRI					•				R550611		90.00	110.00	13	GALGRI			•	•					
R250211		80.00	100.00	10	GALGHI	•		•						R270111		90.00	115.00	13	GALGHI					•				
R810115		80.00	100.00	12	G1LG-BI					•				R500411		90.00	120.00	12	G1ALGHI			•						
R950411		80.00	100.00	12	GALGHI		•							PR370011		90.00	-	-	PORTA						•			
R550811		80.00	100.00	13	GARI			•	•					R520911		91.00	111.00	9	GALGHI		•							
R902311		80.00	100.00	13	GALGHI		•	•						R330511		91.00	111.00	10	G1ALGRI					•				
R970311		80.00	105.00	13	GALGHI		•	•						R300411		91.50	106.50	5.5	ESP-GARI	•		•						
PR320911		80.00	-	-	PORTA							•		R290611		91.50	114.80	12.5				•						
PR321711		80.00	-	-	PORTA						•			R321811		92.00	106.00	5	2 PARTES				•					
PR340314		80.00	-	-	PORTA			•						R302511		92.00	107.58	9.5	G1ARI						•			
R300711		82.00	105.00	12	GALGHI			•						R300311		92.00	108.00	9.8	GAHI				•					
R902111		84.00	104.00	11	GALGRI			•						R581811		93.00	108.00	7	GALGRI					•				
R903411		84.00	117.00	8.5	GALGRI					•				R351111		93.00	114.00	13	GALGHI					•				
PR233311		84.00	-	-	PORTA							•		PR270911		93.00	-	-	PORTA						•			
PR901511		84.00	-	-	PORTA						•			PR351211		93.00	-	-	PORTA							•		
R560111		85.00	105.00	8	GALGRI			•	•					R321111		95.00	114.50	9.5	GALGHI		•							
R910611		85.00	105.00	10	GAHI	•								R340911		95.00	114.50	11	GALGRI				•					
R560611		85.00	105.00	11	GALGRI				•	•		•		R922211		95.00	115.00	9.5	GALGHI		•							
R220411		85.00	105.00	12	GALGRI			•	•		•			R280111		95.00	115.00	12	GALGRI				•					
PR221711		85.00	-	-	PORTA					•		•		R351155		95.00	115.00	13	GALG-BI	•								
PR230211		85.00	-	-	PORTA					•	•			R242111		95.00	115.00	12.5	GALGHI	•								
PR231211		85.00	-	-	PORTA							•		R240711		95.00	118.00	8.5	GALGHI	•		•						
PR907611		85.00	-	-	PORTA			•						R350258		95.00	130.00	13	G2LG	•								
PR224011		85.00	-	-	PORTA							•		R570611		98.00	110.00	7	GALGRI					•				
PR231211		85.00	-	-	PORTA								•		R324711		98.00	110.00	9.5						•			
PR232411		85.00	-	-	PORTA									R470011		98.00	120.00	7	GALGHI					•				
PR232411-2		85.00	-	-	PORTA									PR521911		98.00	-	-	PORTA							•		
PR232911		85.00	164/152	10.5	PORTA					•				R290711		99.00	114.00	11	GALGRI					•				
PR472111		85.00	-	-	PORTA							•		PR430011		99.45	-	-	PORTA						•		•	
R300911		85.70	100.00	5.5	E-GARI	•	•	•						R270311		100.00	118.00	10	GALGHI					•				
R300011		85.70			GAHI			•						R350458		100.00	120.00	13	G2LG	•								
R240311		85.90			GALGRI			•	•					R650912		100.00	120.00	15	GALGHD				•					
R300911-1		86.00			EXPAN		•							R350958		100.00	125.00	12	G1A-BI	•								
R280211		87.00			GALGRI					•				R360812		100.00	130.00	11	GALGRD						•			
R320311		88.00			GALGRI					•				R930111		100.00	135.00	15	GALGHI		•							
R301711		88.00			GAHI					•				R900811		101.57	125.00	13	GALGHI		•							
PR302211		88.00			PORTA							•		R850511		101.60	127.00	7.94	GALGHI				•					
R420611		88.90			GARI			•						R360012		105.00	130.00	12	G1ALGRD						•			
R240211		90.00			GALGRI			•	•					PR302011		105.00	-	-	PORTA							•		
R350211-1		90.00			EXPAN		•							R310411		110.00	130.00	13	GALGHI				•	•				

c/ Con Fieltro  
Con feltro/With Felt

# RETENES RADIALES OIL SEALS

## RETENES POR Ø DE EJE - RETENORES POR DIÂMETRO DO EIXO - DIAMETER HOLDERS OIL SEAL

REF	DE [mm]	DA [mm]	H [mm]	TIPO Type	MATERIAL					
					N	S	P	V	T	VF
R350255	110.00	140.00	13	G2LG	●					
R650212	110.00	140.00	16	GALGHD		●				
R200311	112.50	130.00	11	G1ALGRI			●			
R360811	113.00	140.00	12	GALGRI				●		
R800311	114.00	135.00	13	G1ALGRI					●	
PR270111	114.00	-	-	PORTA					●	
PR291611	115.00			PORTA						●
R351011	115.00	140.00	13	G1ASRRI c/f			●			
R650111	115.00	140.00	16	G1ALGHI			●			
R210011	118.00	143.00	13	GARI	●					
R360011	120.00	140.00	13	G1ALGRI					●	
R350455	120.00	145.00	15	G2LG	●					
R850011	120.65	146.07	12.7	GALGRI c/pista			●			
R330011	122.20	140.80	12	GALGHI					●	
R350955	125.00	150.00	15	G2LG-BI	●					
R870011	130.00	150.00	12/13	GALGRI				●		●
R800811	130.00	155.00	12.5/16							●
R330411	130.00	160.00	12	G1ALGRI					●	
R810111	130.00	160.00	15	GALGRI					●	
R400211	133.35	158.75	11/13	GALGRI			●	●		
R800511	140.00	165.00	13	G1ALGRI			●			
R650411	150.00	172.00	18.3	GAHI			●			
R800055	180.00	200.00	12	G1ALG	●					
R510511				2 MITADES			●			

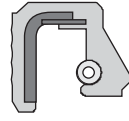

GA



GALG

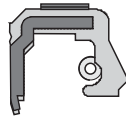

G1A



G1ALG

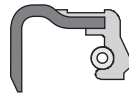

G1

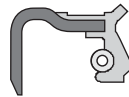

G1LG



G2

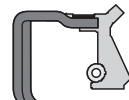

G2LG

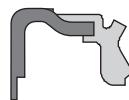

G1SRLG



GALGRI/D

c/f Con Feltro  
Con feltro/With Felt

REF	DE [mm]	DA [mm]	H [mm]	TIPO Type	MATERIAL					
					N	S	P	V	T	VF
R310256	38.10	63.55	12.7	GA	●					
R220455	40.00	52.00	7.5	GALG	●					
R240455	40.00	52.00	8.5	E-GALG	●					
R320055	40.00	55.00	6.5	G1SRLG	●					
R300358	40.00	55.00	8	GALG	●					
R310760	40.00	55.00	9	G1LG-BI	●					
R460760-1	40.00	58.00	10	GALG-BI c/f			●			
R220359	40.10	52.00	9	ESP-GALG	●					
R250455	42.00	56.00	7	GA	●					
R220158	44.45	53.97	4.57	GA	●					
R220355	44.50	62.00	11	GALG-BI	●					
R250258	45.00	59.00	10	G1	●					
R450158	45.00	60.00	10	GA	●					
R450055	45.00	62.00	12	GA	●					
R220358	45.00	65.00	8	GALG	●					
R310658	46.00	65.50	7/8.5	G1LG-BI	●					
R550459	46.43	69.78	12.3	GALG	●					
R310252	47.70	73.10	12.7	ESP	●					
R220356	48.00	72.00	7/8.5	GALG	●					
R550555	48.70	58.00	8.5	ESP	●					
R460255	48.90	63.00	10/12.8	GALG			●			
R300258-1	49.22	63.62	7.26	ESP	●					
R300455	50.00	65.00	9	ESP-G1	●					
R300258	50.80	66.60	6.5	G1SRLG	●					
R550458	50.80	69.85	9.53	GA	●					
R450055-1	52.00	75.00	12	GA	●					
R450355	53.00	79.00	10	ESP	●					
R300759	55.00	70.00	6/10	ESP	●					
R310458	58.95	76.00	9	G1SRLG	●					
R550655	60.00	70.00	9.1	ESP	●					
R350858	75.00	95.00	13	GALG	●					
R351155	95.00	115.00	13	GALG-BI	●					
R350258	95.00	130.00	13	G2LG	●					
R350458	100.00	120.00	13	G2LG	●					
R350958	100.00	125.00	12	G1A-BI	●					
R350255	110.00	140.00	13	G2LG	●					
R350455	120.00	145.00	15	G2LG	●					
R350955	125.00	150.00	15	G2LG-BI	●					
R800055	180.00	200.00	12	G1ALG	●					

## RETENES DE TRANSMIÇÃO - TRANSMISSÃO - TRANSMISSION

R300347	7.90	16.00	6	GA	●					
R550447	8.40	16.00	6.5	GA	●					
R240048	13.00	26.00	7	GALG	●					

# RETENES RADIALES - RUEDA / TRANSMISION

## OIL SEAL - WHEEL OIL SEALS / TRANSMISSION

### RETENES POR Ø DE EJE - RETENORES POR DIÁMETRO DO EIXO - DIAMETER HOLDERS OIL SEAL

REF	DE [mm]	DA [mm]	H [mm]	TIPO Type	MATERIAL					
					N	S	P	V	T	VF
R550051	13.00	26.00	9	GALG	●					
R250148	14.00	24.00	7	ESP	●					
R550451	15.00	26.00	7	GALG	●					
R300748	15.50	28.00	6/15	ESP	●					
R300048	15.70	23.81	4.76	GA SR	●					
R550648	16.00	22.80	4.8	GA	●					
R250448	16.00	24.60	9/20	ESP	●					
R450348	17.00	23.00	7	ESP	●					
R300749	17.00	28.00	7/10	GALGHD	●					
R550450	17.00	28.00	7/13	GAHD	●					
R220649	20.00	35.00	7/10.5	GAHD		●				
R240949	21.00	32.00	7.5	G1LGHD	●					
R300751	21.50	40.00	7	GAHD		●				
R250451	22.00	40.00	7/8.5	G2LGHD	●					
R200349	22.10	40.00	12/17	GALGHD	●					
R260251	22.80	40.00	7/8.5	G2LGHD		●				
R250457	23.00	37.00	13.5	ESP		●				
R550550	24.00	36.00	8/12	GAHD	●					
R550951	27.95	56.00	10	GALGHD		●				
R570351	27.95	70.00	10	GALGHD		●				
R250151	28.00	47.00	8	GAHD	●					
R300351	28.00	40.00	8	GALGHD	●					
R450557	28.00	45.00	8	GAHD		●				
R300051	28.58	41.20	6.2	G1HD	●					
R200849	29.90	45.00	7	G1HD		●				
R200051	31.68	44.45	6.35	G1HD	●					
R250050	32.00	56.00	10	GALGHI	●					
R450351	32.00	50.00	10	GAHD		●				
R220150	34.92	56.00	10.7	GALGRI	●					
R300350	35.00	49.70	12.7	G1LGRI	●					
R250257	36.00	68.00	10/13	GAHD	●					
R300050	38.10	60.30	12.5/19	ESP-RI	●	●				
R300057	39.68	80.29	7/16	ESP-RD	●					
R450350	40.00	58.00	10	GAHI	●	●				
R250757	46.00	78.00	10	G1LGHD	●					
R260950	63.00	69.50	11	ESP		●				
R350957	68.00	85.00	10	GALGHD			●			
R360057	68.00	85.00	16	GALG	●					

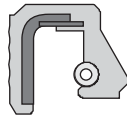

GA



GALG

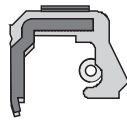

G1A



G1ALG

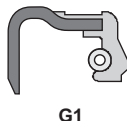

G1



G1LG

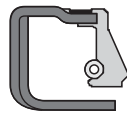

G2

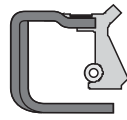

G2LG



G1SRLG

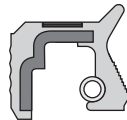

GALGR/D

#### EL MISMO RETEN FABRICADO EN DISTINTOS CAUCHOS

Aconsejamos el uso prioritario de los materiales recomendados en las aplicaciones y referencias originales de nuestro catálogo.

Con el propósito de ofrecer un mejor servicio atendiendo las preferencias de diferentes mercados y clientes, algunos retenes de nuestro catálogo se fabrican también en materiales alternativos.

Si el material recomendado no se ajusta a sus necesidades, le sugerimos que consulten la lista de retenes TARANTO, clasificados por dimensiones, para verificar si la misma pieza puede ser suministrada en otro caucho.

#### O MESMO RETENTOR FABRICADO EM DIFERENTES MATERIAIS

Recomendamos o uso prioritário dos compostos indicados nas aplicações e referências originais do nosso catálogo.

Com o intuito de oferecer melhor serviço atendendo as preferências de diferentes mercados e clientes, alguns retentores de nosso catálogo são fabricados em materiais alternativos.

Se o material recomendado não se ajusta a suas necessidades sugerimos que consultem a lista de retentores TARANTO, classificados por dimensão para verificar se a mesma peça pode ser fornecida em outra borracha.

#### THE SAME OIL SEAL MANUFACTURED IN VARIOUS RUBBERS

It is suggested, as a priority, the use of the materials recommended in the applications and original references (OEM) of our catalogue.

However in order to offer a better service and to assist the preferences of different markets and customers some oil seals of our catalogue are also manufactured with alternative materials.

If the recommended material does not meet your requirements, you should consult TARANTO oil seal list classified by dimensions, to confirm if the same piece can be supplied in another rubber.

#### DISEÑO

La constante mejora de nuestros retenes produjo cambios en el diseño tales como:

- Ⓐ **Modificación de diseño externo:**  
Facilita el montaje y asegura el agarre.
- Ⓑ **Lábios desplazados:**  
Permiten trabajar el labio en una parte del eje no utilizada hasta el momento.
- Ⓒ **Diseño de labio:**  
Se potenció el uso de la rosca como sello hidrodinámico.

#### PROJETO

A constante melhora de nossos retentores produziu mudanças de projeto como:

- Ⓐ **Modificação de desenho externo:**  
Facilita a montagem e assegura o alojamento.
- Ⓑ **Lábios deslocados:**  
Permite que o lábio trabalhe em uma parte do eixo ainda não utilizada.
- Ⓒ **Desenho do lábio:**  
Aumentou a utilização da rosca como vedação hidrodinâmica.

#### DESING

The steady improvement of our oil seals produced changes in desing such as:

- Ⓐ **Changes in external design:**  
Making assembly easier and ensuring housing.
- Ⓑ **Displaced Lips:**  
Allowing the lip to work in a part of shaft not used so far.
- Ⓒ **Lip Design:**  
The use of thread as hydrodynamic seal was potentialized.

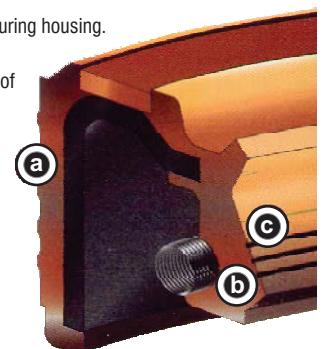

c/f Con Fieltro  
Con feltro/With Felt



# taranto



HAB12075

#### BARRA DE EXTENSION CON LUZ LED

Práctica barra de extensión con encastre de 1/2 x 75mm. Para trabajar en lugares oscuros. Superbrillante y potente luz led con baterías alojadas en el interior de la barra.



## KIT HAK12-38 Taranto.

Práctico Juego de llaves Especiales para Motor.

- ▶ Contiene todos los tipos y medidas de herramientas necesarios para el trabajo sobre vehículos de última generación.
- ▶ Posee tubos y tubos con punta de alta resistencia son fabricados en acero cromo vanadio con doble cromado y moleteados para mejorar el agarre.
- ▶ Encastre de 12.7 mm. Con espacio para bola de retención.



# HERRAMIENTAS ESPECIALES PARA MOTOR

## SET OF SPECIAL AUTOMOTIVE TOOLS

### KIT HAK12-38



#### FORMACION DEL CODIGO DE ARTICULO

<b>H</b>	<b>A</b>	<b>T</b>	<b>5</b>	<b>5</b>	<b>0</b>	<b>5</b>	<b>5</b>
LINEA		TIPO	MEDIDA		LARGO HERRAMIENTA		

#### LINEA

HA: Herramienta de ajuste

#### TIPOS DE LLAVE

D: Tubo Estriado  
S: Tubo Hexagonal  
B: Barra de Extensión

E: Tubo Torx Hembra  
N: Tubo con Punta Estriado  
R: Tubo con Punta Ribe  
T: Tubo con Punta Torx

#### KIT HAK 12-38 - 38 PIEZAS ENCASTRE DE 12.7mm (1 2")

CANT.	CONTENIDO	TUBOS HEXAGONALES	CODIGO	DESCRIPCION	D (mm)	L (mm)
9	TUBOS HEXAGONALES 12,13,14,15,17,19,21,24,27mm		HAS12038	HEXAGONAL 12mm	22	38
5	TUBOS ESTRIADOS 10,12,14,17,19mm		HAS13038	HEXAGONAL 13mm	22	38
6	TUBOS TORX HEMBRA E10,E12,E14,E16,E18,E20		HAS14038	HEXAGONAL 14mm	22	38
5	TUBOS CON PUNTA TORX T55X55,T55X100,T60X55,T60X100,T70X100mm		HAS15038	HEXAGONAL 15mm	22	38
5	TUBOS C/ PUNTA ESTRIADA M9X100,M10X55,M10X100,M12X55,M12X100mm		HAS17038	HEXAGONAL 17mm	24	38
3	TUBOS CON PUNTA RIBE R10X168,R12X63,R14X63mm.		HAS19038	HEXAGONAL 19mm	26	38
5	TUBOS CON PUNTA HEXAGONAL H8X55,H8X90,H8X120,H10X55,H10X140mm.		HAS21038	HEXAGONAL 21mm	28	38
			HAS24038	HEXAGONAL 24mm	32	38
			HAS27038	HEXAGONAL 27mm	36	42

TUBOS ESTRIADOS	CODIGO	DESCRIPCION	D (mm)	L (mm)
	HAD10038	ESTRIADO 10mm	22	38
	HAD12038	ESTRIADO 12mm	22	38
	HAD14038	ESTRIADO 14mm	22	38
	HAD17038	ESTRIADO 17mm	24	38
	HAD19038	ESTRIADO 19mm	26	38

TUBOS TORX	CODIGO	DESCRIPCION	D (mm)	L (mm)
	HAE10038	TORX Hembra E10	23	38
	HAE12038	TORX Hembra E12	23	38
	HAE14038	TORX Hembra E14	23	38
	HAE16038	TORX Hembra E16	23	38
	HAE18038	TORX Hembra E18	23	38
	HAE20038	TORX Hembra E20	24	38

TUBOS CON PUNTA TORX	CODIGO	DESCRIPCION	D (mm)	L (mm)
	HAT55055	Punta TORX T55 x 55mm	24	55
	HAT55100	Punta TORX T55 x 100mm	24	100
	HAT60055	Punta TORX T60 x 55mm	24	55
	HAT60100	Punta TORX T60 x 100mm	24	100
	HAT70100	Punta TORX T70 x 100mm	24	100

TUBOS CON PUNTA ESTRIADA	CODIGO	DESCRIPCION	D (mm)	L (mm)
	HAN09100	Punta EST. M9 x 100mm	24	100
	HAN10055	Punta EST. M10 x 55mm	24	55
	HAN10100	Punta EST. M10 x 100mm	24	100
	HAN12055	Punta EST. M9 x 100mm	24	55
	HAN12100	Punta EST. M12 x 55mm	24	100

TUBOS CON PUNTA RIBE	CODIGO	DESCRIPCION	D (mm)	L (mm)
	HAR10168	Punta RIBE R10 x 168mm	24	168
	HAR12063	Punta RIBE R12 x 63mm	24	63
	HAR14063	Punta RIBE R14 x 63mm	24	63

TUBOS CON PUNTA HEXAGONAL	CODIGO	DESCRIPCION	D (mm)	L (mm)
	HAH08055	Punta HEX. H8 x 55mm	24	55
	HAH08090	Punta HEX. H8 x 90mm	24	90
	HAH08120	Punta HEX. H8 x 120mm	24	120
	HAH10055	Punta HEX. H10 x 55mm	24	55
	HAH10140	Punta HEX. H10 x 140mm	24	140

#### BARRA DE EXTENSION CON LUZ LED - ENCASTRE 12.7mm (1 2")

BARRA CON LUZ	CODIGO	DESCRIPCION	D (mm)	L (mm)
	HAB12075	Barra de extensión 1/2" x 75 mm - con luz led	12.7	75

Práctica barra de extensión con encastrado de 1 2" x 75mm. Para trabajar en lugares oscuros!

Super brillante y potente luz LED con baterías alojadas en el interior de la barra.

3 baterías de repuesto incluidas en el kit.



# taranto

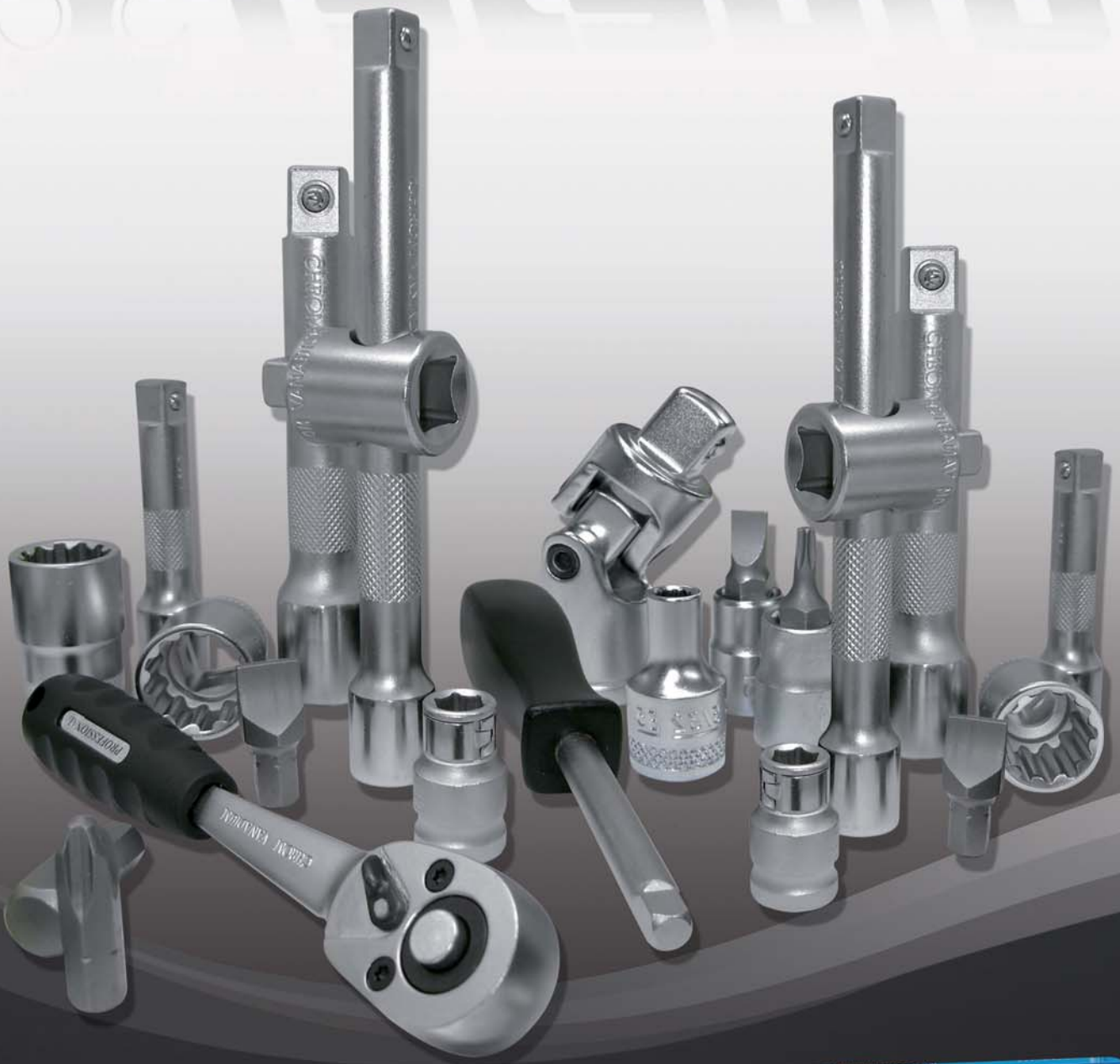

## KIT HAK639512-111 Taranto.

Práctico Juego de llaves combinadas para Taller.











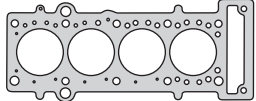

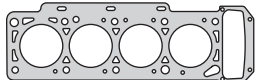

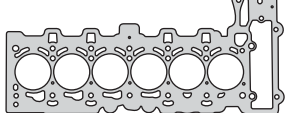

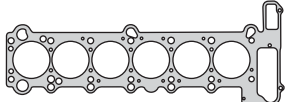

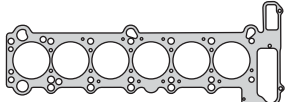

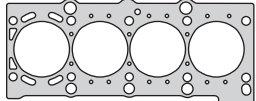
- ▶ Contiene 111 Tubos y llaves SmarDriv encastre 1/4", 3/8" y 1/2"
- ▶ Forjados en acero especial, niquelados y cromados anticorrosión.
- ▶ Diseñados y fabricados con un rango de medidas acorde a las necesidades de cada pieza.

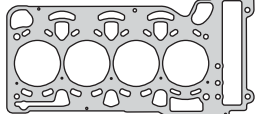

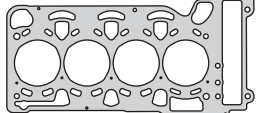
**MOTORES NAFTA Y DIESEL / PETROL AND DIESEL ENGINES**

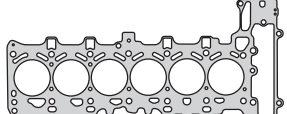
	<b>Código Code</b>	<b>Q</b>	<b>≠</b>	<b>Kit Bulón Bolt Set</b>	<b>Aplicación Application</b>	<b>Motor Engine</b>	<b>Juego</b>
	<b>950207</b> 980207	81.5	1.60	<b>B980000</b> HAE14038	320, 520 1977/82 323i 1977/82	<b>1990cc.</b> M20 122HP Ø80 <b>2315cc.</b> M20 142HP Ø80 (SOHC) 12V	<b>950200-R</b> 🚗 pág. 03
	<b>980007</b> 980007	81.0	1.80	<b>B980000</b> HAE14038	520i 1982/90, 1987/90, 320i 1982/93 - 1988/91 323i 1982/86	<b>1990cc.</b> M20(206KA) 125/129HP 206EE 130HP Ø80 <b>2315cc.</b> M20(236EE) 139/150HP Ø80 (SOHC) 12V	<b>980000-R</b> 🚗 pág. 04
	<b>980107</b> 980107	85.0	1.90	<b>B980000</b> HAE14038	325i Base 1987/93, 325i, 325ix 1985/93 325ix Base, 325 KAT 1988/91 325e 1983/86, 525e 1987/90	<b>2494cc.</b> M20 (256E1/E2/K1/K2) 171HP M20 168HP Ø84 <b>2693cc.</b> M20 (276KA/KB) 123HP Ø84 (SOHC) 12V	
	<b>980207</b> 980207-2M 980207-3M	81.0 81.0	1.68 1.87	<b>B980200</b> HAE16038	325 TD 1991/92, 525 TDS 1990/92 <b>DIESEL</b>	<b>2498cc.</b> M51 (256T1) 115HP M51 (256T1-L) 143HP Ø80 (SOHC) 12V	<b>980201-R</b> 🚗 pág. 05
	<b>980307</b> 980307	85.0	1.70	<b>B981700</b> HAE12038	316i 1993/98 318i 1987/93, 518i 1989/94	<b>1596cc.</b> M43 (164E2) 102HP Ø84 <b>1796cc.</b> M40 (184E1) 113HP Ø84 (SOHC) 8V	
	<b>980507</b> 980507-1M 980507-2M 980507-3M	81.0 81.0 81.0	1.55 1.68 1.87	<b>B980500</b> HAE14038	324 D 1985/90, 524 D 1986/87, 324 TD 1987/93, 524 TD 1982/87 <b>DIESEL</b>	<b>2443cc.</b> M21 (246D/DA) 86HP M21 (246TB/TA) 115HP Ø80 (SOHC) 12V	<b>980501-R</b> 🚗 pág. 06
	<b>980707</b> 980707	90.0	1.50	<b>B980700</b> HAS19038	318/518 1975/80 320/520 1972/78 - 1978	<b>1766cc.</b> M10 98HP Ø89 <b>1990cc.</b> M10 109/105HP Ø89 (SOHC) 8V	
	<b>980907</b> 980907	90.0	1.90		530i KAT 1988/91- 730i KAT 1986/92	<b>2986cc.</b> M30 (306KA) 188HP Ø89 (SOHC) 12V	
	<b>981107</b> 981107-2M 981107-3M	81.0 81.0	1.68 1.87	<b>B981100</b> HAE16038	318TDS 1994/99, 318 Compact TDS 1995/00 <b>DIESEL</b>	<b>1670cc.</b> M41D (174T1) 90HP Ø80 (SOHC) 8V	<b>981101-R</b> 🚗 pág. 07
	<b>981207</b> 981207-2M 981207-3M	81.0 81.0	1.68 1.87	<b>B980200</b> HAE16038	725 TDS 1995/..., 325 TDS, 525 TDS, 325 TD, 525 TD 1994/... <b>DIESEL</b>	<b>2498cc.</b> M51 (256T1) 115/143HP M51 (256T1-L) 143HP Ø80 (SOHC) 12V	<b>981201-R</b> 🚗 pág. 08

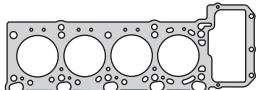
**MOTORES NAFTA Y DIESEL / PETROL AND DIESEL ENGINES**

	<b>Código Code</b>	<b>Q</b>	<b>≠</b>	<b>Kit Bulón Bolt Set</b>	<b>Aplicación Application</b>	<b>Motor Engine</b>	<b>Juego</b>
	<b>981307 - 981308</b> 981307 981308	78.0 78.0	0.95 0.65	<b>B981300</b>  HAS15038	One Coupe (Mini R50) 2000/01, Cooper Coupe (Mini R50) 2000/01	<b>1598cc.</b> W10B16A 90/116HP Ø77	<b>981300-R</b>  pág. 09
	<b>981407</b> 981407	86.0	1.70	<b>B980700</b>  HAS19038	1500 1962/86, 1502 316 (E21) 1975/84, 1600 (E6), 1602, 1600 Ti (E10) 1600 GT 1800 1963/68	<b>1499cc.</b> M10 B15 70HP Ø84 <b>1573cc.</b> M10 B16 73/84/90/103HP Ø84 <b>1773cc.</b> M10 90HP Ø84 (SOHC) 8V	<b>981400-R</b>  pág. 10
	<b>981508</b> 981508	83.0	1.30	<b>B982100</b>  HAT60055 HAT60100	523i 2005/... - 323i, 325i, 325xi, X3i, Z4i 2006/...	<b>2497cc.</b> N52B25A 177/218HP Ø82 (DOHC) 24V	<b>981500-R MLS</b>  pág. 11
	<b>981707</b> 981707 981707-2.0	85.0 85.0	1.74 2.00	<b>B981800</b>  HAE12038	520i, 320i 1989/92	<b>1991cc.</b> M50 (206S1) 150HP Ø80 (DOHC) 24V	<b>981700-R</b>  pág. 12
	<b>981707</b> 981707 981707-2.0	85.0 85.0	1.74 2.00	<b>B981900</b>  HAE12038	323i, 523i 1995/99, 323 ti 1999/00 328i 1995/99, 528i 1995/00, 728i 1995/01, Z3 Coupe 1998/00, Z3 Roaster 1996/00	<b>2494cc.</b> M52 B25 (256S3/S4) 163/170HP Ø84 <b>2793cc.</b> M52 B28 (256S1/S2) 193HP Ø84 (DOHC) 24V	<b>981900-R</b>  pág. 13
	<b>981807</b> 981807	85.0	1.74	<b>B981700</b>  HAE12038	318is, 318 ti 1993/95	<b>1796cc.</b> M42 (184S1) 140HP Ø84 (DOHC) 16V	
	<b>982008</b> 982008	84.5	0.45	<b>B982000</b>  HAE12038 HAE10038	316i, 316ci Coupe, 316ti 2000/... 318ti, 318ci Cabrio, 318ci Coupe 2000/... 320is 2001/..., 318ci Cabrio, 318ci Coupe X3i 2003/..., Z4i 2004/...	<b>1796cc.</b> N42B18A 115/116HP Ø84 <b>1995cc.</b> N42B20A - N46B20A/B20C <b>1995cc.</b> N46B20B 150HP Ø84 (DOHC) 16V	<b>982000-R MLS</b>  pág. 14
	<b>982008</b> 982008	84.5	0.45	<b>B982000</b>  HAE12038 HAE10038	318ti 2004/07	<b>1995cc.</b> N46B20BD 150HP Ø84 (DOHC) 16V	
	<b>982108</b> 982108	90.0		<b>B982100</b>  HAT60055 HAT60100	323i, 523i, 325i, 325xi, 525xi 2004/...	<b>2497cc.</b> N52B25A 177/218HP Ø82 (DOHC) 24V	
	<b>982207</b> 982207	85.0	1.75	<b>B982200</b>  HAE12038	730i, 530i 1992/96	<b>2997cc.</b> M60 (308S1) 218HP Ø84 (DOHC) V8 32V	



**BMW**



Motor/Engine	Cm³	HP	Ø
M20	1990	122	80
M20 (SOHC) 12V	2315	142	80

BMW: 320, 520, 323i 1977/82



Nº OE	Descripción/Description	Mat.	Ref.
	Jgo. de juntas para motor		950200-R
11121738609	Junta tapa cilindros Ø 81.5 ± 1.60	NFT	1 950207
11121726478	Jgo. tornillos tapa cilindros (HAE14038)		B980000
11121730271	Junta tapa de válvulas	NH	1 950210
11131730234	Junta para cárter	NH	1 950211
11141720903	Tapa distribución	NB	1 950212
	Tapa bomba de agua	NB	1 950214
11621723877	Jgo. múltiple escape (6)	NFT	1 950216
11611730743	Jgo. múltiple admisión (5)	NB	1 950217
18111245429	Salida de escape	NFT	2 950218
	Acople bomba de agua	NB	1 950219
	Bomba aceite	NB	1 950227
	Bomba nafta	NB	2 950228
	Brida bomba aceite	NB	1 950229
	Inyección	NB	1 950230
	Inyección	NB	1 950231
07119963130	Arandela tapón cárter A 12 x 15.5 x 1.5 A	AL	
	Kit de retenes completo		R950200
11349059172	Jgo. retén válvulas (12)	V	1 R950210V
11401706999	Retén bancada 90 x 110 x 13	V	1 R550611V
11141275466	Retén distribución 48 x 65 x 10	P	1 R950212P
11121285609	Retén árbol levas 38 x 50 x 6	V	1 R452113V

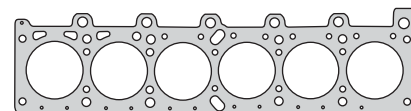

950207

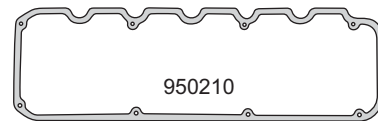

950210

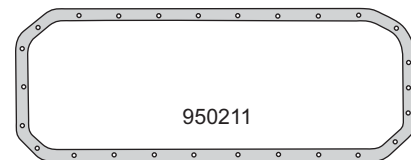

950211

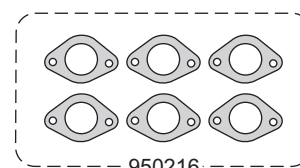

950216

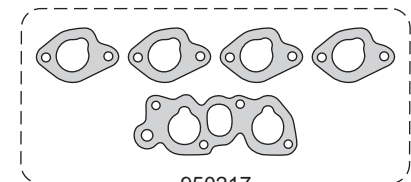

950217

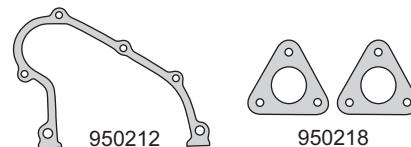

950212

950218

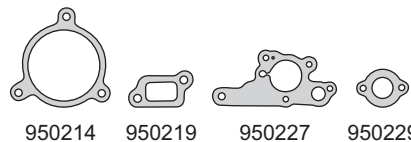

950214

950219

950227

950229

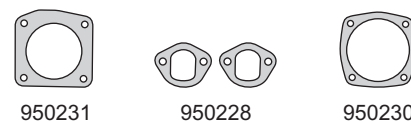

950231

950228

950230

A 12 x 15.5 x 1.5 A



R550611V



R950212P



R452113V

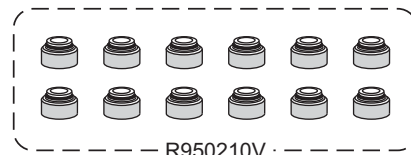

R950210V

**BMW**



Motor/Engine	Cm³	HP	Ø
M20 (206KA)	1990	125/129	80
206EE	1990	130	80
M20 (236EE) (SOHC) 12V	2315	139/150	80

**BMW:** 520i 1982/90 - 1987/90  
320i 1982/93 - 1988/91  
323i E30 1982/86



Nº OE	Descripción/Description	Mat.	Ref.
	<b>Jgo. de juntas para motor</b>		<b>980000-R</b>
11131738611	Junta tapa cilindros Ø 81.0 ± 1.80	NFT	1 980007
11121726478	Jgo. tornillos tapa cilindros (HAE14038)		<b>B980000</b>
11121730271	Junta tapa de válvulas	NFT	1 950210
11131730234	Junta para cárter	CG	1 950211
11141720903	Tapa distribución	NH	1 950212
	Tapa bomba de agua	NH	1 950214
11621723877	Jgo. múltiple escape (2)	NFT	1 980016
11611730743	Jgo. múltiple admisión (5)	NH	1 950217
18111245429	Salida de escape	AC	2 950218
	Acople bomba de agua	NH	1 950219
	Bomba aceite	NH	950227
	Bomba nafta	NH	2 950228
	Porta retén bancada trasera	CB	1 980529
	Brida bomba aceite	NH	1 950229
	Junta	CB	1 980030
	Junta	CB	1 980031
	Inyección	NH	950230
	Inyección	NH	950231
	Tapón goma	GS	4 950240
	Arandela A 13.3 x 10 x 0.86 A	AL	1
	Arandela A 14 x 17.8 x 1.36 A	AL	4
	Arandela A 14 x 17.8 x 1.40 C	CU	2
	Arandela A 15.3 x 12.3 x 1.36 A	AL	3
	Arandela A 27 x 22 x 1.36 A	AL	1
	O´ring G 60 x 3.5	GS	1
	O´ring G 55 x 2	GS	1
	O´ring G 40 x 3	GS	2
	O´ring G 40 x 4	GS	1
	O´ring G 27 x 2.4	GS	1
	O´ring G 27 x 3	GS	2
	O´ring G 7.5 x 3.6	GS	13
	O´ring G 6.5 x 2	GS	1
	Kit de retenes completo		R950200
11349059172	Jgo. retén válvulas (12)	V	1 R950210V
11401706999	Retén bancada 90 x 110 x 13	V	1 R550611V
11141275466	Retén distribución 48 x 65 x 10	P	1 R950212P
11121285609	Retén árbol levas 38 x 50 x 6	V	2 R452113V

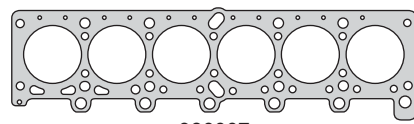

980007

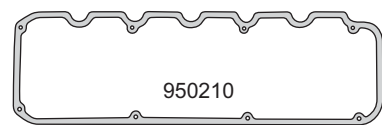

950210

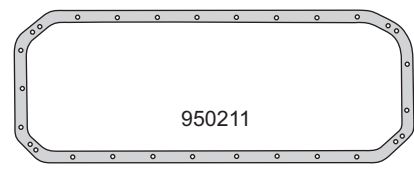

950211

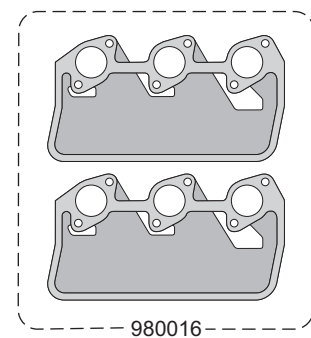

980016

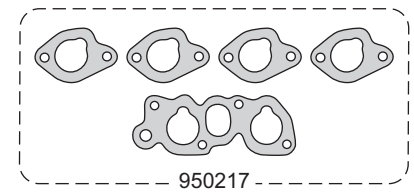

950217

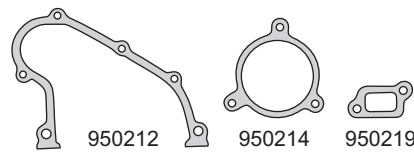

950212

950214

950219

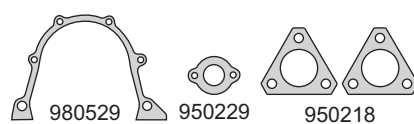

980529

950229

950218

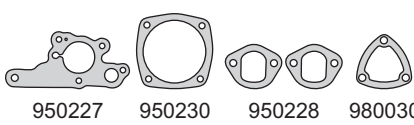

950227

950230

950228

980030



980031

950240

950231



R452113V



R550611V

R950212P

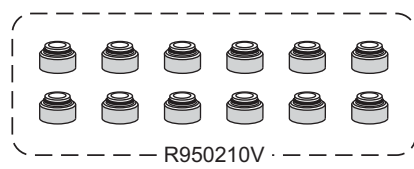

R950210V

**BMW**



Motor/Engine	Cm³	HP	Ø
M51 (256T1)	2498	115	80
M51 (256T1-L) (SOHC) 12V	2498	143	80

BMW: 325 TD 1991/92, 525 TDS 1990/92

DIESEL



Nº OE	Descripción/Description	Mat.	Ref.
	Jgo. de juntas para motor		980201-R
11129065445	Jgo. de juntas superior		980295
11122245483	Junta tapa cilindros Ø 81.0 $\pm$ 1.68	NFT	980207-2M
11122245427	Junta tapa cilindros Ø 81.0 $\pm$ 1.87	NFT	980207-3M
11129067790	Jgo. tornillos tapa cilindros		B980200
11122244398	Junta tapa válvulas	GS	1 1 980210
11139065503	Junta para cárter	NH	1 1 980211
	Placa distribución	NH	1 1 980213
11622243782	Jgo. múltiple escape con reflector (5)	CHA	1 1 980216
11612244391	Jgo. múltiple admisión (6)	NH	1 1 980217
	Salida de escape	NFT	1 1 980218
	Base filtro aceite a bomba	NH	1 980227
	Junta porta retén trasero	CB	1 980229
	Acople bomba aceite	NH	1 980230
	Retorno aceite a turbo	SLS	1 980231
	Cierre distribución	GS	1 980232
	O'ring G 69.5 x 3.5	GS	2 2
	O'ring G 11.6 x 1.59	GS	2 2
	O'ring G 12.6 x 1.6	GS	4 4
	O'ring G 70 x 5	GS	1
	O'ring G 50 x 2	GS	1
	O'ring G 4.5 x 1.4	GS	1
	O'ring G 14.6 x 3	GS	1
	O'ring G 18 x 2	GS	1
	O'ring G 9 x 2	GS	1
	O'ring G 19 x 2.5	GS	1
	O'ring G 35 x 3	GS	1
	O'ring G 28 x 2	GS	1
	Arandela A 15.25 x 12.4 x 1.3 A	AL	4 4
	Arandela A 14.9 x 12.2 x 1.4 C	CU	2 2
	Arandela A 23.8 x 20 x 1.3 C	CU	1
	Arandela A 12.8 x 10 x 1 C	CU	4
	Arandela A 17.8 x 14 x 1.3 A	AL	1
	Arandela A 15.8 x 10.2 x 1 A	AL	1
07119963130	Arandela tapón cárter A 12 x 15.5 x 1.5 A	AL	1
	Kit de retenes completo		R980200
11349064457	Jgo. retén válvulas (12)	V	1 R980210V
11141706999	Retén bancada 90 x 110 x 10	V	1 R980211V
11141275466	Retén distribución 48 x 65 x 10	V	1 R950212V

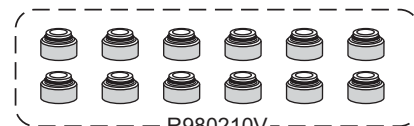
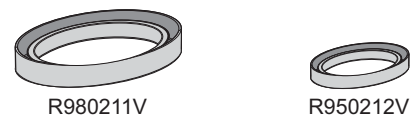
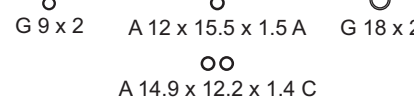
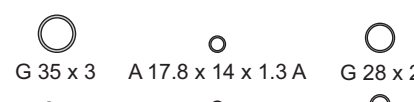
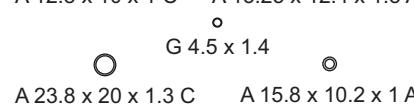
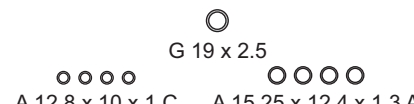
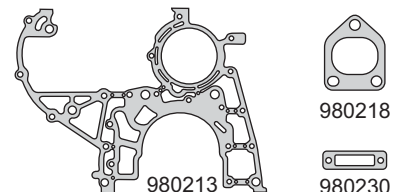
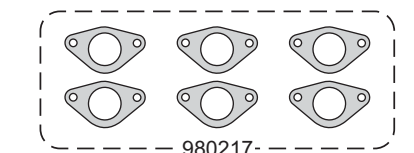
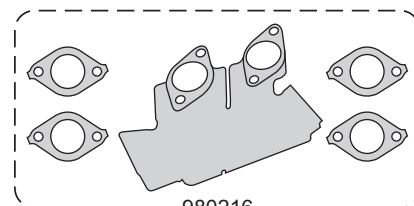
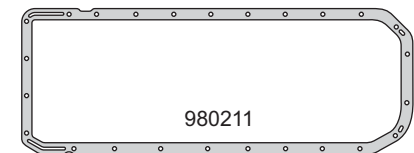
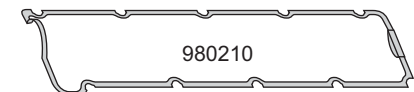
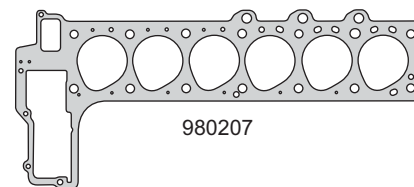

**BMW**



Motor/Engine	Cm³	HP	Ø
M21 (246D/DA)	2443	86	80
M21 (246TB/TA) (SOHC) 12V	2443	115	80

BMW: 324 D 1985/90, 524 D 1986/87  
324 TD 1987/93, 524 TD 1982/87

DIESEL



Nº OE	Descripción/Description	Mat.	1	2	Ref.
	Jgo. de juntas para motor				980501-R
11122243879	Jgo. de juntas superior		●	●	980595
11122244727	Junta tapa cilindros Ø 81.0 $\pm$ 1.55		NFT		980507-1M
11122244728	Junta tapa cilindros Ø 81.0 $\pm$ 1.68		NFT		980507-2M
11122244729	Junta tapa cilindros Ø 81.0 $\pm$ 1.87		NFT		980507-3M
11122243143	Jgo. tornillos tapa cilindros (HAE14038)				B980500
11121285973	Junta tapa válvulas		GS	1	980510
11131730234	Junta para cárter		NH	1	980511
11141720903	Tapa distribución		CB	1	950212
	Bomba de agua		NH	1	950214
	Bomba de agua		NH	1	980514
11622243866	Jgo. múltiple escape (6) 980216/1		CHA	1	980516
11612243867	Jgo. múltiple admisión (3)		NH	1	980517
	Termostato		NH	1	980519
	Base filtro aceite a bomba		CB	1	980527
	Porta retén bancada trasera		CB	1	980529
	Base termostato		NH	1	980530
	Junta		NH	1	980531
	Retorno agua		CB	1	980532
	Chupador aceite		CB	1	980533
	Retorno aceite a turbo		CB	1	980539
07119963130	Arandela tapón cárter A 12 x 15.5 x 1.5 A		AL	1	
	Arandela A 17.85 x 14 x 1.36 A		AL	3	3
	Arandela A 22 x 16 x 1.35 C		CU	1	1
	Arandela A 20 x 16 x 1.3 C		CU	2	2
	Arandela A 20 x 14.3 x 1.5 A		AL	4	4
	Arandela A 14.9 x 12.2 x 1.5 C		CU	2	2
	Arandela A 15.25 x 12 x 1.3 A		AL	6	
	Arandela A 17.8 x 14 x 1.3 A		AL	6	
	Arandela A 19.8 x 16 x 1.3 C		CU	2	
	O´ring G 5 x 2		GS	2	2
	O´ring G 36.5 x 30 x 3		GS	1	1
	O´ring G 13.8 x 2		GS	1	1
	O´ring G 28 x 4.72		GS	1	1
	O´ring G 10 x 8		GS	1	1
	O´ring G 60 x 3.5		GS	1	1
	O´ring G 40 x 3.15		GS	1	
	O´ring G 102 x 4		GS	1	
	O´ring G 92 x 5.38		GS	1	
	Kit de retenes completo				R980500
11349059172	Jgo. retén válvulas (12)		V	1	R980510V
11141706999	Retén bancada 110 x 90 x 10		V	1	R980211V
11141275466	Retén distribución 48 x 65 x 10		V	1	R950212V
11121285609	Retén árbol de levas 38 x 50 x 7		V	2	R980513V

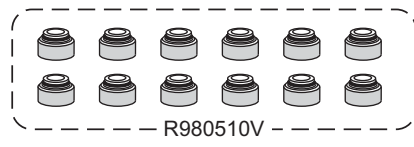
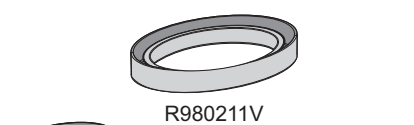
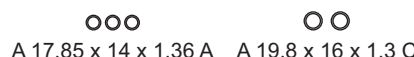
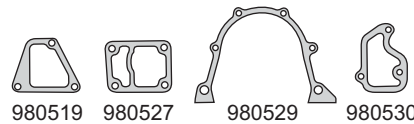
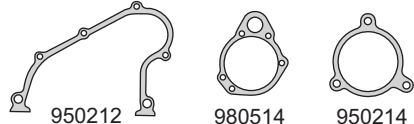
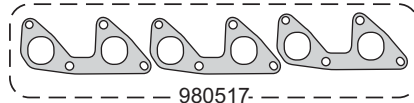
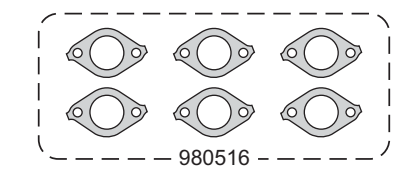
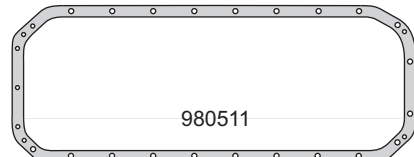
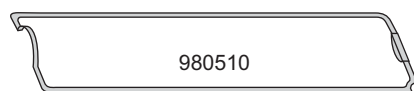
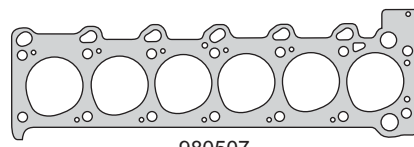

**BMW**



Motor/Engine	Cm³	HP	Ø
M41D (174T1) (SOHC) 8V	1670	90	80

BMW: 318TDS 1994/99  
318 Compact TDS 1995/00

DIESEL

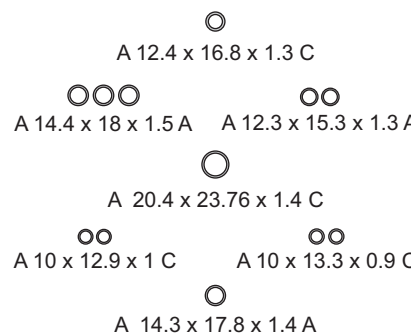
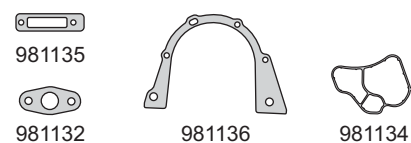
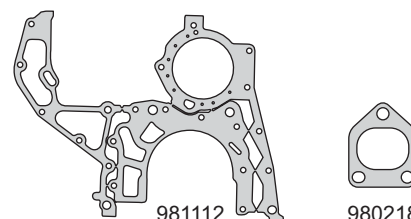
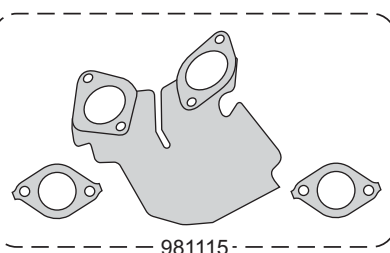
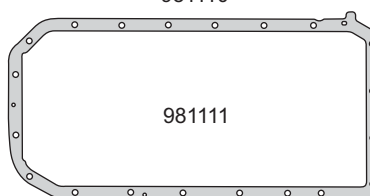
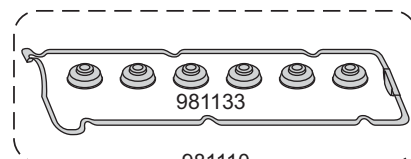
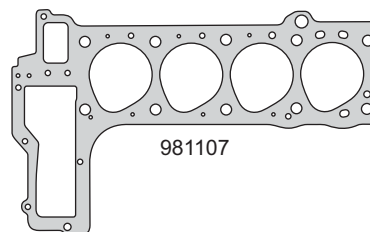

Nº OE	Descripción/Description	Mat.	Ref.
	Jgo. de juntas para motor		981101-R
11122246704	Jgo. de juntas superior	●	981195-2M
	Jgo. de juntas superior	●	981195-3M
11122246093	Junta tapa cilindros Ø 81.0 ±1.68	NFT	1 981107-2M
11122246092	Junta tapa cilindros Ø 81.0 ±1.87	NFT	981107-3M
11129067792	Jgo. tornillos tapa cilindros (HAE16038)		B981100
11122245599	Conj. junta tapa válvulas (7)	GS	1 1 981110
11139067655	Junta para cárter	GS	1 981111
	Tapa distribución	SLS	1 981112
11622245274	Jgo. múltiple escape con reflectores (3)	CHA	1 1 981115
11612245438/9	Jgo. múltiple admisión (5)	GS	1 1 981117
	Salida de escape	NFT	1 1 980218
	Brida	SLS	1 1 981132
11122245844	Arandelas tapa válvulas	CH/GS	6 6 981133
	Guarnición bomba de aceite	GS	1 981134
	Junta inspección distribución	SLS	1 981135
	Junta porta reten trasero motor	SLS	1 981136
	O´ring G 9.60 x 2.5	GS	2
	O´ring G 9.20 x 2.2	GS	2
	O´ring G 16.50 x 4	GS	2
	O´ring G 9.48 x 2.38	GS	2
	O´ring G 12.46 x 1.5	GS	2
	O´ring G 60 x 3.5	GS	2
	O´ring G 14.50 x 3	GS	1
	O´ring G 63.5 x 2.54	GS	1
	O´ring G 28.26 x 2	GS	1
	O´ring G 36 x 3	GS	1
	O´ring G 68 x 5.04	GS	1
	Arandela A 14.4 x 18 x 1.5 A	AL	3
	Arandela A 12.3 x 15.3 x 1.3 A	AL	2
	Arandela A 10 x 12.9 x 1 C	CU	2
	Arandela A 10 x 13.3 x 0.9 C	CU	2
	Arandela A 12.4 x 16.8 x 1.3 C	CU	1
	Arandela A 20.4 x 23.76 x 1.4 C	CU	1
	Arandela A 14.3 x 17.8 x 1.4 A	AL	1
	Kit de retenes completo		R981100
11342245151	Jgo. retén válvulas (8)	V	1 R981110V
11142245364	Retén bancada trasera 90 x 110 x 12	V	1 R981111V
11141274346	Retén distribución 48 x 65 x 10	V	1 R981112V
	Retén árbol de levas 42 x 66 x 6	V	1 R981113V

**BMW**



Motor/Engine	Cm³	HP	Ø
U25TD/X25TD	2498	130	80
D256TM	2498	136	80
M51 (256T1/T1-L) (SOHC) 12V	2498	115/143	80

**BMW:** 725 TDS - 325, 525 TD/TDS 1994/...

**Opel:** Omega B TD 1994/96

**Rover:** Range Rover Turbo 1994/02

**DIESEL**



Nº OE	Descripción/Description	Mat.	Ref.
	Jgo. de juntas para motor		<b>981201-R</b>
11122244328	Jgo. de juntas superior	●	<b>981295-2M</b>
	Jgo. de juntas superior		<b>981295-3M</b>
11122245483	Junta tapa cilindros Ø 81.0 ± 1.68	NFT 1	<b>981207-2M</b>
11122245427	Junta tapa cilindros Ø 81.0 ± 1.87	NFT	<b>981207-3M</b>
11129067790	Jgo. tornillos tapa cilindros (HAE16038)		<b>B980200</b>
11122244398	Junta tapa válvulas	GS 1 1	980210
11139066503	Junta para cárter	NH 1	981211
	Frete distribución	SLS 1	980213
11622246172	Jgo. multiple escape (5)	CHA 1 1	980216
11612244391	Jgo. multiple admisión (6)	NH 1 1	980217
	Salida de escape	NFT 1 1	980218
	Base filtro aceite a bomba	SLS 1	981227
	Porta retén bancada trasero	NH 1	981229
	Acople bomba aceite	SLS 1	981230
	Retorno aceite a turbo	SLS 1	981231
	Cierre distribución	GS 1	980232
	O'ring G 61.26 x 3.89	GS 2 2	
	O'ring G 9.2 x 2.62	GS 2 2	
	O'ring G 12.6 x 1.60	GS 4 4	
	O'ring G 120 x 3.6	GS 1	
	O'ring G 70 x 5	GS 1	
	O'ring G 35 x 3	GS 1	
	O'ring G 14.6 x 3	GS 1	
	O'ring G 19 x 2.5	GS 1	
	O'ring G 4.5 x 1.4	GS 1	
	O'ring G 9.4 x 2	GS 1	
	O'ring G 65 x 2.63	GS 1	
	O'ring G 28 x 2	GS 2	
	Arandela A 15.25 x 12.4 x 1.3 A	AL 4 4	
	Arandela A 15 x 12.20 x 1.43 C	CU 2 2	
	Arandela A 23.8 x 20 x 1.3 C	CU 1	
	Arandela A 13.8 x 10.4 x 0.8 C	CU 4	
	Arandela A 15 x 10.2 x 1 A	AL 2	
	Arandela A 18 x 14.3 x 1.5 A	AL 1	
	Kit de retenes completo		R980200
11349064457	Jgo. retén válvulas (12)	V 1	R980210V
11141706999	Retén bancada 90 x 110 x 10	V 1	R980211V
11141275466	Retén distribución 48 x 65 x 10	V 1	R950212V

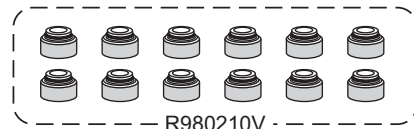
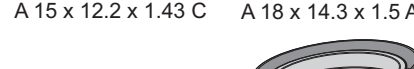
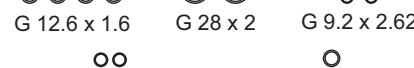
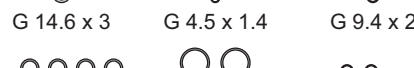
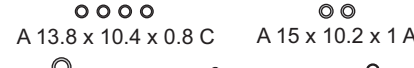
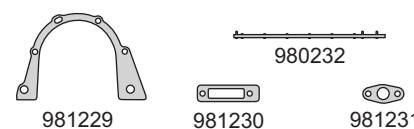
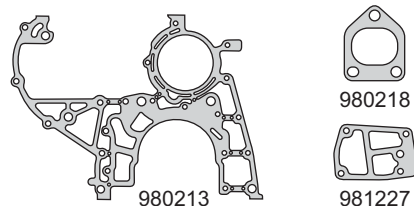
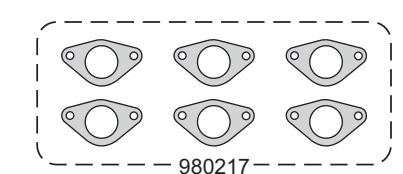
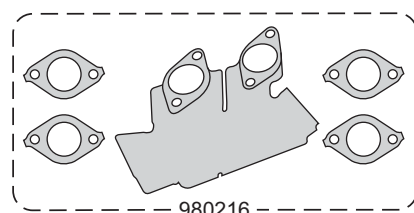
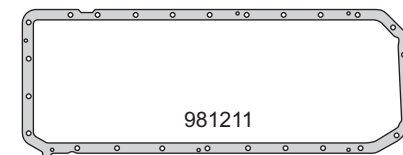
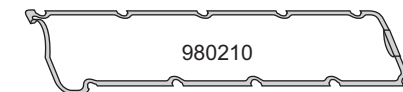
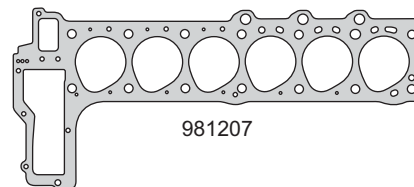

# MINI COOPER



Motor/Engine	Cm³	HP	Ø
W10B16A	1598	90/116	77

Mini Cooper: One Coupe (Mini R50) 2000/01  
Cooper Coupe (Mini R50) 2000/01



Nº OE	Descripción/Description	Mat.	Ref.
	Jgo. de juntas para motor		● 981300-R
11.12.7.508.44	Junta tapa cilindros Ø 78.0 ± 0.95	NFT	981307
11.12.7.508.543	Junta tapa cilindros Ø 78.0 ± 0.65	MLS	1 981308
	Jgo. tornillos tapa cilindros (HAS15038)		B981300
11.12.1.485.838	Jgo. junta tapa válvulas (5)	GS	1 981310
	Junta para cárter	GS	1 981311
	Tapa distribución	SLS	1 981312
11.62.1.174.968	Múltiple escape	SLS	1 981315
	Múltiple admisión	SLS	1 981317
11.61.7.513.044	Jgo. múltiple admisión (4)	GS	1 981317-1
18.11.1.170.941	Salida de escape	NFT	1 981318
	Anillo tapa válvulas	GS	4 981333
13.64.1.437.474	O'ring pico inyector superior e inf. G 7.52 x 3.51	GS	8
	O'ring G 28 x 3.4	GS	2
	O'ring G 31 x 2.6	GS	1
	O'ring G 19.5 x 2.3	GS	1
	O'ring G 15 x 2	GS	1
	Kit de retenes completo		R981300
13.34.0.029.571	Jgo. retén válvulas (16)	V	1 R981310V
	Retén bancada 91 x 111 x 10	V	1 R981311V
	Retén distribución 32 x 45 x 6	V	1 R981312V

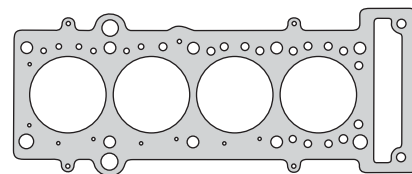

981308

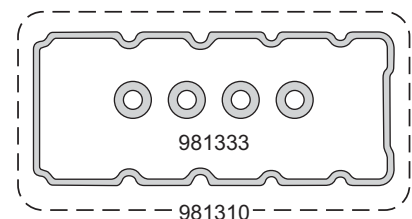

981333

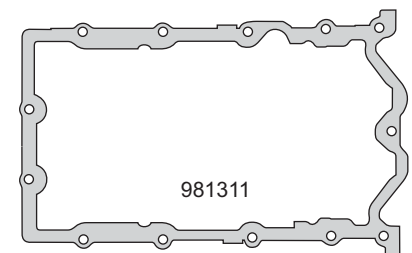

981311

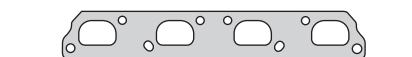

981315



981317



981317-1

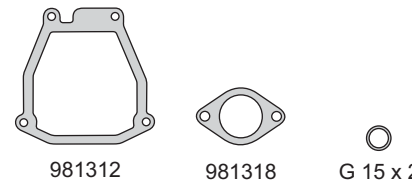

981312

981318

G 15 x 2

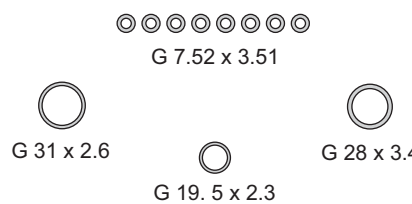

G 7.52 x 3.51

G 31 x 2.6

G 19.5 x 2.3

G 28 x 3.4



R981311V

R981312V

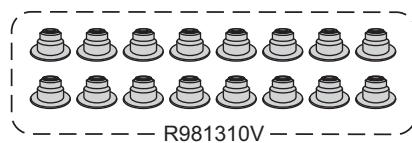

R981310V

**BMW**



Motor/Engine	Cm³	HP	Ø
M10 B15	1499	70	82
M10 B16	1573	73/84	84
M10 B16	1573	90/103	84
M10 (SOHC) 8V	1773	90	84

**BMW:** 1500 1962/86  
 316 (E21) 1975/84  
 1500, 1502, 1600 (E6)  
 1602, 1600 Ti (E10), 1600 GT  
 1800 1963/68



Nº OE	Descripción/Description	Mat.	Ref.
	Jgo. de juntas para motor		981400-R
	Jgo. de juntas superior	●	981495
	Jta. tapa cilindros Ø 86.0 ± 1.70 NR <sup>2</sup>	NFT 1 1	981407
	Jgo. tornillos tapa cilindros (HAS19038)		B980700
	Junta tapa de válvulas	NFT 1 1	981410
	Junta para cárter	NH 1	981411
	Tapa distribución	NB 1	981412
	Tapa distribución	NB 1	981412-1
	Base distribución	NB 1	981413
	Bomba de agua	NB 1	981414
	Jgo. múltiple escape (4)	FCH 1 1	981415
	Jgo. múltiple admisión (2)	NB 1 1	981417
	Salida de escape	FCH 1 1	981418
	Bomba de agua	NB 1	981419
	Junta carburador	NB 1 1	981423
	Junta	NB 1	981427
	Junta bomba de nafta	NB 2 2	981428
	Junta	NB 1 1	981429
	Junta	NB 2 2	981431
	Junta cierre bancada	NB 1 1	981432
	Junta cierre bancada	NB 1 1	981433
	Junta tapón bomba aceite	NB 1	981437
	Junta	NB 1	981440
	Junta	NB 1	981441
	Guarnición goma G 22 x 28 x 4.2	GS 1 1	
	O'ring G 18 x 5	GS 2	
	O'ring G 12 x 3	GS 2	
	O'ring G 10 x 3.53	GS 1	
	Arandela blindada B 22.3 x 26.75 x 2 CN	CN 1	
	Arandela blindada B 8.3 x 12 x 1.5 CN	CN 1	
	Arandela A 36 x 42 x 2 A	AL 1 1	
	Arandela A 30 x 36 x 2 A	AL 2 2	
	Arandela A 22.5 x 27 x 1.5 A	AL 2 3	
	Arandela A 14.2 x 17.9 x 1.5 A	AL 3 5	
	Arandela A 8 x 11.5 x 1.25 A	AL 2 2	
	Arandela A 22.5 x 27 x 1.5 C	CU 4	
	Arandela A 12 x 15 x 1.5 C	CU 5	
	Arandela A 6.5 x 10 x 1 C	CU 4	
	Arandela A 10.5 x 16 x 1 C	CU 1	
	Arandela A 12 x 18 x 1.5 A	AL 1	
	Arandela A 12.5 x 15 x 1.5 A	AL 2	
	Arandela A 10 x 13 x 1 A	AL 1	
	Arandela A 5 x 7 x 1 A	AL 1	
	Kit de retenes completo		R981400
	Jgo. retén válvulas (8)	V 1	R981410V
	Retén bancada 90 x 110 x 12	V 1	R981411V
	Retén distribución 35 x 55 x 12	P 1	R981412P

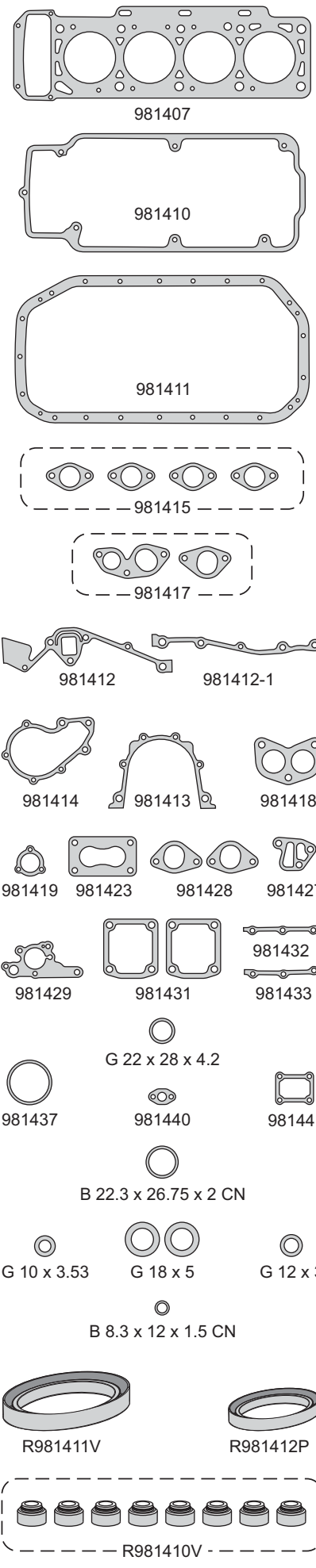



**BMW**



Motor/Engine	Cm³	HP	Ø
N52B25A (DOHC) 24V	2497	177/218	82

BMW: 523i 2005/..., 323i, 325i, 325xi, X3i  
Z4i 2006/...



Nº OE	Descripción/Description	Mat.	Ref.
	<b>Jgo. de juntas para motor</b>	●	<b>981500-R MLS</b>
	<b>Junta tapa cilindros Ø 83.0 ± 1.30</b>	MLS 1	<b>981508</b>
	<b>Jgo. tornillos tapa cilindros (HAT60055/60100)</b>		<b>B982100</b>
	Conj. junta tapa válvulas (2)	GS 1	981510
	Junta para cárter	AC/GS 1	981511
	Jgo. múltiple escape (6)	GFT 1	981515
	Jgo. múltiple admisión G 49 x 2 x 5 (6)	GS 1	981517
	Salida de escape	NFT 2	981518
	Junta termostato	SLS 1	981519
	Junta base filtro aceite	GS 1	981527
	Junta	AC/GS 1	981528
	Junta válvula EGR	GFT 1	981531
	Junta válvula mariposa G 82 x 3 x 11	NFT 1	981532
	Junta tapón árbol de levas	AC/GS 1	981539
	Anillo	AC/GS 1	981540
	Junta llenado aceite	GS 1	981541
	Tapón varilla aceite	GS 1	981542
	Arandela A 22 x 27 x 1.60 C	CU 2	
	Arandela A 12.4 x 18 x 1.30 A	AL 1	
	O´ring G 7.5 x 3.5	GS 12	
	O´ring G 8 x 2	GS 1	
	O´ring G 9.2 x 2.5	GS 1	
	O´ring G 18 x 2	GS 1	
	O´ring G 18 x 3	GS 4	
	O´ring G 24 x 2.9	GS 2	
	O´ring G 25 x 4	GS 2	
	O´ring G 28 x 3	GS 1	
	O´ring G 29 x 3.7	GS 1	
	Kit de retenes completo		R981500
	Jgo. retén válvulas (24)	V 1	R981510V
	Retén bancada 89 x 110 x 12	T 1	R981511T
	Retén distribución 65 x 79 x 20	T 1	R981513T

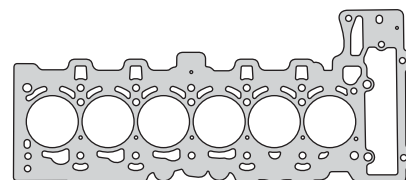

981508

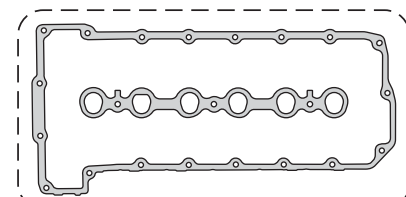

981510

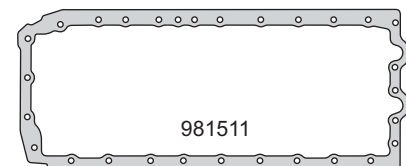

981511

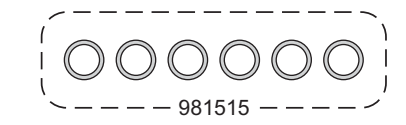

981515



981517

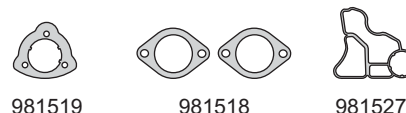

981519

981518

981527



981528

981531

981532



981539

981540

981541

981542

A 12.4 x 18 x 1.30 A



G 28 x 3

G 7.5 x 3.5

G 18 x 2



G 24 x 2.9

G 18 x 3

G 25 x 4

A 22 x 27 x 1.60 C

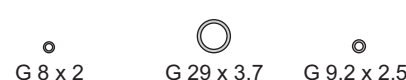

G 8 x 2

G 29 x 3.7

G 9.2 x 2.5

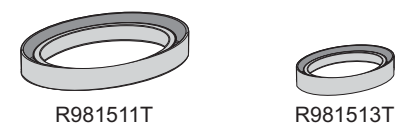

R981511T

R981513T

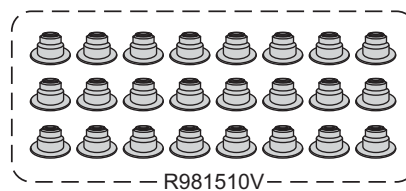

R981510V

**BMW**



Motor/Engine	Cm³	HP	Ø
M50 (206S1) (DOHC) 24V	1991	150	80

BMW: 520i, 320i 1989/92



Nº OE	Descripción/Description	Mat.	Ref.
	Jgo. de juntas para motor		981700-R
	Jgo. de juntas superior	●	981795
11121726623	Junta tapa cilindros Ø 85.0 ± 1.74	NFT 1 1	981707
	Junta tapa cilindros Ø 85.0 ± 2.00	NFT	981707-2.0
	Jgo. tornillos tapa cilindros (HAE12038)		B981800
11120034108	Conj. junta tapa válvula (3)	AC/GS 1 1	981710
11131720519	Junta para cárter	AC/GS 1 1	981711
11361740840	Junta cárter distribución	SLS 1 1	981712
11141720639	Tapa distribucion inferior izquierda	SLS 1 1	981713
11621728981	Jgo. múltiple escape (2)	NFT 1 1	981715
11611717259	Jgo. múltiple admisión (6)	GS 2 1	981717
18301716888	Salida de escape	NFT 1 2	981718
11531740437	Junta de la carcasa del termostato	GS 1	981719
11421719855	Junta filtro de aceite	GS 1	981727
-	Porta retén bancada trasero	SLS 1	981729
11411703947	Junta tubo de aceite	NB 1 1	981730
11611716174	Válvula aceleradora G 73 x 79 x 11	GS 1 1	981732
	Brida de agua	NB 1	981737
	Arandela A 10.5 x 16 x 1.5 A	AL 3 1	
	Arandela A 12.5 x 16 x 1.5 A	AL 3 3	
	Arandela A 14 x 18 x 1.5 A	AL 2 3	
	Arandela A 15 x 20 x 1.5 A	AL 1 4	
	Arandela A 26.5 x 31 x 1.5 A	AL 1 1	
	Arandela A 27.5 x 32 x 1 A	AL 1 1	
	O´ring G 4.47 x 1.78	GS 12 2	
	O´ring G 7.52 x 3.53	GS 1 12	
	O´ring G 9.12 x 3.53	GS 1	
	O´ring G 9.19 x 2.62	GS 2	
	O´ring G 15.6 x 1.78	GS 1 1	
	O´ring G 15.47 x 3.53	GS 1	
	O´ring G 15.54 x 2.62	GS 1 1	
	O´ring G 18.64 x 3.53	GS 2 1	
	O´ring G 20.3 x 2.62	GS 1 2	
	O´ring G 21.89 x 2.62	GS 1 1	
	O´ring G 23.39 x 3.53	GS 1	
	O´ring G 40.87 x 3.53	GS 1 1	
	O´ring G 59.92 x 3.53	GS 1	
	O´ring G 69.22 x 5.33	GS 1	
	O´ring G 88.49 x 3.53	GS 1	
	Kit de retenes completo	1	R981700
6060500058	Jgo. reten válvulas (24)	V 1	R981710V
11142245364	Retén bancada trasera 90 x 110 x 12	V 1	R981111V
11141274346	Retén distribución 48 x 65 x 10	V 1	R981113V

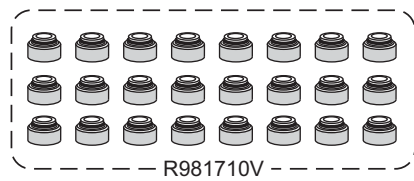
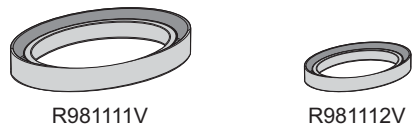
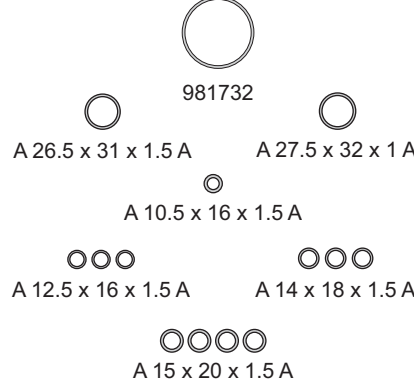
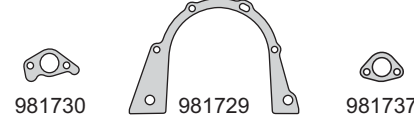
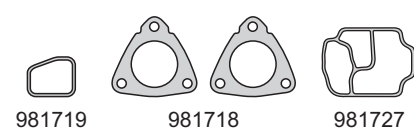
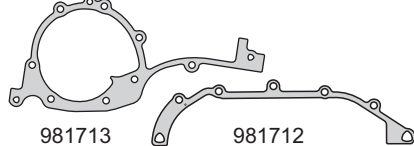
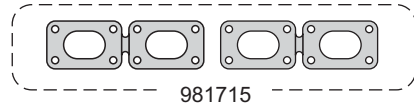
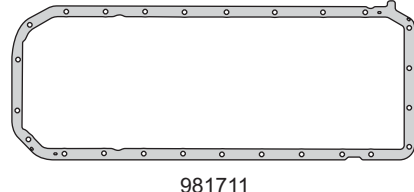
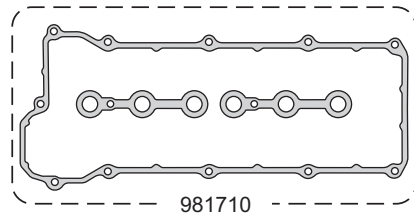
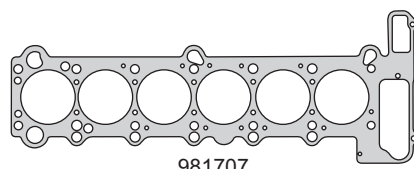

**BMW**



Motor/Engine	Cm³	HP	Ø
M52 (256S3/S4)	2494	163/170	84
M52 (256S1/S2) (DOHC) 24V	2793	193	84

**BMW:** 2.5 323i, 523i 1995/99, 323 ti 1999/00  
2.8 328i 1995/99, 528i 1995/00  
728i 1995/01, Z3 Coupe 1998/00  
Z3 Roaster 1996/00



Nº OE	Descripción/Description	Mat.	Ref.
11121427826	Jgo. de juntas para motor		981900-R
	Jgo. de juntas superior		981995
11121726623	Junta tapa cilindros Ø 85.0 ± 1.74	NFT	1 1 981707
	Junta tapa cilindros Ø 85.0 ± 2.00	NFT	981707-2.0
	Jgo. tornillos tapa cilindros (HAE12038)		B981900
11121738701	Conj. junta tapa válvula (3)	GS	1 1 981910
11131720519	Junta para cárter	AC/GS	1 981711
11141720639	Tapa distribución inferior izquierda	SLS	1 981713
11361740840	Junta cárter distribución	SLS	1 1 981712
11621744252	Jgo. múltiple escape (2)	AC	1 1 981915
11611740069	Jgo. múltiple admisión (2)	GS	1 1 981917
	Salida de escape	NFT	2 2 981718
11531740437	Junta de la carcasa del termostato	GS	1 1 981719
	Guarnición termostato	GS	1 1 981919
11421719855	Junta filtro de aceite	GS	1 981727
-	Porta retén bancada trasero	SLS	1 981729
11411703947	Junta tubo de aceite	NB	1 981730
100115360013	Junta valvula EGR	GFT	2 2 981931
11611716174	Válvula aceleradora G 73 x 79 x 11	GS	1 1 981732
	Brida de agua	NB	1 1 981737
	Junta brida	GFT	1 1 981943
	Arandela A 10.5 x 16 x 1.5 A	AL	1 2
	Arandela A 12.5 x 16 x 1.5 A	AL	3 3
	Arandela A 14 x 18 x 1.5 A	AL	2 2
	Arandela A 15 x 20 x 1.5 A	AL	4 6
	Arandela A 26.5 x 31 x 1.5 A	AL	1 1
	O´ring G 4.47 x 1.78	GS	1 2
	O´ring G 7.52 x 3.53	GS	12 12
	O´ring G 9.12 x 3.53	GS	1 1
	O´ring G 9.19 x 2.62	GS	2
	O´ring G 15.6 x 1.78	GS	1
	O´ring G 15.47 x 3.53	GS	1 1
	O´ring G 15.54 x 2.62	GS	1
	O´ring G 18.72 x 2.62	GS	2 2
	O´ring G 40.87 x 3.53	GS	1
	O´ring G 56.82 x 2.62	GS	1 1
	O´ring G 69.22 x 5.33	GS	1
	O´ring G 88.49 x 3.53	GS	1
	Kit de retenes completo		R981700
6060500058	Jgo. reten válvulas (24)	V	1 1 R981710V
11142245364	Retén bancada trasera 90 x 110 x 12	V	1 R981111V
11141274346	Retén distribución 48 x 65 x 10	V	1 R981113V

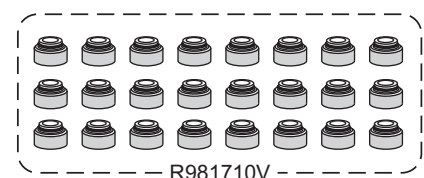
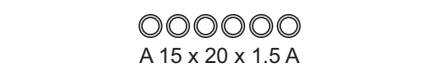
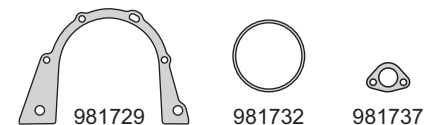
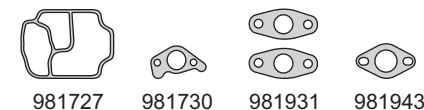
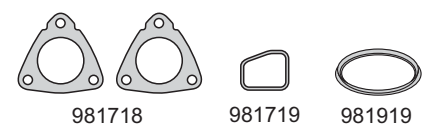
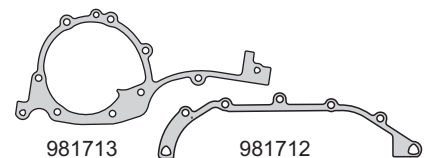
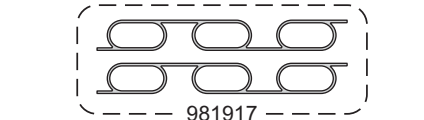
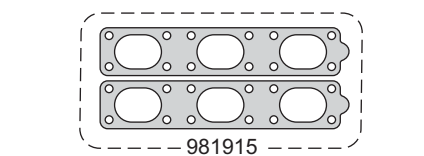
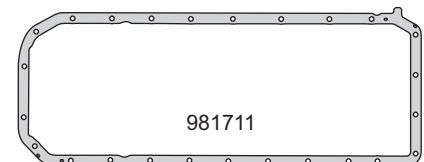
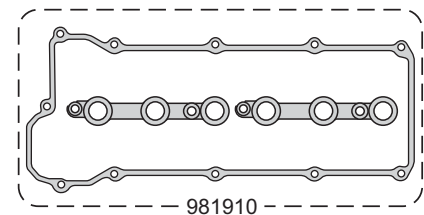
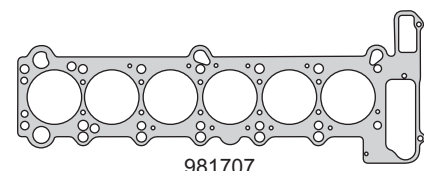

**BMW**



Motor/Engine	Cm <sup>3</sup>	HP	Ø
N42B18A	1796	115/116	84
N40B16A	1796	115/116	84
N42B20A	1995	143/150	84
N46B20A/B20C (VALVETRONIC) (DOHC) 16V	1995	143/150	84

**BMW:** 316i, 316 ci Coupe, 316 ti 2000/...  
318 ti, 318 ci Cabrio, Coupe 2000/...  
320 is 2001/..., 318 ci Cabrio, Coupe  
318ti, X3i 2003/..., Z4i 2004/...



Nº OE	Descripción/Description	Mat.	Ref.
	<b>Jgo. de juntas para motor</b>		● 982000-R MLS
	<b>Junta tapa cilindros Ø 84.5 ± 0.45</b>	MLS	1 982008
	<b>Jgo. tornillos tapa cilindros</b> (HAE10038/12038)		B982000
	Junta tapa de válvulas	GS	1 982010
	Junta para cárter	AL/GS	1 982011
	Junta distribución	GS	1 982012
	Múltiple escape	AC	1 982015
	Jgo. múltiple admisión (4)	GS	1 982017
	Salida de escape	GFT	1 982018
	Junta termostato	GS	1 982019
	Junta bomba de nafta	AL	1 982027
	Junta bomba de nafta	PLAST	1 982028
	Guarnición goma	GS	1 982029
	Guarnición goma	GS	1 982030
	Guarnición base filtro	GS	1 982031
	Guarnición válvula mariposa	GS	1 982032
	Guarnición válvula IAC	GS	1 982033
	Guarnición goma	GS	1 982034
	Guarnición goma	GS	1 982035
	Guarnición base inyector	GS	4 982042
	Guarnición goma	GS	2 982043
	Guarnición entrada de aire	GS	1 982045
	Anillo G 17.5 x 25 x 4.6	GS	3
	O´ring G 30 x 3.53	GS	2
	O´ring G 22 x 3.10	GS	1
	O´ring G 15.9 x 3.20	GS	1
	O´ring G 18 x 3.05	GS	3
	O´ring G 8.8 x 3.05	GS	1
	O´ring G 24.5 x 2.45	GS	4
	O´ring G 7.5 x 3.45	GS	8
	O´ring G 20.5 x 2.50	GS	1
	O´ring G 21.5 x 2.20	GS	2
	O´ring G 24 x 2.90	GS	1
	O´ring G 29.5 x 3.30	GS	4
	O´ring G 31.8 x 4.20	GS	2
	O´ring G 55 x 2.40	GS	1
	Arandela A 13.8 x 18 x 1 A	AL	1
	Arandela A 12.4 x 15.6 x 1 A	AL	1
	Arandela A 22.2 x 27 x 1.5 C	CU	2
	Kit de retenes completo		R982000
	Jgo. retén válvulas (16)	V	1 R982010V
	Retén bancada 90 x 110 x 12	V	1 R982011V
	Retén distribución 65 x 79 x 20	V	1 R982012V

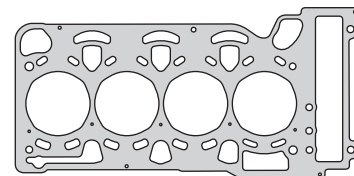

982008

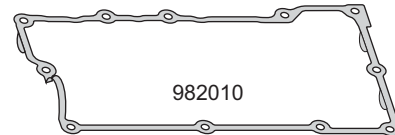

982010

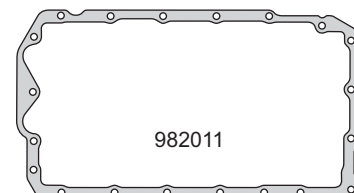

982011

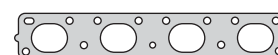

982015



982017

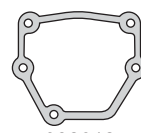

982012



982019



982018



982027



982028



982029



982030



982031



982032



982033



982034



982035



982042



982045



982043



G 22 x 3.10



G 17.5 x 25 x 4.6



G 18 x 3.05



G 8.8 x 3.05



G 24.5 x 2.45



15.9 x 3.20



G 30 x 3.53



G 20.5 x 2.50



G 21.5 x 2.20



G 24 x 2.90



G 29.5 x 3.30



G 31.8 x 4.20



G 7.5 x 3.45



G 7.5 x 3.45



G 7.5 x 3.45



G 7.5 x 3.45



R982011V



R982012V

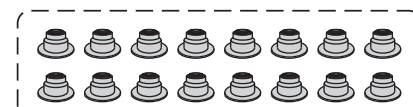

R982010V

# CHEVROLET / GM / OPEL / VAUXHALL

## JUNTA TAPA DE CILINDROS / HEAD GASKETS

### MOTORES NAFTA Y DIESEL / PETROL AND DIESEL ENGINES

	Código Code	Q	≠	Kit Bulón Bolt Set	Aplicación Application	Motor Engine	Juego
	<b>200005</b>	102.6	1.40	B200000	400 1964/72 Super 1964/69, RS Malibu Pick Up Chevy 1969/79	<b>3185cc.</b> 194 Ø90.48 <b>3769cc.</b> 230 Ø98.43 <b>4047cc.</b> 250 Ø98.43	<b>200000-R</b> 🚗 pág. 23
	<b>200205</b>	96.0	1.40		Opel K180 1974/79	<b>1790cc.</b> K180 Ø90.49	<b>200200-R</b> 🚗 pág. 24
	<b>200305 - 200307</b>	103.0 103.0	1.40 1.40	B200000	Pick Up C10 1989/...	<b>4097cc.</b> 250 Ø98.47	<b>200300-R</b> 🚗 pág. 25
	<b>200405</b>	95.0	1.70		Apache C10 3.9/16, Camión 4400 1957/... Bel Air, Impala 1953/62	<b>3851cc.</b> 235 130HP Ø90.48	<b>200400-R</b> 🚗 pág. 26
	<b>200507</b>	102.0	1.40	B200000	Silverado, Pick Up 7B 1980/... Cheyenne 1979/81	<b>4097cc.</b> 250 Ø98.43	<b>200500</b> 🚗 pág. 27
	<b>200605</b>	98.5	1.70		Camión 3 3/4 6500 1954/62, C10 C 14, C60 BR 1969/...	<b>4277cc.</b> 261 142HP Ø95.25	<b>200600-R</b> 🚗 pág. 28
	<b>200805</b>	84.0	1.40		Chevette 1973/89	<b>1393cc.</b> GMC 85 45HP Ø82 <b>1599cc.</b> GMC 98 71HP Ø82	<b>200800-R</b> 🚗 pág. 29
	<b>200905</b>	94.0	1.40		Chevrolet 3 1/2 - Chevrolet 3 9/16 1939/53	<b>3540cc.</b> 216 - 224 - 235 Ø88.9 <b>3674cc.</b> 216 - 224 - 235 Ø90.5	<b>200900</b> 🚗 pág. 30
	<b>240005</b>	86.2	1.40	B240000 HAT55055 HAT55100	Monza 1.8 SLE/SEE, Kadett, Rekord 1983/... Monza - Kadett 1986/91, Astra 1991/97 Vectra 1989/95	<b>1796cc.</b> C18N S/E 75/90HP Ø84.8 <b>1796cc.</b> C18NE/NV - C18NZ 90HP Ø84.5	<b>240000-R</b> 🚗 pág. 31 <b>280000-R</b> 🚗 pág. 68
	<b>240105</b>	104.2	1.40		Opala 153 1969/73 Opala A10 80/84/610 1976/... Opala, C10, A10 1974/..., Comodoro Caravan, A10 1980/84	<b>2475cc.</b> GM 153 Ø101.6 <b>2475cc.</b> GM151 90HP Ø101.6	<b>240100</b> 🚗 pág. 32 <b>240800</b> 🚗 pág. 37

# CHEVROLET / GM / OPEL / VAUXHALL

## JUNTA TAPA DE CILINDROS / HEAD GASKETS

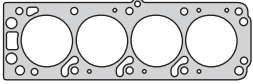
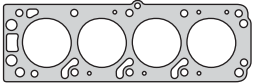
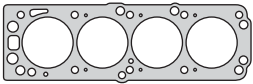
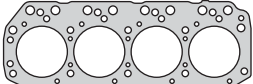
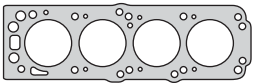
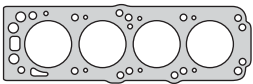
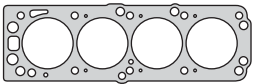
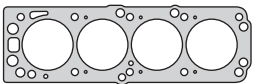
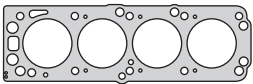
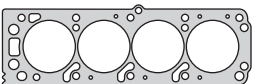

### MOTORES NAFTA Y DIESEL / PETROL AND DIESEL ENGINES

	Código Code	Q	≠	Kit Bulón Bolt Set	Aplicación Application	Motor Engine	Juego
	<b>240205 - 240207</b> 240205 240207	88.0 88.0	1.40 1.40	<b>B240000</b> HAT55055 HAT55100	Monza 1996/..., Astra 1991/..., Kadett 1986/91, Ascona 1986/88, Vectra 1988/95, Blazer  Astra MPFI 1999/...	<b>1796cc.</b> C18NE FII 90HP Ø84.8 <b>1998cc.</b> C20NE 115/130HP Ø86  <b>1796cc.</b> MPFI 8V 110HP Ø84.8	<b>240200-R</b> 🚗 pág. 33  <b>291200-R</b> 🚗 pág. 103
	<b>240305</b> 240305	81.5	1.40	<b>B240000</b> HAT55055 HAT55100	Monza, Kadett 1981/86	<b>1598cc.</b> CN16 - 16SH 90HP Ø80.3	<b>240300-R</b> 🚗 pág. 34
	<b>240405 - 240407</b> 240405 240407	80.5 80.5	1.40 1.40	<b>B240400</b> <b>B240400-1</b> HAE12038	Corsa 1.4 EFI Corsa 1.6 MPFI, Ascona C 1986/88, Astra, Vectra A 1991/97, Corsa A GSI, Nova 1987/93, Kadett E 1986/91  GM Corsa, Vectra, Kadett 1999/...	<b>1389cc.</b> C14 NV/NZ 60/75HP <b>1598cc.</b> C16LZ/NZ/SV E16ASE 75/82HP - X16SZ 71HP 16NZ/SV 75/82HP Ø79  <b>1598cc.</b> C1.6SE - X16 SZR 75/100HP	<b>240400-R</b> 🚗 pág. 35  <b>242300-R</b> 🚗 pág. 52
	<b>240707 - 240708</b> 240707-1M 240707-2M 240707-3M 240708 240708-2M 240708-3M	94.0 94.0 94.0 94.0 94.0 94.0	1.50 1.60 1.70 1.51 1.63 1.70	<b>B240700</b> HAS17038	Pick Up Luv Trooper, Trooper TD 1988/92  <b>DIESEL</b>	<b>2499cc.</b> 4JA1 76HP Ø93 4JB1 - 4JB1T 87 /102 HP Ø93	<b>240700-R</b> 🚗 pág. 36
	<b>240905 - 240907 - 240908</b> 240905 240907 240908	73.5 73.5 74.0	1.40 1.40 1.40	<b>B240400</b> <b>B280600</b> HAE12038	Corsa 1.0 EFI, B10 NZ 1994/... Corsa B 1993/97  Celta 2000/..., Fun 2002/...	<b>996cc.</b> OHC 60HP Ø71 <b>1196cc.</b> C12NZ/12NZ/X12SZ 45HP Ø72  <b>999cc.</b> MPFI (SOHC) 8V 60HP Ø71.1	<b>240900-R</b> 🚗 pág. 38  <b>241200-R</b> 🚗 pág. 41
	<b>240905 - 240907 - 240908</b> 240905 240907 240908	73.5 73.5 74.0	1.40 1.40 1.40	<b>B240400-1</b> <b>B242200</b> HAE12038	Celta, Classic, Corsa 2003/...  Prisma, Onix	<b>999cc.</b> MPFI VHC 60HP Ø71.1  <b>999cc.</b> SPE/4 80HP Ø71,1	<b>243300-R MLS</b> 🚗 pág. 57  <b>244200-R MLS</b> 🚗 pág. 62
	<b>241005 - 241007 - 241008</b> 241005 241007 241007-1.80 241008	79.0 79.0 79.0 79.0	1.70 1.20 1.80 1.50	<b>B240400</b> <b>B240400-1</b> HAE12038	Celta MPFI 2004/...  Corsa A 1990/93, Kadett E 1986/91 Nova 1985/...	<b>1389cc.</b> C14E Familia I 85HP Ø77.6  <b>1196cc.</b> 12NV - 12ST 54/55HP Ø77.8	<b>241000-R</b> 🚗 pág. 39  <b>241100-R</b> 🚗 pág. 40
	<b>241005 - 241007 - 241008</b> 241005 241007 241007-1.80 241008	79.0 79.0 79.0 79.0	1.70 1.20 1.80 1.50	<b>B244000</b> <b>B242200</b> HAE12038 HAS13038	Corsa 1.4 Econoflex, Classic, Agile, Celta 2006/2009 - 2009/...  Prisma, Onix	<b>1389cc.</b> X14SE/Y14NE - MPFI (SOHC) 8V 90/92HP Ø77,65  <b>1389cc.</b> SPE/4 106HP Ø77,6	<b>244000-R</b> 🚗 pág. 60  <b>244300-R</b> 🚗 pág. 63
	<b>241307</b> 241307	77.0	1.30	<b>B240400</b> HAE12038	Kadett D, Kadett E 1979/86 Cavalier, Astra 1980/85	<b>1297cc.</b> 13N/S - 13NS/SB/SC 60/70/75HP Ø75	<b>241300-R</b> 🚗 pág. 42
	<b>241507</b> 241507	87.5	1.30	<b>B240000</b> HAT55055 HAT55100	Omega MPFI, Vectra MPFI 1992/98 Frontera 1991/95, Calibra, Cavalier, Kadett 1986/91, Astra 1991/96 Omega A 1986/94	<b>1998cc.</b> OHC - C20NE/SEH/SER/NEF 100/115/130HP Ø86 (SOHC) 8V	<b>241500-R</b> 🚗 pág. 44

# CHEVROLET / GM / OPEL / VAUXHALL

## JUNTA TAPA DE CILINDROS / HEAD GASKETS

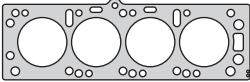
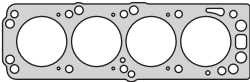
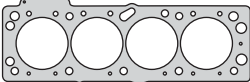
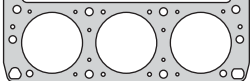
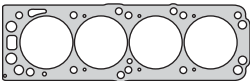
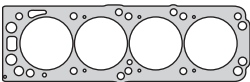
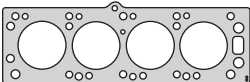
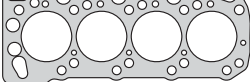

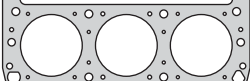
### MOTORES NAFTA Y DIESEL / PETROL AND DIESEL ENGINES

	Código Code	Q	≠	Kit Bulón Bolt Set	Aplicación Application	Motor Engine	Juego
<b>241607</b> 	241607-SM 241607-1M 241607-2M	84.0 84.0 84.0	1.30 1.40 1.50	B241700 HAT55055 HAT55100	Astra 1991/94, Vectra A 1989/95 Astra Max 1990/..., Belmont 1989/91 DIESEL	1699cc. 17D/DR 57/60HP Ø82.5 (SOHC) 8V	241601-R pág. 45
<b>241707</b> 	241707-SM 241707-1M 241707-2M	84.0 84.0 84.0	1.30 1.40 1.50	B241700 HAT55055 HAT55100	Astra TD, Astra F TD 1994/97 DIESEL	1700cc. 17DTL 68HP Ø82.5	241701-R pág. 46
<b>241807 - 241808</b> 	241807 241808	82.0 82.0	1.20 0.35	B280600 HAE12038	Corsa II, Meriva 2003/...	1781cc. L79 (DOHC) 16V 122HP 80.5	241800-R MLS pág. 47
<b>241905</b> 	241905	91.5	1.70		Cutlass, Century, Eurosport, Cavalier 1989/94	2800cc. 3100cc. 172 V6 2da. Generación Cabeza de Aluminio	241900-R pág. 48
<b>242205 - 242207 - 242208</b> 	242205 242207 242208	82.0 82.0 82.0	1.40 1.40 1.40	B242200 B244000 HAE12038 HAS13038	Corsa, Meriva 2003 Spin, Cobalt 2017/...	1796cc. GM Powertrain 102HP Ø80.5 1796cc. SPE/4 111HP Ø80,5	242200-R pág. 51 244500-R MLS pág. 65
<b>242205 - 242207 - 242208</b> 	242205 242207 242208	82.0 82.0 82.0	1.40 1.40 1.40		Spin, Cobalt 2012/...	1796cc. N18XFN 108HP Ø80,5	244100-R MLS pág. 61
<b>242407</b> 	242407-SM 242407-1M 242407-2M	82.0 82.0 82.0	1.30 1.40 1.50	B241700 HAT55055 HAT55100	Kadett D, Kadett E 1984/86, Ascona C Kadett E 1986/89, Ascona C Belmont, Cavalier 1982/86 DIESEL	1598cc. 16D 54HP - 16DA 60HP Ø80	
<b>242507 - 242508</b> 	242507-SM 242507-1M 242507-2M 242508-SM 242508-1M 242508-2M	80.0 80.0 80.0 80.0 80.0 80.0	1.40 1.50 1.60 1.40 1.50 1.60	B280200 HAH10055 HAH10140	Corsa, Astra G DTI, Corsa C DI Combo Tour TD 2000/... DIESEL	1686cc. Y17 DT/DTL Iny. Directa 65/75HP Ø79 (DOHC) 16V	242501-R pág. 53
<b>242607</b> 	242607-SM 242607-1M 242607-2M	77.0 77.0 77.0	1.40 1.50 1.60	B280200 HAH10055 HAH10140	Corsa A D/TD 1987/92, Nova 1991/96 Kadett E TD 1984/91 Isuzu I- Mark 1987/... Gemini 1987/..., I-Mark, Gemini TD 1988/... DIESEL	1488cc. 15D(4EC1) - 15TD(4TEC1I) 50/67/72HP 4EC1- T4EC1 50/76HP Ø76	
<b>242805</b> 	242805	92.5	1.20		Citation, Celebrity, Century 1982/86	2800cc. 172 V6 Carburados	242800-R pág. 55

# CHEVROLET / GM / OPEL / VAUXHALL

## JUNTA TAPA DE CILINDROS / HEAD GASKETS

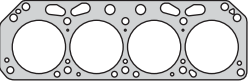
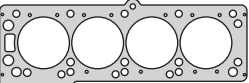
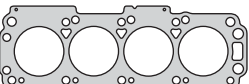
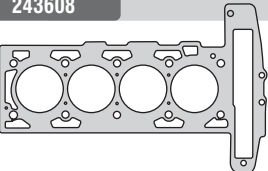
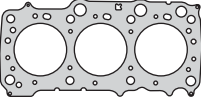
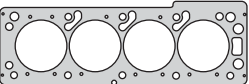
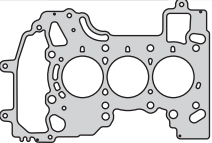
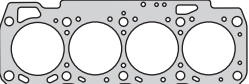
### MOTORES NAFTA Y DIESEL / PETROL AND DIESEL ENGINES





	Código Code	Q	≠	Kit Bulón Bolt Set	Aplicación Application	Motor Engine	Juego
	<b>242905</b>	103.0	1.20		Pontiac Vin E 1988/92	<b>2500cc.</b> L4 - 151	<b>242900-R</b> 🚗 pág. 56
	<b>243407 - 243408</b>	89.0	1.20	<b>B280700</b> HAT55055 HAT55100	Astra 2004/..., S10 2005/... Vectra 2006/...	<b>2405cc.</b> Powertrain 147HP Ø87.5	<b>243400-R MLS</b> 🚗 pág. 58
	<b>243508</b>	84.0	1.30	<b>B241700</b> HAT55055 HAT55100	Astra TD 1994/97, Astra GTD 1998/00 Motor 14555260 08/1994	<b>1699cc.</b> X17 DTL 68HP Ø82.5 (SOHC) 8V (SOHC) 8V	<b>243501-R</b> 🚗 pág. 59
	<b>243608</b>	87.0	0.52	<b>B243600</b> HAS15038	Pontiac 2002/...	<b>2198cc.</b> Z22YH 155HP Ø86 (DOHC) 16V	
	<b>243908</b>	88.5	1.10	<b>B243900</b> HAD14038	Vectra C DTI, Signum C DTI 2003/08 - 2005/09	<b>2958cc.</b> Y30DT 177HP Z30DT 184HP (DOHC) V6 24V Ø87.5	
	<b>244407</b>	88.0	1.40		Blazer, S10	<b>2405cc.</b> C24SE 147HP Ø87.5 (SOHC) 8V	<b>244400-R</b> 🚗 pág. 64
	<b>244607 - 244608</b>	76.5	1.20	<b>B244600</b>	Onix 2020/...  Onix, Tracker 2020/...	<b>999cc.</b> Ecotec 1.0 12V 82HP Ø74  <b>999cc.</b> Ecotec 1.0 12V 116HP Ø74	<b>244600-R MLS</b> 🚗 pág. 66  <b>244700-R MLS</b> 🚗 pág. 67
	<b>252608</b>	83.0	0.80	<b>B252600</b> HAR14063	Astra, Vectra 2004/..., Zafira 2005/...	<b>1910cc.</b> Z19DTH 143/150HP Ø82 (DOHC) 16V	
	<b>280105</b>	105.0	1.20		283/302/307/327 Carburador, 327, 350 No Corvette, 350, Camiónes 1967/... 350 1986/93 No Corvette, Pick Up, Camiónes 350 1986/95 Truck 1996/01, Vortec Vin R	<b>5735cc.</b> GM C350 V8 Ø101.6  <b>5735cc.</b> C350L V8 Ø101.6  <b>5735cc.</b> C350 V8 Ø101.6	<b>280100-R</b> 🚗 pág. 69  <b>280800-R</b> 🚗 pág. 76  <b>281100-R</b> 🚗 pág. 77
	<b>280207 - 280208</b>	81.0	1.40	<b>B280200</b> HAH10055 HAH10140	Corsa D, Combo D 1997/... Vectra TD 1991/96, Astra TD 1994/97	<b>1686cc.</b> 4EE1 - 4EE1T 60/82HP Ø79	<b>280201-R</b> 🚗 pág. 70

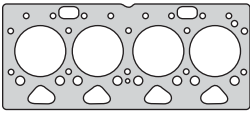

# CHEVROLET / GM / OPEL / VAUXHALL

## JUNTA TAPA DE CILINDROS / HEAD GASKETS

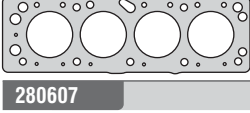
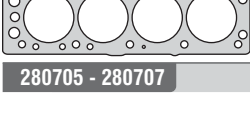
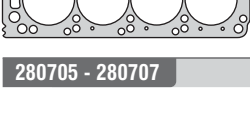
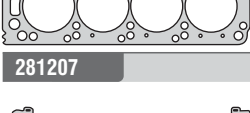
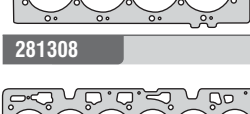
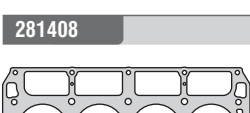
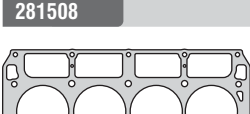
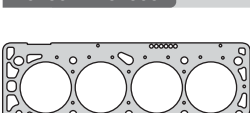





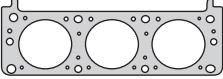
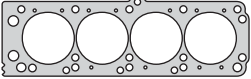
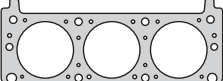

### MOTORES NAFTA Y DIESEL / PETROL AND DIESEL ENGINES

	Código Code	Q	≠	Kit Bulón Bolt Set	Aplicación Application	Motor Engine	Juego
	280307	105.0	1.80	B280300	D20/D40, Pick Up D20 DIESEL	3990cc. Maxion S4 102HP Ø100	280300-R pág. 71
	280407	91.0	1.70	B280400 HAH10055 HAH10140	Luv, Pick Up 1986/92 Luv, Pick Up, Trooper II 1986/95, Impulse Campo .../1992, Brava 1990/94	2254cc. 4ZD1 89/94HP Ø89.3 (SOHC) 8V	280400-R pág. 72
	280507	74.0	1.40	B280600 HAE12038	Corsa 1998/...	999cc. MPFI 68HP Ø71.1 (DOHC) 16V	280500-R pág. 73
	280607	80.5	1.30	B280600 HAE12038	Corsa, Opel, Tigra, Astra, Vectra 1993/...	1598cc. C16XE - C16XEL 109HP Ø79 (DOHC) 16V	280600-R pág. 74
	280705 280707	88.0 88.0	1.40 1.40	B280700 HAT55055 HAT55100	Astra 1995/..., Omega B, Calibra 1994/... Vectra, Astra, Calibra, Zafira 1994/..., Astra 1998/..., Vectra 1998/..., Sintra 1996/99	1998cc. X20XE 136HP Ø86 1998cc. X20 XEV 128/136HP Ø86 2198cc. X22 XE 139/141HP Ø86	280700-R pág. 75 290800-R pág. 99
	280705 280707	88.0 88.0	1.40 1.40	B280700 HAT55055 HAT55100	Vectra 1997/... S10, Blazer, Omega 1994/...	2000cc. MPFI (SOHC) 8V 116HP Ø86 2200cc. MPFI (SOHC) 8V 123HP Ø86 2198cc. MPFI/EFI (OHC) 8V 106HP Ø86	241400-R pág. 43 242000-R pág. 49
	281207	110.0	1.70		Silverado - GMC Sierra 2500/3500HD Suburban GMC Yukon XL Avalanche 2500 - Kodiak 2001/04	8123cc. L18 V8 550HP Ø108	281200-R pág. 78
	281308	94.0	0.70		Trail Blazer 2002/06	4160cc. Atlas LL8 - L6 275HP Ø94 (DOHC) 24V	281300-R MLS pág. 79
	281408	97.4	1.30		Vortec, Silverado, Sierra, Suburban, Tahoe Yukon 2001/03	4800cc. LY2 (OHV) 16V 295HP Ø96 5300cc. L59 (OHV) 16V 295HP Ø96	281400-R pág. 80
	281508	102.7	1.30		Vortec, Silverado, Sierra, Suburban Tahoe Yukon, Express Pick Up 2500/3500 2001/03	5967cc. LQ4 325HP Ø101.6	281500-R pág. 81
	281607 281608	82.0 81.5	1.30 0.50	B280600 HAE12038	Astra 2000/03	1796cc. Z18XE ECOTEC 120HP (DOHC) 16V Ø80.5	281600-R pág. 82

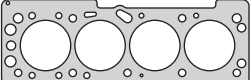
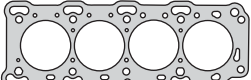
# CHEVROLET / GM / OPEL / VAUXHALL

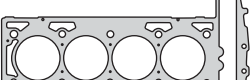
## JUNTA TAPA DE CILINDROS / HEAD GASKETS

### MOTORES NAFTA Y DIESEL / PETROL AND DIESEL ENGINES

	Código Code	Q	≠	Kit Bulón Bolt Set	Aplicación Application	Motor Engine	Juego
	281707	92.0	1.62		Malibu 2000/03 Malibu 1997/99	<b>3136cc.</b> LG8 (OHV) V6 8V 171HP Ø89  <b>3136cc.</b> LG8 (OHV) V6 12V 170HP Ø89	<b>281700-R</b> 🚗 pág. 83  <b>282200-R</b> 🚗 pág. 88
	281907	88.0	1.30		Astra 1995/98, Optra, Zafira 1998/...	<b>1998cc.</b> X20 XEV 128/136HP Ø86 (DOHC) 16V	<b>281900-R</b> 🚗 pág. 85
	282007	95.0	1.40		Venture, Impala, Monte Carlo, Alero Gran Am, Aztek, Silhouette, Trans Sport 2000/03 Venture 1997/99	<b>3350cc.</b> LA1 170HP Ø92 (OHV) V6 12V  <b>3350cc.</b> LA1 185HP Ø92 (OHV) V6 12V	<b>282000-R</b> 🚗 pág. 86  <b>282600-R</b> 🚗 pág. 92
	282108	87.0	0.50	<b>B243600</b> 🚗 HAS15038	Cavalier, Malibu, HHR, Astra, Zafira Vectra, Pontiac Sunfire Grand Am 2000/03	<b>2198cc.</b> Z22SE - L61 147HP Ø86 (DOHC) 16V	<b>282100-R</b> 🚗 pág. 87
	282307	79.0	1.70	<b>B280600</b> 🚗 HAE12038	Corssa 2002/04	<b>1389cc.</b> Z14XE - Ecotec 90HP Ø73.4 (DOHC) 16V	<b>282300-R</b> 🚗 pág. 89
	282407	91.0	1.30		Pontiac Sunfire, Grand Am, Malibu Cavalier Z24 1996/04, Alero 1999/...	<b>2393cc.</b> LD9 141/152HP Ø90 (DOHC) 16V	<b>282400-R</b> 🚗 pág. 90
	282507	70.0	1.40	<b>B282500</b>	Spark 2003/06, Aveo 2006/...	<b>995cc.</b> B10S 63HP Ø68.5 (SOHC) 8V	<b>282500-R</b> 🚗 pág. 91
	290007 290008	90.0 89.0	1.30 0.70	<b>B243600</b> 🚗 HAS15038	Captiva 2008/...	<b>2384cc.</b> LE5 174HP Ø88 (DOHC) 16V	<b>290000-R MLS</b> 🚗 pág. 93
	290107 290108	80.5 80.0	1.20 0.60	<b>B290100</b> 🚗 HAS13038	Nubira 2003/05 Aveo MPI (103HP) 2004/... Pontiac G3 2008/...	<b>1598cc.</b> F16 D3 103/109HP Ø79 (DOHC) 16V	<b>290100-R</b> 🚗 pág. 94
	290207	91.5	1.60		Lumina, Cavalier 1987/97 SS10 1997/99	<b>2190cc.</b> LN2 (OHV) 8V 120HP Ø89	<b>290200-R</b> 🚗 pág. 95
	290307	91.5	1.60		Lumina, Cavalier 1994/97 Cavalier 1998/03	<b>2190cc.</b> LM3 120HP Ø89  <b>2190cc.</b> LN2 120HP Ø89 (OHV) 8V	<b>290300-R</b> 🚗 pág. 96  <b>281800-R</b> 🚗 pág. 84

# CHEVROLET / GM / OPEL / VAUXHALL

## JUNTA TAPA DE CILINDROS / HEAD GASKETS

### MOTORES NAFTA Y DIESEL / PETROL AND DIESEL ENGINES

	Código Code	Q	≠	Kit Bulón Bolt Set	Aplicación Application	Motor Engine	Juego
	290407	92.0	1.60		Cavalier 1994/02	2200cc. C134	
	290605 290607	105.0 105.0	1.20 1.20		Capriche, Impala, Regal, Blazer MPFI 1996/98 Pick Up 1988/93 Pick Up 1986/92	4294cc. 262 V6 180/193HP Ø101.6 4300cc. 262 V6 4300cc. 262 TK V6 Ø101.6	290600-R 🚗 pág. 97 242100-R 🚗 pág. 50 242700-R 🚗 pág. 54
	290707-SM 290707-1M 290707-2M 290708-SM 290708-1M 290708-2M	86.0 86.0 86.0 86.0 86.0 86.0	1.20 1.30 1.40 1.20 1.30 1.40	B290700 HAE18038	Astra, Vectra, Omega, Zafira, Opel mega, Frontera, Sintra Vectra, Zafira, Omega, Frontera, Sintra DIESEL	1995cc. X20 DTL-DTH 82/100HP Ø84 2171cc. X22 DTH 115/116HP Ø84 (SOHC) 16V	290701-R 🚗 pág. 98
	290907	88.0	1.30	B290900 HAE14038	Vectra 1994/96, Calibra 1989/97 Kadett E 1987/91, Calibra Turbo 1992/97 Vectra Turbo 1993/95	1998cc. C20XE 136/150HP C20LET 16V 204HP (DOHC) 16V Ø86	290900 🚗 pág. 100
	291007 291008	82.0 82.0	1.20 1.60	B280600 HAE12038	Aveo 2009/... Astra H 2004/..., Signum, Vectra C 2006/..., Zafira B 2005/..., Insignia, Cruze 2008/...	1399cc. F14D4 101HP Ø73.4 1796cc. Z18XER - A18XER 141HP F18D4 141HP Ø80.5 (DOHC) 16V	291000-R MLS 🚗 pág. 101
	291107-1M 291107-2M 291107-3M 291108-1M 291108-2M 291108-3M	84.0 84.0 84.0 84.2 84.2 84.2	1.20 1.30 1.40 1.10 1.20 1.30	B291100 HAD14038	Epica, Optra 2006/11, Lacetti, Nubira Captiva, Tosca 2007/..., Cruze 2009/..., Antara 2006/10 DIESEL	1991cc. Z20S - Z20DMH 150HP Z20DM 121/126HP (SOHC) 16V Ø83	291101-R 🚗 pág. 102
	291307-1M 291307-2M 291307-3M 291308-1M 291308-2M 291308-3M	95.0 95.0 95.0 95.4 95.4 95.4	1.20 1.30 1.40 1.10 1.20 1.30	B291300 HAS17038	S10, Trail Blazer 2013/... DIESEL	2776cc. VM - CTDI 180HP Ø94	291301-R 🚗 pág. 104
	291407 291408	74.0 73.6	1.20 0.65		Aveo 2008/..., Aveo, Volt 2011/..., Cruze 2011/..., 2013/...	1362cc. LUV - ECOTEC 138/140HP 1398cc. LUV - ECOTEC 100/149HP (DOHC) 16V Ø73.4	291400-R MLS 🚗 pág. 105
	291608	90.0			Captiva 2010/18	2997cc. LF1, LFW 253HP Ø89 (DOHC) V6 24V	
	291707 291708	75.0 75.0	1.20 0.90		Cruze, Tracker, Astra 2017/..., Equinox 2020/...	1399cc. LE2 150HP Ø73,8 (DOHC) 16V	291700-R MLS 🚗 pág. 106

# CHEVROLET / GM / OPEL / VAUXHALL

## JUNTA TAPA DE CILINDROS / HEAD GASKETS

### MOTORES NAFTA Y DIESEL / PETROL AND DIESEL ENGINES

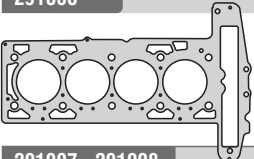
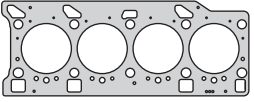
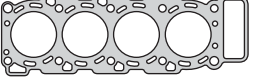
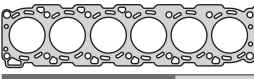
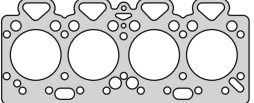
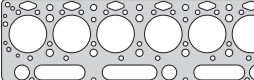
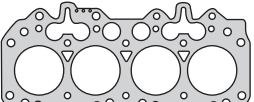
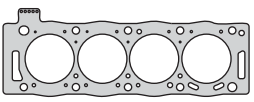
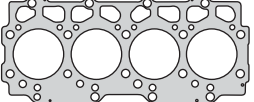
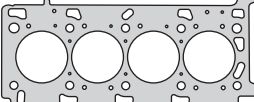
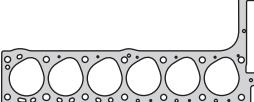
	Código Code	Q	≠	Kit Bulón Bolt Set	Aplicación Application	Motor Engine	Juego
	291808	87.0	0.60	B243600 HAS15038	Cobalt 2008/10, Astra 2012/...	1998cc. LNF Ecotec Turbo 253HP Ø86 (DOHC) 16V	291800-R MLS 🚗 pág. 107
	291907 - 291908	291907-1M 95.0 291907-2M 95.0 291907-3M 950 291908-1M 95.0 291908-2M 95.0 291908-3M 95.0	1.20 1.30 1.40 1.10 1.20 1.20	B291300 HAS17038	S10, Trail Blazer 2013/... DIESEL	2776cc. VM - CTDI 200HP Ø94	291301-R 🚗 pág. 108
	330507 - 330508	330507 96.0 330507-1.70 96.0 330508 96.0	1.40 1.70 1.40	B330500 HAS17038	S10 TD, Blazer TD 2000/... Blazer, S10 2000/... DIESEL	2796cc Sprint 4.07 CA 125HP Ø93 2796cc. Sprint 4.07 TCA Common Rail (SOHC) 12V 132HP Ø93	330500-R 🚗 pág. 370 331100-R MLS 🚗 pág. 372
	330607	330607 96.0 330607-1.70 96.0	1.40 1.70	B330600 HAS17038	GM Silverado 3500HD 1997/... Grand Blazer 1998/... DIESEL	4200cc. Sprint 6.07 TD 167HP Turbo Intercooler 198HP Ø93	330600-R 🚗 pág. 371
	410605 - 410607	410605 104.0 410607 104.0	1.70 1.70		GM D10/20/40 Aspirado Turbo Vehicular GM D20 DIESEL	3860cc. Q20B4.236 70HP Ø98.4 3860cc. Q20B4 70HP Ø98.4	410600-R 🚗 pág. 377 401000-R 🚗 pág. 375
	410907	410907 107.2	1.50		Brasil D60 - D70 DIESEL	5840cc. 6-357 Vehicular 120HP Agrícola 91HP Industrial 108HP Ø104.14	410900-R 🚗 pág. 379
	430007 - 430008	430007-1M 92.0 430007-2M 92.0 430007-3M 92.0 430007-4M 92.0 430008-1M 86.0 430008-2M 86.0 430008-3M 86.0	1.37 1.48 1.50 1.70 1.20 1.30 1.40	B430000 B430000-1 HAE14038	Blazer TDI, S10TDI 1995/... DIESEL	2507cc. 95HP Ø90.7	430001-R 🚗 pág. 365
	470807	470807-1M 86.0 470807-2M 86.0 470807-3M 86.0 470807-4M 86.0 470807-5M 86.0	1.30 1.35 1.40 1.45 1.50	B470800 HAE14038	Tracker 2001/04 DIESEL	1997cc. 108HP (SOHC) 8V Ø85	470801-R 🚗 pág. 435
	520307 - 520308	520307-SM 98.0 520307-1M 98.0 520307-2M 98.0 520308-SM 98.0 520308-1M 98.0 520308-2M 98.0	1.40 1.50 1.60 1.42 1.52 1.62	B520300 HAN12055 HAN12100	Frontera A TD 1995/98 DIESEL	2499cc. VM41B 115HP Ø92	520301-R 🚗 pág. 522
	582307 - 582308	582307 85.0 582308 85.0	1.20 0.80	B581800 HAE18038	Vivaro CDTI 2006/08 - 2008/... DIESEL	1995cc. M9R 780/782/784/786/788 90/114HP Ø84 (DOHC) 16V	582300-R MLS 🚗 pág. 512
	981207	981207-2M 81.0 981207-3M 81.0	1.68 1.87	B980200 HAE16038	Omega B TD 1994/96 DIESEL	2498cc. U25TD/X25TD 130HP Ø80	981201-R 🚗 pág. 08

# CHEVROLET



Motor/Engine	Cm³	HP	Ø
194	3185		90.48
230	3769		98.43
250	4047		98.43

**Chevrolet:** 400 1964/72  
Super 1964/69 - RS Malibu  
Pick Up Chevy 1969/79

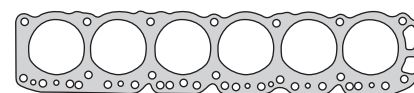

200005

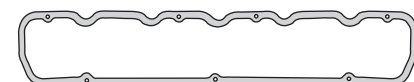

200010

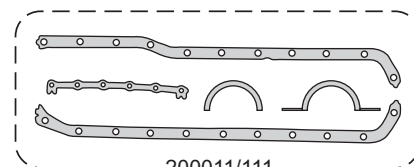

200011/111



200016



200036

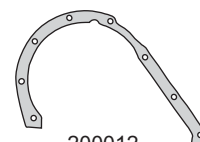

200012

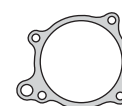

200014



300018

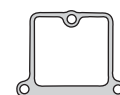

200017



200019



200025



200027



200028



200029



200030



200031



200035

A 13 x 20 x 2 C

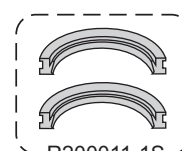

R200011-1S

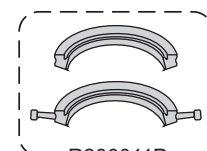

R200011P



R200011-2S



R200012P

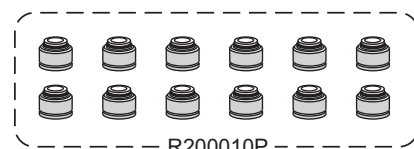

R200010P

Nº OE	Descripción/Description	Mat.	Ref.
	Jgo. de juntas para motor		200000-R
	Jgo. de juntas superior		200095
3788416	Junta tapa cilindros Ø 102.6 ±1.40	NFT	1 1 200005
	Jgo. de tornillos para tapa de cilindros		B200000
3828276	Junta tapa válvulas superior	CG	1 1 200010
3791198	Jgo. junta para cárter hasta 1967 (5)	CG	1 1 200011
5751118	Jgo. junta para cárter 1968/78 (5)	CG	1 1 200111
3788471	Tapa distribución	NB	1 1 200012
3788478	Bomba de agua	NB	1 1 200014
3788487	Múltiple admisión y escape	FCH	1 1 200015
3788487	Múltiple escape	NFT	1 1 200016
3788485	Múltiple admisión	NFT	1 1 200017
3696990	Salida de escape	FCH	1 1 200018
	Salida de escape	FCH	1 1 300018
3701777	Termostato	CB	1 1 200019
	Jgo. juntas carburador ZENITH - GALILEO	VS	1 1 200020
5749650	Jgo. juntas carburador HOLLEY R2751A	VS	1 1 200021
	Jgo. juntas carburador HOLLEY RX7214A	VS	1 1 200022
2017354	Jgo. juntas carburador ROCHESTER	VS	1 1 200023
3828267	Base carburador	NB	1 1 200025
3789970	Tapa bomba aceite	NB	1 1 200027
5752121	Base bomba nafta	CB	1 1 200028
	Acople bomba aceite	CB	1 1 200029
	Base bomba aceite	NB	1 1 200030
	Succión bomba aceite	NB	1 1 200031
2017354	Tapa diferencial DANA 44	CG	1 1 540034
3789161	Cubierta termostato	NB	1 1 200035
3788497	Tapa válvulas lateral	CG	1 2 200036
	Jgo. juntas caja velocidades importada	VS	1 1 200050
	Jgo. juntas caja velocidades FAE 1ra. Serie	VS	1 1 200051
	Jgo. juntas caja velocidades SAGINAW	VS	1 1 200151
	Jgo. juntas empaquetadura bancada	SLA	1 1 200058
	Diferencial autoblocante	CG	1 1 200059
3832420	Jgo. juntas para cárter 1968/78	CGT	1 1 200160
5751118	Tapa válvulas superior	CG	1 1 200061
3828276	Diferencial autoblocante	CG	1 1 200067
3832420	Tapa diferencial DANA 44	CG	1 1 540068
	Tapa diferencial DANA 44	NB	1 1 300086
	Jta. tapa cilindros competición (0.6)	NFT	1 1 200090-0.6
	Jta. tapa cilindros competición (0.8)	NFT	1 1 200090-0.8
	Jta. tapa cilindros competición (1.0)	NFT	1 1 200090-1.0
	Jta. tapa cilindros competición lámina	AC	1 1 200090L
	Jta. tapa cil. compet. (0.6) (boca redonda)	NFT	1 1 200091-0.6
	Jta. tapa cil. compet. (0.8) (boca redonda)	NFT	1 1 200091-0.8
	Jta. tapa cil. compet. (1.0) (boca redonda)	NFT	1 1 200091-1.0
	Jta. tapa cil. comp. lámina (boca redonda)	NFT	1 1 200091L
	Arandela tapón cárter A 13 x 20 x 2 C	CU	1 1
	Kit de retenes completo		1 R200000
	Jgo. retén válvulas (12)	P	1 R200010P
	Jgo. retén bancada (2 mitades) 230	P	1 R200011P
	Jgo. retén bancada (2 mitades) 250	S	1 R200011-1S
	Jgo. retén bancada reforma expansible	S	1 R200011-2S
	Retén distribución 44.47 x 61.19 x 9.57	P	1 R200012P

# CHEVROLET



Motor/Engine	Cm³	HP	Ø
K180	1790		90.49

Chevrolet: Opel K180 1974/79



Nº OE	Descripción/Description	Mat.	Ref.
	<b>Jgo. de juntas para motor</b>		<b>200200-R</b>
2637381	Junta tapa cilindros Ø 96.0 ± 1.40	NFT	1 200205
3873851	Junta tapa válvulas superior	CG	1 200210
	Jgo. junta para cárter (4)	CG	1 200211
3788471	Tapa distribución	NB	1 200012
3788478	Bomba de agua	NB	1 200014
2637660	Múltiple escape	NFT	1 200216
2637457	Múltiple admisión	NFT	1 200217
2638526	Salida de escape	FCH	1 200218
3701777	Termostato	CB	1 200019
	Jgo. juntas carburador	VS	200220
5753411	Base carburador	NB	1 200225
3789970	Tapa bomba aceite	NB	1 200027
5752121	Base bomba nafta	CB	1 200028
3789161	Cubierta termostato	NB	1 200035
3788549	Tapa válvulas lateral	CG	1 200236
	Jgo. juntas caja velocidades FAE	VS	200250
	Arandela tapón cárter A 13 x 20 x 2C	CU	
	Kit de retenes completo		R200200
	Jgo. retén válvulas (8)	P	1 R220110P
	Retén bancada (2 mitades)	P	R200011P
	Retén bancada (2 mitades)	S	R200011-1S
	Retén bancada extensible	S	1 R200011-2S
	Retén distribución 44.47 x 61.19 x 9.57	P	1 R200012P

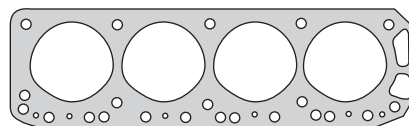

200205

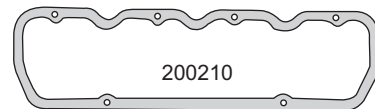

200210

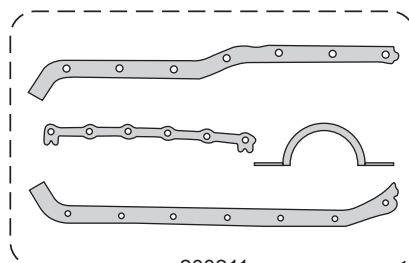

200211

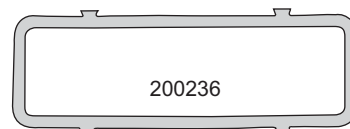

200236



200216

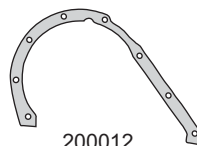

200012

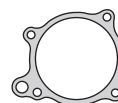

200014



200019



200218



200019



200225



200027



200028



A 13 x 20 x 2 C



200035

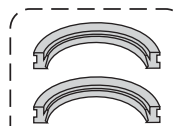

R200011-1S

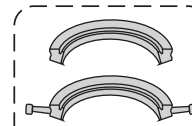

R200011P



R200011-2S



R200012P



R220110P

# CHEVROLET



Motor/Engine	Cm³	HP	Ø
250	4097		98.47

Chevrolet: Pick Up C10 1989/...



Nº OE	Descripción/Description	Mat.	Ref.
	Jgo. de juntas para motor		200300-R
	Junta tapa cilindros Ø 103.0 ± 1.40	NFT	1 200305
	Junta tapa cilindros Ø 103.0 ± 1.40	NFT	200307
	Jgo. de tornillos para tapa de cilindros		B200000
3828276	Junta tapa válvulas superior	CG	1 200010
	Jgo. junta para cárter (4)	CG	1 200311
	Tapa distribución	NB	1 200312
3788478	Bomba de agua	NB	1 200014
3788487	Múltiple escape	NFT	1 200016
3788485	Múltiple admisión	NFT	1 200017
3701777	Termostato	CB	1 200019
	Jgo. juntas carburador SOLEX TEIE	VS	200120
	Base carburador	NB	200325
	Base carburador SOLEX EIES	NB	2 300425
	Tapa bomba de aceite	NB	1 200027
5752121	Base bomba nafta	CB	1 200028
	Base distribuidor	NB	1 200329
2017354	Tapa diferencial DANA 44	CG	540034
3789161	Cubierta termostato	NB	1 200035
3788497	Tapa válvulas lateral	CG	2 200036
	Jgo. juntas caja velocidades FAE 1ra. Serie	VS	200051
	Jgo. empaquetadura bancada (2)	SNA	1 200658
3828276	Tapa válvulas superior	CG	200061
2017354	Tapa diferencial DANA 44	CG	540068
2017354	Tapa diferencial DANA 44	NB	300086
	Arandela tapón cárter A 13 x 20 x 2 C	CU	
	Kit de retenes completo		R200300
	Jgo. retén válvulas (12)	P	1 R200010P
	Jgo. retén válvulas (12)	N	1 R200610N
	Retén bancada (2 mitades)	S	R200011-1S
	Retén bancada reforma expansible	S	1 R200011-2S
	Retén bancada 112.5 x 130 x 11	P	R200311P
	Retén distribución 44.47 x 61.19 x 9.57	P	1 R200012P

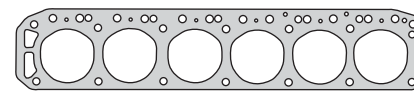

200305

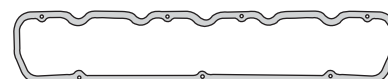

200010

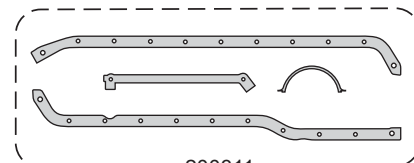

200311



200016



200036

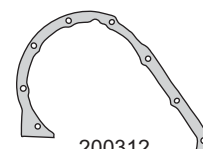

200312

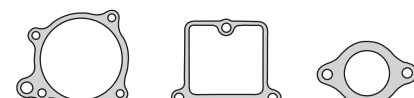

200014

200017

200019

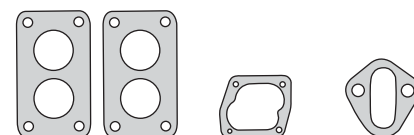

300425

200027

200028



200329

200658

200035

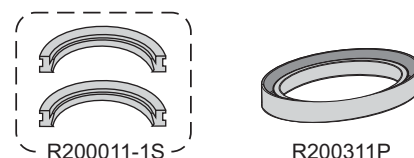

R200011-1S

R200311P



R200011-2S

R200012P

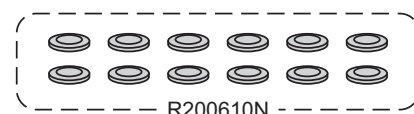

R200610N

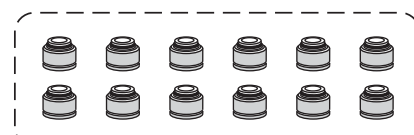

R200010P

# CHEVROLET



Motor/Engine	Cm³	HP	Ø
235	3851	130	90.48

**Chevrolet:** Apache C10 3.9/16  
Camión 4400 1957/...  
Bel Air, Impala 1953/62



Nº OE	Descripción/Description	Mat.	Ref.
7364640	Jgo. de juntas para motor		200400-R
3703179	Junta tapa cilindros Ø 95.0 ± 1.70	NFT 1	200405
3708648	Junta tapa válvulas superior	CG 1	200410
3714551	Jgo. junta para cárter (4)	CG 1	200411
838206	Tapa distribución	CG 1	200912
3835412	Placa distribución	NB 1	200413
3836162	Cuerpo bomba de agua	NB 1	200414
3694871	Jgo. múltiple admisión y escape (3)	NFT 1	200416
838290	Entre múltiples	NFT 1	200917
3696990	Salida de escape	FCH	200018
	Salida de escape	FCH 1	300018
	Jgo. juntas carburador	VS	200420
	Base carburador	NB 1	200425
601348	Base carburador	NB 1	200925
839166	Tapa bomba aceite	NB 1	200927
838263	Base bomba nafta	CB 1	200928
838297	Termostato	CB 1	200929
838341	Salida agua	CB 1	200930
839173	Asiento válvula distribución aceite	NB 1	200931
839174	Tapa distribución aceite	NB 1	200932
838210	Arandelas bujias	CG 6	200933
1523096	Vaso filtro nafta	CG 1	200934
3701542	Tapa válvulas lateral	CG 1	200436
	Jgo. empaquetadura cigüeñal (2)	SNA 1	200658
3714551	Jgo. juntas para cárter	CGT	200460
	Arandela tapón cárter A 13 x 20 x 2 A	AL	
	Kit de retenes completo		R200400
	Jgo. retén válvulas (12)	N 1	R200610N
	Retén distribución 44.47 x 61.19 x 9.57	P 1	R200012P

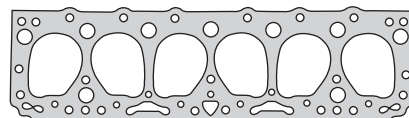

200405



200410

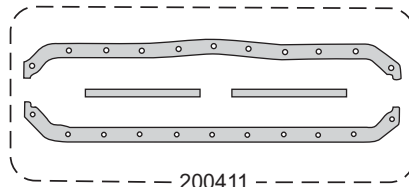

200411

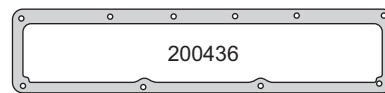

200414

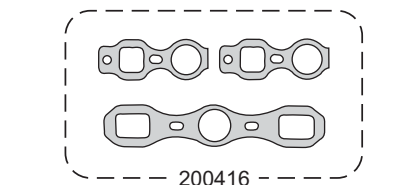

200416

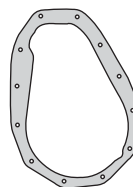

200912

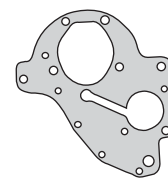

200413

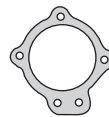

200931



200934



200917

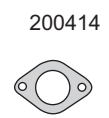

200414



300018



200917



200425



200925



200927



200928



200929

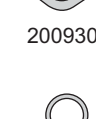

200930

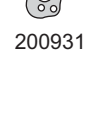

200931

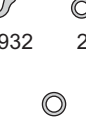

200932

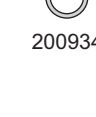

200933



200934

A 13 x 20 x 2 A

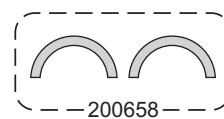

200658



R200012P

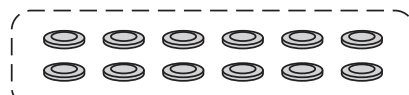

R200610N



# CHEVROLET



Motor/Engine	Cm³	HP	Ø
250	4097		98.43

**Chevrolet:** Silverado, Pick Up 7B 1980/...  
Cheyenne 1979/81

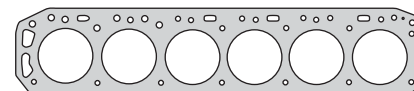

200507

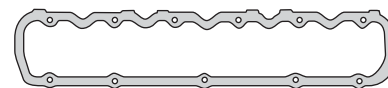

200510

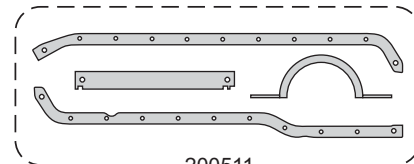

200511

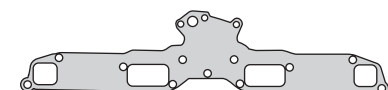

200515



200536

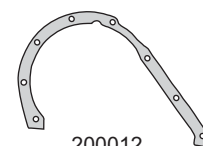

200012



200014



200018

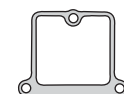

200017



200019

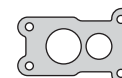

200525



200027



200028



200029



200030



200031



200035



A 13 x 20 x 2 C



R200311P



R200012P

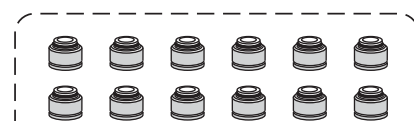

R200010P

Nº OE	Descripción/Description	Mat.	Ref.
	Jgo. de juntas para motor		200500
	Junta tapa cilindros Ø 102.0 ±1.40	NFT	1 200507
	Jgo. de tornillos para tapa de cilindros		B200000
	Junta tapa válvulas	CG	1 200510
	Jgo. junta para cárter (4)	CG	1 200511
	Tapa distribución	NB	1 200012
	Bomba de agua	NB	1 200014
	Múltiple admisión y escape	NFT	1 200515
	Junta entre múltiples	NFT	1 200017
	Salida de escape	FCH	1 200018
	Junta termostato	CB	1 200019
	Junta base carburador	NB	1 200525
	Junta tapa bomba aceite	NB	1 200027
	Junta tapa bomba nafta	CB	1 200028
	Junta acople bomba aceite	CB	1 200029
	Junta base bomba aceite	NB	1 200030
	Junta succión bomba de aceite	NB	1 200031
	Junta cubierta termostato	NB	1 200035
	Junta lateral válvulas	CG	2 200536
	Arandela tapón cárter A13 x 20 x 2 C	CU	1
	Jgo. retén válvulas (12)	P	R200010P
	Retén bancada 112.5 x 130 x 11	P	R200311P
	Retén distribución 44.47 x 61.19 x 9.57	P	R200012P

# CHEVROLET



Motor/Engine	Cm³	HP	Ø
261	4277	142	95.25

**Chevrolet:** Camión 3 3/4 6500 1954/62  
C10, C14, C60 BR 1969/...



Nº OE	Descripción/Description	Mat.	Ref.
	<b>Jgo. de juntas para motor</b>		<b>200600-R</b>
3750625	Junta tapa cilindros Ø 98.5 ± 1.70	NFT	1 200605
3708646	Junta tapa válvulas superior	CG	1 200410
3714551	Jgo. junta para cárter (4)	CG	1 200411
838206	Tapa distribución	CG	1 200912
3835412	Placa distribución	NB	1 200413
3836162	Cuerpo bomba de agua	NB	1 200414
3694871	Jgo. múltiple admisión y escape (3)	NFT	1 200416
838290	Entre múltiples	NFT	1 200917
3696990	Salida de escape	FCH	1 200018
	Base carburador	NB	1 200425
601348	Junta base carburador	NB	1 200925
839166	Tapa bomba aceite	NB	1 200927
838263	Bomba nafta	CB	1 200928
838297	Termostato	CB	1 200929
838341	Salida agua	CB	1 200930
839173	Asiento válvula distribución aceite	NB	1 200931
839174	Tapa distribución aceite	NB	1 200932
838210	Arandelas bujías	CG	6 200933
1523096	Vaso filtro nafta	CG	1 200934
3701542	Tapa válvulas lateral	CG	1 200436
	Jgo. empaquetadura cigüeñal (2)	SNA	1 200658
	Arandela tapón cárter A 13 x 20 x 2 A	AL	
	Kit de retenes completo		R200400
	Jgo. retén válvulas (12)	N	1 R200610N
	Retén distribución 44.47 x 61.19 x 9.57	P	1 R200012P

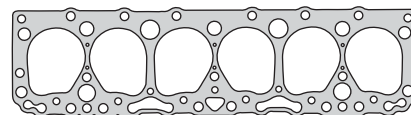

200605



200410

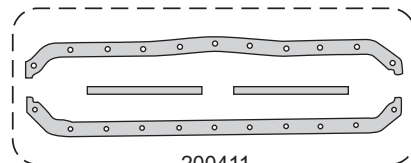

200411

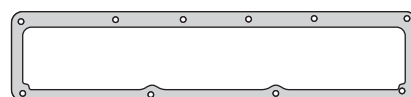

200436

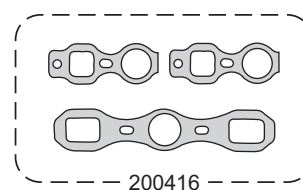

200416



200912



200018

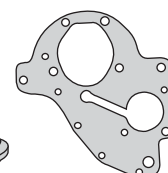

200413

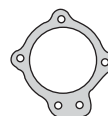

200414



200917



200425



200925



200927



200928

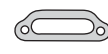

200929



200930



200931



200932



200933



200934

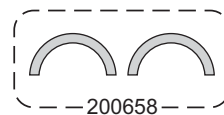

200658



R200012P

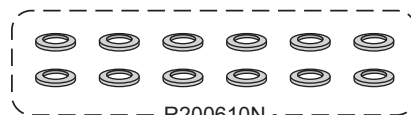

R200610N

# CHEVROLET



Motor/Engine	Cm³	HP	Ø
GMC 85	1393	45	82
GMC 98	1599	71	82

Chevrolet: Chevette 1973/89



Nº OE	Descripción/Description	Mat.	Ref.
7329442	Jgo. de juntas para motor		200800-R
	Jgo. de juntas superior		200895
94601825	Junta tapa de cilindros Ø 84.0 ± 1.40	NFT 1 1	200805
8966782	Junta tapa válvulas	CG 2 2	200810
8966813	Junta para cárter	CG 1	200811
8966792	Tapa distribución frontal motor	CG 1	200812
8966851	Bomba de agua	NB 1	200814
8966704	Múltiple escape	NFT 1 1	200816
8966825	Múltiple admisión	NB 1 1	200817
9308295	Salida de escape	FCH 1 1	200818
8966853	Base termostato	NB 1 1	200819
	Jgo. juntas carburador	VS	200820
8930191	Junta base carburador	NB 1 1	200725
8930353	Bomba nafta	NB 2	550628
8966783	Arandelas tapa válvulas A 8 x 14 x 1.5 F	F 4 4	200833
B4A6698A	Buje bomba aceite	GS 1	300234
8981886	Árbol de levas	CG 1	200835
8966812	Bomba aceite	NB 1	200837
8966864	Arandela termostato	NB 1	200838
105452	Arandela tapón cárter A 14 x 20 x 1.5 A	AL 1	200840
	Kit de retenes completo		R200800
	Jgo. retén válvulas (8)	CHEVROLET- 1	R200810P
	Retén bancada 75.9 x 95 x 11.3	P 1	R200811P
	Retén distribución 45 x 60 x 10	P 2	R450412P

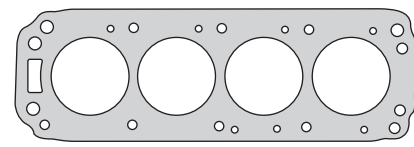

200805

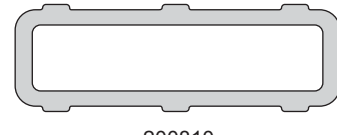
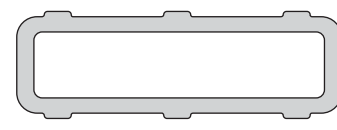

200810

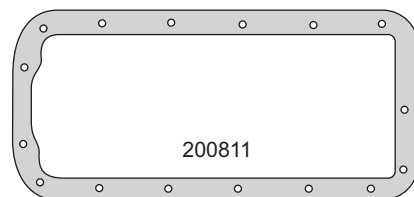

200811

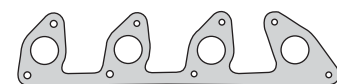

200816

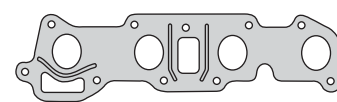

200817

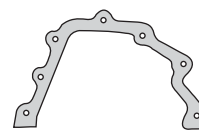

200812

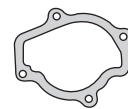

200814



200819



200818



200725



300234

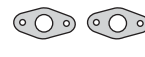

550628

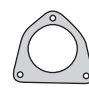

200835



200837



A 14 x 20 x 1.5 A



200838



A 8 x 14 x 1.5 F



R200811P



R450412P

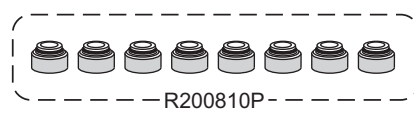

R200810P

# CHEVROLET



Motor/Engine	Cm <sup>3</sup>	HP	Ø
216 - 224 - 235	3540		88.9
216 - 224 - 235	3674		90.5

**Chevrolet:** Chevrolet 3 ½  
Chevrolet 3 9/16 1939/53



N° OE	Descripción/Description	Mat.	Ref.
	<b>Jgo. de juntas para motor</b>		<b>200900</b>
<b>3835465</b>	<b>Junta tapa cilindros Ø 94.0 ± 1.40</b>	<b>NFT 1</b>	<b>200905</b>
838337	Junta tapa válvulas superior	CG 1	200910
604338	Jgo. junta para cárter (4)	CG 1	200911
838206	Tapa distribución	CG 1	200912
839048	Placa distribución	CB 1	200913
839469	Tapa bomba de agua	CB 1	200914
602483	Jgo. múltiple admisión y escape (3)	NFT 1	200916
838290	Múltiple admisión	NFT 1	200917
3696990	Salida de escape	FCH 1	200018
839470	Placa bomba de agua	CB 1	200919
	Junta base carburador	VS	200920
	Jgo. juntas carburador	NB 1	200425
601348	Base carburador	NB 1	200925
839166	Tapa bomba aceite	NB 1	200927
838263	Bomba nafta	CB 1	200928
838297	Termostato	CB 1	200929
838341	Salida agua	CB 1	200930
839173	Asiento válvula distribución aceite	NB 1	200931
839174	Tapa distribución aceite	NB 1	200932
838210	Arandelas bujías	CG 6	200933
1523096	Vaso filtro nafta	CG 1	200934
602336	Tapa válvulas lateral	CG 1	200936
	Jgo. empaquetadura cigüeñal (2)	SNA 1	200158
	Arandela tapón cárter A 13 x 20 x 2 A	AL	
	Retén distribución 44.47 x 61.19 x 9.57	P	R200012P

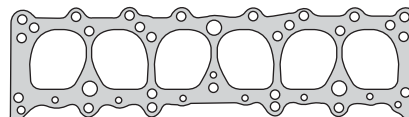

200905



200910

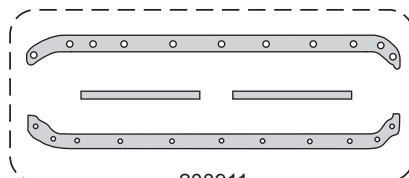

200911

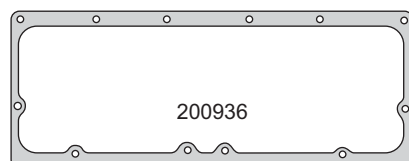

200936

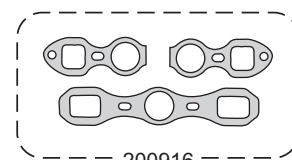

200916

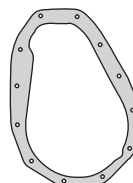

200912



200018

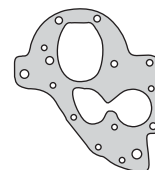

200913



200914



200917



200919



200425



200925



200927



200928



200929



200930



200931



200932



200933



200934



A 13 x 20 x 2 A

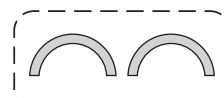

200158



R200012P

# CHEVROLET



Motor/Engine	Cm³	HP	Ø
C18N S/E	1796	75/90	84.8

**Chevrolet:** Monza 1.8 SLE - SEE Kadett, Rekord 1983/...



Nº OE	Descripción/Description	Mat.	Ref.
	Jgo. de juntas para motor		240000-R
	Jgo. de juntas superior		240095
90122951	Junta tapa cilindros Ø 86.2 ± 1.40	NFT	1 1 240005
	Jgo. tornillos tapa cilin. (HAT55055/55100)		B240000
90106506	Junta tapa válvulas	CG	1 1 240010
90106425	Junta para cárter	CG	1 1 240011
90106432	Bomba aceite y filtro a block	NB	1 1 240012
90106456	O'ring bomba de agua G 90 x 3	GS	1 1 240014
90106615	Múltiple escape	NFT	1 1 240016
90106610	Múltiple admisión	NB	1 1 240017
90128293	Salida de escape	FCH	1 1 240018
90118437	O'ring termostato G 50 x 4	GS	1 1 240019
94624122	Base carburador	NB	2 2 240025
94632563	O'ring bomba aceite succión G 16 x 2.5	GS	1 1 240027
9275602	Separador bomba agua	NB	2 2 550628
90122258	Nivel aceite	NB	1 1 240029
90128513	O'ring succión bomba aceite G 64 x 3	GS	1 1 240030
105462	Arandela frente cárter A 20 x 24 x 1.5 A	AL	1 1 240031
1169011	Arandela bomba aceite A14 x 20 x 1.5 A	AL	2 2 240032
	O'ring termostato G 47 x 4	GS	1 1
	O'ring G 64.77 x 2.62	GS	1 1
	Kit de retenes completo		R240300
	Jgo. retén válvulas (8)	V	1 R240010V
	Retén bancada 85.9 x 104 x 11	P	1 R240311P
	Retén distribución 31 x 50 x 8	P	1 R240012P
	Retén árbol levas 35 x 48 x 7	P	1 R240013P

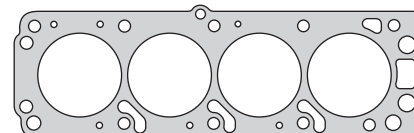

240005

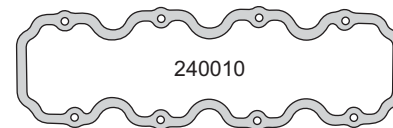

240010

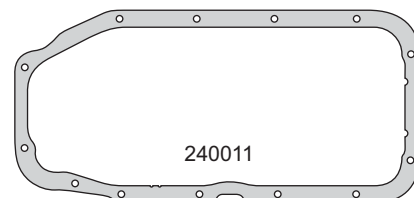

240011

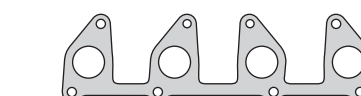

240012



240014



240016



240017

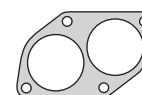

240018



240019



240025



240029



G 16 x 2.5



550628



G 64 x 3



G 64.77 x 2.62



G 47 x 4



A 14 x 20 x 1.5 A



A 20 x 24 x 1.5 A



R240311P



R240012P



R240013P

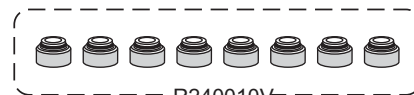

R240010V

# CHEVROLET



Motor/Engine	Cm³	HP	Ø
GM 153	2475		101.6

**Chevrolet:** Opala 153 1969/73  
Opala A10 80/84/610 1976/...



Nº OE	Descripción/Description	Mat.	Ref.
7322161	Jgo. de juntas para motor		240100
	Jgo. de juntas superior	●	240195
9298684	Junta tapa cilindros Ø 104.2 ± 1.40	NFT 1 1	240105
3873851	Junta tapa válvulas	CG 1 1	200210
7322169	Jgo. junta para cárter (4)	CG 1	240111
3923472	Tapa distribuidor	NB 1	200312
3788478	Tapa bomba de agua	NB 1	200014
7330252	Múltiple admisión y escape	NFT 1 1	240116
3788485	Entre múltiple	NFT 1 1	200017
9299824	Salida de escape	FCH 1 1	200018
3701777	Tapa termostato	CB 1 1	200019
7324660	Base carburador	NB	240125
7324660	Base carburador	NB 1	240825
3789970	Tapa bomba de aceite	NB	200327
838263	Base bomba nafta	CB	240128
	Base distribuidor	NB	200329
3789161	Cubierta termostato	NB 1 1	200035
3788549	Lateral junta tapa válvulas	CG	200236
3921989	Arandela tapón cárter A 13 x 20 x 1 F	F	240139
	Junta bomba termostato	NFT	240138
	Jgo. empaquetadura cigüeñal (2)	SNA	240158
	Jgo. retén válvulas (8)	N	R200410N
	Retén bancada 112.5 x 130 x 11	S	R200311P
	Retén distribución 44.47 x 61.19 x 9.57	P	R200012P

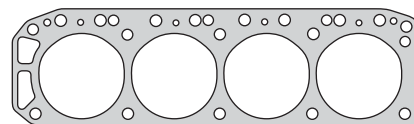

240105

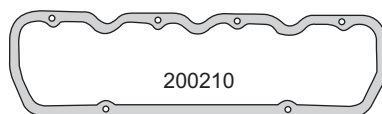

200210

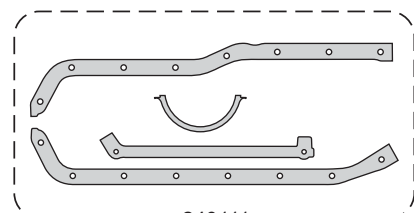

240111

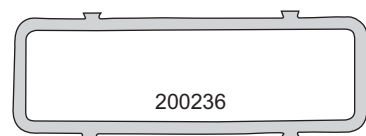

200236



240116

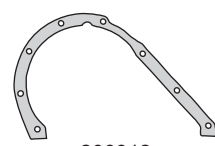

200312

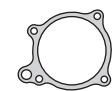

200014

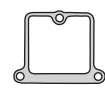

200017



200018



200019



240125



240825



200327



240128



200329



200035



240138

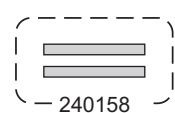

240158



A 13 x 20 x 1 F



R200311P



R200012P



R200410N

# CHEVROLET



Motor/Engine	Cm³	HP	Ø
C18NE FII	1796	90	84.8
C20NE	1998	115/130	86

**Chevrolet:** Monza 1996/..., Astra 1991/...  
Kadett 1986/91, Ascona 1986/88  
Vectra 1988/95, Blazer



Nº OE	Descripción/Description	Mat.	Ref.
	Jgo. de juntas para motor		240200-R
	Jgo. de juntas superior		240295
52272664	Jta. tapa cilindros Ø 88.0 ± 1.40	NFT 1 1	240205
	Jta. tapa cilindros Ø 88.0 ± 1.40 NR	NFT	240207
	Jgo. tornillos tapa cilin. (HAT55055/55100)		B240000
90220309	Junta tapa válvulas	CG 1 1	240010
90194295	Junta para cárter	N 1 1	240211
90106432	Block a filtro	NB 1 1	240012
90106456	O'ring tapa bomba de agua G 90 x 3	GS 1 1	240014
90106615	Múltiple escape	NFT 1 1	240016
90215011	Múltiple admisión	NB 1 1	240217
	Múltiple admisión inyección	NFT 1 1	240517
90128293	Salida de escape	FCH 1 1	240018
90118437	O'ring carcasa termostato G 50 x 4	GS 1 1	240019
94624122	Base carburador	NB 2 2	240025
94649659	Base carburador	NB 2 2	240225
94632563	O'ring G 16 x 2.5	GS 1 1	240027
90265732	Base bomba nafta	NB 2 2	550628
90122258	Junta de comando chevrolet	NB 1 1	240029
90128513	O'ring tubo G 64 x 3	GS 1 1	240030
11069511	Arandela bomba aceite A 14 x 20 x 1.5 A	AL 2 2	240032
90231306	Tubo separador bomba aceite CHEVROLET	NB 1 1	240232
90183165	Válvula termostato	NB 1 1	240233
11029589	Arandela tapón cárter A 14 x 18 x 1.5 A	AL 1 1	
	Arandela A 20 x 24 x 1.5 A	AL 1 1	
	O'ring G 64.77 x 2.62	GS 1 1	
	Kit de retenes completo		R240200
	Jgo. retén válvulas (8)	V 1 1	R240210V
	Retén bancada 90 x 104 x 11	P 1 1	R240211P
	Retén distribución 31 x 50 x 8	P 1 1	R240012P
	Retén árbol levas 35 x 48 x 7	P 1 1	R240013P

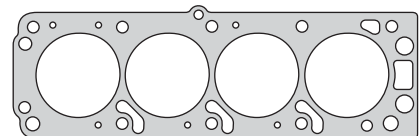

240205

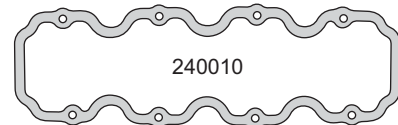

240010

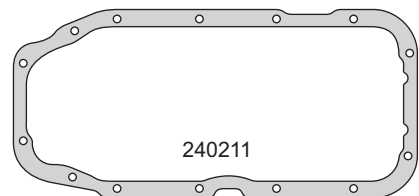

240211

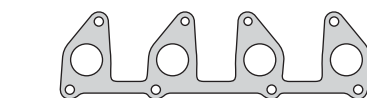

240016

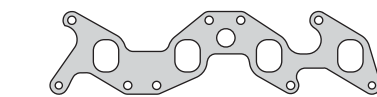

240217

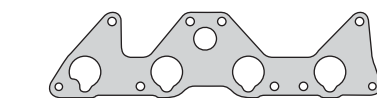

240517



240012

240014



240018

240019

240029

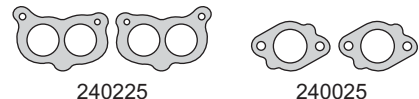

240225

240025

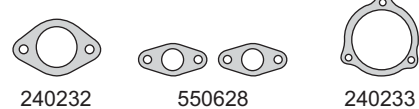

240232

550628

240233

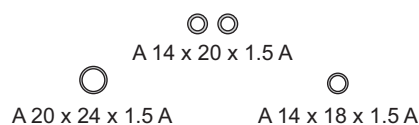

A 14 x 20 x 1.5 A

A 20 x 24 x 1.5 A

A 14 x 18 x 1.5 A

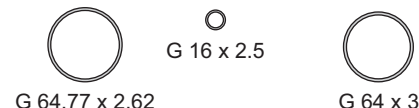

G 16 x 2.5

G 64.77 x 2.62

G 64 x 3



R240211P



R240012P



R240013P



R240210V

# CHEVROLET



Motor/Engine	Cm³	HP	Ø
CN16/16SH	1598	90	80.3

Chevrolet: Monza, Kadett 1981/86



Nº OE	Descripción/Description	Mat.	Ref.
	Jgo. de juntas para motor		240300-R
	Jgo. de juntas superior	●	240395
90122958	Junta tapa cilindros Ø 81.5 ± 1.40	NFT 1 1	240305
	Jgo. tornillos tapa cilin. (HAT55055/55100)		B240000
90106506	Junta tapa válvulas	CG 1 1	240010
90106425	Junta para cárter	CG 1 1	240011
90106432	Bomba aceite y filtro a block	NB 1 1	240012
90106456	O'ring bomba de agua G 90 x 3	GS 1 1	240014
90106615	Múltiple escape	NFT 1 1	240016
90106610	Múltiple admisión	NB 1 1	240017
	Múltiple admisión nafta		240317
90128293	Salida de escape	FCH 1 1	240018
90118437	O'ring termostato G 50 x 4	GS 1 1	240019
94624122	Base carburador	NB 2 2	240025
94632563	O'ring succión bomba aceite G 16 x 2.5	GS 1 1	240027
9275602	Bomba nafta	NB 2 2	550628
90122258	Medidor de aceite	NB 1 1	240029
90128513	O'ring succión bomba aceite G 64 x 3	GS 1 1	240030
105462	Arandela desagote cárter A 20 x 24 x 1.5 A	AL 1 1	240031
1169011	Arandela succión b/aceite A14 x 20 x 1.5 A	AL 2 2	240032
	O'ring termostato G 47 x 4	GS 1 1	
	Kit de retenes completo		R240300
	Jgo. retén válvulas (8)	P 1 1	R240010P
	Retén bancada 85.9 x 104 x 11	P 1 1	R240311P
	Retén distribución 31 x 50 x 8	P 1 1	R240012P
	Retén árbol levas 35 x 48 x 7	P 1 1	R240013P

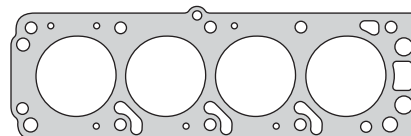

240305

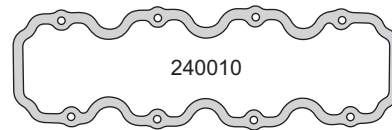

240010

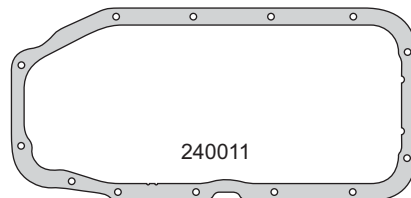

240011

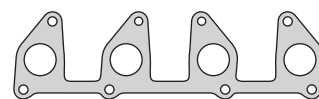

240016



240017



240012



240014



240018



240019



240025



240029



550628



G 16 x 2.5



G 64 x 3



A 14 x 20 x 1.5 A



G 47 x 4



A 20 x 24 x 1.5 A



R240311P



R240012P



R240013P



R240010P



# CHEVROLET



Motor/Engine	Cm³	HP	Ø
C14NV/NZ	1389	60/75	76.5
G15MF	1498	75/78	76.5
OHC	1598	75	79
E16SE/X16SZ	1598	75/82	79
C16LZ/NZ/SV (SOHC) 8V	1598	75/82	79

**Chevrolet:** Corsa 1.4 EFI - 1.6 MPFI, Ascona C 1986/88, Astra, Vectra A 1991/97  
 Corsa A GSI, Nova 1987/93  
 Kadett E 1986/91, Cavalier 1988/94

**Daewoo:** Lemans, Racer 1989/...  
 Cielo, Espero 1994/97

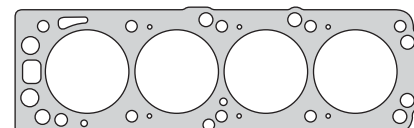

240405

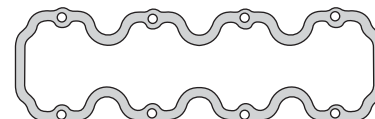

240410

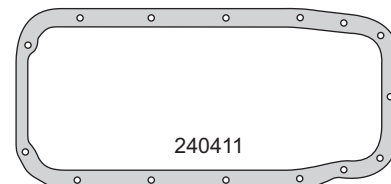

240411

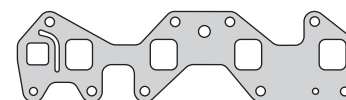

240617

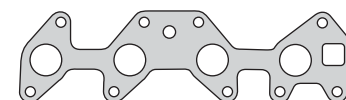

240417

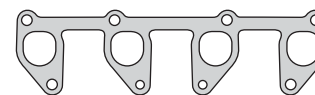

240416

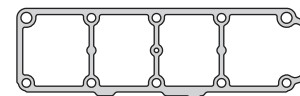

240432

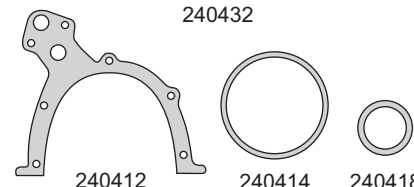

240412

240414

240418



240419

240629

240428



240429

G 40.87 x 3.53

240433



G 64 x 3

G 64.77 x 2.62

40 x 3



A 14 x 20 x 1.5 C

G 15.54 x 2.62

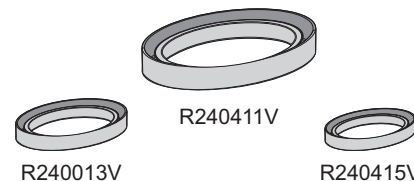

R240411V

R240013V

R240415V



R240210V

Nº OE	Descripción/Description	Mat.	Ref.
	Jgo. de juntas para motor		240400-R
	Jgo. de juntas superior		240495
	Jta. tapa cilindros Ø 80.5 ± 1.40	NFT 1 1	240405
	Jta. tapa cilindros Ø 80.5 ± 1.40 NR	NFT	240407
	Jgo. tornillos tapa cilindros (HAE12038)		B240400
	Junta tapa válvulas	CG 1 1	240410
	Junta para cárter	CG 1	240411
	Frente motor bomba aceite	NB 1	240412
	O'ring bomba de agua G 79.5 x 3	GS 1	240414
	Múltiple escape	NFT 1 1	240416
	Múltiple admisión 1.4 - C14 NV/NZ	NB 1 1	240417
	Multiple admisión 1.6 - C16 NZ	NB 1 1	240617
	Salida de escape	FCH	240418
	Anillo termostato - Hasta 1998	GS 1 1	240419
	Anillo termostato G 41 x 47 - Desde 1999/...	N 1	240428
	Salida gases 1.4	NB 1	240429
	Salida gases 1.6	NB 1	240629
	Base T.B.I.	NB 1	240433
	Junta tapa botadores	NB 1	240432
	Arandela A 14 x 20 x 1.5 C	CU 2	240434
	O'ring distribución G 40 x 3	GS 1	240436
	O'ring distribuidor G 15.54 x 2.62	GS 1	240435
	O'ring G 40.87 x 3.53	GS 1	
	O'ring G 64 x 3	GS 1	
	O'ring G 64.77 x 2.62	GS 1 1	
	Kit de retenes completo		R240400
	Jgo. retén válvulas (8)	V 1	R240210V
	Retén bancada 80 x 98 x 10	V 1	R240411V
	Retén árbol levas 35 x 48 x 7	V 1	R240013V
	Retén distribución 26 x 42 x 8	V 1	R240415V

# CHEVROLET



Motor/Engine	Cm³	HP	Ø
4JA1	2499	76	93
4JB1/4JB1T (OHV) 8V	2771	87/102	93

**Chevrolet:** Pick Up Luv  
**Isuzu:** Trooper, Trooper TD 1988/92



DIESEL

Nº OE	Descripción/Description	Mat.	Ref.
	Jgo. de juntas para motor		240700-R
8.94332-326-0	Junta tapa cilindros Ø 94.0 $\pm$ 1.50	NFT	240707-1M
8.94332-327-0	Junta tapa cilindros Ø 94.0 $\pm$ 1.60	NFT	240707-2M
8.94332-328-0	Junta tapa cilindros Ø 94.0 $\pm$ 1.70	NFT	240707-3M
	Junta tapa cilindros Ø 94.0 $\pm$ 1.51	MLS	1 240708
	Junta tapa cilindros Ø 94.0 $\pm$ 1.63	MLS	240708-2M
	Junta tapa cilindros Ø 94.0 $\pm$ 1.70	MLS	240708-3M
897133416-1	Jgo. tornillos tapa cilindros (HAS17038)		B240700
89424-7-403-1	Conj. junta tapa válvulas (8)	GS	1 240710
	Junta para cárter	GS	240711
894150-790	Cogotera trasera cárter	GS	1 930511-3
897120-933-0	Cogotera delantera cárter	GS	1 930511-4
PTG84	Tapa distribución	GS	1 930512
	Placa distribución	NB	1 240713
	Placa distribución	NB	1 240713-1
	Bomba de agua	GS	1 240714
	Múltiple escape con reflector	CHA	1 240715
	Múltiple admisión	NB	1 240717
	Tapa termostato	NB	1 240719
	Guarnición base filtro aceite	GS	1 240727
	Base termostato	NB	1 240729
	Acople termostato	NB	1 240730
	Brida	NB	1 240731
97113069-0	Cárter inferior trasero	NB	1 930532
	Guarnición tapa válvulas	CH/GS	3 240733
	Arandela especial con rebaje A 8 x 12 x 2.5 C	CU	240734
	Arandela con inserto	CH/GS	240735
	Bujes cónicos	CH/GS	240736
	Junta tapa lateral	GS	1 240737
	Junta brida	NB	1 240738
	O'ring G 10 x 2.3	GS	1
	O'ring G 14.5 x 2	GS	4
	O'ring G 78 x 3	GS	
	Arandela A 8.5 x 16 x 1 C	CU	1
	Arandela A 12.5 x 20 x 1.5 C	CU	1
	Arandela A 14 x 20 x 1.5 C	CU	2
	Arandela A 14 x 24 x 1.5 C	CU	1
	Arandela A 8.5 x 14 x 1.5 C	CU	2
	Kit de retenes completo		R240700
	Jgo. retén válvulas (8)	V	1 R240710V
	Retén bancada 95 x 118 x 8.5	P	1 R240711P
	Retén distribución 50 x 68 x 10	P	1 R550612P
	Retén árbol de levas 40 x 56 x 7	P	2 R250412P

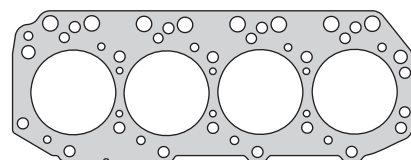

240708

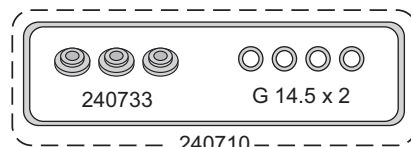

240710

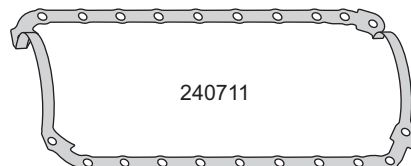

240711



930532

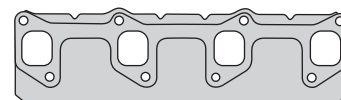

240715



240717

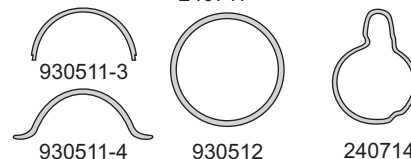

930511-3

930511-4

930512

240714

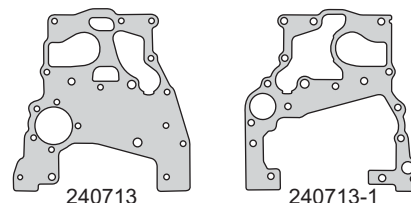

240713

240713-1



240719

240727

240729

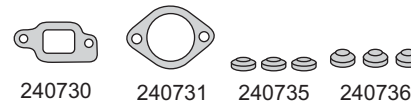

240730

240731

240735

240736

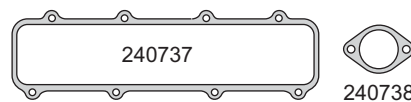

240737

240738

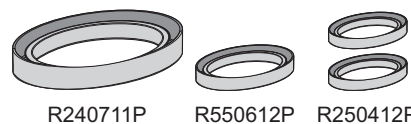
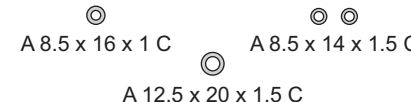

R240711P

R550612P

R250412P



R240710V

# CHEVROLET



Motor/Engine	Cm³	HP	Ø
GM151	2475	90	101.6

**Chevrolet:** Opala, C10, A10 1974/...  
Comodoro, Caravan, A10 1980/84



Nº OE	Descripción/Description	Mat.	Ref.
9300141	Jgo. de juntas para motor		240800
	Jgo. de juntas superior		240895
9298684	Junta tapa cilindros Ø 104.2 ± 1.40	NFT 1 1	240105
3873851	Junta tapa válvulas	CG 1 1	200210
7322169	Jgo. junta para cárter (4)	CG 1	240111
3923472	Tapa distribución	NB 1	200312
3788478	Tapa bomba de agua	NB 1	200014
9298047	Múltiple admisión y escape	NFT 1 1	240816
	Múltiple de escape	NFT 1 1	200216
3788485	Entre múltiple	NFT 1 1	200017
9299824	Salida de escape	FCH 1 1	200018
3701777	Tapa termostato	CB 1 1	200019
7324660	Base carburador	NB 1 1	240825
3789970	Tapa bomba de aceite	NB 1	200027
838263	Base bomba nafta	CB 1	240128
3789161	Cubierta termostato	NB 1 1	200035
3788549	Lateral junta tapa válvulas	CG 1	200236
3921989	Arandela tapón cárter A 13 x 20 x 1 F	F 1	240139
7328511	Jgo. empaquetadura cigüeñal (2)	SNA 1	240158
3835333	Jgo. retén válvulas (8)	N	R200410N
3980267	Retén bancada 112.5 x 130 x 11	P	R200311P
	Retén distribución 44.47 x 61.19 x 9.57	P	R200012P

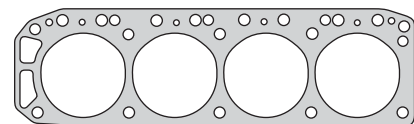

240105

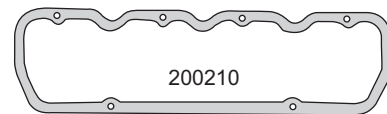

200210

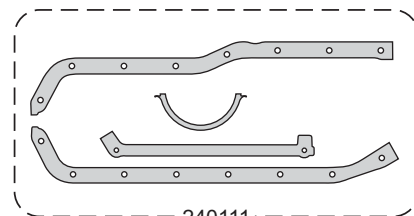

240111

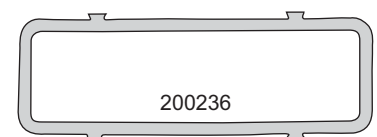

200236



240816



200216

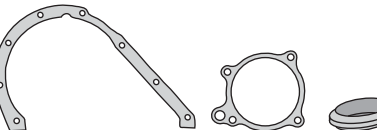

200312

200014

200018



200017



200019



240825

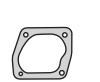

200027



240128



240158



200035



A 13 x 20 x 1 F



R200311P



R200012P



R200410N

# CHEVROLET



Motor/Engine	Cm³	HP	Ø
OHC	996	60	71
C12NZ/12NZ	1196	45	72
X12SZ	1196	45	72

**Chevrolet:** Corsa 1.0 EFI, B10 NZ 1994/...  
Corsa B 1993/97



Nº OE	Descripción/Description	Mat.	Ref.
	Jgo. de juntas para motor		240900-R
	Jgo. de juntas superior	●	240995
	Jta. tapa cilindros Ø 73.5 ±1.40	NFT 1 1	240905
	Jta. tapa cilindros Ø 73.5 ±1.40	NFT	240907
607998	Jta. tapa cilindros Ø 74.0 ±1.40	MLS	240908
	Jgo. tornillos tapa cilindros (HAE12038)		B240400
	Junta tapa válvulas	CG 1 1	240410
	Junta para cárter	CG 1 1	240411
	Frente motor bomba aceite	NB 1 1	240412
	Múltiple escape	NFT 1 1	240416
	Múltiple admisión	NB 1 1	240417
	Múltiple admisión 1.6	NB 1 1	240617
	Salida de escape	FCH	240418
	Anillo termostato	GS 1 1	240419
	Salida gases 1.4	NB 1	240429
	Base T.B.I.	NB 1	240433
	O'ring distribuidor G 15.54 x 2.62	GS 1	
	O'ring bomba agua G 79.5 x 3	GS 1	
	O'ring G 40 x 3	GS 1	
	O'ring distribución G 64 x 3	GS 1	
	O'ring G 64.77 x 2.62	GS 1 1	
	Arandela A 14 x 20 x 1.5 A	AL 1	
	Kit de retenes completo		R240400
	Jgo. retén válvulas (8)	V 1	R240210V
	Retén bancada 80 x 98 x 10	P 1	R240411P
	Retén distrib. bomba aceite 26 x 42 x 8	P 1	R240415P
	Retén árbol levas 35 x 48 x 7	P 1	R240013P

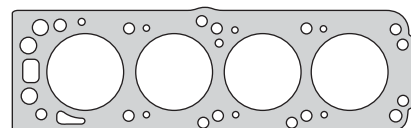

240905

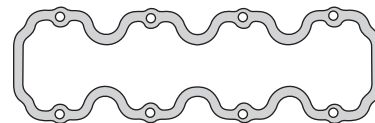

240410

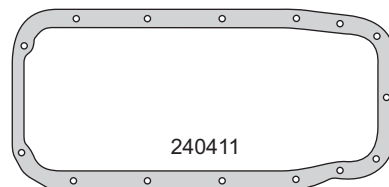

240411

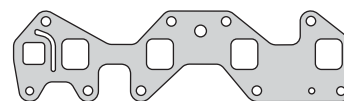

240617

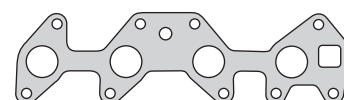

240417

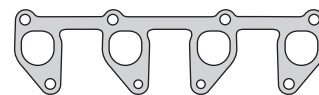

240416

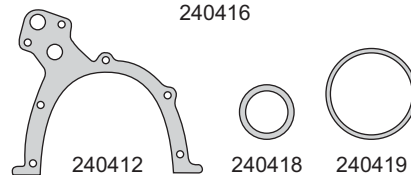

240412

240418

240419

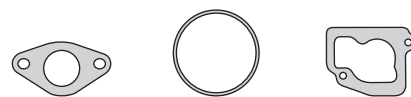

240429

G 79.5 x 3

240433



A 14 x 20 x 1.5 A

G 15.54 x 2.62



G 64 x 3

G 64.77 x 2.62

G 40 x 3



R240411P



R240013P



R240415P



R240210V

# CHEVROLET



Motor/Engine	Cm³	HP	Ø
C14E Familia I	1389	85	77.6

Chevrolet: Celta MPFI 2004/...



Nº OE	Descripción/Description	Mat.	Ref.
	Jgo. de juntas para motor		241000-R
	Jgo. de juntas superior	●	241095
	Jgo. de juntas superior (MLS)		241095 MLS
	Junta tapa cilindros Ø79.0 $\pm$ 1.70	NFT 1 1	241005
	Junta tapa cilindros Ø79.0 $\pm$ 1.20	NFT	241007
	Junta tapa cilindros Ø79.0 $\pm$ 1.80	NFT	241007-1.8
	Junta tapa cilindros Ø79.0 $\pm$ 1.50	MLS	241008
	Jgo. tornillos tapa cilindros (HAE12038)		B240400-1
	Junta tapa válvulas	N 1 1	241010
	Junta para cárter	CG 1	240411
	Frente bomba aceite	SLS 1 1	241812
	Múltiple escape	NFT 1 1	240416
	Múltiple admisión	NB 1 1	240617
	Múltiple admisión	NB 1 1	241017
	Salida de escape	FCH 1 1	240018
	Descarga gases 1.4	GS 1 1	240419
	Junta termostato	GS	241219
	Junta termostato	NB	240429
	Junta	CB	241230
	Anillo goma	NB	241231
	Junta tapa botadores	NB 1 1	240432
	Arandela A 14 x 20 x 1.5 C	CU 2 2	
	Arandela A 20 x 24 x 1.5 A	AL 1 1	
	O´ring G 13.94 x 2.62	GS 1 1	
	O´ring G 21.89 x 2.62	GS 2 2	
	O´ring G 47 x 4	GS 1 1	
	O´ring G 64.77 x 2.62	GS 1 1	
	O´ring G 79.5 x 3	GS	1
	O´ring G 9.19 x 2.62	GS	1
	Kit de retenes completo		R240400
	Jgo. retén válvulas (8)	V 1	R240210V
	Retén bancada 80 x 98 x 10	P 1	R240411P
	Retén distrib. bomba aceite 26 x 42 x 8	P 1	R240415P
	Retén árbol levas 35 x 48 x 7	P 1	R240013P

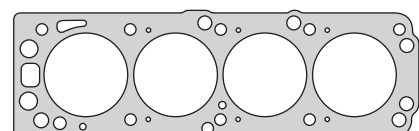

241007-1.80

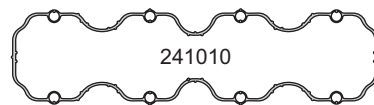

241010

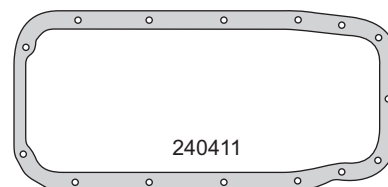

240411

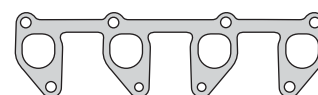

240416

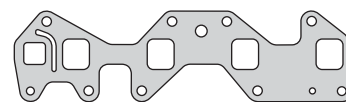

240617

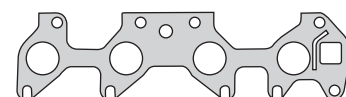

241017

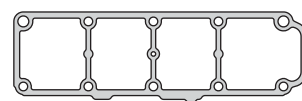

240432

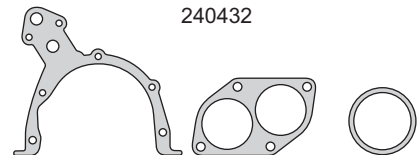

241812 240018 241219

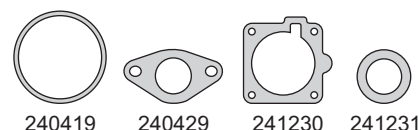

240419 240429 241230 241231



A 14 x 20 x 1.5 C A 20 x 24 x 1.5 A

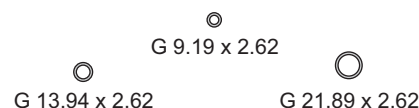

G 13.94 x 2.62 G 21.89 x 2.62



G 79.5 x 3 G 64.77 x 2.62 G 47 x 4

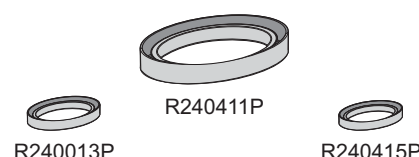

R240013P R240411P R240415P

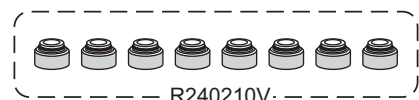

R240210V

# CHEVROLET



Motor/Engine	Cm³	HP	Ø
12NV	1196	55	77.8
12ST	1196	54/55	77.8

**Chevrolet:** Corsa A 1990/93, Kadett E 1986/91  
**Vauxhall:** Nova 1985/...



Nº OE	Descripción/Description	Mat.	Ref.
	Jgo. de juntas superior	●	241195-R
	Junta tapa cilindros Ø 79.0 $\pm$ 1.70	NFT	241005
	Junta tapa cilindros Ø 79.0 $\pm$ 1.20	NFT	1 241007
	Junta tapa cilindros Ø 79.0 $\pm$ 1.80	NFT	241007-1.8
	Junta tapa cilindros Ø 79.0 $\pm$ 1.50	MLS	241008
	Jgo. tornillos tapa cilindros (HAE12038)		B240400
	Jgo. tornillos tapa cilindros (HAE12038)		B240400-1
	Junta tapa válvulas	CG	1 240410
	Junta tapa válvulas	CG	1 241110
	Múltiple escape	NFT	1 240416
	Múltiple admisión	NB	1 241117
	Anillo termostato	GS	1 240419
	Jgo. retén válvulas (8)	V	1 R240210V
	Retén arbol levas 35 x 48 x 7	P	1 R240013P

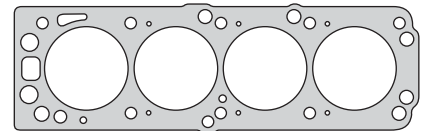

241007

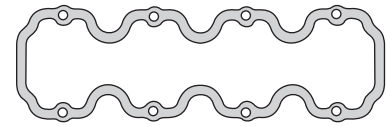

240410

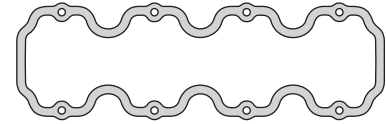

241110

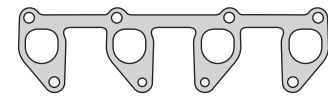

240416

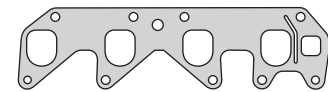

241117

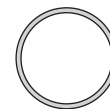

240419



R240013P



R240210V

# CHEVROLET



Motor/Engine	Cm³	HP	Ø
MPFI (SOHC) 8V	999	60	71.1

**Chevrolet:** Celta 2000/...  
**Suzuki:** Fun 2002/...



Nº OE	Descripción/Description	Mat.	Ref.
	Jgo. de juntas para motor		241200-R
	Jgo. de juntas superior		241295
	Junta tapa cilindros Ø 73.5 ± 1.40	NFT 1 1	240905
	Junta tapa cilindros Ø 73.5 ± 1.40	NFT	240907
607998	Junta tapa cilindros Ø 74.0 ± 1.40	MLS	240908
	Jgo. tornillos tapa cilindros (HAE12038)		B280600
	Junta tapa válvulas	N 1 1	241010
	Junta para cárter	CG 1	240411
	Frente motor bomba aceite	NB 1	240412
	Múltiple admisión y escape	NFT 1 1	240416
	Múltiple admisión	NB 1 1	241017
	Junta termostato	GS 1	241219
	Salida gases 1.4	NB 1 1	240429
	Junta soporte inyección TBI	CB 1 1	241230
	Anillo goma	NB 1	241231
	O'ring G 79.5 x 3	GS 1	
	O'ring G 9.19 x 2.62	GS 1	
	O'ring G 64 x 3	GS 1	
	O'ring G 64.77 x 2.62	GS 1 1	
	Kit de retenes completo		R240400
	Jgo. retén válvulas (8)	V 1	R240210V
	Retén bancada 80 x 98 x 10	CHEVROLET- 1	R240411P
	Retén árbol levas 35 x 48 x 7	P 1	R240013P
	Retén distrib. bomba aceite 26 x 42 x 8	P 1	R240415P

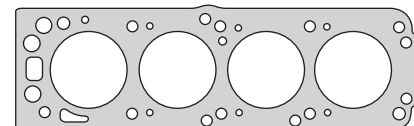

240905

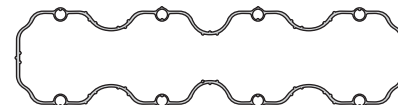

241010

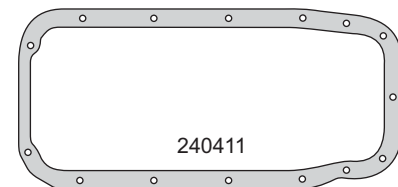

240411

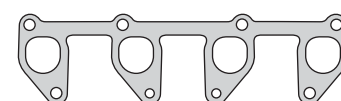

240412

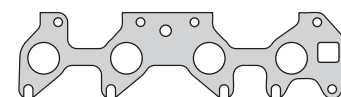

241017

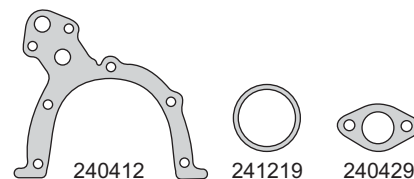

240412

241219

240429



241230

241231

G 79.5 x 3

G 64 x 3



G 9.19 x 2.62



G 64.77 x 2.62



R240013P



R240415P



R240411P



R240210V

# CHEVROLET



Motor/Engine	Cm³	HP	Ø
13N/SB	1297	60/70/75	75
13N/S-13NS/SC	1297	60/70/75	75

**Chevrolet:** Kadett D, Kadett E 1979/86  
**Vauxhall:** Cavalier, Astra 1980/85



Nº OE	Descripción/Description	Mat.	Ref.
	Jgo. de juntas superior		241395-R
	Junta tapa cilindros Ø 77.0 $\pm$ 1.30 <b>NR</b>	NFT	1 241307
	Jgo. tornillos tapa cilindros (HAE12038)		B240400
	Junta tapa válvulas	CG	1 240410
	Junta tapa válvulas	CG	1 241110
	Múltiple escape	NFT	1 240416
	Múltiple admisión	NB	1 241117
	Anillo termostato	GS	1 240419
	O´ring G 64.77 x 2.62	GS	1
	Jgo. retén válvulas (8)	V	1 R240210V
	Retén arbol levas 35 x 48 x 7	P	1 R240013P

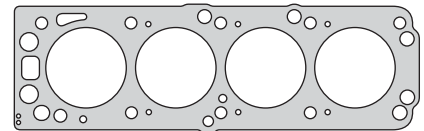

241307

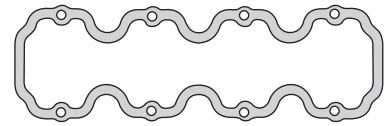

240410

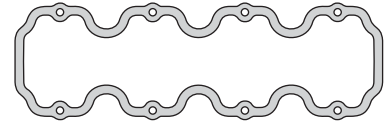

241110

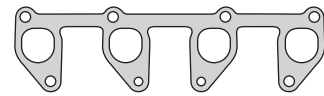

240416

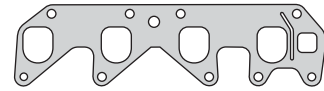

241117

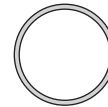

240419



G 64.77 x 2.62



R240013P



R240210V



# CHEVROLET



Motor/Engine	Cm³	HP	Ø
MPFI	2000	116	86
MPFI (SOHC) 8V	2200	123	86

Chevrolet: Vectra 1997/...



Nº OE	Descripción/Description	Mat.	Ref.
	Jgo. de juntas para motor		241400-R
	Jgo. de juntas superior	●	241495
	Jta. tapa cilindros Ø 88.0 ±1.40	NFT 1 1	280705
	Jta. tapa cilindros Ø 88.0 ±1.40		280707
	Jgo. tornillos tapa cilin. (HAT55055/55100)		B280700
90467661	Junta tapa de válvulas	N 1 1	241410
6 52 635	Junta para cárter superior	NFT 1 1	290811
90106615	Bomba aceite filtro a block	NB 1 1	240012
	Múltiple admisión y escape	NFT 1 1	240016
	Múltiple admisión EFI	NFT 1 1	240517
90128293	Múltiple admisión MPFI	NB 1 1	241417
94649659	Salida de escape	FCH 1 1	240018
90122258	Junta base carburador	NB 2 2	240225
	Junta mando	NB 1 1	240029
	Junta soporte inyección TBI	CB 1 1	241230
	Junta	NB 1 1	241430
90231306	Junta	NB 1 1	241431
90183165	Tubo separador bomba aceite	NB 1 1	240232
	Válvula termostato	NB 1 1	240233
6 52 636	Junta sobre cárter	CG 1 1	290832
	Arandela A 14 x 18 x 1.5 A	AL 1 1	
	O´ring G 15.54 x 2.62	GS 1 1	
	O´ring G 16 x 2	GS 1 1	
	O´ring G 47.22 x 3.53	GS 2 2	
	O´ring G 50 x 4	GS 1 1	
	O´ring G 52.07 x 2.62	GS 1 1	
	O´ring G 53.7 x 1.78	GS 1 1	
	O´ring G 64.77 x 2.62	GS 3 3	
	O´ring G 88.57 x 2.62	GS 1 1	
	Kit de retenes completo		R240200
	Jgo. retén válvulas (8)	V 1 1	R240210V
614 827	Retén bancada 90 x 104 x 11	P 1 1	R240211P
646 265	Retén distribución 31 x 50 x 8	P 1 1	R240012P
636 841	Retén árbol de levas 35 x 48 x 7	P 1 1	R240013P

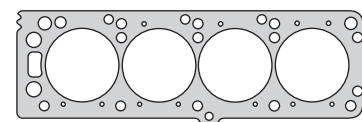

280705

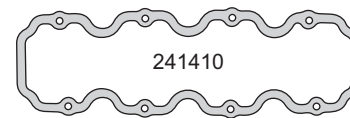

241410

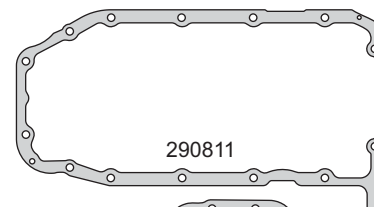

290811

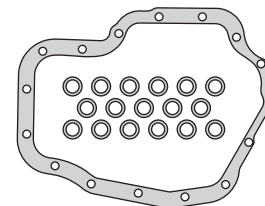

290832

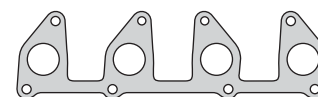

240016



240517

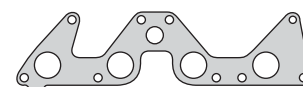

241417

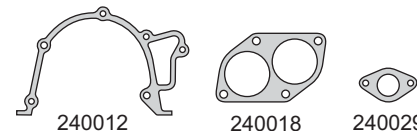

240012

240018

240029

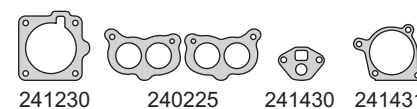

241230

240225

241430

241431



240232

G 64.77 x 2.62

240233



G 50 x 4

G 47.22 x 3.53

G 16 x 2



A 14 x 18 x 1.5 A

G 15.54 x 2.62

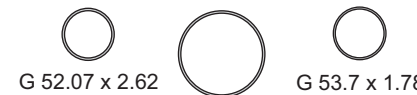

G 52.07 x 2.62

G 88.57 x 2.62

G 53.7 x 1.78

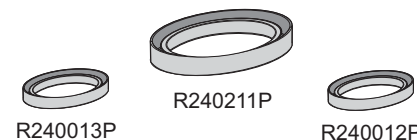

R240013P

R240211P

R240012P

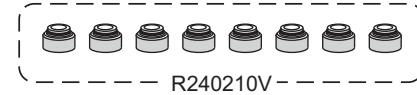

R240210V

# CHEVROLET



Motor/Engine	Cm³	HP	Ø
OHC	1998	110/130	86
C20LE/C20NE	1998	97/110	86
C20NE/SEH/SER	1998	100/130	86
C20NEF (SOHC) 8V	1998	100/130	86

**Chevrolet:** Omega MPFI, Vectra MPFI 1992/98  
**Daewoo:** Lemans, Racer 1989/97  
 Aranos 1995/..., Nubira II 1999/...  
**Opel:** Frontera 1991/95, Calibra, Cavalier  
 Kadett 1986/91, Astra 1991/96  
 Omega A 1986/94



Nº OE	Descripción/Description	Mat.	Ref.
	Jgo. de juntas para motor		241500-RMX
	Jgo. de juntas superior	●	241595
	Jta. tapa cilindros Ø 87.5 $\pm$ 1.30	NFT 1 1	241507
	Jgo. tornillos tapa cilin. (HAT55055/55100)		B240000
652 635	Junta tapa de válvulas	CG 1 1	240010
	Junta para cárter superior	NFT 1 1	290811
	Bomba aceite y filtro a block	NB 1 1	240012
	Múltiple escape	NFT 1 1	240016
	Múltiple admisión	NB 1 1	240217
90128293	Múltiple admisión MPFI	NB 1 1	241417
	Base carburador	NB 3	240025
	Tubo separador bomba aceite	NB 1	240232
	Junta	NB 1	241431
	Junta	NB 1	290833
	Arandela A 14 x 20 x 1.5 A	AL 1	
	Arandela A 20 x 25 x 2 A	AL 1	
	O'ring G 48 x 4	GS 1	
	O'ring G 50 x 4	GS 1	
	O'ring G 55.25 x 2.62	GS 1 1	
	O'ring G 64.77 x 2.62	GS 1	
	O'ring G 90 x 3	GS 1	
	Kit de retenes completo		R241500
	Jgo. retén válvulas (8)	V 1	R240210V
	Retén bancada 90 x 104 x 11	P 1	R240211P
	Retén distribución 31 x 50 x 8	P 1	R240012P
636 841	Retén árbol de levas 35 x 48 x 7	P 1	R240013P
	Retén auxiliar 55 x 70 x 8	V 1	R241515V

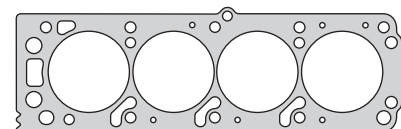

241507

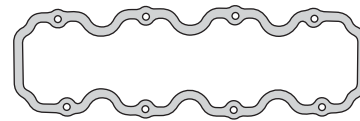

240010

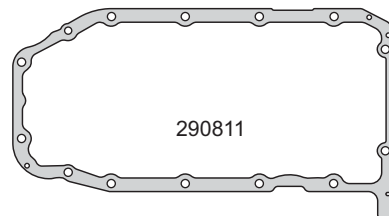

290811

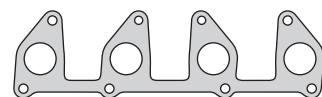

240016



240217



241417



240012

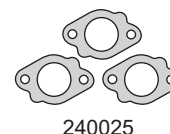

240025



240232



241431



290833



G 48 x 4



A 14 x 20 x 1.5 A



A 20 x 25 x 2 A

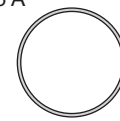

G 90 x 3



G 64.77 x 2.62



G 50 x 4



G 55.25 x 2.62



R240211P



R241515V



R240012P



R240013P



R240210V

# CHEVROLET



Motor/Engine	Cm³	HP	Ø
17D/DR (SOHC) 8V	1699	57/60	82.5
<b>DIESEL</b>			

**Chevrolet:** Astra 1991/94, Vectra A 1989/95  
**Vauxhall:** Astra Max 1990/..., Belmont 1989/91



Nº OE	Descripción/Description	Mat.	Ref.
	Jgo. de juntas para motor		241601-R
	Jgo. de juntas superior	●	241695
	Junta tapa cilindros Ø 84.0 ± 1.30	NFT	241607-SM
	Junta tapa cilindros Ø 84.0 ± 1.40	NFT	241607-1M
	Junta tapa cilindros Ø 84.0 ± 1.50	NFT	241607-2M
	Jgo. tornillos tapa cilin. (HAT55055/55100)		B241700
90106506	Junta tapa válvulas	CG 1 1	240010
90106425	Junta para cárter	CG 1 1	240011
90106432	Bomba aceite y filtro a block	NB 1 1	240012
90106456	O'ring bomba de agua G 90 x 3	GS 1 1	240014
	Múltiple escape	NFT 1 1	241616
	Múltiple admisión	NB 1 1	241617
90122258	Nivel aceite	NB 1 1	240029
	Junta termostato	GS 1 1	560131
1169011	Arandela bomba aceite A 14 x 20 x 1.5 C	CU 2 2	240032
	Salida de escape	CHA 1 1	241640
	Arandela A 18 x 24 x 1.5 A	AL 1 1	
	Arandela A 14 x 22 x 2 C	CU 4 4	
	Arandela A 17 x 21 x 0.5 C	CU 4 4	
	O'ring G 15.54 x 2.62	GS 1 1	
	O'ring G 48 x 4	GS 1 1	
	Kit de retenes completo		R241600
	Jgo. retén válvulas (8)	P 1 1	R240010P
	Retén bancada 90 x 104 x 11	V 1 1	R240211V
	Retén árbol levas 35 x 48 x 7	V 1 1	R240013V
	Retén árbol levas 35 x 50 x 7	V 1 1	R470013V

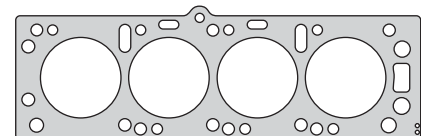

241607

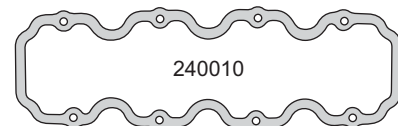

240010

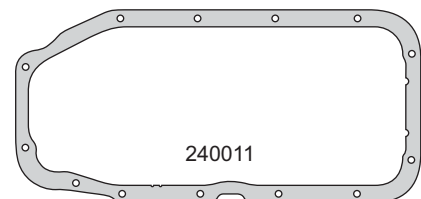

240011

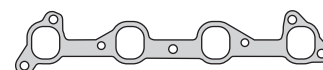

241616



241617

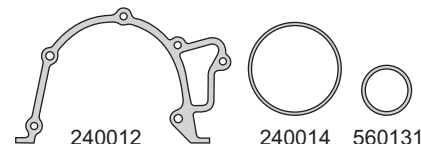

240012

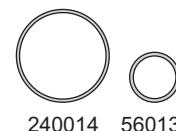

240014

560131



241640



240029

G 15.54 x 2.62

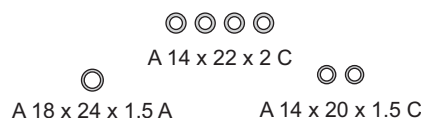

A 14 x 22 x 2 C

A 18 x 24 x 1.5 A

A 14 x 20 x 1.5 C

A 17 x 21 x 0.5 C



G 48 x 4



R240211V



R240013V



R470013V



R240010P

# CHEVROLET



Motor/Engine	Cm³	HP	Ø
17DTL	1699	68	82.5

Chevrolet: Astra TD, Astra F TD 1994/97

DIESEL



Nº OE	Descripción/Description	Mat.	Ref.
	Jgo. de juntas para motor		241701-R
	Jgo. de juntas superior		241795
607464	Junta tapa cilindros Ø 84.0 $\pm$ 1.30	NFT	241707-SM
607472	Junta tapa cilindros Ø 84.0 $\pm$ 1.40	NFT	241707-1M
607466	Junta tapa cilindros Ø 84.0 $\pm$ 1.50	NFT	241707-2M
	Jgo. tornillos tapa cilin. (HAT55055/55100)		B241700
638733	Junta tapa válvulas	N 1 1	241010
652586	Junta para cárter	CG 1	240011
	Junta para cárter	CG 1	240411
90106615	Junta bomba aceite y filtro a block	NB 1	240012
	Junta bomba aceite y filtro a block	NB 1	240412
90106456	O´ring bomba de agua G 90 x 3	GS 1	240014
5850616	Múltiple escape	NFT 1 1	241616
	Múltiple escape	NFT 1	240416
849511	Múltiple admisión	NB 1 1	241617
	Múltiple admisión	NB 1	241017
90122258	Junta nivel de aceite	NB 1	240029
	Descarga gases	NB 1	240429
	Arandela B18 x 24 x 2.3 CN	CN 1	450029
	Junta	CB 1	241230
1169011	Junta termostato	GS 1 1	560131
	Anillo	NB 1	241231
	Arandela bomba aceite A 14 x 20 x 1.5 C	CU 2	240032
	Arandela A 17 x 21 x 1.5 C	CU 4	
	Arandela inyección A 14 x 22 x 2 C	CU 4	
	O´ring G 48 x 4	GS 1 1	
642526	O´ring G 15.54 x 2.62	GS 1	
	O´ring G 79.5 x 3	GS 1	
	O´ring G 9.19 x 2.62	GS 1	
	Kit de retenes completo		R241700
614827	Jgo. retén válvulas (8)	V 1	R240210V
646266	Retén bancada 80 x 98 x 10	P 1	R240411V
	Retén distribución 35 x 50 x 7	P 1	R470013P
	Retén árbol levas 35 x 48 x 7	V 1	R240013V
	Retén distribución 26 x 42 x 8	V 1	R240415V

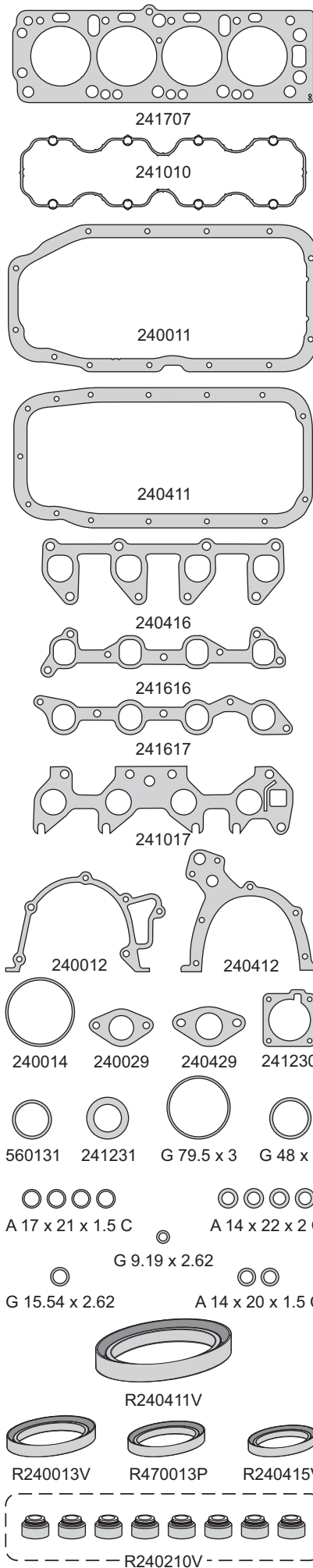

# CHEVROLET



Motor/Engine	Cm³	HP	Ø
L79 ALX (DOHC) 16V	1781	122	80.5

**Chevrolet:** Corsa II, Meriva 2003/...  
**Fiat:** Palio Fase II 2004/...



Nº OE	Descripción/Description	Mat.	Ref.
	Jgo. de juntas para motor		● 241800-R MLS
	Jgo. de juntas superior (MLS)	●	241895 MLS
	Jgo. de juntas superior		241895
	Jta. tapa cilindros Ø 82.0 ± 1.20	NFT	241807
93294584	Jta. tapa cilindros Ø 82.0 ± 0.35	MLS	1 1 241808
90412701	Jgo. tornillos tapa cilindros (HAE12038)		B280600
7083391	Conj. junta tapa válvulas (11)	N	1 1 241810
	Junta para cárter superior	NFT	1 290811
90573301	Frente motor bomba de aceite	SLS	1 241812
09158173	Bomba de agua G 79.5 x 3	GS	1 240414
90470036	Múltiple escape	NFT	1 1 280615
90536057	Múltiple admisión	SLS	1 1 241817
90231452	Salida de escape	FCH	1 1 240018
09157005	Guarnición base termostato G 60.05 x 1.78	GS	1 1 241819
90566088	Válvula aceleración	NB	1 1 241830
90536272	Junta válvula EGR	AC	1 1 241831
90220436	Guarnición termostato G 52.07 x 2.62	GS	1 1 241835
	O´ring G 10 x 2	GS	10 10
	Kit de retenes completo		R241800
90410741	Jgo. reten válvulas (16)	V	1 R280610V
90352111	Retén bancada 80 x 98 x 10	V	1 R240411V
90501719	Retén distribución 30 x 42 x 8	P	1 R550413P
90180529	Retén árbol levas 35 x 48 x 7	P	2 R240013P

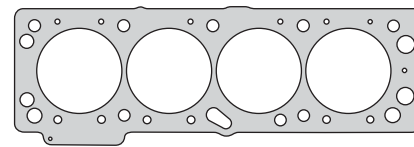

241808

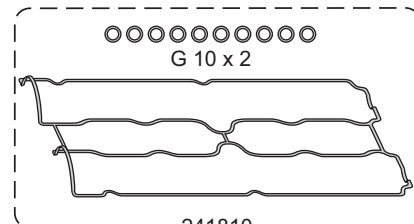

241810

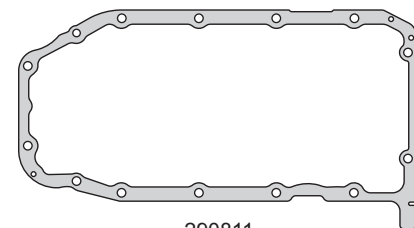

290811



280615

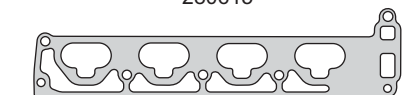

241817



241812

240414

241819

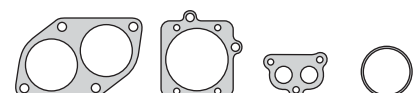

240018

241830

241831

241835



R240411V



R240013P

R550413P

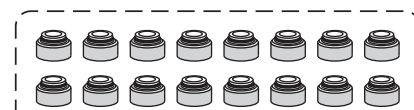

R280610V

# CHEVROLET



Motor/Engine	Cm³	HP	Ø
172 V6 2da. Generación Cabeza de Aluminio	2800 3100		

**Chevrolet:** Cutlass, Century, Eurosport  
Cavalier 1989/94



Nº OE	Descripción/Description	Mat.	Ref.
	Jgo. de juntas para motor		241900-RMX
	Jgo. de juntas superior	●	241995
	Jgo. junta tapa cilin. Ø 91.5 ± 1.70 (2)	NFT 1 1	241905
	Conj. junta tapa válvulas (2)	GS 1 1	241910
	Junta para cárter	GS 1 1	241911
	Junta distribución	NB 1 1	241912
	Jgo. múltiple escape (2)	GFT 1 1	241915
	Jgo. múltiple admisión (4)	NFT 1 1	241917
	Junta	CB 1 1	290227
	Guarnición cierre admisión	GS 2 2	241930
	Junta	NB 1 1	241931
	Junta	GFT 1 1	290231
	Junta	NB 1 1	241932
	Junta	NB 1 1	241933
	Junta	CB 1 1	241934
	Junta	NB 1 1	241937
	Junta	NB 1 1	241938
	Junta	NB 1 1	241939
	Junta	NB 1 1	241940
	Arandela A 33 x 46	CB 1 1	280143
	Arandela tapa válvulas A 13 x 21 x 1.5 F	F 1 1	
	O´ring G 12.42 x 1.78	GS 1 1	
	O´ring G 23.39 x 3.53	GS 1 1	
	Guarnición G 7 x 10 x 2	GS 12 12	
	Kit de retenes completo		R241900
	Jgo. retén válvulas (12)	P 1 1	R241910P
	Retén bancada 76 x 92 x 10	P 1 1	R241911P
	Retén distribución 44.47 x 61.19 x 9.57	P 1 1	R200012P

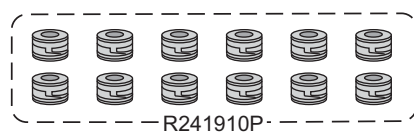
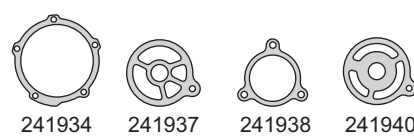
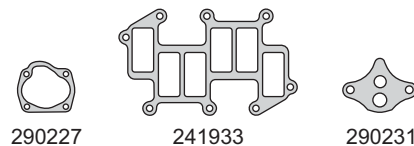
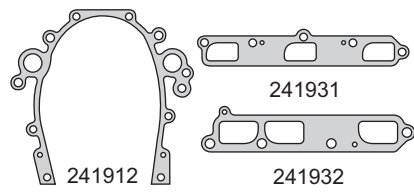
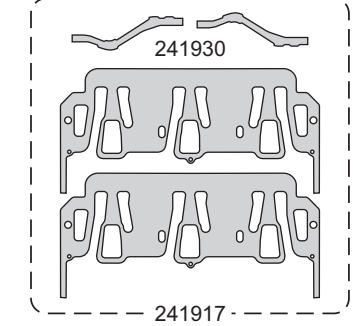
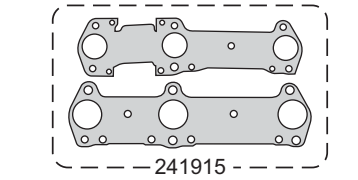
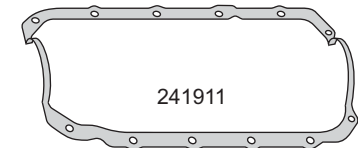
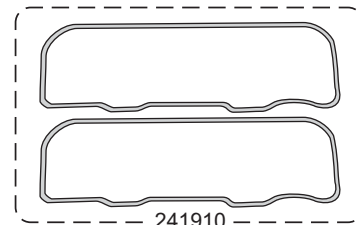
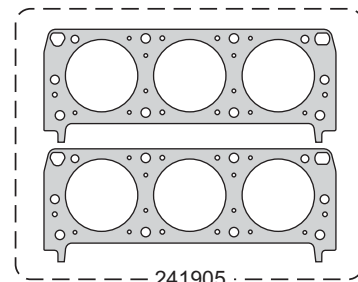

# CHEVROLET



Motor / Engine **Cm<sup>3</sup>** **HP** **Ø**

**MPFI/EFI**  
(OHC) 8V **2198** **106** **86**

*Chevrolet:* S10, Blazer, Omega 1994/...



Nº OE	Descripción / Description	Mat.	Ref.
	<b>Jgo. de juntas para motor</b>		<b>242000-R</b>
	<b>Jta. tapa cilindros Ø 88.0 ±1.40</b>		<b>280705</b>
<b>94658177</b>	<b>Jta. tapa cilindros Ø 88.0 ±1.40</b> <b>N.R.</b>	<b>NFT</b>	<b>1 280707</b>
	<b>Jgo. tornillos tapa cilindros</b> <b>(HAT55055/55100)</b>		<b>B280700</b>
90106506	Junta tapa de válvulas	CG	1 240010
90220309	Junta para cárter	N	1 240211
90106432	Bomba aceite filtro a block	NB	1 240012
90106456	Múltiple admisión y escape	NFT	1 240016
90215011	Múltiple admisión	NB	1 240217
	Múltiple admisión	NFT	1 240517
90128293	Salida de escape	FCH	1 240018
	Junta	NB	1 241430
	Junta soporte inyección TBI	NB	1 242032
90231306	Junta	NB	1 241431
	Tubo separador bomba aceite	NB	1 240232
	Arandela A 14 x 20 x 1.5 A	AL	3
	Arandela A 20.5 x 24 x 1.5 A	AL	1
	Arandela A 22 x 27 x 1.5 A	AL	1
	O´ring G 16 x 2	GS	1
	O´ring G 15.54 x 2.62	GS	1
	O´ring G 47 x 4	GS	1
	O´ring G 55.25 x 2.62	GS	1
	O´ring G 88 x 3	GS	1
	Kit de retenes completo		R242000
	Jgo. retén válvulas (8)	V	1 R240210V
	Retén bancada 90 x 104 x 11	P	1 R240211P
	Retén árbol de levas 35 x 48 x 7	P	1 R240013P

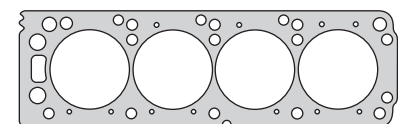

280707

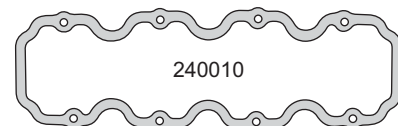

240010

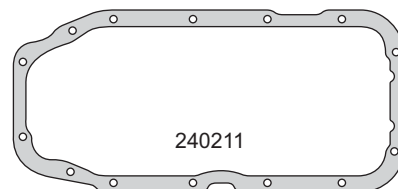

240211

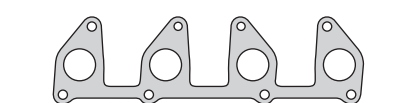

240016



240217



240517

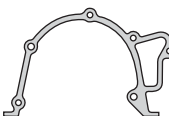

240012

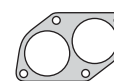

240018



241430



241431



240232



242032



A 14 x 20 x 1.5 A

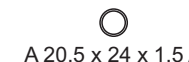

A 20.5 x 24 x 1.5 A



A 22 x 27 x 1.5 A



G 16 x 2



G 15.54 x 2.62

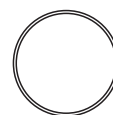

G 88 x 3



G 55.25 x 2.62



G 47 x 4



R240211P



R240013P



R240210V

# CHEVROLET



Motor/Engine	Cm³	HP	Ø
262 V6	4300		101.6

Chevrolet: Pick Up 1988/93



Nº OE	Descripción/Description	Mat.	Ref.
	Jgo. de juntas para motor		242100-RMX
	Jgo. de juntas superior	●	242195
	Jgo. jta. tapa cil. Ø105.0 ±1.20 (2)	NFT	290605
	Jgo. jta. tapa cil. Ø105.0 ±1.20 (2)	NFT	1 1 290607
	Jgo. junta tapa válvulas (2)	CG	1 1 242110
	Jgo. junta para cárter (4)	CG	1 1 242111
	Junta distribución	CB	1 1 280112
	Jgo. múltiple escape (6)	NFT	1 1 242116
	Jgo. múltiple admisión (2)	NFT	1 1 242117
	Jgo. múltiple admisión (2)	NFT	1 1 242117-1
	Salida de escape	NFT	1 1 242118
	Bomba de agua	CB	1 1 280119
	Base bomba nafta	CB	1 1 200028
	Base bomba aceite	NFT	1 1 280828
	Junta acople bomba aceite	CB	2 2 200029
	Guarnición	CG	1 1 242730
	Guarnición	CG	1 1 242731
	Junta	CB	1 1 242132
	Junta tapa inspección	CB	1 1 280132
	Junta porta retén	CB	1 1 280834
	Junta	AC	2 2 280835
	Junta	NB	1 1 242139
	Arandela A 33 x 46	CB	1 1 280143
	Junta	CB	1 1 280144
	Arandela A 12 x 16 x 2 A	AL	1 1
	O´ring G 15.54 x 2.62	GS	1 1
	O´ring G 64.77 x 2.62	GS	1 1
	Kit de retenes completo		R242100
	Jgo. retén válvulas (12)	P	1 R242110P
	Retén bancada 95 x 115 x 12.5	S	1 R242111S
	Retén distribución 44.47 x 61.19 x 9.57	P	1 R200012P

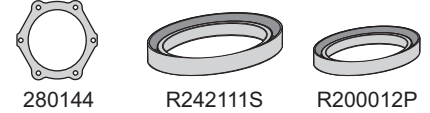
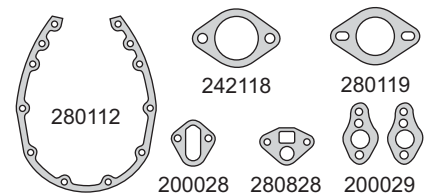
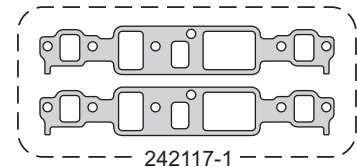
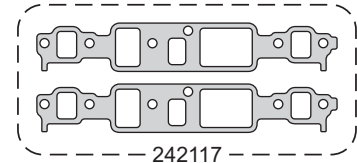
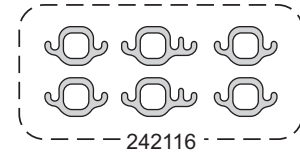
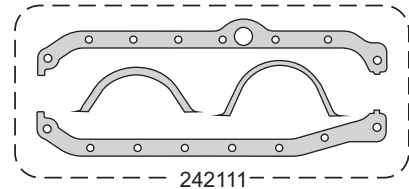
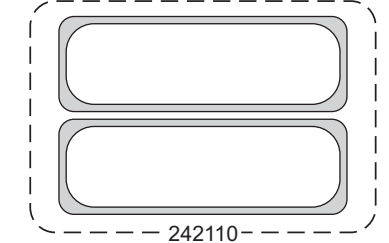
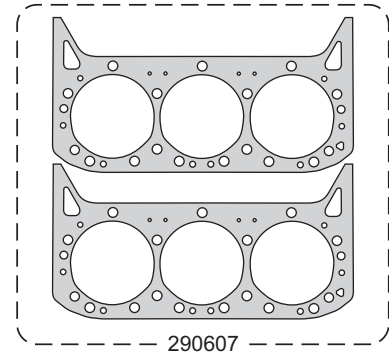



# CHEVROLET



Motor/Engine	Cm³	HP	Ø
GM Powertrain OHC 171190 MPFI 8V	1796 1796	102 102	80.5 80.5

**Chevrolet:** Corsa, Meriva 2003  
**Fiat:** Stylo, Strada Working, Adventure  
 Palio 2003



Nº OE	Descripción/Description	Mat.	Ref.
	Jgo. de juntas para motor		242200-R
	Jgo. de juntas superior (JTC 05)	●	242295
	Jgo. de juntas superior (MLS)		242295 MLS
	Junta tapa cilindros Ø 82.0 ± 1.40	NFT 1 1	242205
	Junta tapa cilindros Ø 82.0 ± 1.40	NFT	242207
93294583	Junta tapa cilindros Ø 82.0 ± 1.40	MLS	242208
	Jgo. tornillos tapa cilindros (HAE12038)		B242200
	Junta tapa válvulas	N 1 1	241010
	Junta para cárter	CG 1	240411
	Frente motor bomba aceite	NB 1	240412
	Múltiple admisión y escape	NFT 1 1	240416
90106615	Múltiple admisión	NB 1 1	241017
7084890	Jgo. múltiple admisión (7)	GS 1 1	252317
	Salida de escape	FCH 1 1	240018
7084981	Junta cuerpo mariposa aceleración	GS 1 1	252326
	Junta base termostato	N 1	240428
90128293	Salida gases 1.4	NB 1	240429
	Junta soporte inyección TBI	CB 1 1	241230
71716584	Guarnición admisión	GS 1 1	270731
	Junta acople admisión	GS 1 1	252332
	O'ring G 9.19 x 2.62	GS 1	
	O'ring G 64.77 x 2.62	GS	
	O'ring G 79.5 x 3	GS 1	
	O'ring G 37.47 x 3	GS 1	
	Kit de retenes completo		R242200
	Jgo. retén válvulas (8)	V 1	R240210V
	Jgo. retén válvulas (8)	V 1	R242210V
	Retén bancada 80 x 98 x 10	V 1	R240411V
	Retén distribución 26 x 42 x 8	V 1	R240415V
	Retén árbol levas 35 x 48 x 7	V 1	R240013V

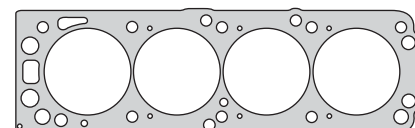

242205

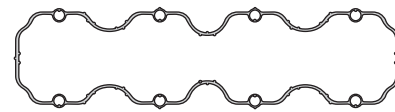

241010

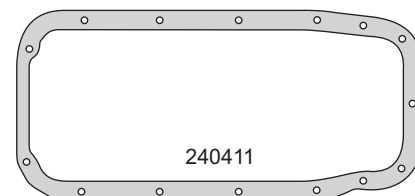

240411

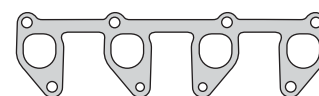

240416



241017

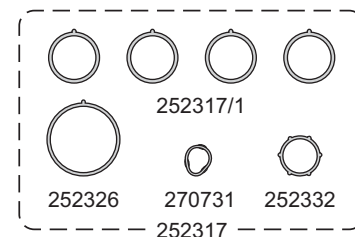

252317/1

252326

270731

252332

252317

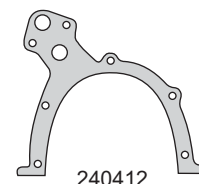

240412



240018



240428

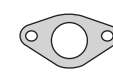

240429



241230

G 9.19 x 2.62



G 37.47 x 3



G 64.77 x 2.62



G 79.5 x 3



R240411V



R240013V



R240415V



R240210V



R242210V

# CHEVROLET



Motor/Engine	Cm³	HP	Ø
C16 SE 8V	1598	75/100	79
X16 SZR 8V	1598	75/100	79

Chevrolet: Corsa, Vectra, Kadett 1999/...



Nº OE	Descripción/Description	Mat.	Ref.
	Jgo. de juntas para motor		242300-R
	Jgo. de juntas superior	●	242395
	Jta. tapa cilindros Ø 80.5 ± 1.40	NFT	240405
	Jta. tapa cilindros Ø 80.5 ± 1.40 <b>NR</b>	NFT 1 1	240407
	Jgo. tornillos tapa cilindros  (HAE12038)		B240400-1
	Junta tapa válvulas	N 1 1	241010
	Junta para cárter	CG 1 1	240411
	Frente motor bomba aceite	NB 1 1	240412
	Múltiple admisión y escape	NFT 1 1	240416
	Múltiple admisión GM Vectra - Kadett	NB 1 1	241017
	Múltiple admisión GM Corsa	NB 1 1	240617
	Junta termostato	GS 1 1	241219
	Junta base termostato	N 1 1	240428
	Salida gases 1.4	NB 1 1	240429
	Junta soporte inyección TBI	CB 1 1	241230
	Anillo goma	NB 1 1	241231
	O'ring G 64.77 x 2.62	GS 1 1	
	O'ring G 79.5 x 3	GS 1 1	
	O'ring G 9.19 x 2.62	GS 1 1	
	Kit de retenes completo		R240400
	Jgo. retén válvulas (8)	V 1 1	R240210V
	Retén bancada 80 x 98 x 10	P 1 1	R240411P
	Retén distrib. bomba aceite 26 x 42 x 8	P 1 1	R240415P
	Retén árbol levas 35 x 48 x 7	P 1 1	R240013P

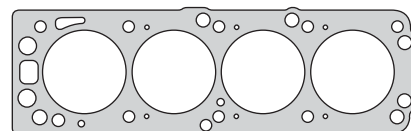

240407

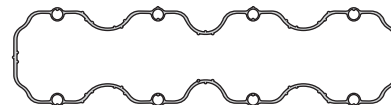

241010

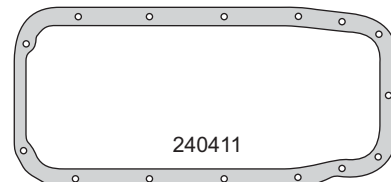

240411

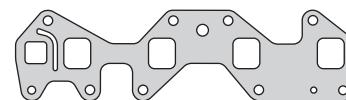

240617

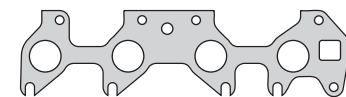

241017

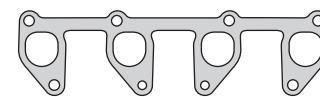

240416

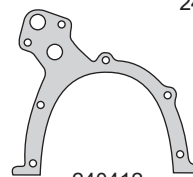

240412



241219



240428



240429



241231



241230



G 79.5 x 3



G 9.19 x 2.62



G 64.77 x 2.62



R240411P



R240013P



R240415P



R240210V

# CHEVROLET



Motor/Engine	Cm³	HP	Ø
Y17 DIT/DTL Iny. Directa (DOHC) 16V	1686	65/75	79

**Chevrolet:** Corsa, Astra G DTI, Corsa C DI  
Combo Tour TD 2000/...

DIESEL



Nº OE	Descripción/Description	Mat.	Ref.
	Jgo. de juntas para motor		242501-R
	Junta tapa cilindros Ø 80.0 ± 1.40	NFT	242507-SM
	Junta tapa cilindros Ø 80.0 ± 1.50	NFT	242507-1M
	Junta tapa cilindros Ø 80.0 ± 1.60	NFT	242507-2M
97102350-SM	Junta tapa cilindros Ø 80.0 ± 1.40	MLS	242508-SM
97102350-1M	Junta tapa cilindros Ø 80.0 ± 1.50	MLS	242508-1M
97102350-2M	Junta tapa cilindros Ø 80.0 ± 1.60	MLS	242508-2M
	Jgo. tornillos tapa cilindros (HAH10055/10140)		B280200
97183007	Junta tapa válvulas	N	1 242510
	Junta para cárter superior	NFT	1 242511
	Bomba de agua	CB	1 280214
97219444	Múltiple escape	AC	1 242515
97218652	Múltiple admisión	NB	1 242517
97183214	Base porta termostato	NB	242519
	Junta filtro de aire	NB	1 280230
97183468	Junta caja porta árbol levas a tapa cilindros	SLS	1 242531
97313965	Junta caja porta árbol levas a tapa cil. - Meriva TD	SLS	1 242531-1
94457048	Tapa termostato	NB	1 242534
97218651	Entre colectores admisión	NB	1 242536
97185863	Cierre gases tapa válvulas	NB	4 242537
97189134	Guarnición base filtro de aceite	SLS	1 242538
94362672	Retorno aceite turbo a turbo	NB	242539
	Junta cárter inferior	NB	1 242541
	Arandela A 14 x 20 x 1.5 C	CU	1
94000378	Arandela entrada agua A 20 x 28 x 1 C	CU	1
94420097	O´ring sellador válvula G 14 x 2	GS	1
90448217	O´ring llenado aceite G 37.47 x 3	GS	1
	O´ring G 64.77 x 2.62	GS	1
	Kit de retenes completo		R242500
	Jgo. retén válvulas (16)	V	1 R230510V
	Retén bancada trasera 87 x 100 x 8.5	V	1 R280211V
	Retén distribución 54 x 82 x 11.45	P	1 R242512P
	Retén árbol de levas 38 x 50 x 6	V	1 R452113V
	Retén bomba depresora 17.5 x 32 x 6	V	1 R280215V

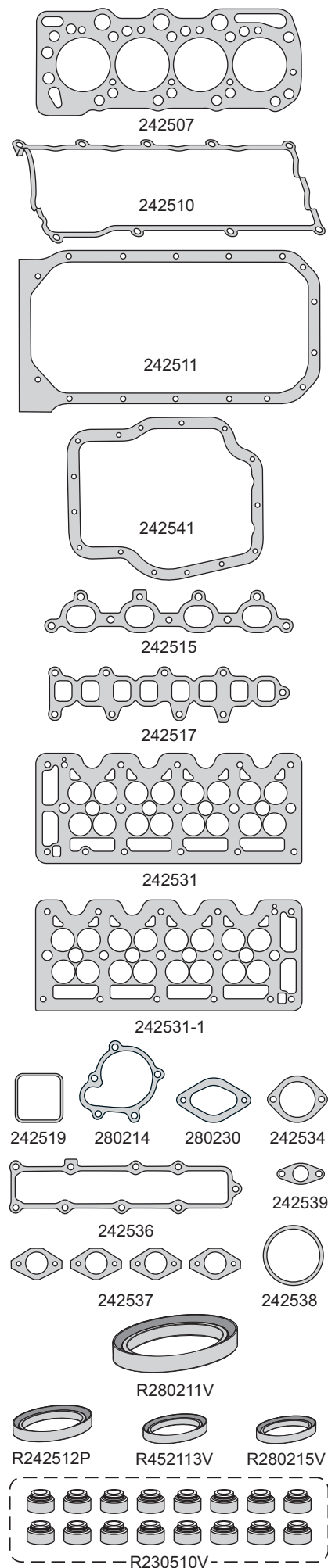

# CHEVROLET



Motor/Engine	Cm³	HP	Ø
262 TK V6	4300		101.6

Chevrolet: Pick Up 1986/92



Nº OE	Descripción/Description	Mat.	Ref.
	Jgo. de juntas para motor		242700-RMX
	Jgo. de juntas superior	●	242795
	Jta. tapa cilin. Ø105.0 ±1.20 (2)	NFT	290605
	Jta. tapa cilin. Ø105.0 ±1.20 (2)	NFT	1 1 290607
	Jgo. junta tapa válvulas (2)	GS	1 1 242710
	Junta para cárter	GS	1 1 242711
	Junta distribución	CB	1 1 280112
	Jgo. múltiple escape (6)	NFT	1 1 242116
	Jgo. múltiple admisión (4)	NFT	1 1 242117-1MX
	Salida de escape	FCH	1 1 540118
	Bomba de agua	CB	1 1 280119
	Junta base bomba nafta	CB	1 200028
	Junta EGR	NFT	1 280828
	Junta acople bba aceite	CB	2 200029
	Guarnición unión admisión	CG	1 1 242730
	Guarnición unión admisión	CG	1 1 242731
	Junta	CB	1 242732
	Junta tapa de inspección	CB	1 280132
	Junta	CB	1 242132
	Junta porta reten	CB	2 280834
	Junta	NB	1 242139
	Arandela A 33 x 46	CB	1 280143
	Junta	CB	1 280144
	Arandela A 12 x 16 x 2 A	AL	1
	O'ring G 15.54 x 2.62	GS	1
	O'ring G 66.27 x 3.53	GS	1
	Kit de retenes completo		R242100
	Jgo. reten válvulas (12)	P	1 R242110P
	Reten bancada 95 x 115 x 12.5	S	1 R242111S
	Reten distribución 44.47 x 61.19 x 9.57	P	1 R200012P

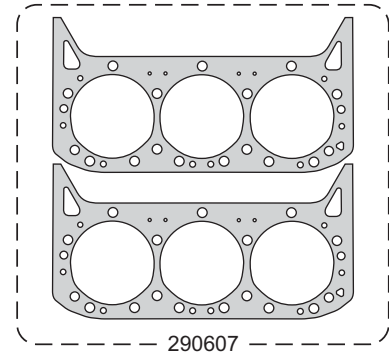

290607

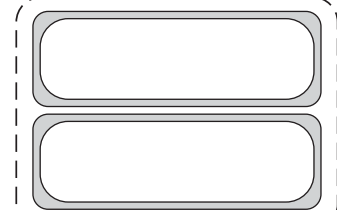

242710

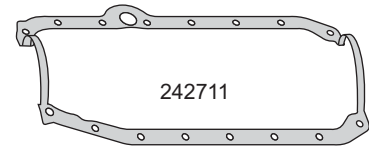

242711

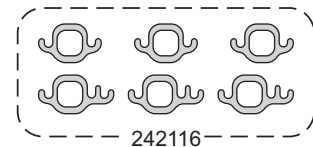

242116

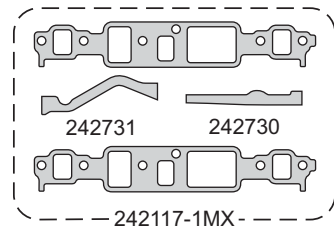

242731 242730

242117-1MX



280112



540118



280119



200028



280828



200029



242732



280132



242132



242139



280143



280834



280144



R242111S

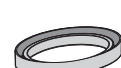

R200012P

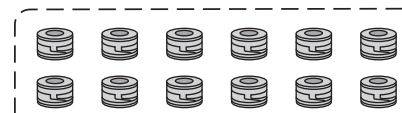

R242110P

# CHEVROLET



Motor/Engine	Cm³	HP	Ø
172 V6 Carburados	2800		

**Chevrolet:** Citation, Celebrity, Century  
1982/86



Nº OE	Descripción/Description	Mat.	Ref.
	Jgo. de juntas para motor		242800-R
	Jgo. de junta superior		242895
	Jgo. junta tapa cilindros Ø92.5 ±1.20 (2)	NFT 1 1	242805
	Jgo. junta tapa válvulas (2)	CG 1 1	242810
	Jgo. junta para cárter (3)	CG 1 1	242811
	Tapa distribución	NB 1 1	241912
	Tapa distribución	CG 1 1	242813
	Bomba de agua	CB 1 1	242814
	Jgo. múltiple escape (3)	NFT 1 1	242816
	Jgo. múltiple admisión (4)	NFT 1 1	242817
	Junta bomba aceite	CB 1 1	290227
	Junta	NB 1 1	242830
	Guarnición cierre admisión	GS 2 2	241930
	Junta	NB 1 1	242831
	Junta	NB 1 1	242832
	Junta entre múltiples	NB 1 1	241933
	Junta	NB 1 1	242833
	Junta	CG 1 1	242834
	O'ring G 7 x 10 x 2	GS 12 12	
	O'ring G 23.39 x 3.53	GS 1 1	
	Kit de retenes completo		R242800
	Jgo. retén válvulas (12)	P 1 1	R242110P
	Retén bancada 76 x 92 x 10	P 1 1	R241911P
	Retén distribución 44.47 x 61.19 x 9.57	P 1 1	R200012P

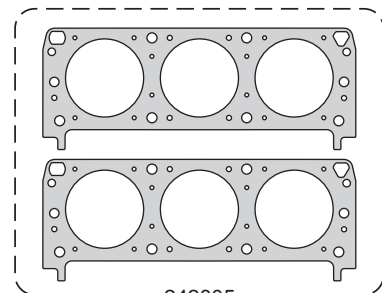

242805

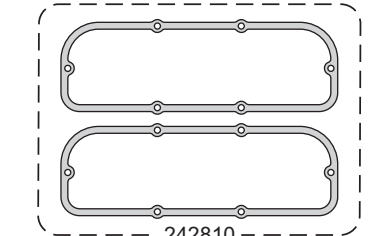

242810

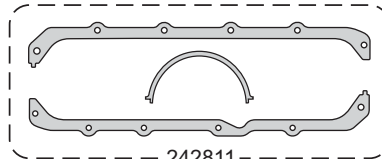

242811

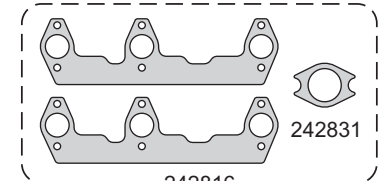

242816

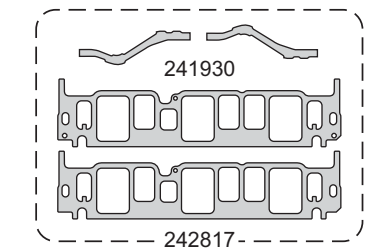

242817

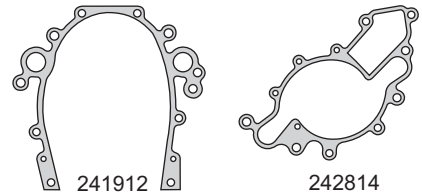

241912

242814

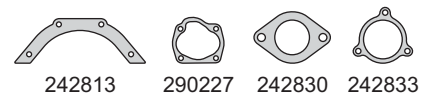

242813

290227

242830

242833

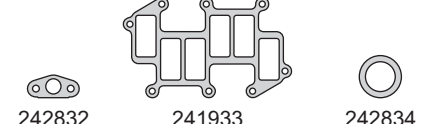

242832

241933

242834



G 7 x 10 x 2

G 23.39 x 3.53



R241911P

R200012P



R242110P

# CHEVROLET



Motor/Engine	Cm³	HP	Ø
L4 - 151	2500		

Chevrolet: Pontiac Vin E 1988/92



Nº OE	Descripción/Description	Mat.	●	●	Ref.
	Jgo. de juntas para motor				242900-RMX
	Jgo. de juntas superior		●		242995
	Jgo. junta tapa cilindros Ø 103.0 ± 1.20		NFT	1 1	242905
	Junta tapa válvulas		CG	1 1	242910
	Jgo. junta para cárter (4)		CG	1	242911
	Tapa distribución		NB	1	200312
	Bomba de agua		NB	1	200014
	Bomba de agua		CB	1	242914
	Múltiple escape		NFT	1 1	242916
	Múltiple admisión		NFT	1 1	242917
	Salida de escape		NFT	1 1	242918
	Tapa bomba de aceite		NB	1	200027
	Junta bomba nafta		CB	1	200028
	E.G.R		NFT	1	280828
	Junta		NB	2	242930
	Junta		NB	1	242931
	Junta		CB	1	242933
	Junta		CG	1	242934
	Junta		CB	1	242935
	Junta		CG	1 1	242936
	Junta		NB	1	242937
	Válvula E.G.R		NFT	1	280839
	Junta		CB	1	290343
	O'ring G 40.94 x 2.62		GS	1	
	O'ring G 7 x 10 x 2		GS		
	O'ring G 6.07 x 1.78		GS	1	
	Kit de retenes completo				R242900
	Jgo. retén válvulas (8)		P	1	R242910P
	Retén bancada 75.9 x 95 x 11.3		P	1	R200811P
	Retén distribución 44,47 x 61.19 x 9,57		N	1	R200012N

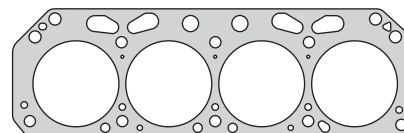

242905

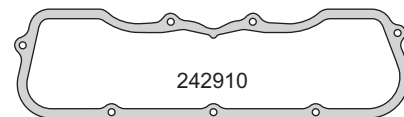

242910

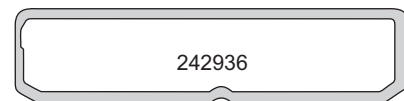

242936

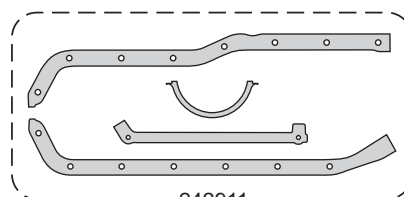

242911



242916



242917

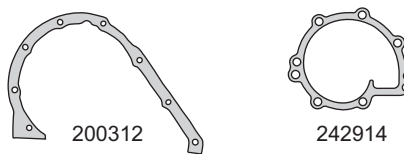

200312

242914

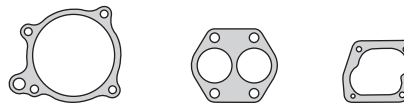

200014

242918

200027

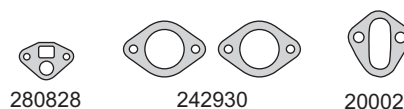

280828

242930

200028



242933

242934

242935

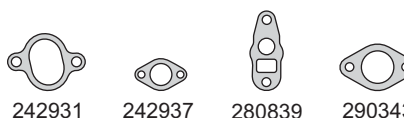

242931

242937

280839

290343



G 6.07 x 1.78

G 7 x 10 x 2

G 40.94 x 2.62



R200811P

R200012N



R242910P

# CHEVROLET



Motor/Engine	Cm³	HP	Ø
MPFI VHC	999	60	71.1

Chevrolet: Celta, Classic, Corsa 2003/...



Nº OE	Descripción/Description	Mat.	Ref.
	Jgo. de juntas para motor		● 243300-R MLS
	Jgo. de juntas superior (MLS)	●	243395 MLS
	Jta. tapa cilindros Ø 73.5 ± 1.40	NFT	240905
	Jta. tapa cilindros Ø 73.5 ± 1.40	NFT	240907
	Jta. tapa cilindros Ø 74.0 ± 1.40	MLS	1 1 240908
	Jgo. tornillos tapa cilindros (HAE12038)		B240400-1
	Junta tapa válvulas	N	1 1 241010
	Junta para cárter	CG	1 240411
	Frente motor bomba aceite	NB	1 240412
	Múltiple admisión y escape	NFT	1 1 240416
	Múltiple admisión	NB	1 1 241017
	Jgo. múltiple admisión (6)	GS	1 1 243317
	Junta termostato	GS	1 241219
	Salida gases 1.4	NB	1 1 240429
	Junta soporte inyección TBI	CB	1 1 241230
	Anillo goma	NB	1 241231
	Conducto agua admisión a EGR	GS	1 1 243331
	Conducto agua admisión a EGR	GS	1 1 270731
	Junta soporte inyeccion TBI	GS	1 1 243332
	O'ring G 64.77 x 2.62	GS	1 1
	O'ring G 79.5 x 3	GS	1
	O'ring G 9.19 x 2.62	GS	1
	Kit de retenes completo		R240400
	Jgo. retén válvulas (8)	V	1 R240210V
	Retén bancada 80 x 98 x 10	P	1 R240411P
	Retén árbol levas 35 x 48 x 7	P	1 R240013P
	Retén distrib. bomba aceite 26 x 42 x 8	P	1 R240415P

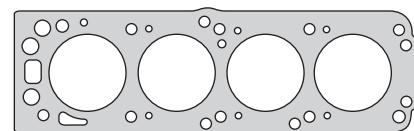

240908

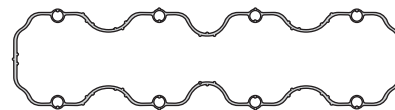

241010

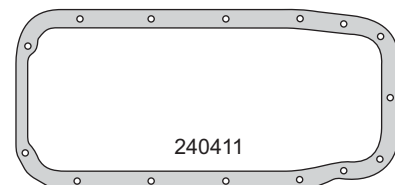

240411

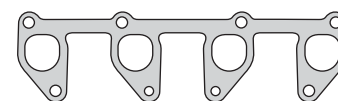

240416

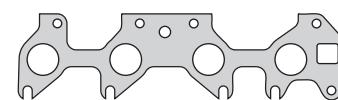

241017

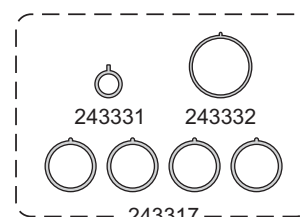

243331 243332

243317

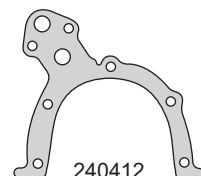

240412



241219



240429



241230



270731



241231



G 64.77 x 2.62



G 9.19 x 2.62



G 79.5 x 3



R240411P



R240013P



R240415P



R240210V

# CHEVROLET



Motor/Engine		Cm <sup>3</sup>	HP	Ø
Powertrain		2405	147	87.5

Chevrolet: Astra 2004/..., S10 2005/...  
Vectra 2006/...



Nº OE	Descripción/Description	Mat.	Ref.
	Jgo. de juntas para motor		● 243400-R MLS
	Jgo. de juntas superior (MLS)	●	243495 MLS
	Junta tapa cilindros Ø89.0 ± 1.20	NFT	243407
56 07 409	Junta tapa cilindros Ø89.0 ± 1.10	MLS	1 1 243408
	Jgo. tornillos tapa cilin. (HAT55055/55100)		B280700
607 647	Conj. tapa de válvulas (11)	N	1 1 280710
652 635	Junta para cárter superior	NFT	1 290811
	Bomba aceite filtro a block	NB	1 240012
90220436	O´ring bomba de agua G 88.57 x 2.62	GS	1 280614
850 656	Múltiple escape	NFT	1 1 280715
850 655	Múltiple admisión	NB	1 1 280717
854 933	Salida de escape	FCH	1 1 240018
	Placa admisión	NFT	1 1 280729
	Guarnición goma termostato G 44.17 x 1.78	GS	1 1 280730
	Guarnición goma termostato G 66.4 x 1.78	GS	1 1 280731
652 636	Junta para cárter inferior	CG	1 290832
	Nivel aceite	SLS	1 280733
	Junta	NB	1 290833
	Junta	NB	1 290834
	Junta	CG	1 290835
	Arandela A 14 x 20 x 1C	CU	1
	Arandela A 20 x 24 x 1.5 A	AL	1
	O´ring G 9 x 2	GS	10 10
	O´ring G 15.54 x 2.62	GS	1
	O´ring G 16 x 2	GS	1
	O´ring G 47.22 x 3.53	GS	2
	O´ring G 50 x 4	GS	1
	O´ring G 52.07 x 2.62	GS	1
	O´ring G 53.7 x 1.78	GS	1
	O´ring G 64.77 x 2.62	GS	3
	Kit de retenes completo		R280700
642 533	Jgo. retén válvulas (16)	V	1 R280610V
614 827	Retén bancada 90 x 104 x 11	V	1 R240211V
646 265	Retén distribución 31 x 50 x 8	V	1 R240012V
636 841	Retén árbol de levas 35 x 48 x 7	V	2 R240013V

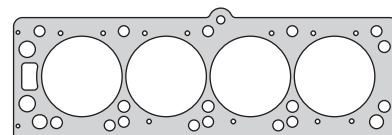

243408

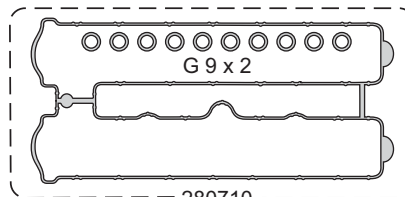

280710

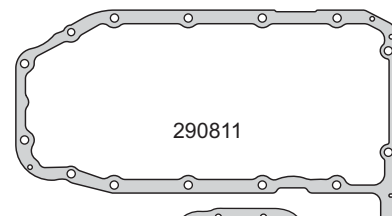

290811

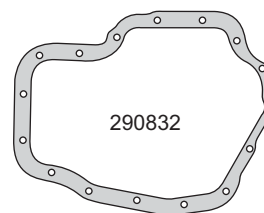

290832



280715



280717

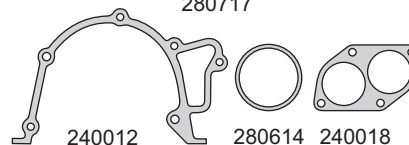

240012

280614

240018

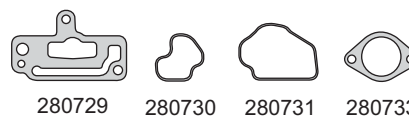

280729

280730

280731

280733

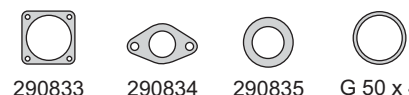

290833

290834

290835

G 50 x 4



G 64.77 x 2.62

G 47.22 x 3.53

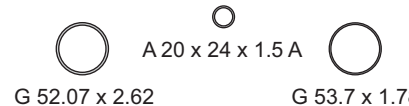

G 52.07 x 2.62

G 53.7 x 1.78



G 15.54 x 2.62

G 16 x 2

A 14 x 20 x 1 C



R240211V



R240012V



R240013V

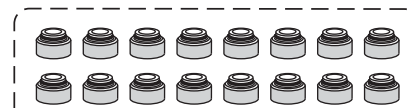

R280610V



# CHEVROLET



Motor/Engine	Cm³	HP	Ø
X17 DTL (SOHC) 8V	1699	68	82.5

**Chevrolet:** Astra TD 1994/97  
Astra GTD 1998/00  
**Motor 1455260 08/1994**

DIESEL



Nº OE	Descripción/Description	Mat.	Ref.
	Jgo. de juntas para motor		243501-R
	Jgo. de juntas superior		243595
5607443	Junta tapa cilindros Ø 84.0 ±1.30	MLS	243508-SM
5607444	Junta tapa cilindros Ø 84.0 ±1.40	MLS	243508-1M
5607445	Junta tapa cilindros Ø 84.0 ±1.50	MLS	243508-2M
	Jgo. tornillos tapa cilin. (HAT55055/55100)		B241700
638192	Junta tapa válvulas	GS	1 1 241410
652608	Junta para cárter superior	NB	1 243511
652609	Junta para cárter inferior	NB	1 243532
90106615	Frente bomba aceite a block	NB	1 1 240012
90106456	O'ring bomba de agua G 90 x 3	GS	1 240014
850608	Múltiple escape	NFT	1 1 241616
850616	Múltiple admisión	NB	1 1 241617
90122268	Junta válvula nivel de aceite	NB	1 240029
	Arandela B 18 x 24 x 2.3 CN	CN	450029
	Junta termostato	GS	1 1 560131
854929	Salida de escape	CHA	1 1 241640
	O'ring G 48 x 4	GS	1 1
	O'ring G 15.54 x 2.62	GS	1 1
469011	Arandela bomba aceite A 14 x 20 x 1.5 A	CU	2
	Arandela inyectores A 14 x 22 x 2 C	CU	4 4
	Arandela A 17 x 21 x 6.5 C	CU	4 4
	Kit de retenes completo		R241600
642526	Jgo. retén válvulas (8)	P	1 R240010P
614827	Retén bancada 90 x 104 x 11	V	1 R240211V
646266	Retén distribución 35 x 48 x 7	V	1 R240013V
646290	Retén árbol levas 35 x 50 x 7	V	1 R470013V

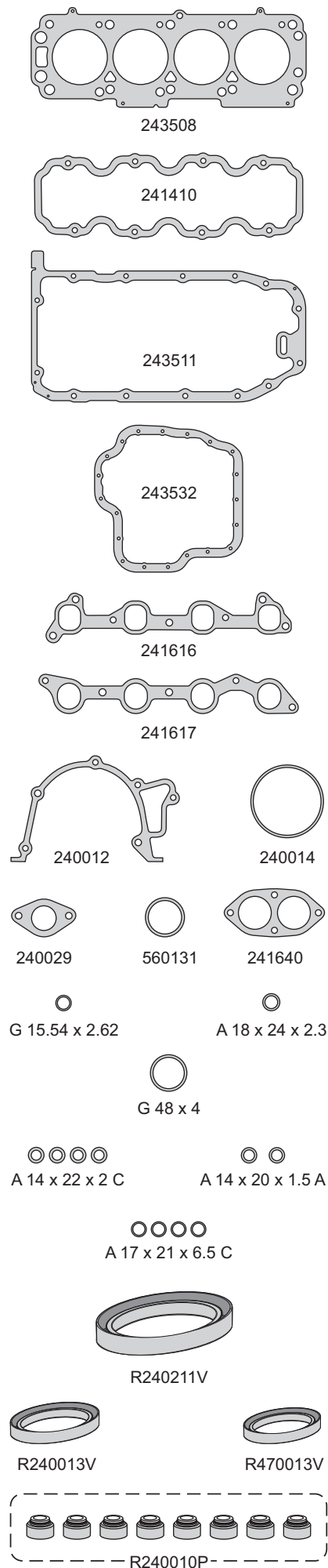

# CHEVROLET



**Motor/Engine** **Cm³** **HP** **Ø**

**X14SE/Y14NE** **1389** **90/92** **77.6**

**Chevrolet:** Corsa Econoflex, Classic, Agile  
Celta 2006/2009 - 2009/...



Nº OE	Descripción/Description	Mat.	Ref.
	Jgo. de juntas para motor		244000-R
	Jgo. de juntas superior	●	244095
	Junta tapa cilindros Ø79.0 ±1.70	NFT	241005
	Junta tapa cilindros Ø79.0 ±1.20	NFT	241007
	Junta tapa cilindros Ø79.0 ±1.80	NFT 1 1	241007-1.8
	Junta tapa cilindros Ø79.0 ±1.50	MLS	241008
	Jgo. tornillos JTC (HAE12038/HAS13038)		B244000
7083232	Junta tapa de válvulas	N 1 1	241010
	Junta cárter con control de compresibilidad	CG	240411
7083280	Frente motor y bomba de aceite	SLS	241812
	O'ring cierre bomba de agua G 79.5 x 3	GS	240414
93396858	Múltiple escape	AC 1 1	240415
90571863	Múltiple admisión	NB 1 1	241017
7084980	Jgo. múltiple admisión (7)	GS 1 1	252317
73502844	Salida de escape catalizador	AC 1 1	252318
90128293	Salida de escape	FCH	240018
	Junta termostato	GS	241219
7084981	Junta cuerpo mariposa aceleración	GS 1 1	252326
	Junta soporte inyección TBI	CB	241230
7083288	Descarga gases	NB	240429
7086225	Conducto agua admisión a EGR	GS 1 1	270731
	Guarnición acople admisión	GS 1 1	252332
7083229	Guarnición tapa llenado de aceite G 38 x 4	GS 1 1	
	O'ring G 64.77 x 2.62	GS 1 1	
	Kit de retenes completo		R244000
7083335	Jgo. retén válvulas (8)	V 1	R244010V
7084149	Retén bancada 80 x 98 x 10	V 1	R240411V
90280463	Retén árbol de levas 35 x 48 x 7	V 1	R240013V
90501719	Retén distribución 26 x 42 x 8	V 1	R240415V

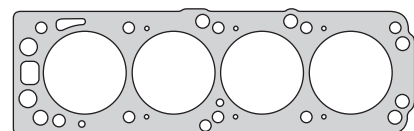

241007-1.80

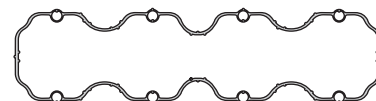

241010

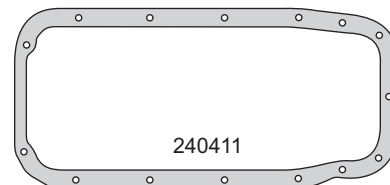

240411

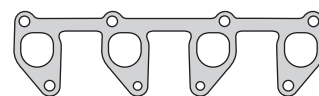

240415

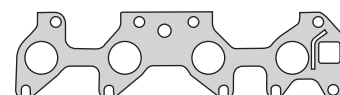

241017

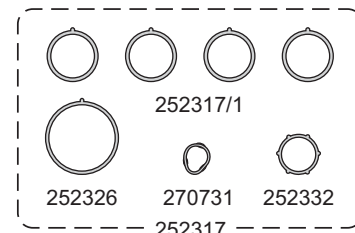

252317/1

252326

270731

252332

252317

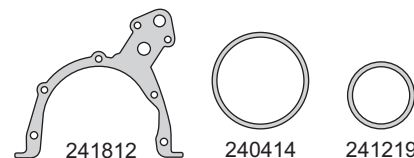

241812

240414

241219

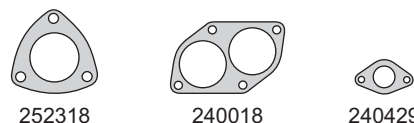

252318

240018

240429



241230

G 64.77 x 2.62

G 38 x 4



R240411V



R240013V



R240415V



R244010V

# CHEVROLET



Motor/Engine	Cm³	HP	Ø
N18XFN	1796	108	80.5

Chevrolet: Spin, Cobalt 2012/...



Nº OE	Descripción/Description	Mat.	Ref.
	Jgo. de juntas para motor		● 244100-R MLS
	Jgo. de juntas superior	●	244195 MLS
	Jgo. de juntas superior (JTC 05)		244195
	Junta tapa cilindros Ø82.0 ± 1.40	NFT	242205
	Junta tapa cilindros Ø82.0 ± 1.40 NR	NFT	242207
93294583	Junta tapa cilindros Ø82.0 ± 1.40 NR	MLS	1 1 242208
90409594	Junta tapa válvulas	N	1 1 241010
90573301	Frente motor bomba de aceite	SLS	1 1 241812
09158173	O´ring bomba de agua G 80 x 3	GS	1 1 240414
24579972	Múltiple admisión y escape	AC	1 1 240415
7084890	Jgo. múltiple admisión (6)	GS	1 1 243317
94733773	Salida de escape	AC	1 1 244118
73502844	Salida de escape catalizador	AC	1 1 252318
90128293	Salida gases 1.4	NB	1 240429
24579938	Conducto agua admisión a EGR	GS	1 1 243331
93397787	Junta soporte inyección TBI	GS	1 1 243332
93278411	O´ring tapa de válvulas G 64.77 x 2.62	GS	1
90190637	O´ring G 15.54 x 2.62	GS	1
	Kit de retenes completo		R244000
90410741	Jgo. retén válvulas (8)	V	1 R244010V
24578614	Retén bancada 80 x 98 x 10	V	1 R240411V
90511719	Retén distribución 26 x 42 x 8	V	1 R240415V
90180529	Retén árbol levas 35 x 48 x 7	V	1 R240013V

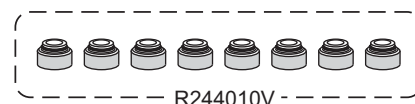
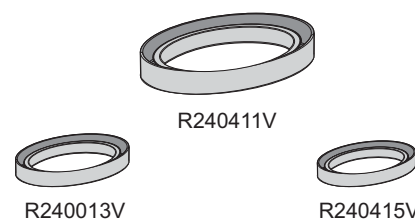
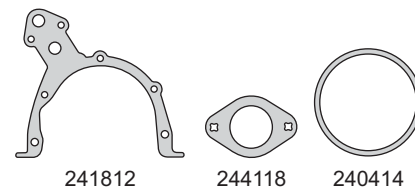
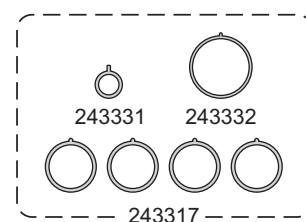
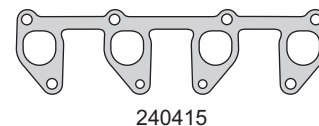
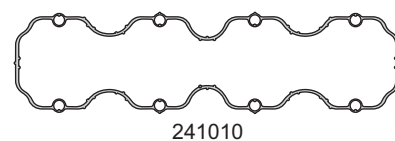
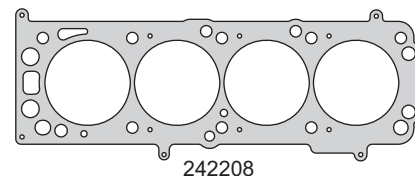

# CHEVROLET



Motor/Engine Cm³ HP Ø

SPE/4 999 80 71.1

Chevrolet: Prisma, Onix



Nº OE	Descripción/Description	Mat.	Ref.
	Jgo. de juntas para motor		244200-R MLS
	Jgo. de juntas superior	●	244295
	Jta. tapa cilindros Ø 73.5 $\pm$ 1.40	NFT	240905
	Jta. tapa cilindros Ø 73.5 $\pm$ 1.40	NFT 1	240907
93221445	Jta. tapa cilindros Ø 74.0 $\pm$ 1.40	MLS 1	240908
	Jgo. tornillos tapa cilindros (HAE12038)		B242200
24578675	Junta tapa válvulas	GS 1	244210
90573301	Frente motor bomba de aceite	SLS 1	241812
09158173	O´ring bomba de agua G 79.5 x 3	GS 1	240414
24579972	Múltiple admisión y escape	AC 1	240415
7084890	Jgo. múltiple admisión (6)	GS 1	243317
94733773	Salida de escape	AC 1	244118
90128293	Salida gases 1.4	NB 1	240429
24579938	Conducto agua admisión a EGR	GS 1	243331
93397787	Junta soporte inyección TBI	GS 1	243332
	Kit de retenes completo		R244000
90410741	Jgo. retén válvulas (8)	V 1	R244010V
24578614	Retén bancada 80 x 98 x 10	V 1	R240411V
90511719	Retén distribución 26 x 42 x 8	V 1	R240415V
90180529	Retén árbol levas 35 x 48 x 7	V 1	R240013V

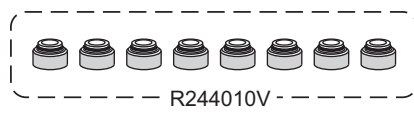
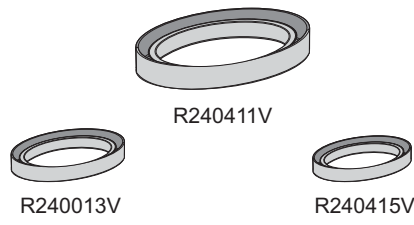
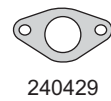
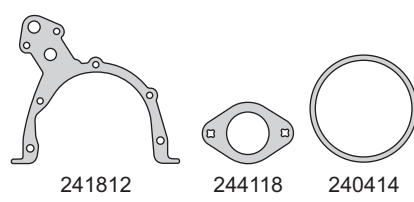
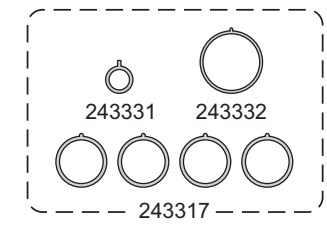
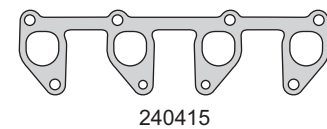
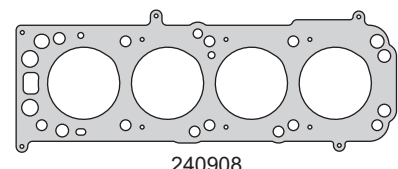

# CHEVROLET



Motor/Engine	Cm³	HP	Ø
SPE/4	1389	106	77.6

Chevrolet: Prisma, Onix



Nº OE	Descripción/Description	Mat.	Ref.
	Jgo. de juntas para motor		244300-R
	Jgo. de juntas superior	●	244395
	Jgo. de juntas superior (MLS)		244395 MLS
	Jta. tapa cilindros Ø 79.0 $\pm$ 1.70	NFT 1 1	241005
	Jta. tapa cilindros Ø 79.0 $\pm$ 1.20	NFT	241007
93346293	Jta. tapa cilindros Ø 79.0 $\pm$ 1.80	NFT	241007-1.80
	Jta. tapa cilindros Ø 79.0 $\pm$ 1.50	MLS	241008
	Jgo. tornillos tapa cilindros (HAE12038)		B242200
24578675	Junta tapa válvulas	GS 1 1	244210
	Junta para carter	CG 1	240411
90573301	Frente motor bomba de aceite	SLS 1	241812
09158173	O'ring bomba de agua G 80 x 3	GS 1 1	240414
24579972	Múltiple admisión y escape	AC 1 1	240415
	Jgo. múltiple admisión (7)	GS 1 1	252317
94733773	Salida de escape	AC 1 1	244118
7084981	Junta cuerpo mariposa aceleración G3	GS 1 1	252326
90128293	Salida gases 1.4	NB 1	240429
7086225	Conducto agua admisión a EGR	GS 1 1	270731
	Guarnición acople admisión	GS 1 1	252332
	Kit de retenes completo		R244000
90410741	Jgo. retén válvulas (8)	V 1	R244010V
24578614	Retén bancada 80 x 98 x 10	V 1	R240411V
90511719	Retén distribución 26 x 42 x 8	V 1	R240415V
90180529	Retén árbol levas 35 x 48 x 7	V 1	R240013V

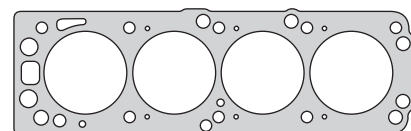

241007-1.80



244210

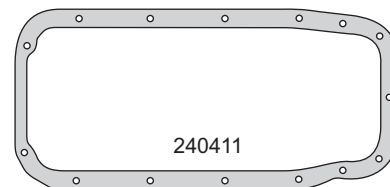

240411

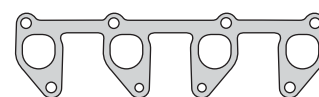

240415

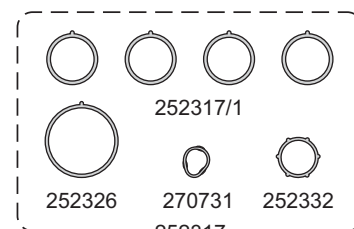

252317/1

252326

270731

252332

252317

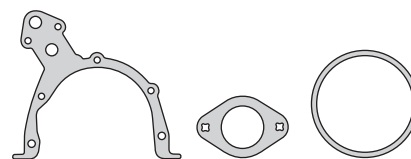

241812

244118

240414

240429



R240411V



R240013V



R240415V

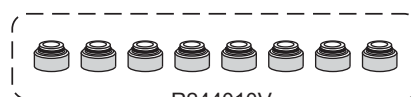

R244010V

# CHEVROLET



Motor/Engine	Cm³	HP	Ø
C24SE 8V (SOHC) 8V	2405	147	87.5

Chevrolet: Blazer, S10



Nº OE	Descripción/Description	Mat.	Ref.
	Jgo. de juntas para motor		244400-R
	Jgo. de juntas superior	●	244495
	Jta. tapa cilindros Ø 88.0 ± 1.40	NFT 1 1	244407
90467661	Junta tapa de válvulas	N 1 1	241410
6 52 635	Junta para cárter superior	NFT 1 1	290811
90106615	Bomba aceite filtro a block	NB 1 1	240012
	Múltiple admisión y escape	NFT 1 1	240016
	Múltiple admisión	NFT 1 1	240517
90128293	Múltiple admisión	NB 1 1	241417
	Jgo. múltiple admisión (5)	GS 1 1	244417
94649659	Salida de escape	FCH 1 1	240018
	Junta mando	NB 1 1	240029
	Junta soporte inyección TBI	CB 1 1	241230
	Junta	NB 1 1	241430
90231306	Junta	NB 1 1	241431
90183165	Tubo separador bomba aceite	NB 1 1	240232
6 52 636	Junta sobre cárter	CG 1 1	290832
	Válvula termostato	NB 1 1	240233
	Arandela A 14 x 18 x 1.5 A	AL 1 1	
	O´ring G 15.54 x 2.62	GS 1 1	
	O´ring G 16 x 2	GS 1 1	
	O´ring G 47.29 x 2.62	GS 1 1	
	O´ring G 48 x 4	GS 1 1	
	O´ring G 50 x 4	GS 1 1	
	O´ring G 52.07 x 2.62	GS 1 1	
	O´ring G 55.25 x 2.62	GS 1 1	
	O´ring G 64 x 3	GS 2 2	
	O´ring G 64.77 x 2.62	GS 1 1	
	O´ring G 88 x 3	GS 1 1	
	Kit de retenes completo		R240200
	Jgo. retén válvulas (8)	V 1 1	R240210V
614 827	Retén bancada 90 x 104 x 11	P 1 1	R240211P
646 265	Retén distribución 31 x 50 x 8	P 1 1	R240012P
636 841	Retén árbol de levas 35 x 48 x 7	P 1 1	R240013P

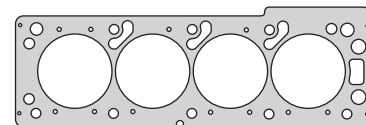

244407

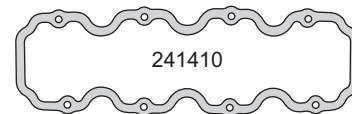

241410

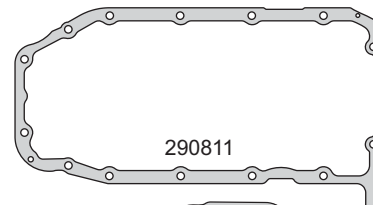

290811

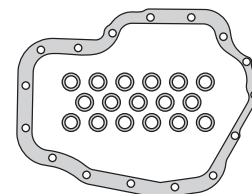

290832

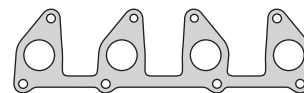

240016



240517



241417

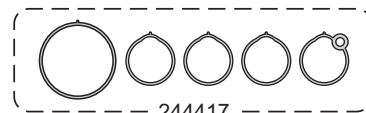

244417

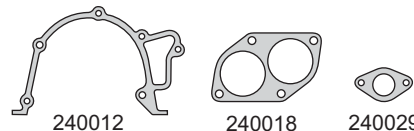

240012

240018

240029

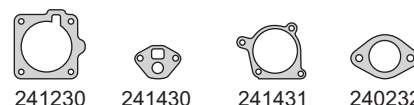

241230

241430

241431

240232



G 88 x 3

G 64 x 3

G 48 x 4

240233



G 52.07 x 2.62

G 16 x 2

G 55.25 x 2.62



G 47.29 x 2.62

G 50 x 4

G 64.77 x 2.62



R240211P

R240012P

R240013P



R240210V

# CHEVROLET



Motor/Engine **Cm³** **HP** **Ø**

**SPE/4** **1796** **111** **80.5**

Chevrolet: Cobalt, Spin 2017/...



Nº OE	Descripción/Description	Mat.		Ref.
	Jgo. de juntas para motor			● 244500-R MLS
	Jgo. de juntas para motor			244500-R
	Jgo. de juntas para motor			244500 MLS
	Jgo. de juntas para motor			244500
	Jgo. de juntas superior		●	244595 MLS
	Jgo. de juntas superior (JTC 05)			244595
	Junta tapa cilindros Ø82.0 $\pm$ 1.40	NFT		242205
	Junta tapa cilindros Ø82.0 $\pm$ 1.40	NFT		242207
93294583	Junta tapa cilindros Ø82.0 $\pm$ 1.40	MLS	1 1	242208
	Jgo. tornillos tapa cilindros (HAE12038)			B242200
	Jgo. tornillos JTC (HAE12038/HAS13038)			B244000
24578675	Junta tapa válvulas	N	1 1	244210
90573301	Frente motor bomba de aceite	SLS		1 241812
09158173	O´ring bomba de agua G 80 x 3	GS	1 1	240414
24579972	Múltiple admisión y escape	AC	1 1	240415
7084890	Jgo. múltiple admisión (6)	GS	1 1	243317
94733773	Salida de escape	AC	1 1	244118
73502844	Salida de escape catalizador	AC	1 1	252318
90128293	Salida gases 1.4	NB		1 240429
24579938	Conducto agua admisión a EGR	GS	1 1	243331
93397787	Junta soporte inyección TBI	GS	1 1	243332
93278411	O´ring tapa de válvulas G 64.77 x 2.62	GS		1
90190637	O´ring G 15.54 x 2.62	GS		1
	Kit de retenes completo			R244000
90410741	Jgo. retén válvulas (8)	V	1	R244010V
24578614	Retén bancada 80 x 98 x 10	V	1	R240411V
90511719	Retén distribución 26 x 42 x 8	V	1	R240415V
90180529	Retén árbol levas 35 x 48 x 7	V	1	R240013V

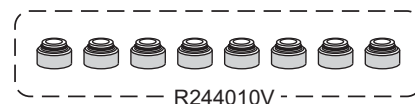
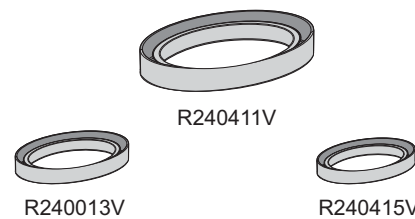
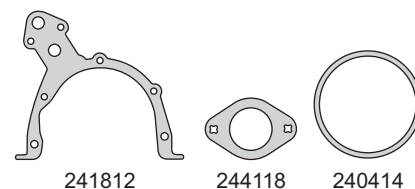
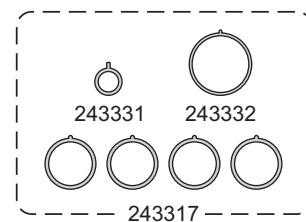
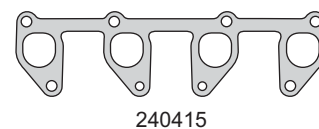
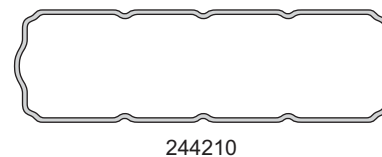
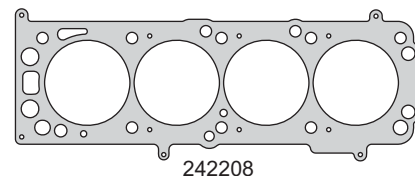

# CHEVROLET



Motor/Engine Cm³ HP Ø

Ecotec (DOHC) 12V 999 82 74

Chevrolet: Onix 2020/...



Nº OE	Descripción/Description	Mat.	Ref.
	<b>Jgo. de juntas para motor</b>		● 244600-R MLS
	Junta tapa cilindros Ø 76.5 $\pm$ 1.20	NFT	244607
55497312	Junta tapa cilindros Ø 75.5 $\pm$ 0.60	MLS	1 244608
	<b>Jgo. tornillos tapa de cilindros</b>		B244600
25197327	Junta tapa de valvulas	GS	1 244610
	Junta para carter	NB	1 244611
	Tapa distribucion	NB	1 244612
55487554	Bomba de agua	GS	1 244614
25194195	Multiple de admisión	GS	1 244617
55496664	Junta termostato	GS	1 244619
55502971	Junta bomba aceite	GS	1 244627
	Junta bomba vacío	SLS	1 244629
25194196	Junta TBI	GS	1 244630
55487252	Salida de agua	GS	1 244632
55511228	Jgo. guarnición bomba de agua (4)	GS	1 244634
	Junta sello cárter	GS	1 244635
	Junta sello cárter	GS	1 244636
12616850	O´ring sello tapón de aceite G11.5 x 20.7 x 2.7	GS	1
12693989	O´ring cigüeñal G 26.5 x 1.70	GS	1
55504437	Anillo sobre cárter G 19 x 23 x 6	GS	1
55504438	Anillo sobre cárter G 11.7 x 15.5 x 6	GS	1
	Jgo. retén válvulas (12)	V	1 R244610V
55487411	Porta retén bancada	V	1 PR244611V
	Porta retén distribución	V	1 PR244612V

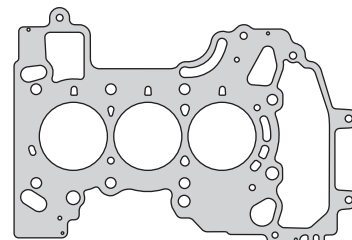

244608

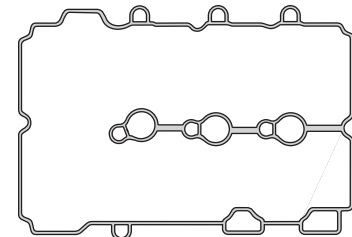

244610

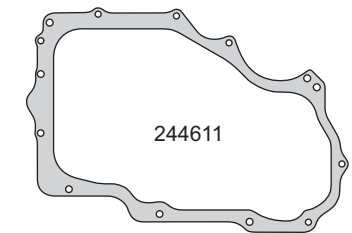

244611



244617

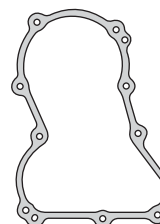

244612



244614



244619

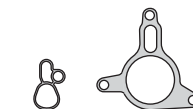

244627

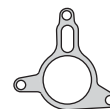

244629



244630



244632



244634



244635



244636



G 19 x 23 x 6

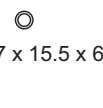

G 11.7 x 15.5 x 6



G 26.5 x 1.70



G 11.5 x 20.7 x 2.7

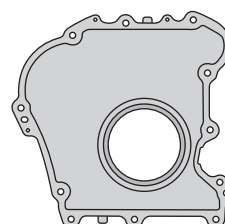

PR244611V

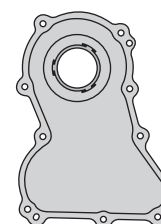

PR244612V

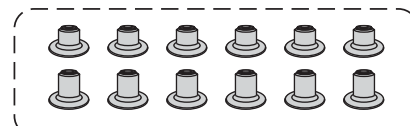

R244610V



# CHEVROLET



Motor/Engine Cm³ HP Ø

Ecotec (DOHC) 12V 999 116 74

Chevrolet: Onix, Tracker 2020/...



Nº OE	Descripción/Description	Mat.	Ref.
	<b>Jgo. de juntas para motor</b>		● 244700-R MLS
	Junta tapa cilindros Ø 75.0 $\pm$ 1.20	NFT	244607
55497312	Junta tapa cilindros Ø 75.0 $\pm$ 0.60	MLS 1	244608
	<b>Jgo. tornillos tapa de cilindros</b>		B244600
55496719	Junta tapa de válvulas	GS 1	244710
	Junta para cárter	NB 1	244611
	Tapa distribución	NB 1	244612
55487554	Bomba de agua	GS 1	244614
55507124	Jgo. múltiple de admisión (3)	GS 1	244717
55496664	Junta termostato	GS 1	244619
55502971	Junta bomba aceite	GS 1	244627
55505453	Junta radiador filtro aceite	GS 1	244727
	Junta bomba vacío	SLS 1	244629
55496679	Junta TBI	GS 1	244730
55486276	Junta TBI	GS 1	244731
55487252	Salida de agua	GS 1	244632
55511228	Jgo. guarnición bomba de agua (4)	GS 1	244634
	Junta sello cárter	GS 1	244635
	Junta sello cárter	GS 1	244636
55494993	Conducto aceite a turbo	SLS 2	244739
55487866	O´ring sello turbo G 7.5 x 2.6	GS 1	
12616850	O´ring sello tapón de aceite G11.5 x 20.7 x 2.7	GS 1	
12693989	O´ring cigüeñal G 26.5 x 1.70	GS 1	
55504437	Anillo sobre cárter G 19 x 23 x 6	GS 1	
55504438	Anillo sobre cárter G 11.7 x 15.5 x 6	GS 1	
	Jgo. retén válvulas (12)	V 1	R244610V
55487411	Porta retén bancada	V 1	PR244611V
	Porta retén distribución	V 1	PR244612V

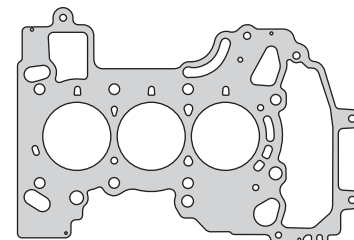

244608

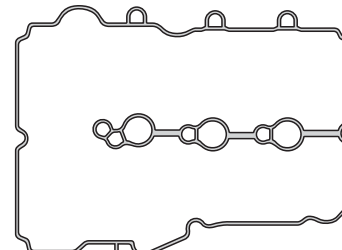

244710

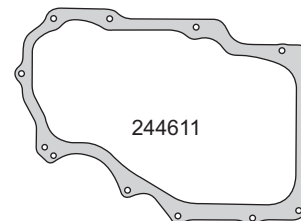

244611



244717

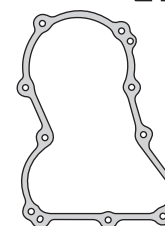

244612



244614



244619



244627



244727



244629



244730



244731



244632

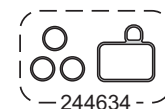

244634



244635



244636



244739

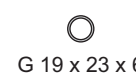

G 19 x 23 x 6



G 26.5 x 1.70

G 7.5 x 2.6



G 11.5 x 20.7 x 2.7



G 11.7 x 15.5 x 6

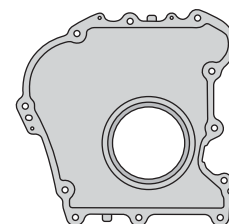

PR244611V

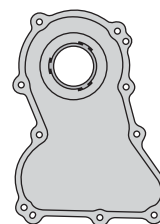

PR244612V

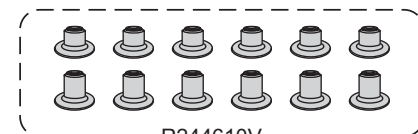

R244610V

# CHEVROLET



Motor/Engine	Cm <sup>3</sup>	HP	Ø
C18NE/NV	1796	90	84.5
C18NZ	1796	90	84.5

**Chevrolet:** Monza, Kadett 1986/91  
Astra 1991/97, Vectra 1989/95



Nº OE	Descripción/Description	Mat.	Ref.
	Jgo. de juntas para motor		280000-R
	Jgo. de juntas superior	●	280095
	Junta tapa cilindros Ø 86.2 ±1.40	NFT 1 1	240005
90122951	Jgo. tornillos tapa cilin. (HAT55055/55100)		B240000
	Junta tapa válvulas	CG 1 1	240010
90220309	Junta para cárter	N 1	240211
90124295	Block a filtro	NB 1	240012
90106432	O'ring tapa bomba de agua G 90 x 3	GS 1	240014
90106456	Múltiple escape	NFT 1 1	240016
90106615	Múltiple admisión	NB 1 1	240217
90215011	Múltiple admisión	NFT 1 1	240517
	Salida de escape	FCH 1 1	240018
90128293	O'ring carcasa termostato G 50 x 4	GS 1 1	240019
90118437	Base carburador	NB 2 2	240025
94624122	O'ring G 16 x 2.5	GS 1	240027
94632563	Base bomba nafta	NB 2	550628
90265732	Nivel aceite	NB 1	240029
90122258	O'ring tubo G 64 x 3	GS 1	240030
90128513	Arandela A 20 x 24 x 1.5 A	AL 1	240031
105462	Arandela bomba aceite A 14 x 20 x 1.5 A	AL 2	240032
11069511	O'ring termostato 55.25 x 2.62	GS	240033
	Arandela tapón cárter B 14 x 18 x 2 CN	CN	150034
	Arandela A 14 x 18 x 1.5 A	AL 1	
	O'ring termostato G 47 x 4	GS 1	
	O'ring G 64.77 x 2.62	GS 1 1	
	Kit de retenes completo		R240200
	Jgo. retén válvulas (8)	V 1	R240210V
	Retén bancada 90 x 104 x 11	P 1	R240211P
	Retén distribución 31 x 50 x 8	P 1	R240012P
	Retén árbol levas 35 x 48 x 7	P 1	R240013P

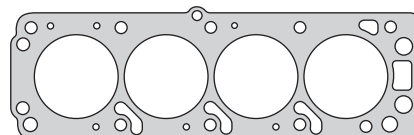

240005

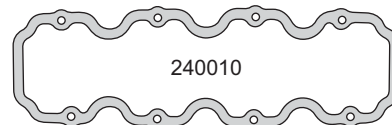

240010

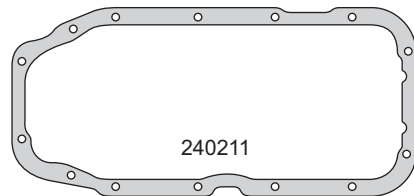

240211

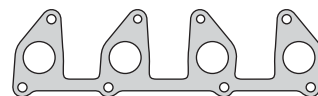

240016



240217



240517



240012



240014



240018



240029



240025



G 16 x 2.5



550628



G 47 x 4



G 64 x 3



G 64.77 x 2.62



G 50 x 4



A 14 x 18 x 1.5 A



A 14 x 20 x 1.5 A



A 20 x 24 x 1.5 A



R240012P



R240211P



R240013P



R240210V

# CHEVROLET



Motor/Engine **GM C350 V8** Cm³ **5735** HP **101.6**

**Chevrolet:** 283, 302, 307, 327 Carburador  
327, 350 No Corvette  
350, Pick Up y Medianos  
283, 307, 327 Camiones 1967/...



Nº OE	Descripción/Description	Mat.	Ref.
	<b>Jgo. de juntas para motor</b>		<b>280100-R</b>
	<b>Jgo. junta tapa cilindros Ø 105.0 ± 1.20 (2)</b>	NFT	<b>1 280105</b>
	Junta tapa válvulas	CG	2 280110
	Jgo. junta para cárter (7)	CG	1 280111-1
	Tapa distribución	CB	1 280112
	Jgo. múltiple escape (2)	NFT	1 280116
	Jgo. múltiple admisión (4)	NFT	1 280117
	Salida de escape	FCH	2 200018
	Salida de escape	NFT	280118
	Codo termostato	CB	280119
	Tapa bomba aceite	CB	280127
	Base bomba nafta	CB	1 200028
	Acople bomba aceite	CB	1 200029
	Base termostato	CB	280131
	Tapa inspección	CB	1 280132
	Puntera cierre admisión Chevrolet C-350	N	1 280133
	Puntera cierre admisión Chevrolet C-350	N	1 280134
	Sello metálico admisión	AC	280135
	Acople escape	NFT	280136
	Subida aceite	NFT	280137
	Bajada aceite	NFT	280138
	Arandela A 33 x 46	CB	1 280143
	Arandela A 67 x 80	CB	280142
	Junta	CB	1 280144
	Junta	CB	1 280145
	Junta	CB	1 280146
	Arandela A 129 x 140	CB	280139
	Arandela A 106 x 116	CB	280140
	Arandela A 78 x 90	CB	280141
	Arandela tapón cárter A 12.8 x 22.8 x 2	PLAST	
	Kit de retenes completo		R280100
	Jgo. retén válvulas (16)	P	1 R280110P
	Retén bancada (2 mitades)	S	1 R200011-1S
	Retén distribución 44.47 x 61.19 x 9.57	P	1 R200012P

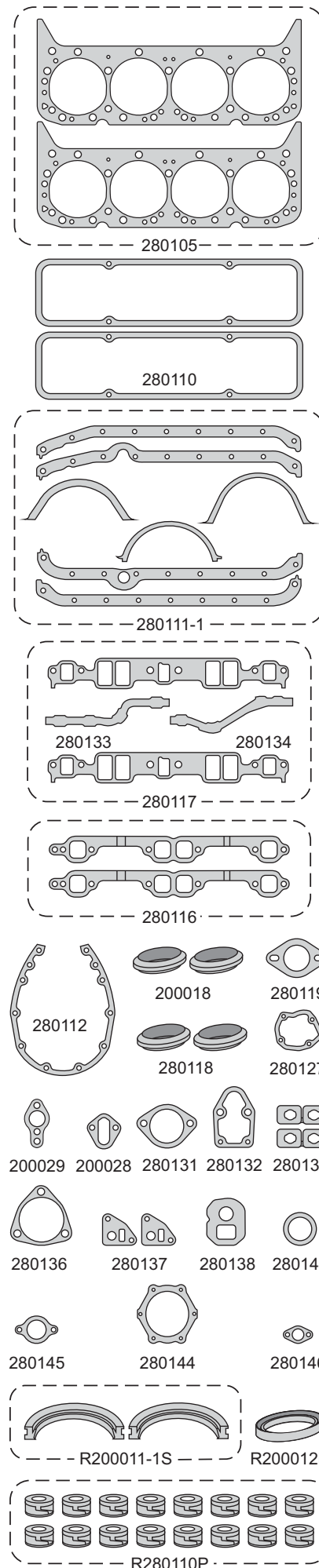

# CHEVROLET



Motor/Engine	Cm³	HP	Ø
4EE1	1686	60	79
4EE1T	1686	82	79

**Chevrolet:** Corsa D, Combo D 1997/...  
Vectra TD 1991/96, Astra TD 1994/97

DIESEL



Nº OE	Descripción/Description	Mat.	1	2	Ref.
	Jgo. de juntas para motor				280201-R
	Jgo. de juntas superior		●		280295-SM
	Jgo. de juntas superior				280295-1M
	Jgo. de juntas superior				280295-2M
	Jgo. de juntas superior (MLS)				280295-SM MLS
	Jgo. de juntas superior (MLS)				280295-1M MLS
	Jgo. de juntas superior (MLS)				280295-2M MLS
	Jgo. juntas superior sin JTC				280296
608.805	Jta. tapa cilindros Ø 81.0 $\pm$ 1.40	NFT	1		280207-SM
608.806	Jta. tapa cilindros Ø 81.0 $\pm$ 1.50	NFT			280207-1M
608.804	Jta. tapa cilindros Ø 81.0 $\pm$ 1.60	NFT			280207-2M
	Jta. tapa cilindros Ø 80.5 $\pm$ 1.40	MLS			280208-SM
	Jta. tapa cilindros Ø 80.5 $\pm$ 1.50	MLS			280208-1M
	Jta. tapa cilindros Ø 80.5 $\pm$ 1.60	MLS			280208-2M
	Jgo. tornillos tapa cilin. (HAH10055/10140)				B280200
	Conj. junta tapa de válvulas (2)	GS	1	1	280210
	Junta para cárter	NB		1	280211
	Bomba de agua	CB		1	280214
	Múltiple escape	NFT	1	1	280215
	Múltiple admisión	NB	1	1	280217
	Termostato	NB	1	1	280219
	Cámara de agua	NB	1	1	280229
	Filtro de aire	NB	1	1	280230
	Inspección tapa cilindros	NB	1	1	280231
	Retorno agua	NB	1	1	280232
	Guarnición cierre	GS			280233
	Bomba de agua	CB			280234
	O'ring bomba de aceite G 63.5 x 3	GS		1	280235
	Guarnición G 56.5 x 66.5 x 6	GS		1	280236
	Guarnición buje bomba de aceite G 17 x 24 x 9	GS		1	280237
	Guarnición medialuna árbol levas	GS	1	1	280238
	O'ring G 23.52 x 1.78	GS		1	
	O'ring G 17.17 x 1.78	GS		1	
	O'ring G 16.5 x 3	GS		1	
	O'ring G 10.77 x 2.62	GS		1	
	Arandela A 14 x 20 x 1.5 C	CU		1	
	Arandela A 12 x 17 x 2 C	CU		1	
	Arandela A 8 x 14 x 1 C	CU		2	
	Kit de retenes completo				R280200
	Jgo. retén válvulas (8)	V		1	R280210V
	Retén bancada 87 x 100 x 8.5	V		1	R280211V
	Retén distribución 40 x 52 x 6	V		2	R280212V
	Retén bomba depresora 17.5 x 32 x 6	V		1	R280215V

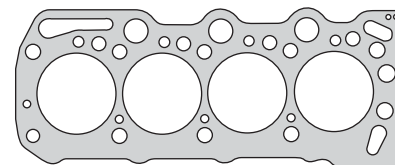

280207

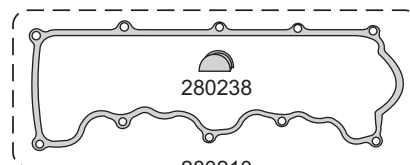

280238

280210

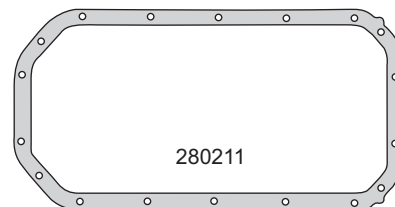

280211



280215



280217



280214



280219



280229

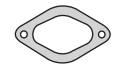

280230



280231



280232



G 23.52 x 1.78



G 17.17 x 1.78



G 10.77 x 2.62

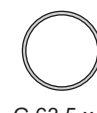

G 63.5 x 3



G 16.5 x 3



G 17 x 24 x 9

G 56.5 x 66.5 x 3



A 12 x 17 x 2 C



A 14 x 20 x 1.5 C



A 8 x 14 x 1 C



R280211V



R280212V



R280215V

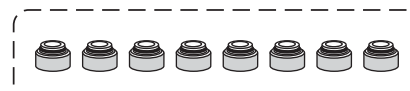

R280210V

# CHEVROLET



Motor/Engine	Cm³	HP	Ø
Maxion S4	3990	102	100

Chevrolet: GM D20, D40, Pick Up D20

DIESEL



Nº OE	Descripción/Description	Mat.	Ref.
	Jgo. de juntas para motor		280300-R
	Jgo. de juntas superior		280395
3681E016	Jta. tapa cilindros Ø 105.0 $\pm$ 1.80 NR	NFT	1 1 280307
	Jgo. tornillos tapa de cilindros		B280300
7049258	Conj. junta tapa válvulas (5)	N	1 1 280310
70490178	Junta para cárter	CG	1 1 280311
70490259	Tapa distribución	NB	1 1 280312
36814137	Placa distribución	NB	1 1 410613
70490255	Bomba de agua cuerpo trasero	NB	1 1 280314
36886007	Jgo. múltiple escape (2)	NFT	1 1 280316
	Jgo. múltiple admisión (3)	NFT	1 1 280317
70490144	Bomba de agua a block	NB	1 1 410719
36853514	Cuerpo salida agua	NB	1 1 410632
36862538	Adaptador al aceite	NB	1 1 410433
36851409	Tapa trasera tapa cilindros	NB	1 1 410633
36834143	Registro bomba inyectora	NB	1 1 400435
36817157	Porta retén bancada trasera	NB	1 1 400236
70490257	Codo a motor a múltiple	NB	1 1 280336
70490254	Conexión agua a tapa termostato	NB	1 1 280337
33817132	Arandela cierre tapa válvulas	GS	280340
70490145	Cuerpo delantero y trasero bomba de agua	NB	1 1 410640
	Anillo goma especial	GS	280341
36851113	Bomba alimentación a block	NB	1 1 410642
36832122	Tubo succión vacío	NB	1 1 410643
0490773	Bomba inyectora	NB	1 1 400146
	Guarnición cierre tapa válvulas	GS	4 4 400446
36865511	Adaptador vacío	NB	1 1 410747
	Jgo. gomas (13)	GS	1 1 280348
	Junta colector a escape turbo	AC	1 1 350462
70920104	Arandelas inyector A 7.5 x 15 x 2 C	CU	4 4
	Arandela A 6 x 9 x 1 C	CU	8 8
	Arandela A 8 x 12 x 1 C	CU	2
	Arandela A 10 x 15 x 1.5 A	AL	3
	Arandela A 15 x 21 x 1.5 A	AL	4 4
	Arandela A 17 x 22 x 1.25 A	AL	3
	Arandela A 22.5 x 29 x 2 A	AL	1
	Arandela A 13 x 17 x 2 A	AL	1
	Arandela A 20 x 28 x 1 A	AL	1
	Anillo G 41.5 x 47.5 x 7	GS	1 1
	Anillo G 6 x 10.5 x 5.8	GS	1 1
	Anillo G 73 x 82 x 9.7	GS	1 1
	O´ring G 15.6 x 1.78	GS	4 4
	O´ring G 18.77 x 1.78	GS	2 2
	O´ring G 15.5 x 30 x 12.5	GS	4 4
	Kit de retenes completo		R280300
	Jgo. retén válvulas (8)	P	1 R280310P
	Jgo. retén válvulas (8)	P	1 R300310P
	Retén distribución 60.32 x 79.36 x 9.5	P	1 R400012P
	Retén bancada 133.35 x 158.75 x 11/13	V	1 R400211V

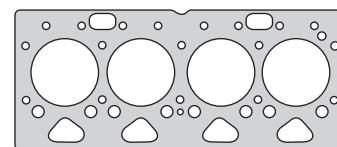

280307

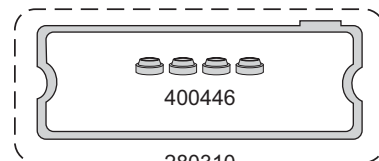

400446

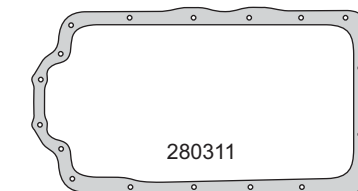

280310



280311

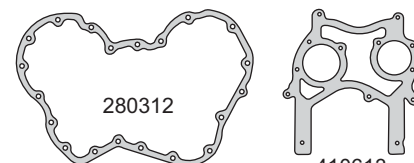

280312

410613



410719

280314

410632

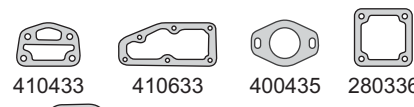

410433

410633

400435

280336

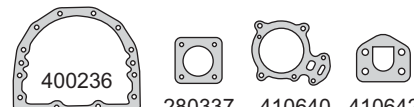

400236

280337

410640

410642

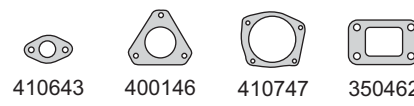

410643

400146

410747

350462

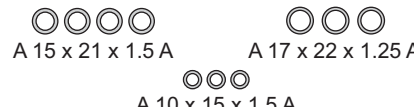

A 15 x 21 x 1.5 A

A 17 x 22 x 1.25 A

A 10 x 15 x 1.5 A

G 15.6 x 1.78

G 18.77 x 1.78

A 22.5 x 29 x 2 A

A 6 x 9 x 1 C

A 7.5 x 15 x 2 C

A 20 x 28 x 1 A

A 8 x 12 x 1 C

A 13 x 17 x 2 A

G 41.5 x 47.5 x 7



R400211V

R400012P

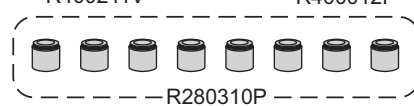

R280310P

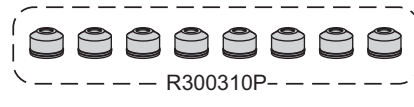

R300310P

**ISUZU**



Motor / Engine	Cm <sup>3</sup>	HP	Ø
4ZD1 (SOHC) 8V	2254	88	89.3

**Isuzu:** Luv, Pick Up, Trooper II 1986/95  
Impulse 1988/90  
**Opel:** Campo .../1992, Brava 1990/94



Nº OE	Descripción / Description	Mat.	Ref.
	<b>Jgo. de juntas para motor</b>	●	<b>280400-R</b>
	<b>Junta tapa cilindros Ø 91.0 ±1.70</b>	NFT	<b>1 280407</b>
	<b>Jgo. tornillos tapa cilindros (6-<del>HAH10055/10140</del>)</b>		<b>B280400</b>
	Conj. junta tapa válvulas (4)	GS	1 280410
	Junta para cárter	GS	1 280411
	Base distribución	CB	1 280413
6403172711	Bomba de agua	NB	1 280414
6403122721	Múltiple escape	CHA	1 280415
6403172881	Múltiple admisión	NB	1 280417
	Base carburador	CB	2 280425
	Base filtro aceite	NB	1 280427
	Codo termostato	NB	1 280431
	Junta	NB	1 280430
	Tapa termostato	NB	1 280432
	Arandela fijación tapa de válvulas	GS	3 280433
	O'ring G 64.77 x 2.62	GS	1
	O'ring G 35 x 3.5	GS	1
	O'ring G 7.52 x 3.53	GS	8
	Kit de retenes completo		R280400
	Jgo. retén válvulas (8)	V	1 R280410V
	Retén bancada 95 x 118 x 8.5	P	1 R240711P
	Retén distribución 40 x 56 x 7	P	1 R260312P
	Retén árbol levas 30 x 45 x 8	P	1 R240713P
	Retén bomba de aceite 25 x 40 x 8	N	1 R280415N



280407

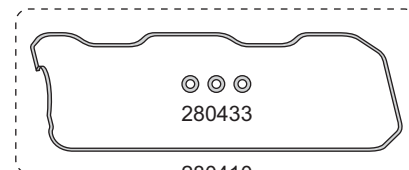

280433

280410

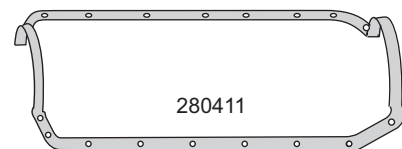

280411



280415



280417

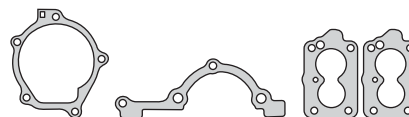

280414

280413

280425



280427

280430

280431

280432



G 64.77 x 2.62



G 35 x 3.5



G 7.52 x 3.53



R240711P



R260312P



R240713P



R280415N



R280410V

# CHEVROLET



Motor/Engine	Cm³	HP	Ø
MPFI (DOHC) 16V	999	68	71.1

Chevrolet: Corsa 1998/...



Nº OE	Descripción/Description	Mat.	Ref.
	Jgo. de juntas para motor		280500-R
	Jgo. de juntas superior		280595
	Jta. tapa cilindros Ø 74.0 ± 1.40	NFT 1 1	280507
	Jgo. tornillos tapa cilindros (HAE12038)		B280600
638 737/736	Conj. juntas tapa válvulas (12)	N 1 1	280610
652669	Junta para cárter	N 1 1	280611
	Frente motor bomba aceite	NB 1 1	240412
5850613	Múltiple escape	NFT 1 1	280615
850668	Múltiple admisión	NB 1 1	280617
90128293	Salida de escape	FCH 1 1	240018
	Termostato	NFT 1 1	280519
	Junta TBI	CB 1 1	280530
5850612	Entre múltiples colectores X16XE	NB 1 1	280634
5050611	Entre múltiple colectores X16XE	NB 1 1	280637
	O'ring G 10 x 2	GS 10 10	
	O'ring G 55.25 x 2.62	GS 1 1	
	O'ring G 60.05 x 1.78	GS 1 1	
	O'ring G 64 x 3	GS 1 1	
	O'ring G 79.5 x 3	GS 1 1	
	Arandela A 14 x 19 x 1.5 C	CU 4 4	
	Kit de retenes completo		R280600
036/109675//	Jgo. retén válvulas (16)	V 1 1	R280610V
614830	Retén bancada 80 x 98 x 10	V 1 1	R240411V
636 841	Retén árbol levas 35 x 48 x 7	V 2 2	R240013V
646274	Retén bomba aceite 26 x 42 x 8	V 1 1	R240415V

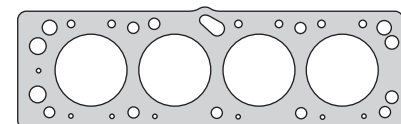

280507

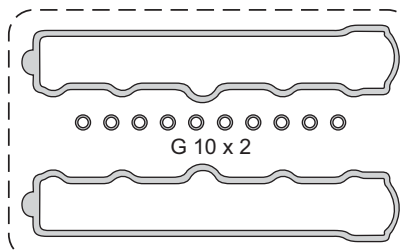

280610

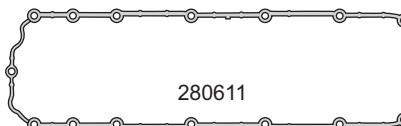

280611



280615



280617



240018



280519



280530

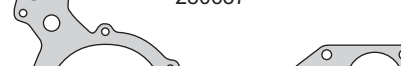

280634



280637



240412



A 14 x 19 x 1.5 C



G 55.25 x 2.62



G 64 x 3



G 60.05 x 1.78



G 79.5 x 3

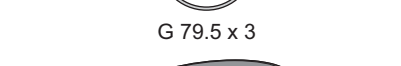

R240411V



R240013V

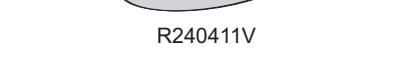

R240415V



R280610V

# CHEVROLET



Motor/Engine	Cm³	HP	Ø
C16XE - C16XEL (DOHC) 16V	1598	109	79

**Chevrolet:** Corsa, Opel, Tigra, Astra, Vectra 1993/...



Nº OE	Descripción/Description	Mat.	Ref.
	Jgo. de juntas para motor		280600-R
	Jgo. de juntas superior	●	280695
91 06 305	Jta. tapa cilindros Ø 80.5 $\pm$ 1.30  NR <sup>2</sup>	NFT 1 1	280607
	Jgo. tornillos tapa cilindros (HAE12038)		B280600
638 737/736	Conj. junta tapa válvulas (12)	N 1 1	280610
652669	Junta para cárter	N 1	280611
	Frente distribución	NH	280612
	Frente bomba aceite	NB	1 240412
90220436	O´ring bomba de agua G 88.57 x 2.62	GS 1	280614
5850613	Múltiple escape	NFT 1 1	280615
850668	Múltiple admisión	NB 1 1	280617
90118437	O´ring termostato G 50 x 4	GS 1	240019
	Anillo termostato	GS 1	240419
	Descarga gases	NB 1	240429
90412738	Guarnición termostato	GS	280629
	Salida gases		280630
5850612	Entre múltiples colectores X16XE	NB 1 1	280634
5050611	Entre múltiple colectores X16XE	NB 1 1	280637
	O´ring G 10 x 2	GS 10 10	
	O´ring G 60.05 x 1.78	GS 1 1	
	O´ring distribución G 15.54 x 2.62	GS 1	
	Arandela A 14 x 22 x 2 C	CU 4	
	Arandela A 17 x 21 x 0.5 C	CU 4	
	Kit de retenes completo		R280600
642 533	Jgo. retén válvulas (16)	V 1	R280610V
614830	Retén bancada 80 x 98 x 10	V 1	R240411V
636 841	Retén árbol levas 35 x 48 x 7	V 2	R240013V
646274	Retén bomba aceite 26 x 42 x 8	V 1	R240415V

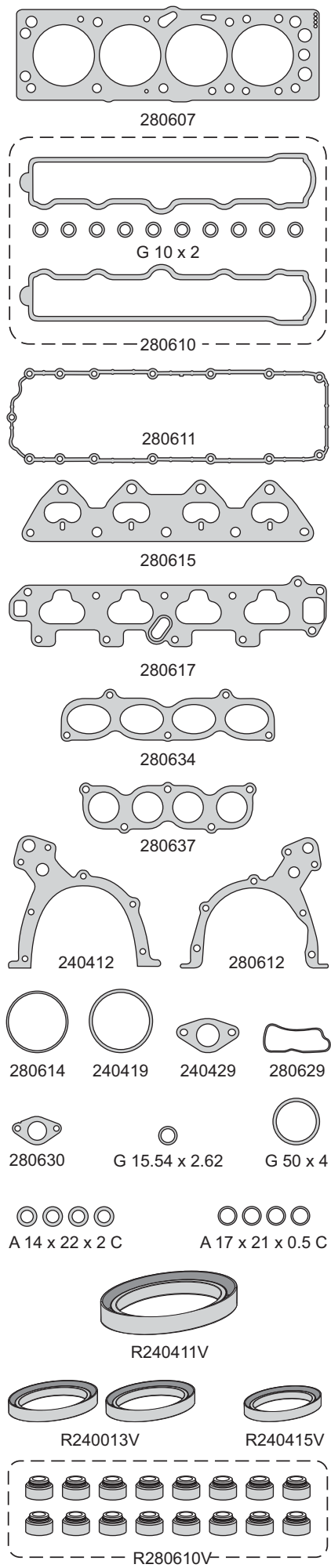



# CHEVROLET



Motor/Engine	Cm³	HP	Ø
X20XEV	1998	136	86
X20SED	1998	136/148	86
X20SED (DOHC) 16V	2198	140	86

**Chevrolet:** Astra 1995/...  
Omega B, Calibra 1994/...

**Daewoo:** Leganza 1997/..., Nubira 1997/...  
Nubira II 1999/..., Magnus 2001/...



Nº OE	Descripción/Description	Mat.	Ref.
	Jgo. de juntas para motor		280700-R
	Jgo. de juntas superior	●	280795
	Jta. tapa cilindros Ø 88.0 ± 1.40	NFT	280705
56 07 449	Jta. tapa cilindros Ø 88.0 ± 1.40	NFT	1 1 280707
	Jgo. tornillos tapa cilin. (HAT55055/55100)		B280700
607 647	Conj. junta tapa de válvulas (11)	N	1 1 280710
	Junta para cárter	N	1 1 240211
652 274	Junta para cárter con rompeolas	CHA	280711
	Bomba aceite filtro a block	NB	1 240012
850 655	Múltiple escape	NFT	1 1 280715
850 656	Múltiple admisión	NB	1 1 280717
854 933	Salida de escape	FCH	1 1 240018
	Placa admisión	NFT	1 1 280729
	Guarnición goma termostato G 44.17 x 1.78	GS	1 1 280730
	Guarnición goma termostato G 66.4 x 1.78	GS	1 1 280731
	Nivel aceite	SLS	1 280733
	Arandela A 14 x 20 x 1 C	CU	1
	Arandela A 20 x 24 x 1.5 A	AL	1
	O´ring G 9 x 2	GS	10 10
	O´ring G 16 x 2.5	GS	1
	O´ring G 17.17 x 1.78	GS	1
	O´ring G 94 x 3	GS	1
	Kit de retenes completo		R280700
642 533	Jgo. retén válvulas (16)	V	1 R280610V
614 827	Retén bancada 90 x 104 x 11	V	1 R240211V
646 265	Retén distribución 31 x 50 x 8	V	1 R240012V
636 841	Retén árbol de levas 35 x 48 x 7	V	2 R240013V

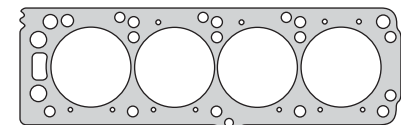

280707

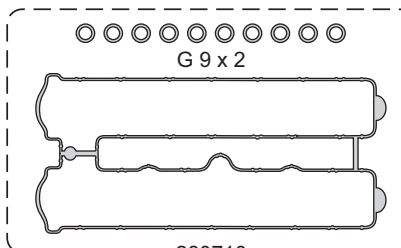

280710

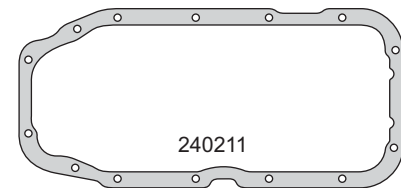

240211

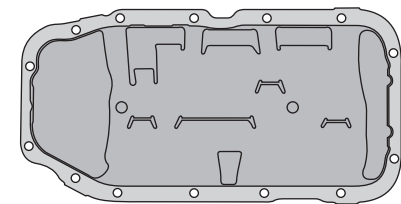

280711

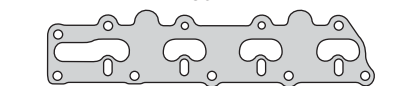

280715

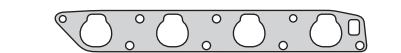

280717

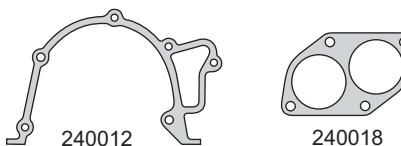

240012

240018



280729

280730

280731

280733

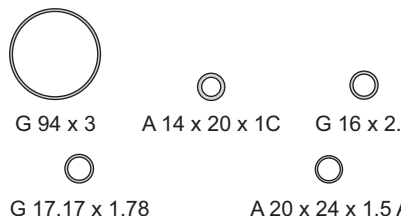

G 94 x 3

A 14 x 20 x 1C

G 16 x 2.5

G 17.17 x 1.78

A 20 x 24 x 1.5 A



R240211V



R240013V

R240012V

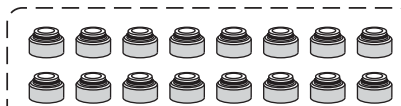

R280610V

# CHEVROLET



Motor/Engine	Cm <sup>3</sup>	HP	Ø
C350L V8	5735		101.6

**Chevrolet:** 350 1986/93 No Corvette  
Pick Up, Camiones 350 1986/95



Nº OE	Descripción/Description	Mat.	Ref.
	<b>Jgo. de juntas para motor</b>	●	<b>280800</b>
	<b>Jgo. junta tapa cilindros Ø 105.0 ± 1.20 (2)</b>	NFT	<b>1 280105</b>
	Junta tapa válvulas	CG	2 280110
	Junta tapa válvulas	GS	2 281110
	Jgo. junta para cárter (2)	CGT	1 280811
	Tapa distribución	CB	1 280112
	Jgo. múltiple escape (2)	NFT	1 280116
	Jgo. múltiple escape (4)	NFT	1 280816
	Jgo. múltiple admisión (4)	NFT	1 280117
	Jgo. múltiple admisión (2)	NFT	1 280817
	Salida de escape	FCH	2 200018
	Codo termostato	CB	1 280119
	Tapa bomba aceite	CB	1 280127
	Base bomba nafta	CB	1 200028
	E.G.R	NFT	1 280828
	Acople bomba aceite	CB	2 200029
	Tapa inspección	CB	1 280132
	Cierre admisión	N	1 280133
	Salida gases	CB	1 280833
	Cierre admisión	N	1 280134
	Porta retén	CB	1 280834
	Sello metálico admisión	AC	2 280835
	Base carburador	CB	1 280837
	Base carburador	CB	1 280838
	Válvula E.G.R	NFT	1 280839
	Tapa filtro aire carburador A 129 x 140 x 1.6	CB	2 280139
	Llenado aceite A 33 x 46 x 0.8	CB	1 280143
	Arandela tapón cárter A 13 x 23 x 1.5 C	CU	1
	Anillo G 82.2 x 91 x 4.75	GS	1
	Anillo G 85.5 x 3.35	GS	1
	Anillo G 85 x 3	GS	1

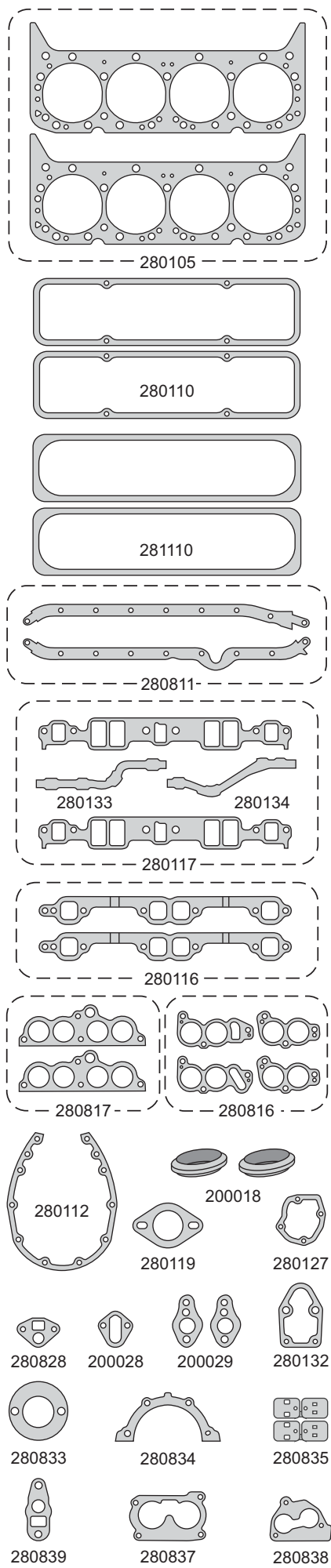

# CHEVROLET



Motor/Engine	Cm³	HP	Ø
C350 V8	5735		101.6

Chevrolet: Truck 1996/01, Vortec Vin R



Nº OE	Descripción/Description	Mat.	Ref.
	Jgo. de juntas para motor		● 281100-RMX
	Jgo. de juntas superior		● 281195
	Jgo. junta tapa cilin. Ø 105.0 ± 1.20 (2)	NFT	2 2 280105
	Junta tapa de válvulas	GS	2 2 281110
	Junta para cárter	GS	1 280111
	Jgo. múltiple escape (3)	AC	2 2 281116-1
	Jgo. múltiple admisión (4)	VS	1 1 281117
	Acople bomba aceite	CB	2 200029
	Junta base distribuidor	NB	1 200329
	Guarnición unión admisión	CG	1 242730
	Guarnición unión admisión	CG	1 242731
	Junta porta retén	CB	1 280834
	Guarnición	GS	1 1 281136
	Guarnición	GS	1 1 281137
	Guarnición	GS	1 1 281138
	Guarnición	GS	1 1 281139
	O´ring G 18.72 x 2.62	GS	2
	O´ring G 66.27 x 3.53	GS	1
	O´ring G 85.32 x 3.53	GS	1
	Kit de retenes completo		R281100
	Jgo. retén válvulas (16)	P	1 R281110P
	Retén bancada 95 x 115 x 12.5	S	1 R242111S
	Retén distribución 44.47 x 61.19 x 9.57	P	1 R200012P

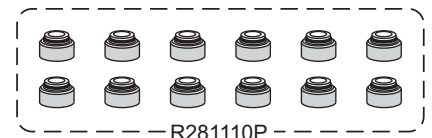
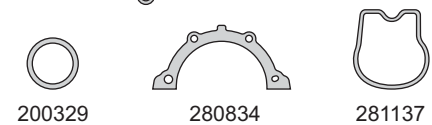
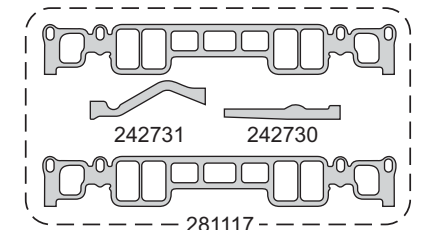
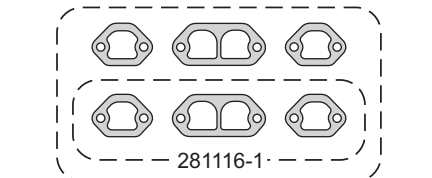
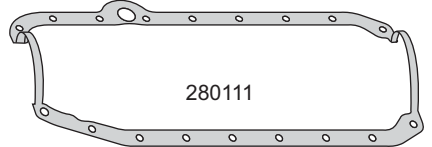
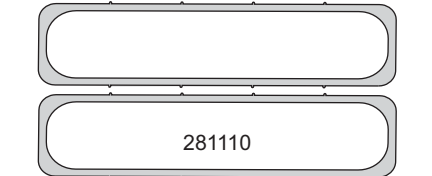
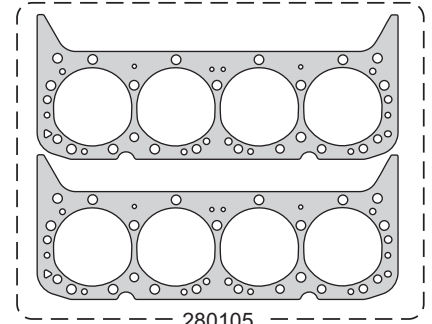

# CHEVROLET



Motor/Engine	Cm³	HP	Ø
L18 V8	8123	550	108

**Chevrolet:** Silverado/GMC Sierra 2500/3500HD  
Suburban/GMC Yukon XL  
Avalanche 2500  
Kodiak 2001/04



Nº OE	Descripción/Description	Mat.	Ref.
	<b>Jgo. de juntas para motor</b>		<b>281200-R</b>
	<b>Jgo. jta. tapa cilindros Ø110 ± 1.70 (2) NR</b>	NFT	1 281207
	Junta tapa válvulas	GS	2 281210
	Junta para cárter	GS	1 281211
	Tapa distribución	GS	1 281212
	Jgo. múltiple escape (2)	GFT	1 281216
	Jgo. múltiple admisión (4)	AC/GS	1 281217
	Bomba de agua	AC/GS	1 281230
	Tubo bomba de agua	GFT	1 281231
	Válvula EGR	GFT	1 290231
	Tubo válvula EGR	GFT	1 281232
	Tubo válvula EGR	GFT	1 281233
	Junta cuerpo aceleración	NH	1 281234
	Junta	N	1 290244
	O´ring G 7.52 x 3.53	GS	16
	Kit de retenes completo		R281200
	Jgo. retén válvulas (16)	P	1 R281210P
	Retén bancada	T	1 R281211T
	Retén distribución	T	1 R281212T

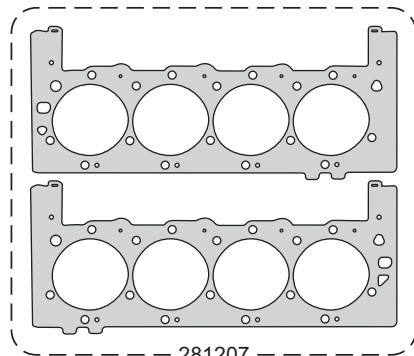

281207

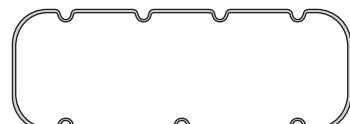

281210

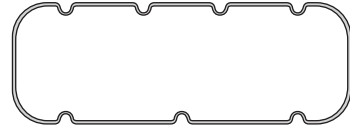

281211

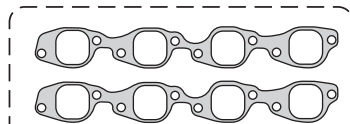
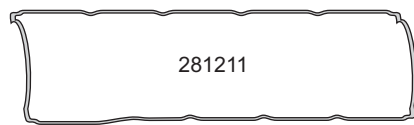

281216

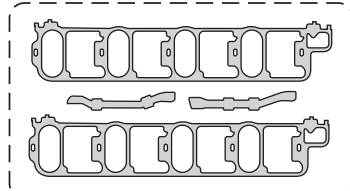

281217

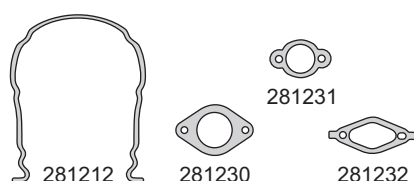

281212

281231

281230

281232

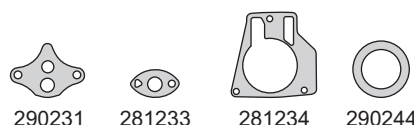

290231

281233

281234

290244



G 7.52 x 3.53



R281212T

R281211T

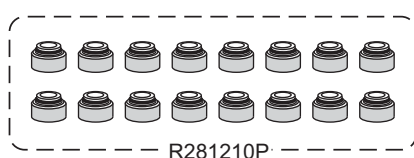

R281210P

# CHEVROLET



Motor/Engine	Cm³	HP	Ø
Atlas LL8 - L6 (DOHC) 24V	4160	275	94

Chevrolet: Trail Blazer 2002/06

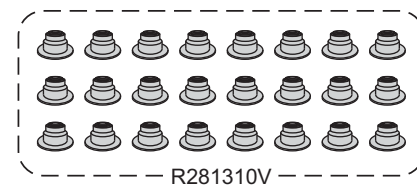
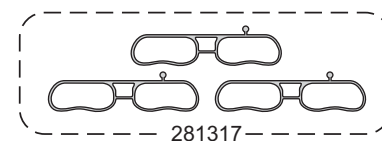
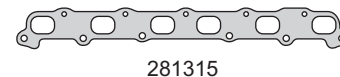
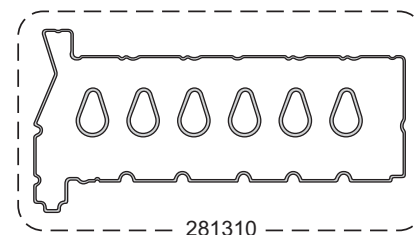
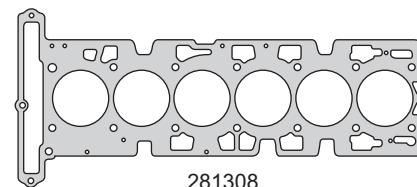

Nº OE	Descripción/Description	Mat.	Ref.
	Jgo. de juntas para motor		● 281300-R MLS
	Jgo. de juntas superior	●	281395 MLS
	Junta tapa de cilin. Ø94.0 ±0.70	MLS 1	1 281308
	Conj. junta tapa válvulas (7)	GS 1	1 281310
	Múltiple escape	AC 1	1 281315
	Jgo. múltiple admisión (3)	GS 1	1 281317
	Bomba de agua	AC	1 281330
	Junta tubo de succión aceite	AC/GS	1 281331
	Junta salida caja termostato	GS	1 281333
	Junta salida anticongelante	GS	1 281334
	Junta	GS	1 281335
	Junta cuerpo de aceleración	GS 1	1 281336
	Junta válvula control de emisiones	GFT	1 281337
	O´ring termostato G 56.7 x 3.53	GS	1
	Kit de retenes completo		R281300
	Jgo. retén válvulas (24)	V	1 R281310V
	Retén bancada 105 x 128 x 11/13.5	T	1 R281311T
	Retén distribución 44 x 59 x 8.5/10	T	1 R281312T

# CHEVROLET



Motor/Engine	Cm³	HP	Ø
LY2	4800	295	96
L59 (OHV) 16V	5300	295	96

**Chevrolet:** Vortec, Silverado, Sierra  
Suburban, Tahoe Yukon 2001/03



Nº OE	Descripción/Description	Mat.	Ref.
	<b>Jgo. de juntas para motor</b>	●	<b>281400-R</b>
	<b>Junta tapa cilindros Ø 97.4 ±1.30</b>	MLS	<b>2 281408</b>
	Junta tapa válvulas	GS	2 281410
	Junta para cárter	AL/GS	1 281411
	Junta distribución	AL/GS	1 281412
	Junta distribución	AL/GS	1 281413
	Bomba de agua	AC/GS	2 281414
	Jgo. múltiple escape (2)	AC	1 281415
	Jgo. múltiple admisión (2)	PLAST	1 281417
	Junta	GS	2 281418
	Junta	AC/GS	4 281430
	Junta	AC/GS	1 281431
	Junta	GS	1 281432
	Junta	AC/GS	1 281433
	Junta	GFT	1 281434
	Junta	NFT	1 281435
	Junta	AL/GS	1 281436
	Junta	NFT	2 281437
	Junta	NB	2 281438
	O´ring G 11 x 20.5 x 2.5	GS	1 290243
	O´ring G 21.82 x 3.53	GS	1
	O´ring G 104.37 x 3.53	GS	1
	O´ring G 9.19 x 2.62	GS	8
	O´ring G 20.5 x 4	GS	1
	O´ring G 7.52 x 3.53	GS	8
	Kit de retenes completo		R281400
	Jgo. retén válvulas (16)	V	1 R281410V
	Retén bancada 100 x 114.8 x 10	T	1 R281411T
	Retén distribución 55 x 72 x 8.5	T	1 R281412T
	Retén auxiliar 18 x 47.7 x 9	P	1 R281415P

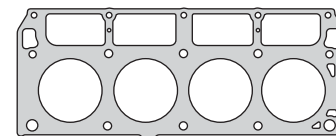

281408

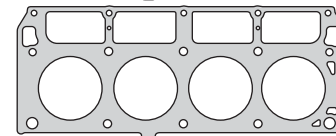

281410

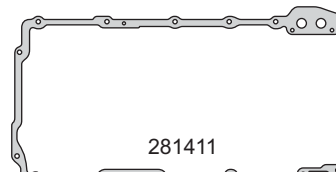

281411

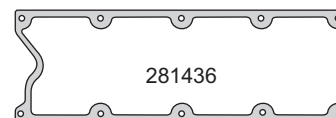

281436

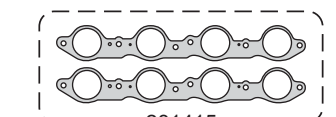

281415

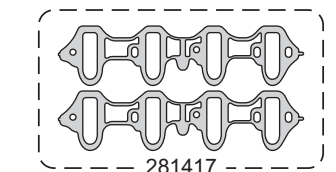

281417

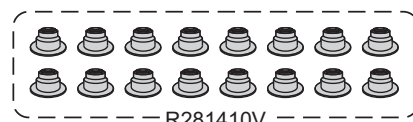
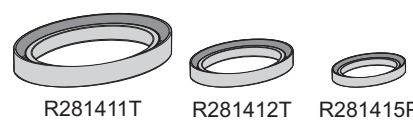
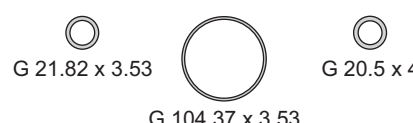
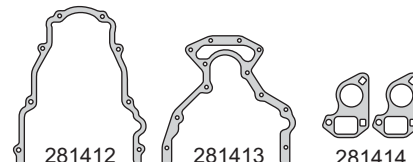

# CHEVROLET



Motor/Engine	Cm³	HP	Ø
LQ4	5967	325	101.6

**Chevrolet:** Vortec, Silverado, Sierra  
Suburban, Tahoe Yukon, Express  
Pick Up 2500/3500 2001/03



Nº OE	Descripción/Description	Mat.	Ref.
	Jgo. de juntas para motor		● 281500-R
	Jgo. de juntas superior	●	281595
	Jta. tapa cilindros Ø 102.7 $\pm$ 1.30 NR	MLS 2 2	281508
	Junta tapa válvulas	GS 2 2	281410
	Junta para cárter	AL/GS 1	281411
	Junta distribución	AL/GS 1	281412
	Junta distribución	AL/GS 1	281413
	Bomba de agua	AC/GS 2	281414
	Jgo. múltiple escape (2)	AC 1 1	281415
	Jgo. múltiple admisión (2)	PLAST 1 1	281417
	Junta	GS 2 2	281418
	Junta	AC/GS 4 4	281430
	Junta	AC/GS 1 1	281431
	Junta	GS 1 1	281432
	Junta	AC/GS 1	281433
	Junta	GFT 1	281434
	Junta	NFT 1 1	281435
	Junta	AL/GS 1 1	281436
	Junta	NFT 2	281437
	Junta	NB 2	281438
	O´ring G 11 x 20.5 x 2.5	GS 1	290243
	O´ring G 21.82 x 3.53	GS 1	
	O´ring G 104.37 x 3.53	GS 1	
	O´ring G 9.19 x 2.62	GS 8 8	
	O´ring G 20.5 x 4	GS 1 1	
	O´ring G 7.52 x 3.53	GS 8	
	Kit de retenes completo		R281400
	Jgo. retén válvulas (16)	V 1	R281410V
	Retén bancada 100 x 114.8 x 10	T 1	R281411T
	Retén distribución 55 x 72 x 8.5	T 1	R281412T
	Retén auxiliar 18 x 47.7 x 9	P 1	R281415P

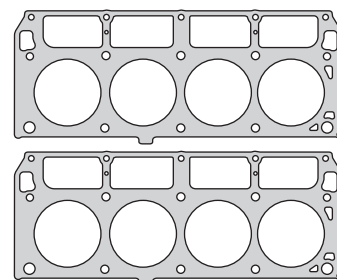

281508

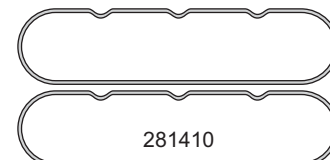

281410

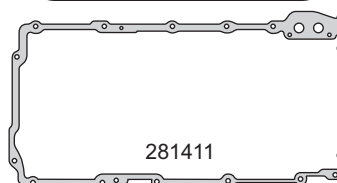

281411

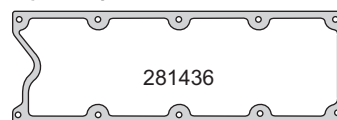

281436

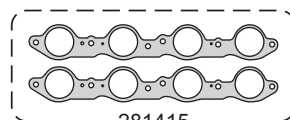

281415

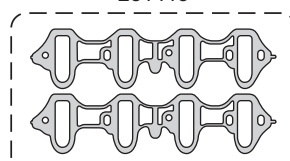

281417

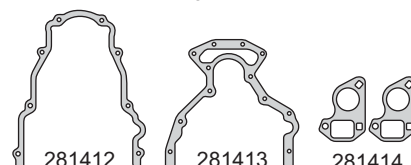

281412

281413

281414



281418

281430

281431

281432

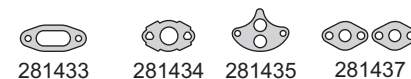

281433

281434

281435

281437



281438

G 7.52 x 3.53

G 9.19 x 2.62

290243



G 21.82 x 3.53

G 104.37 x 3.53

G 20.5 x 4

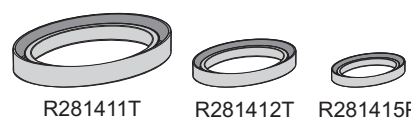

R281411T

R281412T

R281415P



R281410V

# CHEVROLET



Motor/Engine	Cm <sup>3</sup>	HP	Ø
Z18XE - Ecotec (DOHC) 16V	1796	120	80.5

Chevrolet: Astra 2000/03



Nº OE	Descripción/Description	Mat.	Ref.
	Jgo. de juntas para motor		281600-R
	Jgo. de juntas superior	●	281695
	Jta. tapa cilindros Ø 82.0 $\pm$ 1.30	NFT	281607
	Jta. tapa cilindros Ø 81.5 $\pm$ 0.50	MLS 1 1	281608
	Jgo. tornillos tapa cilindros (HAE12038)		B280600
	Junta tapa válvulas	GS 1 1	281610
	Frente motor bomba de aceite	SLS 1	241812
	Múltiple escape	AC 1 1	281615
	Múltiple admisión	SLS 1 1	241817
	Kit de retenes completo		R281600
	Jgo. retén válvulas (16)	V 1	R281610V
	Retén bancada 80 x 98 x 10	P 1	R240411P
	Retén árbol de levas 35 x 48 x 7	P 2	R240013P
	Retén auxiliar 30 x 40 x 7	P 1	R550615P

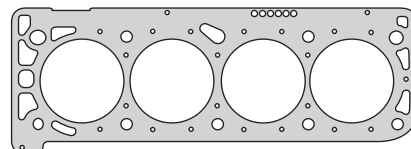

281608

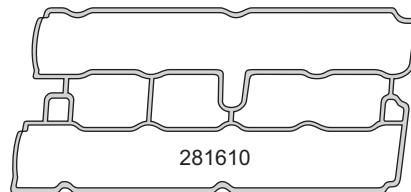

281610



241615



241817

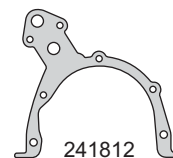

241812



R240411P

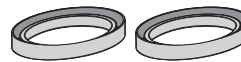

R240013P



R550615P



R281610V



# CHEVROLET



Motor/Engine	Cm³	HP	Ø
LG8 (OHV) V6 8V	3136	171	89

Chevrolet: Malibu 2000/03



Nº OE	Descripción/Description	Mat.	Ref.
	Jgo. de juntas para motor		281700-R
	Jgo. de juntas superior	●	281795
	Jgo. jta. tapa cil. Ø92.0 $\pm$ 1.62 (2) NR	NFT 1 1	281707
	Jgo. junta tapa válvulas (2)	GS 1 1	281710
	Junta para cárter	GS 1 1	281711
	Junta distribución	NB 1 1	241912
	Jgo. múltiple escape (2)	CHA 1 1	281715
	Jgo. múltiple admisión (2)	PLAST 1 1	281717
	Junta	NFT 1 1	281730
	Junta	CB 1 1	281731
	Junta chupador aceite	GFT 1 1	290231
	Jgo. entre múltiples (2)	NB 1 1	281732
	Guarnición goma	GS 7 7	281733
	Bomba de agua	CB 1 1	241934
	Junta base termostato	NB 1 1	241937
	O´ring G 11 x 20.5 x 2.5	GS 1 1	290243
	Guarnición goma	N 1 1	290244
	O´ring G 10.77 x 2.62	GS 1 1	
	O´ring G 9.19 x 2.62	GS 6 6	
	O´ring G 13.94 x 2.62	GS 2 2	
	O´ring G 6.07 x 1.78	GS 1 1	
	O´ring G 7.52 x 3.53	GS 12 12	
	O´ring G 17.12 x 2.62	GS 1 1	
	O´ring G 21.89 x 2.62	GS 1 1	
	O´ring G 18.77 x 1.78	GS 1 1	
	O´ring G 12.42 x 1.78	GS 1 1	
	O´ring G 21.95 x 1.78	GS 1 1	
	Kit de retenes completo		R281700
	Jgo. retén válvulas (12)	P 1 1	R281710P
	Retén bancada 76 x 92 x 10	P 1 1	R241911P
	Retén distribución 44.47 x 61.19 x 9.57	N 1 1	R200012N

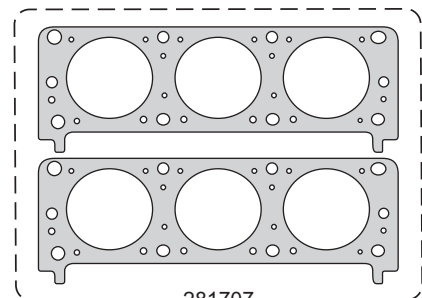

281700-R

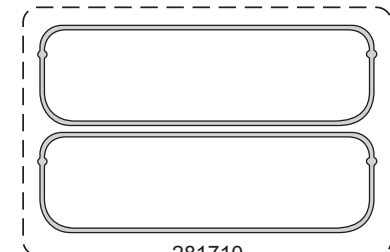

281710

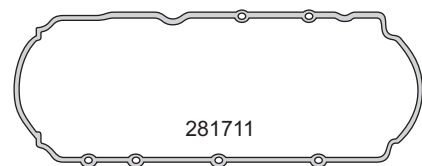

281711

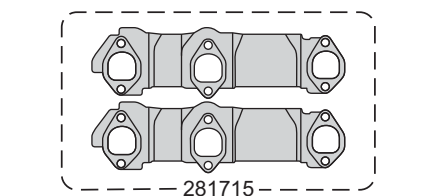

281715

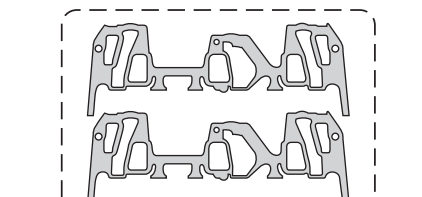

281717

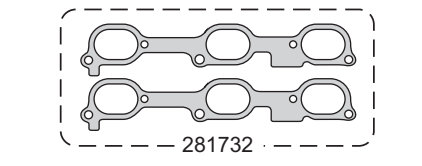

281730

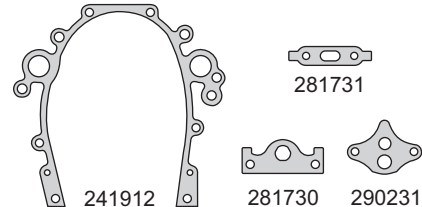

241934

281731

281730

290231

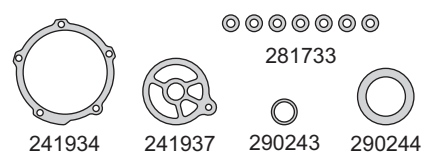

241934

241937

281733

290243

290244

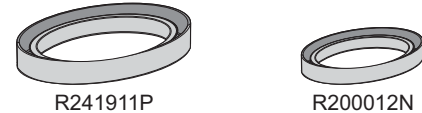

R241911P

R200012N

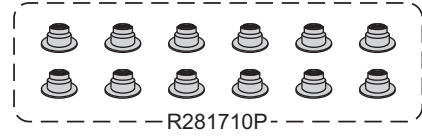

R281710P

# CHEVROLET



Motor/Engine Cm³ HP Ø

LN2 (OHV) 8V 2190 120 89

Chevrolet: Cavalier 1998/03



Nº OE	Descripción/Description	Mat.	Ref.
	Jgo. de juntas para motor		281800-R
	Jgo. de juntas superior	●	281895
	Jta. tapa cilindros Ø 91.5 $\pm$ 1.60  NR	NFT 1 1	290307
	Junta tapa válvulas	GS 1 1	290410
	Jgo. junta para cárter (2)	CG 1 1	290211
	Múltiple escape	NFT 1 1	290416
	Múltiple admisión	NFT 1 1	290417
	Base termostato	GFT 1 1	290219
	Bomba aceite	CB 1 1	290227
	Tapa termostato	CB 1 1	290230
	Junta	NB 1 1	281830
	Chupador aceite	GFT 1 1	290231
	Junta	NFT 1 1	290431
	Junta	NB 1 1	290432
	Junta	CB 1 1	290433
	Cogotera	N 1 1	290238
	Lateral	N 1 1	290241
	Guarnición	CB 1 1	290344
	Arandela A 12.8 x 22.8 x 2 PL	PLAST 1 1	
	Arandela A 13 x 23 x 1.5 C	CU 1 1	
	O´ring G 24.99 x 3.53	GS 1 1	
	O´ring G 20 x 2	GS 4 4	
	O´ring G 14 x 2.5	GS 1 1	
	O´ring G 12.42 x 1.78	GS 4 4	
	O´ring G 8 x 1.50	GS 2 2	
	O´ring G 6.07 x 1.78	GS 2 2	
	Kit de retenes completo		R281800
	Jgo. retén válvulas (8)	V 1 1	R281810V
	Retén bancada 76 x 92 x 10	P 1 1	R241911P
	Retén distribución 44.47 x 61.19 x 9.57	P 1 1	R200012P

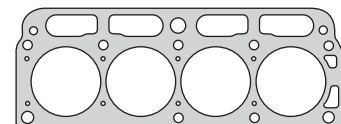

290307

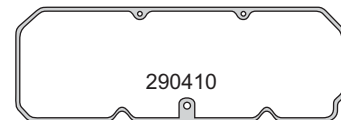

290410

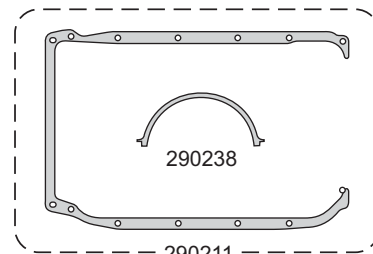

290211



290416



290417

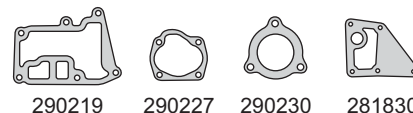

290219 290227 290230 281830

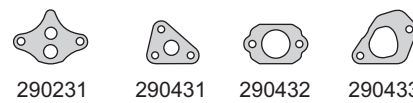

290231 290431 290432 290433

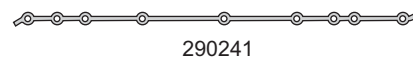

290241



G 8 x 1.5 290344 G 14 x 2.5



G 20 x 2



A 12.8 x 22.8 x 2 A 13 x 23 x 1.5 C

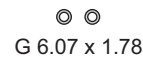

G 6.07 x 1.78



G 24.99 x 3.53 G 12.42 x 1.78



R241911P



R200012P



R281810V

# CHEVROLET



Motor/Engine	Cm³	HP	Ø
X20XEV (DOHC) 16V	1998	128/136	86

Chevrolet: Astra 1995/98, Zafira, Optra 1998/...

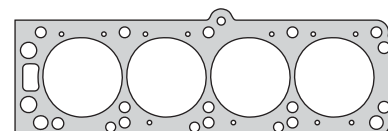

281907

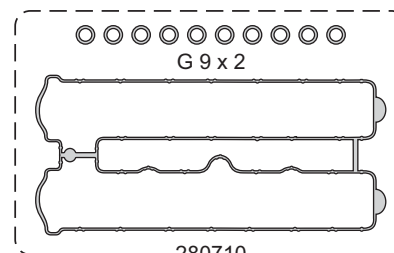

280710

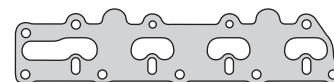

280715



280717

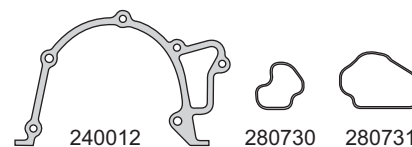

290833

290836

290837

A 20 x 25 x 2 A



R240211P



R240013P

R240012P



R280610V

Nº OE	Descripción/Description	Mat.	Ref.
	Jgo. de juntas para motor		281900-R
	Jgo. de juntas superior		281995
56 07 449	Jta. tapa cilindros Ø 88.0 ± 1.30	NFT	1 1 281907
607 647	Conj. junta tapa de válvulas (11)	N	1 1 280710
	Bomba aceite filtro a block	NB	1 240012
850 655	Múltiple escape	NFT	1 1 280715
850 656	Múltiple admisión	NB	1 1 280717
	Guarnición goma termostato	GS	1 1 280730
	Guarnición goma termostato	GS	1 1 280731
	Junta	NB	1 290833
	Junta	AC	1 1 290836
	Junta	AC	1 1 290837
	Arandela A 20 x 25 x 2 A	AL	1
	O´ring G 9 x 2	GS	10 10
	Kit de retenes completo		R280700
642 533	Jgo. retén válvulas (16)	V	1 R280610V
614 827	Retén bancada 90 x 104 x 11	P	1 R240211P
646 265	Retén distribución 31 x 50 x 8	P	1 R240012P
636 841	Retén árbol de levas 35 x 48 x 7	P	2 R240013P

# CHEVROLET



Motor/Engine	Cm³	HP	Ø
LA1 (OHV) V6 12V	3350	170	92

**Chevrolet:** Venture, Impala, Monte Carlo  
Alero, Gran Am, Aztek, Silhouette  
Trans Sport 2000/03



Nº OE	Descripción/Description	Mat.	Ref.
	<b>Jgo. de juntas para motor</b>		<b>282000-R</b>
	<b>Junta tapa cilindros Ø 95.0 ± 1.40</b>	<b>GFT 2</b>	<b>282007</b>
	Conj. junta tapa válvulas (2)	GS 1	281710
	Junta para cárter	GS 1	281711
	Junta distribución	NB 1	241912
	Jgo. múltiple escape (2)	CHA 1	281715
	Jgo. múltiple admisión (2)	PLAST 1	281717
	Junta	NFT 1	281730
	Junta chupador aceite	GFT 1	290231
	Jgo. entre múltiples (2)	NB 1	281732
	Bomba de agua	CB 1	241934
	Junta base termostato	NB 1	241937
	O´ring G 11 x 20.5 x 2.5	S 1	290243
	Guarnición	N 1	290244
	O´ring G 10.77 x 2.62	GS 1	
	O´ring G 9.19 x 2.62	GS 6	
	O´ring G 13.94 x 2.62	GS 2	
	O´ring G 6.07 x 1.78	GS 1	
	O´ring G 7.52 x 3.53	GS 12	
	O´ring G 17.12 x 2.62	GS 1	
	O´ring G 21.89 x 2.62	GS 1	
	O´ring G 18.77 x 1.78	GS 1	
	O´ring G 12.42 x 1.78	GS 1	
	O´ring G 21.95 x 1.78	GS 1	
	Kit de retenes completo		R281700
	Jgo. retén válvulas (12)	P 1	R281710P
	Retén bancada 76 x 92 x 10	P 1	R241911P
	Retén distribución 44.47 x 61.19 x 9.57	N 1	R200012N

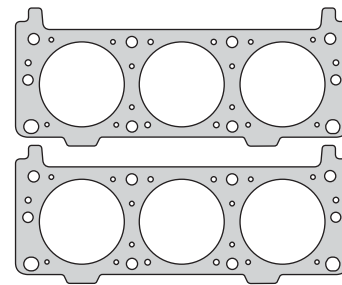

282007

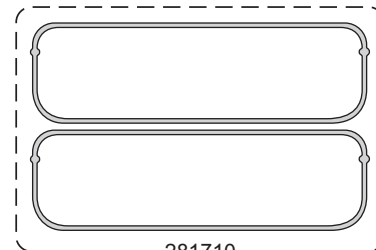

281710

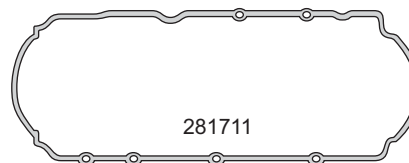

281711

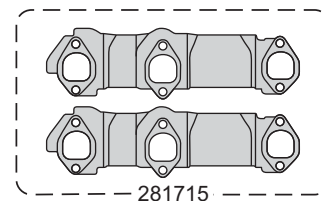

281715

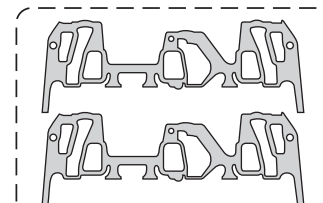

281717

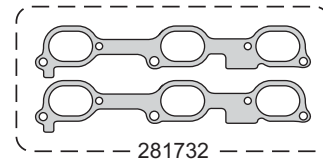

281732

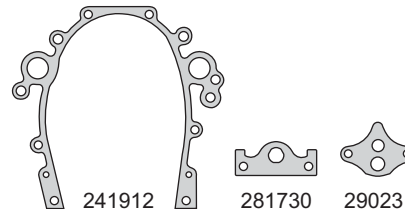

241912

281730

290231

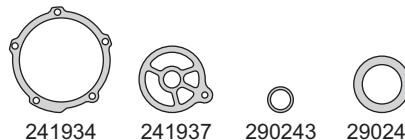

241934

241937

290243

290244



R241911P

R200012N

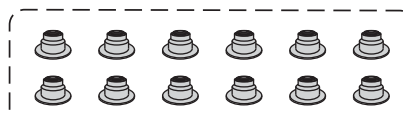

R281710P

**CHEVROLET**



Motor/Engine	Cm³	HP	Ø
Z22SE L61 (DOHC) 16V	2198	147	86

**Chevrolet:** Cavalier, Malibu, HHR, Astra, Zafira Vectra, Pontiac Sunfire, Grand Am 2000/03



Nº OE	Descripción/Description	Mat.	Ref.
	Jgo. de juntas para motor		● 282100-R
	Junta tapa cilindros Ø 87.0 $\pm$ 0.50 <b>NR</b>	MLS	1 282108
	Jgo. tornillos tapa cilindros (HAS15038)		B243600
	Conj. junta tapa válvulas (5)	GS	1 282110
	Junta distribución	GS/AC	1 282112
	Múltiple escape	GFT	1 282115
	Jgo. múltiple admisión (5)	VS	1 282117
	Junta	GS	1 282130
	Kit de retenes completo		R282100
	Jgo. retén válvulas (16)	P	1 R282110P
	Retén bancada 90 x 104 x 11	P	1 R240211P

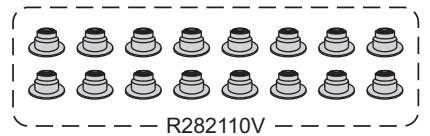
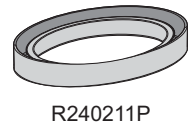
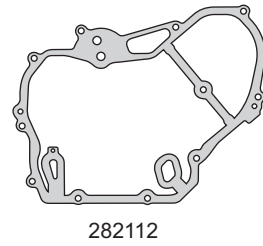
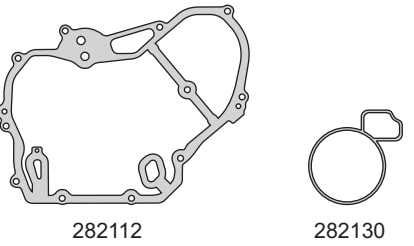
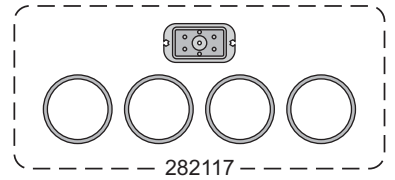
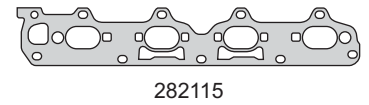
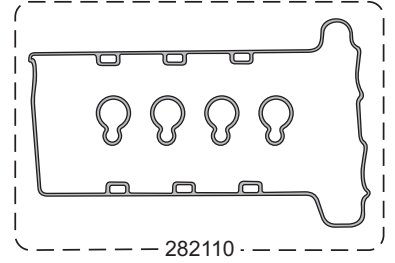
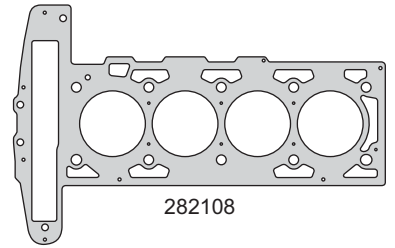

# CHEVROLET



Motor/Engine Cm³ HP Ø

**LG8**  
(OHV) V6 12V **3136** **170** **89**

Chevrolet: Malibu 1997/99



Nº OE	Descripción/Description	Mat.	Ref.
	<b>Jgo. de juntas para motor</b>		<b>282200-R</b>
	<b>Jgo. junta tapa cilin. Ø92.0 ±1.62 (2)</b>	<b>NFT 1</b>	<b>281707</b>
	Jgo. junta tapa válvulas (2)	GS 1	281710
	Junta para cárter	GS 1	281711
	Junta distribución	NB 1	241912
	Jgo. múltiple escape (2)	CHA 1	281715
	Jgo. múltiple admisión (2)	PLAST 1	282217
	Junta	NFT 1	281730
	Junta	CB 1	281731
	Junta chupador aceite	GFT 1	290231
	Jgo. entre múltiples (2)	NB 1	282232
	Guarnición	GS 7	281733
	Bomba de agua	CB 1	241934
	Junta base termostato	NB 1	241937
	O´ring G 11 x 20.5 x 2.5	S 1	290243
	Guarnición	N 1	290244
	O´ring G 10.77 x 2.62	GS 1	
	O´ring G 9.19 x 2.62	GS 6	
	O´ring G 13.94 x 2.62	GS 2	
	O´ring G 6.07 x 1.78	GS 1	
	O´ring G 7.52 x 3.53	GS 12	
	O´ring G 17.12 x 2.62	GS 1	
	O´ring G 21.89 x 2.62	GS 1	
	O´ring G 18.77 x 1.78	GS 1	
	O´ring G 12.42 x 1.78	GS 1	
	O´ring G 21.95 x 1.78	GS 1	
	O´ring G 28 x 5	GS 1	
	Kit de retenes completo		R282600
	Jgo. retén válvulas (12)	V 1	R282210V
	Retén bancada 76 x 92 x 10	P 1	R241911P
	Retén distribución 44.47 x 61.19 x 9.57	N 1	R200012N

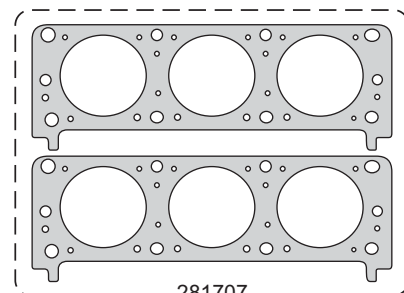

281707

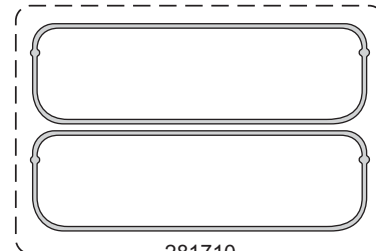

281710

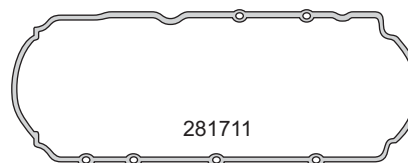

281711

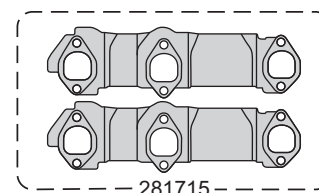

281715

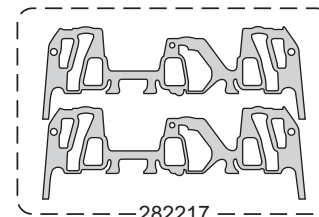

282217

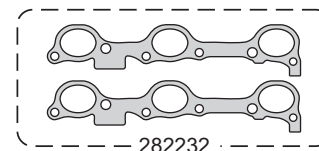

282232

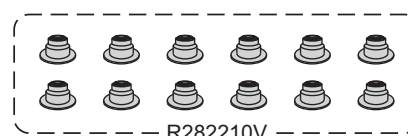
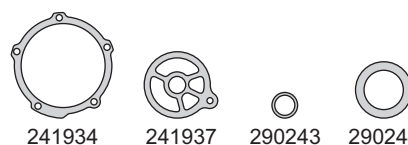
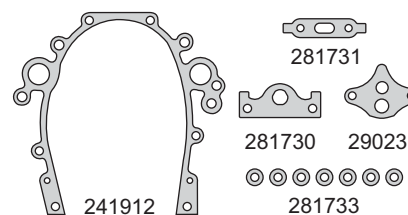

# CHEVROLET



Motor/Engine	Cm³	HP	Ø
Z14XE - Ecotec (DOHC) 16V	1389	90	73.4

Chevrolet: Corsa 2002/04



Nº OE	Descripción/Description	Mat.	Ref.
	Jgo. de juntas para motor		282300-R
	Junta tapa cilindros Ø 79.0 ± 1.70	GFT	1 282307
	Jgo. tornillos tapa cilindros (HAE12038)		B280600
	Sellador líquido - caucho de silicona		TRN0085G
	Conj. junta tapa válvulas (11)	GS	1 241810
	Junta distribución	SLS	1 241812
	Múltiple escape	GFT	1 282316
	Múltiple admisión	NB	1 282317
	Junta	NB	1 282330
	Junta	NB	1 282331
	Múltiple pleno de admisión	NB	1 282332
	O'ring G 10 x 2	GS	10
	O'ring G 15.54 x 2.62	GS	1
	O'ring G 80 x 3	GS	1
	O'ring G 60.05 x 1.78	GS	1
	Arandela A 14 x 18 x 1.25 A	AL	1
	Arandela A14 x 20 x 1.5 A	AL	1
	Kit de retenes completo		R282300
	Jgo. retén válvulas (16)	V	1 R280610V
	Retén bancada 80 x 98 x 10	P	1 R240411P
	Retén árbol levas 35 x 48 x 7	P	2 R240013P
	Retén distribución 26 x 42 x 8	V	1 R240415V

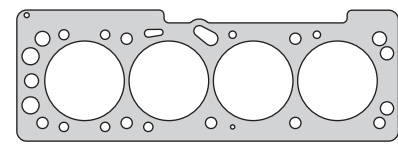

282307

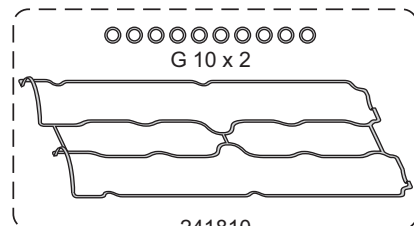

G 10 x 2

241810



282316

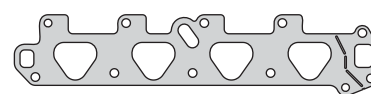

282317

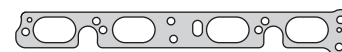

282332

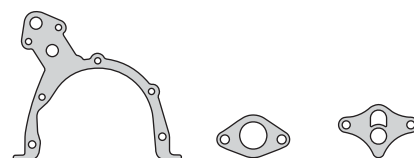

241812

282331

282330



G 80 x 3

G 60.05 x 1.78

G 15.54 x 2.62

A 14 x 18 x 1.25 A

A14 x 20 x 1.5 A



R240411P



R240013P

R240415V

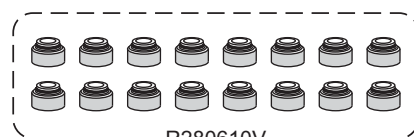

R280610V

# CHEVROLET



Motor/Engine	Cm³	HP	Ø
LD9 (DOHC) 16V	2392	141/152	90

**Chevrolet:** Pontiac Sunfire, Grand Am, Malibu  
Cavalier Z24 1996/04  
Alero 1999/...



Nº OE	Descripción/Description	Mat.	Ref.
	<b>Jgo. de juntas para motor</b>		<b>282400-R</b>
	<b>Junta tapa cilindros Ø 91.0 ±1.30</b>	NFT	<b>1 282407</b>
	Conj. junta tapa válvulas (4)	GS	1 282410
	Junta para cárter	AL/GS	1 282411
	Junta distribución	NH	1 282412
	Junta distribución	AL/GS	1 282412-1
	Junta tapa distribución	NB	1 282413
	Bomba de agua	NB	1 282414
	Bomba de agua	NB	1 282414-1
	Múltiple escape	AC	1 282415
	Múltiple admisión	PLAST	1 282417
	Junta placa de agua	AL/GS	1 282419
	Junta bomba aceite a block	GFT	1 282427
	Junta brida	AL/GS	1 282430
	Junta tapa de válvulas		2 282436
	Guarnición goma	GS	1 230243
	Junta	NH	1 282444
	Junta	SLS	2 282446
	Junta	NB	1 282445
	O´ring G 59.69 x 3.53	GS	1
	O´ring G 41 x 1.78	GS	1
	O´ring G 28.17 x 3.53	GS	1
	O´ring G 17.17 x 1.78	GS	1
	O´ring G 15.54 x 2.62	GS	2
	O´ring G 9.19 x 2.62	GS	8
	O´ring G 7.65 x 1.78	GS	2
	O´ring G 7.52 x 3.53	GS	8
	O´ring G 4.42 x 2.62	GS	1
	Kit de retenes completo		R282400
	Jgo. retén válvulas (16)	V	1 R282410V
	Retén bancada 82 x 96 x 8	V	1 R282411V
	Retén distribución 51 x 73.2 x 9.5	P	1 R282412P

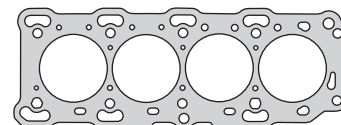

282407

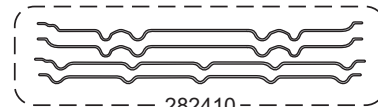

282410

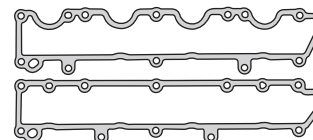

282411

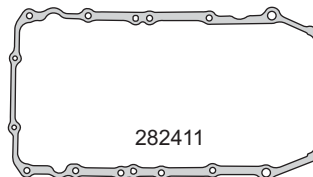

282412-1

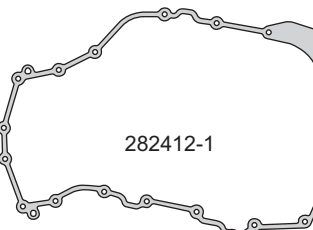

282414

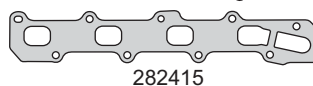

282414-1

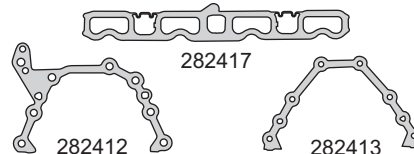

282415

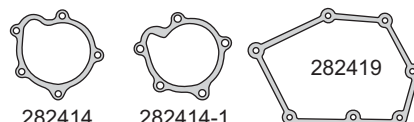

282419

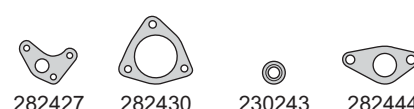

282427

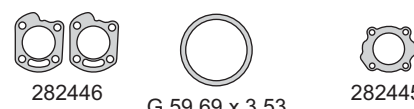

282430



230243



282446

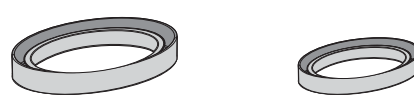

G 17.17 x 1.78

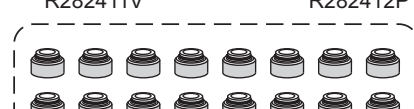

G 9.19 x 2.62

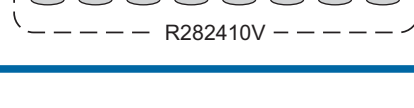

G 7.52 x 3.53



R282411V



R282410V



# CHEVROLET



Motor/Engine	Cm³	HP	Ø
B10S F12S3 (SOHC) 8V	995 1148	63 71/72	68.5 68.5

**Chevrolet:** Spark 2003/06, Aveo 2006/...  
**Daewoo:** Matiz 2003/06, Kalos 2002/...



Nº OE	Descripción/Description	Mat.	Ref.
93740055	Jgo. de juntas para motor		282500-R
	Jgo. de juntas superior		282595
	Jta. tapa cilindros Ø 70.0 ± 1.40	NFT 1 1	282507
	Jgo. de tornillos para tapa de cilindros		B282500
	Junta tapa válvulas	GS 1 1	282510
	Junta distribución	NB 1 1	940012
	Bomba de agua	NB 1 1	940014
	Múltiple escape	NFT 1 1	282515
	Múltiple admisión	GS 1 1	282517
	Bomba aceite	NB 1 1	940027
	Mariposa aceleración	GS 1 1	282532
	Tapa inyección	NB 1 1	940039
	Porta retén inyección	NB 1 1	940041
	Kit de retenes completo		R282500
	Jgo. retén válvulas (8)	P 1	R282510P
	Retén bancada 60 x 80 x 8	S 1	R940011S
	Retén árbol levas y distrib. 32 x 47 x 7	P 2	R282513P

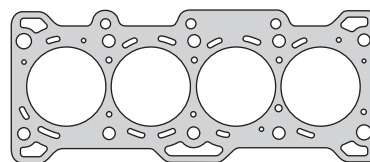

282507

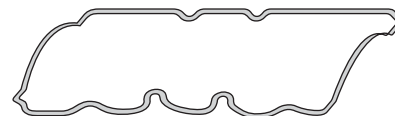

282510



282515



282517

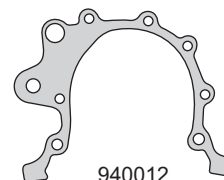

940012



940014



940027



282532



940039

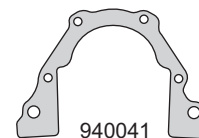

940041



R940011S



R282513P

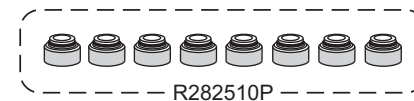

R282510P

# CHEVROLET



Motor/Engine	Cm³	HP	Ø
LA1 (OHV) V6 12V	3350	185	92

Chevrolet: Venture 1997/99



Nº OE	Descripción/Description	Mat.	Ref.
	<b>Jgo. de juntas para motor</b>		<b>282600-R</b>
	<b>Jgo. junta tapa cilin. Ø 95.0 ±1.40 (2)</b>	GFT	1 282007
	Jgo. junta tapa válvulas (2)	GS	1 281710
	Junta para cárter	GS	1 281711
	Junta distribución	NB	1 241912
	Jgo. múltiple escape (2)	CHA	1 281715
	Jgo. múltiple admisión (2)	PLAST	1 281717
	Junta	NFT	1 281730
	Junta chupador aceite	GFT	1 290231
	Jgo. entre múltiples (2)	NB	1 281732
	Bomba de agua	CB	1 241934
	Junta base termostato	NB	1 241937
	O´ring G 11 x 20.5 x 2.5	GS	1 290243
	Guarnición	N	1 290244
	O´ring G 10.77 x 2.62	GS	1
	O´ring G 9.19 x 2.62	GS	6
	O´ring G 13.94 x 2.62	GS	2
	O´ring G 6.07 x 1.78	GS	1
	O´ring G 7.52 x 3.53	GS	12
	O´ring G 17.12 x 2.62	GS	1
	O´ring G 21.89 x 2.62	GS	1
	O´ring G 18.77 x 1.78	GS	1
	O´ring G 12.42 x 1.78	GS	1
	O´ring G 21.95 x 1.78	GS	1
	Kit de retenes completo		R282600
	Jgo. retén válvulas (12)	V	1 R282210V
	Retén bancada 76 x 92 x 10	P	1 R241911P
	Retén distribución 44.47 x 61.19 x 9.57	N	1 R200012N

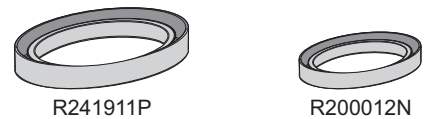
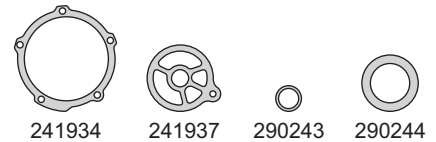
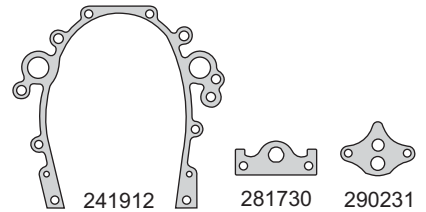
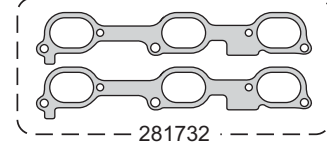
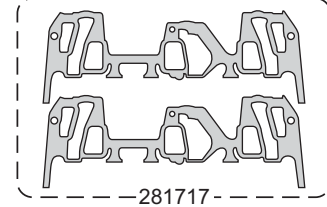
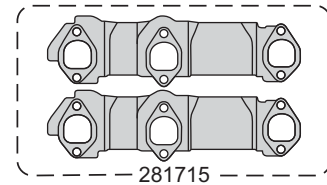
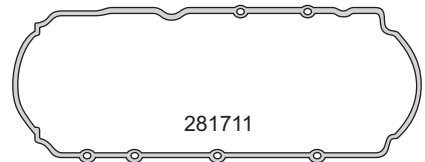
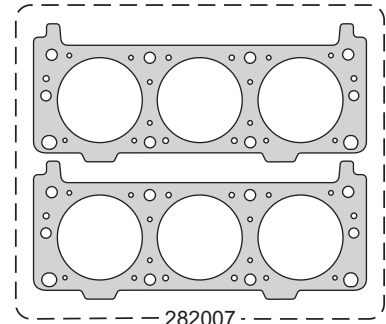

# CHEVROLET



Motor/Engine	Cm³	HP	Ø
LE5 (DOHC) 16V	2384	174	88

Chevrolet: Captiva 2008/...



Nº OE	Descripción/Description	Mat.	Ref.
	Jgo. de juntas para motor		● 290000-R MLS
	Junta tapa cilindros Ø 90.0 $\pm$ 1.30	NFT	290007
	Junta tapa cilindros Ø 89.0 $\pm$ 0.70	MLS	1 290008
	Jgo. tornillos tapa cilindros (HAS15038)		B243600
	Sellador líquido - caucho de silicona		TRN0085G
	Conj. junta tapa válvulas (2)	GS	1 290010
	Junta distribución	AC/GS	290012
	Bomba de agua	GS	1 290014
	Múltiple escape	AC	1 290015
	Jgo. múltiple admisión (4)	GS	1 290017
	Junta termostato	GS	1 290019
	Kit de retenes completo		R290000
	Jgo. retén válvulas (16)	V	1 R290010V
	Retén bancada 90 x 104 x 11	V	1 R240211V
	Retén distribución 42 x 55 x 7	V	1 R290013V

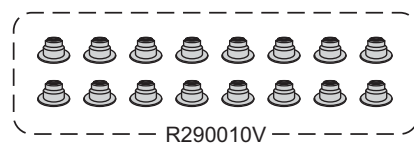
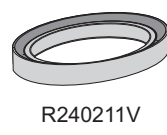
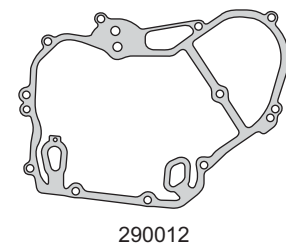
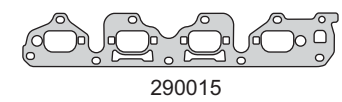
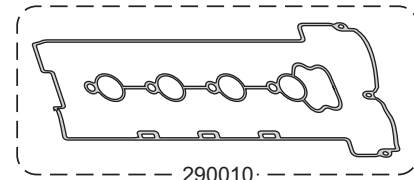
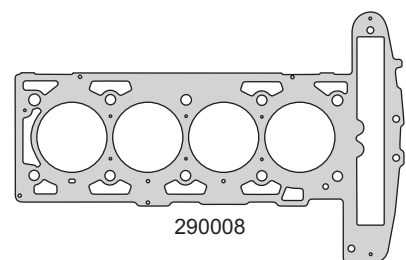

# CHEVROLET



Motor/Engine	Cm³	HP	Ø
F14 D3	1399	94	77.9
F16 D3 (DOHC) 16V	1598	103/109	79

**Chevrolet:** Nubira 2003/05, Aveo MPI 2004/...  
Pontiac G3 2008/...  
**Daewoo:** Kalos, Lacetti 2004/...  
Nubira 2003/05



Nº OE	Descripción/Description	Mat.	Ref.
93742687	Jgo. de juntas para motor		290100-R
	Jgo. de juntas superior (MLS)	●	290195
	Junta tapa cilindros Ø 80.5 ± 1.20	NFT 1 1	290107
96963220	Junta tapa cilindros Ø 80.0 ± 0.60	MLS	290108
	Jgo. tornillos tapa cilindros (HAS13038)		B290100
96353002	Junta tapa válvulas	GS 1 1	290110
	Junta para cárter	CG 1	240411
96414580	Frente motor bomba aceite	SLS 1	241812
	O´ring bomba de agua G 80 x 3	N 1	240414
96378805	Múltiple escape	AC 1 1	290115
96461130	Jgo. múltiple admisión (4)	GS 1 1	290117
96376371	Guarnición comando aceleración	GS 1 1	290130
	Guarnición anillo especial G 27.5 x 38.5 x 6	GS 1 1	290131
	O´ring G 15.54 x 2.62	GS 1 1	
	O´ring G 40.87 x 3.53	GS 1 1	
	Arandela A 20 x 24 x 1.5 A	AL 1 1	
	Arandela A 14 x 20 x 1.5 C	CU 1	
	Kit de retenes completo		R290100
	Jgo. retén válvulas (16)	V 1	R570910V
96376569	Retén bancada 80 x 98 x 10	P 1	R240411P
96350161	Reten distribución 30 x 42 x 7	P 1	R260113P
94580413	Retén árbol de levas 42 x 56 x 7	P 2	R300612P

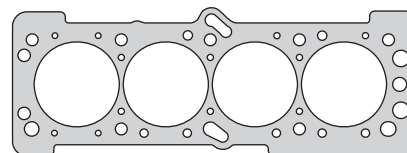

290107

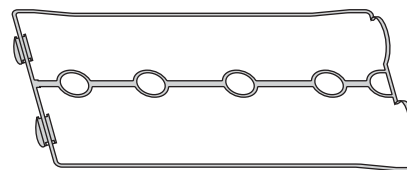

290110

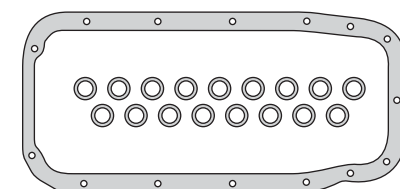

240411



290117

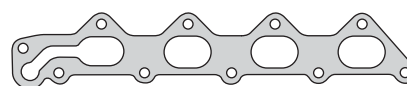

290115

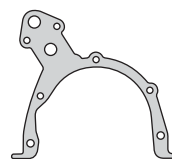

241812

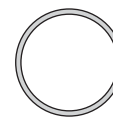

240414



290130



G 40.87 x 3.53



290131



A 14 x 20 x 1.5 C



G 15.54 x 2.62



A 20 x 24 x 1.5 A



R240411P

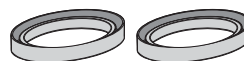

R300612P



R260113P

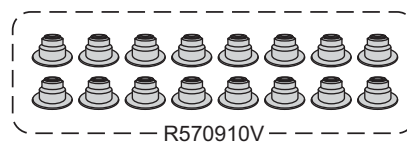

R570910V

# CHEVROLET



Motor/Engine	Cm³	HP	Ø
LN2 (OHV) 8V	2190	120	89

**Chevrolet:** Lumina, Cavalier 1987/97  
SS10 1997/99



Nº OE	Descripción/Description	Mat.	Ref.
	Jgo. de juntas para motor		290200-R
	Jgo. de juntas superior		290295
	Jta. tapa cilindros Ø 91.5 ± 1.60	NFT 1 1	290207
	Junta tapa válvulas	GS 1 1	290210
	Jgo. junta para cárter (2)	CG 1 1	290211
	Múltiple escape	NFT 1 1	290215
	Múltiple admisión	NFT 1 1	290216
	Múltiple admisión	NFT 1 1	290217
	Base termostato	GFT 1 1	290219
	Bomba aceite	CB 1 1	290227
	Tapa termostato	CB 1 1	290230
	Chupador aceite	GFT 1 1	290231
	Base filtro aceite	CB 1 1	290232
	Distribución aceite	GFT 1 1	290233
	Entrada agua	NFT 1 1	290234
	Salida agua	CB 1 1	290235
	Lateral de válvulas	CB 1 1	290236
	Retorno aceite	CB 1 1	290237
	Cogotera	N 1 1	290238
	Guarnición	N 1 1	290239
	Guarnición	N 1 1	290240
	Lateral	N 1 1	290241
	Varilla aceite	GFT 1 1	290242
	O´ring G 11 x 20.5 x 2.5	GS 1 1	290243
	Guarnición	N 1 1	290244
	Junta	N 1 1	290344
	O´ring G 9.19 x 2.62	GS 5 5	
	O´ring G 14 x 2.5	GS 2 2	
	O´ring G 12.42 x 1.78	GS 4 4	
	O´ring G 20 x 2	GS 4 4	
	O´ring G 15.6 x 1.78	GS 4 4	
	O´ring G 24.99 x 3.53	GS 2 2	
	O´ring G 21.95 x 1.78	GS 1 1	
	Arandela A 13 x 23 x 1.5 C	CU 1 1	
	Retén distribución 44.47 x 61.19 x 9.57	N 1 1	R200012N

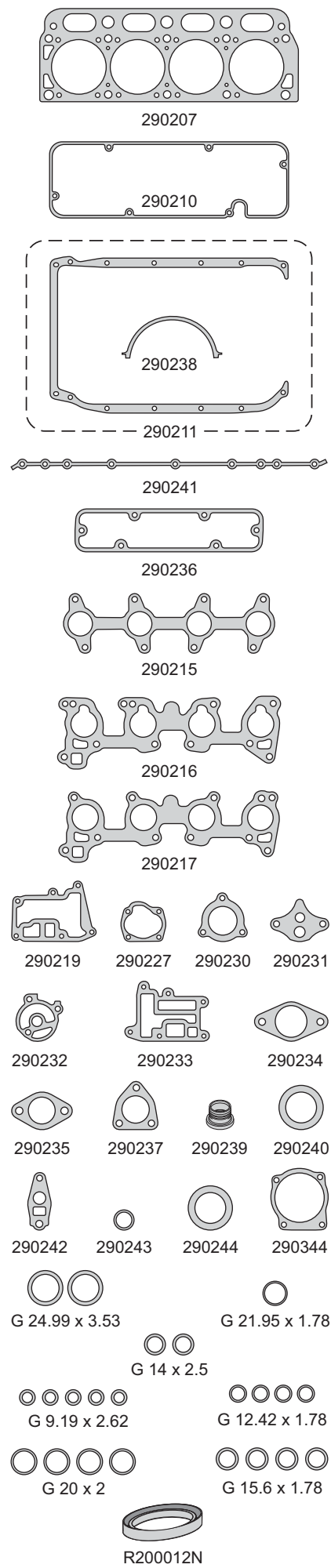

# CHEVROLET



Motor/Engine	Cm <sup>3</sup>	HP	Ø
LM3	2190	120	89

Chevrolet: Lumina, Cavalier 1994/97



Nº OE	Descripción/Description	Mat.	Ref.
	<b>Jgo. de juntas para motor</b>		<b>290300-R</b>
	<b>Junta tapa cilindros Ø 91.5 ± 1.60</b>	NFT	1 290307
	Junta tapa válvulas	GS	1 290210
	Jgo. junta para cárter (2)	CG	1 290211
	Múltiple escape	NFT	1 290215
	Múltiple escape	NFT	1 290216
	Base termostato	GFT	1 290219
	Bomba aceite	CB	1 290227
	Tapa termostato	CB	2 290230
	Chupador aceite	GFT	1 290231
	Base filtro aceite	CB	1 290232
	Distribución aceite	GFT	1 290233
	Lateral de válvulas	CB	1 290236
	Retorno aceite	CB	1 290237
	Cogotera	N	1 290238
	Guarnición	N	1 290239
	Guarnición	N	1 290240
	Lateral	N	1 290241
	Varilla aceite	GFT	1 290242
	Junta	CB	1 290342
	O´ring G 11 x 20.5 x 2.5	GS	1 290243
	Junta	CB	2 290343
	Junta	CB	2 290344
	Arandela A 13 x 23 x 1.5 C	CU	1
	O´ring G 6.07 x 1.78	GS	2
	O´ring G 8 x 1.5	GS	2
	O´ring G 12.42 x 1.78	GS	4
	O´ring G 14 x 2.5	GS	1
	O´ring G 20 x 2	GS	4
	O´ring G 24.99 x 3.53	GS	1
	Kit de retene completo		R290200
	Jgo. retén válvulas (8)	P	1 R290210P
	Retén bancada 76 x 92 x 10	P	1 R241911P
	Retén distribución 44.47 x 61.19 x 9.57	P	1 R200012P

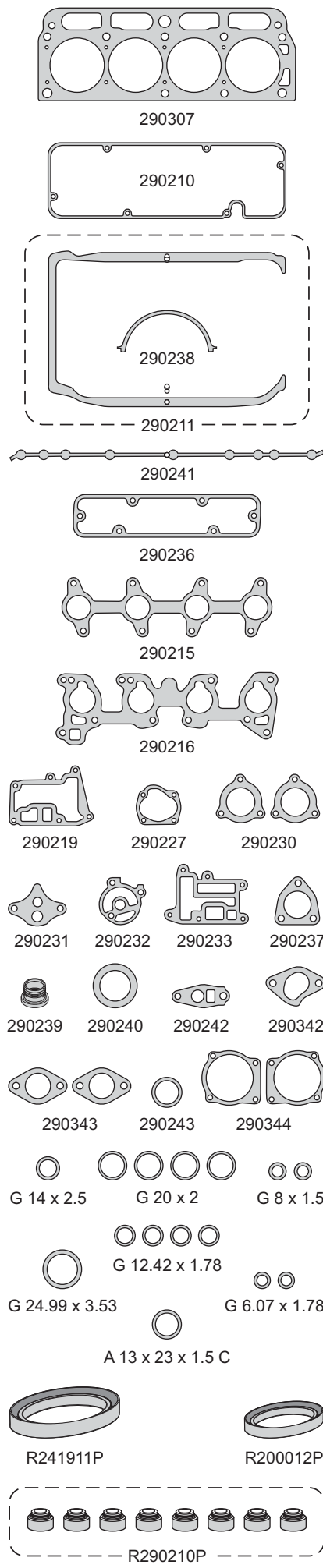

# CHEVROLET



Motor/Engine	Cm³	HP	Ø
262 V6	4294	180/193	101.6

**Chevrolet:** Capriche, Impala, Regal  
Blazer MPFI 1996/98



Nº OE	Descripción/Description	Mat.	Ref.
	Jgo. de juntas para motor		290600-R
	Jgo. junta tapa cil. Ø 105.0 ± 1.20 (2)	NFT	290605
	Jgo. junta tapa cil. Ø 105.0 ± 1.20 (2)	NFT	1 290607
	Conj. junta tapa válvulas (2)	GS	1 290610
	Jgo. junta para cárter	GS	1 290611
	Jgo. múltiple escape (4)	AC	1 290615
	Jgo. múltiple admisión (2)	PLAST	1 290617
	Acople bomba de aceite	CB	2 200029
	Válvula E.R.G.	GFT	2 290231
	Válvula E.R.G.	NB	1 242139
	Junta frente	NB	290635
	Entrada de aire	GS	290636
	Tubo unión	GS	290637
	Junta llenado 33 x 46	CB	1 280143
	Junta	CB	1 280144
	O'ring G 15.54 x 2.62	GS	1
	O'ring G 13 x 20 x 2 A	GS	1
	O'ring G 10.82 x 1.78	GS	1
	Kit de retenes completo		R290600
	Jgo. retén válvulas (12)	P	1 R290610P
	Retén bancada 91.5 x 114.8 x 12.5	S	1 R290611S
	Retén distribución 44.47 x 61.19 x 9.57	P	1 R200012P

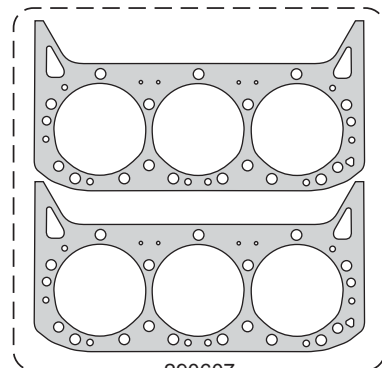

290607

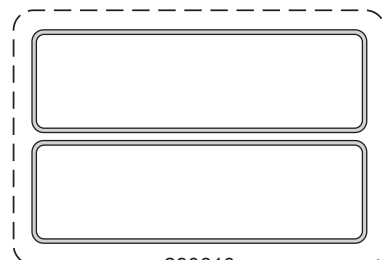

290610

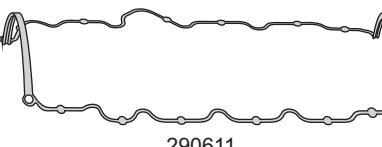

290611

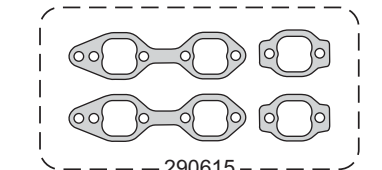

290615

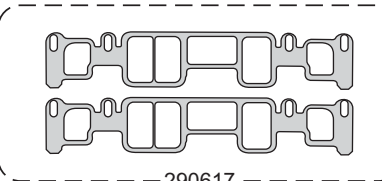

290617

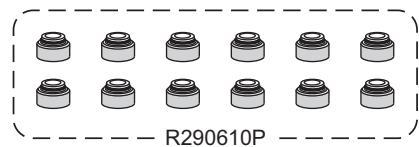
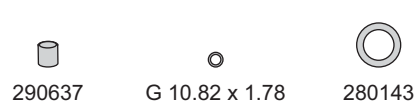
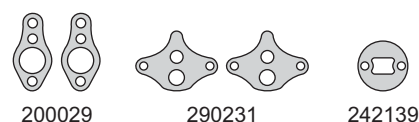

# CHEVROLET



Motor/Engine	Cm³	HP	Ø
X20 DTL	1995	82	84
X20 DTH	1995	100	84
X22 DTH (SOHC) 16V	2171	115/116	84

**Chevrolet:** Astra, Vectra, Omega, Zafira  
Opel Omega, Frontera, Sintra

**DIESEL**



Nº OE	Descripción/Description	Mat.	Ref.
	Jgo. de juntas para motor	●	290701-R
	Junta tapa cilindros Ø 86.0 $\pm$ 1.20	NFT	290707-SM
	Junta tapa cilindros Ø 86.0 $\pm$ 1.30	NFT	290707-1M
	Junta tapa cilindros Ø 86.0 $\pm$ 1.40	NFT	290707-2M
5607422	Junta tapa cilindros Ø 86.0 $\pm$ 1.20	MLS	290708-SM
5607423	Junta tapa cilindros Ø 86.0 $\pm$ 1.30	MLS	290708-1M
5607421	Junta tapa cilindros Ø 86.0 $\pm$ 1.40	MLS	290708-2M
90.502.072	Jgo. tornillos tapa cilindros (HAE18038)		B290700
90.571.911	Junta tapa válvulas	ACP 1	290710
90.502.195	Junta para cárter	NFT 1	290711
90.500.931	Múltiple escape	AC 1	290715
90.572.108	Múltiple admisión	SLS 1	290717
	Junta	NFT 1	290729
90.500.940	Múltiple entre colectores admisión	SLS 1	290731
	O'ring tapón cárter G 17.12 x 2.62	GS 1	
	O'ring G 45 x 4	GS 5	
	Kit de retenes completo		R290700
642.533	Jgo. retén válvulas (16)	V 1	R280610V
90.570.322	Retén bancada 99 x 114 x 11	V 1	R290711V
90.500.805	Retén distribución 55 x 68 x 8	V 1	R270612V
	Retén distribución 42 x 60 x 10 1997/98	P 1	R450412P

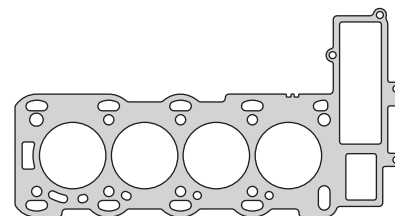

290707

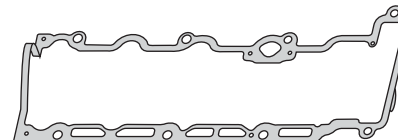

290710

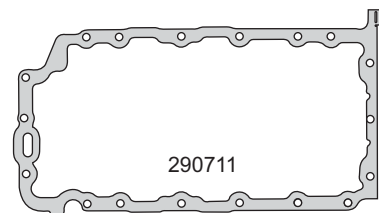

290711



290715



290717

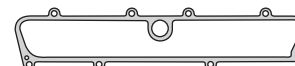

290731



290729



G 17.12 x 2.62



G 45 x 4



R290711V



R270612V



R450412P

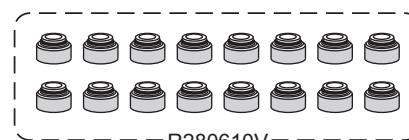

R280610V



# CHEVROLET



Motor/Engine	Cm³	HP	Ø
X20 XEV	1998	128/136	86
X22 XE (DOHC) 16V	2198	139/141	86

**Chevrolet:** Vectra, Astra, Calibra, Zafira 1994/...  
Astra, Vectra 1998/...  
Sintra 1996/99



Nº OE	Descripción/Description	Mat.	Ref.
	Jgo. de juntas para motor		290800-R
	Jgo. de juntas superior		290895
	Jta. tapa cilindros Ø 88.0 ±1.40	NFT 1	280705
56 07 409	Jta. tapa cilindros Ø 88.0 ±1.40 <b>NR</b>	NFT 1	280707
	Jgo. tornillos tapa cilin. (HAT55055/55100)		B280700
607 647	Conj. junta tapa de válvulas (11)	N 1 1	280710
652 635	Junta para cárter superior	NFT 1	290811
	Bomba aceite filtro a block	NB 1	240012
90220436	O´ring bomba de agua G 88.57 x 2.62	GS 1	280614
850 656	Múltiple escape	NFT 1 1	280715
850 655	Múltiple admisión	NB 1 1	280717
854 933	Salida de escape	FCH 1 1	240018
	Placa admisión	NFT 1 1	280729
	Guarnición goma termostato G 44.17 x 1.78	GS 1 1	280730
	Guarnición goma termostato G 66.4 x 1.78	GS 1 1	280731
652 636	Junta para cárter inferior	CG 1	290832
	Nivel aceite	SLS 1	280733
	Junta	NB 1	290833
	Junta	NB 1	290834
	Junta	CG 1	290835
	Arandela A 14 x 20 x 1C	CU 1	
	Arandela A 20 x 24 x 1.5 A	AL 1	
	O´ring G 9 x 2	GS 10 10	
	O´ring G 15.54 x 2.62	GS 1	
	O´ring G 16 x 2	GS 1	
	O´ring G 47.22 x 3.53	GS 2	
	O´ring G 50 x 4	GS 1	
	O´ring G 52.07 x 2.62	GS 1	
	O´ring G 53.7 x 1.78	GS 1	
	O´ring G 64.77 x 2.62	GS 3	
	Kit de retenes completo		R280700
642 533	Jgo. retén válvulas (16)	V 1	R280610V
614 827	Retén bancada 90 x 104 x 11	V 1	R240211V
646 265	Retén distribución 31 x 50 x 8	V 1	R240012V
636 841	Retén árbol de levas 35 x 48 x 7	V 2	R240013V

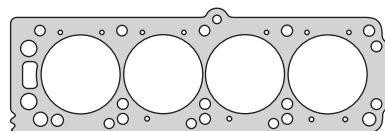

280707

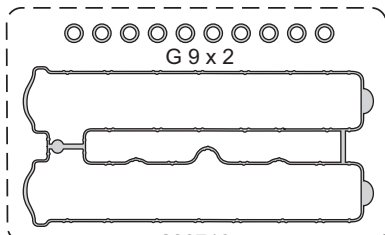

280710

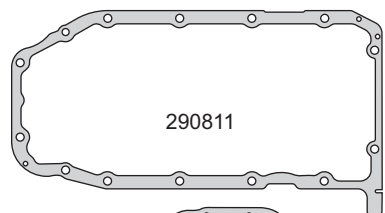

290811

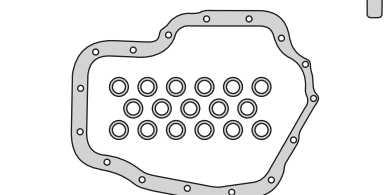

290832

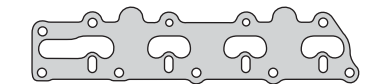

280715



280717

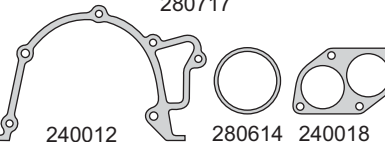

240012

280614

240018



280729

280730

280731

280733

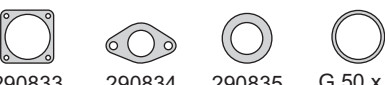

290833

290834

290835

G 50 x 4



G 64.77 x 2.62

G 47.22 x 3.53

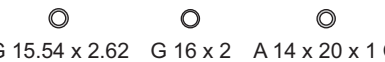

G 15.54 x 2.62

G 16 x 2

A 14 x 20 x 1 C

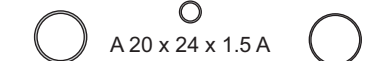

A 20 x 24 x 1.5 A

G 52.07 x 2.62

G 53.7 x 1.78



R240211V



R240012V

R240013V

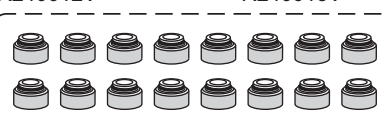

R280610V

# CHEVROLET



Motor/Engine	Cm³	HP	Ø
C20XE	1998	136/150	86
C20LET (DOHC) 16V	1998	204	86

**Chevrolet:** Vectra 1994/96, Calibra 1989/97  
Kadett E 1987/91, Calibra Turbo  
1992/97, Vectra Turbo 1993/95

**Lada:** 110 GTI 1996/...



Nº OE	Descripción/Description	Mat.	Ref.
	Jgo. de juntas superior		290995
	Junta tapa cilindros Ø 88.0 ± 1.30	NFT 1	290907
	Jgo. tornillos tapa cilindros (HAE14038)		B290900
	Junta tapa de válvulas	GS 1	290910
	Múltiple escape	NFT 1	290916
	Múltiple admisión	NH 1	290917
	Arandela A 12 x 17 x 1.5 C	CU 1	
	O´ring G 50.52 x 1.78	GS 1	
	O´ring G 55.25 x 2.62	GS 1	
	Jgo. retén válvulas (8)	V	R240210V
	Retén árbol de levas 35 x 48 x 7	V	R240013V

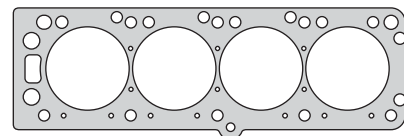

290907

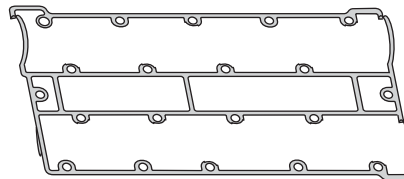

290910

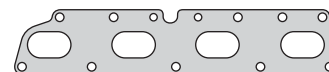

290916



290917



A 12 x 17 x 1.5 C



G 50.52 x 1.78



G 55.25 x 2.62



R240013V



R240210V

# CHEVROLET



Motor/Engine	Cm³	HP	Ø
F14D4	1399	101	80.5
F18D4 MPI	1796	141	80.5
Z18XER/A18XER	1796	141	80.5
939A4 (DOHC) 16V	1796	140	80.5

Alfa Romeo: 159 2005/...  
 Chevrolet: Cruze 1.8 2008/..., Aveo 1.4 2009/...  
 Fiat: Croma 2005/...  
 Opel: Astra H 2004/..., Signum, Vectra C 2006/..., Zafira B 2005/..., Insignia 2008/...



Nº OE	Descripción/Description	Mat.	Ref.
	Jgo. de juntas para motor		● 291000-R MLS
	Jgo. de juntas superior (MLS)		291095 MLS
	Jgo. de juntas superior	●	291095
	Junta tapa cilindros Ø82.0 ± 1.20 NR	NFT 1	291007
93186222	Junta tapa cilindros Ø82.0 ± 0.60 NR	MLS 1	291008
	Jgo. tornillos tapa cilindros (HAE12038)		B280600
	Conj. junta tapa de válvulas (5)	GS 1 1	291010
	Junta para cárter	NB	291011
	Frente motor	AL/GS 1 1	291012
	Bomba de agua	GS 1 1	291014
12992396	Múltiple escape	AC 1 1	291015
	Múltiple admisión	GS 1 1	291017
55557507	Salida de escape	AC 1 1	291018
55353353	Guarnición termostato	GS 1 1	291019
55354071	Guarnición radiador filtro aceite	GS 1	291027
	Kit venteo tapa de válvulas	GS 1 1	291029
	Guarnición goma	GS 1 1	291030
55353321	Guarnición filtro aceite	GS 1	291031
	Guarnición capuchón de bujía	GS 4 4	291032
	Guarnición entrada de aceite	GS 2	291033
55353319	Guarnición filtro aceite	GS 1	291035
	Guarnición entrada de aceite	GS 2	291037
	Guarnición venteo tapa de válvulas	GS 1 1	291038
	Guarnición venteo tapa de válvulas	GS 1 1	291039
	Guarnición venteo tapa de válvulas	GS 1 1	291040
	Guarnición diafragma venteo tapa de válvulas	GS 1 1	291042
	Kit refrigerador aceite (3)	GS 1	291048
	O´ring G 11 x 3.2	GS 2	
	O´ring G 22 x 3.15	GS 4 4	
	O´ring G 64 x 3.6	GS 1	
	Kit de retenes completo		R291000
	Jgo. retén válvulas (16)	V 1	R291010V
55555805	Porta retén bancada	T 1	PR291011T
55563374	Retén distribución 32 x 42 x 7	V 1	R230512V
	Retén árbol levas 35 x 48 x 7	V 2	R240013V

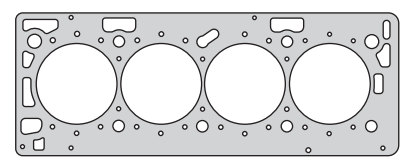

291008

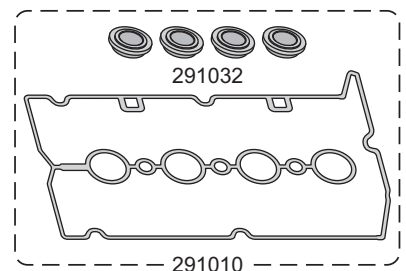

291032

291010

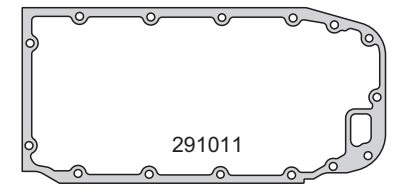

291011

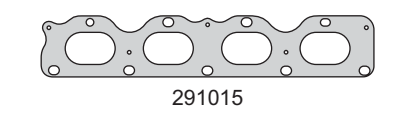

291015



291017

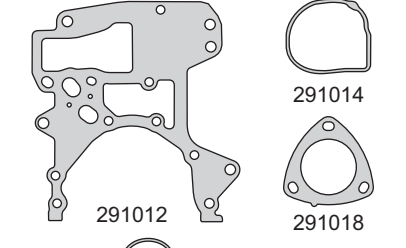

291012

291014

291018

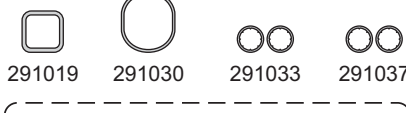

291019

291030

291033

291037

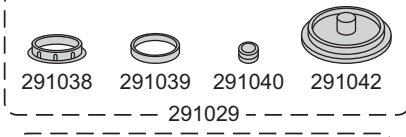

291038

291039

291040

291042

291029

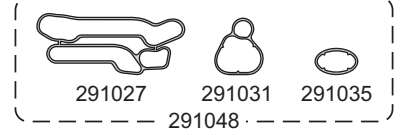

291027

291031

291035

291048



G 22 x 3.15

G 64 x 3.6

G 11 x 3.2

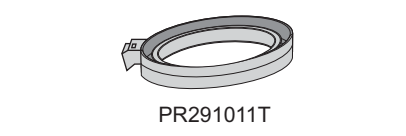

PR291011T

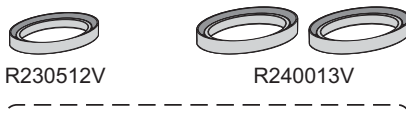

R230512V

R240013V

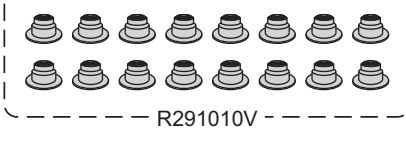

R291010V

# CHEVROLET



Motor/Engine	Cm³	HP	Ø
Z20DM	1991	121/126	83
Z20S/DMH (SOHC) 16V	1991	150	83

**Chevrolet:** Epica, Optra 2006/11, Lacetti, Nubira Captiva, Tosca 2007/..., Cruze 2009/...  
**Daewoo:** Epica, Captiva, Toscana 2006/...  
**Opel:** Antara 2006/10

DIESEL



Nº OE	Descripción/Description	Mat.	Ref.
	Jgo. de juntas para motor		291101-R
	Junta tapa cilindros Ø 84.0 $\pm$ 1.20	NFT	291107-1M
	Junta tapa cilindros Ø 84.0 $\pm$ 1.30	NFT	291107-2M
	Junta tapa cilindros Ø 84.0 $\pm$ 1.40	NFT	291107-3M
	Junta tapa cilindros Ø 84.2 $\pm$ 1.10	MLS	291108-1M
	Junta tapa cilindros Ø 84.2 $\pm$ 1.20	MLS	291108-2M
	Junta tapa cilindros Ø 84.2 $\pm$ 1.30	MLS	291108-3M
	Jgo. tornillos tapa cilindros (HAD14038)		B291100
	Sellador líquido - caucho de silicona		TRN0085G
	Junta tapa válvulas	GS 1	291110
	Bomba de agua	NB 1	291114
	Múltiple escape	AC 1	291115
	Múltiple admisión	SLS 1	291117
	Salida de escape	FCH 1	291118
	Junta termostato	NB 1	291119
	Junta	NB 1	291130
	Válvula EGR	AC 5	291131
	Junta	NB 1	291132
	Junta	FCH 1	291133
	Junta	NB 1	291134
	Arandela A 10 x 14 x 1 A	AL 4	
	Arandela A 7.5 x 15 x 1.45 A	AL 4	
	Kit de retenes completo		R291100
	Jgo. retén válvulas (16)	V 1	R291110V
	Retén bancada 98 x 114 x 8	P 1	R291111P
	Retén distribución 32 x 45 x 6	P 1	R291112P
	Retén árbol de levas 36 x 50 x 8	P 1	R460213P

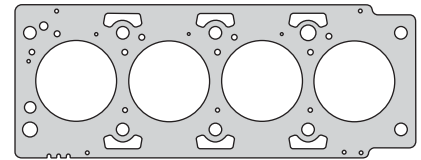

291108

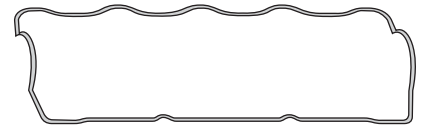

291110



291115



291117



291114



291118



291119



291130

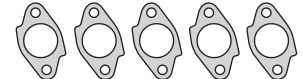

291131



291132



291134

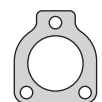

291133



A 10 x 14 x 1 A



A 7.5 x 15 x 1.45 A



R291111P



R291112P



R460213P

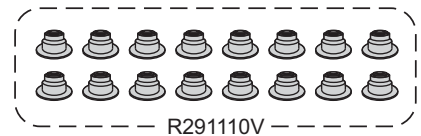

R291110V

# CHEVROLET



Motor/Engine	Cm³	HP	Ø
MPFI 8V	1796	110	84.8

Chevrolet: Astra MPFI 1999/...



Nº OE	Descripción/Description	Mat.	Ref.
	Jgo. de juntas para motor		291200-R
	Jgo. de juntas superior		291295
	Jta. tapa cilindros Ø 88.0 ± 1.40	NFT 1 1	240205
	Jta. tapa cilindros Ø 88.0 ± 1.40 NR	NFT	240207
	Jgo. tornillos tapa cilin. (HAT55055/55100)		B240000
90467601	Junta tapa válvulas	N 1 1	241410
652635	Junta para cárter superior	NFT 1 1	290811
	Bomba aceite y filtro a block	NB 1 1	240012
	O'ring bomba de agua G 85.32 x 3.53	GS 1 1	291214
90106615	Múltiple escape	NFT 1 1	240016
	Múltiple admisión	NFT 1 1	240517
90128293	Salida de escape	FCH 1 1	240018
	O'ring termostato G 50 x 4	GS 1	240019
90231306	Junta	NB 1 1	241430
	Junta válvula mariposa	NB 1 1	291230
90183165	Junta	NB 1 1	241431
	Junta separador bomba de aceite	NB 1	240232
	Arandela A 14 x 20 x 1.5 C	CU 1	
	O'ring G 15.54 x 2.62	GS 1	
	O'ring G 16 x 2	GS 1	
	O'ring G 45.69 x 2.62	GS 1	
	O'ring G 48 x 4	GS 1	
	O'ring G 55.25 x 2.62	GS 1	
	O'ring G 63.17 x 2.62	GS 3	
	Kit de retenes completo		R240200
	Jgo. retén válvulas (8)	V 1	R240210V
	Retén bancada 90 x 104 x 11	P 1	R240211P
	Retén distribución 31 x 50 x 8	P 1	R240012P
	Retén árbol levas 35 x 48 x 7	P 1	R240013P

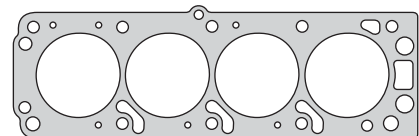

240205

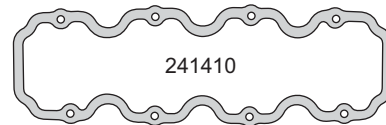

241410

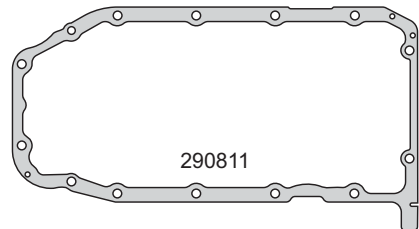

290811

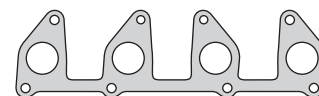

240016



240517



240012

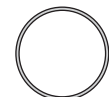

291214



240018

240019

291230

241430



241431

A 14 x 20 x 1.5 C



240232



G 55.25 x 2.62



G 48 x 4



G 45.69 x 2.62

G 16 x 2



G 63.17 x 2.62

G 15.54 x 2.62



R240211P



R240012P



R240013P



R240210V

# CHEVROLET



Motor/Engine	Cm³	HP	Ø
VM - CTDI	2776	180	94

Chevrolet: S10, Trail Blazer 2012

DIESEL



Nº OE	Descripción/Description	Mat.	Ref.
	Jgo. de juntas para motor		291301-R
	Jgo. de juntas superior	●	291395-1M
	Jgo. de juntas superior		291395-2M
	Jgo. de juntas superior		291395-3M
	Junta tapa cilindros Ø 95.0 $\pm$ 1.20	NFT 1	291307-1M
	Junta tapa cilindros Ø 95.0 $\pm$ 1.30	NFT	291307-2M
	Junta tapa cilindros Ø 95.0 $\pm$ 1.40	NFT	291307-3M
12625492	Junta tapa cilindros Ø 95.4 $\pm$ 1.10	MLS	291308-1M
12625493	Junta tapa cilindros Ø 95.4 $\pm$ 1.20	MLS	291308-2M
12625494	Junta tapa cilindros Ø 95.4 $\pm$ 1.30	MLS	291308-3M
12625498	Jgo. tornillos tapa cilindros (HAS17038)		B291300
12637611	Conj. junta tapa válvulas (2)	GS 1 1	291310
12625698	Junta para cárter	AC/GS 1	291311
12625613	Tapa distribución	MLS 1	291312
12625424	Placa distribución	MLS 1	291313
12648132	Bomba de agua	GS 1 1	291314
12642186	Múltiple escape	AC 1 1	291315
12637739	Múltiple admisión	GS 1 1	291317
94718254	Salida de escape	AC 1	291318
12650486	Junta sellador termostato	GS 1 1	291319
12629737	Junta cárter inferior	AC/GS 1	291330
12640049	Junta TBI	GS 1 1	291332
12625506	Tapón ciego	AC/N 1 1	291338
12642185	Junta retorno aceite a turbo	MLS 1 1	291341
12642175	Junta turbo	AC 1	291342
12650512	O'ring G 42 x 4	GS 1	
	Kit de retenes completo		R291300
90410741	Jgo. retén válvulas (16)	V 1	R280610V
12625417	Retén bancada 91.8 x 115.3 x 7	P 1	R291311P
12625490	Retén distribución 30.9 x 55.30 x 6.27	T 1	R291312T
12625490	Retén árbol de levas	P 1	R291313P

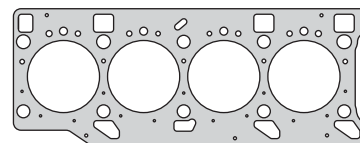

291308

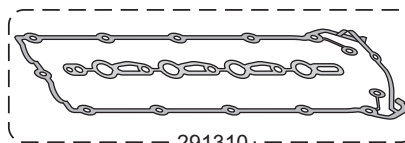

291310

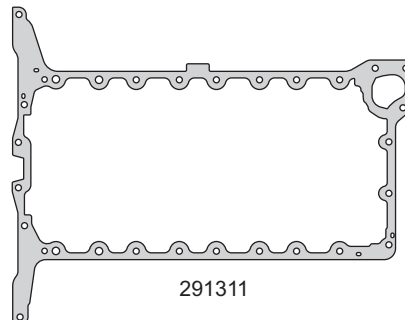

291311



291315



291317

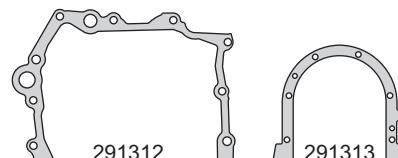

291312

291313

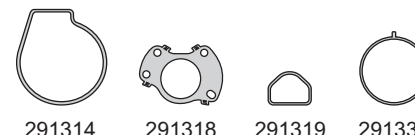

291314

291318

291319

291332

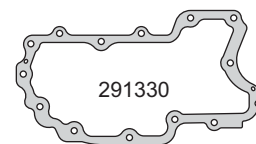

291330



291342



291341



291338



G 42 x 4



R291311P



R291312P



R291313T

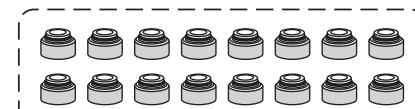

R280610V

# CHEVROLET



Motor/Engine	Cm³	HP	Ø
<b>ECOTEC</b> (DOHC) 16V	<b>1362</b> <b>1398</b>	<b>138/140</b> <b>100/149</b>	<b>72.5</b> <b>73.4</b>

**Chevrolet:** Aveo 2008/..., Aveo, Volt 2011/...  
Cruze 2011/..., 2013/...



Nº OE	Descripción/Description	Mat.	Ref.
	<b>Jgo. de juntas para motor</b>		● <b>291400-R MLS</b>
	<b>Junta tapa cilindros Ø 74.0 ± 1.20</b>	<b>NFT</b>	<b>291407</b>
	<b>Junta tapa cilindros Ø 73.6 ± 0.65</b>	<b>MLS</b>	<b>1 291408</b>
	<b>Sellador líquido - caucho de silicona</b>		<b>TRN0085G</b>
	Junta tapa válvulas	GS	1 291410
	Junta distribución	AC/GS	1 291412
	Bomba de agua	AC/GS	1 291414
	Múltiple escape	AC	1 291415
	Múltiple escape	AC	1 291415-1
	Múltiple admisión	AC	1 291417
	Jgo. múltiple admisión (5)	GS	1 291417-1
	Guarnición termostato	GS	1 291419
	Guarnición filtro de aceite	GS	1 291427
	O´ring G 7.5 x 3.63	GS	8
	O´ring G 17 x 2.70	GS	1
	O´ring G 61 x 3.53	GS	1
	Kit de retenes completo		R291400
	Jgo. retén válvulas (16)	P	1 R291410P
	Retén bancada 80 x 98 x 10	S	1 R240411S
	Retén distribución 42 x 55x 7	S	1 R290013S

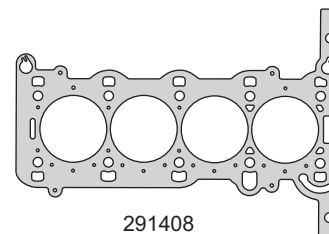

291408

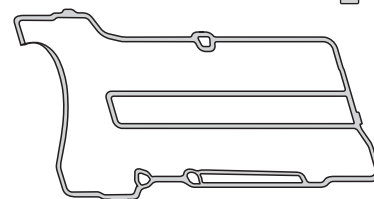

291410

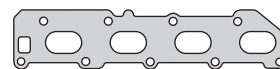

291414



291415



291415-1



291417



291417-1

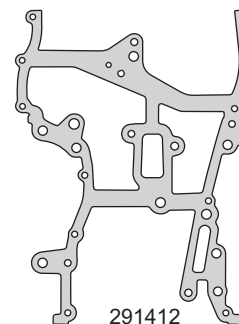

291412



291414



291419

G 61 x 3.53

291427

G 17 x 2.70

G 7.5 x 3.63



R240411S



R290013S

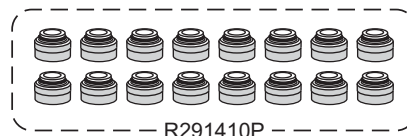

R291410P

# CHEVROLET



Motor/Engine	Cm³	HP	Ø
LE2 Ecotec (DOHC) 16V	1399 1490	150 172	73.8 74

**Chevrolet:** Cruze, Tracker, Astra 2017/...  
Equinox 2020/...



N° OE	Descripción/Description	Mat.	Ref.
	Jgo. de juntas para motor		● 291700-R MLS
12681524	Jgo. de juntas superior (MLS)		291795 MLS
	Jgo. de juntas superior	●	291795
	Jta. tapa cilindros Ø 75.0 $\pm$ 1.20	NFT 1	291707
	Jta. tapa cilindros Ø 75.0 $\pm$ 0.90	MLS 1	291708
12636177/6384	Conj. junta tapa válvulas (2)	GS 1 1	291710
	Junta para cárter	NB 1	291711
12637018	Múltiple admisión	GS 1 1	291717
	Jgo. múltiple admisión (4)	GS 4 4	291717-1
	Junta sobre cárter	NB 1	291731
12641115	Junta turbo compresor	AC	291739
	O´ring G 79 x 3	GS 1 1	
	Kit de retenes completo		R291700
	Jgo. retén válvulas (16)	V 1 1	R291710V
12653685	Retén bancada 84 x 100 x 8.9	S 1 1	R291711S
12661527	Retén distribución 44 x 60 x 8.5	P 1 1	R291712P

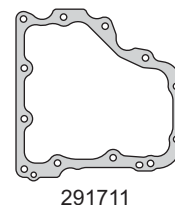
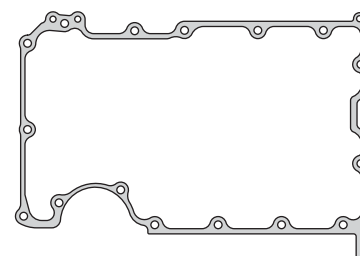
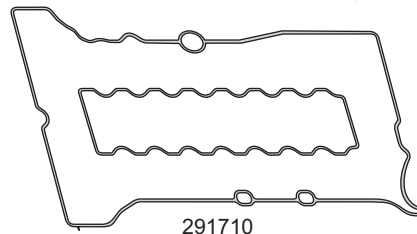
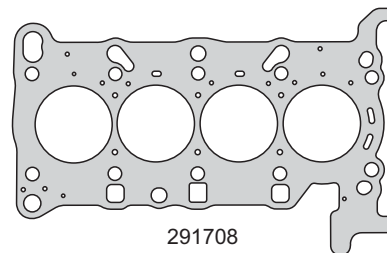



# CHEVROLET



Motor/Engine **Cm³** **HP** **Ø**

**LNF**  
**Ecotec Turbo**  
(DOHC) 16V

1998

253

86

Chevrolet: Cobalt 2008/10, Astra 2012/...



Nº OE	Descripción/Description	Mat.	Ref.
	Jgo. de juntas para motor		● 291800-R MLS
12589346B	Junta tapa cilindros Ø 87.0 ±0.60		291808
	Jgo. tornillos tapa cilindros (HAS15038)	MLS	1 B243600
	Sellador líquido - caucho de silicona		TRN0085G
12609291B	Conj. junta tapa válvulas (2)	GS	1 291810
24435052B	Junta distribución	AC/GS	1 290012
24439799B	Bomba de agua	GS	1 290014
12622668B	Múltiple escape	SLS	1 291815
	Jgo. múltiple admisión (4)	SLS	1 291817
12618586B	Salida de escape a turbo	SLS	1 291818
	Junta termostato	GS	1 290019
	Junta distribución	NB	1 291840
	Kit de retenes completo		R290000
	Jgo. retén válvulas (16)	V	1 R290010V
	Retén bancada 90 x 104 x 11	V	1 R240211V
	Retén distribución 42 x 55 x 7	V	1 R290013V

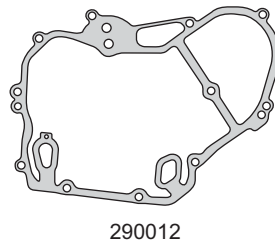
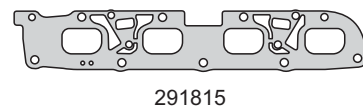
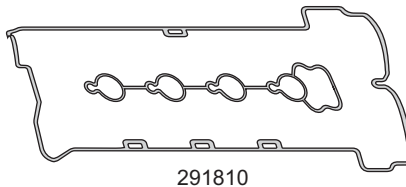
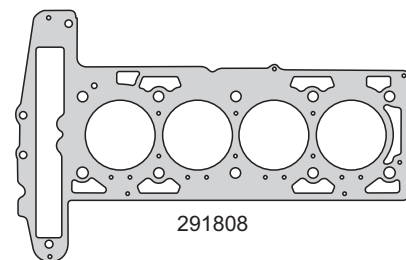

# CHEVROLET



Motor/Engine	Cm³	HP	Ø
VM - CTDI	2776	200	94

Chevrolet: S10, Trail Blazer 2013/...

DIESEL



Nº OE	Descripción/Description	Mat.			Ref.
	Jgo. de juntas para motor				291301-R
	Jgo. de juntas superior		●		291995-1M
	Jgo. de juntas superior				291995-2M
	Jgo. de juntas superior				291995-3M
	Junta tapa cilindros Ø 95.0 ± 1.20	NFT	1		291907-1M
	Junta tapa cilindros Ø 95.0 ± 1.30	NFT			291907-2M
	Junta tapa cilindros Ø 95.0 ± 1.40	NFT			291907-3M
12625492	Junta tapa cilindros Ø 95.0 ± 1.10	MLS			291908-1M
12625493	Junta tapa cilindros Ø 95.0 ± 1.20	MLS			291908-2M
12625494	Junta tapa cilindros Ø 95.0 ± 1.30	MLS			291908-3M
12625498	Jgo. tornillos tapa cilindros (HAS17038)				B291300
12637611	Conj. junta tapa válvulas (2)	GS	1	1	291310
12625698	Junta para cárter	AC/GS		1	291311
12625613	Tapa distribución	MLS		1	291312
12625424	Placa distribución	MLS		1	291313
12648132	Bomba de agua	GS	1	1	291314
12642186	Múltiple escape	AC	1	1	291315
12637739	Múltiple admisión	GS	1	1	291317
94718254	Salida de escape	AC		1	291318
12650486	Junta sellador termostato	GS	1	1	291319
12629737	Junta cárter inferior	AC/GS		1	291330
12640049	Junta TBI	GS	1	1	291332
12625506	Tapón ciego	AC/N	1	1	291338
12642185	Junta retorno aceite a turbo	MLS	1	1	291341
12642175	Junta turbo	AC		1	291342
12650512	O´ring G 42 x 4	GS		1	
	Kit de retenes completo				R291300
90410741	Jgo. retén válvulas (16)	V	1	1	R280610V
12625417	Retén bancada 91.8 x 115.3 x 7	P	1	1	R291311P
12625490	Retén distribución 30.9 x 55.30 x 6.27	T	1	1	R291312T
12625490	Retén árbol de levas	P	1	1	R291313P

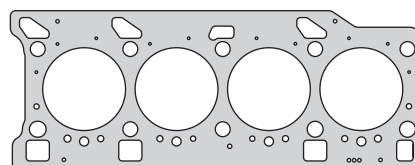

291907

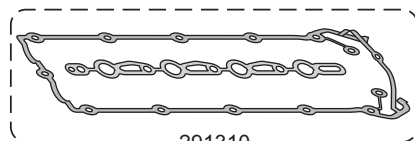

291310

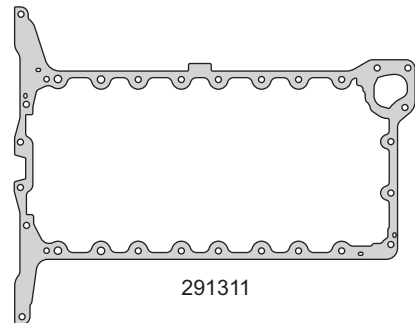

291311

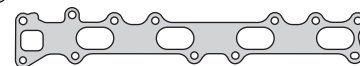

291312



291315

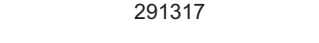

291317

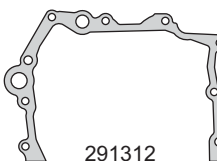

291312

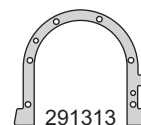

291313



291314



291318



291319



291332

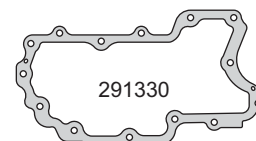

291330



291342



291341



291338



G 42 x 4



R291311P



R291312P



R291313T

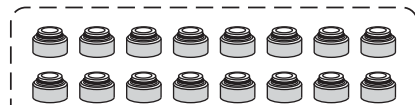



R280610V

# CHRYSLER / DODGE / JEEP

## JUNTA TAPA DE CILINDROS / HEAD GASKETS

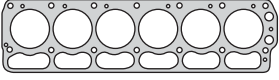
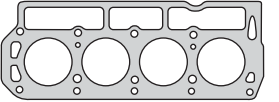

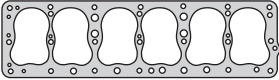
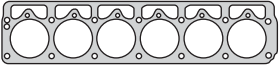
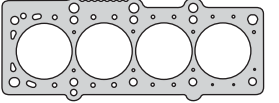
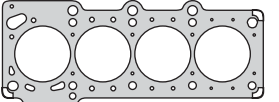
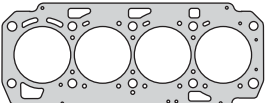
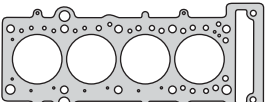







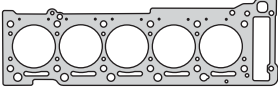

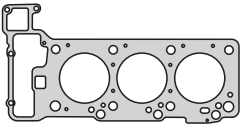

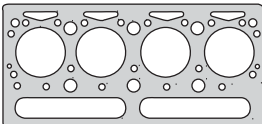

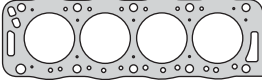

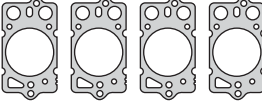
### MOTORES NAFTA Y DIESEL / PETROL AND DIESEL ENGINES

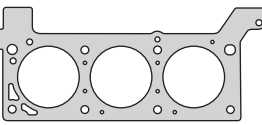
	Código Code	Q	≠	Kit Bulón Bolt Set	Aplicación Application	Motor Engine	Juego
	220005	89.0	1.40		Valiant I/II/III/IV D100, D2800, Polara Coronado, RT 1964/79	2788cc. 170 130HP Ø86.36 3687cc. 225 130HP Ø86.36	220000-R 🚗 pág. 114
	220105 220106	88.0 88.0	1.40 2.40	B220100 🔧 HAT55055 HAT55100	D1500, GT90, GT100, Paikan 1971/... D1800 - Paikan 1971/...	1498cc. Hillman 72HP Ø86 1798cc. Hillman 110HP Ø86	220100-R 🚗 pág. 115
	220505	102.0	1.40		GTX, Coupe 1970/...	5210cc. 318 V8 202HP Ø99.31	220500 🚗 pág. 116
	220705	88.0	1.40		Continental 3 3/8 - 3 7/16 D100/200/400/500 1951/64	3956cc. 241 95HP Ø85.73 4106cc. 251 100HP Ø87.31	220700 🚗 pág. 117
	220907	102.0	1.20	B220900	Grand Cherokee Laredo, Cherokee Cherokee Sport, Comanche Wagoneer, Wrangler 1986/91	3960cc. 240 - 242/L 185HP Ø98.4	220900 🚗 pág. 118
	230407	88.0	1.20	B230400 🔧 HAS15038	Neón 1997/99 Neón, Cirrus, Stratus, Voyager 1996/01	1796cc. 122 CID/116HP Ø83 1996cc. ECB/420H 132HP Ø87.5 (SOHC) 16V	230400-R 🚗 pág. 119
	230807	89.0	1.40	B230800 🔧 HAS15038	Neón, Sebring, Avenger 1995/... Stratus, Cirrus, Plymouth Breeze Caravan, Grand Caravan, Voyager Grand Voyager 1995/00	1996cc. 4A20 130/140HP Ø87.5 (DOHC) 16V 2429cc. EDZ 150HP Ø87.5 (DOHC) 16V	230800-R 🚗 pág. 120 521400-R 🚗 pág. 138
	253007 - SM 253007-1M 253007-2M 253008-SM 253008-1M 253008-2M	84.0 84.0 84.0 84.0 84.0 84.0	1.20 1.30 1.40 0.95 1.05 1.15	B253000 🔧 HAR12063	Renegade 2015/... DIESEL	1956cc. Multijet TD 170HP Ø83 (DOHC) 16V	253001-R 🚗 pág. 183
	272708	82.5	0.60	B272000 🔧 HAS15038	Renegade	1598cc. E.torq Evo 110HP Ø80.5	273700-R MLS 🚗 pág. 228

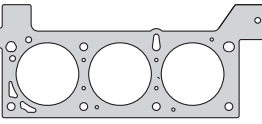
# CHRYSLER / DODGE / JEEP

## JUNTA TAPA DE CILINDROS / HEAD GASKETS

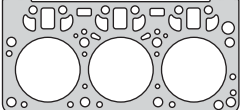



### MOTORES NAFTA Y DIESEL / PETROL AND DIESEL ENGINES

	Código Code	Q	≠	Kit Bulón Bolt Set	Aplicación Application	Motor Engine	Juego
<b>352407 - 352408</b> 	352407-1M 352407-2M 352408 352408-2M	90.0 90.0 90.0 90.0	1.20 1.40 1.20 1.40	B352400  HAE18038	Grand Cherokee TD 2002/... <b>DIESEL</b>	2685cc. ENF 163HP Ø88 (DOHC) 20V	352401-R  pág. 357
<b>352808</b> 	352808	92.0	0.65	B352800  HAT55055 HAT55100	Crossfire 2004/...	3199cc. EGX/EGZ 218HP Ø89,9 (SOHC) V6 18V	
<b>400005 - 400007 - 400008</b> 	400005 400007 400008	92.5 92.5 92.5	1.40 1.40 1.15	B400000  HAS19038	D100/D200 1987/... <b>DIESEL</b>	3336cc. 4.203-P4-192Z 71HP Ø91.49	400000-R  pág. 373
<b>460307</b> 	460307-1M 460307-2M 460307-3M 460307-4M	84.0 84.0 84.0 84.0	1.50 1.60 1.70 1.80	B460300  HAT55055 HAT55100	JPX <b>DIESEL</b>	1995cc. XUD9 65/69HP Ø83 (SOHC) 8V	460301-R  pág. 418
<b>500507</b> 	500507-SM 500507-2M 500507-1M	98.0 98.0 98.0	1.55 1.60 1.80		Voyager TD, Grand Voyager TD 1992/94 <b>DIESEL</b>	2499cc. HR425CL1(M00) 118HP Ø92	500401  pág. 521
<b>510007</b> 	510007	96.0	1.90	B510000  HAS15038	Caravan, Grand Caravan, Imperial Voyager, Grand Voyager, New Yorker Town & Country 1990/99	3301cc. 201 (R00) 152/162HP Ø93 (OHV) V6 12V	510000-R  pág. 121
<b>510107</b> 	510107	98.0	1.90	B510000  HAS15038	Caravan, Grand Caravan, Voyager Grand Voyager, New Yorker, Imperial Town & Country 1991/99	3778cc. 231 (L00) 162/166HP Ø96 (OHV) V6 12V	510100-R  pág. 122
<b>510407</b> 	510407	103.5	1.80		Dakota, Pick Up, Jeep Cherokee Comanche, Wrangler, Renegade 1991/96	2464cc. D150 121HP Ø98.4	510400-R  pág. 124
<b>510507</b> 	510507	102.5	1.40		Dakota Pick Up 1996/...	3908cc. EHC 174HP Ø99.3 (OHV) V6 12V	510500-R 510500  pág. 125

# CHRYSLER / DODGE / JEEP

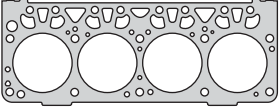
## JUNTA TAPA DE CILINDROS / HEAD GASKETS

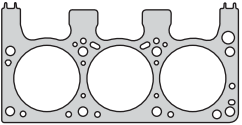
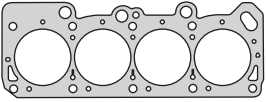
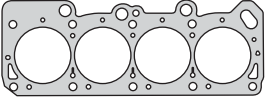
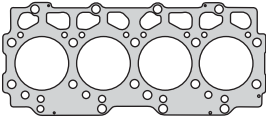
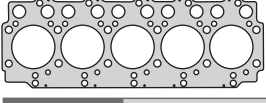
### MOTORES NAFTA Y DIESEL / PETROL AND DIESEL ENGINES

	Código Code	Q	≠	Kit Bulón Bolt Set	Aplicación Application	Motor Engine	Juego
	510707	104.0	1.20		Grand Cherokee 1993/...	<b>5210cc.</b> 318 215/223HP Ø99.3 (OHV) V8 16V	<b>510700-R</b> 🚗 pág. 126
	510807	99.0	1.20		Grand Wagoneer 1984/88 Pick Up 1981/88, Scrambler 1981/86 Jeep CJ/DJ 1981/86	<b>4200cc.</b> 258 AMC Jeep 170HP Ø95.25	<b>510800-R</b> 🚗 pág. 127
	510907	99.0	1.20		Wrangler, Jeep YJ 1986/90	<b>4200cc.</b> 258 AMC Jeep 170HP Ø95.25	<b>510900-R</b> 🚗 pág. 128
	520107	103.0	1.30		Pick Up V6 1987/91	<b>3910cc.</b> 239 CID V6 130HP Ø99.31	<b>520100-R</b> 🚗 pág. 129
	520205 520207	89.0 89.0	1.80 1.90		135 (EDR) Lebaron, Spirit, Shadow, Voyager, Caravan, Daytona 1982/98 EDM Caravan, Grand Caravan, Grand Voyager, Saratoga 1986/95 EDT Voyager, Caravan, Lebaron, Daytona 1989/92	<b>2213cc.</b> 135 (EDR) 177HP Ø87.5 <b>2501cc.</b> EDM (K00) 99/101HP EDT 150HP Ø87.5 (SOHC) 8V	<b>520200-R</b> 🚗 pág. 130
	520205 520207	89.0 89.0	1.80 1.90		Lebaron, Daytona Turbo 1989/...  Voyager, Caravan, Saratoga, Lebaron Daytona Turbo 1989/...	<b>2213cc.</b> 135 (EDR) 177HP Ø87.5 <b>2501cc.</b> 153 (EDT) 150HP Ø87.5 (SOHC) 8V	<b>521200-R</b> 🚗 pág. 137
	520307-SM 520307-1M 520307-2M 520308-SM 520308-1M 520308-2M	98.0 98.0 98.0 98.0 98.0 98.0	1.40 1.50 1.60 1.42 1.52 1.62	<b>B520300</b> 🔧 HAN12055 HAN12100	Dakota TD, Grand Voyager TD 1995/... Cherokee, Grand Cherokee TD 1997/...  <b>DIESEL</b>	<b>2499cc.</b> VM425TD 114/115HP Ø92	<b>520301-R</b> 🚗 pág. 522
	520407-SM 520407-1M 520407-2M 520408-SM 520408-1M 520408-2M	98.0 98.0 98.0 98.0 98.0 98.0	1.40 1.50 1.60 1.42 1.52 1.62	<b>B520400</b> 🔧 HAN12055 HAN12100	Jeep Cherokee, Grand Cherokee Dakota, Caravan 2001/...  <b>DIESEL</b>	<b>3100cc.</b> VM531TD 142HP Ø92	<b>520401-R</b> 🚗 pág. 523
	520505	104.0	1.20		Barracuda, Super Bee 1970/74  Charger, Dart GTS, Le Baron, Cordoba Monaco, Super Bee, Camiónes Ligeros D350/D600 1979/92	<b>5210cc.</b> 318 LA V8 202HP Ø99,3  <b>5899cc.</b> (OHV) V8 16V 360 Con Carburador y T.B.I	<b>510200-R</b> 🚗 pág. 123  <b>520500</b> 🚗 pág. 131

# CHRYSLER / DODGE / JEEP

## JUNTA TAPA DE CILINDROS / HEAD GASKETS

### MOTORES NAFTA Y DIESEL / PETROL AND DIESEL ENGINES

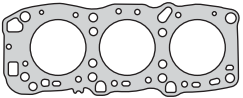
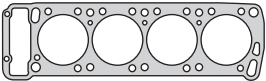
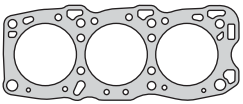
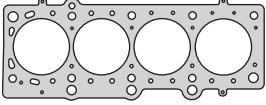
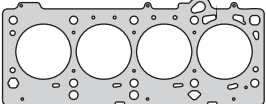
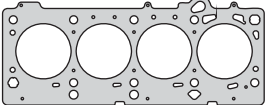
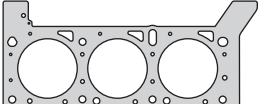
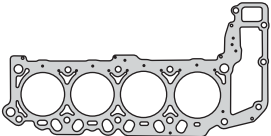
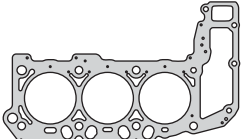
	Código Code	Q	≠	Kit Bulón Bolt Set	Aplicación Application	Motor Engine	Juego
	520607	87.0	1.40		Stratus, Avenger, Sebring, Cirrus 1995/99	2497cc. 150 (H00) 167HP Ø83.5 (SOHC) V6 24V	520600-R 🚗 pág. 132
	520805	94.0	1.20		Pick Up, Lebaron, Caravan 1981/89	2555cc. G54B 103HP Ø91.1 (SOHC) 12V	520800-R 🚗 pág. 133
	520905 520907	95.0 95.0	1.50 1.60		Pick Up, Caravan 1987/96 Spirit, Daytona 1990/93	2972cc. 6G72-181CID 143HP Ø92 (SOHC) V6 12V	520900-R 🚗 pág. 134
	521008	89.5	1.00		Neon 2000/05	1996cc. ECB 135HP Ø87,5 (SOHC) 16V	521000-R 🚗 pág. 135
	521107 521108	88.0 88.0	1.20 0.70		PT Crusier 2002/05	1996cc. ECC (DOHC) 16V 150HP Ø87.5	521100-R MLS 🚗 pág. 136
	521107 521108	88.0 88.0	1.20 0.70	B522100	Stratus 2002/6 PT Cruiser 2002/05	2429cc. EDZ (DOHC) 16V 150HP Ø87.5 2429cc. EDZ 150HP Ø87.5	521500-R 🚗 pág. 139 522100-R 🚗 pág. 145
	521608	97.2	0.75	B510000 🔧 HAS15038	Voyager 2002/06 - Pacifica 2004/07	3778cc. EGH 162HP Ø96 (OHV) V6 16V	521600-R 🚗 pág. 140
	521708	93.7	0.75		Dakota, Ram 1500 2000/11 Grand Cherokee, Durango 1999/09 Aspen, Commander 2006/09	4698cc. V8 Magnum 235HP Ø93	521700-R MLS 🚗 pág. 141
	521808	93.75	0.70		Dakota, Ram 1500, Durango 2000/09 Jeep Liberty, Grand Cherokee 2002/09	3701cc. EKG 210HP Ø93 (SOHC) V6 12V	521800-R MLS 🚗 pág. 142

# CHRYSLER / DODGE / JEEP

## JUNTA TAPA DE CILINDROS / HEAD GASKETS

### MOTORES NAFTA Y DIESEL / PETROL AND DIESEL ENGINES

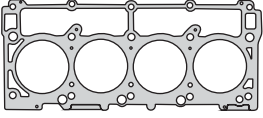
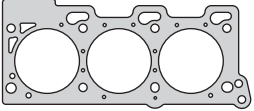
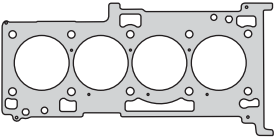
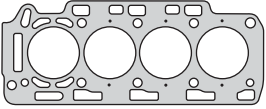
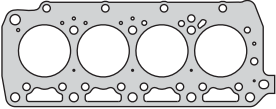
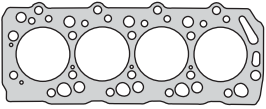
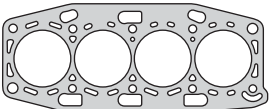
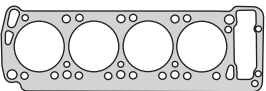
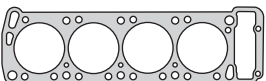
	Código Code	Q	≠	Kit Bulón Bolt Set	Aplicación Application	Motor Engine	Juego
	521908	100	0.75		Ram 2500, Ram 3500, Ram Quad, Charger, Jeep Comander, Sonora, 300C, Grand Cherokee, Aspen	5645cc. EZB - Hemi 345HP Ø99,5 (OHV) V8 16V	521900-R 🚗 pág. 143
	522007	100.0	1.40		Concorde, New Yorker LHS	3518cc. EGE 214HP Ø96 (DOHC) V6 24V	522000-R 🚗 pág. 144
	523008	89.0	0.60	B523000	Jeep, Avenger, Patriot, Caliber, Compass Sebring, Stratus 2007/... Journey, Compass 2009/...	2360cc. ED3 - GEMA 170/174HP Ø88 (DOHC) 16V	523000-R MLS 🚗 pág. 146
	550605 550606 550607	89.0 89.0 89.0	1.40 2.40 1.20	B550600 B550600-1 🚗 HAS19038	Wrangler 1983/86	1995cc. J5R Ø88	550600-R 🚗 pág. 470
	560007-1M 560007-2M 560007-3M	87.0 87.0 87.0	1.70 1.60 1.80	B560000 🚗 HAH10055 HAS19038 HAE18038	Jeep Wagoneer TD 1984/95 Comanche TD 1986/88 DIESEL	2068cc. 852/J8S 65/86HP Ø86	560001-R 🚗 pág. 474
	910507	92.0	1.70	B910500 🚗 HAH10055 HAH10140	Pick Up Power Ram 50 TD 1983/85 DIESEL	2346cc. 4D55T 8V 67HP Ø91	910500-R 🚗 pág. 167
	961507	82.5	1.70	B961500 🚗 HAD10038	Vista - Colt 1992/94	1834cc. 4G93 120HP Ø81 (SOHC) 16V	961500-R 🚗 pág. 181
	964807	93.0	1.70		Pick Up D50, Colt 1978/80	2555cc. 4G54B Ø91.1 (SOHC) 8V	964800-R 🚗 pág. 212
	964907	93.0	1.70		Pick Up 1982/...	2555cc. 4G54B Ø91.1 (SOHC) 8V	964900-R 🚗 pág. 213

# CHRYSLER



Motor/Engine	Cm³	HP	Ø
170	2788	130	86.36
225	3687	130	86.36

Dodge: Valiant I/II/III/IV D100, D2800, Polara Coronado, RT 1964/79



Nº OE	Descripción/Description	Mat.	Ref.
2488777	Jgo. de juntas para motor		220000-R
	Jgo. de juntas superior		220095
1947578	Junta tapa cilindros Ø 89.0 ± 1.40	NFT 1 1	220005
2406625	Junta tapa válvulas superior	CG 1 1	220010
2240697	Jgo. junta para cárter (4)	CG 1 1	220011
1947553	Tapa distribución	NB 1 1	220012
1947523	Tapa bomba de agua	NB 1 1	220014
2084416	Múltiple admisión y escape	NFT 1 1	220016
2206120	Entre múltiples	NFT 1 1	220017
2073972	Salida de escape	FCH 1 1	220018
1947521	Bomba agua a block	NB 1 1	220019
	Jgo. juntas carburador HOLLEY	VS	220020
	Jgo. juntas carburador HOLLEY	VS	220021
2205582	Base carburador	NB 1 1	220025
	Tapa carburador HOLLEY RX 7001/7005	CG	220026
2121404	Bomba aceite a block	NB 1 1	220027
1400185	Base bomba nafta	NB 1 1	220028
1947708	Arandelas bujias	GS 6 6	220029
1947671	Termostato	CB 1 1	220032
	Tapa diferencial DANA 44	CG	540034
	Jgo. juntas caja velocidades VAL. I - II	VS	220050
	Jgo. juntas caja velocidades III - IV	VS	220051
	Jgo. juntas caja velocidades CORONADO	VS	220052
	Jgo. juntas caja velocidades 3 V	VS	220053
2084411	Jgo. juntas empaquetadura bancada (2)	SNA 1 1	220058
2240697	Tapa diferencial DANA 44	CGT	540068
	Jta. tapa cilindros competición (0.80)	NFT	220090-0.80
	Jta. tapa cilindros competición (1.00)	NFT	220090-1.00
	Jta. tapa cilindros competición (1.20)	NFT	220090-1.20
	Jta. tapa cilindros competición (0.80)	NFT	220091-0.80
	Jta. tapa cilindros competición (1.00)	NFT	220091-1.00
	Jta. tapa cilindros competición (1.20)	NFT	220091-1.20
	Arandela tapón cárter A 13 x 20 x 2 A	AL	
	Kit de retenes completo		R220000
	Jgo. retén válvulas (12)	P 1 1	R300010P
	Retén distribución 53.97 x 80.96 x 14.68	N 1 1	R220012N
	Retén árbol de levas 57.15 x 80.98 x 11.5	P 1 1	R220013P

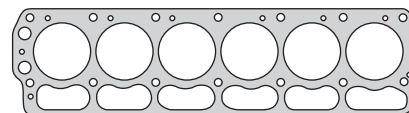

220005

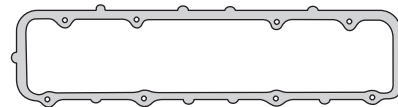

220010

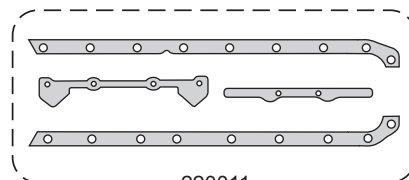

220011



220016

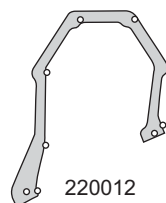

220012



220014

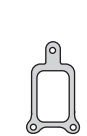

220017



220018



220019



220025



220027



220028



220032



220029



A 13 x 20 x 2 A



220058



R220012N



R220013P



R300010P



# CHRYSLER



Motor/Engine	Cm³	HP	Ø
Hillman	1498	72	86
Hillman	1798	110	86

**Dodge:** D1500, D1800, Paikan, GT90  
GT100 1971/...

**Volkswagen:** 1500, 1800 1982/...



Nº OE	Descripción/Description	Mat.	Ref.
	Jgo. de juntas para motor		220100-R
	Jgo. de juntas superior		220195
71241047	Junta tapa cilindros Ø 88.0 ± 1.40	NFT 1 1	220105
	Junta tapa cilindros Ø 88.0 ± 2.40	NFT	220106
	Jgo. tornillos tapa cilin. (HAT55055/55100)		B220100
71244439	Junta tapa válvulas	CG 1 1	220110
71244432	Junta para cárter	CG 1	220111
71300122	Tapa distribución	NB 1	220112
71241043	Tapa bomba de agua	NB 1	220114
71241094	Múltiple admisión y escape	CHA	220115
71241094	Múltiple admisión y escape	NFT 1 1	220116
	Entre múltiple	NFT 1 1	220117
71248090	Salida de escape	FCH 1 1	220118
2068331	Termostato	CB 1 1	220119
71305081	Jgo. juntas carburador STROMBERG	VS	220120
85G7007N	Jgo. juntas carburador HOLLEY RX 7034 A	VS	220121
85G7008N	Jgo. juntas carburador HOLLEY RX 7035 A	VS	220122
71235148	Base carburador	NB 2	220125
	Bomba aceite	NB 1	220127
71240978	Bomba nafta	NB 2	220128
	Bastón cierre bancada	N 2	220131
71301430	Base carburador HOLLEY 1,5	NB 2 2	220132
	Base carburador HOLLEY 1,8	NH	220133
7080341	Tapa carburador STROMBERG	CB	220134
75061327	Cebador carburador STROMBERG	CB	220135
	Base filtro aire	CB	220136
71035003	Jgo. juntas caja velocidades	CB	220150
75064744	Jgo. juntas caja velocidades AUTOMATICO	VS	220151
	Tapa diferencial TRANSAX - DANA 30	CG	450355
	Palier brasilero	CB	220156
	Diferencial brasilero	CB	220159
71244432	Junta para cárter	CGT	220160
71244439	Junta tapa válvulas	CGT	220161
	Palier nacional	CB	220162
	Tapa diferencial TRANSAX - DANA 30	CGT	450362
	Jta. tapa cilindros competición (0.80)	NFT	220290-0.80
	Jta. tapa cilindros competición (1.00)	NFT	220290-1.00
	Jta. tapa cilindros competición (1.20)	NFT	220290-1.25
	Arandela tapón cárter A 13 x 20 x 2 A	AL	
	Kit de retenes completo		R220100
	Jgo. retén válvulas (8) 1.5	P 1	R220110P
	Jgo. retén válvulas (8) 1.8	P	R220210P
	Retén bancada 76.2 x 95.22 x 9.32	N 1	R220111N
	Retén distribución 44.45 x 63.5 x 9.52	P 1	R220112P

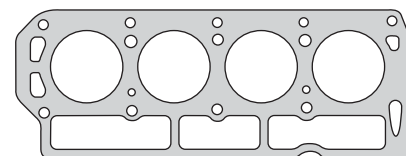

220105

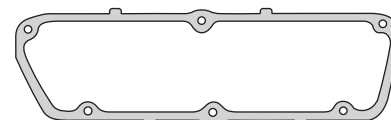

220110

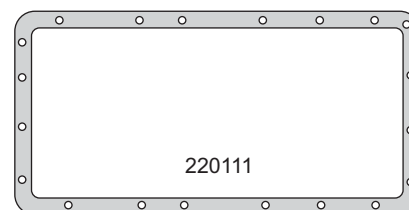

220111

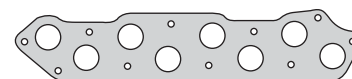

220116

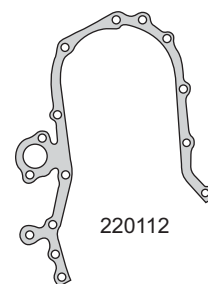

220112



220114



220117



220118



220119



220127



220125



220131



220128

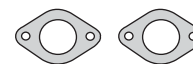

220132

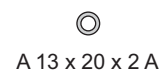

A 13 x 20 x 2 A



R220111N



R220112P



R220110P



R220210P

**CHRYSLER**



Motor/Engine Cm³ HP Ø

318 V8 5210 202 99.31

Dodge: GTX, Coupe 1970/...



Nº OE	Descripción/Description	Mat.	Ref.
	<b>Jgo. de juntas para motor</b>		<b>220500</b>
2463338	Jgo. junta tapa cilindros Ø 102.0 ± 1.40 (2)	NFT	1 220505
3658869	Conjunto tapa válvulas superior	CG	2 220510
3518879	Jgo. junta para cárter (4)	CG	1 220511
2129012	Tapa distribución	NB	1 220512
2129013	Cuerpo bomba de agua	NB	1 220514
	Jgo. múltiple escape (6)	NFT	1 220515
2536514	Jgo. múltiple admisión (2)	NFT	1 220517
50082	Codo salida agua	NB	1 220519
2468818	Base carburador	NB	2 220525
1400185	Base bomba nafta	NB	1 220528
2268513	Tapón cárter A 14 x 20 x 1.5 A	AL	1 220529
2806095	Delantera múltiple admisión	CG	1 220530
2806096	Trasera múltiple admisión	CG	1 220531
	Jgo. juntas empaquetadura bancada (2)	SNA	1 220558
	Retén distribución 52.50 x 80.96 x 19.05	N	R220512N

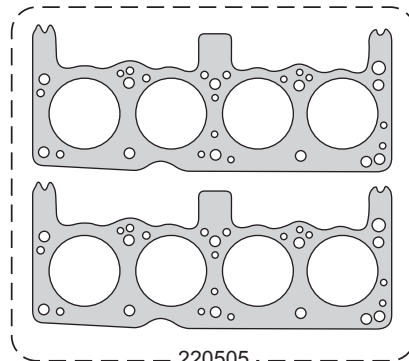

220505

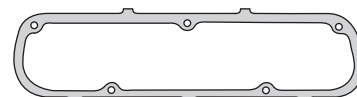

220510

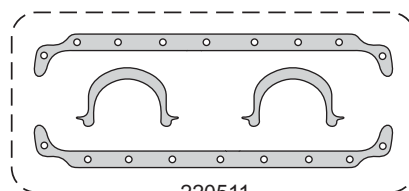

220511

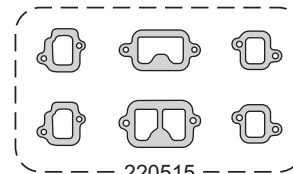

220515

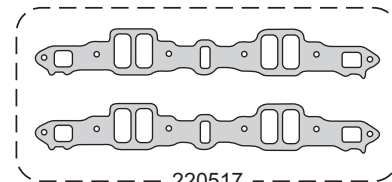

220517

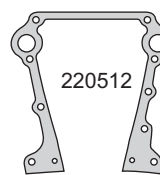

220519

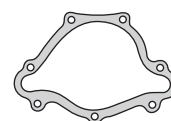

220525



220528

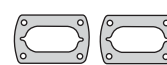

220529



220530



A 14 x 20 x 1.5 A



220531



R220512N



220558



R220512N

# CHRYSLER



Motor/Engine	Cm³	HP	Ø
241	3956	95	85.73
251	4106	100	87.31

Dodge: Continental 3 3/8 - 3 7/16  
D100/200/400/500 1951/64



Nº OE	Descripción/Description	Mat.	Ref.
	<b>Jgo. de juntas para motor</b>		<b>220700</b>
	<b>Junta tapa cilindros Ø 88.0 ±1.40</b>	NFT	<b>1 220705</b>
665690	Junta tapa válvulas	CG	2 220710
7800478	Jgo. junta para cárter (4)	CG	1 220711
600752	Tapa distribución	CB	1 220712
600749	Placa distribución	CB	1 220713
637439	Bomba de agua hasta 1948	NB	1 220714
780462	Jgo. múltiple admisión y escape (5)	NFT	1 220716
666352	Entre múltiple	NFT	1 220717
679023	Salida de escape D-100	FCH	220018
683051	Salida de escape D-400	FCH	220718
637440	Bomba de agua a block	NB	1 220719
	Base carburador	NB	540025
	Cuba carburador	FCH	220726
	Bomba aceite	FCH	220727
634704	Bomba nafta	FCH	220728
50082	Termostato	FCH	220729
	Bomba agua 49/	NB	1 220730
	Intermedia carburador	FCH	220734
695442	Base filtro aceite	FCH	220735
	Arandela tapón cárter A 13 x 20 x 2 A	AL	
1088603	Retén distribución 55.56 x 81 x 17.46	N	R220712N

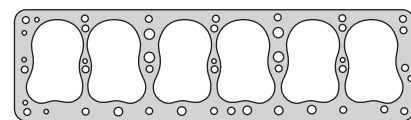

220705



220710

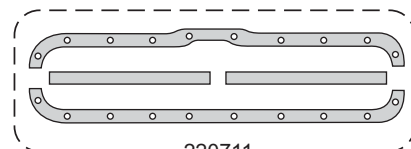

220711

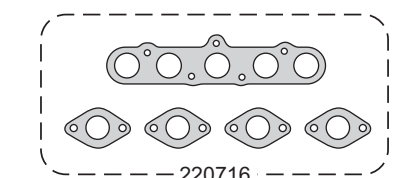

220716

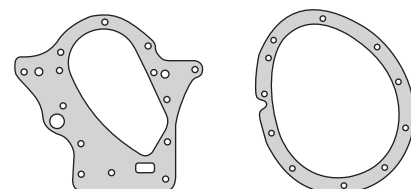

220713

220712

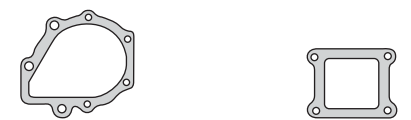

220714

220717

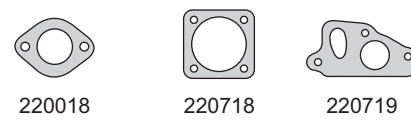

220018

220718

220719

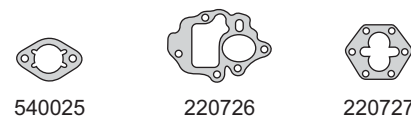

540025

220726

220727



220728

220729

220730

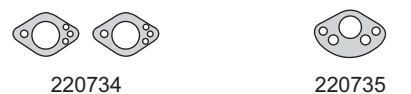

220734

220735

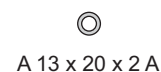

A 13 x 20 x 2 A



R220712N

# CHRYSLER



Motor/Engine	Cm³	HP	Ø
240 - 242/L	3960	185	98.4

**Jeep:** Grand Cherokee Laredo, Cherokee Cherokee Sport, Comanche, Wagoneer Wrangler 1986/91



Nº OE	Descripción/Description	Mat.	Ref.
	<b>Jgo. de juntas para motor</b>	●	<b>220900</b>
	<b>Junta tapa cilindros Ø 102.0 ± 1.20</b>	NFT	<b>1 220907</b>
	<b>Jgo. de tronillos para tapa de cilindros</b>		<b>B220900</b>
	Junta tapa de válvulas	CG	1 220910
	Junta para cárter moldeado 1991/95	GS	1 220911
	Jgo. junta para cárter 1987/90 (2)	CG	1 220911-1
	Tapa distribución	CB	1 220912
	Bomba de agua	CB	1 220914
	Múltiple admisión y escape 1987/90	NFT	1 220916
	Múltiple admisión y escape 1991/95	NFT	1 220916-1
52005431	Salida de escape	AC	220918
	Salida de agua	CB	1 220919
	Cuerpo válvula cierre	CB	1 220926
	Base bomba de aceite	CB	1 220927
	E.G.R.	NFT	1 220929
	Arandela tapón cárter A 14 x 24 x 1.5 A	AL	1 220930
	O'ring filtro aceite chico G 17.17 x 1.78	GS	1 220931
	O'ring filtro aceite mediano G 20.30 x 2.62	GS	1 220932
	O'ring filtro aceite grande G 63.09 x 3.53	GS	1 220933
	O'ring inyección G 21.82 x 3.53	GS	1 220934
6503155	Arandela tapa válvulas A 10 x 22 x 2 A	AC/GS	15 220935
	Cuerpo válvula cierre	CB	1 220937
	Base distribuidor	CB	1 220938
	O'ring enfriador aceite G 32.99 x 2.62	GS	1 220939
	Jta. tapa cilindros competición (0.80)	NFT	220990-0.80
	Jta. tapa cilindros competición (1.00)	NFT	220990-1.00
	Jta. tapa cilindros competición (1.20)	NFT	220990-1.20
	Jta. tapa cilindros competición (0.80)	NFT	220991-0.80
	Jta. tapa cilindros competición (1.00)	NFT	220991-1.00
	Jta. tapa cilindros competición (1.20)	NFT	220991-1.20
	Kit de retenes completo		R220900
53009886/7	Jgo. retén válvulas (12)	P	R210910P
4778126AB	Retén bancada (2 mitades)	P	R510811P
33004681	Retén distribución 45 x 57.15 x 9.5	P	R510812P

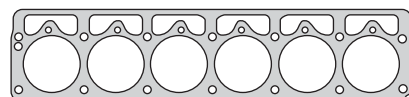

220907



220910

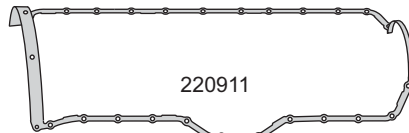

220911

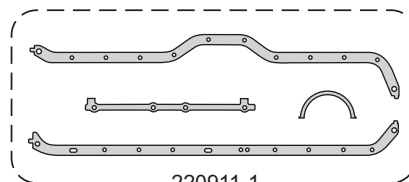

220911-1



220916

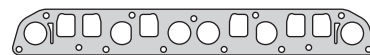

220916-1

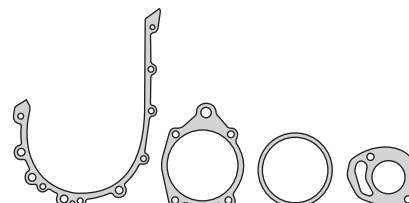

220912 220914 220918 220919

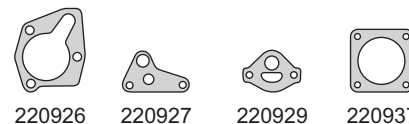

220926 220927 220929 220937



G 32.99 x 2.62 220938 G 21.82 x 3.53



G 63.09 x 3.53 G 17.17 x 1.78 G 20.30 x 2.62



A 14 x 24 x 1.5 A

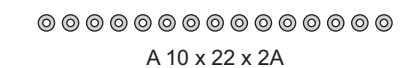

A 10 x 22 x 2A

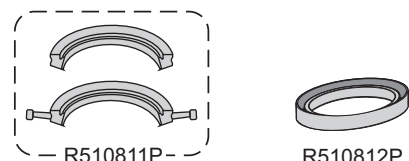

R510811P R510812P

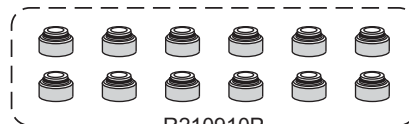

R210910P

# CHRYSLER



Motor/Engine	Cm³	HP	Ø
122 CID ECB/420H (SOHC) 16V	1796 1996	116 132	83 87.5

Chrysler: Neón, Cirrus, Stratus, Voyager  
1996/01, Neon 1997/99



Nº OE	Descripción/Description	Mat.	Ref.
	Jgo. de juntas para motor		● 230400-R
0477-7072AB	Junta tapa cilindros Ø 88.0 ± 1.20	NFT	1 230407
	Jgo. tornillos tapa cilindros (HAS15038)		B230400
0466-7985	Conj. junta tapa válvulas (5)	GS	1 230410
0455-6666	Junta para cárter (goma/metal)	GS	1 230411
0466-7663	Bomba de agua	GS	1 230414
0466-7492	Múltiple escape	NFT	1 230416
0477-7895AA	Toberas múltiple admisión (4)	GS	1 230417
	Salida de escape	AC/GS	1 230418
	Junta	NB	1 230430
	Guarnición goma	GS	1 230431
0477-7042	Jgo. junta capuchón bujías (4)	GS	1 230437
	Brida	NFT	1 230439
	Brida	NFT	1 230440
	Jgo. múltiple admisión gases (3)	NFT	1 230441
	Guarnición goma G 24 x 32 x 4.5	GS	1 230442
	Guarnición goma G 50.8 x 53.8 x 3.5	GS	230445
	Guarnición goma metal G 24 x 46.5 x 10	GS	230448
	O´ring G 48.9 x 2.62	GS	1
	O´ring G 36.09 x 3.53	GS	1
	O´ring G 37.77 x 2.62	GS	1
	O´ring G 15.47 x 3.53	GS	2
	O´ring G 7.52 x 3.53	GS	4
	O´ring G 20.3 x 2.62	GS	1
	O´ring G 26.64 x 2.62	GS	1
	Arandela tapón cárter A 19.5 x 27 x 1 A	AL	1
	Kit de retenes completo		R230400
0464-8619	Jgo. retén válvulas (16)	P	1 R230410P
0466-7904	Retén bancada 91 x 111 x 10	V	1 R330511V
0466-7198	Retén distribución 32 x 45 x 6.5	P	1 R230412P
0477-7086	Retén árbol de levas 35 x 48 x 7	P	1 R240013P

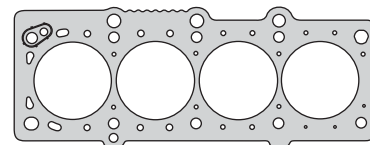

230407

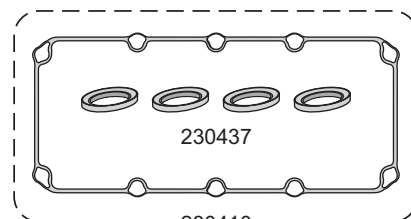

230437

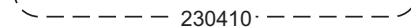

230410

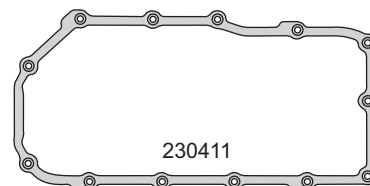

230411



230416



230417

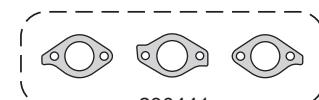

230441



230414



230418



230430



230439



230440



230442



230448



230445



A 19.5 x 27 x 1 A

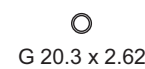

G 20.3 x 2.62



G 48.9 x 2.62



G 37.77 x 2.62



G 26.64 x 2.62



G 7.52 x 3.53

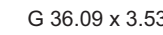

G 36.09 x 3.53

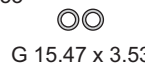

G 15.47 x 3.53



R330511V



R230412P



R240013P

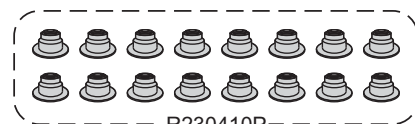

R230410P

# CHRYSLER



Motor/Engine	Cm³	HP	Ø
4A20 (DOHC) 16V	1996	130/140	87.5

Chrysler: Neón, Sebring, Avenger 1995/...



Nº OE	Descripción/Description	Mat.	1	1	Ref.
	Jgo. de juntas para motor			●	230800-R
	Jgo. de juntas superior		●		230895
0469-4324	Jta. tapa cilindros Ø 89.0 ±1.40 NR <sup>2</sup>	NFT	1	1	230807
	Jgo. tornillos tapa cilindros (HAS15038)				B230800
0466-7421	Junta tapa válvulas	GS	1	1	230810
0455-6666	Junta para cárter (goma/metal)	GS	1	1	230411
0466-7663	Bomba de agua	GS	1	1	230414
0466-7722	Múltiple escape	NFT	1	1	230816
0466-7539	Múltiple admisión	NB	1	1	230817
0466-7817	Tubo múltiple admisión	NB	1	1	230836
0527-7928	Brida	NFT	1	1	230439
0466-7232	Jgo. juntas capuchón bujías (4)	GS	1	1	230839
0466-3247	Brida	NFT	1	1	230440
0466-7420	Guarnición goma G 8.7 x 18.8 x 12.3	GS	8		230840
	Jgo. múltiple admisión gases (3)	NFT	1	1	230441
	Guarnición goma G 24 x 32 x 4.5	GS	1		230442
	Guarnición goma/metal G 24 x 46.5 x 10	GS			230448
	O´ring G 48.9 x 2.62	GS		1	
	O´ring G 36.09 x 3.53	GS		1	
	O´ring G 37.77 x 2.62	GS		1	
	O´ring G 15.47 x 3.53	GS		2	
	O´ring G 7.52 x 3.53	GS		4	
	O´ring G 26.64 x 2.62	GS		1	
	O´ring G 20.3 x 2.62	GS		1	
	Arandela tapón cárter A 19.5 x 27 x 1 A	AL	1		
	Kit de retenes completo				R230400
0464-8619	Jgo. retén válvulas (16)	P	1		R230410P
0466-7904	Retén bancada 91 x 111 x 10	V	1		R330511V
0466-7198	Retén distribución 32 x 45 x 6.5	P	1		R230412P
0477-7086	Retén árbol de levas 35 x 48 x 7	P	1		R240013P

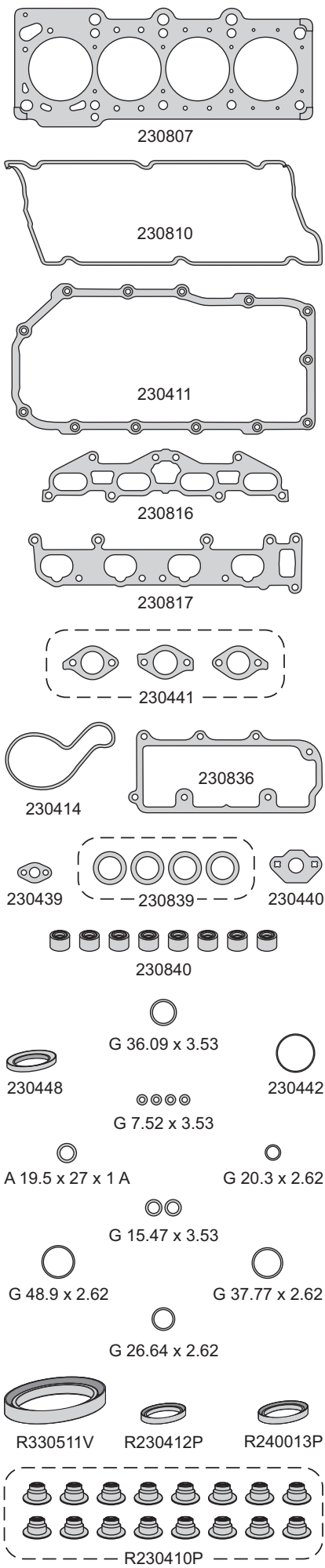

# CHRYSLER



Motor/Engine	Cm³	HP	Ø
201 (R00) (OHV) V6 12V	3301	152/162	93

**Chrysler:** Caravan, Grand Caravan, Imperial, Voyager, Grand Voyager, New Yorker Town & Country 1990/99



Nº OE	Descripción/Description	Mat.	Ref.
	Jgo. juntas para motor		510000-R
	Jgo. junta tapa cilin. Ø 96.0 ± 1.90 (2)	NFT	1 510007
	Jgo. tornillos tapa cilindros (HAS15038)		B510000
	Junta tapa de válvulas	GS	2 510010
	Junta para cárter	GS	1 510011
	Tapa distribución	CB	1 510012
	Jgo. múltiple escape (2)	NFT	1 510015
	Salida de escape	NFT	510018
	Base termostato	CB	1 510019
	Junta árbol de levas	CB	1 510020
	Junta	NFT	510120
	Junta	CB	510121
	Porta retén bancada trasera	CB	1 510122
	Bomba aceite	NB	510527
	E.G.R.	NFT	510030
	Retorno aceite	NFT	510031
	Guarnición G 35 x 42 x 4.5	GS	2 510040
	Arandela tapón cárter A 13 x 23 x 1.5 C	CU	1
	O´ring G 104.37 x 3.53	GS	1
	O´ring G 34.52 x 3.53	GS	
	O´ring G 21.82 x 3.53	GS	1
	O´ring G 24 x 30 x 3.9	GS	1
	O´ring G 7.52 x 3.53	GS	12
	O´ring G 20.30 x 2.62	GS	1
	Kit de retenes completo		R510000
	Jgo. reten válvulas (12)	P	1 R510010P
	Retén bancada 91 x 111 x 10	V	1 R330511V
	Retén distribución 28.5 x 41.25 x 6	P	1 R510012P

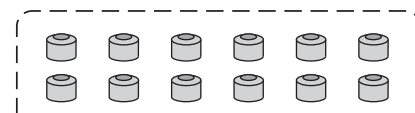
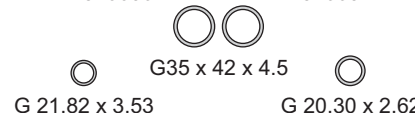
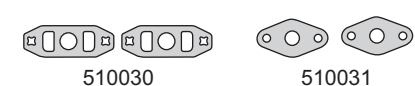
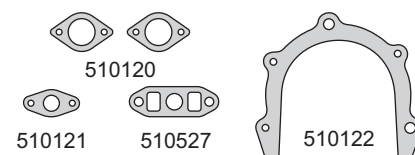
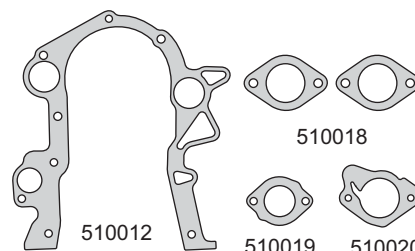
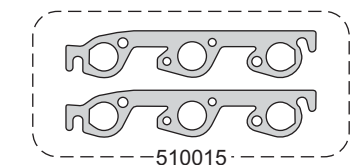
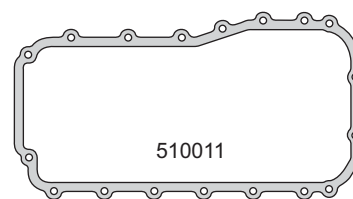
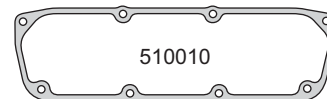
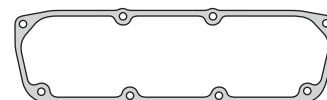
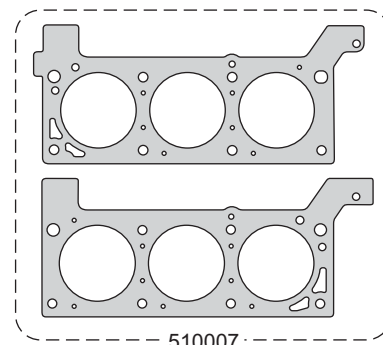

# CHRYSLER



Motor/Engine	Cm³	HP	Ø
231 (L00) (OHV) V6 12V	3778	162/166	96

**Chrysler:** Caravan, Grand Caravan, Voyager  
Grand Voyager, New yorker, Imperial  
Town & Country 1991/99



Nº OE	Descripción/Description	Mat.	Ref.
	<b>Jgo. de juntas para motor</b>		<b>510100-R</b>
	<b>Jgo. junta tapa cilin. Ø 98.0 ±1.90 (2) NR</b>	NFT	<b>1 510107</b>
	<b>Jgo. tornillos tapa cilindros (HAS15038)</b>		<b>B510000</b>
	Junta tapa de válvulas	GS	2 510010
	Junta para cárter	GS	1 510011
	Tapa distribución	CB	1 510012
	Jgo. múltiple escape (2)	NFT	1 510015
	Salida de escape	NFT	510018
	Base termostato	CB	1 510019
	Junta árbol de levas	CB	1 510020
	Junta	NFT	2 510120
	Junta	CB	1 510121
	Porta retén bancada trasera	CB	1 510122
	E.G.R	NFT	510030
	Retorno aceite	NFT	510031
	Guarnición G 35 x 42 x 4.5	GS	2 510040
	Arandela tapón cárter A 12.8 x 22.8 x 2	PLAST	
	Arandela A 13 x 23 x 1.5 C	CU	1
	O´ring G 104.37 x 3.53	GS	1
	O´ring G 20.30 x 2.62	GS	1
	O´ring G 21.82 x 3.53	GS	1
	Anillo G 24 x 30 x 3.9	GS	1
	O´ring G 7.52 x 3.53	GS	12
	Kit de retenes completo		R510000
	Jgo. reten válvulas (12)	P	1 R510010P
	Retén bancada 91 x 111 x 10	V	1 R330511V
	Retén distribución 28.5 x 41.25 x 6	P	1 R510012P

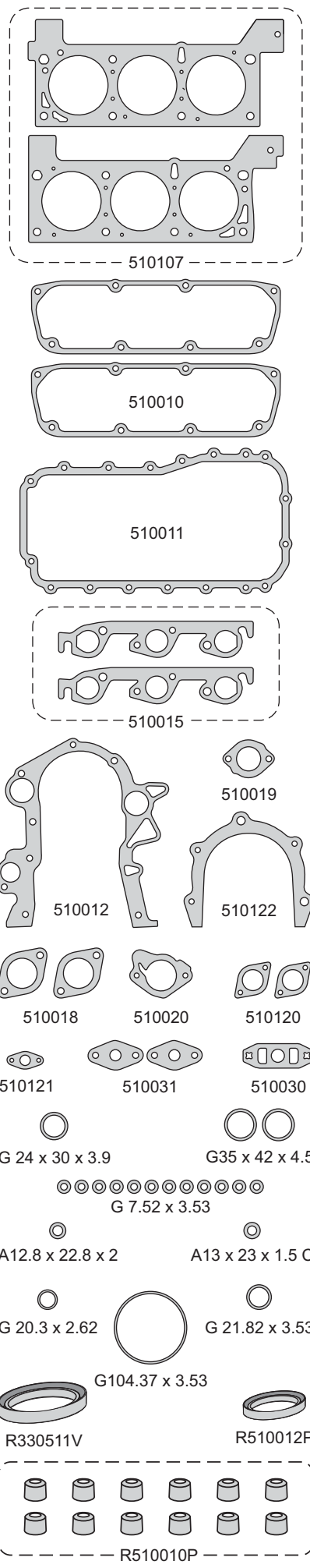



# CHRYSLER



Motor/Engine	Cm³	HP	Ø
318 LA V8	5210	202	99.3

Dodge: Barracuda, Super Bee 1970/74



Nº OE	Descripción/Description	Mat.	Ref.
	Jgo. de juntas para motor		510200-R
	Jgo. junta tapa cilindros Ø 104.0 ± 1.20 (2)	NFT	1 520505
3658869	Conjunto tapa válvulas superior	CG	2 220510
3518879	Jgo. junta para cárter (4)	CG	1 220511
2129012	Tapa distribución	NB	1 220512
2129013	Cuerpo bomba de agua	NB	1 220514
	Jgo. múltiple escape (6)	NFT	1 220515
2536514	Jgo. múltiple admisión (2)	NFT	1 220517
50082	Codo salida agua	NB	1 220519
	Junta	CB	1 520122
2468818	Base carburador	NB	2 220525
1400185	Base bomba nafta	NB	1 220528
2268513	Tapón cárter A 14 x 20 x 1.5 A	AL	1 220529
2806095	Delantera múltiple admisión	CG	1 220530
2806096	Trasera múltiple admisión	CG	1 220531
	Junta	AC	1 520532
	Jgo. juntas empaquetadura bancada (2)	SNA	1 220558
	Kit de retenes completo		R510200
	Jgo. retén válvulas (12)	P	1 R510210P
	Retén distribución 55 x 81 x 15.8	V	1 R510512V

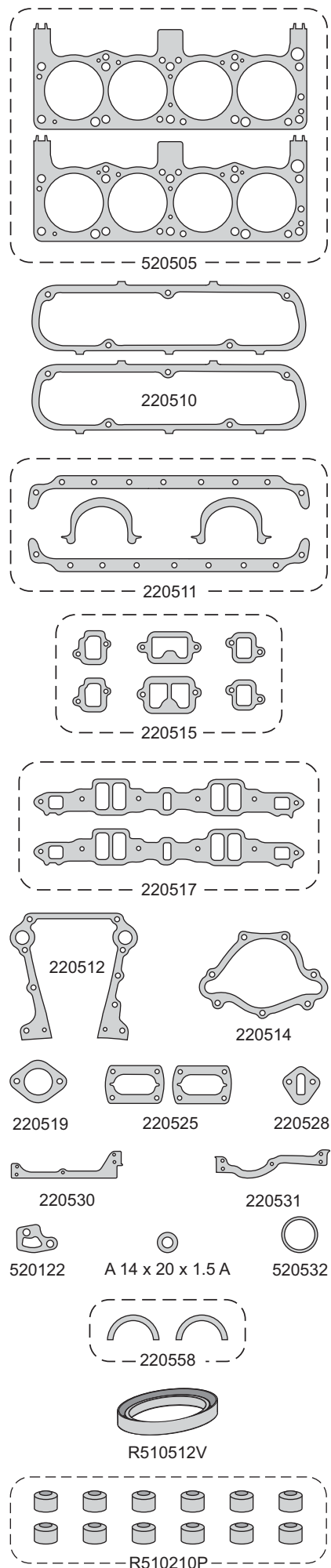

# CHRYSLER



Motor/Engine	Cm³	HP	Ø
D150	2464	121	98.4

**Chrysler:** Dakota, Pick Up, Jeep Cherokee Comanche, Wrangler, Renegade 1991/96



Nº OE	Descripción/Description	Mat.	Ref.
	<b>Jgo. de juntas para motor</b>	●	<b>510400-R</b>
	<b>Junta tapa cilindros Ø 103.5 x 1.80</b>	NFT	<b>1 510407</b>
	Junta tapa de válvulas	CG	1 510410
	Junta para cárter	GS	1 510411
	Tapa distribución	CB	1 220912
	Bomba de agua	NB	1 510414
	Bomba de agua	CB	1 220914
	Múltiple admisión y escape	NFT	1 510416
	Salida de agua	CB	1 220919
	Termostato	CB	1 510019
	Bomba aceite	CB	1 220927
	Bomba nafta	CB	1 200028
	Brida		510429
	Brida	NFT	1 510430
	Anular		510432
	Guarnición bomba de agua	GS	510435
	Junta	CB	1 200037
	O´ring G 47.22 x 3.53	GS	1
	O´ring G 7.52 x 3.53	GS	8
	Kit de retenes completo		R510400
	Jgo. retén válvulas (8)	P	1 R510410P
	Retén bancada 76.2 x 9.25 x 9.5	S	1 R510411S
	Retén distribución 44.45 x 57.15 x 9.5	S	1 R510412S

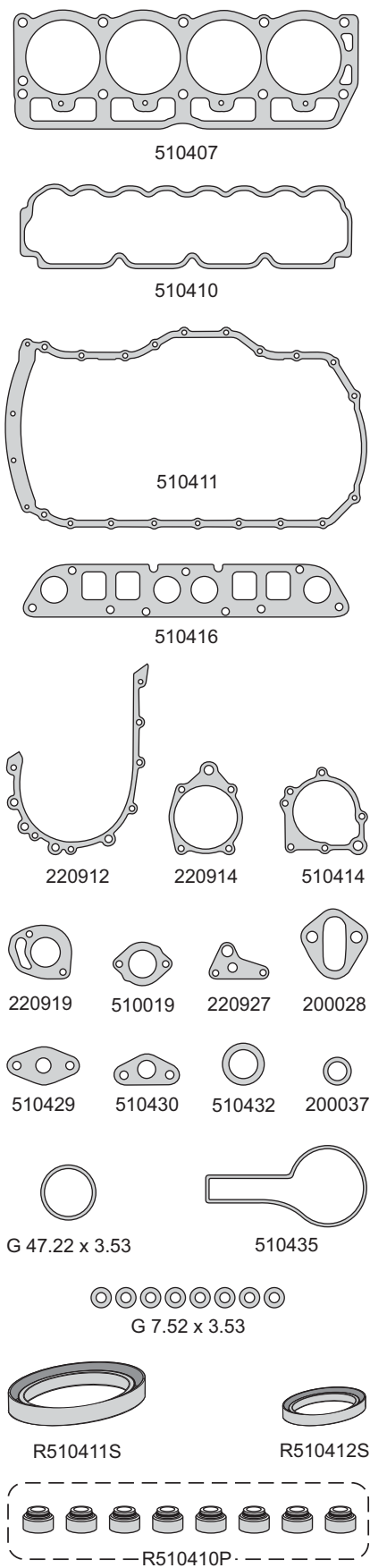

# CHRYSLER



Motor/Engine **Cm³** **HP** **Ø**

**EHC** **3908** **174** **99.3**

Chrysler: Dakota Pick Up 1996/...



Nº OE	Descripción/Description	Mat.	Ref.
	Jgo. de juntas para motor		● 510500-R
	Jgo. de juntas para motor		510500
	Jgo. de juntas superior	●	510595
	Jgo. tapa cilin. Ø102.5 ± 1.40 (2)	NFT 1 1	510507
	Junta tapa de válvulas	GS 2 2	510510
	Junta para cárter	GS 1	510511
	Tapa distribución	CB 1	510512
	Placa distribución	CB 1	510513
	Tapa bomba de agua	CB 1	510514
	Jgo. múltiple escape (2)	NFT 1 1	510515
	Jgo. múltiple admisión (4)	GFT 1 1	510517
	Tapa termostato	CB 1 1	510519
	Junta bomba aceite	NFT 1	510527
	Junta entrada de aire	CB 1 1	510529
	Unión admisión trasera	CG 1 1	510530
	Unión admisión delantera	CG 1 1	510531
	Tapa admisión	NFT 1 1	510532
	Base termostato	CB	510536
	Arandela porta retén A 104 x 118 x 1.6	CB 1	510533
	Arandela A 129 x 141	CB 1	510534
	Arandela A 30 x 46 x 3	GS 1	510535
	Brida	GFT 1	510546
	Unión cañería	CB 2	510545
	Brida conducto aire	CB 2	510544
	O´ring G 45.36 x 3.53	GS 12	12
	O´ring G 7.52 x 3.53	GS 12	12
	Arandela tapón cárter A 13 x 23 x 1.5 C	CU 1	1
	Kit de retenes completo		R510500
	Jgo. retén válvulas (12)	P 1	R510510P
	Jgo. retén bancada (dos mitades)	P 1	R510511P
	Retén distribución 55 x 81 x 15.8	V 1	R510512V

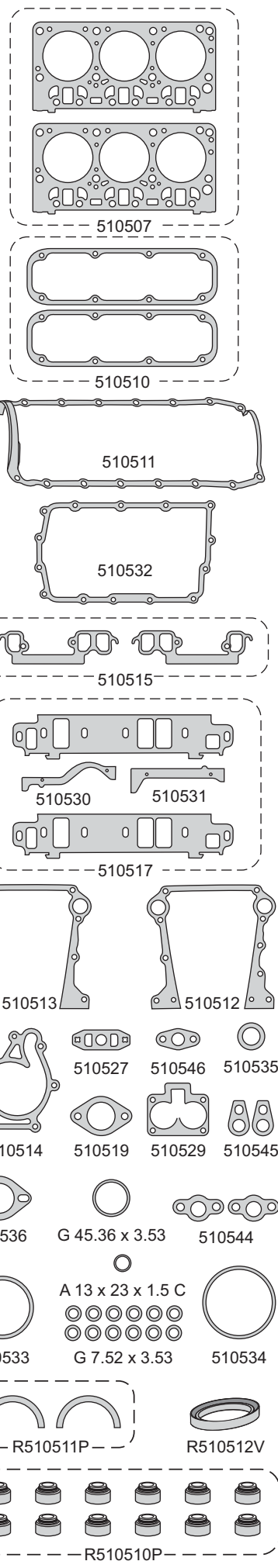

# CHRYSLER



Motor/Engine	Cm³	HP	Ø
318 (OHV) V8 16V	5210	215/223	99.3

Jeep: Grand Cherokee 1993/...



Nº OE	Descripción/Description	Mat.	Ref.
	Jgo. de juntas para motor	●	510700-R
	Jgo. de juntas superior	●	510795
	Jgo. tapa cilin. Ø104.0 ± 1.20 (2)	NFT 1 1	510707
	Jgo. junta tapa de válvulas (2)	CG 1 1	510710
	Junta para cárter	GS 1 1	510711
	Placa distribución	CB 1 1	510513
	Tapa bomba de agua	CB 1 1	510514
	Jgo. múltiple escape (2)	NFT 1 1	510715
	Jgo. múltiple admisión (2)	NFT 1 1	510717
	Tapa termostato	CB 1 1	510519
	E.G.R	NFT	510030
	Unión admisión trasera	CG 1 1	510530
	Unión admisión delantera	CG 1 1	510531
	Tapa admisión	NB 1 1	510732
	Arandela porta retén A 104 x 118 x 1.6	CB 1 1	510533
	Arandela A 129 x 141	CB 1 1	510534
	Brida conducto aceite	CB 3 1	510544
	Unión cañería	CB 2 1	510545
	Brida E.G.R	GFT 1 1	510546
	O'ring G 45.69 x 2.62	GS 1 1	
	O'ring G 15.60 x 1.78	GS 1 1	
	Arandela tapón cárter A 13 x 20 x 2 A	AL 1 1	
	Kit de retenes completo		R510700
	Jgo. retén válvulas (16)	P 1 1	R510710P
	Retén bancada (2 mitades)	S 1 1	R510711-1S
	Retén distribución 55 x 81 x 15.8	V 1 1	R510512V

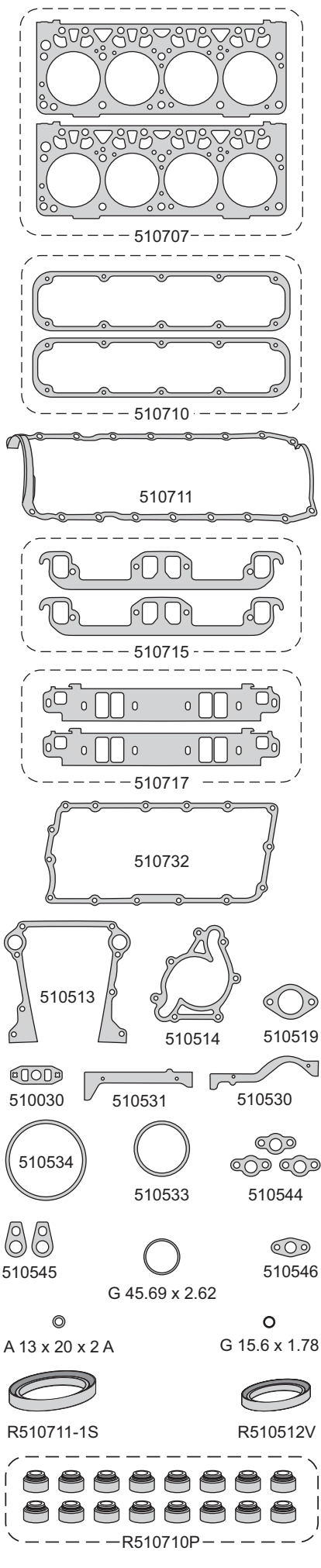

# CHRYSLER



Motor/Engine	Cm³	HP	Ø
258 AMC Jeep	4200	170	95.25

**Chrysler:** Grand Wagoneer 1984/88  
Pick Up 1981/88  
Scrambler, Jeep CJ/DJ 1981/86



510807



510810

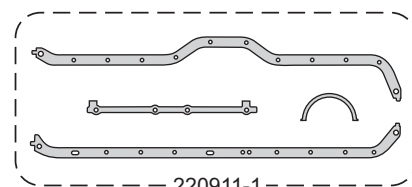

220911-1



510816

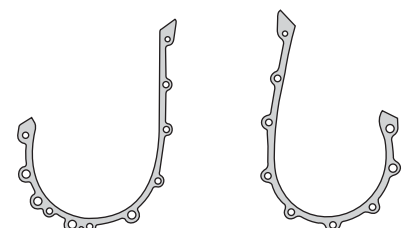

220912

510912



220914



220919



220927



510827



200028



510829



510830



510831



510832



G 66.5 x 80



220938



G 63.09 x 3.53



R510812P

Nº OE	Descripción/Description	Mat.	Ref.
	<b>Jgo. de juntas para motor</b>		<b>510800-R</b>
	<b>Junta tapa cilindros Ø 99.0 ± 1.20</b>	NFT	1 510807
	Junta tapa de válvulas	CG	1 510810
	Jgo. junta para cárter (4)	CG	1 220911-1
	Tapa distribución	NB	1 510912
	Tapa distribución	CB	1 220912
	Bomba de agua	CB	1 220914
	Múltiple admisión y escape	NFT	1 510816
	Salida agua	CB	1 220919
	Tapa bomba aceite	CB	1 510827
	Base bomba aceite	CB	1 220927
	Bomba nafta	CB	1 200028
	Cuerpo válvula cierre	GFT	1 510829
	Junta	CB	1 510830
	Junta anular 67 x 7.5 x 2.2	NB	510831
	Guarnición goma	GS	2 510832
	Cogotera	GS	1 510833
	Bancada	GS	1 510834
	Base distribuidor	CB	1 220938
	Arandela A 66.5 x 80	CB	1 510839
	O´ring G 63.09 x 3.53	GS	1
	Retén distribución 45 x 57 x 9.5	P	1 R510812P

# CHRYSLER



Motor/Engine	Cm³	HP	Ø
258 AMC Jeep	4200	170	95.25

Chrysler: Wrangler, Jeep YJ 1986/90



Nº OE	Descripción/Description	Mat.	Ref.
	<b>Jgo. de juntas para motor</b>		<b>510900-R</b>
	<b>Junta tapa cilindros Ø 99.0 ±1.20</b>	NFT	1 510907
	Junta tapa de válvulas	CG	1 510810
	Jgo. junta para cárter (4)	CG	1 220911-1
	Tapa distribución	NB	1 220912
	Tapa distribución 1986/...	CB	1 510912
	Tapa bomba de agua	CB	1 220914
	Múltiple admisión y escape	NFT	1 510816
	Salida agua	CB	1 220919
	Tapa bomba aceite	CB	1 510827
	Base bomba aceite	CB	1 220927
	Base bomba nafta	CB	1 200028
	Cuerpo válvula cierre	GFT	1 510829
	Junta	CB	1 510830
	Guarnición goma	GS	2 510832
	Junta anular 29 x 40 x 0.8	NB	510933
	Cogotera	GS	1 510833
	Bancada	GS	1 510834
	Base distribuidor	CB	1 220938
	Arandela A 28.5 x 40	CB	1 510838
	O´ring G 62 x 3.5	GS	1
	O´ring G 63.09 x 3.53	GS	1
	O´ring G 32.92 x 3.53	GS	1
	O´ring G 20.3 x 2.62	GS	2
	Retén distribución 45 x 57.15 x 9.5	P	1 R510812P



510907



510810

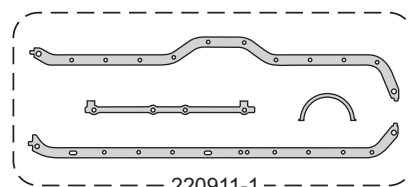

220911-1



510816

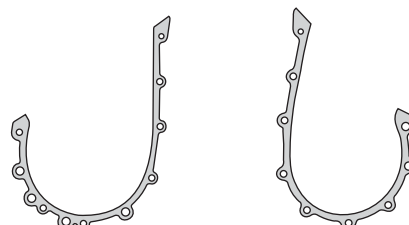

220912

510912



220914



220919



220927



510827



200028



510829



510830



510832



510933



G 62 x 3.5



G 63.09 x 3.53



220938



G 20.3 x 2.62



G 32.92 x 3.53



A 28.5 x 40



R510812P

**CHRYSLER****taranto**

Motor/Engine

Cm³

HP

Ø

239 CID V6

3910

130

99.31

Dodge: Pick Up V6 1987/91



Nº OE	Descripción/Description	Mat.	Ref.
	Jgo. de juntas para motor		● 520100-R
	Jgo. junta tapa cil. Ø 103.0 ± 1.30 (2)	NFT	1 520107
	Junta tapa de válvulas	CG	2 520110
	Jgo. junta para cárter (4)	CG	1 520111
	Tapa distribución	CB	1 510512
	Bomba de agua	CB	1 520114
	Jgo. múltiple escape (2)	NFT	1 520115
	Jta. múltiple admisión	AC	1 520116
	Jgo. múltiple admisión (4)	AC	1 520117
	Termostato	CB	1 510519
	Junta	CB	1 520122
	Bomba combustible	CB	1 200028
	Junta unión múltiple	CG	1 520130
	Junta unión múltiple	CG	1 520131
	Junta porta retén A 104 x 118 x 1.6	CB	1 510533
	Arandela A 30 x 46 x 3	GS	1 510535
	Arandela A 13 x 23 x 1.5 C	CU	1
	Arandela A 14 x 18 x 1.5 A	AL	1
	O´ring G 23.52 x 1.78	GS	1
	O´ring G 27.5 x 3.53	GS	1
	O´ring G 44.04 x 3.53	GS	1
	O´ring G 67.95 x 2.62	GS	1
	Retén distribución 55 x 81 x 15.8	V	1 R510512V

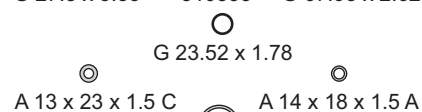
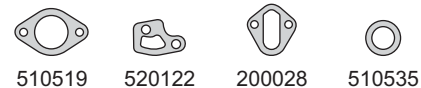
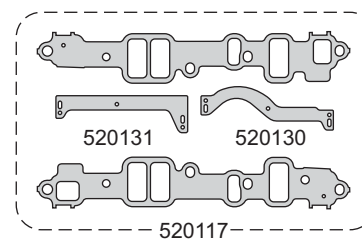
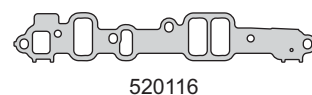
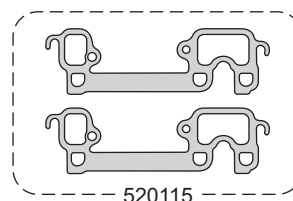
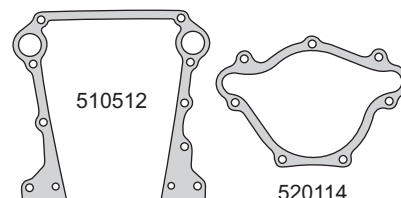
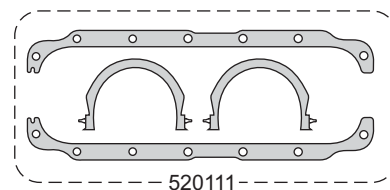
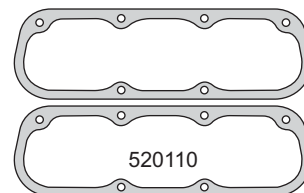
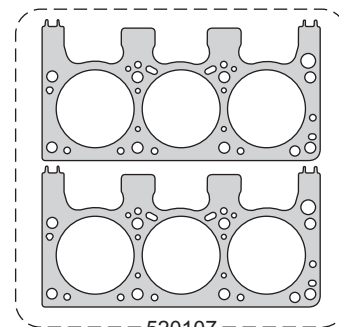

# CHRYSLER



Motor/Engine	Cm³	HP	Ø
135 (EDR)	2213	177	87.5
EDM (K00)	2501	99/101	87.5
EDT (SOHC) 8V	2501	150	87.5

**Chrysler:** 135 (EDR) Lebaron, Spirit, Shadow Voyager, Phantom, Caravan, Daytona New Yorker, Town & Country 1982/88 EDM (K00) Caravan, Grand Caravan Grand Voyager, Saratoga 1986/95 EDT Voyager, Caravan Lebaron, Daytona 1989/92



Nº OE	Descripción/Description	Mat.	Ref.
	Jgo. de juntas para motor		520200-R
	Jgo. de juntas superior	●	520295
	Jta. tapa cilindros Ø 89.0 ± 1.80	NFT 1 1	520205
	Jta. tapa cilindros Ø 89.0 ± 1.90	NFT	520207
	Jgo. junta tapa válvulas (6)	CG 1 1	520210
	Jgo. junta para cárter (4) 1984/87	CG 1	520211
	Jgo. junta para cárter goma (4) 1986/93	GS 1	520236
	Junta frente	NB 1	520212
	Bomba de agua	GS 1	520214
	Múltiple admisión y escape	NFT 1 1	520217
	Salida eje	NB 1 1	520218
	Termostato	NB 1	520219
	Chupador aceite	NB 1	520220
	Junta bomba de aceite	NFT 1	510527
	Bomba de nafta	NB 2	520228
	Arandela drenaje de cárter	PL 1	310930
	Guarnición	GS 2 2	520230
	Guarnición	GS 1 1	520232
	Bomba de aceite	NB 1	520235
	Inferior frente	NB 1	520237
	Porta retén	NB 1	520238
	Árbol de levas	NB 1	520239
	Tapón árbol de levas	GS 1 1	520240
	Suplemento camisa cilindros (0.50)	AC	520285-0.50
	O`ring G 6.07 x 1.78	GS 1	
	O`ring G 17.12 x 2.62	GS 1	
	O`ring G 20.30 x 2.62	GS 1	
	O`ring G 21.89 x 2.62	GS 1	
	O`ring G 47.22 x 3.53	GS 1	
	Kit de retenes completo		R520200
	Jgo. retén válvulas (8)	P 1	R520210P
	Retén bancada 91 x 111 x 10	V 1	R330511V
	Retén árbol de levas 35 x 52 x 8	N	R520213N
	Retén árbol de levas auxiliar 35 x 52 x 8	P 3	R520212P
	Retén directa caja velocidad 28.58 x 41.2 x 6.2	N 1	R300051N

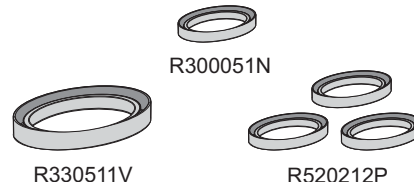
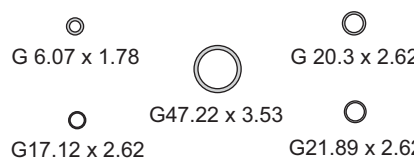
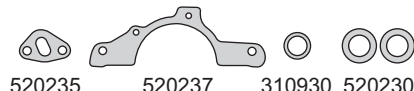
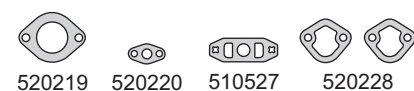
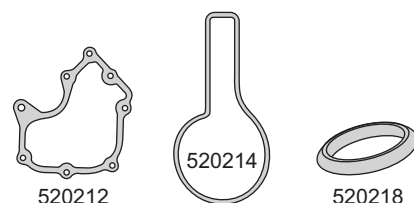
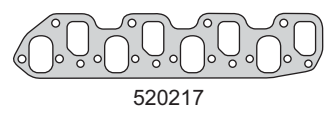
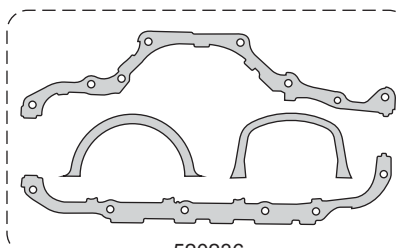
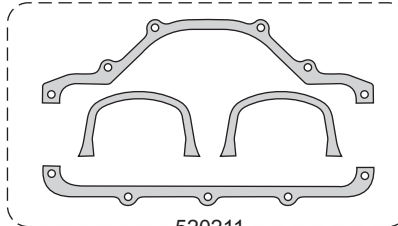
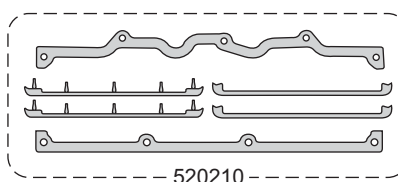
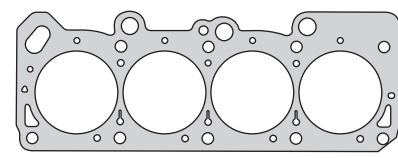



# CHRYSLER



Motor/Engine	Cm³	HP	Ø
360 (OHV) V8 16V Carburador y T.B.I	5899		

**Chrysler:** Charger, Dart GTS, Le Baron  
Cordoba, Monaco, Super Bee  
Camiones Ligeros D350/D600  
1979/92



Nº OE	Descripción/Description	Mat.	Ref.
	Jgo. de juntas para motor		520500-RMX
	Jgo. de juntas superior		520595 MX
	Jgo. junta tapa cilin. Ø 104.0 ± 1.20 (2)	NFT	1 1 520505
3658869	Conjunto tapa de válvulas (2)	CG	1 1 220510
	Jgo. junta para cárter (7)	CG	1 1 520511
	Tapa distribución	CB	1 1 510512
2129013	Tapa bomba de agua	NB	1 1 220514
	Jgo. múltiple escape (2)	NFT	1 1 520515
	Jgo. múltiple admisión (4)	NFT	1 1 520517
	Junta	NB	1 1 520519
	Junta	CB	1 1 520122
5752121	Bomba combustible	CB	1 1 200028
	Junta	GS	1 1 520530
2806095	Junta delantera múltiple admisión	CG	1 1 220530
2806096	Junta trasera múltiple admisión	CG	1 1 220531
	Jgo. múltiple admisión (4)	NB	1 1 520531
	Junta	AC	1 1 520532
	Junta porta retén	CB	1 1 510533
	Arandela A 14 x 20 x 1.5 C	CU	1 1
	Kit de retenes completo		R520500
	Jgo. retén válvulas (16)	P	1 R520510P
	Retén bancada (2 mitades)	S	2 R510711-1S
	Retén distribución 55 x 81 x 15.8	V	1 R510512V

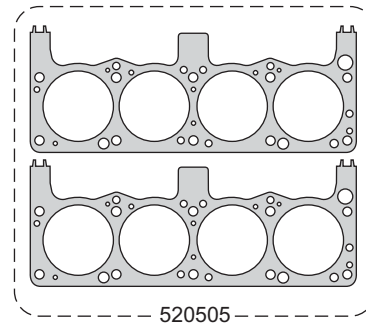

520505

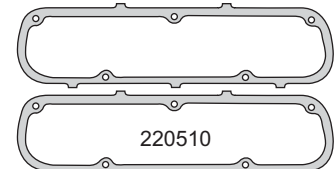

220510

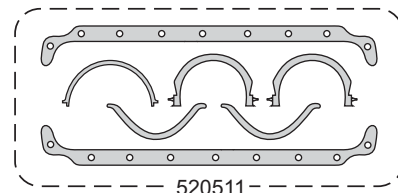

520511

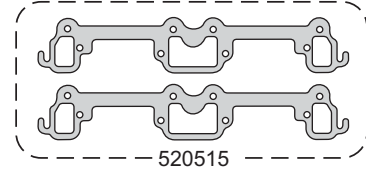

520515

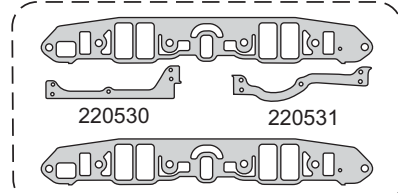

220530

220531

520517

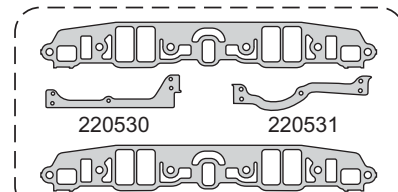

220530

220531

520531

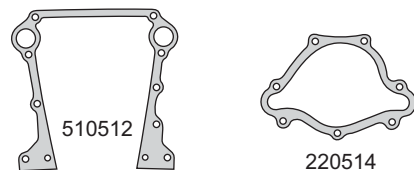

510512

220514

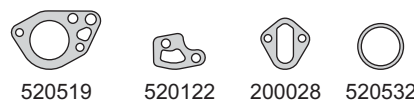

520519

520122

200028

520532



510533

A 14 x 20 x 1.5 C



R510711-1S

R510512V



R520510P

# CHRYSLER



Motor/Engine	Cm³	HP	Ø
150 (H00) (SOHC) V6 24V	2497	167	83.5

Chrysler: Stratus, Avenger, Sebring, Cirrus  
1995/99



Nº OE	Descripción/Description	Mat.	Ref.
MD973444	Jgo. de juntas para motor	●	520600-R
MD320044	Jgo. junta tapa cil. Ø 87.0 ±1.40 (2)	NFT	2 520607
MD303148	Conj. junta tapa válvulas (2)	GS	1 960010
	Junta para cárter	CB	1 520611
	Jgo. múltiple escape (2)	FCH	1 960015
	Jgo. múltiple admisión (2)	AC	1 960017
	Anillo termostato	GS	1 520619
	Junta tapa VGR	NH	1 520626
	Junta entre colectores	AC	1 960029
	Junta brida VGR	NH	1 520632
	Junta brida VGR	NFT	1 520633
	Junta brida VGR	SLS	2 520634
	Junta brida VGR	AC	1 520635
	Junta brida VGR	NFT	1 520636
	Junta brida VGR	NFT	1 520637
	Guarnición cónica bujías G 24 x 37 x 42 x 1.6	GS	6 960038
	O´ring G 44.5 x 3.5	GS	1
	O´ring cañería agua G 16 x 3.5	GS	2
	O´ring pico inyector G 8 x 2	GS	6
	Kit de retenes completo		R960000
TRVSS0305980	Jgo. retén válvulas (24)	P	1 R960010P
TR4111209L	Retén bancada 91 x 111 x 9	S	1 R960011S
TRV0501306R	Retén distribución 37 x 50 x 6	N	1 R960012N
TRV0501508R	Retén árbol de levas 35 x 50 x 8	N	2 R960013N

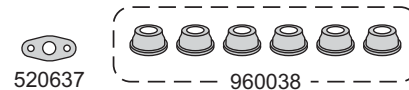
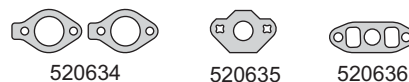
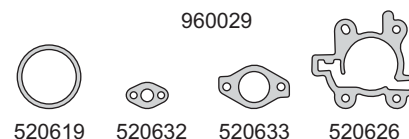
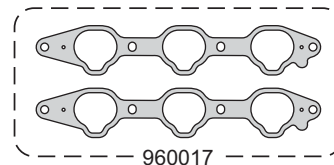
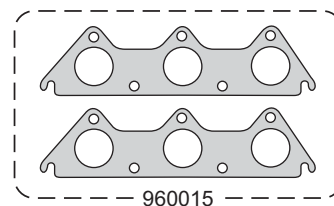
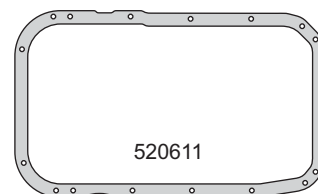
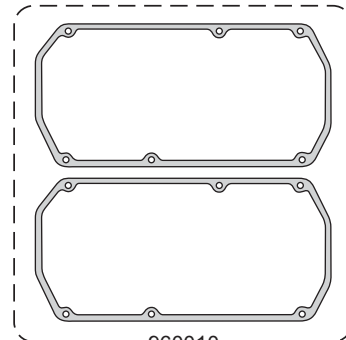
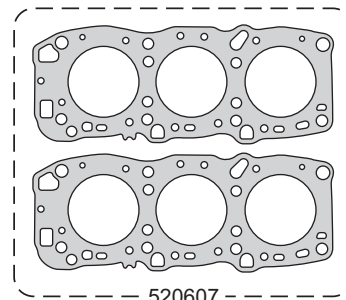

# CHRYSLER



Motor/Engine	Cm³	HP	Ø
G54B (SOHC) 12V	2555	103	91.1

Chrysler: Pick Up, Lebaron, Caravan 1981/89



Nº OE	Descripción/Description	Mat.	Ref.
	Jgo. de juntas para motor		● 520800-RMX
	Jgo. junta tapa cilindros Ø 94.0 ± 1.20	NFT	1 520805
	Junta tapa válvulas	GS	1 520810
	Junta para cárter	CG	1 910511
	Tapa distribución	CB	1 520812
	Tapa distribución	CB	1 520813
	Bomba de agua	NB	1 520814
	Múltiple escape	NFT	1 520816
	Múltiple admisión	NFT	1 520817
	Junta	NB	1 520819
	Junta	NB	2 520228
	Junta porta retén trasero	NB	1 910529
	Junta	NB	1 520830
	Junta frente motor	CB	1 520831
	Junta	NB	1 520832
	Junta	NB	1 520833
	Junta	NB	1 910433
	Junta	CB	1 520834
	Junta	NB	1 520835
	Guarnición	GS	2 520931
	O´ring G 17.12 x 2.62	GS	1
	Arandela A 18 x 22 x 1.5 A	AL	1
	Kit de retenes completo		R520800
	Jgo. retén válvulas (12)	P	1 R520810P
	Retén bancada 80 x 96 x 9	P	1 R520811P
	Retén distribución 48 x 68 x 11	P	1 R520812P

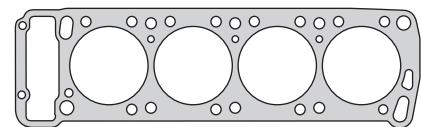

520805

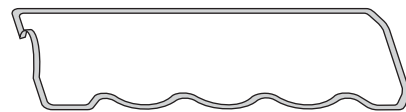

520810

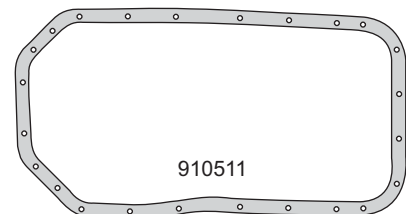

910511

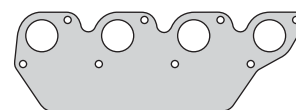

520816

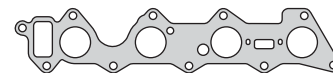

520817



520812

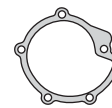

520814



520813



520819

520228

520830

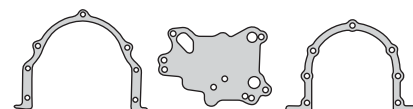

910529

520833

520831

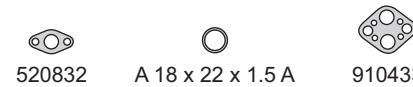

520832

A 18 x 22 x 1.5 A

910433

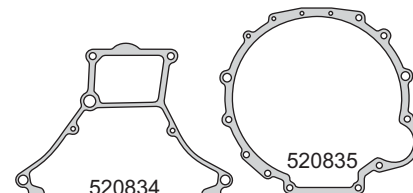

520834

520835

G 17.12 x 2.62



R520811P



R520812P

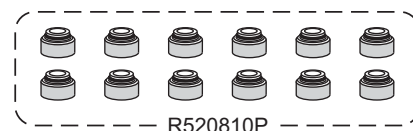

R520810P

**CHRYSLER**

Motor/Engine

Cm³

HP

Ø

6G72 - 181CID  
(SOHC) V6 12V

2972

143

92

Chrysler: Pick Up, Carvan 1987/96  
Spirit, Daytona 1990/93

Nº OE	Descripción/Description	Mat.	Ref.
	Jgo. de juntas para motor		520900-RMX
	Jgo. de juntas superior	●	520995
	Jgo. jta. tapa cil. Ø 95.0 ± 1.50 (2)	NFT 1	520905
	Jgo. jta. tapa cil. Ø 95.0 ± 1.60 (2)	NFT 1	520907
	Conj. junta tapa de válvulas (2)	GS 1	520910
	Junta para cárter	CB 1	520611
	Junta distribución	CB 1	520912
	Junta distribución	CB 1	520913
	Junta distribución	CB 1	961113
	Bomba de agua	CB 1	520914
	Bomba de agua	CB 1	520914-1
	Jgo. múltiple escape (2)	AC 1	520915
	Jgo. múltiple admisión (2)	NFT 1	520917
	Salida de escape	NFT 2	520918
	Junta	CB 1	520919
	Junta árbol de levas	CB 1	510020
	Junta	NB 2	520228
	Guarnición	NB 2	520930
	Guarnición	GS 4	520931
	Junta	CB 2	520932
	Junta	CB 1	520933
	Junta	CB 1	520934
	Junta	CB 1	520935
	Junta	CB 1	520936
	Junta	NFT 1	520937
	Jgo. múltiple de admisión (2)	CB 1	520938
	Junta	CB 1	520939
	Junta	CB 1	520940
	Junta	CB 1	520941
	Junta	CB 1	520942
	Junta	NFT 2	520943
	Junta	CB 2	520944
	O´ring G 7.65 x 1.78	GS 12	12
	O´ring G 9.25 x 1.78	GS 2	2
	O´ring G 45.69 x 2.62	GS 1	1
	O´ring G 15.47 x 3.53	GS 1	1
	O´ring G 21.82 x 3.53	GS 1	1
	O´ring G 31.34 x 3.53	GS 3	3
	Arandela A 19 x 26 x 1.5 C	CU 1	1
	Arandela A 20 x 28 x 1 C	CU 1	1
	Kit de retenes completo		R520900
	Jgo. retén válvulas (12)	P 1	R520910P
	Retén bancada 91 x 111 x 9	S 1	R520911S
	Retén distribución 37 x 50 x 6	S 1	R520912S
	Retén auxiliar 35 x 50 x 8	N 2	R520915N

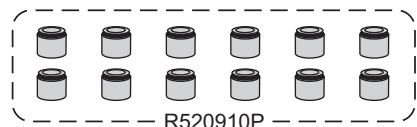
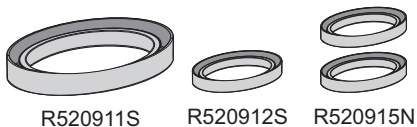
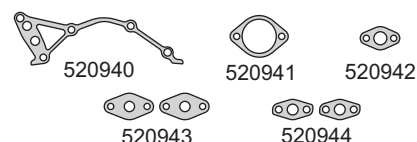
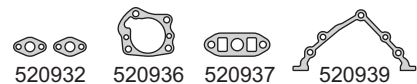
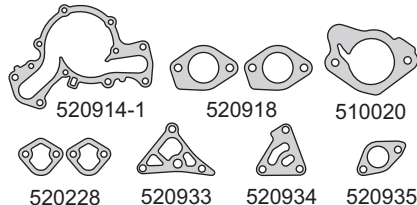
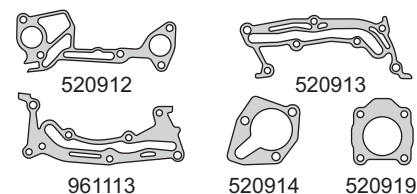
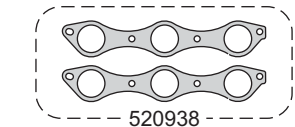
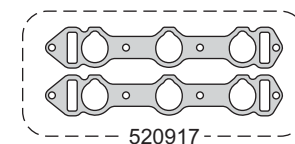
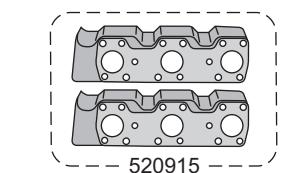
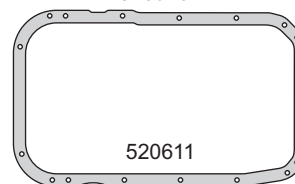
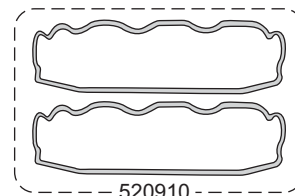
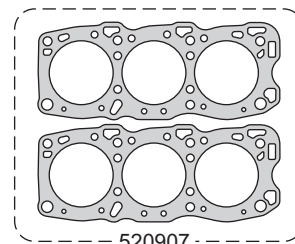

# CHRYSLER



Motor/Engine	Cm³	HP	Ø
ECB (SOHC) 16V	1996	135	87.5

Chrysler: Neón 2000/05



Nº OE	Descripción/Description	Mat.	Ref.
	Jgo. de juntas para motor		● 521000-R
0477-7072AB	Junta tapa cilindros Ø 89.5 ± 1.00	MLS	1 521008
0466-7985	Conj. junta tapa de válvulas (5)	GS	1 521010
0455-6666	Junta para cárter (goma/metal)	GS	1 230411
0466-7663	Bomba de agua	GS	1 230414
0466-7492	Múltiple escape	NFT	1 230416
0477-7895AA	Junta toberas múltiple admisión (4)	GS	1 230417
	Brida	NFT	1 230439
	Brida	NFT	1 230440
	Guarnición goma G 24 x 32 x 4.5	GS	1 230442
	O'ring G 48.9 x 2.62	GS	1
	O'ring G 35 x 6	GS	1
	O'ring G 34.52 x 3.53	GS	1
	O'ring G 20.3 x 2.62	GS	1
	O'ring G 26.64 x 2.62	GS	1
	Kit de retenes completo		R521000
	Jgo. retén válvulas (16)	P	1 R521010P
0466-7904	Retén bancada 91 x 111 x 10	V	1 R330511V
0466-7198	Retén distribución 32 x 45 x 6.5	P	1 R230412P
0477-7086	Retén árbol de levas 35 x 48 x 7	P	1 R240013P

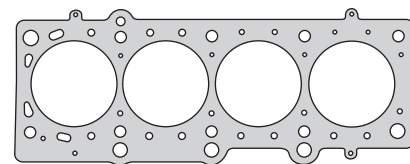

521008

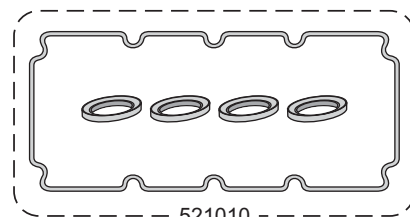

521010

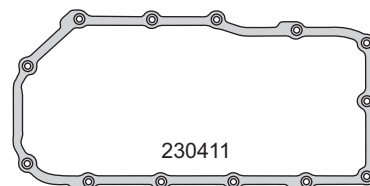

230411



230416



230417



230414



230439



230440



230442



G 26.64 x 2.62



G 20.3 x 2.62



G 34.52 x 3.53



G 48.9 x 2.62



G 35 x 6



R330511V



R230412P



R240013P

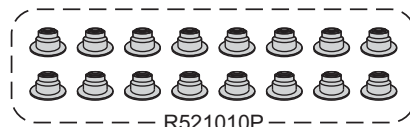

R521010P

**CHRYSLER**



Motor/Engine	Cm³	HP	Ø
ECC (DOHC) 16V	1996	150	87.5

Chrysler: PT Crusier 2002/05



Nº OE	Descripción/Description	Mat.		Ref.
	Jgo. de juntas para motor		●	521100-R MLS
	Jgo. de juntas superior		●	521195
	Junta tapa cilindro Ø 88.0 ± 1.20	NFT		521107
	Junta tapa cilindro Ø 88.0 ± 0.70	MLS	1 1	521108
	Conj. junta tapa de válvulas (5)	GS	1 1	521110
0455-6666	Junta para cárter (goma/metal)	GSAC	1	230411
0466-7663	Bomba de agua	GS	1	230414
	Múltiple escape	AC	1 1	521515
	Jgo. múltiple admisión (4)	GS	1 1	521117
	Jgo. múltiple admisión (4)	GS	1 1	521132
	Brida	NFT	1 1	230439
	Brida	NFT	1 1	230440
	Guarnición goma G 24 x 32 x 4.5	GS	1 1	230442
	Arandela A 20 x 28 x 1 C	CU		1
	O´ring G 7.52 x 3.53	GS	4 4	
	O´ring G 20.3 x 2.62	GS		1
	O´ring G 26.64 x 2.62	GS		1
	O´ring G 36.09 x 3.53	GS		1
	O´ring G 37.77 x 2.62	GS		1
	O´ring G 48.9 x 2.62	GS		1
	Kit de retenes completo			R521000
	Jgo. retén válvulas (16)	P	1	R521010P
0466-7904	Retén bancada 91 x 111 x 10	V	1	R330511V
0466-7198	Retén distribución 32 x 45 x 6.5	P	1	R230412P
0477-7086	Retén árbol de levas 35 x 48 x 7	P	2	R240013P

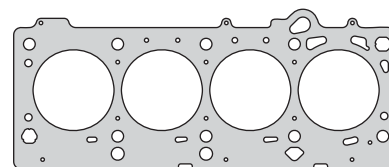

521108

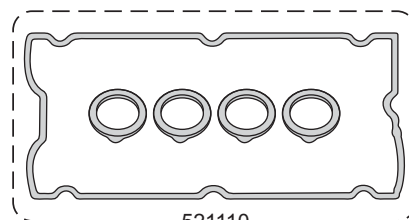

521110

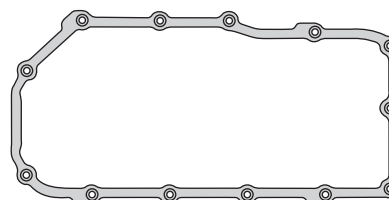

230411

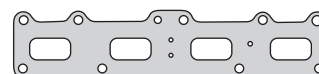

521515

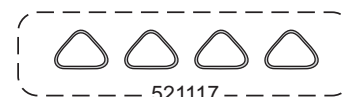

521117

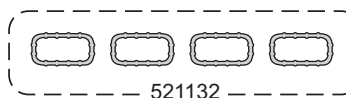

521132



230414



230439



230440



230442

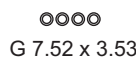

G 7.52 x 3.53



G 20.3 x 2.62



G 37.77 x 2.62



G 36.09 x 3.53



A 20 x 28 x 1 C



G 48.9 x 2.62



G 26.64 x 2.62



R330511V



R230412P



R240013P

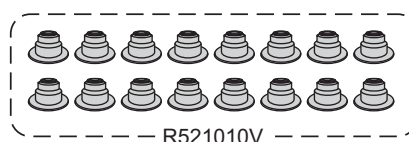

R521010V

# CHRYSLER



Motor/Engine	Cm³	HP	Ø
135 (EDR)	2213	177	87.5
153 (EDT) (SOHC) 8V	2501	150	87.5

Chrysler: Voyager, Caravan, Saratoga  
Lebaron, Daytona Turbo 1989/...



Nº OE	Descripción/Description	Mat.	Ref.
	Jgo. de juntas para motor		521200-R
	Jgo. de juntas superior	●	521295
	Jgo. junta tapa cil. Ø 89.0 ± 1.80	NFT 1 1	520205
	Jgo. junta tapa cil. Ø 89.0 ± 1.90	NFT	520207
	Junta tapa de válvulas	GS 1 1	521210
	Jgo. junta para cárter (4)	CG 1 1	520211
	Tapa distribución	NB 1 1	520212
	Bomba de agua	GS 1 1	520214
	Múltiple admisión	NFT 1 1	520217
	Salida eje	NB 1 1	520218
	Termostato	NB 1 1	520219
	Chupador aceite	NB 1 1	520220
	Junta bomba de aceite	NFT 1 1	510527
	Bomba de nafta	NB 2 2	520228
	Guarnición	GS 2 2	520230
	Arandela drenaje de cárter	PLAST 1 1	310930
	Guarnición	GS 1 1	520232
	Bomba de aceite	NB 1 1	520235
	Jgo. junta para cárter (4)	GS 1 1	520236
	Inferior frente	NB 1 1	520237
	Porta retén	NB 1 1	520238
	Arbol de levas	NB 1 1	520239
	Tapón árbol de levas	GS 1 1	520240
	O´ring G 6.07 x 1.78	GS 1 1	
	O´ring G 17.12 x 2.62	GS 1 1	
	O´ring G 20.30 x 2.62	GS 1 1	
	O´ring G 21.89 x 2.62	GS 1 1	
	O´ring G 47.22 x 3.53	GS 1 1	
	Kit de retenes completo		R520200
	Jgo. retén válvulas (8)	P 1 1	R520210P
	Retén bancada 91 x 111 x 10	V 1 1	R330511V
	Retén auxiliar 35 x 52 x 8	P 3 3	R520212P
	Retén directa caja velocidad 28.58 x 41.2 x 6.2	N 1 1	R300051N

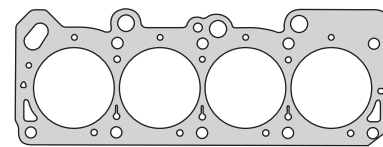

520205



521210

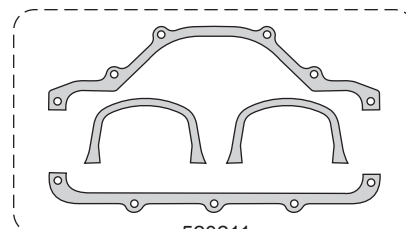

520211

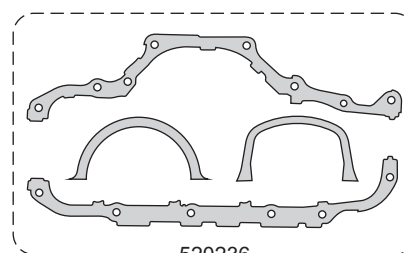

520217

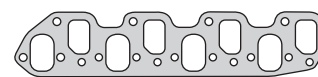

510527

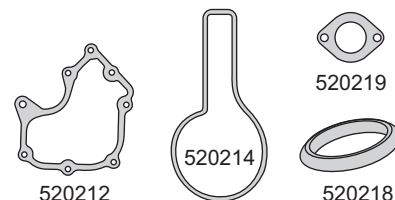

520212

520214

520219

520218

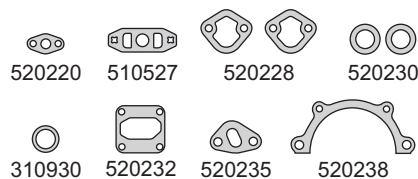

310930

520220

510527

520228

520230

520232

520235

520238

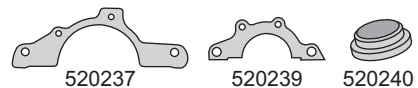

520237

520239

520240

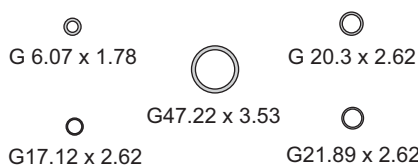

G 6.07 x 1.78

G 20.3 x 2.62

G 17.12 x 2.62

G 47.22 x 3.53

G 21.89 x 2.62

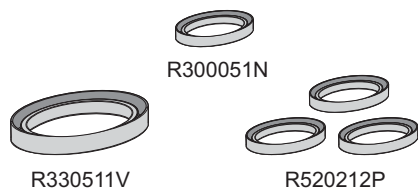

R300051N

R330511V

R520212P



R520210P

**CHRYSLER****taranto**

Motor/Engine

Cm³

HP

Ø

EDZ  
(DOHC) 16V

2429

150

87.5

Chrysler: Stratus, Cirrus, Plymouth Breeze  
Caravan, Grand Caravan, Voyager  
Grand Voyager 1995/00

Nº OE	Descripción/Description	Mat.	Ref.
	Jgo. de juntas para motor		521400-R
	Jgo. de juntas superior	●	521495
0469-4324	Jta. tapa cilindros Ø 89.0 ± 1.40	NFT 1 1	230807
	Conj. junta tapa de válvulas (5)	GS 1 1	521410
	Jgo. junta para cárter (14)	CG 1 1	521411
0466-7663	Bomba de agua	GS 1 1	230414
0466-7722	Múltiple escape	NFT 1 1	230816
0466-7539	Múltiple admisión	NB 1 1	230817
	Junta	NB 1 1	230832
	Arandela A 20 x 28 x 1 C	CU 1 1	
	O'ring G 20.3 x 2.62	GS 1 1	
	O'ring G 24.99 x 3.53	GS 1 1	
	Kit de retenes completo		R521400
0464-8619	Jgo. retén válvulas (16)	P 1 1	R521010P
	Retén bancada 91 x 111 x 10	V 1 1	R981311V
0466-7198	Retén distribución 32 x 45 x 6.5	P 1 1	R230412P
0477-7086	Retén árbol de levas 38 x 48 x 7	P 2 2	R240013P

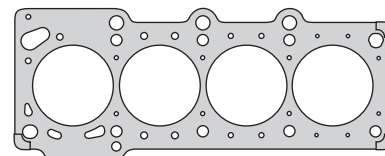

230807

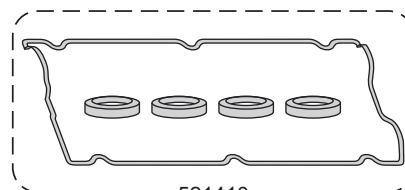

521410

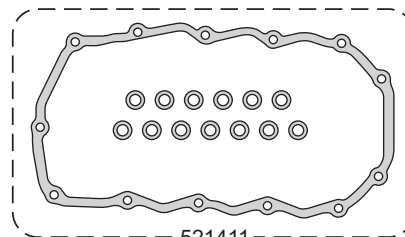

521411



230816

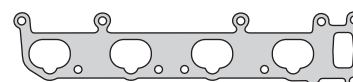

230817

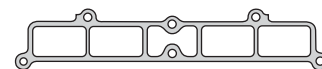

230832



230414



A 20 x 28 x 1 C

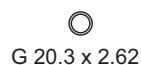

G 20.3 x 2.62



G 24.99 x 3.53



R981311V



R230412P



R240013P

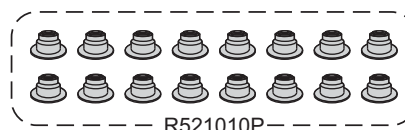

R521010P



# CHRYSLER



Motor/Engine	Cm³	HP	Ø
EDZ (DOHC) 16V	2429	150	87.5

Chrysler: Stratus 2002/6



Nº OE	Descripción/Description	Mat.	Ref.
	Jgo. de juntas para motor		521500-R
	Juntas tapa cilindro Ø 88.0 ± 1.20	NFT	521107
	Juntas tapa cilindro Ø 88.0 ± 0.70	MLS	1 521108
	Jgo. de tornillos para tapa de cilindros		B522100
	Conj. junta tapa de válvulas (5)	GS	1 521510
	Junta para cárter	GS	1 521511
	Bomba de agua	GS	1 521514
	Múltiple escape	AC	1 521515
	Jgo. múltiple admisión (4)	GS	1 521517
	Junta	GS	1 521530
	Brida	NFT	1 230440
	Guarnición goma G 24 x 32 x 4.5	GS	1 230442
	Arandela A 20 x 28 x 1 C	CU	1
	O'ring G 7.52 x 3.53	GS	4
	O'ring G 15.47 x 3.53	GS	2
	O'ring G 20.3 x 2.62	GS	1
	O'ring G 26.64 x 2.62	GS	1
	O'ring G 36.09 x 3.53	GS	1
	O'ring G 37.77 x 2.62	GS	1
	O'ring G 48.9 x 2.62	GS	1
	Kit de retenes completo		R521500
	Jgo. retén válvulas (16)	P	1 R521010P
0466-7904	Retén bancada 91 x 111 x 10	V	1 R330511V
0477-7086	Retén árbol de levas 35 x 48 x 7	P	2 R240013P

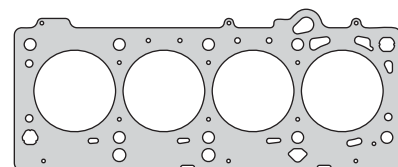

521108

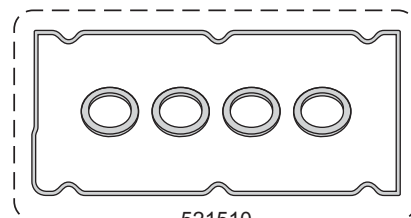

521510

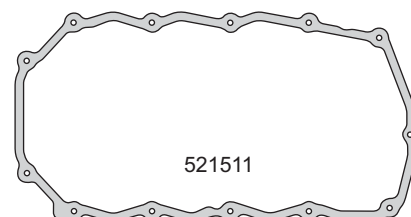

521511

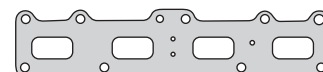

521515

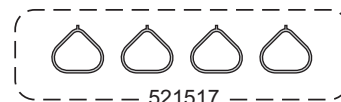

521517

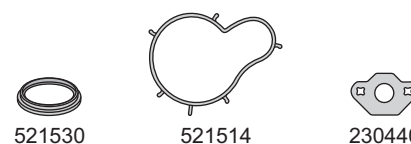

521530

521514

230440

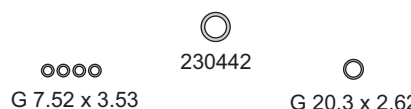

G 7.52 x 3.53

230442

G 20.3 x 2.62

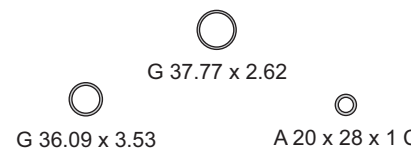

G 36.09 x 3.53

G 37.77 x 2.62

A 20 x 28 x 1 C

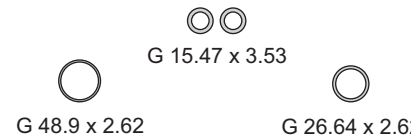

G 48.9 x 2.62

G 15.47 x 3.53

G 26.64 x 2.62



R330511V

R240013P

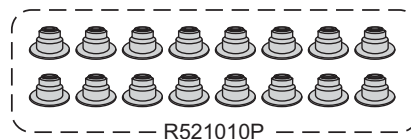

R521010P

# CHRYSLER



Motor/Engine	Cm³	HP	Ø
EGH (OHV) V6 16V	3778	162	96

Chrysler: Voyager 2002/06  
Pacifica 2004/07



Nº OE	Descripción/Description	Mat.	Ref.
	Jgo. de juntas para motor		521600-R
	Jgo. de juntas superior	●	521695
	Jgo. tapa cilin. Ø 97.2 ± 0.75 (2)  NR <sup>2</sup>	MLS 1 1	521608
	Jgo. tornillos tapa cilindros (HAS15038)		B510000
	Junta tapa de válvulas	GS 2 2	521610
	Junta para cárter	GS 1	510011
	Tapa distribución	CB 1	510012
	Jgo. múltiple escape (2)	NFT 1 1	510015
	Múltiple admisión	SLS 1 1	521617
	Junta	NB 1	521619
	Junta bancada trasera	CB 1	510122
	Junta	AC 2 2	521630
	Junta	GS 1	521631
	Jgo. múltiple de admisión (8)	VS 1 1	521632
	Junta cuerpo aceleración	S 1 1	521633
	Guarnición goma	GS 1	521634
	Junta	NB 1	521635
	O´ring G 20.32 x 2.62	GS 1	
	Kit de retenes completo		R521600
	Jgo. reten válvulas (16)	V 1	R521610V
	Retén bancada 91 x 111 x 10	V 1	R330511V
	Retén distribución 28.5 x 41.25 x 6	P 1	R510012P

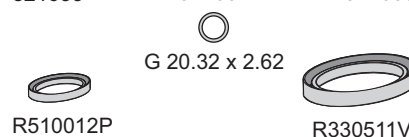
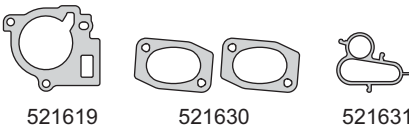
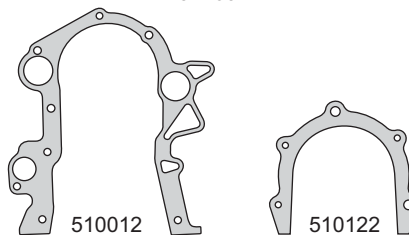
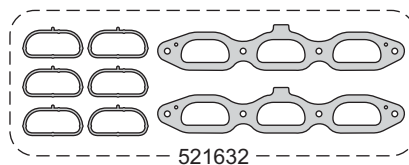
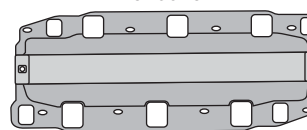
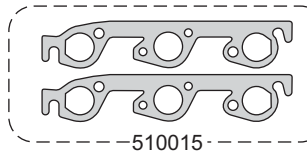
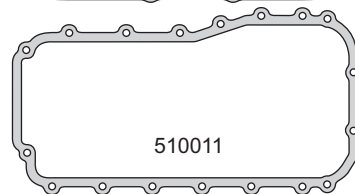
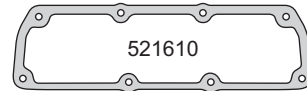
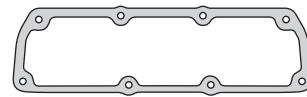
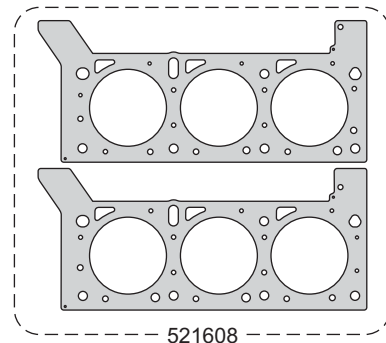

# CHRYSLER



Motor/Engine	Cm³	HP	Ø
V8 Magnum	4698	235	93

Chrysler: Dakota, Ram 1500 2000/11  
Grand Cherokee, Durango 1999/09  
Aspen, Commander 2006/09



Nº OE	Descripción/Description	Mat.	Ref.
	Jgo. de juntas para motor		● 521700-R MLS
	Jgo. de juntas superior	●	521795 MLS
	Jgo. jta. tapa cil. Ø93.7 ± 0.75 (2)	MLS 1 1	521708
	Conj. junta tapa válvulas (2)	GS 1 1	521710
	Junta para cárter	AC/GS 1	521711
	Tapa distribución	AC/GS 1	521712
	Jgo. múltiple escape (2)	GFT 1 1	521715
	Jgo. múltiple admisión (8)	GS 1 1	521717
	Bomba de agua	GS 1 1	521730
	Junta cuerpo aceleración	GS 1	521731
	Junta tubo de llenado de aceite	GS 1 1	521732
	Junta	GS 1 1	521733
	Junta	GS 1 1	521734
	Kit de retenes completo		R521700
	Jgo. retén válvulas (16)	V 1	R521710V
	Retén bancada 91 x 111 x 10	V 1	R521711V
	Retén distribución 32 x 45 x 6	V 1	R521712V

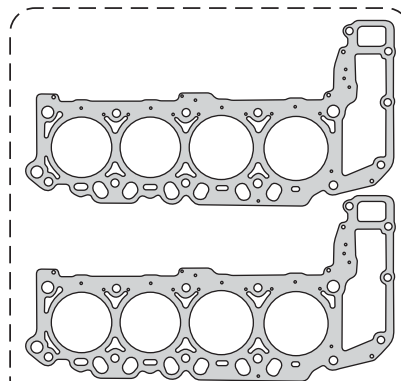

521708

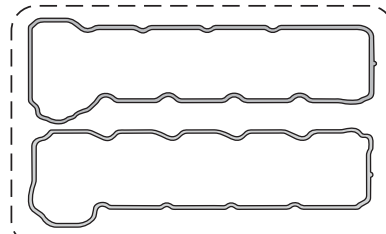

521710

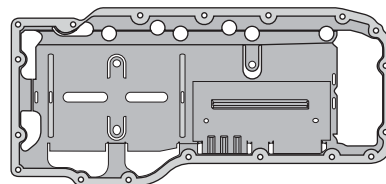

521711

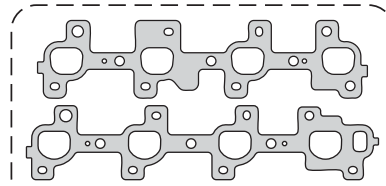

521715

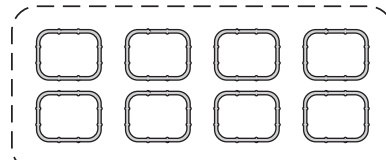

521717

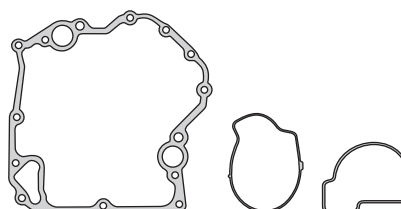

521712

521730

521731



521732

521733

521734

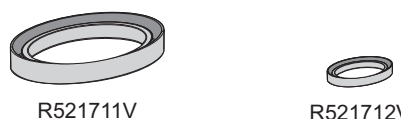

R521711V

R521712V

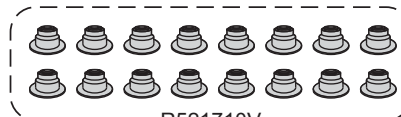

R521710V

# CHRYSLER



Motor/Engine	Cm³	HP	Ø
EKG (SOHC) V6 12V	3701	210	93

**Chrysler:** Dakota, Ram 1500, Durango 2000/09  
**Jeep:** Liberty, Grand Cherokee 2002/09



Nº OE	Descripción/Description	Mat.	Ref.
	Jgo. de juntas para motor		● 521800-R MLS
	Jgo. de juntas superior	●	521895 MLS
	Jgo. tapa cil. Ø 93.75 ± 0.70 (2)	NFT 1 1	521808
	Conj. junta tapa de válvulas (2)	GS 1 1	521810
	Junta para cárter	AC/GS	521811
	Junta distribución	AC/GS	521812
	Jgo. múltiple escape (2)	GFT 1 1	521815
	Jgo. múltiple admisión (6)	GS 1 1	521817
	Bomba de agua	GS 1 1	521830
	Junta cuerpo aceleración	GS 1 1	521731
	Junta cuerpo aceleración	GS 1	521831
	Junta tubo llenado de aceite	GS 1 1	521732
	Junta	GS 1	521733
	Junta	GS 1	521734
	Kit de retenes completo		R521800
	Jgo. retén válvulas (12)	V 1	R521810V
	Retén bancada 91 x 111 x 10	V 1	R521711V
	Retén distribución 32 x 45 x 6	V 1	R521712V

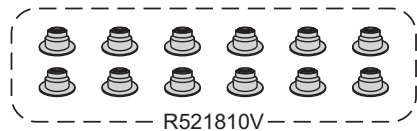
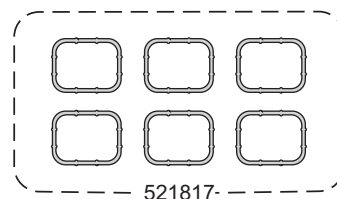
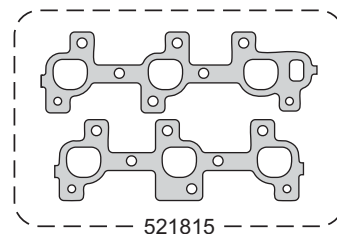
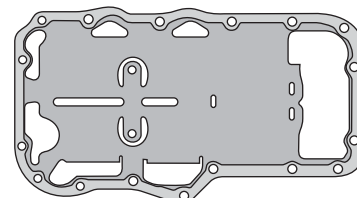
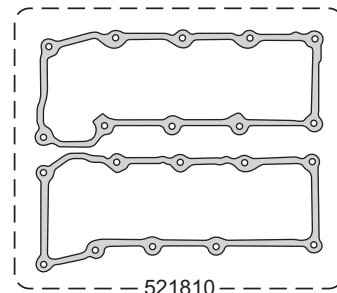
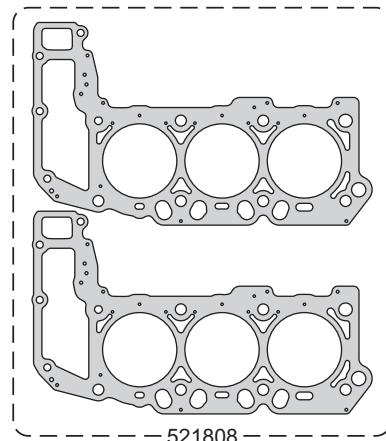

# CHRYSLER



Motor/Engine	Cm³	HP	Ø
EZB - Hemi (OHV) V8 16V	5645	345	99.5

**Chrysler:** Ram 2500, Ram 3500, Ram Quad Charger, Jeep Comander, Sonora 300C, Grand Cherokee, Aspen



Nº OE	Descripción/Description	Mat.	Ref.
	Jgo. de juntas para motor		● 521900-RMX
	Jgo. juntas tapa cil. Ø 100.0 ± 0.75 (2) NR		MLS 1 521908
	Conj. junta tapa de válvulas (10)		GS 1 521910
	Junta para cárter		AC/GS 521911
	Junta distribución		GS 1 521912
	Jgo. múltiple escape (2)		NFT 1 521915
	Jgo. múltiple admisión (8)		GS 1 521917
	Junta válvula PVC		GS 1 521930
	Guarnición goma		GS 1 521931
	Junta cuerpo de aceleración		GS 1 521932
	Kit de retenes completo		R521900
	Jgo. retén válvulas (16)		V 1 R521910V
	Porta retén bancada		T PR521911T
	Reten distribución 50 x 75.5 x 11		T R521912T

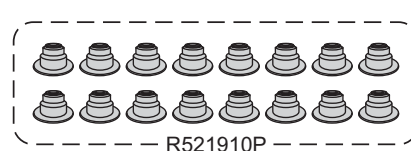
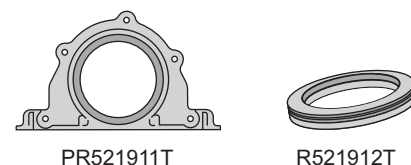
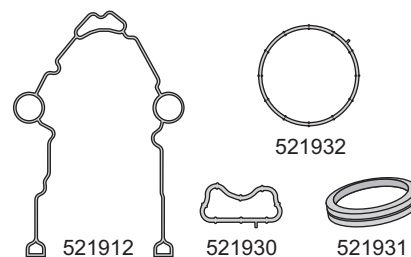
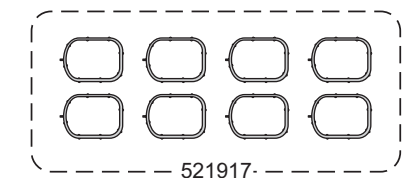
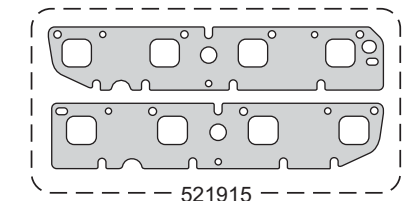
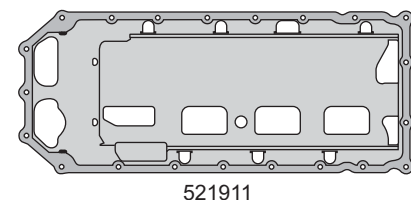
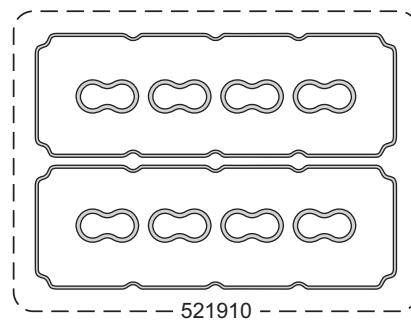
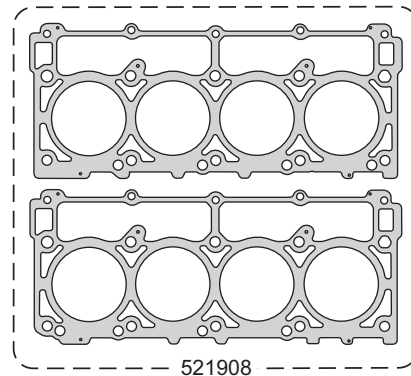

# CHRYSLER



Motor/Engine Cm³ HP Ø

EGE (DOHC) V6 24V 3518 214 96

Chrysler: Concorde, New Yorker LHS



Nº OE	Descripción/Description	Mat.		Ref.
	Jgo. de juntas para motor		●	522000-R
	Jgo. de juntas superior		●	522095
	Jgo. tapa cil. Ø 100.0 ±1.40 (2)  N.R.	NFT	1 1	522007
	Junta tapa válvulas	GS	2 2	522010
	Junta para cárter	ACP		522011
	Junta distribución	NB	1	522012
	Jgo. múltiple escape (2)	NFT	1 1	522015
	Jgo. múltiple admisión (2)	NB	1 1	522017
	Junta base termostato	NB	1 1	200819
	Junta	CB	1	510122
	Arandela drenaje cárter		1	310930
	Junta	NB	2 2	522030
	Junta	NB	2 2	522031
	Junta	NB	1 1	522032
	Junta	GFT	1 1	520637
	Junta brida	NFT	1 1	230439
	Junta brida	NFT	1 1	230440
	Junta	GFT	1 1	520640
	O´ring G 20.3 x 2.62	GS	8 8	
	O´ring G 24.99 x 3.53	GS	1 1	
	O´ring G 28.17 x 3.53	GS	6 6	
	O´ring G 34.52 x 3.53	GS	2 2	
	O´ring G 7.52 x 3.53	GS	6 6	
	O´ring G 98.02 x 3.53	GS	1 1	
	Kit de retenes completo			R522000
	Jgo. retén válvulas (24)	P	1	R522010P
	Retén bancada 91 x 111 x 10	V	1	R330511V
	Retén árbol de levas	P	1	R522013P
	Retén directa caja velocidad 28.58 x 41.20 x 6.2	N	1	R300051N

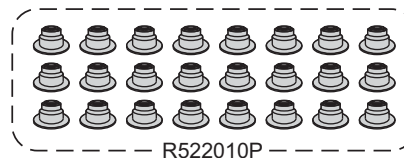
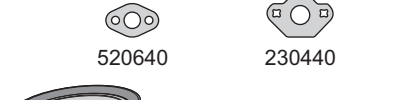
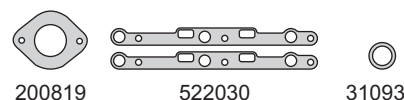
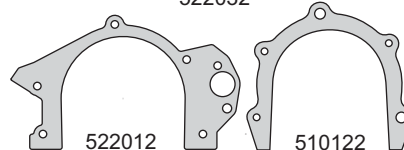
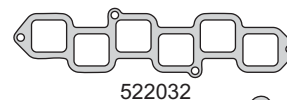
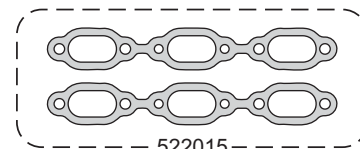
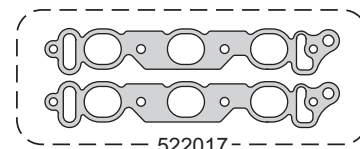
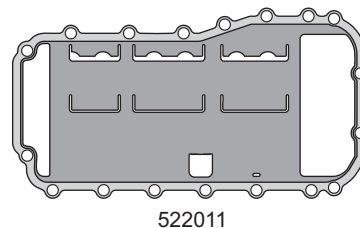
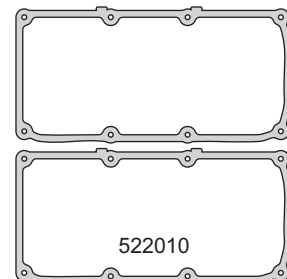
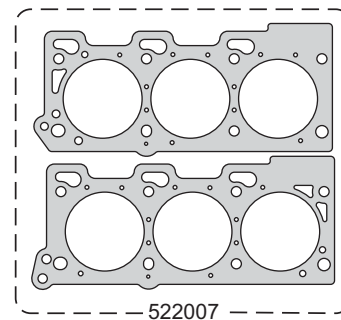

# CHRYSLER



Motor/Engine	Cm³	HP	Ø
EDZ (DOHC) 16V	2429	150	87.5

Chrysler: PT Crusier 2002/05



Nº OE	Descripción/Description	Mat.	Ref.
	Jgo. de juntas para motor		522100-R
	Jgo. de juntas superior		522195
	Junta tapa cilindro Ø 88.0 $\pm$ 1.20	NFT	521107
	Junta tapa cilindro Ø 88.0 $\pm$ 0.70	MLS 1 1	521108
	Jgo. de tornillos para tapa de cilindros		B522100
	Conj. junta tapa de válvulas (5)	GS 1 1	521110
	Junta para cárter	GS 1 1	522111
0466-7663	Bomba de agua	GS 1 1	230414
	Junta múltiple escape	AC 1 1	521515
	Jgo. múltiple admisión (4)	GS 1 1	521117
	Junta	AL/GS 1 1	522130
	Jgo. múltiple admisión (4)	GS 1 1	521132
	Brida	NFT 1 1	230439
	Brida	NFT 1 1	230440
	Guarnición goma G 24 x 32 x 4.5	GS 1 1	230442
	Arandela A 20 x 28 x 1 C	CU	1
	O´ring G 7.52 x 3.53	GS 4 4	
	O´ring G 15.47 x 3.53	GS	2
	O´ring G 20.3 x 2.62	GS	1
	O´ring G 26.64 x 2.62	GS	1
	O´ring G 36.09 x 3.53	GS	1
	O´ring G 37.77 x 2.62	GS	1
	O´ring G 48.9 x 2.62	GS	1
	Kit de retenes completo		R522100
	Jgo. retén válvulas (16)	P 1	R521010P
0466-7904	Retén bancada 91 x 111 x 10	V 1	R330511V
0466-7198	Retén distribución 32 x 45 x 6.5	P 1	R230412P
0477-7086	Retén árbol de levas 35 x 48 x 7	P 2	R240013P

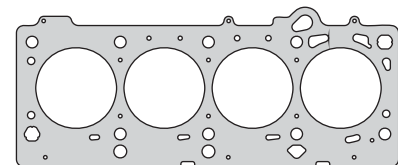

521108

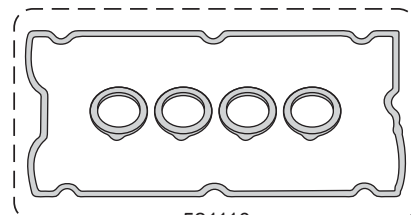

521110

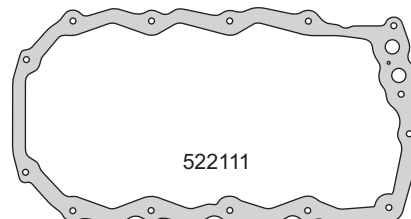

522111

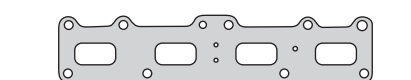

521515



521117

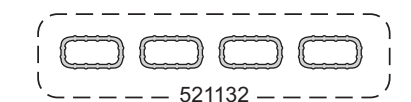

521132

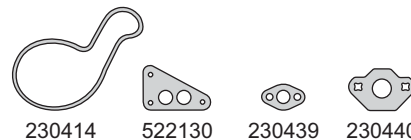

230414 522130 230439 230440

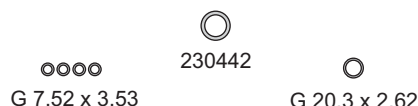

G 7.52 x 3.53 230442 G 20.3 x 2.62

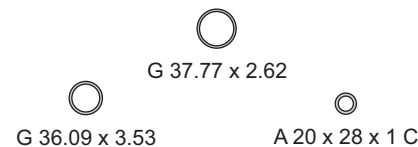

G 36.09 x 3.53 G 37.77 x 2.62 A 20 x 28 x 1 C

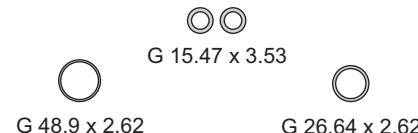

G 48.9 x 2.62 G 15.47 x 3.53 G 26.64 x 2.62



R330511V



R230412P R240013P



R521010P

# CHRYSLER



Motor/Engine	Cm³	HP	Ø
ED3 - GEMA (DOHC) 16V	2360	170/174	88

**Chrysler:** Jeep Avenger, Patriot, Caliber  
Compass, Sebring, Stratus 2007/...  
Journey, Compass 2009/...

**Fiat:** Freemont 2012/...



Nº OE	Descripción/Description	Mat.	Ref.
05189956AA	Jgo. de juntas para motor	●	523000-R MLS
04884762A	Junta tapa cilindros Ø 89.0 ± 0.60	MLS	1 523008
	Jgo. de tornillos para tapa de cilindros		B523000
	Sellador líquido - caucho de silicona		TRN0085G
	Conj. junta tapa válvulas (2)	GS	1 523010
	Junta para cárter	NB	1 523011
04693346AB	Múltiple escape	AC	1 523015
04884883AA	Múltiple admisión	GS	1 523017
04884696AA	Salida bomba de agua	SLS	1 503027
04884703AA	Entrada de agua	SLS	1 523019
04884551AA	Junta cuerpo acelerador	GS	1 523031
1028A025	Filtro		523038
04884572AA	Adaptador salida de refrigerante	GS	1 523037
04884873AA	O´ring tubo entrada de agua G 32 x 4	GS	1
	O´ring G 7.52 x3.53	GS	4
	O´ring G 8.5 x 1.9	GS	
	O´ring G 15.54 x 2.62	GS	1
	O´ring G 20.30 x 2.62	GS	1
	Kit de retenes completo		R523000
2222425000	Jgo. retén válvulas (16)	V	1 R523010V
05047167AA	Retén bancada 85 x 103 x 8	P	1 R523011P
05047372AA	Retén distribucion 42 x 55 x 7	P	1 R523012P

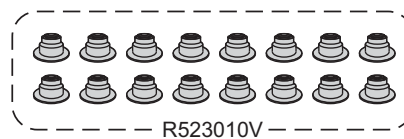
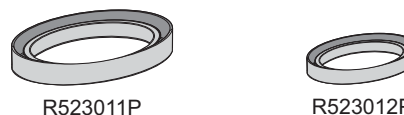
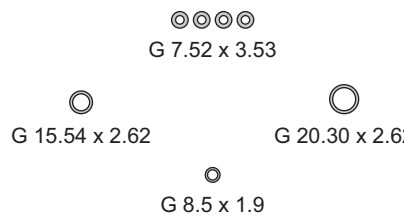
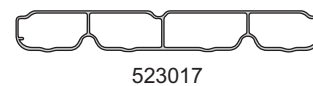
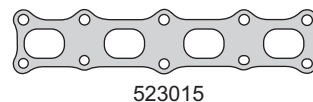
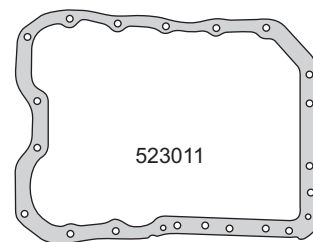
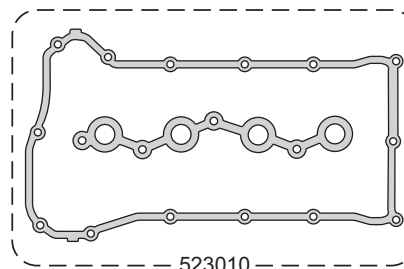
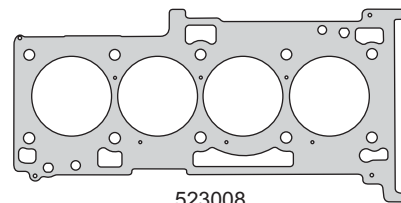



# DI TELLA



Motor/Engine	Cm³	HP	Ø
	1489		73.02
	1622		76.20

**Di Tella:** Morris - Riley - Traveller 1500 - Pick Up  
 Argenta 1500 - Magnette 1622  
 Morris 1650 - Magnette 1960/66



N° OE	Descripción/Description	Mat.	Ref.
48G 131	Jgo. de juntas para motor		210900
137541	Junta tapa cilindros Ø 80.4 ± 1.40	NFT	1 210905
137561	Junta tapa válvulas	CG	1 210910
137118	Jgo. junta para cárter (3)	CG	1 210911
137004	Tapa distribución	CG	1 210912
137044	Placa distribución	CB	1 210913
139516	Bomba de agua	NB	1 210914
140006	Múltiple admisión y escape	NFT	1 210916
	Entre múltiples	NFT	1 210917
137543	Codo base termostato	CB	1 210919
	Jgo. juntas carburador	VS	210920
	Base carburador	NB	1 210925
139007	Bomba aceite a block	NB	1 210927
	Base bomba nafta	NB	1 210928
139005	Bomba aceite a filtro	NB	1 210931
137544	Brida chica calef. block	NB	2 210932
	Brida grande calef. block	NB	1 210933
137014	Placa trasera distribución	CB	1 210934
138014	Tensor porta cadena	NB	1 210935
137053	Lateral tapa válvulas	CG	2 210936
137042	Arandela tapón cárter A 22 x 27 x 1 C	CU	1 210938
137093	Arandela bomba aceite A 13 x 18 x 1 C	CU	1 210939
120566	Palier	CB	210957
120552	Tapa diferencial	CG	210959
	Junta bancada cárter	CG	2 210980
	Jgo. retén válvulas (8)	P	R220110P
	Retén distribución 39.68 x 58.73 x 9.46	N	R210912N

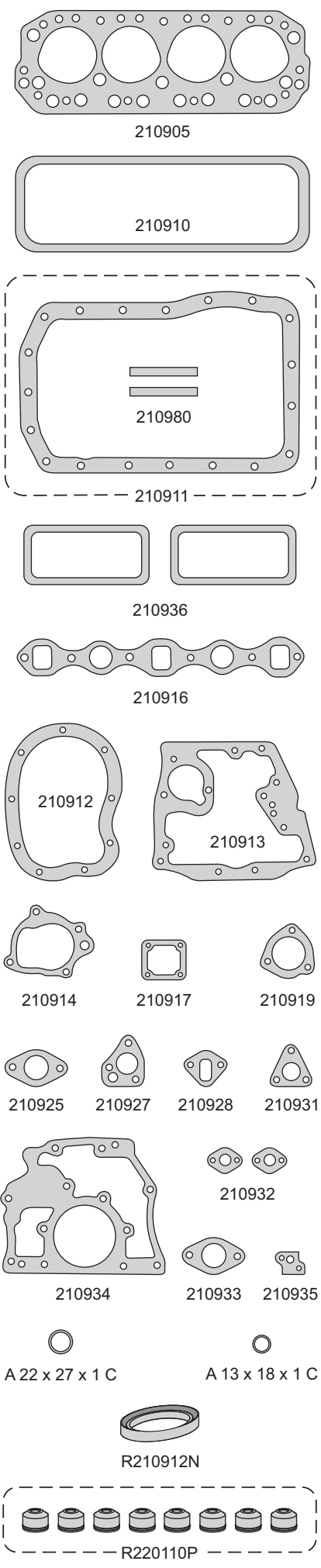

**DKW**



Motor/Engine	Cm³	HP	Ø
Wartburg	900	44	73.5
Wartburg	992	50	73.5

DKW: Graciela - Auto Unión 1000S  
1953/67



Nº OE	Descripción/Description	Mat.	Ref.
	Jgo. de juntas para motor		140000
	Junta tapa cilindros Ø 75 $\pm$ 1.40	NFT 1	140005
	Codo de agua	CG 1	140014
	Jgo. múltiple escape (3)	NFT 1	140016
6403163061	Múltiple admisión	NB 1	140017
	Jgo. juntas carburador	VS	140020
6403172711	Base carburador	NB 2	140025
6403122721	Tapa carburador	CB 1	140026
6403172881	Base bomba nafta	NB 1	140028
	Flotante tanque nafta	CG 1	140042
	Tapa lateral caja velocidades	CB 1	140051
	Tapa trasera caja velocidades	CB 1	140052
	Tapa hexagonal caja velocidades	CB 1	140053
	Tapón caja velocidades	NB 1	140054
	Directa caja velocidades	NB 1	140055
	Tapa diferencial	CB 1	140056

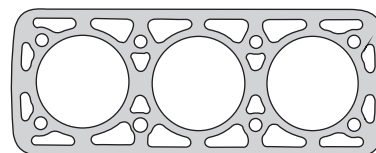

140005

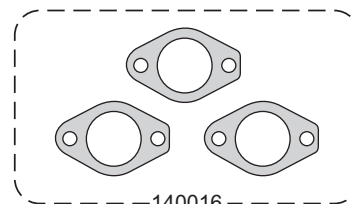

140014

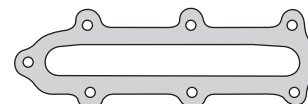

140016

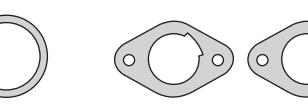

140017



140025

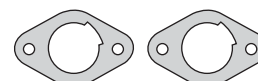

140020



140026



140028

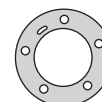

140042

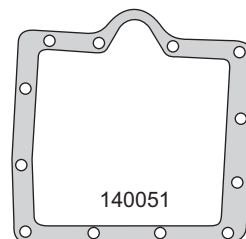

140051

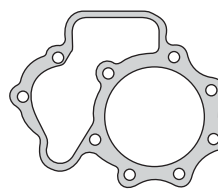

140052

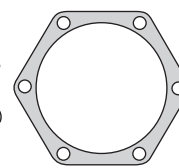

140053



140054



140055

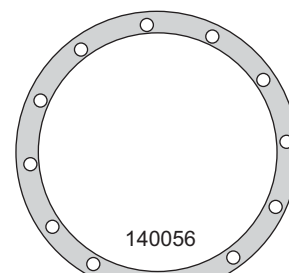









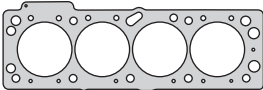



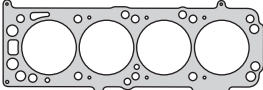



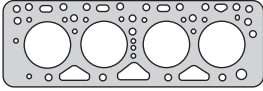

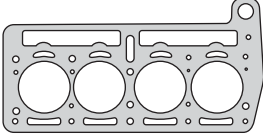

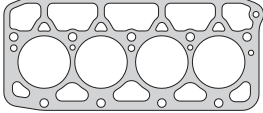

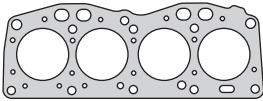
140056

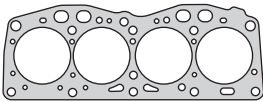
# FIAT / ALFA ROMEO / LANCIA

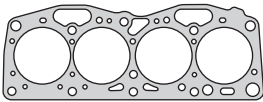
## JUNTA TAPA DE CILINDROS / HEAD GASKETS

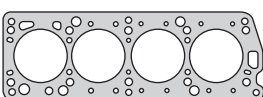









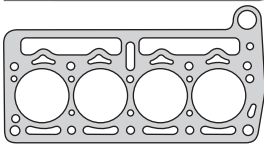

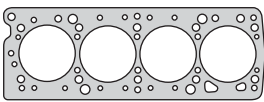

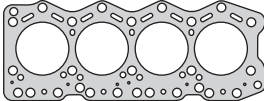

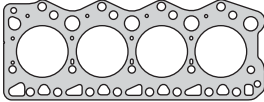

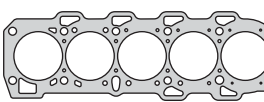

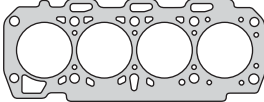
### MOTORES NAFTA Y DIESEL / PETROL AND DIESEL ENGINES

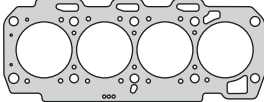
	Código Code	Q	≠	Kit Bulón Bolt Set	Aplicación Application	Motor Engine	Juego
<b>241807 - 241808</b> 	241807 241808	82.0 82.0	1.20 0.35	B280600  HAE12038	Palio Fase II 2004/...	1781cc. ALX 122HP 80.5 (DOHC) 16V	241800-R MLS  pág. 47
<b>222407</b> 	222407	85.0	1.20		Palio 2001/..., Siena 2002/...	1461cc. 178E5 84HP Ø83 (SOHC) 8V	
<b>242205 - 242207 - 242208</b> 	242205 242207 242208	82.0 82.0 82.0	1.40 1.40 1.40	B240400-1 B242200  HAE12038	Palio, Stilo, Palio Flex, Strada Siena Flex 2003/..., Idea Adventura HLX G2/G3 2006/... Stylo, Strada Working, Adventure, Palio 2003	1796cc. OHC-171190 - 17241C1 103HP G2/G3 105/110HP Ø80.5  1796cc. OHC 171190 102HP Ø80.5	252300-R MLS  pág. 176  242200-R MLS  pág. 51
<b>250005 - 250006</b> 	250005 250006	74.0 74.0	1.40 2.40		1100/103 1961/64	1089cc. 65HP Ø68.5	250000-R  pág. 157
<b>250105 - 250106</b> 	250105 250106	64.0 64.0	1.40 2.40	B250100  HAS13038	600 (E.R.D.), 770 Coupe 800 Spider 1962/76	767cc. 100D - 170R 32HP Ø62 (OHV) 8V	250100-R  pág. 158
<b>250205 - 250206</b> 	250205 250206	80.0 80.0	1.70 2.40	B250200  HAS19038	1500 Berlina, Familiar, Multicarga 1963/69 1600 Berlina, Coupe 1969/72	1481cc. 115C (OHV) 8V 72HP Ø77 1600cc. 115C (OHV) 8V 76HP Ø78	250200-R  pág. 159
<b>250405 - 250406 - 250407</b> 	250405 250406 240407	81.0 81.0 81.0	1.40 2.40 1.40	B250400  HAS19038	128, 147, Spazio, Brio, Ritmo 60 Strada 60 1971/...	1116cc. 128A 55/60HP Ø80 (SOHC) 8V	250400-R  pág. 160
<b>250505 - 250506 - 250507</b> 	250505 250506 240507	87.7 87.7 87.7	1.40 2.40 1.40	B250400  HAS19038	128, Europa, 147, Spazio 1971/81 Regata 70, Ritmo Strada 65, Uno 70 lava, TV, 147 Sorpasso Fiorino 1982/... Lancia Prisma 1983/..., Delta 1986/92 Ritmo Strada 75, Ritmo Strada 85 1978/82 Lancia Prisma, Delta 1978/81	1290cc. 128A1 73HP Ø86.4 1301cc. 138B2 68/70HP Ø86.4  1498cc. 138A2/4 75/85HP Ø86.4	250500-R  pág. 162
<b>250605 - 250606 - 250607</b> 	250605 250606 240607	87.0 87.0 87.0	1.70 2.40 1.70	B260200  HAS15038	128 Regatta '85, Ritmo 1986/90, Duna Uno, Super Europa 1983/... Elba, Premio, Fiorino Lancia Delta, Prisma 1986/...	1498cc. 138C3 75/85HP Ø86.4  831B1 80/82HP Ø86.4 (DOHC) 8V	250600-R  pág. 164
<b>250705 - 250706</b> 	250705 250706	81.0 81.0	1.40 2.40	B250700  HAS17038	125 (Bialbero), Berlina Sport Multicarga, Mirafiori 1972/74	1608cc. 125AB - 125A 110HP Ø80	250700-R  pág. 166

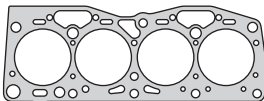
# FIAT / ALFA ROMEO / LANCIA

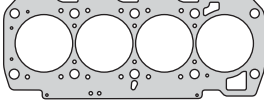
## JUNTA TAPA DE CILINDROS / HEAD GASKETS

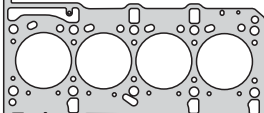
### MOTORES NAFTA Y DIESEL / PETROL AND DIESEL ENGINES

	Código Code	Q	≠	Kit Bulón Bolt Set	Aplicación Application	Motor Engine	Juego
	250805	66.0	1.40	B250800	133, Berlina de Lujo 1977/82, 850 850 Van 1965/76 Uno 45 1974/..., 127 Especial 1983/88	<b>843cc.</b> 100R/G 32/37HP Ø62.5 <b>903cc.</b> 146A 45HP Ø65 (OHV) 8V	<b>250800-R</b>  pág. 167
	250806	66.0	2.40	 HAS17038			
	250807	66.0	1.40	HAS17038			
	250905	85.0	1.70	B250700	Regata 100S 1985/...	<b>1585cc.</b> 149A 100HP Ø84 (SOHC) 8V	<b>250900-R</b>  pág. 168
	250907	85.0	1.70	 HAS17038			
	251107-SM	96.0	1.60	B251100	Ducato 14, Ducato 18 Maxi, Ducato 14D Ducato 18D Maxi 1998/...	<b>2799cc.</b> 8140.63 87/89HP Ø94.4 (SOHC) 8V Iny. Indirecta	<b>251101-R</b>  pág. 170
	251107-1M	96.0	1.70	 HAS17038			
	251107-2M	96.0	1.80	HAS17038			
	251407	95.0	1.40	B270100	Ducato TD 1985/... Iveco Daily TD 1985/89 Iveco Daily TD 1987/89	<b>2445cc.</b> 8140.21 92HP Ø93 <b>2499cc.</b> 8140.27 103HP Ø93 (SOHC) 8V	<b>251400-R</b>  pág. 172
				 HAS17038			
	251807-SM	83.0	1.70	B251800	Marea TD 1996/99 Lancia Kappa TD 1994/00	<b>2387cc.</b> 185A2 124HP Ø82 838A3 - 838A7 124HP Ø82	<b>251800-R</b>  pág. 172
	251807-1M	83.0	1.80	 HAR14063			
	251807-2M	83.0	1.95	HAR14063			
	252007-SM	83.0	1.40	B252000	Brava, Bravo TD 1996/99, Marengo TD Marea TD	<b>1910cc.</b> 182A8/A7 75/100HP Ø82 (SOHC) 8V	<b>252001-R</b>  pág. 174
	252007-1M	83.0	1.50	 HAR14063			
	252007-2M	83.0	1.60	HAR14063			
	252008-SM	83.0	1.35				
	252008-1M	83.0	1.45				
	252008-2M	83.0	1.55				
	252107-SM	83.0	1.60	B252000	Brava, Bravo TD, Multipla TD Marea TD 1998/...	<b>1910cc.</b> 182 B4 105HP Ø82 (SOHC) 8V	<b>252101-R</b>  pág. 175
	252107-1M	83.0	1.70	 HAR14063			
	252107-2M	83.0	1.80	HAR14063			
	252108-SM	83.0	1.60				
	252108-1M	83.0	1.70				
	252108-2M	83.0	1.80				
	252205	87.0	1.70		Regata 75 i.e., Ritmo 75 i.e. Uno 75 i.e. 1986/90, Fiorino i.e. 1988/93  Lancia Delta i.e., Prisma i.e. 1986/89 Delta, Prisma 1986/92	<b>1498cc.</b> 149A5 - 149C1 - 138C3 483C3 75HP Ø86.4 831B1 75/80HP M202 82HP Ø86.4	<b>252200-R</b>  pág. 175
	252207	87.0	1.70				
	252407-SM	83.0	0.85	B252000	Marea JTD 2000/02, Stilo JTD Idea JTD 2003/..., Punto 2003/... Palio JTD 2002/..., Strada	<b>1910cc.</b> 186 A6 110HP 192 A1/3 115HP 188 B2 80HP 182 B9 100HP Ø82 (SOHC) 8V	<b>252401-R</b>  pág. 177
	252407-1M	83.0	1.00	 HAR14063			
	252407-2M	83.0	1.20	HAR14063			
	252407-3M	83.0	1.30	HAR14063			
	252408-SM	83.0	0.82				
	252408-1M	83.0	0.92				
	252408-2M	83.0	1.02				
	252508	70.5	0.70	B252500	Palio, Panda JTDM, Siena JTD 2002/... Idea JTD 2004/..., Cinquecento 500 Fiorino JTDM 2007/..., 500 JTD 2009/... Lancia Musa JTD 2004/... Ypsilon JTD 2004/...	<b>1248cc.</b> 188A9 - 196A1/A2 - 199B1 70/75/95HP Ø69.6 188A9 69HP 199A2 75HP (DOHC) 16V Ø69.6	<b>252500-R</b>  pág. 177

# FIAT / ALFA ROMEO / LANCIA

## JUNTA TAPA DE CILINDROS / HEAD GASKETS

### MOTORES NAFTA Y DIESEL / PETROL AND DIESEL ENGINES

	Código Code	Q	$\approx$	Kit Bulón Bolt Set	Aplicación Application	Motor Engine	Juego	
	252608-SM	83.0	0.80	B252600	Stilo JTD 2001/... - Bravo JTD 2007/...	<b>1910cc.</b> 937A5 150HP Ø82 192B1/A5-937A4/A5 140HP 937A5 140/150HP 937A6 170HP Ø82 (DOHC) 16V		
	252608-1M	83.0	0.90	HAR14063	Alfa 147 JTD 2000/..., 156JTD 2001/...			
	252608-2M	83.0	1.00		<b>DIESEL</b>			
	252707-1M	100.0	1.30		Daily, 40 S14, 3.0 HPI, Euro III TD 55 C16, 3.0 HPI, Euro III TD 2008/...	<b>2998cc.</b> 8210 - 42E2 - F1CE 0481 136/155HP Ø95.8 (DOHC) 16V	<b>252701-R</b> pág. 178	
	252707-2M	100.0	1.40					<b>DIESEL</b>
	252707-3M	100.0	1.50					
	252708-1M	96.8	1.20					
	252708-2M	96.8	1.30					
	252708-3M	96.8	1.40					
	252808-1M	89.0	1.10	B252800	Ducato JTD 2002/... - 2006/... Iveco Cargo, Maxicargo, Furgon Multijet 2010/...	<b>2286cc.</b> F1AE 110/120/127HP Ø88 (DOHC) 16V	<b>252801-R</b> pág. 180	
	252808-2M	89.0	1.20	HAE14038				<b>DIESEL</b>
	252808-3M	89.0	1.30	HAE18038				
	253007-SM	84.0	1.20	B253000	Toro 2016/...	<b>1956cc.</b> Multijet TD 170HP Ø83 (DOHC) 16V	<b>253001-R</b> pág. 183	
	253007-1M	84.0	1.30	HAR12063				<b>DIESEL</b>
	253007-2M	84.0	1.40					
	253008-SM	84.0	0.95					
	253008-1M	84.0	1.05					
	253008-2M	84.0	1.15					
	260005-1M	77.0	1.85	B260000	147, Duna, Fiorino, Spazio, Uno 1985/...	<b>1301cc.</b> 4TD - 146B 45HP Ø76.1 (SOHC) 8V	<b>260001-R</b> pág. 184	
	260005-2M	77.0	1.95	HAS13038				<b>DIESEL</b>
	260005-3M	77.0	2.30					
	260007-SM	77.0	1.60					
	260007-1M	77.0	1.80	HAS17038				
	260007-2M	77.0	1.95					
	260007-3M	77.0	2.20					
	260105	85.0	1.70	B260100	Tempra, Tipo 1992/95 Lancia Delta, Dedra 1993/99 Regatta 2000, Bialbero, Tempra 1989/... Lancia Thema, Delta Turbo 1987/94	<b>1756cc.</b> 835C 105HP Ø84 <b>1987cc.</b> 154C 90/110HP Ø84 831C 177HP - 834B 115HP (DOHC) 8V Ø84	<b>260100-R</b> pág. 185	
	260107	85.0	1.70	HAR12063				
	260105	85.0	1.70	B260100	Tempra 1992/..., Tipo i.e. 1989/93 Croma i.e 1993/..., Coupe i.e Turbo 1994/...	<b>1995cc.</b> 160A/154E/836 126/140/145HP ACT (DOHC) 16V Ø84	<b>260600-R</b> pág. 190	
	260107	85.0	1.70	HAR12063				
	260105	85.0	1.70	B260100	Tempra i.e, Tipo i.e, Croma i.e Croma i.e Turbo 1992/95	<b>1995cc.</b> 154C4/A6 - 834B 115/153HP ACT (DOHC) 8V Ø84	<b>260800-R</b> pág. 192	
	260107	85.0	1.70	HAR12063				
	260205	82.0	1.70	B260200	Spazio, Duna, Tipo, Uno, Vivace, Palio Siena 1988/91, Fiorino 1993/95	<b>1372cc.</b> 160A1 71HP 146C1/5 67/72HP 159A2 78HP Ø80.5	<b>260200-R</b> pág. 186	
	260206	82.0	2.40	HAS15038				
	260207	82.0	1.65					
	260208	82.0	1.60					
	260305	88.0	1.70	B260200	Duna, Uno, Regatta, Palio, Siena Premio, Elba, Tipo, Fiorino 1988/... Lancia Dedra 1989/93	<b>1581cc.</b> Sevel 84/88HP - 146C6 75HP 159A3 76/78HP - 160A2 82HP 835A 80/90HP Ø86.4 (SOHC) 8V Ø86.4	<b>260300-R</b> pág. 187	
	260306	88.0	2.40	HAS15038				
	260307	88.0	1.70					
	260308	88.0	1.60					

# FIAT / ALFA ROMEO / LANCIA

## JUNTA TAPA DE CILINDROS / HEAD GASKETS



### MOTORES NAFTA Y DIESEL / PETROL AND DIESEL ENGINES

	Código Code	Q	≠	Kit Bulón Bolt Set	Aplicación Application	Motor Engine	Juego
	<b>260405 - 260407</b>						
	260405-1M	84.0	1.85	B260400	Duna, Uno, Regatta, Fiorino 1985/...	<b>1697cc.</b> 149B - 146B 60HP Ø82.6 831D 65HP Ø82.6 (SOHC) 8V	<b>260401-R</b> 🚗 pág. 188
	260405-2M	84.0	1.95	🔩 HAR12063	Lancia Prisma 1986/91		
	260405-3M	84.0	2.30				
	260407-SM	84.0	1.70				
	260407-1M	84.0	1.80				
	260407-2M	84.0	1.95				
260407-3M	84.0	2.20					
	<b>260505</b>						
	260505	77.0	1.40	B260500	147, Oggi, Panorama, Uno, Premio Trend	<b>1049cc.</b> 127AB 206 60/70HP Ø76 <b>1300cc.</b> 127AB 2C 60/70HP Ø76 (OHV) 8V	<b>260500-R</b> 🚗 pág. 189
	<b>260705 - 260707</b>						
	260705	77.0	1.80	B260500	Uno Mille, Palio, Siena 1983/...	<b>994cc.</b> 146B 48/61HP Ø76 (SOHC) 8V	<b>260700-R</b> 🚗 pág. 191
260707	77.0	1.90	🔩 HAS17038				
	<b>260705 - 260707</b>						
	260705	77.0	1.80	B260500	Palio 1.0 ED/EDX MPI 96	<b>994cc.</b> ED/EDX MPI 48/61HP Ø76 <b>1495cc.</b> EL MPI 76HP Ø76 (SOHC) 8V	<b>270200-R</b> 🚗 pág. 199
260707	77.0	1.90	🔩 HAS17038	Palio 1.5 EL MPI 96			
	<b>260905 - 260907</b>						
	260905	87.0	1.80	B260900	Palio, Siena, Tipo, Bravo, Marea	<b>1581cc.</b> 182A4 - 182A6 - 186A3 186A4 103HP Ø86.4 (DOHC) 16V	<b>260900-R</b> 🚗 pág. 193
260907	87.0	1.80	🔩 HAR10168	Multipla 1999/... Lancia Delta, Dedra, Lybra 1996/...			
	<b>261107 - 261108</b>						
	261107	82.0	1.20	B260900	Palio, Siena, Marea, Multipla 2001/...	<b>1596cc.</b> 182B6 - 178E7 103HP Ø77 (DOHC) 16V	<b>261100-R MLS</b> 🚗 pág. 194
261108	81.5	0.40	🔩 HAR10168				
	<b>270007</b>						
	270007-SM	84.0	1.70	B260400	Fiorino, Uno, Tipo, Palio, Ducato D/TD	<b>1697cc.</b> 149B - 176A 58/69HP Ø82.6 <b>1929cc.</b> 160D - 280A1 65/90HP Ø82.6 675.01 - 336.01 90HP Ø82.6 (SOHC) 8V	<b>260401-R</b> (270000) 🚗 pág. 195
	270007-1M	84.0	1.80	🔩 HAR12063	Tipo, Tempra, Palio, Siena TD		
	270007-2M	84.0	1.95		Lancia Delta, Dedra TD 1994/99		
	270007-3M	84.0	2.10		Alfa Romeo 146 TD 1994/99 155 TD 1993/97		
			DIESEL				
	<b>270008</b>						
	270008-SM	83.5	1.65	B260400	Fiorino, Uno, Tipo, Palio, Ducato D/TD	<b>1697cc.</b> 149B - 176A 58/69HP Ø82.6 <b>1929cc.</b> 160D - 280A1 65/90HP Ø82.6 675.01 - 336.01 90HP Ø82.6 (SOHC) 8V	<b>260401-R</b> (270000) 🚗 pág. 195
	270008-1M	83.5	1.75	🔩 HAR12063	Tipo, Tempra, Palio, Siena TD		
	270008-2M	83.5	1.85		Lancia Delta, Dedra TD 1994/99		
	270008-3M	83.5	1.95		Alfa Romeo 146 TD 1994/99 155 TD 1993/97		
			DIESEL				
	<b>270107</b>						
	270107-SM	96.0	1.30	B270100	Ducato TD 1990/94, Ducato TDS 1994/96	<b>2499cc.</b> 8140.27/47R 103/110HP 8140.47.X230 116HP Ø93	<b>270100-R</b> <b>270101-R</b> 🚗 pág. 197
	270107-1M	96.0	1.40	🔩 HAS17038	Ducato TDSE 1996/...		
	270107-2M	96.0	1.50		Iveco Daily Turbo 1990/...		
	270107-3M	96.0	1.60		DIESEL		
	<b>270107</b>						
	270107-SM	96.0	1.30	B270100	Ducato 14TDS, Ducato Maxi 18TDS	<b>2799cc.</b> 8140.43 122HP Ø94.4 (SOHC) 8V	<b>270300-R</b> <b>270301-R</b> 🚗 pág. 200
	270107-1M	96.0	1.40	🔩 HAS17038	1996/...		
	270107-2M	96.0	1.50		DIESEL		
	270107-3M	96.0	1.60				

# FIAT / ALFA ROMEO / LANCIA

## JUNTA TAPA DE CILINDROS / HEAD GASKETS

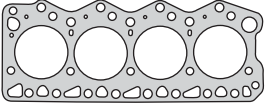
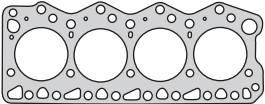
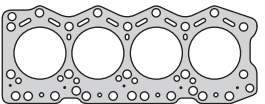
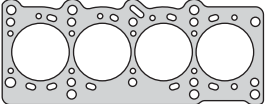
### MOTORES NAFTA Y DIESEL / PETROL AND DIESEL ENGINES

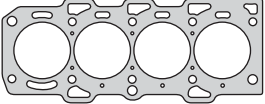
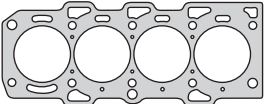
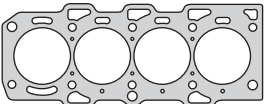
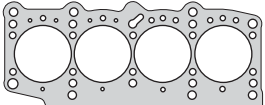
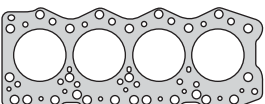
	Código Code	Q	≠	Kit Bulón Bolt Set	Aplicación Application	Motor Engine	Juego
	270107 270107-SM 270107-1M 270107-2M 270107-3M	96.0 96.0 96.0 96.0	1.30 1.40 1.50 1.60	B270100 HAS17038	Ducato JTD 2006/09 Iveco Daily 35.13, 35.13 4x4, 38.13 40.13, 50.13, 60.13, 70.13 2005/10 <b>DIESEL</b>	2799cc. 8140.43S Euro III Common Rail (SOHC) 8V 122/125HP Ø94.4	252901-R pág. 181
	270107 270107-SM 270107-1M 270107-2M 270107-3M	96.0 96.0 96.0 96.0	1.30 1.40 1.50 1.60	B270100 HAS17038	Turbo Daily 35.10 - 49.12 1996/... 45.10 - 49.10 - 40.10 - Turbo Daily 49.12 60.12 Intercooler <b>DIESEL</b>	2798cc. 8140.23 - 8140.43 99/122HP Ø94.4 (SOHC) 8V	271101-R pág. 208
	270407 270407-1M 270407-2M	95.0 95.0 95.0	1.70 1.50 1.60	B270100 HAS17038	Nuovo Ducato 1989/94  Ducato 1994/... Iveco Daily 30.8 - 35.8 1996/... <b>DIESEL</b>	2445cc. 8140.67 55HP Ø93 2499cc. 8140.67X230 85HP Ø93 2499cc.8140.67F37 82HP Ø93 (SOHC) 8V	270400-R 270401-R pág. 202
	270505 - 270507 - 270508 270505 270507 270507-1.9 270508	72.0 72.0 72.0 72.0	1.20 1.20 1.95 0.40	B270500 HAS13038	Uno, Palio, Siena, Mille Fire	999cc. Fire MPI 50HP Ø70 1300cc. Fire MPI 75HP Ø70.8 (SOHC) 8V	270500-R pág. 204
	270505 - 270507 - 270508 270505 270507 270507-1.9 270508	72.0 72.0 72.0 72.0	1.20 1.20 1.95 0.40	B270500 HAS13038	Uno 1994/00 Panda 1986/..., Uno 1989/95 - 1998/... Panda 1995/96, Palio 2001/...  Punto 60 Cabrio, Palio 75, Siena 1995/... Punto 60, Punto Selecta 1993/99 Lancia Ypsilon 1996/00	994cc.146A2 48HP Ø70 999cc.156A2/A3 30/45HP Ø70 1108cc.176B2/178B9 54HP  1242cc. 176B4/176B1/176A7 60HP 178B5 73HP Ø70.8	251000-R pág. 169  251700-R pág. 173
	270607 270607	84.0	1.70	B270600 HAR14063	Alfa Romeo 145/146/155/156 Twin Spark 16V 1996/... 145 Twin Spark 1996/...	1598cc. 676.01 120HP Ø82 1747cc. 671.06/99 - 322.01 140/144HP Ø82 (DOHC) 16V	270600-R pág. 205
	270607 270607	84.0	1.70	B270600 HAR14063	Alfa Romeo 145/146 Twin Spark 1996/... 156 Twin Spark 1997/... 145/146/156 Twin Spark 1997/... GTV Twin Spark, Spider 1998/00	1598cc. 321.02 - 676.01 120HP Ø82 1747cc. 322.01 144HP Ø82 (DOHC) 16V	271800-R pág. 213
	270607 270607	84.0	1.70	B270600 HAR14063	Fiat Marea 1996/..., Brava Bravo 1995/...	1747cc. 182A2 (DOHC) 16V 113HP Ø82	272300-R pág. 218
	270705 - 270707 - 270708 270705 270707 270708	72.0 72.0 72.0	1.20 1.20 0.40	B270700	Palio, Siena, Palio Weekend Palio Novo, Novo Siena, Doblo Lancia Ypsilon 2000/...	999cc. Fire 1714130 70HP Ø71 1242cc. Fire 188.A5 80HP Ø71 (DOHC) 16V	270700-R pág. 206
	270807 270807	95.0	1.70	B270100 HAS17038	131/132 1978/..., Argenta 1981/..., Ducato 1981/89 - Iveco Daily 1979/... <b>DIESEL</b>	2445cc. 8144.61 53HP Ø93	

# FIAT / ALFA ROMEO / LANCIA

## JUNTA TAPA DE CILINDROS / HEAD GASKETS

### MOTORES NAFTA Y DIESEL / PETROL AND DIESEL ENGINES

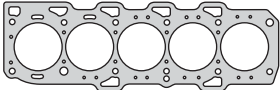
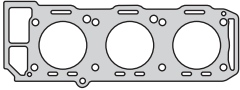
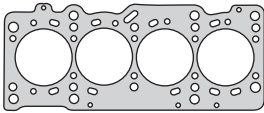
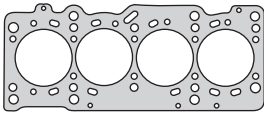
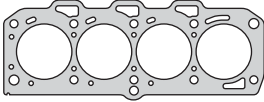
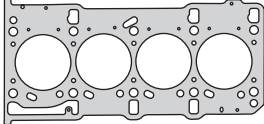
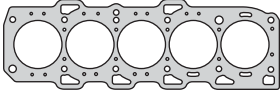
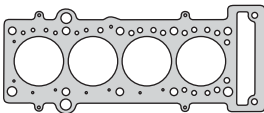
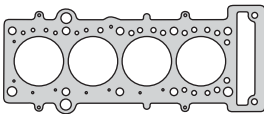
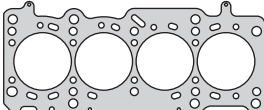
	Código Code	Q	≠	Kit Bulón Bolt Set	Aplicación Application	Motor Engine	Juego
	<b>270907</b>	83.0	1.80	<b>B270900</b> HAR10168	Marea 1996/98 - 1998/... , Coupe 1996/01 Bravo 1995/98  Bravo, Coupe, Marea 1998/01 Lancia Kappa 1994/01	<b>1998cc.</b> 182A1 147HP - 182B3/B7 147/155HP Ø82 (DOHC) 20V  <b>1998cc.</b> 182B7 - 182B3 155HP Ø82 (DOHC) 20V	<b>270900-R</b> 🚗 pág. 207  <b>271300-R</b> 🚗 pág. 211
	<b>271007</b>	95.0	1.70		Alfa Romeo 166 1998/00 - 2000/... GTV 1996/00 - 2001/..., Spider 2001/...  147, GTV 2003/...	<b>2959cc.</b> 361.01 220HP - 161.05 218HP 161.02 - 343.01 226HP Ø93 <b>3179cc.</b> 932A 250HP - 936A6 240HP Ø93	
	<b>271205 - 271207 - 271208</b>	73.0 73.0 72.5	1.20 1.20 0.40	<b>B270500</b> HAS13038	Palio, Siena, Strada  Mobi BZ 2016/... Fiorino XMF 2016/18	<b>1368cc.</b> Fire 80/81HP Ø72 (SOHC) 8V  <b>1242cc.</b> Fire 70HP Ø72 <b>1368cc.</b> Fire Evo 80HP Ø72 (SOHC) 8V	<b>271200-R MLS</b> 🚗 pág. 210  <b>273600-R</b> 🚗 pág. 227
	<b>271205 - 271207 - 271208</b>	73.0 73.0 72.5	1.20 1.20 0.40	<b>B270500</b> HAS13038	Fire 1.3, Fiorino, 500 2007/...  Fire 1.4 ELX, Evo 2010/..., Idea 2003/... Palio Fase II/III 2007/13, Strada Fase III Siena Gen. III MPI 2002/... Grande Punto 2005/..., Linea 2007/... Lancia Musa 2004/...	<b>1242cc.</b> 350 A1 70HP Ø72 <b>1368cc.</b> 169 A4 77/80/82HP Ø72 (SOHC) 8V	<b>271900-R</b> 🚗 pág. 214
	<b>271407</b>	89.0	0.70	<b>B271400</b> HAR12063	Bravo 1995/..., Marea 1996/00 Lancia Ypsilon 1995/01	<b>1370cc.</b> 182 A3 - 840 A2 80HP Ø82 (SOHC) 12V	
	<b>271507 - 271508</b>	72.0 72.0 72.0 71.0 71.0 71.0	1.20 1.30 1.40 0.70 0.80 0.90	<b>B271500</b> HAR12063	Punto ELX JTD 2003/... Strada Trekking Fase III JTD 2010/... <b>DIESEL</b>	<b>1248cc.</b> 188A9 70HP Ø69.6 (DOHC) 16V	<b>271500-R MLS</b> 🚗 pág. 212
	<b>271707</b>	84.0	1.80	<b>B270900</b> HAR10168	Marea 1991/...  Lancia Kappa, Kappa Coupe 1998/...	<b>2445cc.</b> 160HP Ø83 <b>2445cc.</b> 838B2 175HP Ø83	
	<b>272007 - 272008</b>	78.0 78.0	1.20 0.60	<b>B272000</b> HAS15038	Idea Essence, Idea Sporting Idea Adventure, Siena Fase III Essence Strada Fase III/IV Adventure Palio Wend Fase III/IV Adventure Adventure 2010/..., Punto Essence 2011/...	<b>1598cc.</b> E.torQ 178D20.11 - 178D22.11 115HP Ø77(SOHC) 16V	<b>272000-R MLS</b> 🚗 pág. 215
	<b>272105 - 272107 - 272108</b>	82.5 82.5 82.0	1.20 1.20 0.60	<b>B272000</b> HAS15038	Punto, Idea, Linea 2011/..	<b>1747cc.</b> E-TorQ 130HP Ø81 (SOHC) 16V	<b>272100-R MLS</b> 🚗 pág. 216
	<b>272205 - 272207 - 272208</b>	72.0 72.0 72.5	1.40 1.20 0.60	<b>B270500</b> HAS13038	Palio, Siena Generación III Uno Fase II 2010/...	<b>999cc.</b> Fire EVO 73/75HP Ø70 (SOHC) 8V	<b>272200-R MLS</b> 🚗 pág. 217



# FIAT / ALFA ROMEO / LANCIA

## JUNTA TAPA DE CILINDROS / HEAD GASKETS











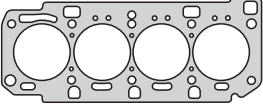
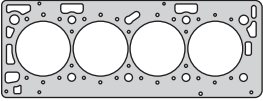

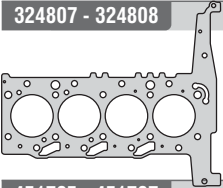

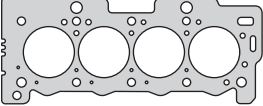

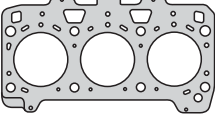

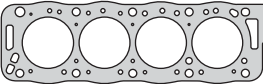
### MOTORES NAFTA Y DIESEL / PETROL AND DIESEL ENGINES

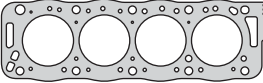
	Código Code	Q	$\neq$	Kit Bulón Bolt Set	Aplicación Application	Motor Engine	Juego
	<b>272407 - 272408</b> 272407 272408	73.0 73.0	1.30 0.60	B270700	500, Punto, Bravo, Doblo Punto T-Jet 2009/...	<b>1368cc.</b> 198A4/199A8/955A6/A8 105HP Ø72 (DOHC) 16V	<b>272400-R MLS</b> 🚗 pág. 219
	<b>272507 - 272508</b> 272507 272508	73.0 73.0	1.20 0.45	B270700	Palio 2002/..., Siena 2005/... Punto 2003/..., Idea, Stilo 2004/... Doblo 2010/... Lancia Ypsilon 2003/...	<b>1242cc.</b> 178D7 80HP Ø72 <b>1368cc.</b> 183A1/192B2 95HP Ø72 (DOHC) 16V	<b>272500-R MLS</b> 🚗 pág. 220
	<b>272607 - 272608</b> 272607 272608	78.0 78.0	1.20 0.60	B272000 🚗 HAS15038	Grand Siena 2012/..., Idea 2011/16 Palio 2012/..., Punto 2013/17 Strada 2013/... Grand Siena 2012/..., Idea 2011/16 Palio 2012/..., Punto 2013/17 Strada 2013/...	<b>1598cc.</b> E.torq 115/117HP Ø77 (SOHC) 16V <b>1747cc.</b> E.torq 130HP Ø77 (SOHC) 16V	<b>272600-R MLS</b> 🚗 pág. 221
	<b>272607 - 272608</b> 272607 272608	78.0 78.0	1.20 0.60	B272000 🚗 HAS15038	Tipo 2017/...	<b>1598cc.</b> E.torq Evo 110HP Ø76	<b>273500-R MLS</b> 🚗 pág. 226
	<b>272705 - 272707 - 272708</b> 272705 272707 272708	82.5 82.5 82.5	1.40 1.20 0.60	B272000 🚗 HAS15038	Argo, Bravo 2011/16, Doblo 2010/..., Idea 2011/16, Linea 2009/16, Palio, Strada 2013/..., Punto 2013/17	<b>1747cc.</b> E.torq 135/139HP Ø80.5 (SOHC) 16V	<b>272700-R MLS</b> 🚗 pág. 222
	<b>272705 - 272707 - 272708</b> 272705 272707 272708	82.5 82.5 82.5	1.40 1.20 0.60	B272000 🚗 HAS15038	Argo, Cronos 2017/...	<b>1747cc.</b> E.torq Evo 130HP Ø80.5	<b>273700-R MLS</b> 🚗 pág. 228
	<b>272807</b> 272807	88.0	1.20	B260900 🚗 HAR10168	Linea 2008/15	<b>1896cc.</b> 310A4011 130/132HP Ø86 Torque 16V	<b>272800-R</b> 🚗 pág. 223
	<b>272907</b> 272907 272908	72.0 71.0	1.20 0.60		Argo, Mobi, Uno 2018/...	<b>999cc.</b> Firefly 77HP Ø70 (SOHC) 6V	<b>272900-R MLS</b> 🚗 pág. 224
	<b>273007</b> 273007 273008	72.0 70.5	1.20 0.60		Argo, Cronos 2018/...	<b>1332cc.</b> Firefly 99HP Ø70 (SOHC) 8V	<b>273000-R MLS</b> 🚗 pág. 225
	<b>273808</b> 273808	82.5	0.65	B273800	500 2009/... - 2012/... Panda 2012/... - 2015/...	<b>875cc.</b> 312A2/A5 80/86H 312A7 78HP 199B6 105HP (SOHC) 6V Ø80.5	

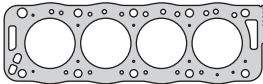
# FIAT / ALFA ROMEO / LANCIA

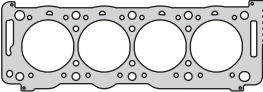
## JUNTA TAPA DE CILINDROS / HEAD GASKETS

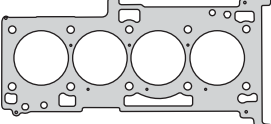
### MOTORES NAFTA Y DIESEL / PETROL AND DIESEL ENGINES

	Código Code	Q	≠	Kit Bulón Bolt Set	Aplicación Application	Motor Engine	Juego
	273908	84.0	0.60	B273900	Alfa 159, Spider Turbo 2009/... Lancia Delta 2009/...	1742cc. 939B1 200HP Ø83 (DOHC) 16V	
	291007 291008	82.0 82.0	1.20 0.60	B280600  HAE1238	Croma 2005/...	1796cc. 939A4 140HP Ø80,5 (DOHC) 16V	291000-R MLS  pág. 101
	324807-1M 324807-2M 324807-3M 324808-1M 324808-2M 324808-3M	87.1 87.1 87.1 87.1 87.1 87.1	1.20 1.25 1.30 1.10 1.15 1.20	B324800  HAS13038 HAS17038	Ducato 2006/... <b>DIESEL</b>	2198cc. 4HU 101HP Ø86	324801-R  pág. 326
	451705 451707	76.0 76.0	1.30 1.30	B470500  HAE14038	Qubo, Fiorino Qubo	1360cc. 75HP Ø75	452200-R  pág. 415
	452308	89.0	0.70	B452300  HAE14038	Ulysse 2002/... Lancia Phedra 2002/...	2946cc. ES9J4S (XFW) 204/207HP Ø87 (DOHC) V6 24V	
	460907-1M 460907-2M 460907-3M	84.0 84.0 84.0	1.50 1.60 1.70	B460900  HAT55055 HAT55100	Ducato TD 1994/... Scudo TD 1995/01 <b>DIESEL</b>	1905cc. D8B/DHX 92HP Ø83	460301-R (460900)  pág. 424
	460908-1M 460908-2M 460908-3M 460908-4M 460908-5M	84.0 84.0 84.0 84.0 84.0	1.34 1.38 1.42 1.50 1.55	B460900  HAT55055 HAT55100	Ducato TD 1994/... Scudo TD 1995/01 <b>DIESEL</b>	1905cc. D8B/DHX 92HP Ø83	460301-R (460900)  pág. 424
	461307-1M 461307-2M 461307-3M 461307-4M 461307-5M	84.0 84.0 84.0 84.0 84.0	1.36 1.40 1.44 1.48 1.52	B460300  HAT55055 HAT55100	Escudo, Ducato 1994/01 <b>DIESEL</b>	1905cc. D9B/DJY 68/69HP Ø83	
	461508-1M 461508-2M 461508-3M 461508-4M 461508-5M 461508-SM	85.0 85.0 85.0 85.0 85.0 85.0	1.52 1.57 1.62 1.67 1.72 1.77	B461500  HAE14038	Ulysse TD 1996/99 Lancia Zeta TD 1996/00 <b>DIESEL</b>	2088cc. P8C (XUD11ATE/L) 12V 109HP Ø86	461501-R  pág. 427
	523008	89.0	0.50	B523000	Freemont 2012/...	2360cc. ED3 - GEMA 170/174HP Ø88 (DOHC) 16V	523000-R MLS  pág. 146

**FIAT**



Motor/Engine	Cm³	HP	Ø
	1089	65	68.5

Fiat: 1100/103 1961/64



Nº OE	Descripción/Description	Mat.	Ref.
	Jgo. de juntas para motor		250000-R
4015455	Junta tapa cilindros Ø 74.0 ± 1.40	NFT 1	250005
4015455	Junta tapa cilindros Ø 74.0 ± 2.40	NFT	250006
859472	Junta tapa válvulas	CG 1	250010
869695	Junta para cárter	CG 1	250011
367200	Tapa distribución	CB 1	250012
367198	Placa distribución	CB 1	250013
853240	Tapa bomba de agua	NB 1	250014
4015881	Múltiple admisión y escape	NFT 1	250016
860639	Salida de escape	FCH 1	250018
367185	Termostato	CB 1	250019
	Jgo. juntas carburador SOLEX E 32/35	VS	250020
	Jgo. juntas carburador WEBER 28/32/36	VS	250220
	Jgo. juntas carburador SOLEX 32 PBIC	VS	250221
	Base carburador	NB 1	250025
810874	Base bomba nafta	NB 1	250028
869808	Acople bancada cigüeñal	NB 1	250031
869027	Filtro aceite a block	NB 1	250032
367316	Brida bomba aceite	NB 1	250033
374464	Tapa descarga bomba aceite	NB 1	250034
815416	Tubo bomba aceite base	NB 1	250035
367188	Tapa válvulas lateral	CG 1	250036
853701	Salida bomba agua	NB 1	250037
	Brida toma aire	NB 1	250038
	Jgo. juntas caja velocidades	VS	250050
	Tapa diferencial	CB	250059
	Kit de retenes completo		R250000
40004350	Retén bancada 64 x 80 x 8	N 1	R250111N
	Retén distribución 40 x 60 x 10	N 1	R250012N

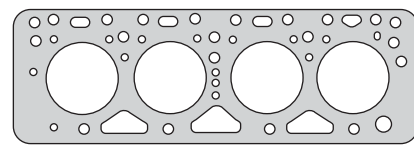

250005

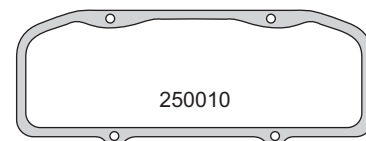

250010

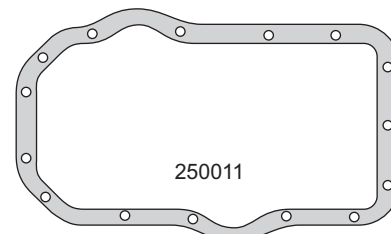

250011



250036



250016

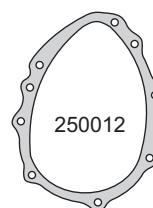

250012

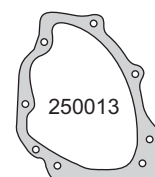

250013



250014



250018



250019

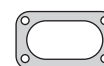

250025



250028



250031



250032



250033



250034



250035



250037



250038



R250012N



R250111N

FIAT



Motor/Engine	Cm³	HP	Ø
100D - 170R (OHV) 8V	767	32	62

Fiat: 600 (E.R.D), 770 Coupe  
800 Spider 1962/76



Nº OE	Descripción/Description	Mat.	Ref.
	Jgo. de juntas para motor		250100-R
	Jgo. de juntas superior	●	250195
4064640	Junta tapa cilindros Ø 64.0 ± 1.40	NFT 1 1	250105
4064640	Junta tapa cilindros Ø 64.0 ± 2.40	NFT	250106
	Jgo. tornillos tapa cilindros (HAS13038)		B250100
4117850	Junta tapa válvulas	CG 1 1	250110
	Jgo. junta para cárter (4)	CG	250111
4107391	Tapa distribución	NB	250112
4065244	Tapa bomba de agua	NB	250114
4135158	Múltiple admisión y escape	FCH	250115
4135158	Múltiple admisión y escape	NFT 1 1	250116
876075	Salida de escape	FCH 1 1	250118
	Bomba de agua a block	NB	250119
400425	Jgo. juntas carburador WEBER 28 ICP	VS	250120
	Jgo. juntas carburador HOLLEY 1975/76	VS	250121
	Jgo. juntas carburador WEBER 30-ICF-19	VS	250122
	Jgo. juntas carburador BRESSEL y GALILEO	VS	250123
4121933	Base superior carburador	NB 1 1	250125
4100576	Entre carburador y múltiple	NB 1	250825
9910788	Tapa carburador	CB	250126
881452	Superior bomba aceite	NB	250127
4081258	Base bomba nafta 0,8	NB	250128
4052518	Brida bomba aceite	NB 1	250129
4057986	Inferior caño bomba aceite	NB	250130
4064079	Base intermedia carburador Weber 28 IEP	NB 1	250131
4064078	Base inferior carburador Weber 28 IEP	NB 1	250132
883831	Base filtro aceite a block	NB	250133
97050117	Termostato	CB 1 1	250135
4172904	Porta retén bancada trasera	NB	250136
1/02795/60	Tapa tubo entrada aceite	CG	250137
9904841	Vaso filtro nafta	CG	250138
987112	O'ring balanceador armónico G 101 x 4.3	GS	250140
4065247	Base termostato	NB 1 1	250141
1458.030	Junta vaso de nafta	CG	450041
	Porta aro cigüeñal	NB	250142
	Base carburador a múltiple Holley Web.600R	NB 1 1	250143
	Base bomba nafta 0.5	NB	250144
	Soporte caño escape	AC	250145
	Jgo. juntas caja velocidades	VS	250150
	Palier	CB	250154
4117850	Jgo. juntas para cárter	CG	250160
	Tapa válvulas	CG	250161
	Suplemento tapa cilindros	AL	250185
	Junta tapa cilindros competición (0.30)	CU	250190-0.30
	Junta tapa cilindros competición (0.60)	NFT	250190-0.60
	Junta tapa cilindros competición (0.80)	NFT	250190-0.80
	Kit de retenes completo		R250100
	Jgo. retén válvulas (8)	P	1 R250110P
40004350	Retén bancada 64 x 80 x 8	N	1 R250111N
	Retén distribución 42 x 56 x 7	N	1 R250112N

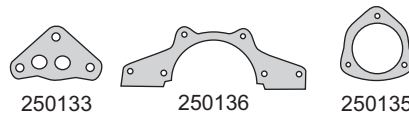
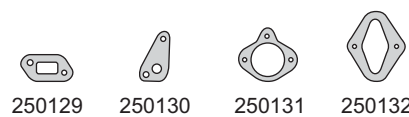
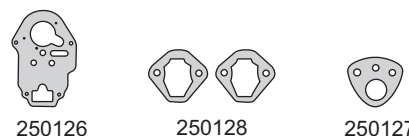
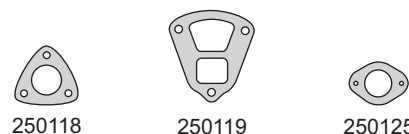
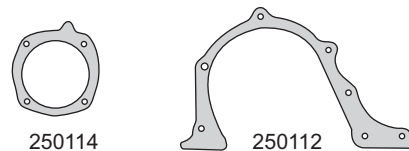
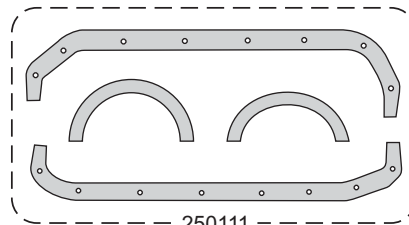
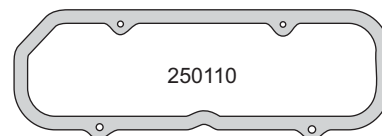
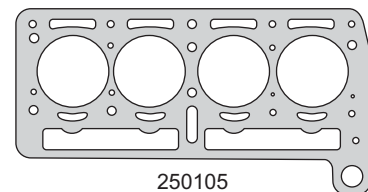

**FIAT**



Motor/Engine	Cm³	HP	Ø
115C	1481	72	77
115C (OHV) 8V	1600	76	78

**Fiat:** 1500 Berlina, Familiar, Multicarga 1963/69  
1600 Berlina, Coupe 1969/72  
**Seat:** 1500 1963/71



Nº OE	Descripción/Description	Mat.	Ref.
	Jgo. de juntas para motor		250200-R
	Jgo. de juntas superior		250295
4956553	Junta tapa cilindros Ø 80.0 ± 1.70	NFT 1 1	250205
4056553	Junta tapa cilindros Ø 80.0 ± 2.40	NFT	250206
	Jgo. tornillos tapa cilindros (HAS19038)		B250200
4027732	Junta tapa válvulas	CG 1 1	250210
	Jgo. junta para cárter (4)	CG	250211
4025572	Tapa distribución	NB	250212
4025776	Bomba de agua	NB	250214
4088354	Jgo. múltiple escape	CHA	250215
	Jgo. múltiple escape (2)	NFT 1 1	250216
	Jgo. múltiple admisión (3)	NFT 1 1	250217
4061096	Salida de escape	FCH 1 1	250218
4027777	Placa bomba de agua	NB	250219
	Jgo. juntas carburador WEBER 28/32 y 36	VS	250220
	Jgo. juntas carburador SOLEX 32 PBIC	VS	250221
	Jgo. juntas carburador WEBER 34 DCHD	VS	250321
	Jgo. juntas carburador SOLEX 34 PAIA 2	VS	250223
4069488	Base carburador 1500	NB 1 1	250225
4127681	Base carburador 1600	NB 1 1	250325
4089702	Tapa termostato	NB 1 1	250227
4081257	Base bomba nafta 0.8	NB	250128
4025578	Desahogo caño aceite	CG	250228
4026063	Brida caño aceite	NB	250229
4025778	Base carcaza termostato	NB 1 1	250230
	Brida soporte bomba aceite	NB	250231
9913568	Vaso nafta	CG	250233
4026077	Entre caño bomba aceite	NB	250234
4076865	Arandela base distribuidor	NB	250235
4025574	Porta retén bancada 1500	NB	250236
4230787	Porta retén bancada 1600	NB	250237
	Base bomba aceite	NB	250238
	Pre-filtro nafta	CG	250239
987112	O'ring balanceador armónico G 101 x 4.3	GS	250140
4071514	O'ring retén guía válvulas G 5.8 x 1.78	GS	250241
987099	O'ring varilla aceite	GS	250242
4020448	Entrada carga aceite	CG	250243
	Base bomba nafta 0.5	NB	250144
4081258	Base bomba nafta 1.5	NB	250248
	Jgo. juntas caja velocidades	VS	250250
	Palier	CB	250256
	Tapa diferencial	CB	250259
	Jgo. juntas para cárter	CG	250260
4027732	Junta tapa válvulas	CG	250261
	Suplemento tapa cilindros	AL	250285
	Kit de retenes completo		R250200
	Jgo. retén válvulas (8)	P	1 R250110P
	Retén bancada 80 x 100 x 10	N	1 R250211N
	Retén distribuidor 45 x 65 x 10	N	1 R250212N

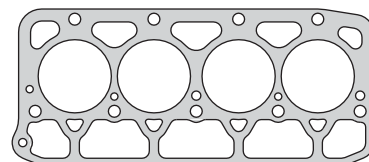

250205

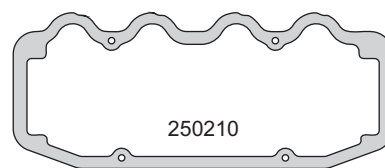

250210

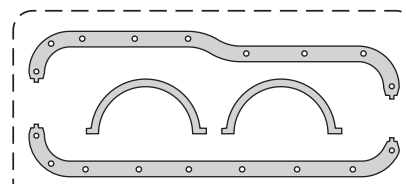

250211

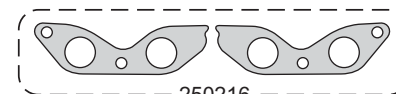

250216

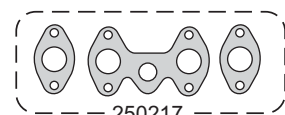

250217

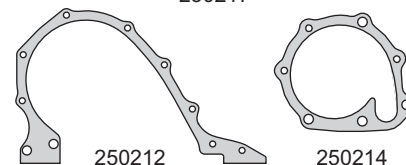

250212

250214

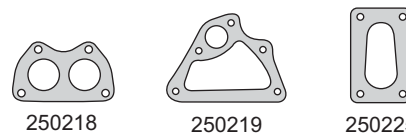

250218

250219

250225

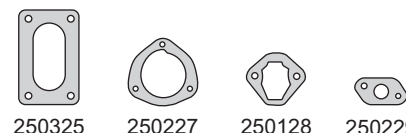

250325

250227

250128

250229

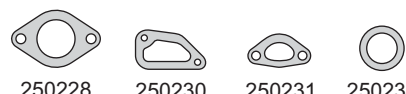

250228

250230

250231

250233

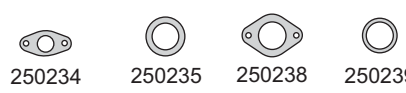

250234

250235

250238

250239

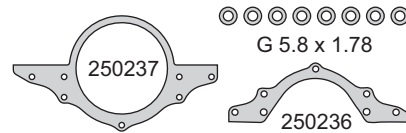

250237

G 5.8 x 1.78

250236



250242

G 101 x 4.3

250243



R250212N

R250211N



R250110P

FIAT



Motor/Engine	Cm³	HP	Ø
128A (SOHC) 8V	1116	55/60	80

Fiat: 128, 147, Spazio, Brio, Ritmo 60 Strada 60 1971/...



Nº OE	Descripción/Description	Mat.	Ref.
1041169	Jgo. de juntas para motor		250400-R
	Jgo. de juntas superior		250495
4321213	Jta. tapa cilindros Ø 81.0 ±1.40	NFT 1 1	250405
4321213	Jta. tapa cilindros Ø 81.0 ±2.40	NFT	250406
	Jta. tapa cilindros Ø 81.0 ±1.40 NR	NFT	250407
	Jgo. tornillos tapa cilindros (HAS19038)		B250400
97052381	Junta tapa válvulas superior	CG 1 1	250410
4179038	Junta para cárter	CG 1 1	250411
4179043	Tapa distribución	NB 1 1	250412
97052378	Tapa bomba de agua	NB 1 1	250414
4195133	Jgo. múltiple admisión y escape (2)	NFT 1 1	250416
	Jgo. múltiple admisión y escape IAVA	NFT	250616
4179155	Bomba de agua a block	NB 1 1	250419
97052379	Bomba de agua	NB 1 1	260319
	Jgo. juntas carburador WEBER 32	VS	250420
	Jgo. juntas carburador WEBER (3 series)	VS	250520
	Jgo. juntas carburador WEBER	VS	250421
	Jgo. juntas carburador WEBER IAVA	VS	250422
	Jgo. juntas carburador WEBER 30 IBA/32	VS	250424
4428157	Base carburador	NB 2 2	250425
9922076	Tapa carburador	CB	250426
	Base filtro aceite	NB 1 1	250427
4179113	Base bomba nafta 0.8	NB 1 1	250128
4179114	Separador bomba nafta 0.5	NB 1 1	250428
4193959	Superior bomba agua	NB 1 1	250429
4194902	Brida caño calefactor	NB 1 1	250430
97051650	Caballote T.V. 0.2	NB 1 1	250431
97051650	Caballote T.V. 0.5	NB	250432
97051650	Caballote T.V. 0.8	NB	250433
4195119	Tapa inspección cigüeñal	NB 1 1	250434
4179117	Tapa inspección árbol levas 0.3	NB	250534
4179117	Tapa inspección árbol levas 0.8	NB 1 1	250435
4179117	Tapa inspección árbol levas 0.5	NB	250535
4179117	Tapa inspección árbol levas 1.5	NB	250635
4179183	Termostato	CB 1 1	250436
97052380	Base termostato	NB 1 1	250437
4179148	Brida caño aceite	NB 1 1	250438
4179138	Base bomba aceite	NB 1 1	250439
4230783	Bomba aceite tubo escape	NB 1 1	250440
4302267	Porta retén bancada trasero	NB 1 1	250441
4158100	Caño respiradero cárter	NB 1 1	250442
4109133	Apoyo distribuidor	NB 1 1	250443
9919743	Intermedia carburador	NB	250444
4205663	Separador bomba nafta 0.8	NB	250445
4205664	Separador bomba nafta 1.5	NB 1 1	250446
97051650	Caballote T.V. 1.5	NB	250448
	Jgo. juntas caja velocidades	VS	250450
	Jgo. juntas caja velocidades	VS	250451
	Tapa válvulas superior (2.7)	NB	250459
4179038	Junta para cárter	CGT	250460
97052381	Junta tapa válvulas superior	CGT	250461
	Junta tapa cilindros competición (0.80)	NFT	250490-0.8
	Junta tapa cilindros competición (1.00)	NFT	250490-1.0

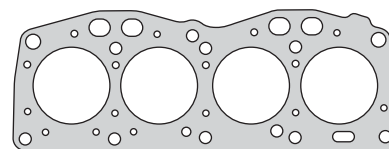

250405

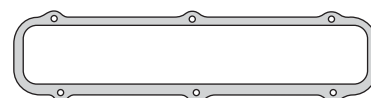

250410

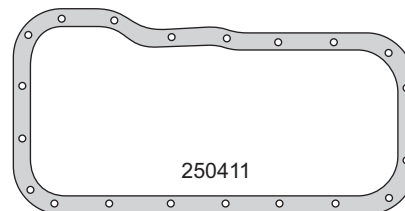

250411

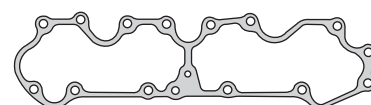

250431

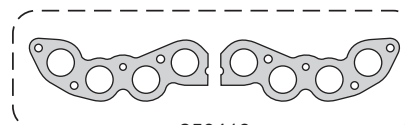

250416



250412

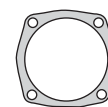

250414



250419



260319



250425



250426



250427



250128



250428



250429



250430



250434



250435



250436



250437



250438



250439



250440



250441



250442



FIAT





Motor/Engine	Cm³	HP	Ø
128A1	1290	73	86.4
138B2	1301	68/70	86.4
831B	1301	75	86.4
138A2/A4 (SOHC) 8V	1498	75/85	86.4

**Fiat:** 128, Europa, 147, Spazio 1971/81  
Regata 70, Ritmo Strada 65, Uno 70  
Iva, TV, 147 Sorpasso Fiorino 1982/...

**Lancia:** Prisma 1983/..., Delta 1986/92  
Prisma, Delta 1978/81



N° OE	Descripción/Description	Mat.	Ref.
1041194	Jgo. de juntas para motor 		250500-R
	Jgo. de juntas superior 		250595
4444452	Jta. tapa cilindros Ø 87.7 ± 1.40 	NFT 1 1	250505
4444452	Jta. tapa cilindros Ø 87.7 ± 2.40 	NFT	250506
4444452	Jta. tapa cilindros Ø 87.7 ± 1.40  NR	NFT	250507
	Jgo. tornillos tapa cilindros (HAS19038) 		B250400
97052381	Junta tapa válvulas 	CG 1 1	250410
4179038	Junta para cárter 	CG 1 1	250411
4179043	Tapa distribución 	NB 1 1	250412
97052378	Tapa bomba de agua 	NB 1 1	250414
4195133	Jgo. múltiple admisión y escape(2) 	NFT 1 1	250416
7770023	Bomba de agua a block 	NB 1 1	260319
	Jgo. juntas carburador WEBER	VS	250421
	Jgo. juntas carburador IAVA WEBER 49/D-F3	VS	250422
	Jgo. juntas carburador SOLEX	VS	250423
	Jgo. juntas carburador WEBER 30 IBA/22	VS	250424
4428157	Base carburador	NB 2 2	250425
9922076	Tapa carburador	CB	250426
4179113	Base bomba nafta 0.8	NB	250128
4179114	Separador bomba nafta 0.5	NB	250428
4193959	Superior bomba agua	NB	250429
4194902	Brida caño calefactor	NB 1 1	250430
97051650	Caballote T.V. 0.2	NB 1 1	250431
4218077	Tapa árbol levas distribución	NB	250531
97051650	Caballote T.V. 0.5	NB	250432
4218080	Tapa árbol levas trasero	NB	250532
97051650	Caballote T.V. 0.8	NB	250433
4195119	Tapa inspección cigüeñal	NB	250434
	Tapa inspección árbol levas 0.3	NB	250534
4179117	Tapa inspección árbol levas 0.8	NB 1 1	250435
4179117	Tapa inspección árbol levas 0.5	NB	250535
4179117	Tapa inspección árbol levas 1.5	NB	250635
4179183	Termostato	CB 1 1	250436
97052380	Base termostato	NB 1 1	250437
4179148	Brida caño aceite	NB	250438
4179138	Base bomba aceite	NB	250439
4230783	Bomba aceite tubo escape	NB	250440
7737202	Porta retén bancada trasero	NB	260241
4158100	Caño respiradero cárter	NB	250442
4109133	Apoyo distribuidor	NB	250443
9919743	Intermedia carburador	NB	250444
4205663	Separador bomba nafta 0.8	NB	250445
4205663	Separador bomba nafta 1.5	NB	250446
97051650	Caballote T.V. 1.5	NB	250448
	Jgo. juntas caja velocidades 4ta.	VS	250450
	Jgo. juntas caja velocidades 5ta.	VS	250550
	Jgo. juntas caja velocidades 4ta.	VS	250451
	Jgo. juntas caja velocidades 5ta.	VS	250551
4179038	Junta para cárter 	CGT	250460
97052381	Junta tapa válvulas 	CGT	250461
	Suplemento tapa cilindros 	AL	250585
	Junta tapa cilindros competición (0.80)	NFT	250590-0.8
	Kit de retenes completo 		R250400

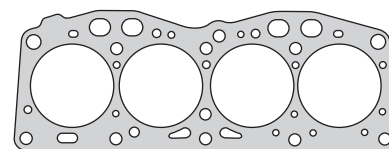

250505

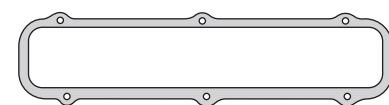

250410

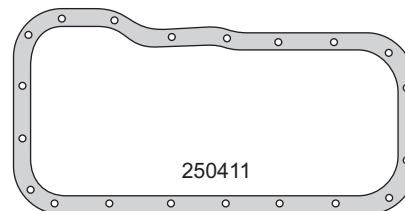

250411

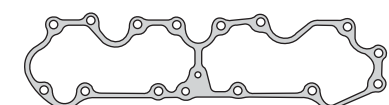

250431

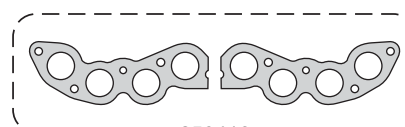

250416

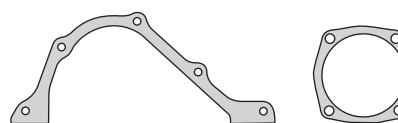

250412

250414



260319

250425

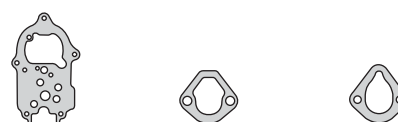

250426

250128

250428



250429

250430

250531

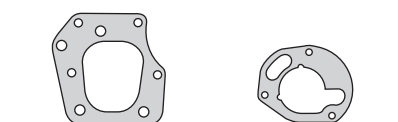

250532

250434



250435

250436

250437



250438

250439

250440



**FIAT**



Motor/Engine	Cm³	HP	Ø
128A1	1290	73	86.4
138B2	1301	68/70	86.4
831B	1301	75/80	86.4
138A2/A4 (SOHC) 8V	1498	75/85	86.4

**Fiat:** 128, Europa, 147, Spazio 1971/81  
Regata 70, Ritmo Strada 65, Uno 70  
lava, TV, 147 Sorpasso Fiorino 1982/...  
Ritmo Strada 75/85 1978/82

**Lancia:** Prisma 1983/..., Delta 1986/92  
Prisma, Delta 1978/81

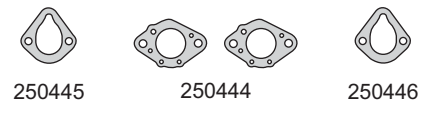
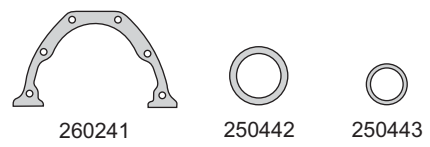

Nº OE	Descripción/Description	Mat.	Ref.
	Jgo. retén válvulas (8)	V	1 R250410V
	Retén bancada 64 x 80 x 8	P	1 R250111P
	Retén distribución 40 x 56 x 7	P	1 R250412P
	Retén árbol levas 30 x 52 x 7	P	2 R250413P

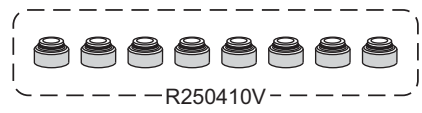
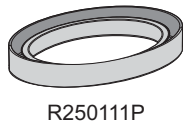

FIAT



Motor/Engine	Cm³	HP	Ø
138C3	1498	75/85	86.4
831B1 (DOHC) 8V	1498	80/82	86.4

**Fiat:** 128 Regatta '85, Ritmo 1986/90  
Duna, Uno, Super Europa 1983/...  
Elba, Premio, Fiorino

**Lancia:** Delta, Prisma 1986/...



Nº OE	Descripción/Description	Mat.	Ref.
1041254	Jgo. de juntas para motor		250600-R
	Jgo. de juntas superior		250695
5957865	Jta. tapa cilindros Ø 87.0 ±1.70	NFT 1 1	250605
	Jta. tapa cilindros Ø 87.0 ±2.40	NFT	250606
5957865	Jta. tapa cilindros Ø 87.0 ±1.70 NR	NFT	250607
	Jgo. tornillos tapa cilindros (HAS15038)		B260200
97052381	Junta tapa válvulas superior	CG 1 1	250410
4179038	Junta para cárter	CG 1	250411
4179043	Tapa distribución	NB 1	250412
97052378	Tapa bomba de agua	NB 1	250414
4195133	Jgo. múltiple admisión y escape (2)	NFT 1 1	250416
1482930	Salida de escape	FCH 1 1	250618
7770023	Bomba de agua a block	NB 1	260319
	Jgo. juntas carburador SOLEX 32 DISA	VS	250620
	Jgo. juntas carburador SOLEX C32/34 CIC	VS	250621
	Jgo. juntas carburador WEBER 2B	VS	250622
4428157	Base carburador	NB 2	250425
	Base carburador SOLEX DISA	NB 1 1	250625
	Tapa carburador SOLEX DISA	CB	250626
4179113	Base bomba nafta	NB 1	250128
4179114	Separador bomba nafta 0.5	NB 1	250428
4193959	Superior bomba agua	NB 1	250429
4194902	Brida caño calefactor	NB 1 1	250430
97051650	Caballote T.V. 0.2	NB 1 1	250431
4218077	Tapa árbol levas distribución hasta 1988	NB 1	250531
	Intermedio carburador SOLEX DISA	CB	250631
97051650	Caballote T.V. 0.5	NB	250432
4218080	Tapa árbol levas trasero hasta /88	NB 1	250532
97051650	Caballote T.V. 0.8	NB	250433
5937811	Tapa block (volante) 89/ ad.	NB 1	250633
4195119	Tapa inspección cigüeñal	NB 1	250434
4179117	Tapa inspección árbol levas 0.3	NB	250534
7575660	Tapa block (distribución) 89/ ad.	NB 1	250634
4179117	Tapa inspección árbol levas 0.8	NB 1 1	250435
4179117	Tapa inspección árbol levas 0.5	NB	250535
4179117	Tapa inspección árbol levas 1.5	NB	250635
4179183	Termostato	CB 1 1	250436
97052380	Base termostato	NB 1 1	250437
4179148	Brida caño aceite	NB 1	250438
4179138	Base bomba aceite	NB 1	250439
4230783	Bomba aceite tubo escape	NB 1	250440
7737203	Porta retén bancada trasera	NB 1	260241
4158100	Caño respiradero cárter	NB 1	250442
4109133	Apoyo distribuidor	NB 1	250443
4205663	Separador bomba nafta 0.8	NB	250445
4205664	Separador bomba nafta 1.5	NB 1	250446
97051650	Caballote T.V. 1.5	NB	250448
	Jgo. juntas caja velocidades	VS	250550
	Jgo. juntas caja velocidades	VS	250551
4179038	Junta para cárter	CGT	250460
	Junta tapa cilindros competición (0.80)	NFT	250690-0.8
	Junta tapa cilindros competición (1.00)	NFT	250690-1.0
	Junta tapa cilindros competición (1.20)	NFT	250690-1.2

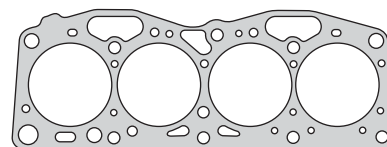

250605

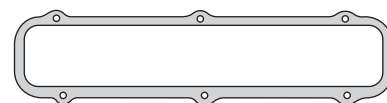

250410

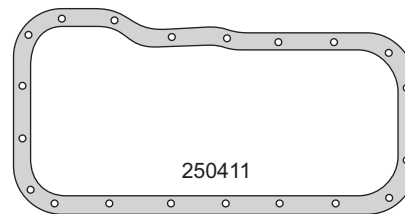

250411

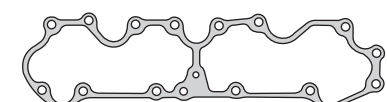

250431

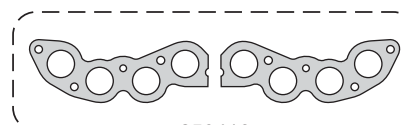

250416

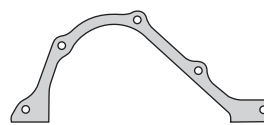

250412

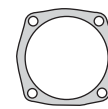

250414

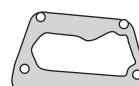

260319



250618



250625



250626



250425



250128



250128



250428



250429



250430



250631

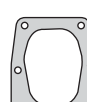

250531

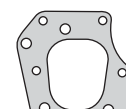

250532



250633

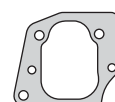

250634



250434



250435



250436



250437



250438



250439



FIAT



Motor/Engine	Cm³	HP	Ø
125AB - 125A	1608	110	80

Fiat: 125 (Bialbero), Berlina, Sport  
Multicarga, Mirafiori 1972/74

Nº OE	Descripción/Description	Mat.	Ref.
	Jgo. de juntas para motor		250700-R
	Jgo. de juntas superior		250795
4315063	Junta tapa cilindros Ø 81.0 $\pm$ 1.40	NFT 1 1	250705
4315063	Junta tapa cilindros Ø 81.0 $\pm$ 2.40	NFT	250706
	Jgo. tornillos tapa cilindros (HAS17038)		B250700
4158646	Conj. junta tapa válvulas (3)	CG 2 2	250710
4129756	Junta para cárter	CG 1	250711
4130903	Tapa distribución	NB 1	250712
4129813	Tapa cuerpo bomba de agua	NB 1	250714
4177112	Múltiple escape	NFT 1 1	250716
4194060	Múltiple admisión	NFT 1 1	250717
4176386	Salida de escape	FCH 1 1	250718
4158100	Anillo bomba de agua	NB 1	250719
	Jgo. juntas carburador SOLEX PAIA 33	VS	250720
	Jgo. juntas carburador SOLEX 34 EIES	VS	250722
	Jgo. juntas carburador WEBER DCHE-20	VS	250723
4135604	Porta filtro aceite	NB 1	250727
4081258	Base bomba nafta 0.8	NB 2	250128
4130916	Porta retén delantero	NB 1	250728
4129763	Porta retén bancada trasera	NB 1	250729
4123150	Tapa árbol levas	NB 2 2	250730
4268806	Caballote T.V. 0.2	NB	250731
	Caballote T.V. 0.5	NB	250732
	Caballote T.V. 0.8	NB 2 2	250733
4129820	Soporte bomba agua	NB 1	250734
4121068	Base bomba aceite	NB 1	250735
	Cuerpo respiradero motor	CG 1	250736
4123229	Vaso nafta	CG 1	250737
4135490	Arbol levas	NB 1	250738
4184495	Termostato	GS	260039
4188704	Salida agua	NB 1	250739
	Termostato	NB	250740
	Caballote T.V. 0.8	NFT	250741
	Arandela tapa válvulas A 13 x 21 x 1.5 F	F 4 4	250742
	Arandela salida agua tapa cilindros	CG	250743
	Base bomba nafta 0.5	NB	250144
4123150	Tapa árbol levas 0.25	NB	250744
4123150	Tapa árbol levas 0.5	NB	250745
4123150	Tapa árbol levas 1.0	NB	250746
4081258	Base bomba nafta 1.5	NB	250248
	Jgo. juntas caja velocidades	VS	250250
	Palier	CB	250256
	Tapa diferencial	CB	250259
4129756	Junta para cárter	CGT	250760
4158646	Junta tapa válvulas	CG	250761
	Suplemento tapa cilindros	AL	250785
	Kit de retenes completo		R250700
	Jgo. retén válvulas (8)	V 1	R250410V
	Retén bancada 70 x 90 x 10	P 1	R550411P
	Retén distribución 40 x 56 x 7	P 1	R250412P
	Retén árbol levas 30 x 52 x 7	P 3	R250413P

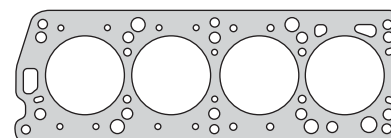

250705

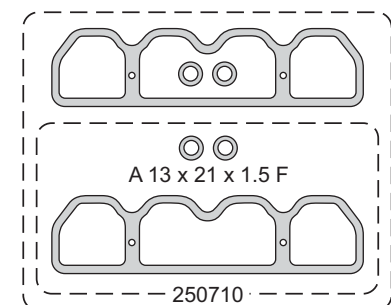

250710

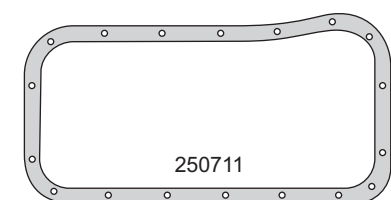

250711

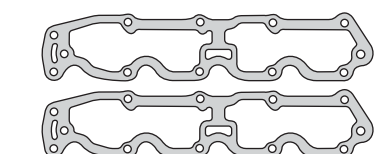

250733



250716



250717



250712

250714

250718

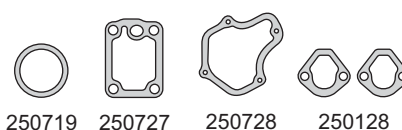

250719

250727

250728

250128

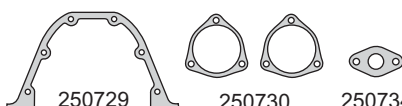

250729

250730

250734

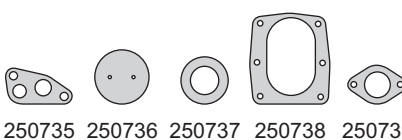

250735

250736

250737

250738

250739

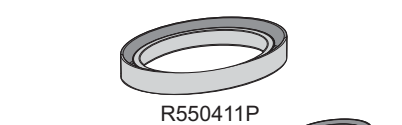

R550411P



R250412P

R250413P



R250410V

**FIAT**



Motor/Engine	Cm³	HP	Ø
100R	843	32	62.5
100G	843	37	65
08NCA	843	35/45	65
146A	903	40/45	65
08NCA-09NCA (OHV) 8V	903	40/45	65

**Fiat:** 133, Berlina de Lujo 1977/82  
850, 850 Van 1965/76  
Uno 45 1974/..., 127 Especial 1983/88

**Seat:** Marbella, Ibiza, Terra 1989/94, 133 74/78  
850 1964/78, Panda 1980/...  
127, Panda 45 1972/...

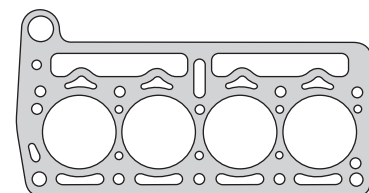

250805

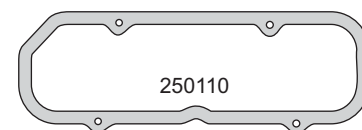

250110

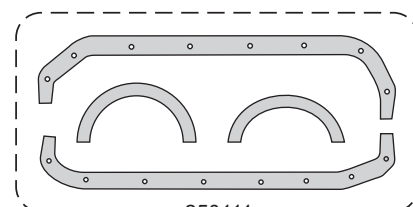

250111



250816



250112



250814

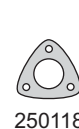

250118



250819



250125



250825



250126



250127



250129

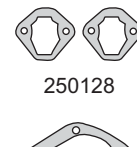

250128

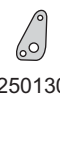

250130



250131



250833

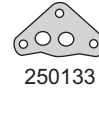

250133



250835

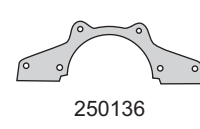

250136



250137



250140



250141



R250112P

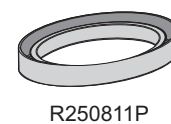

R250811P



R250810P

Nº OE	Descripción/Description	Mat.	Ref.
	Jgo. de juntas para motor		250800-R
	Jgo. de juntas superior		250895
97051863	Jta. tapa cilindros Ø 66.0 ± 1.40	NFT 1 1	250805
97051863	Jta. tapa cilindros Ø 66.0 ± 2.40	NFT	250806
	Jta. tapa cilindros Ø 66.0 ± 1.40 NR	NFT	250807
	Jgo. tornillos tapa cilindros (HAS17038)		B250800
4117850	Junta tapa válvulas	CG 1 1	250110
	Jgo. junta para cárter (4)	CG 1	250111
4107391	Tapa distribución	NB 1	250112
97051581	Tapa bomba de agua	NB 1	250814
4127971	Múltiple admisión y escape	NFT 1 1	250816
876075	Salida de escape	FCH 1 1	250118
	Bomba de agua	NB 1	250819
	Jgo. juntas carburador WEBER 30 ICF	VS	250122
4121933	Base superior carburador	NB 1	250125
4100576	Entre carburador y múltiple	NB 1 1	250825
9910788	Tapa carburador	CB	250126
881452	Superior bomba aceite	NB 1	250127
4081258	Base bomba nafta 0,8	NB 2	250128
4052518	Brida bomba aceite	NB 1	250129
4057986	Inferior caño bomba aceite	NB 1	250130
4064079	Base intermedia carburador	NB 1	250131
883831	Base filtro aceite a block	NB 1	250133
4101760	Tapa bomba de agua	NB 1	250833
4100581	Tapa termostato	NB 1 1	250835
4172904	Porta retén bancada trasera	NB 1	250136
1/02795/60	Tapa tubo entrada aceite	CG 1	250137
987112	Balanceador armónico G101 x 4.3	GS 1	250140
4065247	Base termostato	NB 1 1	250141
	Base bomba nafta 0.5	NB	250144
4081258	Base bomba nafta 1.5	NB	250248
	Jgo. juntas caja velocidades	VS	250850
	Junta tapa cilindros competición (0.60)	NFT	250890-0.6
	Junta tapa cilindros competición (0.80)	NFT	250890-0.8
	Kit de retenes completo		R250800
	Jgo. retén válvulas (8)	P 1	R250810P
	Retén bancada 64 x 80 x 8	P 1	R250811P
	Retén distribución 42 x 56 x 7	P 1	R250112P

FIAT



Motor/Engine Cm³ HP Ø

149A (SOHC) 8V 1585 100 84

Fiat: Regata 100S 1985/...



Nº OE	Descripción/Description	Mat.	Ref.
	Jgo. de juntas para motor		250900-R
5951675	Junta tapa cilindros Ø 85.0 ± 1.70	NFT 1	250905
5951675	Junta tapa cilindros Ø 85.0 ± 1.70 <b>N.R.</b>	NFT	250907
5951675	Jgo. tornillos tapa cilindros (HAS17038)		B250700
	Junta tapa válvulas	CG 2	250710
4158646	Junta para cárter	CG 1	250911
4331606	Tapa distribución	NB 1	250712
4130903	Base bomba de agua	NB 1	250914
4475631	Múltiple escape	NFT 1	250716
4177112	Múltiple admisión	NFT 1	250717
4194060	Salida de escape	FCH 1	250718
1476386	Anillo caño bomba de agua	GS	250919
14458580	Jgo. juntas carburador WEBER 32-DAT	VS	250920
	Base carburador	NB 2	250925
	Tapa carburador	CB	250926
	Base bomba aceite	NB 1	250927
4304656	Porta retén delantero	NB 1	250728
4130916	Base bomba nafta	NB 2	250928
4319009	Porta retén bancada trasera	NB 1	250729
4129763	Tapa árbol levas	NB 2	250930
4123150	Caballote T.V. 0.2	NB	250731
4268806	Caballote T.V. 0.5	NB	250732
4268806	Caballote T.V. 0.8	NB 2	250733
4388512	SopORTE brida caño bomba	NB 1	250734
4129820	Base filtro aceite	NB 1	250935
4337093	Pescador bomba aceite	NB 1	250937
4336939	Tapa inspección cámara agua	NB 1	250938
97053144	Salida agua	NB 1	250739
4188704	Tapa inspección cámara agua	NB 1	250940
	Base bomba agua	NB 1	250941
	Arandela tapa válvulas A 13 x 21 x 1.5 F	F 4	250742
	Filtro lubricación	NB 1	250942
4158100	Bomba agua reforma	NB 1	250943
	O'ring G 36 x 3	GS 1	
	Kit de retenes completo		R260400
	Jgo. retén válvulas (8)	V 1	R250410V
	Retén bancada 74 x 90 x 10	P 1	R260111P
	Retén distribución 30 x 43 x 8	P 1	R260112P
	Retén árbol levas 30 x 52 x 7	P 2	R250413P

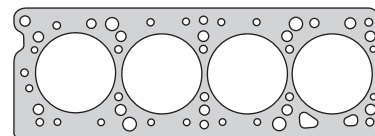

250905

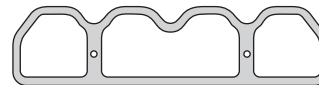

250710

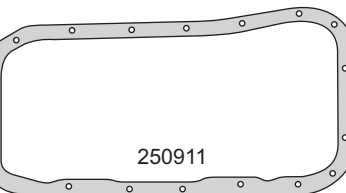

250911



250716



250717

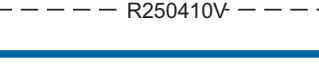
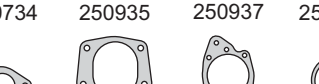
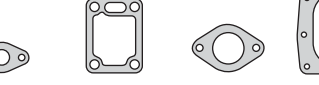
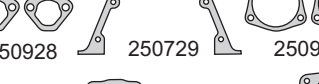
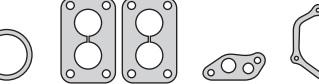

FIAT



Motor/Engine	Cm³	HP	Ø
146A2	994	48	70
156A2/A3	999	30/45	70
176B2/178B9 (SOHC) 8V	1108	54	70

Fiat: Panda 1986/..., Uno 1989/95  
Uno 1998/..., Panda 1995/96  
Palio 2001/....

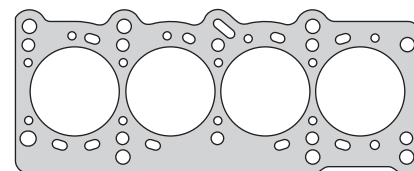

270507



251010

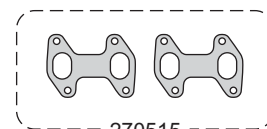

270515

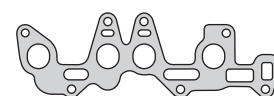

251017

















270519



R260113V



R270510V

Nº OE	Descripción/Description	Mat.	Ref.
	Jgo. de juntas superior 		251095-R
	Junta tapa cilindros Ø 72.0 $\pm$ 1.20 	NFT	270505
	Junta tapa cilindros Ø 72.0 $\pm$ 1.20  N.R. 	NFT	1 270507
46546120	Junta tapa cilindros Ø 72.0 $\pm$ 1.95  N.R. 	NFT	270507-1.9
	Junta tapa cilindros Ø 72.0 $\pm$ 0.40  N.R. 	MLS	270508
	Jgo. tornillos tapa cilindros (HAS13038) 		B270500
	Junta tapa de válvulas 	P	1 251010
46546134	Jgo. múltiple escape (2) 	NFT	1 270515
	Jgo. múltiple admisión 	NB	1 251017
7604488	Termostato	NB	1 270519
7581344	Jgo. retén válvulas (8) 	V	1 R270510V
40004240	Retén árbol de levas 30 x 42 x 7 	V	1 R260113V

FIAT



Motor/Engine	Cm³	HP	Ø
8140.63 (SOHC) 8V	2799	87/89	94.4

**Fiat:** Ducato 14, Ducato 18 Maxi  
Ducato 14D, Ducato 18D Maxi 1998/...

**Iveco:** Daily 30.8, Daily 35.8 1996/...

DIESEL



Nº OE	Descripción/Description	Mat.	Ref.
	Jgo. de juntas para motor		251101-R
	Jgo. de juntas superior		251195-SM
	Jgo. de juntas superior	●	251195-1M
	Jgo. de juntas superior		251195-2M
500206171	Junta tapa cilindros Ø 96.0 ± 1.60	NFT	251107-SM
	Junta tapa cilindros Ø 96.0 ± 1.70	NFT 1	251107-1M
	Junta tapa cilindros Ø 96.0 ± 1.80	NFT	251107-2M
	Jgo. tornillos tapa cilindros (HAS17038)		B251100
500388381	Junta tapa válvulas	N 1 1	251110
99488483	Junta para cárter 1996/...	CG 1	270111
99488486	Junta para cárter 1998/...	CG 1	270311
	Junta distribución	NB 1	270112
	Bomba de agua	NB 1	251114
98434020	Jgo. múltiple escape (4)	NFT 1 1	270116
98425767	Jgo. multiple admisión (4)	NFT 1 1	270117
	Porta termostato	NB 1 1	270119
	Comando bomba inyectora	NB 2	270135
	Junta base filtro aceite	NB 1	270136
	Brida agua	NB 1 1	270137
99432807	Intermedio block izquierdo	GS 1	270338
99432808	Intermedio block derecho	GS 1	270339
	Tapa inspección block trasero	NB 1	270340
	Múltiple admisión	NB 1 1	270341
	Base depresora	NB 1 1	251143
	Junta	NB 1	251144
	Tapa ciega inspección precámara	SLS 1	251142
	Bridas turbo	AC 3	251145
	Junta porta retén árbol de levas	NFT	251146
	Guarnición termostato	GS 1	460245
	Salida de escape turbo	AC 1 1	500546
	O'ring G 37.47 x 5.33	GS 1	
	O'ring G 12.37 x 2.62	GS 1	
	O'ring G 64.77 x 2.62	GS 1	
	O'ring G 59.92 x 3.53	GS 1	
	O'ring G 55.25 x 2.62	GS 1	
	O'ring G 47.22 x 3.53	GS 2	
	O'ring G 44.04 x 3.53	GS 1	
	O'ring G 29.82 x 2.62	GS 1	
	O'ring G 18.72 x 2.62	GS 2	
	O'ring G 56.87 x 1.78	GS 1	
	O'ring G 48.90 x 2.62	GS 1	
	O'ring G 23.47 x 2.62	GS 1	
	O'ring G 21.95 x 1.78	GS 1	
	O'ring G 18.64 x 3.53	GS 1	
	O'ring G 17.17 x 1.78	GS 4	
	O'ring G 9.25 x 1.78	GS 4	
	Arandela A 22 x 27 x 1.5 C	CU 2	
	Arandela A 20 x 26 x 1 C	CU 2	
	Arandela A 18 x 22 x 1.5 C	CU 2	
	Arandela A 14 x 20 x 1.5 C	CU 2	
	Arandela A 12 x 18 x 1.5 C	CU 10	
	Arandela A 10 x 14 x 1 C	CU 4	
	Arandela A 8 x 14 x 1 C	CU 5	

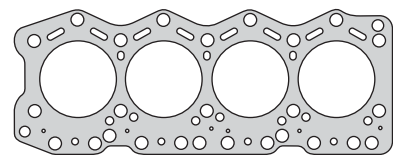

251107

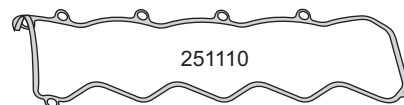

251110

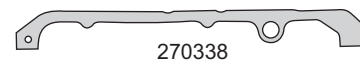

270338



270339

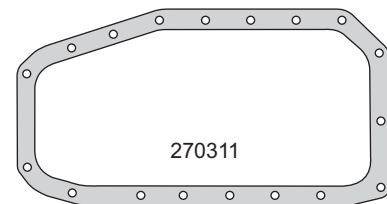

270311

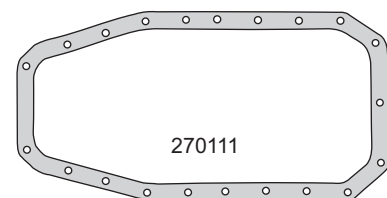

270111

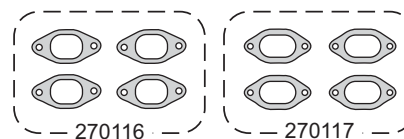

270116

270117

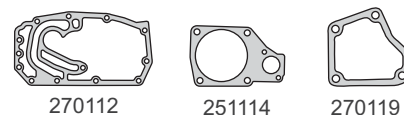

270112

251114

270119

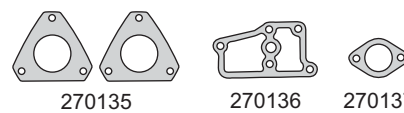

270135

270136

270137

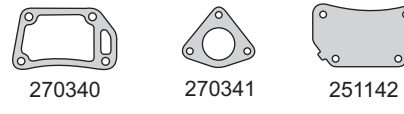

270340

270341

251142

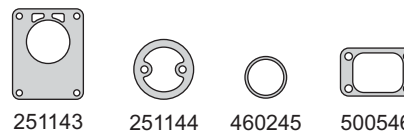

251143

251144

460245

500546



251145

251146

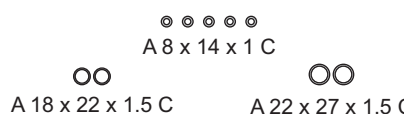

A 8 x 14 x 1 C

A 18 x 22 x 1.5 C

A 22 x 27 x 1.5 C

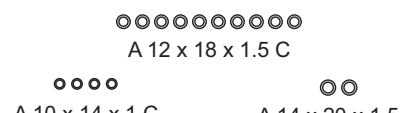

A 12 x 18 x 1.5 C

A 10 x 14 x 1 C

A 14 x 20 x 1.5 C

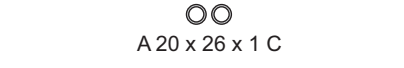

A 20 x 26 x 1 C





**FIAT**



Motor/Engine	Cm³	HP	Ø
8140.21	2445	92	93
8140.27 (SOHC) 8V	2499	103	93

**Fiat:** Ducato TD 1985/...  
**Iveco:** Daily TD 1985/89  
**Renault:** B90 1986/88

DIESEL

Nº OE	Descripción/Description	Mat.	Ref.
	Jgo. de juntas superior		251495-R
	Junta tapa cilindros Ø 95.0 $\pm$ 1.40	NFT 1	251407
	Jgo. tornillos tapa cilindros (HAS17038)		B270100
	Junta tapa válvulas	GS 1	270110
	Jgo. múltiple admisión y escape (4)	NFT 1	270116
	Jgo. múltiple admisión (4)	NFT 1	270117
	Junta porta termostato	NB 1	270119
	Junta filtro aceite	NB 1	270132
	Junta brida agua	NB 4	270137
	Junta brida agua	NB 1	270140
	Junta brida agua	NB 1	270141
	Junta brida agua	NB 1	270142
	Junta brida agua	NB 1	270144
	Junta porta árbol de levas	NFT	251146
	Junta motor	NB 1	251445
	Junta motor	AC 1	251446
	Junta colector escape a turbo	AC 1	350462
	Arandela A 12 x 18 x 1C	CU 4	
	Arandela A 8 x 14 x 0.5 C	CU 6	
	Retén árbol auxiliar 55 x 70 x 10	V 1	R270115V

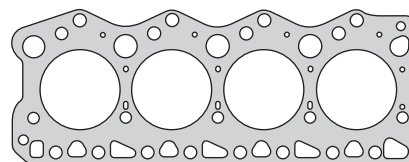

251407

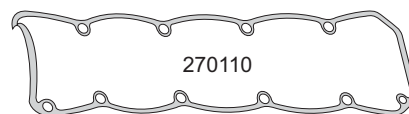

270110

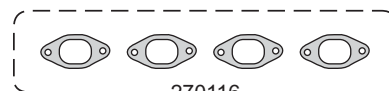

270116

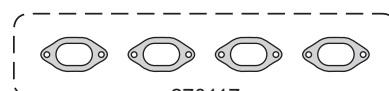

270117



270119



270132



270140



270137



270141



270142



270144



251446



350462



251445



251146



A 12 x 18 x 1 C



A 8 x 14 x 0.5 C



R270115V

FIAT



Motor/Engine	Cm³	HP	Ø
176B1/B4/A7	1242	60	70.8
178B5	1242	73	70.8
840A3 (SOHC) 8V Iny. Monopunto y Multipunto	1242	60	70.8

**Fiat:** Punto 60 Cabrio 1995/99  
Palio 75, Siena 1996/...  
Punto 60, Punto Selecta 1993/99

**Lancia:** Ypsilon 1996/00

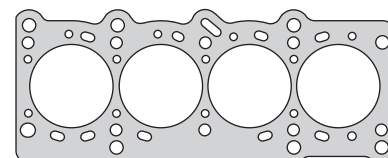

270507

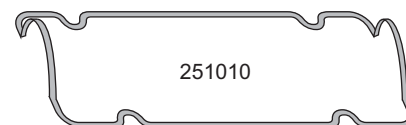

251010

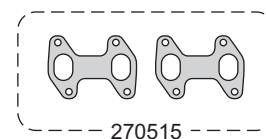

270515



251717

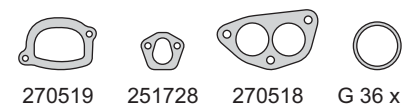

270519

251728

270518







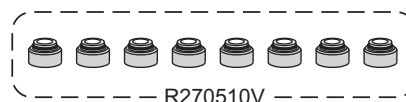







G 36 x 3



R260113P



R270510V

Nº OE	Descripción/Description	Mat.	Ref.
	Jgo. de juntas superior 		251795-R
	Junta tapa cilindros Ø 72.0 $\pm$ 1.20 	NFT	270505
	Junta tapa cilindros Ø 72.0 $\pm$ 1.20 	NFT	270507
	Junta tapa cilindros Ø 72.0 $\pm$ 1.95 	NFT	1 270507-1.9
46541379	Junta tapa cilindros Ø 72.0 $\pm$ 0.40 	MLS	270508
	Jgo. tornillos tapa cilindros (HAS13038) 		B270500
	Junta tapa de válvulas 	P	1 251010
46546134	Jgo. múltiple escape (2) 	NFT	1 270515
	Jgo. múltiple admisión 	NFT	1 251717
	Salida de escape 	FCH	1 270518
7604488	Termostato 	NB	1 270519
	Junta bomba combustible 	NB	1 251728
	O`ring G36 x 3 	GS	1
7581344	Jgo. retén válvulas (8) 	V	1 R270510V
40004240	Retén árbol de levas 30 x 42 x 7 	P	1 R260113P

**FIAT**



Motor/Engine	Cm³	HP	Ø
182A7/A8 (SOHC) 8V	1910	75/100	82

Fiat: Brava, Bravo TD 1996/99  
Marengo TD, Marea TD

DIESEL



Nº OE	Descripción/Description	Mat.	Ref.
	Jgo. de juntas para motor		252001-R
	Junta tapa cilindros Ø 83.0 $\pm$ 1.40	NFT	252007-SM
	Junta tapa cilindros Ø 83.0 $\pm$ 1.50	NFT	252007-1M
	Junta tapa cilindros Ø 83.0 $\pm$ 1.60	NFT	252007-2M
46473174	Junta tapa cilindros Ø 83.0 $\pm$ 1.35	MLS	252008-SM
46473175	Junta tapa cilindros Ø 83.0 $\pm$ 1.45	MLS	252008-1M
46473176	Junta tapa cilindros Ø 83.0 $\pm$ 1.55	MLS	252008-2M
	Jgo. tornillos tapa cilindros (HAR14063)		B252000
	Sellador líquido - caucho de silicona		TRN0085G
46432087	Junta tapa válvulas	GS	1 252010
	Frete distribución	NB	1 270612
46467747	Múltiple escape	AC	1 252015
46461755	Múltiple admisión	NFT	1 252017
	Junta brida	NFT	252029
	Guarnición goma llenado aceite	GS	1 270929
	Junta acople	NFT	252031
	Junta	SLS	1 251832
	Arandela pico inyector	AC	252033
	Salida admisión	SLS	1 270633
	Base bomba inyectora	NFT	1 251834
	Guarnición tubo goma	GS	252034
	Anillo goma G 66 x 72 x 3	GS	1 252035
	O´ring G 63.09 x 3.53	GS	1
	O´ring G 80 x 1.80	GS	1
	O´ring G 56.82 x 2.62	GS	1
	O´ring G 55.25 x 2.62	GS	1
	O´ring G 7.65 x 1.78	GS	2
	Kit de retenes completo		R252000
7553637	Jgo. retén válvulas (8)	V	1 R250410V
46435513	Porta retén bancada 93 x 172/139 x 7/12	V	PR252011V
7628850	Retén distribución 31 x 41 x 7	V	1 R252012V
40004240	Retén árbol de levas 30 x 42 x 7	V	1 R260113V

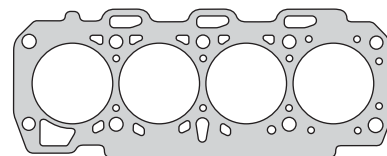

252007



252010



252015



252017

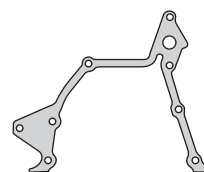

270612



252029



270929



252031

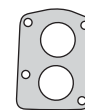

251832

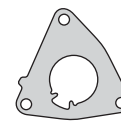

251834



252033



270633



252034



G 55.25 x 2.62



252035



G 63.09 x 3.53



G 7.65 x 1.78

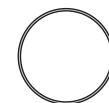

G 80 x 1.80



G 56.82 x 2.62

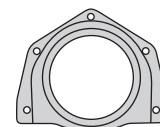

PR252011V



R252012V



R260113V

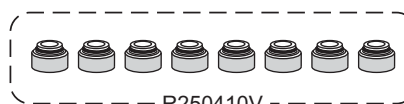

R250410V

**FIAT**



Motor/Engine	Cm³	HP	Ø
182B4	1910	105	82
323.02 (SOHC) 8V	1910	105	82

**Fiat:** Brava, Bravo TD, Multipla TD  
Marea TD 1998/...

**Alfa Romeo:** 156 TD 1997/00, 145 TD  
146 TD 1999/...

DIESEL



Nº OE	Descripción/Description	Mat.	Ref.
	Jgo. de juntas para motor		252101-R
	Junta tapa cilindros Ø 83.0 ± 1.60	NFT	252107-SM
	Junta tapa cilindros Ø 83.0 ± 1.70	NFT	252107-1M
	Junta tapa cilindros Ø 83.0 ± 1.80	NFT	252107-2M
46447765	Junta tapa cilindros Ø 83.0 ± 1.60	MLS	252108-SM
464439944	Junta tapa cilindros Ø 83.0 ± 1.70	MLS	252108-1M
46449945	Junta tapa cilindros Ø 83.0 ± 1.80	MLS	252108-2M
	Jgo. tornillos tapa cilindros (HAR14063)		B252000
	Sellador líquido - caucho de silicona		TRN0085G
	Junta tapa válvulas	GS 1	252110
	Frente distribución	NB 1	270612
46467747	Múltiple escape	AC 1	252015
46772389	Múltiple admisión	NFT 1	252117
	Junta brida	NFT 1	252029
	Guarnición goma llenado aceite	GS 1	270929
	Junta acople	NFT 1	252031
	Junta	SLS 1	251832
	Arandela pico inyector	AC 4	252033
	Salida admisión	SLS 1	270633
	Base bomba inyectora	NFT 1	251834
	Guarnición tubo goma	GS 1	252034
	Anillo goma G 66 x 72 x 3	GS 1	252035
	O´ring G 63.09 x 3.53	GS 1	
	O´ring G 80 x 1.80	GS 1	
	O´ring G 56.82 x 2.62	GS 1	
	O´ring G 55.25 x 2.62	GS 1	
	O´ring G 7.65 x 1.78	GS 2	
	Kit de retenes completo		R252000
7553637	Jgo. retén válvulas (8)	V 1	R250410V
46435513	Porta retén bancada 93 x 172/139 x 7/12	V	PR252011V
7628850	Retén distribución 31 x 41 x 7	V 1	R252012V
40004240	Retén árbol de levas 30 x 42 x 7	V 1	R260113V

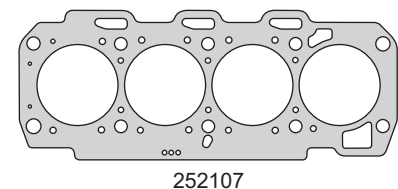

252107



252110



252107-1M



252107-2M

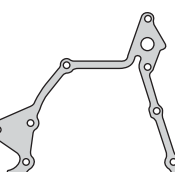

252015



252029



270929



252031



252033



251832



270633



251834



252034



G 55.25 x 2.62



G 66 x 72 x 3



G 80 x 1.80



G 63.09 x 3.53



G 56.82 x 2.62



G 7.65 x 1.78



PR252011V



R252012V



R260113V

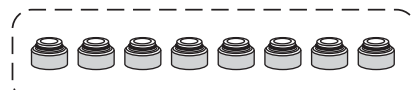

R250410V

FIAT



Motor/Engine	Cm³	HP	Ø
OHC-171190	1796	103	80.5
17241C1	1796	103	80.5
G2	1796	102/105	80.5
G3	1796	110	80.5

Fiat: Palio, Stilo, Palio Flex, Strada  
Siena Flex 2003/... BR  
Idea Adventura HLX, G2, G3 2006/... BR



Nº OE	Descripción/Description	Mat.	Ref.
7085016	Jgo. de juntas para motor		252300-R MLS
	Jgo. de juntas superior (MLS)	●	252395 MLS
	Junta tapa cilindros Ø 82.0 ± 1.40	NFT	242205
	Junta tapa cilindros Ø 82.0 ± 1.40 NR	NFT	242207
7083633	Junta tapa cilindros Ø 82.0 ± 1.40 NR	MLS 1 1	242208
	Jgo. tornillos tapa cilindros (HAE12038)		B240400-1
7083232	Junta tapa de válvulas	N 1 1	241010
	Junta cárter con control de compresibilidad	CG 1	240411
7083280	Frente motor y bomba de aceite	SLS 1	241812
	O´ring cierre bomba de agua G 79.5 x 3	GS 1 1	240414
93396858	Múltiple escape	AC 1 1	240415
90571863	Múltiple admisión	NB 1 1	241017
7084980	Jgo. múltiple admisión (7) G3	S 1 1	252317
73502844	Salida de escape catalizador G3	AC 1 1	252318
90128293	Salida de escape G2	FCH	240018
7084981	Junta cuerpo mariposa aceleración G3	GS 1 1	252326
7083288	Descarga gases	NB	240429
7086225	Conducto agua admisión a EGR	GS 1 1	270731
	Guarnición acople admisión G3	GS 1 1	252332
7083229	Guarnición tapa llenado de aceite G 38 x 4	GS	1
	Kit de retenes completo		R252300
7083239	Jgo. retén válvulas (8) G2	V 1	R240210V
7083335	Jgo. retén válvulas (8) G3	V 1	R252310V
7084149	Retén bancada 80 x 98 x 10	V 1	R240411V
90280463	Retén árbol de levas 35 x 48 x 7	V 1	R240013V
90501719	Retén distribución 26 x 42 x 8	V 1	R240415V

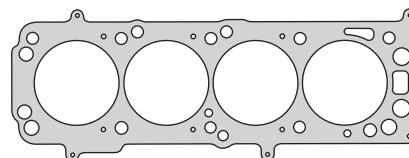

242208

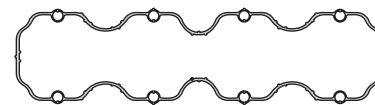

241010

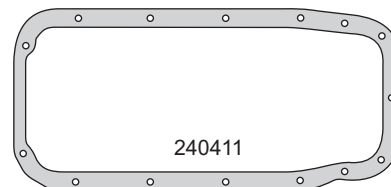

240411

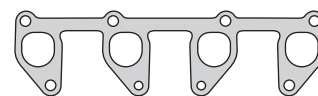

240415

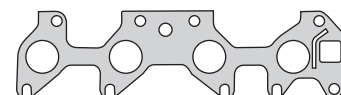

241017

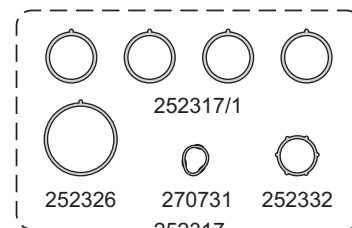

252317/1

252326 270731 252332

252317

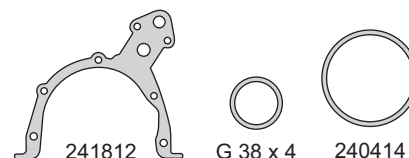

241812

G 38 x 4

240414

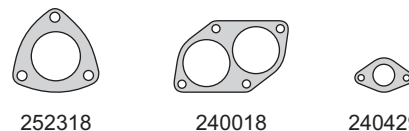

252318

240018

240429



R240411V



R240013V



R240415V

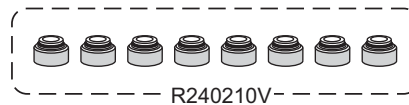

R240210V

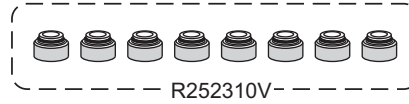

R252310V

**FIAT**



Motor/Engine	Cm³	HP	Ø
186A6	1910	110	82
192A1/A3	1910	115	82
188B2	1910	80	82
182B9 (SOHC) 8V	1910	100	82

**Fiat:** Marea JTD 2000/02  
Stilo JTD, Idea JTD, Punto 2003/...  
Palio JTD 2002/..., Strada



**DIESEL**

Nº OE	Descripción/Description	Mat.	Ref.
1718658	Jgo. de juntas para motor		252401-R
	Jgo. de juntas superior		252495
	Junta tapa cilindros Ø 83.0 ± 0.85	NFT	252407-SM
	Junta tapa cilindros Ø 83.0 ± 1.00	NFT	252407-1M
	Junta tapa cilindros Ø 83.0 ± 1.20	NFT	252407-2M
	Junta tapa cilindros Ø 83.0 ± 1.30	NFT	252407-3M
55190356	Junta tapa cilindros Ø 83.0 ± 0.82	MLS	252408-SM
55190357	Junta tapa cilindros Ø 83.0 ± 0.92	MLS	252408-1M
55190358	Junta tapa cilindros Ø 83.0 ± 1.02	MLS	252408-2M
7775920	Jgo. tornillos tapa cilindros (HAR14063)		B252000
	Sellador líquido - caucho de silicona		TRN0085G
46545441	Junta tapa válvulas	GS	1 1 252410
	Frente motor	NB	1 1 270612
46467747	Múltiple escape	AC	1 1 252015
46772389	Múltiple admisión	NFT	1 1 252117
46547895	Junta cuerpo mariposa acelerac	SLS	252426
46773082	Junta cuerpo mariposa	SLS	252428
	Guarnición goma llenado aceite	GS	1 1 270929
	Junta	SLS	1 1 251832
	Acople frente motor	SLS	1 270633
	Base bomba inyectora	NFT	1 1 251834
	Anillo goma G 66 x 72 x 3	GS	1 252036
	Arandelas pico inyector A 7 x 16 x 2 C	C	4 4
11198074	Arandela fijación A 8 x 15 x 1.5 C	C	3 3
	O´ring G 63.09 x 3.53	GS	1
	O´ring G 7.65 x 1.78	GS	2
	O´ring G 55.25 x 2.62	GS	1 1
	O´ring G 80 x 1.80	GS	1 1
	Kit de retenes completo		R252000
7553637	Jgo. retén válvulas (8)	V	1 R250410V
46435513	Porta retén bancada trasera	V	PR252011V
	Retén distribución 31 x 41 x 7	V	1 R252012V
6080949	Retén árbol de levas 30 x 42 x 7	V	1 R260113V

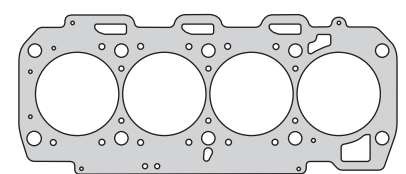

252408

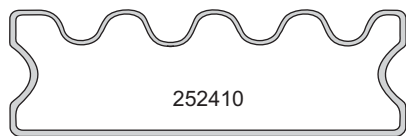

252410

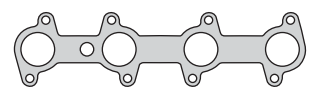

252015

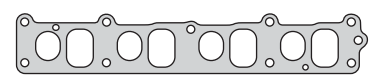

252117

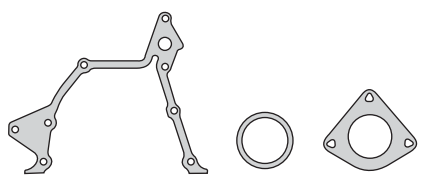

270612

270929

252426



252428



251832



270633

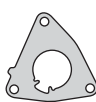

251834

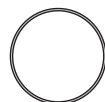

G 80 x 1.80



G 55.25 x 2.62



G 63.09 x 3.53

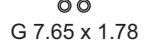

G 7.65 x 1.78



A 8 x 15 x 1.5 C

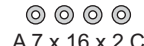

A 7 x 16 x 2 C



G 66 x 72 x 3

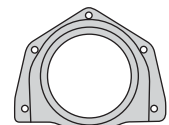

PR252011V



R260113V



R250410V

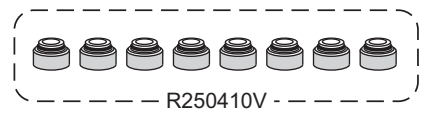

R250410V

# FIAT IVECO



Motor/Engine	Cm³	HP	Ø
8210.42E2 F1CE 0481 (DOHC) 16V	2998	136/155	95.8

Iveco: Daily, 40 S14, 3.0 HPI, Euro III TD  
55 C16, 3.0 HPI, Euro III TD 2008/...



DIESEL

Nº OE	Descripción/Description	Mat.		Ref.
02995572	Jgo. de juntas para motor			252701-R
	Jgo. de juntas superior			252795
	Jta. tapa cilindros Ø 100 $\pm$ 1.30	NFT		252707-1M
	Jta. tapa cilindros Ø 100 $\pm$ 1.40	NFT		252707-2M
	Jta. tapa cilindros Ø 100 $\pm$ 1.50	NFT		252707-3M
504093499	Jta. tapa cilindros Ø 96.8 $\pm$ 1.20	MLS		252708-1M
	Jta. tapa cilindros Ø 96.8 $\pm$ 1.30	MLS		252708-2M
	Jta. tapa cilindros Ø 96.8 $\pm$ 1.40	MLS		252708-3M
504047676	Junta tapa de válvulas	SLS	1	252710
504083813	Junta para cárter	GS	1	252711
504082437	Placa distribución	NB	1	252712
	O'ring asiento bomba de agua G 94.84 x 3.53	GS	1	252714
504167862	Jgo. múltiple escape (3)	AC	1	252715
504022754	Múltiple escape	GFT	1	252716
504047974	Múltiple admisión	SLS	1	252717
504072973	Salida de escape	AC	1	252718
504081697	Bomba aceite	SLS	1	252727
504090818	Junta posterior tapa cilin. intercambiador/calor	SLS	1	252728
500370706	Descarga aceite turbo	GFT		252729
504089123	Base cambiador temperatura	SLS	1	252731
504080013	Bomba de agua	SLS	1	252732
	Junta cámara trasera botadores	SLS	1	252734
504090524	Junta cuerpo regulador temperatura	SLS	1	252735
504059849	Junta tapa delantera árbol levas	GS	1	252736
504196620	Junta tubería colectores	SLS		252739
504196616	Junta unión pestaña a tapa	SLS		252742
504135162	Junta soporte bomba aceite	SLS	1	252743
504077555	Junta acople enfriador aceite	SLS		252744
504032165	Guarnición inyectores tapa válvula G 32 x 26 x 14	AC/P	4	252745
4834948	Salida de escape turbo	AC	1	270345
17290481	O'ring soporte trasero G 69.44 x 3.53	GS	2	252746
4834948	Junta entrada turbo	AC	1	500546
	Jgo. juntas turbo (3)	VS		252768
	O'ring G 63.17 x 2.62	GS	1	
	O'ring G 47 x 5	GS	1	
	O'ring G 45.69 x 2.62	GS	1	
172954800	O'ring G 37.47 x 3.53	GS	1	
	O'ring G 34.59 x 2.62	GS	1	
172828810	O'ring G 28.24 x 2.62	GS	4	
	O'ring G 23.47 x 2.62	GS	1	
	O'ring G 23.47 x 2.62	GS	1	
	O'ring G 17.17 x 1.78	GS	1	
	O'ring G 9 x 2	GS	2	
	O'ring G 6 x 2	GS	1	
16508560	Arandela tapa de cilindro A 26 x 32 x 1.50 C	CU	1	
	Arandela tapón cárter A 22 x 28 x 1.50 C	CU	1	
	Arandela A 20 x 26 x 1 C	CU	1	
	Arandela A 17 x 21 x 1.50 C	CU	1	
	Arandela A 14 x 20 x 1.50 C	CU	1	
	Arandela A 12 x 18 x 1.50 C	CU	6	
	Arandela A 10 x 14 x 1 C	CU	1	
	Kit de retenes completo			R252700
500395378	Jgo. retén válvulas (16)	V	1	R252710V

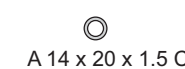
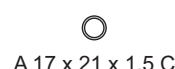
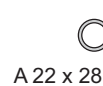
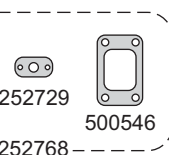
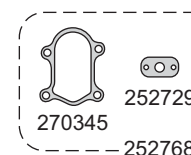
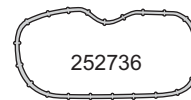
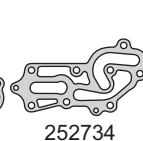
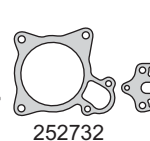
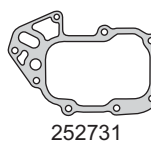
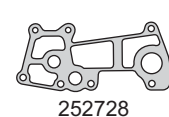
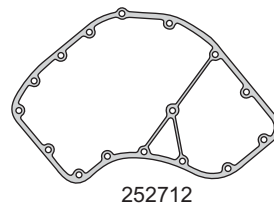
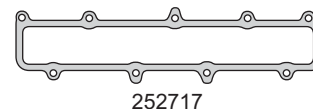
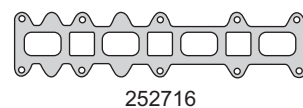
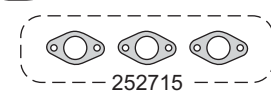
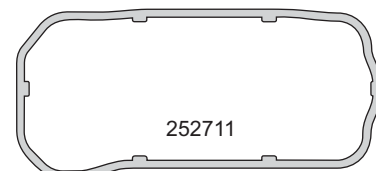
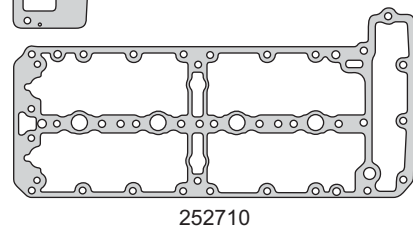
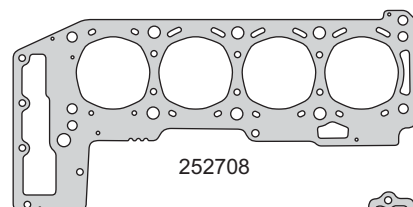





FIAT



Motor/Engine	Cm³	HP	Ø
F1AE (DOHC) 16V	2286	110/120 127	88

**Fiat:** Ducato JTD 2002/..., 2006/...  
**Iveco:** Cargo, Maxicargo, Furgon, Multijet 2010/...

DIESEL



Nº OE	Descripción/Description	Mat.	Ref.
	Jgo. de juntas para motor		252801-R
500387067	Junta tapa cilindros Ø 89.0 $\pm$ 1.10	MLS	252808-1M
500387068	Junta tapa cilindros Ø 89.0 $\pm$ 1.20	MLS	252808-2M
500387069	Junta tapa cilindros Ø 89.0 $\pm$ 1.30	MLS	252808-3M
	Jgo. tornillos tapa cilindros (HAE14038/18038)		B252800
	Junta tapa válvulas	SLS	1 252810
504018307	Junta para cárter	GS	1 252811
504012746	Junta distribución	NB	1 252812
	O´ring asiento bomba de agua G 94.92 x 2.62	GS	1 252714
504022754	Múltiple escape	GFT	1 252816
504037859	Múltiple admisión	NB	1 252817
500370706	Junta descarga aceite turbo	GFT	1 252729
	Junta	GS	1 252836
	Junta acople árbol de levas	GS	1 252837
500326581	Bridas turbo	AC	5 251145
504032165	Guarnición inyectores tapa válvula	AC/P	4 252745
4834948	Junta escape turbo	AC	1 270345
500378462	Junta acople turbo	AC	1 252846
	O´ring G 63.09 x 3.53	GS	1
	O´ring G 37.47 x 5.33	GS	1
	O´ring G 29.74 x 3.53	GS	2
	O´ring G 28.17 x 3.53	GS	1
	O´ring G 23.47 x 2.62	GS	1
	O´ring G 21.82 x 3.53	GS	1
	O´ring G 7.94 x 1.78	GS	4
	O´ring G 6 x 2	GS	2
	O´ring G 52.07 x 2.62	GS	1
	O´ring G 32.69 x 5.33	GS	1
	O´ring G 36 x 2	GS	1
	O´ring G 42 x 3	GS	1
	Anillo G 80 x 88 x 5	GS	1
	Arandela A 21 x 24 x 1.5 A	AL	1
	Arandela A 17 x 21 x 1.5 A	AL	1
	Arandela A 12 x 18 x 1.5 A	AL	3
	Arandela A 12 x 16 x 1.5 A	AL	8
	Arandela A 10 x 14 x 1.5 A	AL	2
	Arandela A 18 x 22 x 1.5 A	AL	1
	Arandela A 8 x 13 x 1.5 A	AL	1
	Kit de retenes completo		R252700
500395378	Jgo. retén válvulas (16)	V	1 R252710V
504014232	Retén trasero bancada 83 x 113 x 14	V	1 R252811V
504056152	Retén delantero distribución 50 x 80 x 14	V	1 R252812V
504050244	Retén respiradero motor 34 x 60 x 10	V	1 R252815V

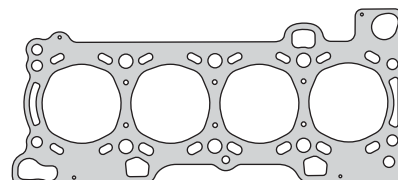

252808

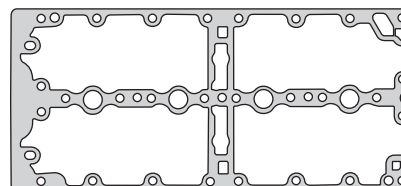

252810

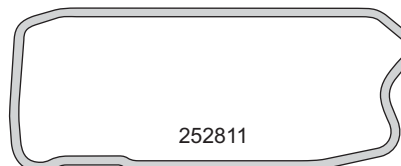

252811

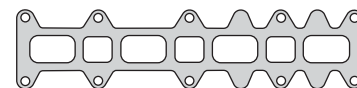

252816

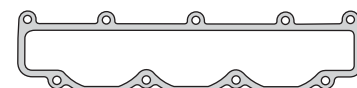

252817

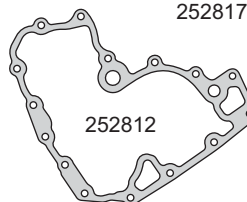

252812



252714

252729

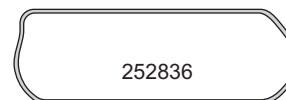

252836



252837



252745



270345



252846



251145



A 12 x 16 x 1.5 A



A 12 x 18 x 1.5 A



A 17 x 21 x 1.5 A



A 10 x 14 x 1.5 A



A 18 x 22 x 1.5 A



A 8 x 13 x 1.5 A



R252811V

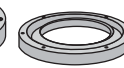

R252812V



R252815V

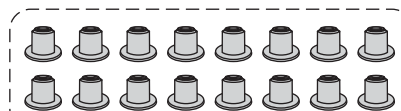

R252710V

# FIAT IVECO



Motor/Engine	Cm³	HP	Ø
8140.43 Euro II 8140.43S Euro III (SOHC) 8V Common Rail	2798	122/125	94.4

**Fiat:** Ducato JTD 2006/09  
**Iveco:** Daily 35.13, 35.13 4x4, 38.13, 40.13  
 50.13, 60.13, 70.13 2005/10  
**Peugeot:** Boxer TDI/HDI 2001/09  
**Renault:** Jumper HDI 2001/09

DIESEL



Nº OE	Descripción/Description	Mat.	Ref.
	Jgo. de juntas para motor		252901-R
99432354	Junta tapa cilindros Ø 96.0 ± 1.30	NFT	270107-SM
99432353	Junta tapa cilindros Ø 96.0 ± 1.40	NFT	270107-1M
99460983	Junta tapa cilindros Ø 96.0 ± 1.50	NFT	270107-2M
99458402	Junta tapa cilindros Ø 96.0 ± 1.60	NFT	270107-3M
48281505	Jgo. tornillos tapa cilindros (HAS17038)		B270100
500388381	Junta tapa válvulas	N	1 251110
99488486	Junta para cárter	CG	1 270311
	Frente distribución	NB	1 270112
98434020	Jgo. múltiple escape (4)	NFT	1 270116
98425767	Jgo. múltiple admisión (4)	NFT	1 270117
98421297	Porta termostato	NB	1 270119
	Bomba vacío	NB	1 270131
	Filtro aceite	NB	1 270132
	Filtro aceite	NB	1 270332
98430444	Comando bomba inyectora	NB	1 270135
	Junta base filtro aceite	NB	1 270136
98430478	Brida agua	NB	1 270137
99432807	Intermedio block izquierdo esp. 2.5	GS	1 270338
	Anillo termostato	GS	1 330638
99432808	Intermedio block derecho esp. 2.5	GS	1 270339
	Tapa inspección block trasera	NB	1 270340
98426170	Colector admisión	NB	1 270341
98484659	Colector a turbo	AC	1 270345
	Guarnición termostato	GS	1 460245
99436990	Escape a turbo	AC	1 270347
	Salida aceite a turbo	NB	1 271147
	O'ring G 9.25 x 1.78	GS	4
	O'ring G 13.11 x 2.62	GS	1
	O'ring G 17.17 x 1.78	GS	6
	O'ring G 18.64 x 3.53	GS	1
	O'ring G 21.89 x 2.62	GS	1
	O'ring G 22.2 x 3.5	GS	2
	O'ring G 23.47 x 2.62	GS	1
	O'ring G 28.24 x 2.62	GS	1
	O'ring G 29.82 x 2.62	GS	1
	O'ring G 39.34 x 2.62	GS	1
	O'ring G 44.04 x 3.53	GS	1
	O'ring G 47.22 x 3.53	GS	3
	O'ring G 48.90 x 2.62	GS	2
	O'ring G 55.25 x 2.62	GS	1
	O'ring G 56.87 x 1.78	GS	1
	O'ring G 59.92 x 3.53	GS	1
	O'ring G 64.77 x 2.62	GS	1
	O'ring G 94.84 x 3.53	GS	1
	O'ring G 98.02 x 3.53	GS	1
	Arandela A 7 x 13 x 1.5 A	AL	1
	Arandela A 8 x 14 x 1 C	CU	5
4858606	Arandela A 10 x 14 x 1 C	CU	6
	Arandela A 12 x 16 x 1.5 C	CU	1
4858607	Arandela A 12 x 17 x 1.5 C	CU	5
	Arandela A 12 x 18 x 1.5 C	CU	1
4858608	Arandela A 14 x 20 x 1.5 C	CU	10

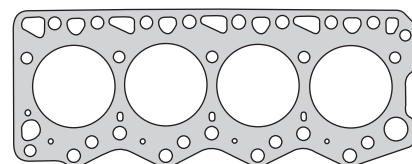

270107

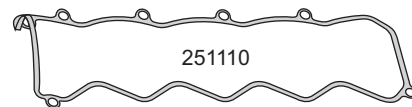

251110

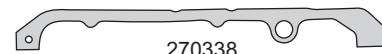

270338

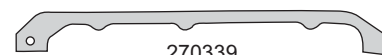

270339

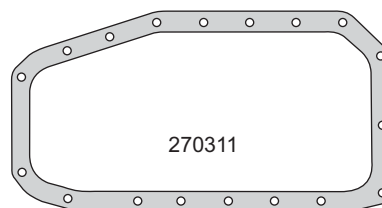

270311

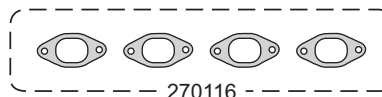

270116

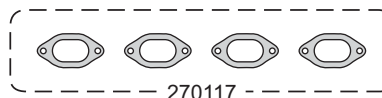

270117



270112



270119

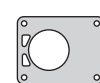

270131



270132



270332

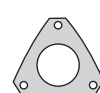

270135

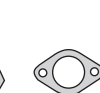

270137



270340



270341

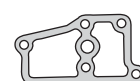

270136



270345



460245



270347



271147



G 94.84 x 3.53



330638



G 98.02 x 3.53



G 47.22 x 3.53



G 55.25 x 2.62



G 64.77 x 2.62



G 56.87 x 1.78



G 59.92 x 3.53



G 39.34 x 2.62

# FIAT IVECO



Motor/Engine	Cm³	HP	Ø
8140.43 Euro II 8140.43S Euro III (SOHC) 8V Common Rail	2798	122/125	94.4

DIESEL

**Fiat:** Ducato JTD 2006/09  
**Iveco:** Daily 35.13, 35.13 4x4, 38.13, 40.13  
 50.13, 60.13, 70.13 2005/10  
**Peugeot:** Boxer TDI/HDI 2001/09  
**Renault:** Jumper HDI 2001/09



Nº OE	Descripción/Description	Mat.	Ref.
	Arandela A 16 x 20 x 1 C	CU	4
	Arandela A 18 x 22 x 1.5 C	CU	1
	Arandela A 20 x 26 x 1 C	CU	2
	Arandela A 22 x 27 x 1.5 C	CU	1
	Kit de retenes completo		R251100
98472291	Jgo. retén válvulas (8)	V	1 R270110V
99468744	Porta retén bancada 1996/...	V	PR270111V
	Porta retén distribución 1996/...	V	PR270112V
98454045	Retén árbol levas 50 x 70 x 10	V	1 R270113V
98454041	Retén auxiliar 55 x 70 x 10	V	1 R270115V

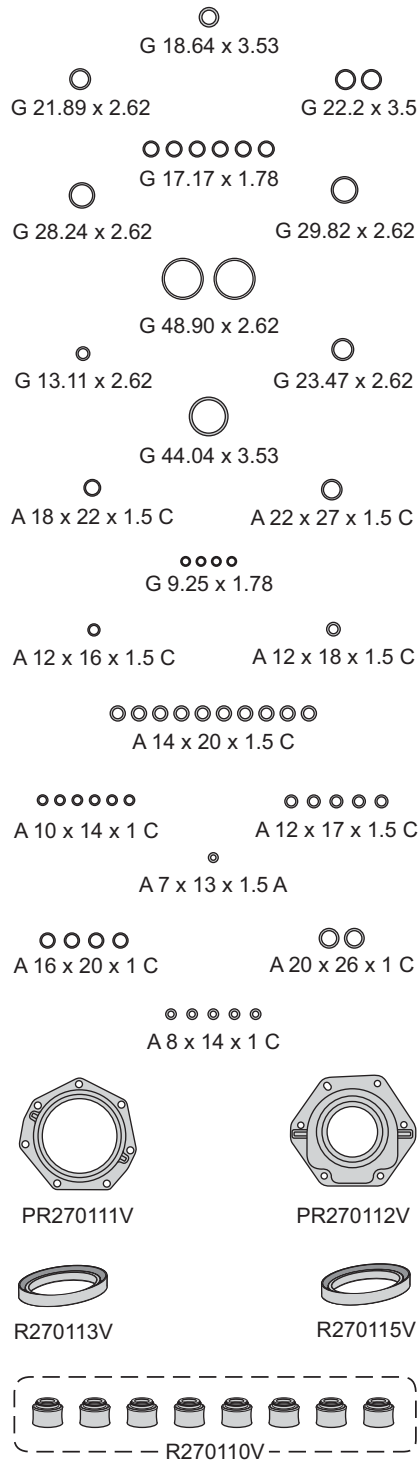

**FIAT**



Motor/Engine	Cm³	HP	Ø
Multijet TD (DOHC) 16V	1956	170	83

Fiat: Toro 2016/...  
Jeep: Renegade 2015/...

DIESEL



Nº OE	Descripción/Description	Mat.	Ref.
	Jgo. de juntas para motor		253001-R
	Junta tapa cilindros Ø 84.0 ± 1.20	NFT	253007-SM
	Junta tapa cilindros Ø 84.0 ± 1.30	NFT	253007-1M
	Junta tapa cilindros Ø 84.0 ± 1.40	NFT	253007-2M
55211409	Junta tapa cilindros Ø 84.0 ± 0.95	MLS	253008-SM
55211410	Junta tapa cilindros Ø 84.0 ± 1.05	MLS	253008-1M
55211411	Junta tapa cilindros Ø 84.0 ± 1.15	MLS	253008-2M
6809298AA	Jgo. tornillos tapa cilindros (HAR12063)		B253000
	Sellador líquido - caucho de silicona		TRN0085G
55248941	Junta tapa válvulas	SLS 1	253010
	Junta distribución	AC 1	253012
46772635	Bomba de agua	SLS 1	253014
55222403	Múltiple escape	AC 1	253015
71754211	Jgo. múltiple admisión (6)	GS 1	253017
55212676	Junta conexión agua	AC/GS 1	253027
55252555	Guarnición goma	GS 1	253030
55254236	Junta electroválvula	SLS 1	253031
55254383	Junta	SLS 1	253032
55207398	Junta retorno aceite a turbo	SLS 1	253033
55212608	Guarnición goma	GS 1	253034
55252561	Junta	AC 1	253035
	Kit turbocompresor (11)	VS 1	253040
55212785	Junta turbocompresor	AC 1	253041
	Junta turbocompresor	SLS 1	253042
51823801	Anillo tubo de escape	AC 1	253043
	Arandela especial A 15.5 x 26 x 1.5 A	AC/GS 1	
55221016	Arandela inyector A 7.5 x 15 x 2 C	CU 4	
55232972	Arandela entrada aceite turbo A 10 x 16 x 1 A	AL 4	
	Arandela A 7.5 x 15.3 x 1.53	AL 4	
	Arandela A 10 x 14 x 1.50	AL 4	
14463786	O'ring G 32 x 3.53	GS 1	
14458081	O'ring G 28.5 x 2.65	GS 1	
	O'ring G 15 x 2.50	GS 3	
	Kit de retenes completo		R253000
55183812	Jgo. retén válvulas (16)	V 1	R253010V
55272147	Porta retén bancada	V	PR270911V
7628850	Retén distribución 31 x 45 x 8	V 1	R250255N
46802577	Retén árbol de levas 30 x 45 x 7	P 1	R253013P

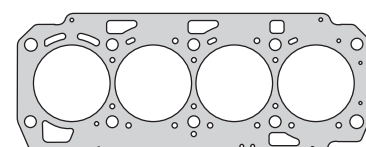

253008

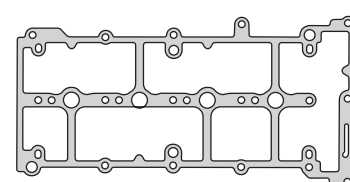

253010



253015



253017

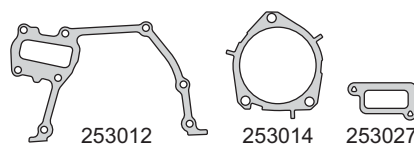

253012

253014

253027

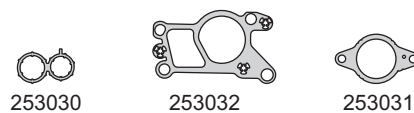

253030

253032

253031



253033

253034

253035

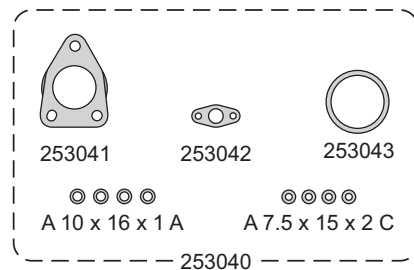

253041

253042

253043

253040

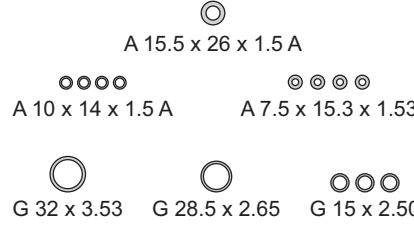

G 32 x 3.53

G 28.5 x 2.65

G 15 x 2.50

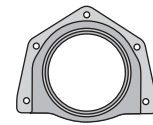

PR270911V



R250255N



R253013P

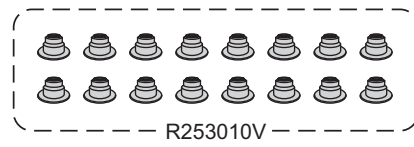

R253010V

FIAT



Motor/Engine	Cm³	HP	Ø
4TD - 146B (SOHC) 8V	1301	45	76.1

Fiat: 147, Duna, Fiorino, Spazio, Uno 1985/...

DIESEL

Nº OE	Descripción/Description	Mat.	Ref.
5881359	Jgo. de juntas para motor		260001-R
	Jgo. de juntas superior	●	260095-SM
	Jgo. de juntas superior		260095-1M
	Jgo. de juntas superior		260095-2M
	Jgo. de juntas superior		260095-3M
	Jgo. juntas superior sin JTC		260096
	Junta tapa cilindros Ø 77.0 ± 1.85	NFT	260005-1M
	Junta tapa cilindros Ø 77.0 ± 1.95	NFT	260005-2M
	Junta tapa cilindros Ø 77.0 ± 2.30	NFT	260005-3M
4467996	Junta tapa cilindros Ø 77.0 ± 1.60	NFT	260007-SM
4467997	Junta tapa cilindros Ø 77.0 ± 1.80	NFT	260007-1M
4467998	Junta tapa cilindros Ø 77.0 ± 1.95	NFT	260007-2M
	Junta tapa cilindros Ø 77.0 ± 2.20	NFT	260007-3M
	Jgo. tornillos tapa cilin. (HAS13038/17038)		B260000
4424154	Junta tapa válvulas superior	NB	1 1 260010
4249510	Junta para cárter	CG	1 260011
4249516	Tapa distribución	CB	1 260012
4249517	Placa distribución	NB	1 260013
4346415	Cuerpo bomba de agua	NB	1 1 260014
4398359	Jgo. múltiple admisión y escape (2)	NFT	1 1 260016
	Salida de escape	FCH	1 1 260018
4250780	Base bomba de agua	CB	1 1 260019
4250500	Cuerpo bomba aceite	CB	1 260027
4193959	Superior bomba de agua	NB	1 1 250429
4296113	Tapa cámara agua	NB	1 1 260029
4249520	Tapa árbol levas	NB	1 1 260030
4386806	Tapa block lado placa	CB	1 260033
4477229	Tapa block lado volante	CB	1 260034
4434100	Colector aspiración	NB	1 260035
	Arandela parallamas	AC	4 560036
4193959	Entre bomba agua y tubo	NB	260037
4109133	Tapón orificio distribución	NB	1 260038
4184495	Termostato	GS	1 1 260039
5948368	Tapa bomba agua	NB	1 1 260040
4351195	Base termostato	NB	1 1 260041
4325360	Tapa retén aceite	NB	1 1 260042
	Bomba depresora	NB	1 1 260043
4249510	Junta para cárter	CGT	260060
	O'ring depresora G 39.34 x 2.62	GS	
	O'ring depresora G 5.34 x 1.78	GS	
	Kit de retenes completo		R260000
	Jgo. retén válvulas (8)	V	1 R250410V
	Retén bancada 70 x 85 x 8	P	1 R260011P
	Retén distribución 40 x 56 x 7	P	1 R250412P
	Retén árbol levas 30 x 52 x 7	P	2 R250413P

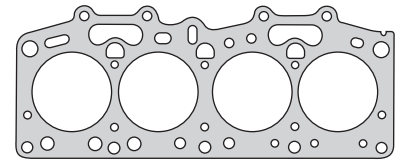

260007

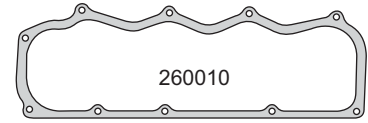

260010

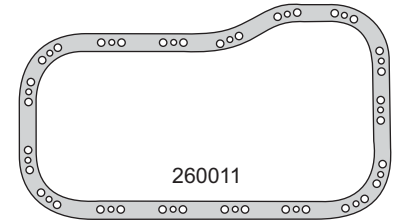

260011

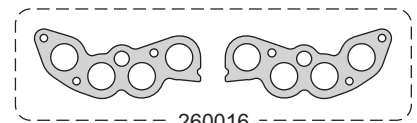

260016

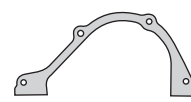

260012

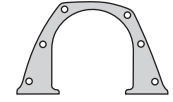

260013



260014

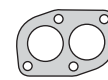

260018



260019



260027



250429



260029



260030

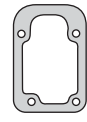

260033



260034



260040



260035



560036



G 5.34 x 1.78



260037



260038



260039



260041



260042



260043



G 39.34 x 2.62



R260011P



R250412P



R250413P

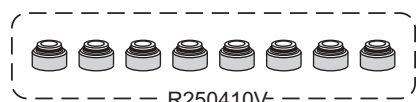

R250410V

**FIAT**



Motor/Engine	Cm³	HP	Ø
835C	1756	90/105	84
836A	1756	90/101	84
154C	1987	90/110	84
831C	1995	177	84
834B	1995	115	84

(DOHC) 8V

**Fiat:** Regatta 2000, Bialbero, Tempra 1989/...  
Tempra, Tipo 1992/95  
**Lancia:** Delta, Dedra 1993/99  
Thema, Delta Turbo 1987/94

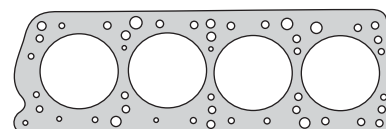

260105

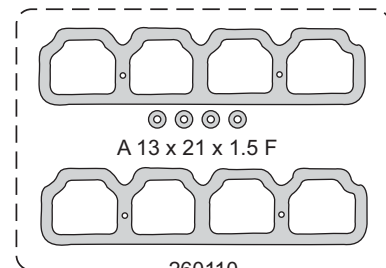

260110

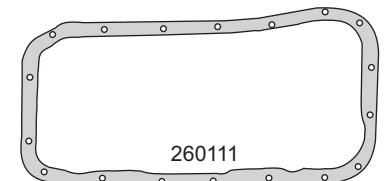

260111

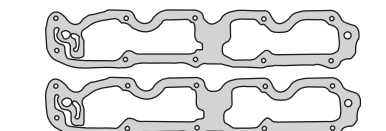

260131



250716



260117

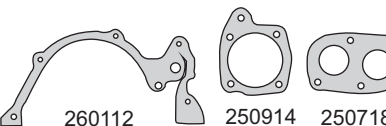

260112

250914

250718

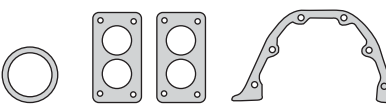

250919

260125

250729



260130

260129

250935

260137



260138

260139

260140

260141



260142

A 14 x 20 x 2 C

260143



R260111P



R260112P



R250413P



R250410V

Nº OE	Descripción/Description	Mat.	Ref.
	Jgo. de juntas para motor		260100-R
7604263	Junta tapa cilindros Ø 85.0 ± 1.70	NFT	1 260105
5959226	Junta tapa cilindros Ø 85.0 ± 1.70	NFT	260107
	Jgo. tornillos tapa cilindros (HAR12063)		B260100
7574967	Conj. junta tapa válvulas (6)	NB	2 260110
	Junta para cárter	CG	1 260111
7589509	Tapa distribución	NB	1 260112
4475631	Bomba de agua	NB	1 250914
4177112	Múltiple escape	NFT	1 250716
7546474	Múltiple admisión	NFT	1 260117
4176386	Salida de escape	FCH	1 250718
5949822	Termostato	GS	250919
	Jgo. juntas carburador WEBER 34 DMTR	VS	260120
97053371	Base carburador	NB	2 260125
4161222	Tapa carga aceite	GS	1 260129
4129763	Porta retén bancada trasera	NB	1 250729
7547667	Inspección árbol levas	NB	2 260130
5966008	Caballote T.V.	NFT	2 260131
4337093	Filtro aceite	NB	1 250935
5969318	Aspirador bomba aceite	NB	1 260137
5960717	Inspección agua a block	NB	1 260138
5873131	Tubo respiración	NB	1 260139
7541231	Tapa base termostato	NB	1 260140
5923392	Inferior base termostato	GS	1 260141
5972773	Cuerpo respiradero o-ring G 36 x 3	GS	1 260142
	Arandela tapa valvulas A 13 x 21 x 1.5 F	F	4 250742
4158100	Cuerpo inferior respiradero	NB	1 260143
10280060	Perilla tapa botadores A 14 x 20 x 2 C	CU	4 260144
	Junta tapa cilindros competición (1.00)	NFT	260190-1.0
	Kit de retenes completo		R260400
	Jgo. retén válvulas (8)	V	1 R250410V
	Retén bancada 74 x 90 x 10	P	1 R260111P
	Retén distribución 30 x 43 x 8	P	1 R260112P
	Retén árbol levas 30 x 52 x 7	P	2 R250413P

FIAT



Motor/Engine	Cm³	HP	Ø
160A1	1372	71	80.5
146C1/5	1372	67/72	80.5
159A2 (SOHC) 8V	1372	78	80.5

Fiat: Spazio, Duna, Tipo, Uno, Vivace  
Palio, Siena 1988/91, Fiorino 1993/95



Nº OE	Descripción/Description	Mat.	Ref.
	Jgo. de juntas para motor		260200-R
	Jgo. de juntas superior	●	260295
	Jgo. de juntas superior (JTC 07)		260297
7663366	Jta. tapa cilindros Ø 82.0 ± 1.70	NFT 1 1	260205
	Jta. tapa cilindros Ø 82.0 ± 2.40	NFT	260206
7604403	Jta. tapa cilindros Ø 82.0 ± 1.65	NFT	260207
	Jta. tapa cilindros Ø 82.0 ± 1.60	MLS	260208
	Jgo. tornillos tapa cilindros (HAS15038)		B260200
7554851	Junta tapa válvulas	CG	260210
7797034	Junta tapa válvulas 1996/...	CG 1 1	260310
	Junta tapa válvulas super medida (4.00)	CG	260310-SM
	Junta para cárter	CG 1	260211
4179117	Tapa distribución	NB 1	250412
97052378	Bomba de agua	NB 1	250414
7665722	Múltiple admisión y escape	NFT 1 1	260216
	Salida de escape	FCH 1 1	250618
	Acople salida de escape	AC	260218
46584559	Termostato	NB 1 1	260219
7770023	Bomba de agua a block	NB 1	260319
	Jgo. juntas carburador WEBER 32/34 TLDE	VS	260220
4428157	Base carburador	NB 1 1	250425
	Base superior carburador WEBER	NB 1	260325
97053371	Base carburador	NB 2 2	260225
	Tapa carburador WEBER TLDE	NB	260226
4179113	Base bomba nafta 0.8	NB 1	250128
4205663	Separador bomba nafta 0.5	NB 1	250428
4193959	Superior bomba agua	NB 1	250429
4194902	Brida caño calefactor	NB 1	250430
	Base inferior carburador WEBER	NB 1	260330
7633424	Caballote T.V.	NB	260231
7784728	Caballote T.V. (1993/)	NB 1 1	260331
5937811	Tapa inspección block (lado volante)	NB 1	250633
7597760	Tapa inspección block	NB	260234
4195119	Tapa inspección cigüeñal	NB 1	250434
7575660	Tapa inspección block (lado dist.)	NB 1	250634
4179117	Tapa inspección árbol levas	NB 1 1	250435
7668667	Tapa inspección cigüeñal	NFT 1	260235
7615049	base termostato	NB 1 1	260237
4179148	Brida caño aceite	NB 1	250438
4179138	Base bomba aceite	NB 1	250439
4230783	Bomba aceite tubo escape	NB 1	250440
	Unión caño escape	AC	260240
7737202	Porta retén bancada trasera	NB 1	260241
4158100	Caño respiradero cárter	NB 1	250442
4109133	Apoyo distribuidor	NB 1	250443
4179114	Separador bomba nafta 0.8	NB 1	250445
4205664	Separador bomba nafta 1.5	NB 1	250446
	O'ring bomba nafta G 31. 42 x 2. 62	GS 2	260247
7663366	Junta para cárter	CGT	260260
	Kit de retenes completo		R260200
	Jgo. retén válvulas (8)	V 1	R250410V
	Retén bancada 64 x 80 x 8	P 1	R250111P
	Retén distribución 40 x 56 x 7	P 1	R250412P
	Retén árbol levas 30 x 52 x 7	P 2	R250413P

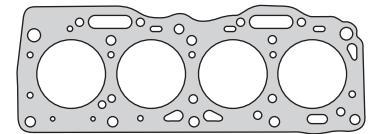

260205

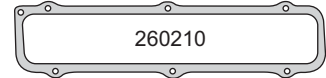

260210

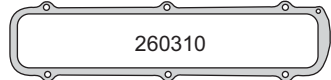

260310

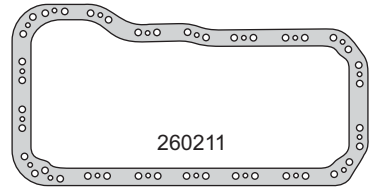

260211

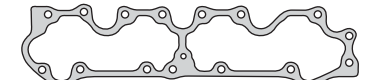

260231



260331



260216

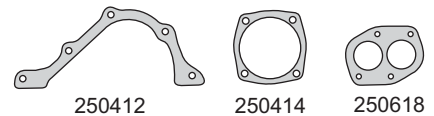

250412

250414

250618

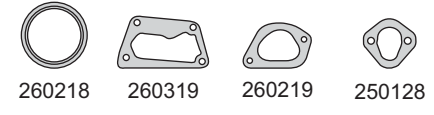

260218

260319

260219

250128

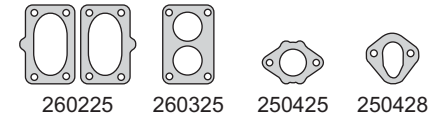

260225

260325

250425

250428

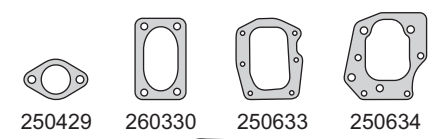

250429

260330

250633

250634



250430

260235

250435

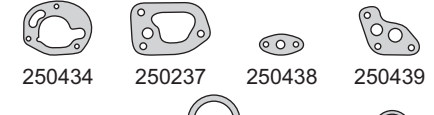

250434

250237

250438

250439



250440

250442

250443



250445

260241

250446

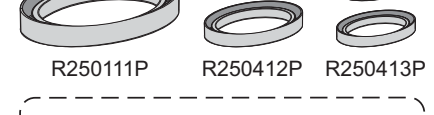

R250111P

R250412P

R250413P



R250410V



**FIAT**



Motor/Engine	Cm³	HP	Ø
SEVEL	1581	84/88	86.4
146C6	1581	75	86.4
159A3	1581	76/86	86.4
160A2	1581	82	86.4
835A (SOHC) 8V	1581	80/90	86.4

**Fiat:** Duna, Uno, Regatta, Palio, Siena Premio, Elba, Tipo, Fiorino 1988/...

**Lancia:** Dedra 1989/93



Nº OE	Descripción/Description	Mat.	Ref.
	Jgo. de juntas para motor		<b>260300-R</b>
	Jgo. de juntas superior	●	<b>260395</b>
	Jgo. de juntas superior (JTC 07)		<b>260397</b>
7604404	Jta. tapa cilindros Ø 88.0 $\pm$ 1.70	NFT 1 1	<b>260305</b>
	Jta. tapa cilindros Ø 88.0 $\pm$ 2.40	NFT	<b>260306</b>
7604404	Jta. tapa cilindros Ø 88.0 $\pm$ 1.70	NFT	<b>260307</b>
	Jta. tapa cilindros Ø 88.0 $\pm$ 1.60	MLS	<b>260308</b>
	Jgo. tornillos tapa cilindros (HAS15038)		<b>B260200</b>
7554851	Junta tapa válvulas	CG	260210
7797034	Junta tapa válvulas 1996/...	CG 1 1	260310
7663366	Junta para cárter	CG 1	260211
4179117	Tapa distribución	NB 1	250412
97052378	Bomba de agua	NB 1	250414
7665722	Múltiple admisión y escape	NFT 1 1	260216
7772495	Múltiple admisión y escape	GFT	260316
	Acople salida de escape	AC	260218
	Salida de escape	FCH 1 1	250618
46584559	Termostato	NB 1 1	260219
97052379	Bomba de agua a block	NB 1	260319
	Jgo. juntas carburador WEBER 32/34 TLDE	VS	260220
	Jgo. juntas carburador WEBER	VS	260221
	Jgo. juntas carburador WEBER TLDF	VS	260222
4428157	Junta base carburador	NB 1	250425
97053371	Junta base carburador WEBER TLDE	NB 2	260225
	Base carburador WEBER TLDE	NB 1 1	260325
4179113	Tapa bomba nafta 0.8	NB 1	250128
4205663	Separador bomba nafta 0.5	NB 1	250428
4193959	Superior bomba agua	NB 1	250429
	Base carburador WEBER	NB 1 1	260330
4194902	Brida caño calefactor	NB 1	250430
7633424	Caballote T.V.	NB	260231
7784728	Caballote T.V. 1993/...	NB 1 1	260331
5937811	Tapa inspección block (lado volante)	NB 1	250633
7597760	Tapa inspección block	NB	260234
7575660	Tapa inspección block (lado dist.)	NB 1	250634
4195119	Tapa inspección cigüeñal	NB 1	250434
7668667	Tapa inspección cigüeñal	NFT 1	260235
4179117	Tapa inspección árbol levas	NB 1 1	250435
7615049	Base termostato	NB 1 1	260237
4179148	Brida caño aceite	NB 1	250438
4179138	Base bomba aceite	NB 1	250439
4230783	Bomba aceite tubo escape	NB 1	250440
4302267	Porta retén bancada trasera	NB 1	260241
4158100	Caño respiradero cárter	NB 1	250442
4109133	Apoyo distribuidor	NB 1	250443
4179114	Separador bomba nafta 0.8	NB 1	250445
4205664	Separador bomba nafta 1.5	NB 1	250446
	O'ring bomba nafta G 31.42 x 2.62	GS 2	260247
7663366	Junta para cárter	CGT	260260
	Kit de retenes completo		R260200
	Jgo. retén válvulas (8)	V 1	R250410V
	Retén bancada 64 x 80 x 8	P 1	R250111P
	Retén distribución 40 x 56 x 7	P 1	R250412P
	Retén árbol levas 30 x 52 x 7	P 2	R250413P

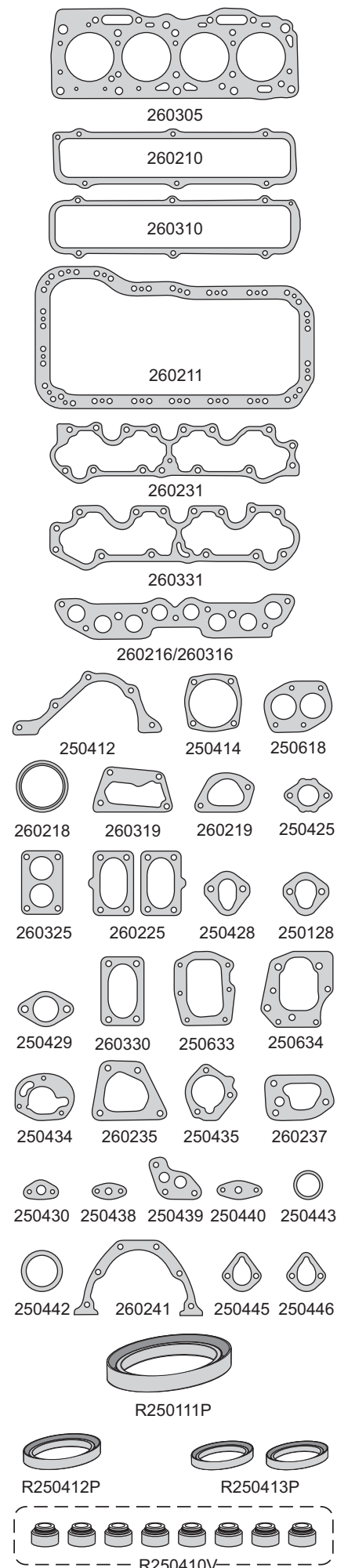

**FIAT**



Motor/Engine	Cm³	HP	Ø
149B - 146B 831D (SOHC) 8V	1697 1929	60 65	82.6 82.6
<b>DIESEL</b>			

**Fiat:** Duna, Uno, Regatta, Fiorino 1985/...  
**Lancia:** Prisma 1986/91



Nº OE	Descripción/Description	Mat.		Ref.
	Jgo. de juntas para motor			260401-R
	Jgo. de juntas superior			260495-SM
	Jgo. de juntas superior			260495-1M
	Jgo. de juntas superior			260495-2M
	Jgo. de juntas superior			260495-3M
	Jgo. juntas superior sin JTC			260496
	Junta tapa cilindros Ø 84.0 ± 1.85	NFT		260405-1M
	Junta tapa cilindros Ø 84.0 ± 1.95	NFT		260405-2M
	Junta tapa cilindros Ø 84.0 ± 2.30	NFT		260405-3M
7759146	Junta tapa cilindros Ø 84.0 ± 1.70	NFT		260407-SM
7759147	Junta tapa cilindros Ø 84.0 ± 1.80	NFT	1	260407-1M
7759148	Junta tapa cilindros Ø 84.0 ± 1.95	NFT		260407-2M
7759149	Junta tapa cilindros Ø 84.0 ± 2.20	NFT		260407-3M
	Jgo. tornillos tapa cilindros (HAR12063)			<b>B260400</b>
7702774	Junta tapa válvulas	NB	1 1	260410
7647596	Junta para cárter	CG	1	260411
7625508	Tapa distribución	NB	1	260112
	Bomba de agua tapa DUNA/PALIO/SIENA 1.9	NB		270014
7702770	Cuerpo bomba de agua	NB	1 1	260414
7765454	Múltiple admisión y escape turbo (NFT/CHA)	NFT	1	260415
7765454	Múltiple admisión y escape	NFT	1	260416
4364121	Bomba de agua a tapa de cilindros	NB	1 1	260419
	Base filtro aceite	NB	1	260427
4129763	Porta retén bancada trasera	NB	1	250729
4161222	Tapa carga aceite	GS	1	260129
7702773	Tapa cámara agua	NB	1 1	260429
7702766	Soporte bomba inyectora	NB	1	260430
7702772	Termostato	NB	1 1	260431
	Tapa cámara agua	NB	1 1	260432
7702131	Tapa cámara block	NB	1	260433
7702769	Tapa soporte árbol levas	NB	1 1	260434
7696793	Tapa block lado distribución	CB	1	260435
7565461	Arandela parallamas	AC	4	560036
	Bomba de agua tapa DUCATO	NB	1	260436
5969318	Aspirador bomba aceite	NB	1	260137
7702768	Tapa árbol levas	NB	1 1	260437
7668658	Inspección agua block	NB	1	260138
	Salida agua	CB	1	260439
	Brida	NFT	2	260440
	Brida	NFT	1	260441
4158100	Anillo caño bomba agua G36.09 x 3.53	GS	1 1	260442
	Bomba depresora	NB		260043
10282458	Cuerpo inferior respiradero	NB	1	260143
	O'ring bomba depresora G 40.94 x 2.62	GS		260044
	Arandela conducto combust. A 25 x 29.5 x 1C	CU	4	260444
	Jgo. caja velocidades DUCATO todos	VS		270050
	O'ring bomba depresora G 5.34 x 1.78	GS		
	Kit de retenes completo			R260400
	Jgo. retén válvulas (8)	V	1	R250410V
	Retén bancada 74 x 90 x 10	P	1	R260111P
	Retén distribución 30 x 43 x 8	P	1	R260112P
	Retén árbol levas 30 x 52 x 7	P	2	R250413P

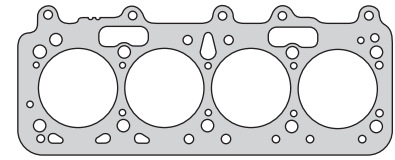

260407

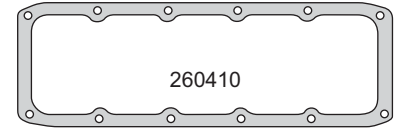

260410

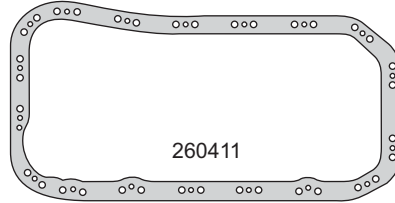

260411



260415



260112



260414

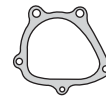

270014

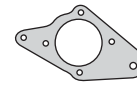

260419

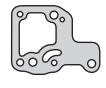

260427



260429

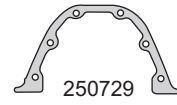

250729



260129



260430



260431



260432

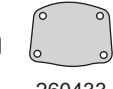

260433



260434



260435

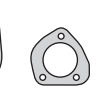

260437



260436



560036



260137



260138



260439



260440



260441



260442

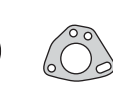

260043



260143



A 25 x 29.5 x 1 C



260044



R260111P



R260112P



R250413P

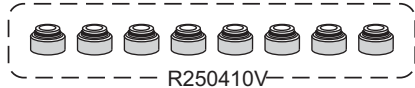

R250410V

**FIAT**



Motor/Engine	Cm³	HP	Ø
127AB 206	1049	60/70	76
127AB 2C (OHV) 8V	1300	60/70	76

Fiat: 147, Oggi, Panorama, Uno, Premio, Trend



Nº OE	Descripción/Description	Mat.	Ref.
7073000/418	Jgo. de juntas para motor		260500-R
	Jgo. de juntas superior		260595
5990020	Junta tapa cilindros Ø 77.0 ± 1.40	NFT	1 1 260505
	Jgo. tornillos tapa cilindros (HAS17038)		B260500
4323710	Junta tapa válvulas	CG	1 1 260510
4249510	Jgo. junta para cárter	CG	1 1 260011
4249516	Tapa distribución	CB	1 1 260012
4249517	Porta retén	NB	1 1 260013
4346415	Bomba de agua	NB	1 1 260014
4398359	Jgo. admisión y escape (2)	NFT	1 1 260016
	Salida de escape	FCH	1 1 260018
4250780	Bomba de agua	CB	1 1 260019
4206146	Base carburador	NB	1 1 250425
4250500	Aceite	CB	1 1 260027
4143730	Base bomba nafta	NB	1 1 250128
	Base bomba nafta (0,25)	NB	1 1 260528
4193959	Superior bomba de agua	NB	1 1 250429
4296113	Tapa delantera válvulas	NB	1 1 260029
	Base bomba nafta (0,80)	NB	1 1 260529
4249520	Tapa árbol levas	NB	1 1 260030
	Base bomba nafta (1,20)	NB	1 1 260530
	Junta tapa válvulas	NB	1 1 260531
4386806	Tapa block lado	CB	1 1 260033
4386808	Tapa block lado volante	CB	1 1 260034
4346834	Tensor de correa	NB	1 1 260534
4346836	Colector aspiración	NB	1 1 260035
4346833	Tapón block a volante	NB	1 1 260535
4427495	Respiradero motor	NB	1 1 260536
4193959	Entre bomba y tubo	NB	1 1 260037
4109133	Tapón orificio distribución	NB	1 1 260038
	Junta termostato	GS	1 1 260039
4351195	Base termostato	NB	1 1 260041
4325360	Tapa retén aceite	NB	1 1 260042
	Base bomba nafta	NB	1 1 250144
	Kit de retenes completo		R260000
	Jgo. retén válvulas (8)	V	1 R250410V
	Retén bancada 70 x 85 x 8	P	1 R260011P
	Retén distribución 40 x 56 x 7	P	1 R250412P
	Retén árbol de levas 30 x 52 x 7	P	2 R250413P

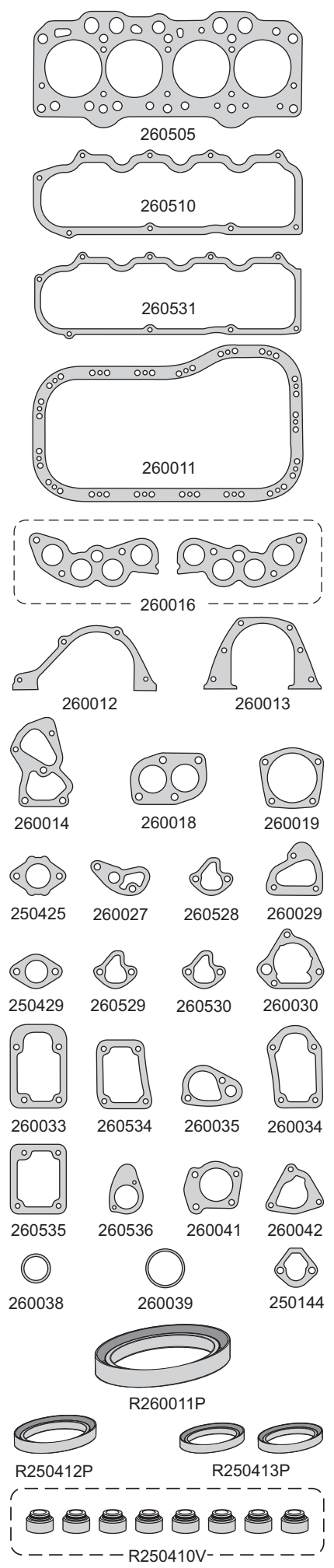

FIAT



Motor/Engine	Cm³	HP	Ø
160A	1995	126	84
154E	1995	140	84
836A	1995	145	84

Fiat: Tempra 1992/..., Tipo i.e. 1989/93  
Croma i.e. 1993/..., Coupe i.e - Turbo 1994



Nº OE	Descripción/Description	Mat.		Ref.
7076950	Jgo. de juntas para motor			260600-R
	Jgo. de juntas superior			260695
	Jta. tapa cilindros Ø 85.0 ±1.70	NFT	1 1	260105
7709257	Jta. tapa cilindros Ø 85.0 ±1.70	NFT		260107
	Jgo. tornillos tapa cilindros (HAR12063)			B260100
7527826	Jgo. juntas tapa válvulas (5)	N	1 1	260610
7646248	Jgo. junta para cárter	CG		260111
7589509	Tapa distribución	NB		260112
7679976	Bomba de agua	NB		250914
7700581	Múltiple escape	NFT	1 1	260616
7668195	Múltiple admisión con aislante bakelita	NB	1 1	260617
4176386	Salida de escape	FCH	1 1	250718
5949822	Termostato G 36 x 3	GS	1 1	250919
4161222	Tapa carga aceite	GS	1 1	260129
4129763	Porta retén bancada trasera	NB		250729
7748504	Inspección agua a block	SLS		260633
	Base termostato	NB	1 1	260634
7625793	Tubo respiradero	NB		260635
4337093	Filtro aceite	NB		250935
7700578	Cuerpo farfalliato	NB		260636
5969318	Aspirador bomba aceite	NB		260137
7703016	Tapa trasera árbol de levas	NB	2 2	260637
7639644	Tubo aspiración	NFT		260638
5873131	Tubo respiración	NB		260139
7701854	Termostato	NB		260639
7874731	Arandelas tapa de válvulas	GS	4 4	260642
	Kit de retenes completo			R260600
	Jgo. retén válvulas (16)	V	1	R260610V
	Retén bancada 74 x 90 x 10	P	1	R260111P
	Retén distribución 30 x 43 x 8	P	1	R260112P
	Retén árbol levas 30 x 42 x 7	P	2	R260113P
	Retén árbol levas 30 x 52 x 7	V		R260313V

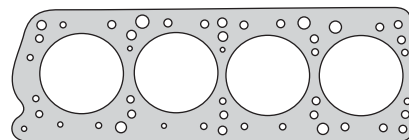

260105

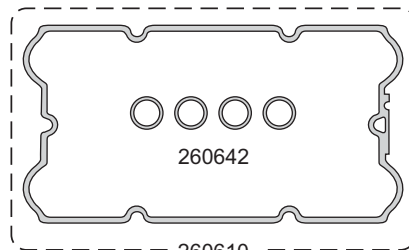

260642

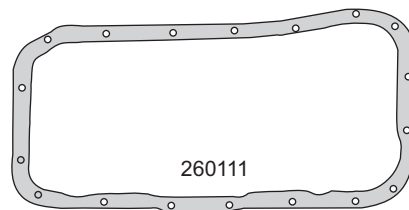

260111



260616



260617



260112



250914

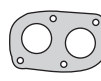

250718



250919



260129

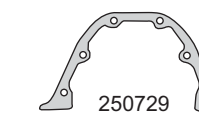

250729

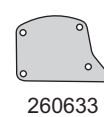

260633



260634



260635



250935



260636

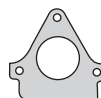

260637



260638



260137



260139



R260111P



R260112P

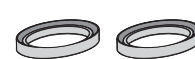

R260113P

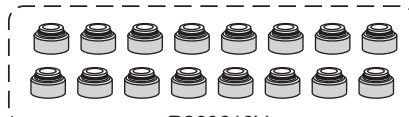

R260610V

**FIAT**



Motor/Engine Cm³ HP Ø

146B (SOHC) 8V 994 48/61 76

Fiat: Uno Mille, Palio, Siena 1983/...



Nº OE	Descripción/Description	Mat.			Ref.
	Jgo. de juntas para motor			●	260700-R
	Jgo. de juntas superior		●		260795
	Jta. tapa cilindros Ø 77.0 ± 1.80	NFT	1	1	260705
	Jta. tapa cilindros Ø 77.0 ± 1.90  NR	NFT			260707
	Jgo. tornillos tapa cilindros (HAS17038)				B260500
4323710	Junta tapa válvulas	CG	1	1	260510
4249510	Jgo. junta para cárter	CG		1	260011
4249516	Tapa distribución	CB		1	260012
4249517	Porta retén trasero	NB		1	260013
4346415	Bomba de agua	NB	1	1	260014
4398359	Jgo. admisión y escape (2)	NFT	1	1	260016
	Salida de escape	FCH	1	1	260018
4250780	Tapa bomba de agua	CB		1	260019
4428157	Base carburador	NB	1	1	250425
4250500	Bomba de aceite	CB		1	260027
4081257	Base bomba nafta	NB			250128
4427495	Bomba nafta 0.25	NB		1	260528
4296113	Tapa delantera tapa cilindro	NB	1	1	260029
	Superior bomba agua	NB		1	250429
4427495	Bomba nafta 0.8	NB		1	260529
4427495	Bomba nafta 1.2	NB		1	260530
4249520	Tapa árbol levas	NB		1	260030
	Junta tapa válvulas	NB	1	1	260531
4386806	Tapa block	CB		1	260033
4477229	Tapa block	CB		1	260034
4346834	Tensor correa	NB		1	260534
4434100	Colector aspiración	NB		1	260035
4346833	Tapa block al volante	NB		1	260535
4139959	Entre bomba y tubo	NB			260037
4109133	Tapón orificio distribuidor	NB		1	260038
4351195	Base termostato	NB	1	1	260041
4325360	Tapa retén aceite	NB	1	1	260042
	Base bomba nafta 0.5	NB		1	250144
	Kit de retenes completo				R260000
	Jgo. retén válvulas (8)	V	1		R250410V
	Retén bancada 70 x 85 x 8	P	1		R260011P
	Retén distribución 40 x 56 x 7	P	1		R250412P
	Retén árbol levas 30 x 52 x 7	P	2		R250413P

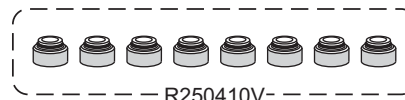
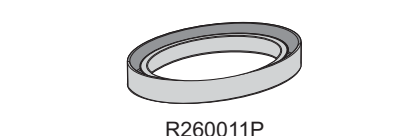
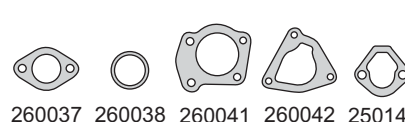
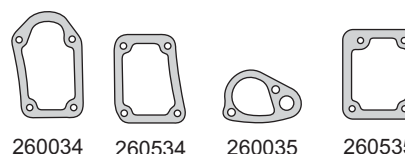
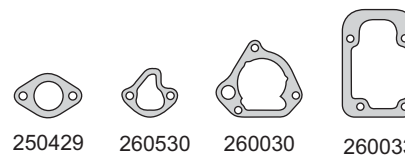
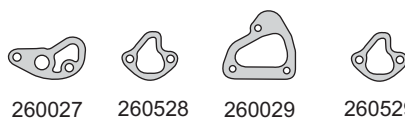
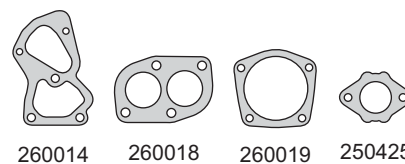
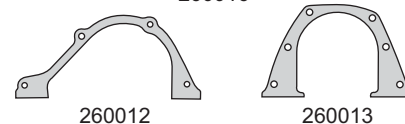
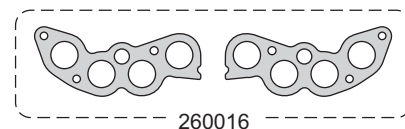
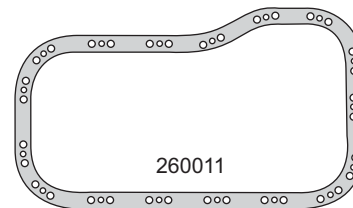
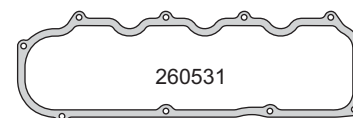
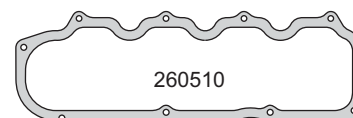
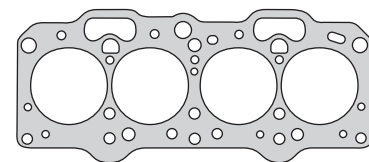

FIAT



Motor/Engine	Cm³	HP	Ø
154C4.046	1995	153	84
159A6.046	1995	115	84
834B.146	1995	115	84

Fiat: Tempra i.e, Tipo i.e, Cromo i.e  
Croma i.e Turbo 1992/95



Nº OE	Descripción/Description	Mat.	Ref.
7096175	Jgo. de juntas para motor		260800-R
	Jgo. de juntas superior		260895
	Jta. tapa cilindros Ø 85.0 ± 1.70	NFT	1 1 260105
7709257	Jta. tapa cilindros Ø 85.0 ± 1.70	NFT	260107
	Jgo. tornillos tapa cilindros (HAR12063)		B260100
7715789	Conj. junta tapa válvulas (3)	P	2 2 260810
	Junta para cárter	CG	1 260111
7589509	Tapa distribución	NB	1 260112
7679976	Bomba de agua	NB	1 250914
4177112	Múltiple escape	NFT	1 1 250716
7714537	Múltiple admisión	NFT	1 1 260117
4176386	Salida de escape	FCH	1 1 250718
5949822	Termostato	GS	250919
	Jgo. juntas carburador	VS	260121
	Base carburador	NB	2 2 260825
4161222	Tapa carga aceite	GS	1 1 260129
4129763	Porta retén bancada trasera	NB	1 250729
7547667	Inspección árbol levas	NFT	2 2 260130
50006916	Caballote T.V.	NFT	2 2 260131
4337093	Filtro aceite	NB	1 250935
5969318	Aspirador bomba aceite	NB	1 260137
7668658	Inspección agua a block	NB	1 260138
5873131	Tubo respiración	NB	1 260139
7541231	Tapa base termostato	NB	1 1 260140
5923392	Inferior base termostato	GS	1 1 260141
5972773	Cuerpo respiradero o'ring G 36 x 3	GS	2 2 260142
	Arandela tapa válvulas A 13 x 21 x 1,5 F	F	4 4 250742
	Junta apoyo distribuidor	NB	1 250443
4158100	Cuerpo inferior respiradero	NB	1 260143
10280060	Perilla tapa botadores	CU	260144
	Arandela A 14 x 20 x 2 C	CU	4 4
	Kit de retenes completo		R260400
	Jgo. retén válvulas (8)	V	1 R250410V
	Retén bancada 74 x 90 x 10	P	1 R260111P
	Retén distribución 30 x 43 x 8	P	1 R260112P
	Retén árbol levas 30 x 52 x 7	P	2 R250413P

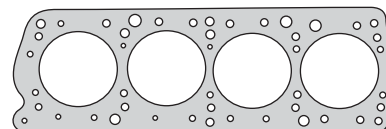

260105

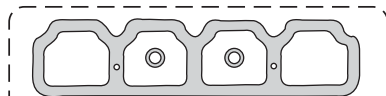

A 13 x 21 x 1.5 F

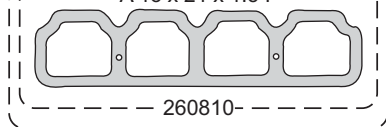

260810-

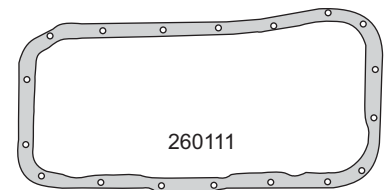

260111

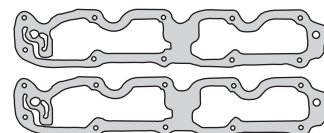

260131



250716



260117



260112

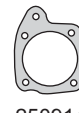

250914

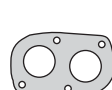

250718



250919



260825



260129



250729



260130



250935



260137



260138



260139



260140



260141



260142



260143



250443



R260111P



R260112P



R250413P



R250410V

**FIAT**



Motor/Engine	Cm³	HP	Ø
182A4/A6	1581	90/103	86.4
186A3/A4 (DOHC) 16V	1581	103	86.4

**Fiat:** Palio, Siena, Tipo, Bravo, Marea Multipla 1999/...

**Lancia:** Delta, Dedra, Lybra 1996/...



Nº OE	Descripción/Description	Mat.	1	2	Ref.
	Jgo. de juntas para motor				260900-R
	Jgo. de juntas superior		●		260995
	Jta. tapa cilindros Ø 87.0 ±1.80	NFT	1	1	260905
464100960	Jta. tapa cilindros Ø 87.0 ±1.80 NR	NFT			260907
	Jgo. tornillos tapa cilindros (HAR10168)				B260900
7773831	Junta tapa válvulas (metálica)	SLS	2	2	260931
7663366	Junta para cárter	NB		1	260911
7737203	Porta retén delantero	NB		1	250412
46412116	Múltiple escape	NFT	1	1	260916
46410505	Múltiple admisión	NFT	1	1	260917
1482930	Salida de escape	FCH	1	1	250618
7770023	Pasaje de agua a tapa	NB	1	1	260919
	Tapa bomba aceite	CU		1	260927
4947376	Junta mariposa aire	NB	1	1	260929
	Junta mariposa aire	NB	1	1	260930
7737204	Tapa inspección cigueñal	NB		1	250434
46413166	Salida de múltiple a catalizador	AC			260936
4179138	Base bomba aceite	NB		1	250439
4902267	Porta retén	NB		1	260241
46402220	Jgo. toberas multiple admisión (4)	N	1	1	260939
	Junta tapa cilindros competición (0.80)	NFT			260990-0.8
	Junta tapa cilindros competición (1.00)	NFT			260990-1.0
	Junta tapa cilindros competición (1.20)	NFT			260990-1.2
	Junta tapa cilindros competición (1.40)	NFT			260990-1.4
7792371	O'ring G 18.72 x 2.62	GS		1	
46428901	O'ring G 59.92 x 3.53	GS	2	2	
7792369	O'ring G 17.12 x 2.62	GS		1	
	O'ring G 55.25 x 2.62	GS	1	1	
	O'ring bomba de agua G 88.57 x 2.62	GS		1	
	O'ring bomba de agua G 31.34 x 3.53	GS		1	
	O'ring varilla aceite G 6.07 x 1.78	GS		1	
	O'ring llena aceite G 26.57 x 3.53	GS		1	
	O'ring árbol levas G 66.27 x 3.53	GS		1	
	O'ring tubo llenado G 50.39 x 3.53	GS		1	
	Kit de retenes completo				R260900
	Jgo. retén válvulas (16)	V	1		R260610V
	Porta retén bancada 64 x 81.50 x 8	V	1		PR260911V
	Retén distribución 40 x 56 x 7	P	1		R260312P
	Retén árbol levas bba. de aceite 30 x 42 x 7	P	1		R260113P
	Retén árbol levas 30 x 52 x 7	P	2		R260313P

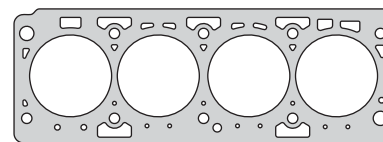

260905

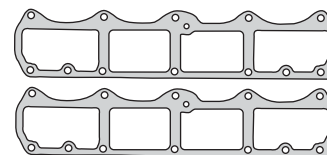

260931

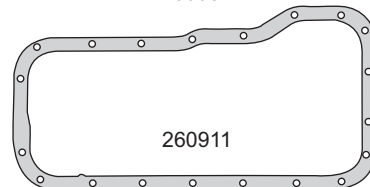

260911

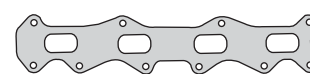

260916



260917



260939



250412

250618

260919

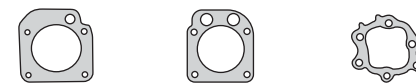

260929

260930

260927



250434

260241

250439

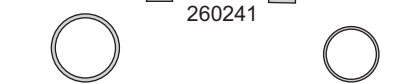

G 66.27 x 3.53

G 55.25 x 2.62



G 88.57 x 2.62

G 59.92 x 3.53

G 50.39 x 3.53



G 17.12 x 2.62

G 26.57 x 3.53

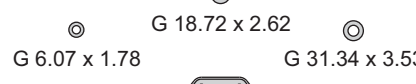

G 6.07 x 1.78

G 18.72 x 2.62

G 31.34 x 3.53

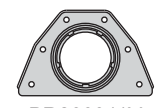

PR260911V



R260312P

R260313P

R260113P



R260610V

**FIAT**



Motor/Engine	Cm³	HP	Ø
182B6 - 178E7 (DOHC) 16V	1596	103	77

**Fiat:** Palio, Siena, Marea, Multipla 2001/...  
**Lancia:** Lybra 2000/05



Nº OE	Descripción/Description	Mat.	Ref.
	Jgo. de juntas para motor		● 261100-R MLS
	Jgo. de juntas superior	●	261195 MLS
	Jgo. de juntas superior		261195
	Jta. tapa cilindros Ø 82.0 $\pm$ 1.20	NFT	261107
	Jta. tapa cilindros Ø 81.5 $\pm$ 0.40	MLS	1 1 261108
	Jgo. tornillos tapa cilindros (HAR10168)		B260900
7773831	Junta tapa válvulas (metálica)	SLS	2 2 260931
7663366	Junta para cárter	NB	1 260911
7737203	Porta retén delantero	NB	1 250412
46412116	Múltiple escape	NFT	1 1 260916
46410505	Múltiple admisión	NFT	1 1 260917
1482930	Salida de escape	FCH	1 1 250618
7770023	Pasaje de agua a tapa	NB	1 1 260919
	Tapa bomba aceite	CU	1 260927
4947376	Junta mariposa aire	NB	1 260929
	Junta mariposa aire	NB	1 1 260930
7737204	Tapa inspección cigueñal	NB	1 250434
46413166	Salida de múltiple a catalizador	AC	4 260936
4179138	Base bomba aceite	NB	1 250439
4902267	Porta retén	NB	1 260241
46402220	Jgo. toberas múltiple admisión (4)	N	1 1 260939
7792371	O'ring G 18.72 x 2.62	GS	1
46428901	O'ring G 59.92 x 3.53	GS	2 2
7792369	O'ring G 17.12 x 2.62	GS	1
	O'ring G 55.25 x 2.62	GS	1 1
	O'ring bomba de agua G 88.57 x 2.62	GS	1
	O'ring bomba de agua G 31.34 x 3.53	GS	1
	O'ring varilla aceite G 6.07 x 1.78	GS	1
	O'ring llena aceite G 26.57 x 3.53	GS	1
	O'ring árbol levas G 66.27 x 3.53	GS	1
	O'ring tubo llenado G 50.39 x 3.53	GS	1
	Kit de retenes completo		R260900
	Jgo. retén válvulas (16)	V	1 R260610V
	Porta retén bancada 64 x 81.50 x 8	V	1 PR260911V
	Retén distribución 40 x 56 x 7	P	1 R260312P
	Retén árbol levas bba. de aceite 30 x 42 x 7	P	1 R260113P
	Retén árbol levas 30 x 52 x 7	P	2 R260313P

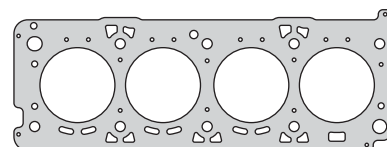

261108

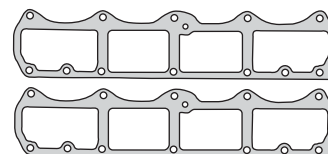

260931

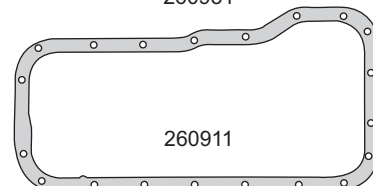

260911

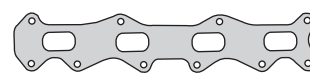

260916



260917



260939



250412

250618

260919

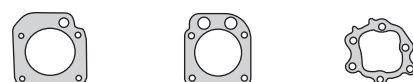

260929

260930

260927



250434

260241

250439



G 66.27 x 3.53



G 55.25 x 2.62



G 59.92 x 3.53



G 88.57 x 2.62



G 50.39 x 3.53



G 17.12 x 2.62



G 26.57 x 3.53



G 6.07 x 1.78



G 18.72 x 2.62

G 31.34 x 3.53

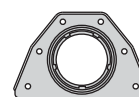

PR260911V



R260312P

R260313P

R260113P



R260610V



FIAT



Motor/Engine	Cm³	HP	Ø
149B - 176A	1697	58/69	82.6
160D - 280A1	1929	65/90	82.6
675.01 - 336.01 (SOHC) 8V	1929	90	82.6





































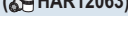

























Alfa Romeo: 146 TD 1994/99, 155 TD 1993/97

Fiat: Fiorino, Uno, Tipo, Palio, Tempra  
Ducato, Siena TD

Lancia: Delta, Dedra TD 1994/99

DIESEL



Nº OE	Descripción/Description	Mat.	Ref.
	Jgo. de juntas para motor 		260401-R
	Jgo. de juntas superior 		270095-SM
	Jgo. de juntas superior 		270095-1M
	Jgo. de juntas superior 		270095-2M
	Jgo. de juntas superior 		270095-3M
	Jgo. de juntas superior (MLS) 		270095-SM MLS
	Jgo. de juntas superior (MLS) 		270095-1M MLS
	Jgo. de juntas superior (MLS) 		270095-2M MLS
	Jgo. de juntas superior (MLS) 		270095-3M MLS
	Jgo. juntas superior sin JTC 		270096
46431639	Jta. tapa cilindros Ø 84.0 $\pm$ 1.70  	NFT	1 270007-SM
46431640	Jta. tapa cilindros Ø 84.0 $\pm$ 1.80  	NFT	270007-1M
46431641	Jta. tapa cilindros Ø 84.0 $\pm$ 1.95  	NFT	270007-2M
46431642	Jta. tapa cilindros Ø 84.0 $\pm$ 2.10  	NFT	270007-3M
46451593	Jta. tapa cilindros Ø 83.5 $\pm$ 1.65  	MLS	270008-SM
46451594	Jta. tapa cilindros Ø 83.5 $\pm$ 1.75  	MLS	270008-1M
46451595	Jta. tapa cilindros Ø 83.5 $\pm$ 1.85  	MLS	270008-2M
46451596	Jta. tapa cilindros Ø 83.5 $\pm$ 1.95  	MLS	270008-3M
	Jgo. tornillos tapa cilindros  (HAR12063) 		B260400
7702774	Junta tapa válvulas 	NB	1 1 260410
7647596	Junta para cárter 	CG	1 260411
7625508	Tapa distribución 	NB	1 260112
	Bomba de agua tapa PALIO/SIENA 1.9 	NB	270014
7702770	Cuerpo bomba de agua 	NB	1 1 260414
7765454	Múltiple admisión y escape turbo (NFT/CHA) 	NFT	1 260415
7765454	Múltiple admisión y escape 	NFT	1 260416
4364121	Bomba de agua a tapa cilindros 	NB	1 1 260419
	Base filtro aceite 	NB	1 260427
4129763	Porta retén bancada trasera 	NB	1 250729
4161222	Tapa carga aceite 	GS	1 260129
7702773	Tapa cámara agua 	NB	1 1 260429
7702766	Soporte bomba inyectora 	NB	1 260430
7702772	Termostato 	NB	1 1 260431
	Tapa cámara agua 	NB	1 1 260432
7702131	Tapa cámara block 	NB	1 260433
7702769	Tapa soporte árbol levas 	NB	1 1 260434
7696793	Tapa block lado distribución 	CB	1 260435
7565461	Arandela parallamas 	AC	4 560036
	Bomba de agua tapa DUCATO 	NB	1 260436
5969318	Aspirador bomba aceite 	NB	1 260137
7702768	Tapa árbol levas 	NB	1 1 260437
7668658	Inspección agua block 	NB	1 260138
	Salida agua 	CB	1 260439
	Brida 	NFT	2 260440
	Brida 	NFT	1 260441
4158100	Anillo caño bomba agua G 36.09 x 3.53 	GS	1 1 260442
	Bomba depresora 	NB	260043
10282458	Cuerpo inferior respiradero 	NB	1 260143
	O'ring bomba depresora G 40.94 x 2.62 	GS	260044
	Arandela conducto combustible A 25 x 29 x 1 C 	CU	4 260444
	Jgo. caja velocidades DUCATO todos 	VS	270050
	Junta caja velocidad 	CB	270055
	Junta acople caja de velocidad 	CB	270056

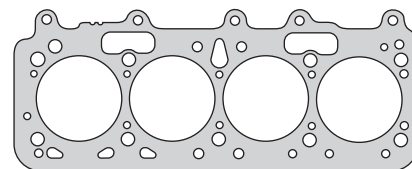

270007

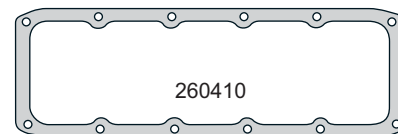

260410

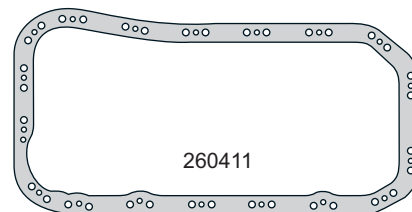

260411



260415

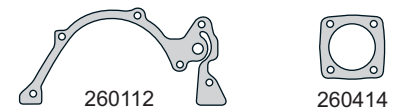

260112

260414

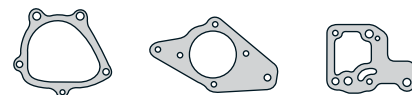

270014

260419

260427



260429

250729

260129



260430

260431

260432



260433

260434

260435



260437

260436

560036

260137

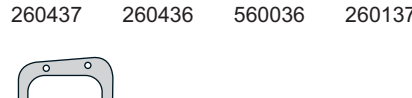

260138

260439

260440

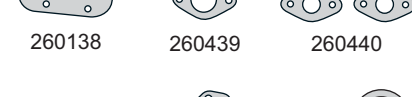

260441

260043

260143

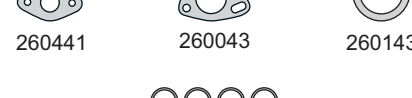

260441

260043

260143

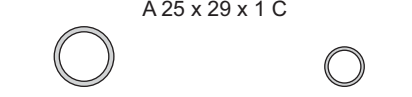

G 40.94 x 2.62

G 36.09 x 3.53

FIAT







Motor/Engine	Cm³	HP	Ø
149B - 176A	1697	58/69	82.6
160D - 280A1	1929	65/90	82.6
675.01 - 336.01 (SOHC) 8V	1929	90	82.6

**Alfa Romeo:** 146 TD 1994/99, 155 TD 1993/97

**Fiat:** Fiorino, Uno, Tipo, Palio, Tempra  
Ducato, Siena TD

**Lancia:** Delta, Dedra TD 1994/99

DIESEL

N° OE	Descripción/Description	Mat.	Ref.
	Junta bolillero caja de velocidad	CB	270057
	O'ring G 69.52 x 2.62	GS	
	O'ring bomba depresora G 5.34 x 1.78	GS	
	Kit de retenes completo 		R260400
	Jgo. retén válvulas (8) 	V	1 R250410V
	Retén bancada 74 x 90 x 10 	P	1 R260111P
	Retén distribución 30 x 43 x 8 	P	1 R260112P
	Retén árbol levas 30 x 52 x 7 	P	2 R250413P



G 69.52 x 2.62



G 5.34 x 1.78



R260111P



R260112P



R250413P



R250410V

**FIAT**



Motor/Engine	Cm³	HP	Ø
8140.27/S	2499	103	93
8140.47/R/S	2499	110/116	93
8140.47.X230 (SOHC) 8V	2499	116	93

**Fiat:** Ducato TD 1990/94, Ducato TDS 1994/96  
Ducato TDSE 1996/...

**Iveco:** Daily Turbo 1990/...

DIESEL



Nº OE	Descripción/Description	Mat.	Ref.
	Jgo. de juntas para motor		● 270100-R
	Jgo. de juntas para motor		270101-R
	Jgo. de juntas superior		270195-SM
	Jgo. de juntas superior		270195-1M
	Jgo. de juntas superior	●	270195-2M
	Jgo. de juntas superior		270195-3M
99432354	Jta. tapa cilindros Ø 96.0 ± 1.30	NFT	270107-SM
99432353	Jta. tapa cilindros Ø 96.0 ± 1.40	NFT	270107-1M
99460983	Jta. tapa cilindros Ø 96.0 ± 1.50	NFT	1 1 270107-2M
99458402	Jta. tapa cilindros Ø 96.0 ± 1.60	NFT	270107-3M
	Jgo. tornillos tapa cilindros (HAS17038)		B270100
	Junta tapa válvulas	GS	1 1 270110
99488483	Junta para cárter	CG	1 270111
	Tapa distribución	NB	1 270112
	Tapa delantera cigüeñal	NB	1 270113
	Bomba de agua	NB	1 251114
98434020	Jgo. múltiple escape (4)	NFT	1 1 270116
98425767	Jgo. múltiple admisión (4)	NFT	1 1 270117
98421297	Salida de escape	NFT	1 270118
	Porta termostato	NB	1 1 270119
	Tapa trasera cigüeñal	NB	1 270129
	Junta tapa delantera block	NB	1 270130
	Bomba vacio	NB	1 1 270131
	Filtro aceite	NB	1 270132
	Filtro aceite	NB	1 270332
	Filtro aceite	CB	1 270133
	Junta tapa trasera block	NB	1 270134
98430444	Comando bomba inyectora	NB	1 270135
	Junta base filtro aceite	NB	1 270136
	Brida agua	NB	4 270137
98432857	Intermedio block izquierdo	GS	1 270138
	Intermedio block derecho	GS	1 270139
	Brida	NB	1 1 270140
	Brida	NB	1 1 270141
	Brida	NB	1 270142
	Brida	NB	1 270143
	Brida	NB	2 2 270144
	Arandela A 38 x 46 x 4 C	CG	1 270145
	Junta porta retén árbol de levas	NFT	251146
36885008	Escape turbo	AC	1 1 350462
	O'ring G 44.12 x 2.62	GS	1
	O'ring G 64.77 x 2.62	GS	1
	O'ring G 98.02 x 3.53	GS	
	O'ring G 9.25 x 1.78	GS	3
	O'ring G 18.77 x 1.78	GS	2
	O'ring G 20.30 x 2.62	GS	15
	O'ring G 23.47 x 2.62	GS	1
	O'ring G 21.89 x 2.62	GS	1
	O'ring G 21 x 1.5	GS	2
	O'ring G 20 x 2	GS	2
	O'ring G 17.12 x 2.62	GS	1
	O'ring G 31.42 x 2.62	GS	2
	O'ring G 56.87 x 1.78	GS	1

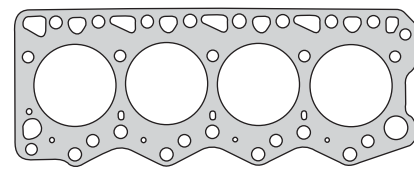

270107

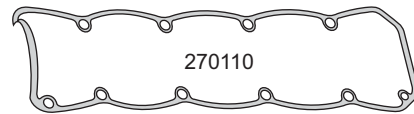

270110



270138



270139

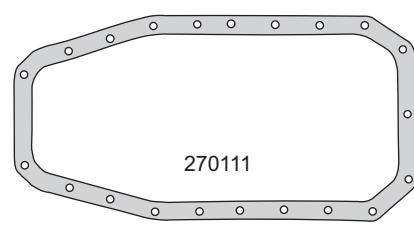

270111

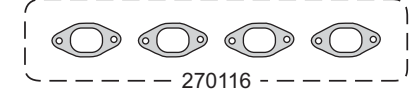

270116



270117

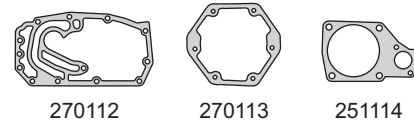

270112

270113

251114

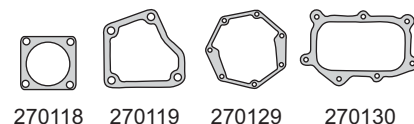

270118

270119

270129

270130

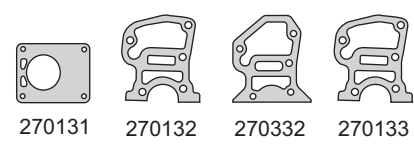

270131

270132

270332

270133

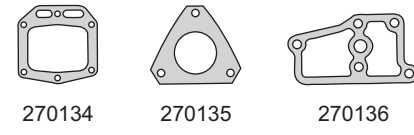

270134

270135

270136

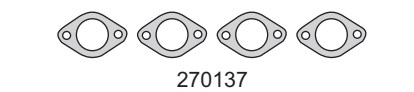

270137

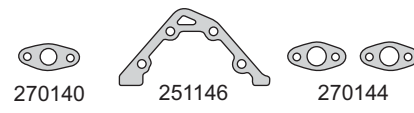

270140

251146

270144

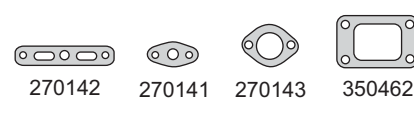

270142

270141

270143

350462

**FIAT**



Motor/Engine	Cm³	HP	Ø
8140.27/S	2499	103	93
8140.47/R/S	2499	110/116	93
8140.47.X230 (SOHC) 8V	2499	116	93

**Fiat:** Ducato TD 1990/94, Ducato TDS 1994/96  
Ducato TDSE 1996/...

**Iveco:** Daily Turbo 1990/...



**DIESEL**

Nº OE	Descripción/Description	Mat.	Ref.
	Arandela A 9 x 13 x 0.5 C	CU	5
	Arandela A 10.3 x 14 x 1 C	CU	2
	Arandela A 10 x 14 x 1 A	AL	1
	Arandela A 14 x 18 x 1.5 C	CU	4
	Arandela A 12 x 18 x 1 C	CU	4
98429280	Arandela A 20 x 26 x 1.5 C	CU	3
	Arandela A 22 x 28 x 1.5 C	CU	4
	Arandela A 28 x 38 x 1.5 C	CU	1
	Kit de retenes completo		R270100
	Jgo. retén válvulas (8)	V	1 R270110V
40100311	Retén bancada 90 x 115 x 13	V	1 R270111V
99468744	Porta retén bancada 1996/...	V	PR270111V
	Porta retén distribución 1996/...	V	PR270112V
98454053	Retén distribución 70 x 90 x 10	V	1 R270112V
98454045	Retén árbol levas 50 x 70 x 10	V	1 R270113V
98454041	Retén auxiliar 55 x 70 x 10	V	1 R270115V

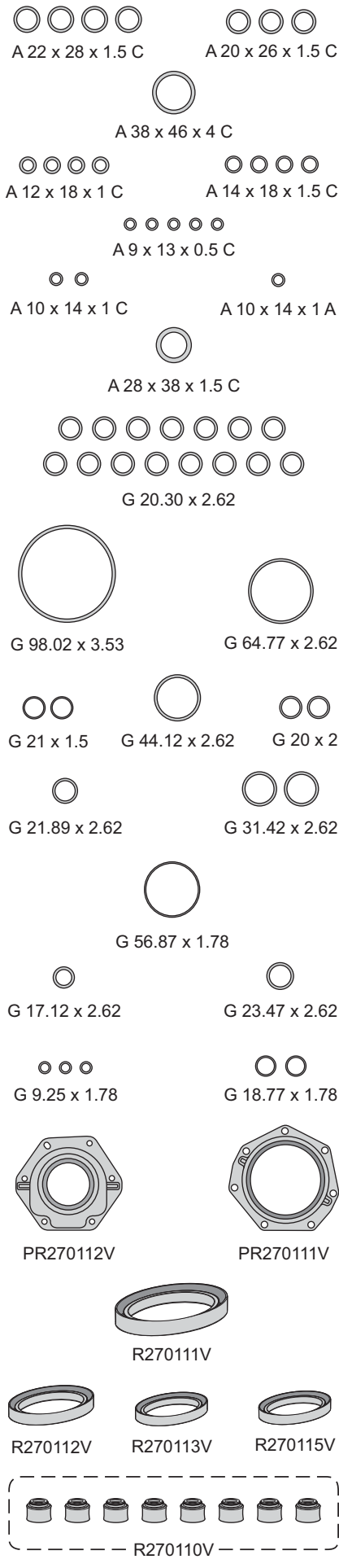

**FIAT**



Motor/Engine	Cm³	HP	Ø
ED/EDX MPI	994	48/61	76
EL MPI (SOHC) 8V	1495	76	76

Fiat: Palio 1.0 ED/EDX MPI 96  
Palio 1.5 EL MPI 96



Nº OE	Descripción/Description	Mat.	1	2	Ref.
	Jgo. de juntas para motor				270200-R
	Jgo. de juntas superior		●		270295
7702873	Jta. tapa cilindros Ø 77.0 ± 1.80	NFT	1	1	260705
	Jta. tapa cilindros Ø 77.0 ± 1.90	NFT			260707
	Jgo. tornillos tapa cilindros (HAS17038)				B260500
4249510	Jgo. junta para cárter	CG		1	270211
4249516	Tapa distribución	CB		1	260012
4249517	Porta retén trasero	NB		1	260013
46451539	Múltiple escape	NFT	1	1	270216
46435756	Multiple admisión	NB	1	1	270217
	Salida de escape	FCH	1	1	270218
4250780	Tapa bomba de agua	CB	1	1	260019
46436930	Termostato a block	NB	1	1	270219
4250500	Bomba de aceite	CB		1	260027
	Superior bomba de agua	NB	1	1	250429
4296113	Tapa delantera tapa cilindro	NB	1	1	260029
4249520	Tapa árbol levas	NB		1	260030
4323710	Junta tapa válvulas	NB	1	1	260531
4386806	Tapa block	CB		1	260033
46440387	Tapa trasera tapa cilindros	NB	1	1	270233
4477229	Tapa block	CB		1	260034
4346834	Tensor correa	NB		1	260534
4434100	Colector aspiración	NB		1	260035
46435757	Base inyección	NB	1	1	270235
4346833	Tapa block al volante	NB		1	260535
4139959	Entre bomba y tubo	NB			260037
7733577	Bomba de aceite	NB		1	270237
4325360	Tapa retén aceite	NB	1	1	260042
	Kit de retenes completo				R260000
	Jgo. retén válvulas (8)	V		1	R250410V
	Retén bancada 70 x 85 x 8	P		1	R260011P
	Retén distribución 40 x 56 x 7	P		1	R250412P
	Retén árbol levas 30 x 52 x 7	P		2	R250413P

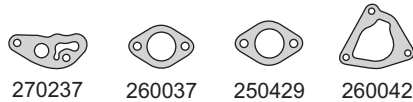
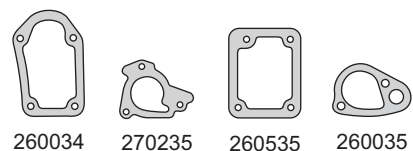
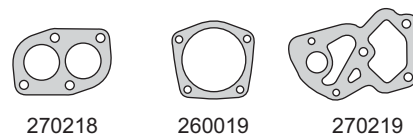
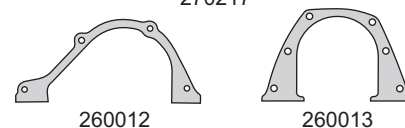
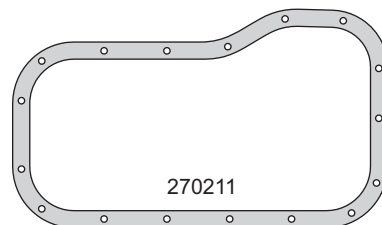
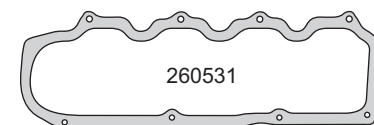
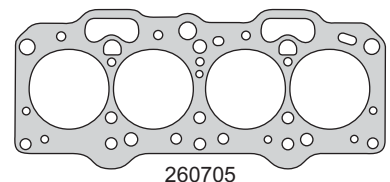

FIAT



Motor/Engine	Cm³	HP	Ø
8140.43	2799	122	94.4
S9W 700/702 (SOHC) 8V	2799	115	94.4

Fiat: Ducato 14TDS, Ducato Maxi 18TDS 1996/...

Renault: Master TD 1998/...

DIESEL



Nº OE	Descripción/Description	Mat.	Ref.
	Jgo. de juntas para motor		270300-R
	Jgo. de juntas para motor		270301-R
	Jgo. de juntas superior		270395-SM
	Jgo. de juntas superior	●	270395-1M
	Jgo. de juntas superior		270395-2M
	Jgo. de juntas superior		270395-3M
99432354	Jta. tapa cilindros Ø 96.0 $\pm$ 1.30	NFT	270107-SM
99432353	Jta. tapa cilindros Ø 96.0 $\pm$ 1.40	NFT	1 270107-1M
99460983	Jta. tapa cilindros Ø 96.0 $\pm$ 1.50	NFT	1 270107-2M
99458402	Jta. tapa cilindros Ø 96.0 $\pm$ 1.60	NFT	270107-3M
	Jgo. tornillos tapa cilindros		B270100
500388381	Junta tapa válvulas	N	1 1 270310
500327660	Junta para cárter aspirado	CG	1 270311
99488483	Junta para cárter	CG	1 270111
	Junta distribución	NB	1 270112
	Junta tapa anterior cigüeñal	NB	1 1 270113
	Bomba de agua	NB	1 251114
98434020	Jgo. múltiple escape (4)	NFT	1 1 270116
98425767	Jgo. múltiple admisión (4)	NFT	1 1 270117
	Salida de escape	NFT	1 270118
98421297	Junta porta termostato	NB	1 1 270119
	Junta tapa trasera cigüeñal	NB	1 270129
	Arandela A 37 x 47 x 4	CG	1 270330
	Junta filtro de aceite	CB	1 270133
	Junta	NB	1 270134
98430444	Junta comando bomba inyectora	NB	1 270135
	Junta	NB	1 270136
98430478	Junta brida agua	NB	1 1 270137
	Intermedio block izquierda 2.5	GS	1 270138
99432807	Intermedio block izquierda	GS	1 270338
	Intermedio block derecha 2.5	GS	1 270139
99432808	Intermedio block derecha	GS	1 270339
	Tapa inspección block trasero	NB	1 270340
98426170	Colector admisión	NB	1 1 270341
	Junta colector turbo	NFT	1 1 270342
98484659	Junta escape turbo	AC	1 1 270345
	Guarnición termostato	GS	1 460245
4834948	Entre múltiple turbo	AC	1 1 500546
	Junta porta retén árbol de levas	NB	251146
99436990	Junta colector escape	AC	1 1 270347
	O'ring G 94.84 x 3.53	GS	1
	O'ring G 64.77 x 2.62	GS	1
	O'ring G 59.92 x 3.53	GS	1
	O'ring G 55.25 x 2.62	GS	1
	O'ring G 56.87 x 1.78	GS	1
	O'ring G 48.9 x 2.62	GS	1
	O'ring G 47.22 x 3.53	GS	2
	O'ring G 47.22 x 3.53	S	1
	O'ring G 44.04 x 3.53	GS	1
	O'ring G 37.77 x 2.62	GS	1
	O'ring G 29.82 x 2.62	GS	1
	O'ring G 23.47 x 2.62	GS	1
	O'ring G 18.64 x 3.53	GS	1

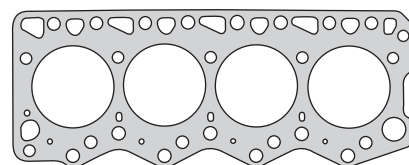

270107



270310

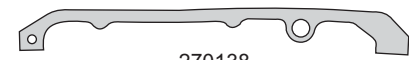

270138



270139



270338



270339

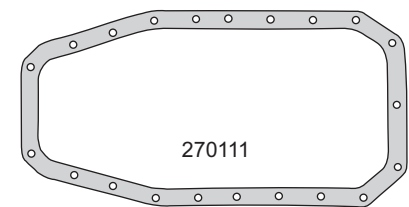

270111

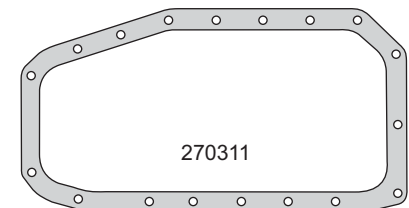

270311

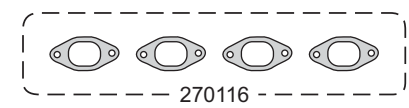

270116

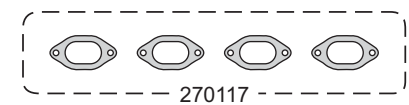

270117

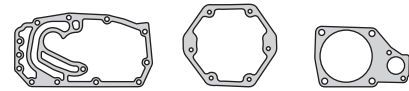

270112



270113

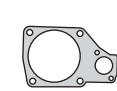

251114



270118

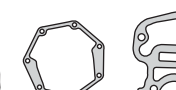

270119



270129



270133

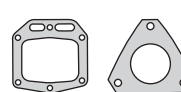

270134



270135



270137

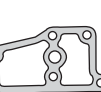

270136



270340



270341



270342



460245

**FIAT**



Motor/Engine	Cm³	HP	Ø
8140.43 S9W 700/702 (SOHC) 8V	2799 2799	122 115	94.4 94.4

**Fiat:** Ducato 14TDS, Ducato Maxi 18TDS  
1996/...  
**Renault:** Master TD 1998/...

**DIESEL**

Nº OE	Descripción/Description	Mat.	Ref.
	O'ring G 21.95 x 1.78	GS	2
	O'ring G 18.72 x 2.62	GS	2
	O'ring G 17.12 x 2.62	GS	2
	O'ring G 17.17 x 1.78	GS	4
	O'ring G 9.25 x 1.78	GS	3
	Arandela tapón cárter A 22 x 27 x 1.5 C	CU	1
	Arandela A 20 x 26 x 1 C	CU	1
	Arandela A 20 x 26 x 0.5 C	CU	1
	Arandela A 18 x 22 x 1.5 C	CU	1
4858608	Arandela A 14 x 20 x 1.5 C	CU	4
	Arandela A 12 x 18 x 1.5 C	CU	4
4858606	Arandela A 10 x 14 x 1 C	CU	4
	Arandela A 8 x 14 x 0.5 C	CU	4
	Arandela A 7 x 13 x 1.5 A	AL	4
	Kit de retenes completo		R270100
	Jgo. retén válvulas (8)	V	1 R270110V
40100311	Retén bancada 90 x 115 x 13	V	1 R270111V
98454053	Retén distribución 70 x 90 x 10	V	1 R270112V
98454045	Retén árbol levas 50 x 70 x 10	V	1 R270113V
98454041	Retén auxiliar 55 x 70 x 10	V	1 R270115V

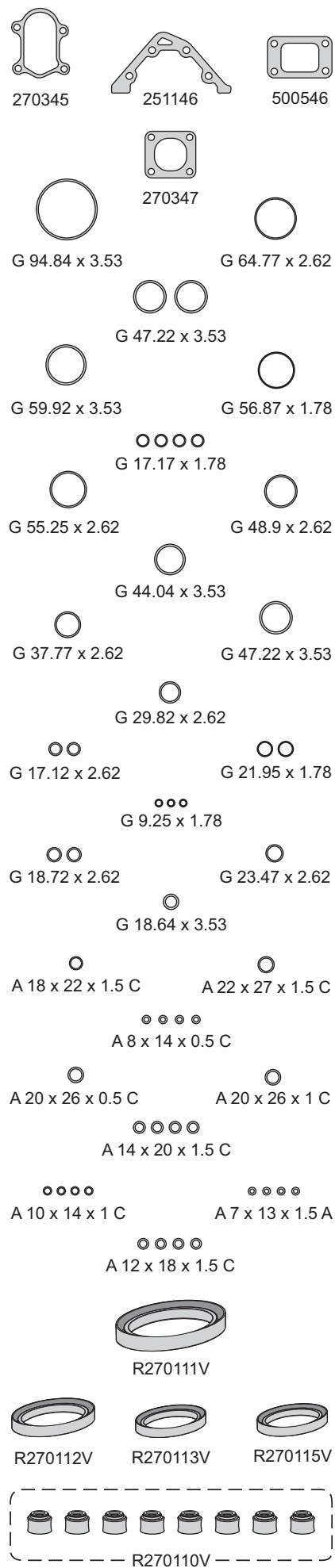

**FIAT**



Motor/Engine	Cm³	HP	Ø
8140.67	2445	55	93
8140.67X230	2499	85	93
8140.67F37	2499	82	93
S8U (SOHC) 8V	2499	55/75/80	93

**Fiat:** Nuovo Ducato 1989/94, Ducato 1994/...  
**Iveco:** Daily 30.8, 35.8 1996/...  
**Renault:** Master 1990/... - 1998/...  
 Trafic 1990/...  
 Serie 742/748/770/772/758/780/782



DIESEL

Nº OE	Descripción/Description	Mat.	Ref.
	Jgo. de juntas para motor	●	270400-R
	Jgo. de juntas para motor		270401-R
98492581	Junta tapa cilindros Ø 95.0 ±1.70	NFT	1 270407
4403137	Junta tapa cilindros Ø 95.0 ±1.50	NFT	270407-1M
4403135	Junta tapa cilindros Ø 95.0 ±1.60	NFT	270407-2M
	Jgo. tornillos tapa cilindros (HAS17038)		B270100
500388381	Junta tapa válvulas	N	1 270310
99488483	Junta para cárter	CG	1 270111
500327440	Junta para cárter	CG	1 270311
	Junta distribución	NB	1 270112
	Junta distribución	NB	1 270412
	Tapa delantera cigüeñal	NB	1 270113
	Bomba de agua	NB	1 251114
98434020	Jgo. múltiple escape (4)	NFT	1 270116
98425767	Jgo. múltiple admisión (4)	NFT	1 270117
	Salida de escape	NFT	1 270118
98421297	Porta termostato	NB	1 270119
	Tapa trasera cigüeñal	NB	1 270129
	Junta tapa delantera block	NB	1 270130
	Bomba vacío	NB	1 270131
	Filtro aceite	NB	1 270132
	Filtro aceite	NB	1 270332
	Filtro aceite	CB	1 270133
	Junta tapa trasera block	NB	1 270134
98430444	Comando bomba inyectora	NB	1 270135
	Junta base filtro aceite	NB	1 270136
98430478	Brida agua	NB	1 270137
99432807	Intermedio block izquierdo	GS	1 270138
99432808	Intermedio block derecho	GS	1 270139
	Brida	NB	1 270140
	Brida	NB	1 270141
	Brida	NB	1 270142
	Brida	NB	1 270143
	Brida	NB	1 270144
	Arandela A 38 x 46 x 4 C	CG	1 270145
	Junta porta retén árbol de levas	NB	251146
	O'ring G 44.12 x 2.62	GS	1
	O'ring G 64.77 x 2.62	GS	1
	O'ring G 9.25 x 1.78	GS	3
	O'ring G 18.77 x 1.78	GS	2
	O'ring G 20.30 x 2.62	GS	15
	O'ring G 23.47 x 2.62	GS	1
	O'ring G 21.89 x 2.62	GS	1
	O'ring G 21 x 1.5	GS	2
	O'ring G 20 x 2	GS	2
	O'ring G 17.12 x 2.62	GS	1
	O'ring G 31.42 x 2.62	GS	2
	O'ring G 56.87 x 1.78	GS	2
	Arandela A 9 x 13 x 0.5 C	CU	5
	Arandela A 10.3 x 14 x 1 C	CU	2
	Arandela A 10 x 14 x 1 A	AL	1
	Arandela A 14 x 18 x 1.5 C	CU	4
	Arandela A 12 x 18 x 1 C	CU	4

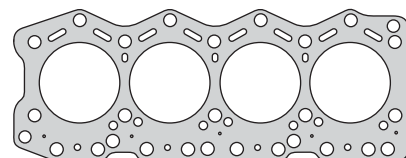

270407



270310



270138



270139

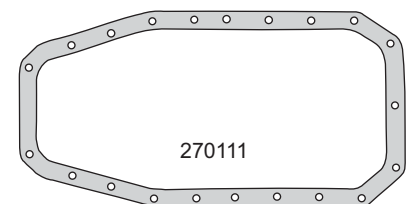

270111

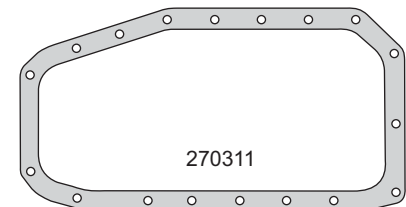

270311

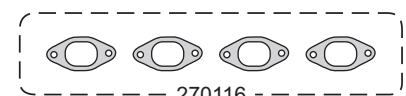

270116

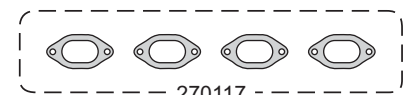

270117

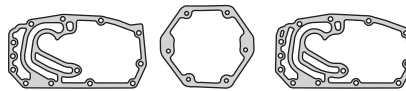

270112 270113 270412

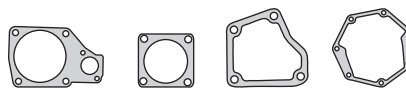

251114 270118 270119 270129

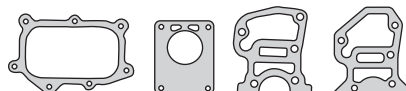

270130 270131 270132 270332

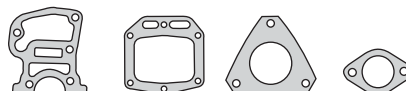

270133 270134 270135 270137



270136 270140 251146



270141 270142 270143 270144



# FIAT



Motor/Engine	Cm³	HP	Ø
<b>8140.67</b>	<b>2445</b>	<b>55</b>	<b>93</b>
<b>8140.67X230</b>	<b>2499</b>	<b>85</b>	<b>93</b>
<b>8140.67F37</b>	<b>2499</b>	<b>82</b>	<b>93</b>
<b>S8U</b> (SOHC) 8V	<b>2499</b>	<b>55/75/80</b>	<b>93</b>

**DIESEL**

**Fiat:** Nuovo Ducato 1989/94, Ducato 1994/...

**Iveco:** Daily 30.8, 35.8 1996/...

**Renault:** Master 1990/... - 1998/...  
Trafic 1990/...  
Serie 742/748/770/772/758/780/782



Nº OE	Descripción/Description	Mat.	Ref.
98429280	Arandela A 20 x 26 x 1.5 C	CU	3
	Arandela A 22 x 28 x 1.5 C	CU	4
	Arandela A 28 x 37 x 1.5 C	CU	1
	Kit de retenes completo		R270100
	Jgo. retén válvulas (8)	V	1 R270110V
40100311	Retén bancada 90 x 115 x 13	V	1 R270111V
99468744	Porta retén bancada 1996/...	V	PR270111V
	Porta retén distribución 1996/...	V	PR270112V
98454053	Retén distribución 70 x 90 x 10	V	1 R270112V
98454045	Retén árbol levas 50 x 70 x 10	V	1 R270113V
98454041	Retén auxiliar 55 x 70 x 10	V	1 R270115V



A 38 x 46 x 4 C

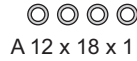

A 12 x 18 x 1 C



A 14 x 18 x 1.5 C

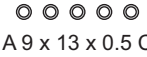

A 9 x 13 x 0.5 C



A 10.3 x 14 x 1 C



A 10 x 14 x 1 A



A 28 x 37 x 1.5 C

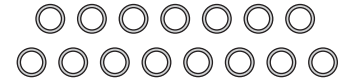

G 20.30 x 2.62



G 64.77 x 2.62



G 44.12 x 2.62



G 21 x 1.5



G 9.25 x 1.78



G 20 x 2



G 21.89 x 2.62



G 31.42 x 2.62



G 56.87 x 1.78



G 17.12 x 2.62



G 23.47 x 2.62



G 18.77 x 1.78

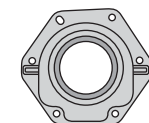

PR270112V

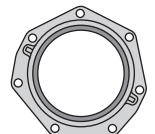

PR270111V



R270111V



R270112V



R270113V



R270115V



R270110V

**FIAT**



Motor/Engine	Cm³	HP	Ø
Fire MPI	999	50	70
Fire MPI (SOHC) 8V	1300	75	70.8

Fiat: Uno, Palio, Siena, Mille Fire



Nº OE	Descripción/Description	Mat.	Ref.
	Jgo. de juntas para motor		270500-R
	Jgo. de juntas superior	●	270595
	Jgo. de juntas superior (MLS)		270595 MLS
	Jta. tapa cilindros Ø 72.0 $\pm$ 1.20	NFT 1 1	270505
	Jta. tapa cilindros Ø 72.0 $\pm$ 1.20	NFT	270507
	Jta. tapa cilindros Ø 72.0 $\pm$ 1.95	NFT	270507-1.9
	Jta. tapa cilindros Ø 72.0 $\pm$ 0.40	MLS	270508
46541379	Jgo. tornillos tapa cilindros (HAS13038)		B270500
	Junta tapa de válvulas	N 1 1	270510
46748519	Junta para cárter	GS 1	270511
4249510	Tapa distribución	NB 1	270512
46552427	Bomba de agua	NB 1 1	251014
	Jgo. múltiple escape (2)	NFT 1 1	270515
46546134	Jgo. múltiple admisión (6)	GS 1 1	270517
71716583	Salida de escape	FCH 1 1	270518
	Termostato	NB 1 1	270519
7604488	Guarnición goma	GS 1 1	270532
46549928	Guarnición admisión	GS 1 1	270731
71716584	Conexión sensor temperatura	GS 1 1	270533
46824135	O`ring G 30.8 x 3.7	GS 1 1	
14463580	O`ring G 21.95 x 1.78	GS 1	
	Kit de retenes completo		R270500
	Jgo. retén válvulas (8)	V 1	R270510V
7581344	Retén bancada 74 x 88 x 8 - hasta 2003	P 1	R270511P
7724665	Porta retén bancada - desde 2004/...	V	PR270511V
55187497	Retén árbol de levas 30 x 42 x 7	P 1	R260113P
40004240	Retén bomba de aceite 27 x 37 x 7	P 1	R270515P

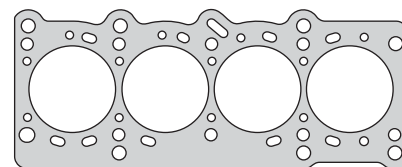

270507

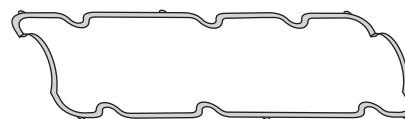

270510

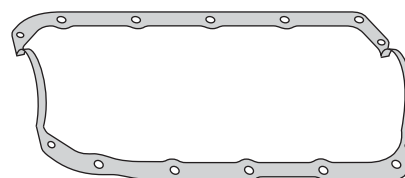

270511

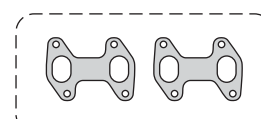

270515



270517



270512

270518

251014



270519

G 30.8 x 3.7

270533



G 21.95 x 1.78



PR270511V



R270511P



R260113P



R270515P



R270510V

# ALFA ROMEO



Motor/Engine	Cm³	HP	Ø
676.01	1598	120	82
671.06	1747	140/144	82
671.99	1747	140/144	82
322.01 (DOHC) 16V	1747	140/144	82

Alfa Romeo: 145/146/155/156 Twin Spark  
1996/...

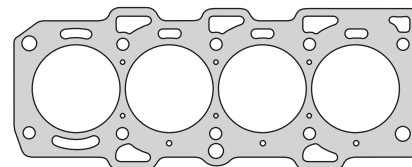

270607

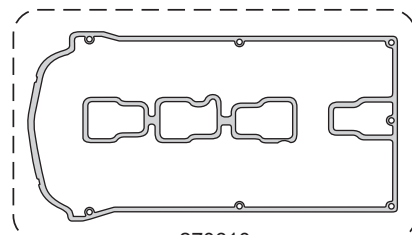

270610



270615

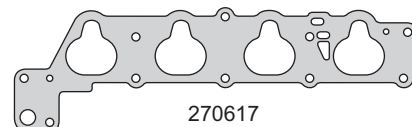

270617

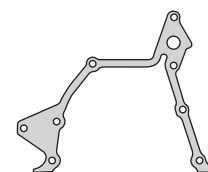

270612



270614



270627



270632



270633



A 14 x 24 x 2 C



270634



A 12 x 18 x 1 C



A 19 x 26 x 1.5 C



G 62.87 x 5.33



R260111V



R260112P



R270612V



R260113P



R270614V



R270615V

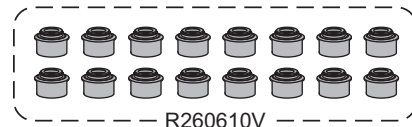

R260610V

N° OE	Descripción/Description	Mat.	Ref.
	Jgo. de juntas para motor		270600-R
	Jgo. de juntas superior		270695
60608895	Jta. tapa cilindros Ø 84.0 ±1.70 NR <sup>3</sup>	NFT 1 1	270607
	Jgo. tornillos tapa cilindros (HAR14063)		B270600
	Sellador líquido - caucho de silicona		TRN0085G
	Conjunto juntas tapa válvulas (2)	GS 1 1	270610
	Junta distribución	NB 1 1	270612
	Válvula mariposa aceleración	NB 1 1	270614
46526271	Múltiple escape	AC 1 1	270615
	Múltiple admisión	NFT 1 1	270617
	Tapa bomba aceite	AC 1	270627
	Entrada admisión	SLS 1 1	270632
	Salida admisión	SLS 1 1	270633
	Válvula bomba aceite	CB 1	270634
	Guarnición llenado aceite		270635
	Junta interior tapa de válvulas	GS 1 1	270642
	O'ring G 62,87 x 5,33	GS 1	
	Arandela A 12 x 18 x 1 C	CU 1	
	Arandela A 14 x 24 x 2 C	CU 1	
	Arandela A 19 x 26 x 1,5 C	CU 1	
	Kit de retenes completo		R270600
	Jgo. retén válvulas (16)	V 1	R260610V
60805182	Retén bancada 74 x 90 x 10	V 1	R260111V
90500805	Retén distribución 55 x 68 x 8	V 1	R270612V
60805219	Retén distribución 30 x 43 x 8	P 1	R260112P
60809849	Retén árbol levas 30 x 42 x 7	P 1	R260113P
	Retén árbol levas auxiliar 30 x 44 x 8	V 1	R270614V
7628850	Retén árbol levas auxiliar 31 x 41 x 7	V 1	R270615V

**FIAT**



Motor/Engine	Cm³	HP	Ø
Fire 1714130	999	70	71
Fire 188.A5 (DOHC) 16V	1242	80	71

**Fiat:** Palio, Siena, Palio Weekend, Palio Novo  
Novo Siena, Doblo  
**Lancia:** Ypsilon 2000/...



Nº OE	Descripción/Description	Mat.	Ref.
	Jgo. de juntas para motor		270700-R
	Jgo. de juntas superior	●	270795
	Jgo. de juntas superior		270795 MLS
	Junta tapa cilindros Ø 72.0 ± 1.20	NFT 1	270705
	Junta tapa cilindros Ø 72.0 ± 1.20	NFT 1	270707
46410960	Junta tapa cilindros Ø 72.0 ± 0.40	MLS	270708
	Jgo. tornillos tapa de cilindros		B270700
46513955	Junta tapa de válvulas	SLS 1 1	270710
46745223	Junta para cárter aceite	CG 1	270711
46552317	Tapa distribución	NB 1	270712
	Bomba de agua	NB 1 1	251014
46526271	Jgo. múltiple escape	NFT 1 1	270715
71716583	Jgo. múltiple admisión (6)	GS 1 1	270517
46774747	Salida de escape	FCH 1 1	270718
7604488	Termostato	NB 1 1	270519
	Junta estanqueidad	GS 1 1	270929
46751961	Tapa trasera distribución	SLS 1 1	270730
71716584	Guarnición admisión	GS 1 1	270731
46549928	Guarnición termostato	GS 1 1	270532
7689903	Guarnición goma	GS	270732
71716584	Carga de aceite	GS	270742
	O´ring G 21.95 x 1.78	GS	1
14463580	O´ring G 30.8 x 3.7	GS 1 1	
7083082	O´ring inyectores G 7.52 x 3.53	GS 5 5	
	Kit retenes completo		R270700
46470334	Jgo. retén válvulas (16)	V 1	R270710V
46751174	Porta retén bancada 74 x 187.5/141 x 17	V 1	PR270711V
46780736	Retén árbol de levas 40 x 55 x 7	P 2	R270713P
	Retén bomba de aceite 27 x 37 x 7	P 1	R270515P

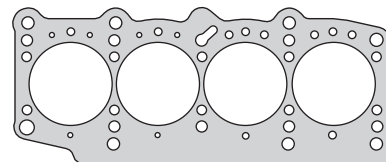

270707

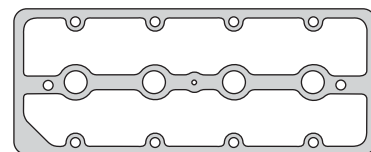

270710

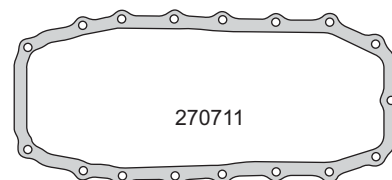

270711



270715

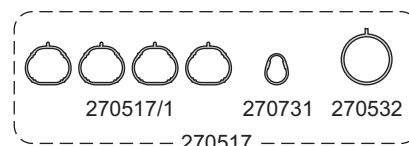

270517

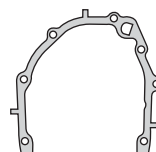

270712



251014

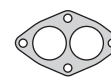

270718



270519

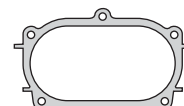

270730



270929



G 7.52 x 3.53



G 30.8 x 3.7



G 21.95 x 1.78

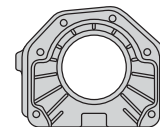

PR270711V



R270713P



R270515P

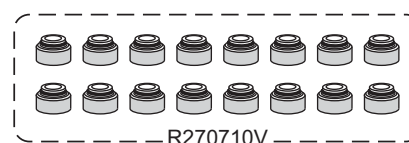

R270710V

**FIAT**



Motor/Engine	Cm³	HP	Ø
182A1	1998	147	82
838A1/A6	1998	145/155	82
182B3/B7 (DOHC) 20V	1998	147/155	82

**Fiat:** Coupe 1996/01, Bravo 1995/98  
Marea 1996/98 - 1999/...

**Lancia:** Kappa, Libra 1996/00



Nº OE	Descripción/Description	Mat.	Ref.
	Jgo. de juntas para motor		● 270900-R
7766268	Junta tapa cilindros Ø 83.0 ± 1.80	NFT	1 270907
7710582	Jgo. tornillos tapa cilindros (HAR10168)		B270900
	Conj. juntas tapa válvulas (6)	GS	1 270910
	Junta para cárter	NB	1 270911
	Junta distribución	NB	1 270912
	Jgo. tapa distribución (4)	GS	270912-1
	Junta distribución	NB	1 270913
	Bomba de agua	NB	1 270614
46525557	Múltiple escape	AC	1 270915
7765227	Múltiple admisión	NFT	1 270917
	Junta estanqueidad	GS	1 270929
	Junta cierre estanqueidad	GS	1 270930
	Junta cierre estanqueidad	GS	270931
46464114	Junta cierre de alimentación	GS	1 270932
	Junta protección bujías	GS	5 270933
	Junta válvula bomba de aceite	CB	1 270634
	Junta	NB	1 271334
	Junta	NB	1 270938
	Bomba de agua	NB	1 270940
	Arandela A 18 x 22 x 1.5 C	CU	1
	O´ring G 17.17 x 1.78	GS	1
	O´ring G 53.64 x 2.62	GS	1
	O´ring G 79 x 1.8	GS	1
	O´ring G 34.65 x 1.78	GS	1
	O´ring G 21.89 x 2.62	GS	1
	O´ring G 7.52 x 3.53	GS	10
	Kit de retenes completo		R270900
	Jgo. retén válvulas (20)	V	1 R270910V
	Porta retén bancada	V	PR270911V
90500805	Retén distribución 55 x 68 x 8	V	1 R270612V
60809849	Retén árbol de levas 30 x 42 x 7	V	1 R260113V
7628850	Retén árbol de levas secundario 31 x 41 x 7	V	1 R270615V

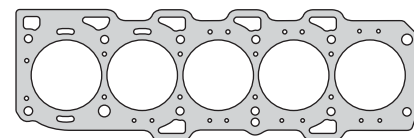

270907

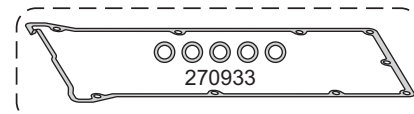

270933



270910

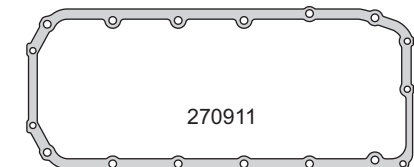

270911



270917



270915

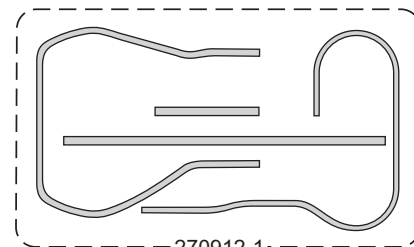

270912-1

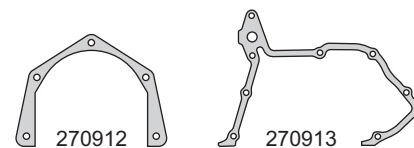

270912

270913

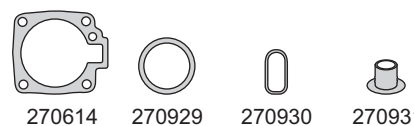

270614

270929

270930

270931

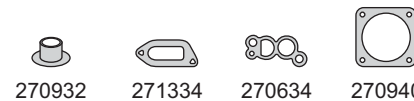

270932

271334

270634

270940

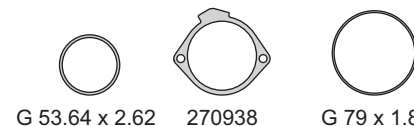

G 53.64 x 2.62

270938

G 79 x 1.8



G 21.89 x 2.62

G 17.17 x 1.78

G 34.65 x 1.78

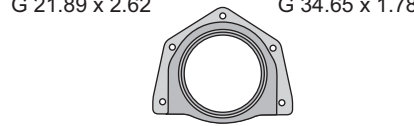

PR270911V



R270612V

R260113V

R270615V

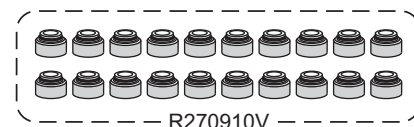

270910V

# FIAT IVECO



Motor/Engine	Cm³	HP	Ø
8140.23	2798	99	94.4
8140.43 (SOHC) 8V	2798	122	94.4

Iveco: Turbo Daily 35.10, 49.12 1996/...  
45.10, 49.10, 40.10  
Turbo Daily 49.12, 60.12 Intercooler



DIESEL

Nº OE	Descripción/Description	Mat.	Ref.
	Jgo. de juntas para motor		271101-R
	Jgo. de juntas superior	●	271195-SM
	Jgo. de juntas superior		271195-1M
	Jgo. de juntas superior		271195-2M
	Jgo. de juntas superior		271195-3M
99432354	Junta tapa cilindros Ø 96.0 ±1.30	NFT 1	270107-SM
99432353	Junta tapa cilindros Ø 96.0 ±1.40	NFT	270107-1M
99460983	Junta tapa cilindros Ø 96.0 ±1.50	NFT	270107-2M
99458402	Junta tapa cilindros Ø 96.0 ±1.60	NFT	270107-3M
48281505	Jgo. tornillos tapa cilindros (HAS17038)		B270100
500388381	Junta tapa válvulas	N 1 1	270310
994 88 483	Junta para cárter con limitadores de torque	CG 1	271111
	Frente distribución	NB 1	270112
	Tapa delantera cigüeñal	NB 1	270113
	Bomba de agua	NB 1	251114
98434020	Jgo. múltiple escape (4)	AC 1 1	271115
98425767	Jgo. múltiple admisión (4)	SLS 1 1	271117
	Salida de escape	NFT 1	270118
98421297	Porta termostato	NB 1	270119
	Bomba vacío	NB 1 1	270131
	Filtro aceite	NB 1	270132
	Filtro aceite	NB 1	270332
98430444	Comando bomba inyectora	NB 1	270135
	Junta base filtro aceite	NB 1	270136
98430478	Brida agua	NB 1 1	270137
99432807	Intermedio block izquierdo esp. 2.5	GS 1	270338
	Anillo termostato	GS 1	330638
99432808	Intermedio block derecho esp. 2.5	GS 1	270339
	Tapa inspección block trasera	NB 1	270340
98426170	Colector admisión	NB 1 1	270341
98484659	Colector a turbo	AC 1 1	270345
	Entrada aceite a turbo	NB 1	271146
99436990	Junta porta retén árbol de levas	NB	251146
	Escape a turbo	AC 1 1	270347
	Salida aceite a turbo	NB 1	271147
	Brida cañería	NB 1	271148
	O'ring G 9.25 x 1.78	GS 4	
	O'ring G 13.11 x 2.62	GS 1	
	O'ring G 17.17 x 1.78	GS 6	
	O'ring G 18.64 x 3.53	GS 1	
	O'ring G 21.89 x 2.62	GS 1	
	O'ring G 22.2 x 3.5	GS 2	
	O'ring G 23.47 x 2.62	GS 1	
	O'ring G 28.24 x 2.62	GS 1	
	O'ring G 29.82 x 2.62	GS 1	
	O'ring G 39.34 x 2.62	GS 1	
	O'ring G 44.04 x 3.53	GS 1	
	O'ring G 47.22 x 3.53	GS 3	
	O'ring G 48.90 x 2.62	GS 2	
	O'ring G 55.25 x 2.62	GS 1	
	O'ring G 56.87 x 1.78	GS 1	
	O'ring G 64.77 x 2.62	GS 1	
	O'ring G 94.84 x 3.53	GS 1	

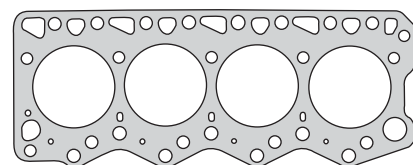

270107



270310

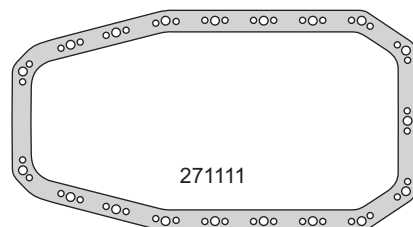

271111



270338

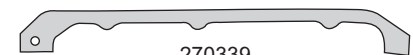

270339

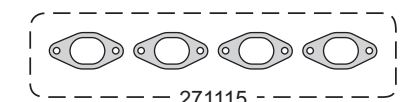

271115

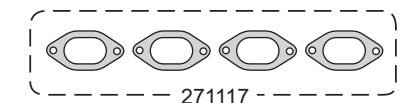

271117

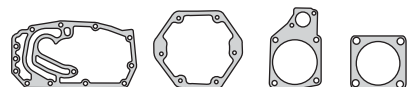

270112 270113 251114 270118

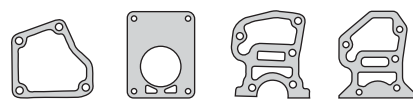

270119 270131 270132 270332

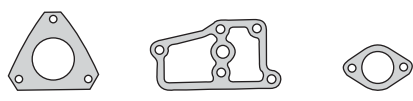

270135 270136 270137

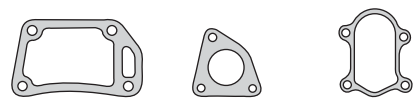

270340 270341 270345



270347 271147 251146



271146 G 59.92 x 3.53 271148



G 56.87 x 1.78 G 47.22 x 3.53



G 55.25 x 2.62 330638 G 64.77 x 2.62

# FIAT IVECO



Motor/Engine	Cm³	HP	Ø
8140.23	2798	99	94.4
8140.43 (SOHC) 8V	2798	122	94.4

Iveco: Turbo Daily 35.10 - 49.12 1996/...  
45.10 - 49.10 - 40.10  
Turbo Daily 49.12 - 60.12 Intercooler



DIESEL

Nº OE	Descripción/Description	Mat.	Ref.
	O'ring G 59.92 x 3.53	GS	1
	Arandela A 7 x 13 x 1.5 A	AL	1
	Arandela A 8 x 14 x 1 C	CU	5
4858606	Arandela A 10 x 14 x 1 C	CU	6
	Arandela A 12 x 16 x 1.5 C	CU	1
4858607	Arandela A 12 x 17 x 1.5 C	CU	5
	Arandela A 12 x 18 x 1.5 C	CU	1
4858608	Arandela A 14 x 20 x 1.5 C	CU	10
	Arandela A 16 x 20 x 1 C	CU	4
	Arandela A 18 x 22 x 1.5 C	CU	1
	Arandela A 20 x 26 x 1 C	CU	2
	Arandela A 22 x 27 x 1.5 C	CU	1
	Kit de retenes completo		R251100
98472291	Jgo. retén válvulas (8)	V	1 R270110V
99468744	Porta retén bancada 1996/...	V	PR270111V
	Porta retén distribución 1996/...	V	PR270112V
98454045	Retén árbol levas 50 x 70 x 10	V	1 R270113V
98454041	Retén auxiliar 55 x 70 x 10	V	1 R270115V

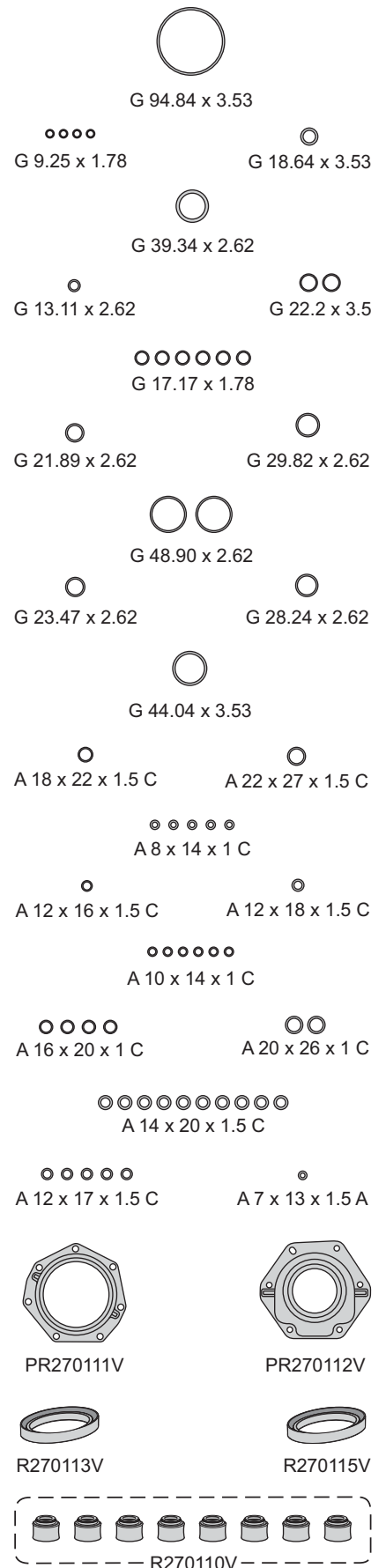

**FIAT**



Motor/Engine Cm³ HP Ø

Fire (SOHC) 8V 1368 80/81 72

Fiat: Palio, Siena, Strada



Nº OE	Descripción/Description	Mat.	1	2	Ref.
	Jgo. de juntas para motor			●	271200-R MLS
	Jgo. de juntas para motor				271200-R
	Jgo. de juntas superior (MLS)		●		271295 MLS
	Jgo. de juntas superior				271295
	Jta. tapa cilindros Ø 73.0 ± 1.20	NFT			271205
	Jta. tapa cilindros Ø 73.0 ± 1.20	NFT			271207
55190882	Jta. tapa cilindros Ø 72.5 ± 0.40	MLS	1	1	271208
	Jgo. tornillos tapa cilindros (HAS13038)				B270500
46748519	Junta tapa de válvulas	N	1	1	270510
46745223	Junta para cárter	CG		1	270711
7084019	Tapa distribución	NB		1	270712
	Bomba de agua	NB	1	1	251014
55199355	Jgo. múltiple escape (2)	NFT	1	1	270515
	Jgo. múltiple admisión (6)	GS	1	1	271217
	Salida de escape	FCH	1	1	270518
7604488	Termostato	NB	1	1	270519
14463580	O`ring bomba de agua a block G 29.74 x 3.53	GS		1	271219
46549928	Guarnición goma	GS	1	1	270532
46824135	Conexión sensor temperatura	GS	1	1	270533
14463580	O`ring G 30.8 x 3.7	GS	1	1	271217
	Kit de retenes completo				R271200
	Jgo. retén válvulas (8)	V		1	R271210V
55187497	Porta retén bancada	V			PR270511V
40004240	Retén árbol de levas 30 x 42 x 7	P		1	R260113P
	Retén bomba de aceite 27 x 37 x 7	V		1	R270515V

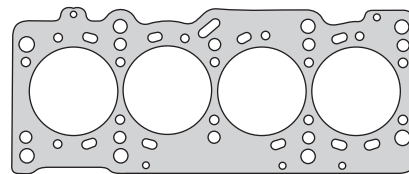

271208

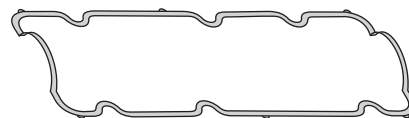

270510

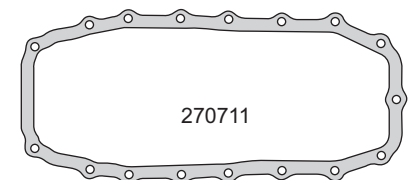

270711

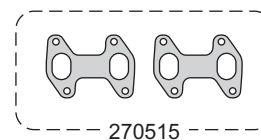

270515

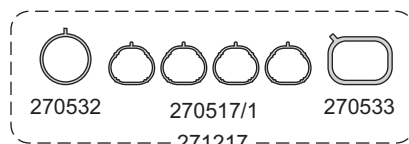

270532

270517/1

270533

271217

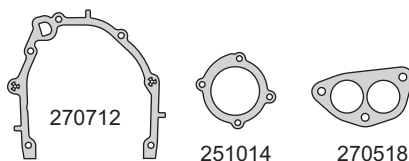

270712

251014

270518



270519

G 30.8 x 3.7

271219



PR270511V



R260113P

R270515V



R271210V



**FIAT**



Motor/Engine	Cm³	HP	Ø
182B7	1998	155	82
182B3	1998	155	82
838A1 (DOHC) 20V	1998	145	82

**Fiat:** Bravo - Coupe - Marea 1998/01  
**Lancia:** Kappa 1994/01



Nº OE	Descripción/Description	Mat.	Ref.
	Jgo. de juntas para motor		271300-R
71713675	Jgo. de juntas superior		271395
7766268	Jta. tapa cilindros Ø 83.0 ± 1.80 NR <sup>3</sup>	NFT	270907
7710582	Jgo. tornillos tapa cilindros (HAR10168)		B270900
46464114	Junta tapa válvulas	GS	271310
	Junta para cárter	NB	270911
46544944/1	Jgo. tapa distribución (2)	GS	271312
7774203	Junta frente motor, bomba de aceite	NB	270913
7772358	Múltiple escape	AC	271315
7765227	Múltiple admisión	SLS	271317
73503584	Salida de escape y acople catalizador	AC	271318
46464149	Guarnición cierre llenado aceite	GS	270929
55196309	Arandela tapón de cárter B 18 x 24 x 2.3 CN	CN	450029
	Junta cierre estanqueidad nivel aceite	GS	270931
	Entrada admisión	SLS	270632
	Guarnición goma G 69.5 x 74.5 x 6.5	GS	271333
	Junta entre colector y escape	SLS	271334
	Bomba de agua	NB	270940
7734963	Arandela bulón tapa de cilindro A 10 x 22.8 x 4 C	CU	
	Arandela A 18 x 26 x 1.5 C	CU	1
5894834	O´ring bomba de agua G 79 x 1.78	GS	1
	O´ring G 53.64 x 2.62	GS	1
	O´ring G 34.65 x 1.78	GS	1
	O´ring G 21.89 x 2.62	GS	1
14457681	O´ring G 18.77 x 1.78	GS	1
	Kit de retenes completo		R270900
55188053	Jgo. retén válvulas (20)	V	1 R270910V
71718365	Porta retén bancada trasera	V	PR252011V
60603436	Retén árbol de levas 55 x 68 x 8	V	1 R270612V
40004240	Retén árbol de levas 30 x 42 x 7	V	1 R260113V
7628850	Retén árbol de levas secund. 31 x 41 x 7	V	1 R270615V

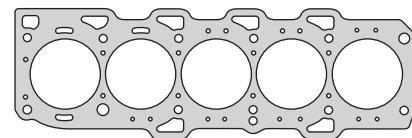

270907

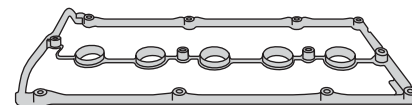

271310

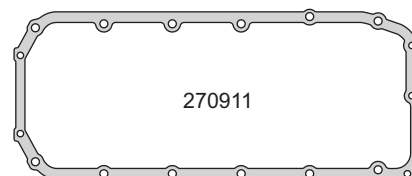

270911

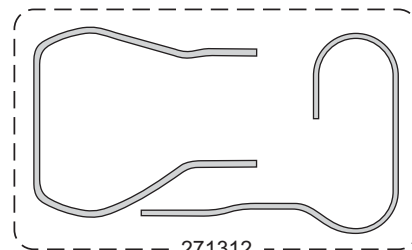

271312



270913



271315



271317



270929



270931

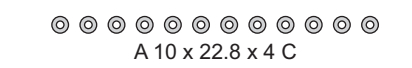

G 79 x 1.78



G 53.64 x 2.62

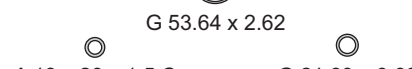

G 34.65 x 1.78



G 21.89 x 2.62



G 18.77 x 1.78



A 10 x 22.8 x 4 C



A 18 x 26 x 1.5 C



G 69.5 x 74.5 x 6.5

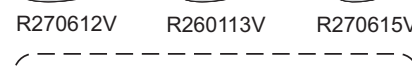

R270612V



R260113V

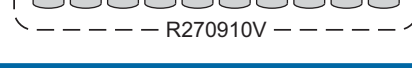

R270910V

**FIAT**



Motor/Engine	Cm³	HP	Ø
188A9 (DOHC) 16V	1248	70	69.6

Fiat: Punto ELX JTD 2003/...  
Strada Trekking Fase III JTD 2010/...

DIESEL



Nº OE	Descripción/Description	Mat.	Ref.
0071744288	Jgo. de juntas para motor		● 271500-R MLS
	Junta tapa cilindros Ø 72.0 $\pm$ 1.20	NFT	271507-1M
	Junta tapa cilindros Ø 72.0 $\pm$ 1.30	NFT	271507-2M
	Junta tapa cilindros Ø 72.0 $\pm$ 1.40	NFT	271507-3M
0055209070	Junta tapa cilindros Ø 71.0 $\pm$ 0.70	MLS	1 271508-SM
0055209071	Junta tapa cilindros Ø 71.0 $\pm$ 0.80	MLS	271508-1M
0055209072	Junta tapa cilindros Ø 71.0 $\pm$ 0.90	MLS	271508-2M
	Jgo. tornillos tapa cilindros (HAR12063)		B271500
0073500063	Junta tapa válvulas/caballate	SLS	1 271510
	Junta para cárter	NH	271511
0055186663	Junta distribución	AL/GS	1 271512
0055209071	Guarnición bomba de agua G 66.5 x 70.5 x 3	GS	271514
0073500058	Múltiple escape	AC	1 271515
	Múltiple admisión	GS	1 271517
	Salida de escape a turbo	AC	1 271518
	Base termostato	GS	271519
0073501332	Junta base radiador aceite	GS	1 271527
	Junta acople tubo	SLS	1 271534
0055187301	Buje varilla de aceite	GS	271535
0071732845	Junta inspección placa	GS	1 271536
	Junta	SLS	1 271538
	Junta base turbo	AC	271539
	Junta distanciadora block	SLS	1 271540
	Junta acople turbo	NB	271542
	Junta acople turbo rígido	SLS	271543
	Junta	NB	271544
	Junta acople turbo	NB	271545
0071740366	Junta trompa bomba de aceite	GS	271546
	Junta	SLS	271547
0073502578	Junta acople electro válvula	SLS	271548
	Junta	SLS	1 271549
	Arandela tapón cárter A 10.4 x 15.8 x 1 A	AL	1
	Arandela pico inyector A 10 x 17 x 1 C	CU	
0014453781	O´ring G 21 x 1.5	GS	1
	O´ring G 15.7 x 3.1	S	1
	O´ring G 45 x 3	N	1
	O´ring G 45 x 50 x 4	S	1
	Kit de retenes completo		R271500
	Jgo. retén válvulas (16)	V	1 R271510V
	Retén bancada 78 x 100 x 9	T	1 R271511T
	Retén distribución 40 x 52 x 7	V	1 R420613V

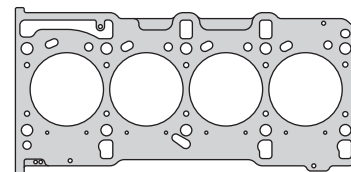

271508

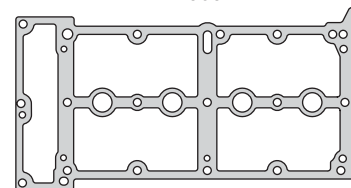

271510

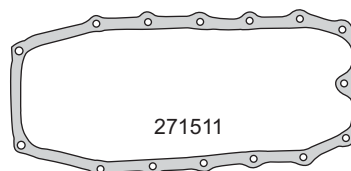

271511

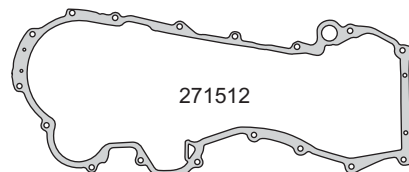

271512



271515



271517

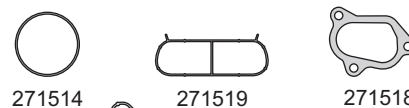

271514 271519 271518

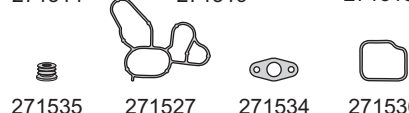

271535 271527 271534 271536

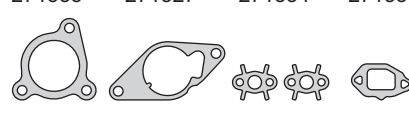

271539 271540 271542 271538

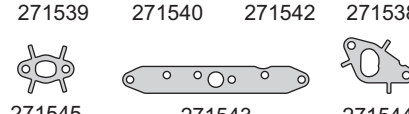

271545 271543 271544

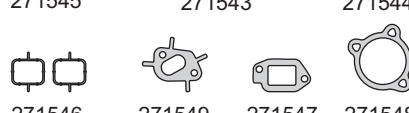

271546 271549 271547 271548

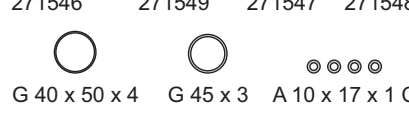

G 40 x 50 x 4 G 45 x 3 A 10 x 17 x 1 C

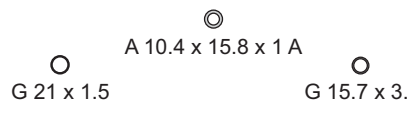

G 21 x 1.5 G 15.7 x 3.1



R271511T R420613V

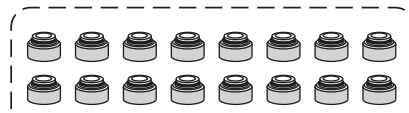

R271510V

# ALFA ROMEO



Motor/Engine	Cm³	HP	Ø
321.02 - 676.01	1598	120	82
322.01 (DOHC) 16V	1747	144	82

Alfa Romeo: 145/146 Twin Spark 1996/...  
156 Twin Spark 1997/...  
GTV Twin Spark 1998/00  
Spider Twin Spark 1998/00



N° OE	Descripción/Description	Mat.	Ref.
	Jgo. de juntas para motor		271800-R
	Jgo. de juntas superior		271895
60608895	Jta. tapa cilindros Ø 84.0 ±1.70 <b>NR3</b>	NFT 1 1	270607
	Jgo. tornillos tapa cilindros (HAR14063)		B270600
	Sellador líquido - caucho de silicona		TRN0085G
	Juntas tapa válvulas	GS 1 1	271810
	Junta distribución	NB 1 1	270612
	Válvula mariposa aceleración	NB 1 1	270614
46526271	Múltiple escape	AC 1 1	270615
	Múltiple admisión	NFT 1 1	270617
	Tapa bomba aceite	AC 1	270627
	Entrada admisión	SLS 1 1	270632
	Salida admisión	SLS 1 1	270633
	Válvula bomba aceite	CB 1	270634
	Guarnición llenado aceite		270635
	O'ring G 62,87 x 5,33	GS 1	
	Arandela A 12 x 18 x 1 C	CU 1	
	Arandela A 14 x 24 x 2 C	CU 1	
	Arandela A 19 x 26 x 1,5 C	CU 1	
	Kit de retenes completo		R270600
	Jgo. retén válvulas (16)	V 1	R260610V
60805182	Retén bancada 74 x 90 x 10	V 1	R260111V
	Porta retén bancada	V	PR270911V
90500805	Retén distribución 55 x 68 x 8	V 1	R270612V
60805219	Retén distribución 30 x 43 x 8	P 1	R260112P
60809849	Retén árbol levas 30 x 42 x 7	P 1	R260113P
	Retén árbol levas auxiliar 30 x 44 x 8	V 1	R270614V
7628850	Retén árbol levas auxiliar 31 x 41 x 7	V 1	R270615V

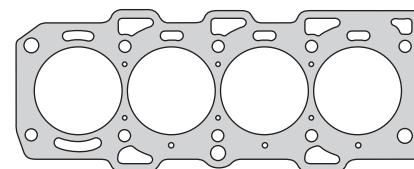

270607

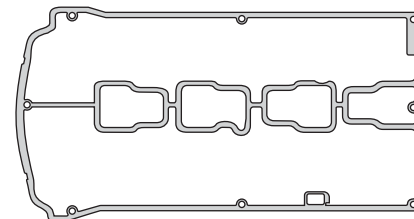

271810



270615

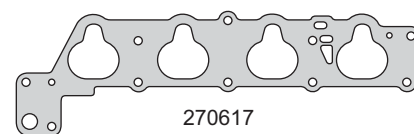

270617

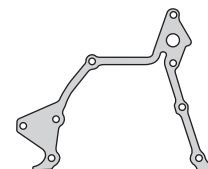

270612

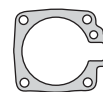

270614



270627



270632



270633



A 14 x 24 x 2 C



270634



A 12 x 18 x 1 C



A 19 x 26 x 1.5 C



G 62.87 x 5.33

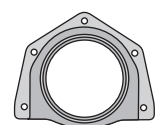

PR270911V



R260111V



R260112P



R270612V



R260113P



R270614V



R270615V

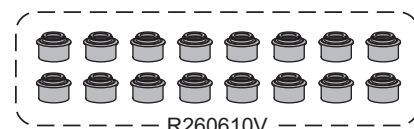

R260610V

**FIAT**



Motor/Engine	Cm³	HP	Ø
350 A1	1242	70	72
169 A4	1368	77/80/82	72
Fire Evo (SOHC) 8V			

**Fiat:** Fire 1.3 - Fiorino, 500 2007/...  
 Fire 1.4 ELX - Evo 2010/..., Idea 2003/...  
 Palio Fase II/III 2007/13 - Siena Gen. III  
 MPI 2002/..., Grande Punto 2005/...  
 Linea 2007/..., Strada Fase III

**Lancia:** Musa 2004/...



Nº OE	Descripción/Description	Mat.	Ref.
7087532	Jgo. de juntas para motor		271900-R MLS
	Jgo. de juntas superior (MLS)	●	271995 MLS
	Jgo. de juntas superior		271995
	Jta. tapa cilindros Ø 73.0 ± 1.20	NFT	271205
	Jta. tapa cilindros Ø 73.0 ± 1.20	NFT	271207
55190882	Jta. tapa cilindros Ø 72.5 ± 0.40	MLS	1 1 271208
7696197	Jgo. tornillos tapa cilindros (HAS13038)		B270500
55222897	Conj. junta tapa válvulas (5)	GS	1 1 271910
46745223/1	Junta para cárter	CG	1 270711
7084019	Tapa distribución	NB	1 270712
	Bomba de agua	NB	251014
	Bomba de agua	GS	1 1 271914
	Bomba de agua	GS	1 1 272014
	Bomba de agua G40.58 x 3.52	GS	1 1 272014-1
55194291	Jgo. múltiple escape (2)	AC	1 1 271915
	Jgo. múltiple admisión (3)	GS	1 1 272217
	Jgo. múltiple admisión (6)	GS	1 1 271217
7604488	Base termostato	NB	1 1 270519
14463580	O´ring bomba de agua a block G 29.74 x 3.53	GS	1 271219
	Anillo tapa válvulas	GS	4 4 271930
46549928	Guarnición goma	GS	1 1 270532
46824135	Conexión sensor temperatura	GS	1 1 270533
7082509	O´ring de válvula G 28.17 x 3.53	GS	1
	O´ring de válvula G 7.52 x 3.53	GS	1
	O´ring G 30.8 x 3.7	GS	1 1
	Kit de retenes completo		R271900
55190344	Jgo. retén válvulas (8)	V	1 R271210V
5210858	Porta retén bancada trasera	VF	PR271911VF
55206525	Retén árbol de levas 40 x 55 x 7	V	1 R270713V
46404094	Retén bomba de aceite 27 x 37 x 7	V	1 R270515V

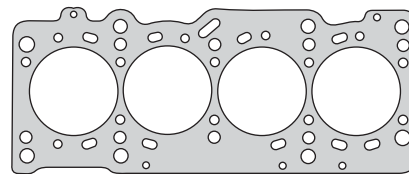

271208

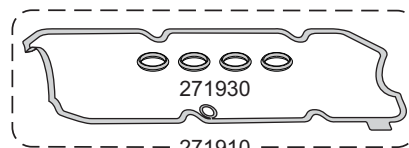

271930

271910

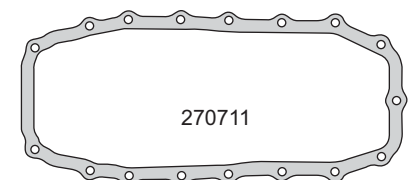

270711

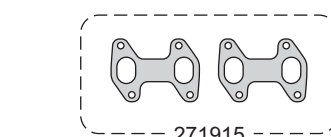

271915

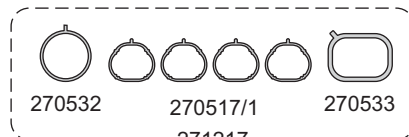

270532

270517/1

270533

271217

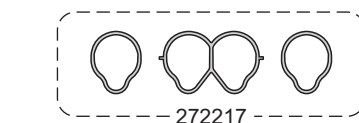

272217

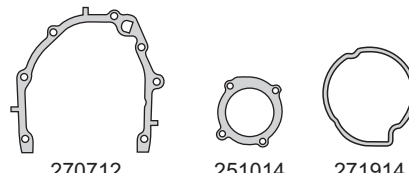

270712

251014

271914



272014

272014-1

270519

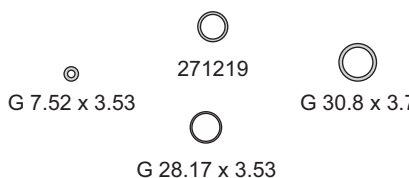

G 7.52 x 3.53

271219

G 30.8 x 3.7

G 28.17 x 3.53

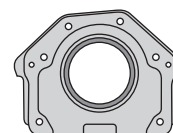

PR271911VF



R270713V



R270515V

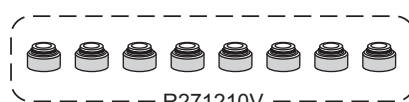

R271210V

**FIAT**



Motor/Engine **Cm³** **HP** **Ø**

**E.torQ**  
**178D20.11/22.11**  
(SOHC) 16V

**1598**    **115**    **77**

**Fiat:** Idea Essence, Idea Sporting  
Idea Adventure, Siena Fase III Essence  
Strada Fase III/IV Adventure  
Palio Wend Fase III/IV Adventure 2010/...  
Punto Essence 2011/...

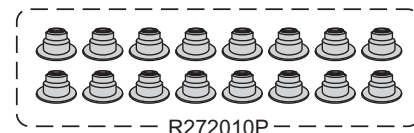
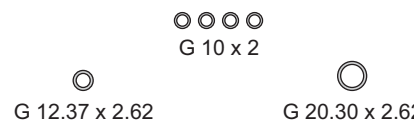
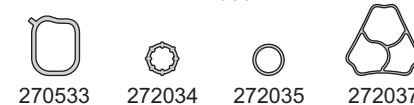
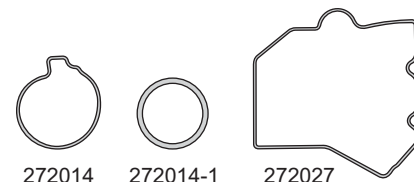
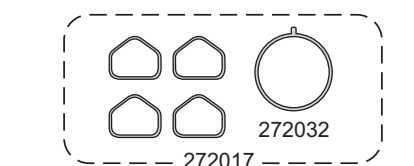
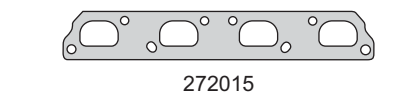
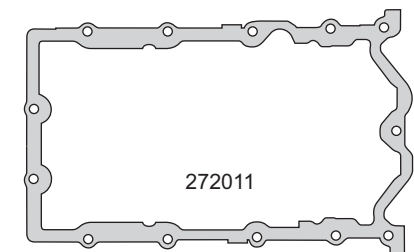
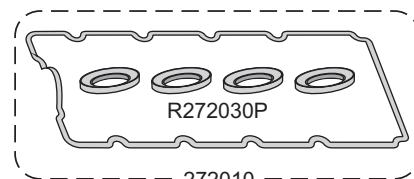
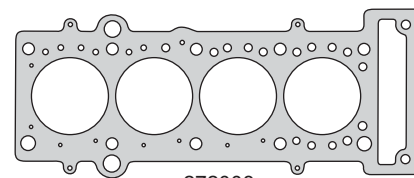

Nº OE	Descripción/Description	Mat.	Ref.
7087743	Jgo. de juntas para motor		272000-R MLS
	Jgo. de juntas superior (MLS)	●	272095 MLS
	Jgo. de juntas superior		272095
	Jta. tapa cilindros Ø 78.0 ± 1.20	NFT	272007
55226527	Jta. tapa cilindros Ø 78.0 ± 0.60	MLS	1 1 272008
55223509	Jgo. tornillos tapa cilindros (HAS15038)		B272000
55224544	Conj. junta tapa de válvulas (5)	GS	1 1 272010
55226126	Guarnición entre cárter y basamiento	NFT	1 272011
	Bomba de agua	GS	1 1 272014
	Bomba de agua G 40.58 x 3.52	GS	1 1 272014-1
55224457	Múltiple escape	AC	1 1 272015
7087745	Jgo. múltiple admisión (5)	S	1 1 272017
55227126	Guarnición frente motor bomba aceite	P	272027
	Arandela junta tapa válvulas	GS	12 12 272030
55224542	Retén capuchón bujías	P	4 4 R272030P
7087746	Guarnición cuerpo mariposa	P	1 1 272032
	Colector admisión	SLS	1 1 272033
46824135	Guarnición sensor temperatura	GS	1 1 270533
7087876	Guarnición entrada aceite a bba G 27 x 32.5 x 4.5	P	1 1 272034
7087877	Guarnición salida aceite a bba G 22.5 x 27.5 x 5.5	P	1 1 272035
55231652	Guarnición base filtro aceite	GS	1 272037
55229989	O´ring G 12.37 x 2.62	GS	1 1
55229787	O´ring G 20.30 x 2.62	GS	1 1
	O´ring inyector G 10 x 2	GS	4 4
	Kit de retenes completo		R272000
55223481	Jgo. retén válvulas (16)	P	1 R272010P
55223567	Retén bancada trasera 91 x 111 x 10	V	1 R330511V
	Retén distribución 32 x 45 x 6.5	P	1 R230412P
55224542	Retén árbol de levas 40 x 55 x 7	V	1 R270713V

FIAT



Motor/Engine Cm³ HP Ø

E.torQ (SOHC) 16V 1747 130 81

Fiat: Punto, Idea, Linea 2011/..



Nº OE	Descripción/Description	Mat.	1	2	Ref.
	Jgo. de juntas para motor			●	272100-R MLS
	Jgo. de juntas superior (MLS)		●		272195 MLS
	Jta. tapa cilindros Ø 82.5 $\pm$ 1.40	NFT			272105
	Jta. tapa cilindros Ø 82.5 $\pm$ 1.20	NFT			272107
55231762	Jta. tapa cilindros Ø 82.0 $\pm$ 0.60	MLS	1	1	272108
55223509	Jgo. tornillos tapa cilindros (HAS15038)				B272000
55224544	Conj. junta tapa válvulas (5)	GS	1	1	272010
55226126	Junta para cárter	NFT		1	272011
	Junta para cárter	PLAST			272111
55224457	Múltiple escape	AC	1	1	272015
7087745	Jgo. múltiple admisión (5)	S	1	1	272017
55227126	Guarnición frente motor bomba aceite	P			272027
	Arandela junta tapa válvulas	GS	12	12	272030
55224542	Retén capuchón bujías	P	4	4	R272030P
7087746	Guarnición cuerpo mariposa	P	1	1	272032
	Colector admisión	SLS	1	1	272033
46824135	Guarnición sensor temperatura	GS	1	1	270533
7087876	Guarnición entrada aceite a bba G 27 x 32.5 x 4.5	P	1	1	272034
7087877	Guarnición salida aceite a bba G 22.5 x 27.5 x 5.5	P	1	1	272035
55231652	Guarnición base filtro aceite	GS		1	272037
55229989	O´ring G 12.37 x 2.62	GS	1	1	
55229787	O´ring G 20.30 x 2.62	GS	1	1	
	O´ring inyector G 10 x 2	V	4	4	
	Kit de retenes completo				R272000
55223481	Jgo. retén válvulas (16)	P		1	R272010P
55223567	Retén bancada trasera 91 x 111 x 10	V		1	R330511V
	Retén distribución 32 x 45 x 6.5	P		1	R230412P
55224542	Retén árbol de levas 40 x 55 x 7	V		1	R270713V

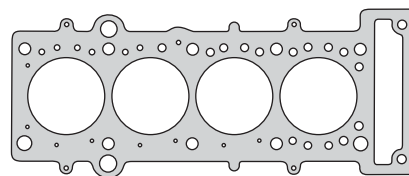

272108

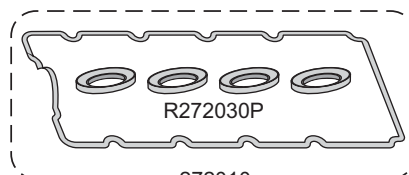

272010

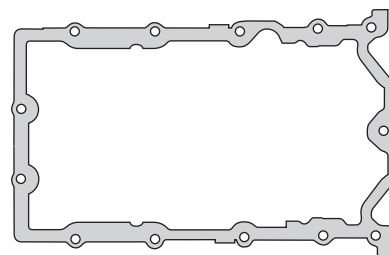

272011 - 272111

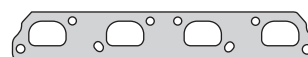

272015



272033

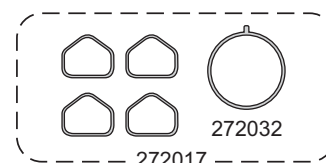

272017

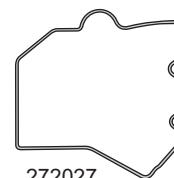

272027



272030



270533

272034

272035

272037

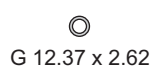

G 12.37 x 2.62



G 20.30 x 2.62



G 10 x 2



R330511V



R230412P



R270713V

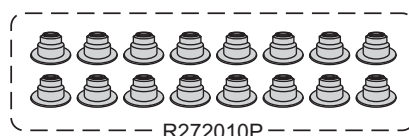

R272010P

FIAT



Motor/Engine

Cm³

HP

Ø

Fire EVO  
(SOHC) 8V

999

73/75

70

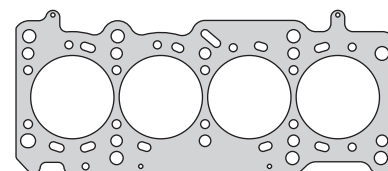
Fiat: Palio, Siena Generación III  
Uno Fase II 2010/...

272208

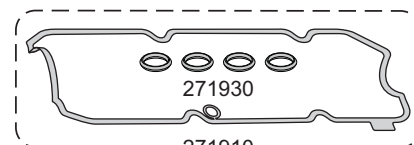

271930

271910

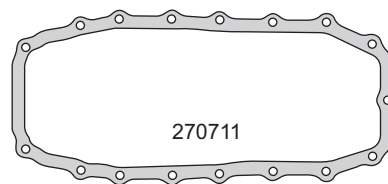

270711

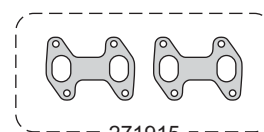

271915



270532

270517/1

270533

271217

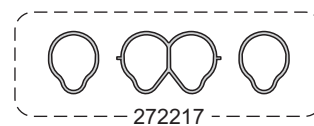

272217



270512



251014

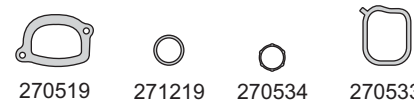

270519

271219

270534

270533



G 28.17 x 3.53



G 7.52 x 3.53

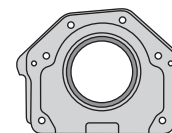

PR271911VF



R272213V



R270515V

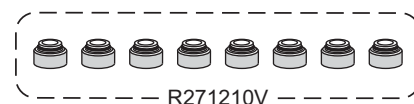

R271210V

Nº OE	Descripción/Description	Mat.	Ref.
7087532	Jgo. de juntas para motor		272200-R MLS
	Jgo. de juntas superior (MLS)		272295 MLS
	Jgo. de juntas superior		272295
	Jta. tapa cilindros Ø 72.0 $\pm$ 1.20	NFT	272205
	Jta. tapa cilindros Ø 72.0 $\pm$ 1.20	NFT	272207
55190882	Jta. tapa cilindros Ø 72.5 $\pm$ 0.60	MLS	1 1 272208
7696197	Jgo. tornillos tapa cilindros (HAS13038)		B270500
55222897	Conj. junta tapa válvulas (5)	GS	1 1 271910
46745223/1	Junta para cárter	CG	1 270711
46552427	Tapa distribución	NB	1 270512
	Bomba de agua	NH	251014
55194291	Múltiple escape (2)	AC	1 1 271915
	Jgo. múltiple admisión (6)	GS	1 1 271217
	Jgo. múltiple admisión (3)	GS	1 1 272217
7604488	Base termostato	NB	1 1 270519
14463580	O´ring bomba de agua a block G 29.74 x 3.53	GS	1 271219
	Anillo tapa válvulas	GS	4 4 271930
46549928	Guarnición goma	GS	1 1 270532
46824135	Conexión sensor temperatura	GS	1 1 270533
7086127/1	Guarnición anillo válvula	S	270534
7082509	O´ring de válvulas G 28.17 x 3.53	GS	1
	O´ring de válvulas G 7.52 x 3.53	GS	1
	Kit de retenes completo		R272200
55190344	Jgo. retén válvulas (8)	V	1 R271210V
5210858	Porta retén bancada trasera	VF	PR271911VF
55206525	Retén árbol de levas 31 x 55 x 7	V	1 R272213V
46404094	Retén bomba de aceite 27 x 37 x 7	V	1 R270515V

**FIAT**



Motor/Engine	Cm³	HP	Ø
182A2 (DOHC) 16V	1747	113	82

Fiat: Marea 1996/..., Brava, Bravo 1995/...



Nº OE	Descripción/Description	Mat.	Ref.
	Jgo. de juntas para motor		272300-R
60608895	Junta tapa cilindros Ø 84.0 ± 1.70	NFT	1 270607
	Jgo. tornillos tapa cilindros (HAR14063)		B270600
	Sellador líquido - caucho de silicona		TRN0085G
	Conjunto juntas tapa válvulas (6)	GS	1 272310
	Tapa inferior cárter	NB	1 272311
	Junta distribución	NB	1 270612
	Salida de escape	NB	1 272318
60611531	Múltiple escape	AC	1 270615
	Múltiple admisión	NFT	1 270617
	Junta	NB	1 272327
	Válvula mariposa aceleración	NB	1 272330
	Arandela capuchon bujías	GS	4 270933
	Entrada admisión	SLS	1 270632
	Salida admisión	SLS	1 270633
	Anillo G 64 x 70 x 3	GS	1
	O´ring G 76 x 2	GS	1
	O´ring G 55.25 x 2.62	GS	1
	O´ring G 34.65 x 1.78	GS	1
	O´ring G 21.89 x 2.62	GS	1
	O´ring G 18.72 x 2.62	GS	1
	O´ring G 17.17 x 1.78	GS	1
	O´ring G 10.82 x 1.78	GS	1
	O´ring G 6.07 x 1.78	GS	1
	O´ring inyector G 7.52 x 3.53	GS	8
	Arandela A 20 x 26 x 1.5 C	CU	1
	Arandela A 12 x 18 x 1 C	CU	1
	Kit de retenes completo		R272300
60548495	Jgo. retén válvulas (16)	V	1 R260610V
93178503	Porta retén bancada	V	PR270911V
	Retén de bancada 74 x 90 x 10	V	1 R260111V
	Retén de distribución 30 x 43 x 8	P	1 R260112P
90500805	Retén de distribución 55 x 68 x 8	V	1 R270612V
60809849	Retén árbol levas 30 x 42 x 7	P	1 R260113P
	Retén árbol levas auxiliar 30 x 44 x 8	V	1 R270614V
7628850	Retén árbol levas auxiliar 31 x 41 x 7	V	1 R270615V

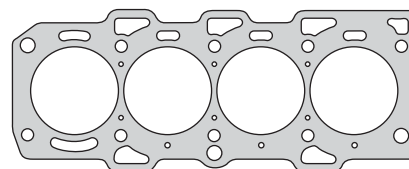

270607

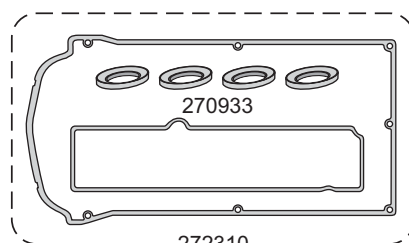

270933

272310

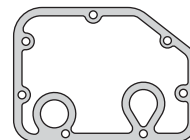

272311



270615

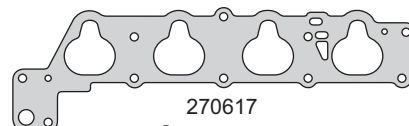

270617

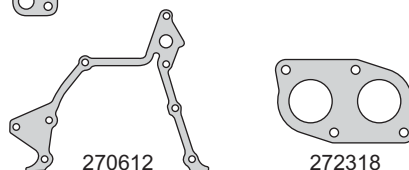

270612

272318

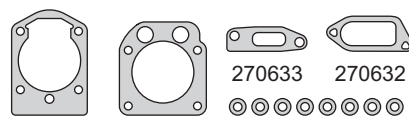

272327

272330

270633 270632

G 7.52 x 3.53



G 55.25 x 2.62

G 76 x 2

G 64 x 70 x 3



A 20 x 26 x 1.5 C

A 12 x 18 x 1 C

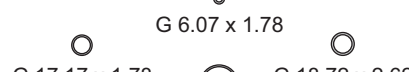

G 6.07 x 1.78

G 17.17 x 1.78

G 18.72 x 2.62



G 34.65 x 1.78

G 10.82 x 1.78

G 21.89 x 2.62

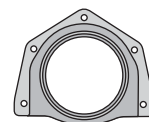

PR270911V



R270612V



R260113V



R270615V

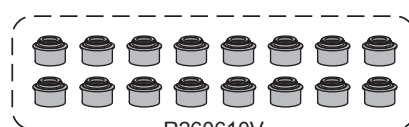

R260610V



**FIAT**



Motor/Engine	Cm³	HP	Ø
198A4	1368	105	72
199A8	1368	105	72
955A6/A8 (DOHC) 16V	1368	105	72

Fiat: 500, Punto, Bravo, Doblo, Punto T-Jet 2009/...

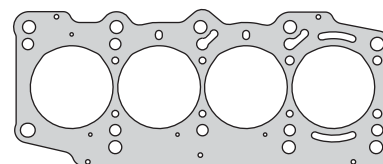

272408

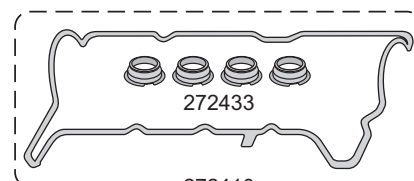

272410

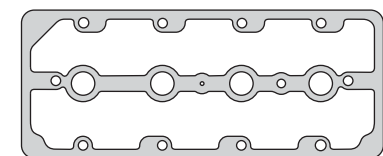

272431

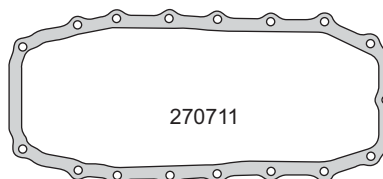

270711



272415



270517

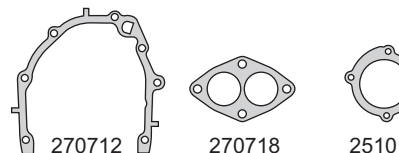

270712

270718

251014

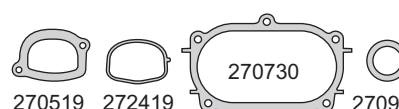

270519

272419

270730

270929

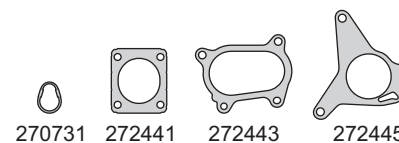

270731

272441

272443

272445

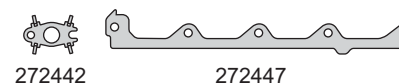

272442

272447

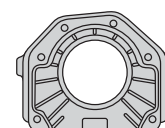

PR270711V



R270713P

R270515P

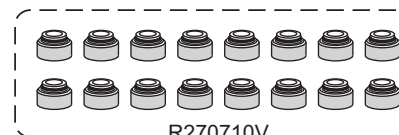

R270710V

Nº OE	Descripción/Description	Mat.	Ref.
	Jgo. de juntas para motor		272400-R MLS
	Jgo. de juntas superior		272495 MLS
	Jta. tapa cilindros Ø 73.0 ± 1.30	NFT	272407
55206232	Jta. tapa cilindros Ø 73.0 ± 0.60	MLS	1 1 272408
	Jgo. tornillos tapa cilindros		B270700
55225144	Conj. junta tapa de válvulas (5)	GS	1 1 272410
46745223	Junta para cárter aceite	CG	1 270711
46552317	Tapa distribución	NB	1 270712
	Bomba de agua	NB	1 251014
	Múltiple escape	MLS	1 1 272415
71716583	Jgo. múltiple admisión (5)	GS	1 1 270517
46774747	Salida de escape	FCH	1 1 270718
7604488	Termostato	NB	1 1 270519
	Termostato	GS	1 272419
	Junta estanqueidad	GS	1 1 270929
46751961	Tapa trasera distribución	SLS	1 1 270730
71716584	Guarnición admisión	GS	1 1 270731
46513955	Junta caballete	SLS	1 1 272431
46549928	Guarnición valvula mariposa	GS	1 1 270532
	Guarnición capuchón bujías	AC/GS	4 272433
55224615	Colector de escape a turbo	AC	1 272441
55196740	Junta	AC	1 272442
51896690	Junta acople a turbo	SLS	272443
	Junta bomba depresora	SLS	1 272445
55222222	Junta accionador	SLS	1 272447
	Arandela A 12 x 16 x 1A	AL	4
	Arandela A 14 x 20 x 1.5 A	AL	4
7083082	O´ring inyectores G 7.52 x 3.53	GS	4 4
	O´ring G 12 x 3	GS	2
	O´ring G 15.6 x 1.78	GS	10 10
	O´ring G 21.95 x 1.78	GS	1
	O´ring G 25.07 x 2.62	GS	1
14463580	O´ring G 30.8 x 3.7	GS	1 1
	O´ring G 45.69 x 2.62	GS	1
	O´ring G 34.52 x 3.53	GS	1
	O´ring G 47.22 x 3.53	GS	1
	O´ring G 26.57 x 3.53	GS	1
	O´ring G 29.74 x 3.53	GS	2
	O´ring G 21.95 x 1.78	GS	1
	Kit retenes completo		R270700
46470334	Jgo. retén válvulas (16)	V	1 R270710V
46751174	Porta retén bancada 74 x 187.5/141 x 17	V	1 PR270711V
46780736	Retén árbol de levas 40 x 55 x 7	P	2 R270713P
	Retén bomba de aceite 27 x 37 x 7	P	1 R270515P

**FIAT**



Motor/Engine	Cm³	HP	Ø
178D7	1242	80	72
183A1	1368	95	72
192B2 (DOHC) 16V	1368	95	72

**Fiat:** Palio 2002/..., Siena 2005/...  
Punto 2003/..., Idea, Stilo 2004/...  
Doblo 2010/...  
**Lancia:** Ypsilon 2003/...



Nº OE	Descripción/Description	Mat.	Ref.
	Jgo. de juntas para motor		● 272500-R MLS
	Jgo. de juntas superior	●	272595 MLS
	Jta. tapa cilindros Ø 73.0 $\pm$ 1.20	NFT	272507
55206232	Jta. tapa cilindros Ø 73.0 $\pm$ 0.45	MLS	1 1 272508
	Jgo. tornillos tapa cilindros		B270700
46745223	Junta para cárter aceite	CG	1 270711
46552317	Tapa distribución	NB	1 270712
	Bomba de agua	NB	1 1 251014
46526271	Múltiple escape	SLS	1 1 270715
71716583	Jgo. múltiple admisión (6)	GS	1 1 270517
46774747	Salida de escape	FCH	1 1 270718
7604488	Termostato	NB	1 1 270519
	Termostato	GS	1 272419
	Junta estanqueidad	GS	1 1 270929
46751961	Tapa trasera distribución	SLS	1 1 270730
71716584	Guarnición admisión	GS	1 1 270731
46513955	Junta caballete	SLS	1 1 272431
46549928	Guarnición valvula mariposa	GS	1 1 270532
	Arandela A 12 x 16 x 1 A	AL	4
	Arandela A 14 x 20 x 1.5 A	AL	4
7083082	O'ring inyectores G 7.52 x 3.53	GS	4 4
	O'ring G 12 x 3	GS	2
	O'ring G 15.6 x 1.78	GS	10 10
	O'ring G 21.95 x 1.78	GS	1
	O'ring G 25.7 x 2.62	GS	1
14463580	O'ring G 30.8 x 3.7	GS	1 1
	O'ring G 45.69 x 2.62	GS	1
	O'ring G 34.52 x 3.53	GS	1
	O'ring G 47.22 x 3.53	GS	1
	O'ring G 26.57 x 3.53	GS	1
	O'ring G 29.74 x 3.53	GS	2
	O'ring G 21.95 x 1.78	GS	1
	Kit retenes completo		R270700
46470334	Jgo. retén válvulas (16)	V	1 R270710V
46751174	Porta retén bancada 74 x 187.5/141 x 17	V	1 PR270711V
46780736	Retén árbol de levas 40 x 55 x 7	P	2 R270713P
	Retén bomba de aceite 27 x 37 x 7	P	1 R270515P

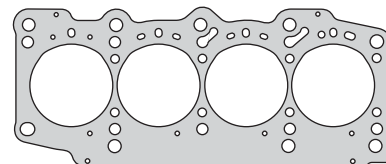

272508

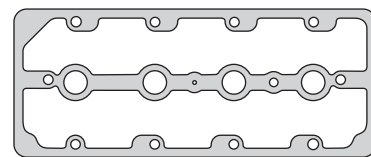

272431

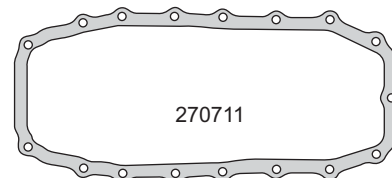

270711



270715



270517/1 270731 270532

270517

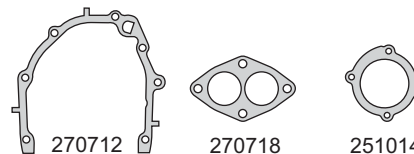

270712 270718 251014

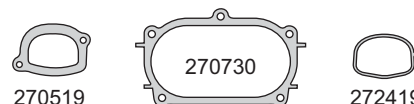

270519 270730 272419



270929

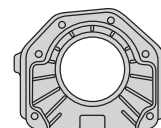

PR270711V



R270713P R270515P

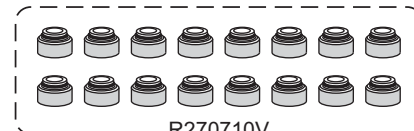

R270710V

**FIAT**



Motor/Engine	Cm³	HP	Ø
<b>E.torq</b> (SOHC) 16V	<b>1598</b> <b>1747</b>	<b>115/117</b> <b>130</b>	<b>77</b> <b>77</b>

**Fiat:** 1.6 Grand Siena 2012/..., Idea 2011/16  
 Palio 2012/..., Punto 2013/17, Strada 2013/...  
 1.8 Toro 2016/..., Argo 2017/..., Cronos  
 2018/...



Nº OE	Descripción/Description	Mat.	Ref.
	Jgo. de juntas para motor		● 272600-R MLS
	Jgo. de juntas superior (MLS)	●	272695
	Jta. tapa cilindros Ø 78.0 $\pm$ 1.20	NFT 1	272607
552637320	Jta. tapa cilindros Ø 78.0 $\pm$ 0.60	MLS 1	272608
55223509	Jgo. tornillos tapa cilindros (HAS15038)		B272000
55242412	Conj. junta tapa de válvulas (5)	GS 1	1 272110
55226126	Junta para cárter	NFT 1	272011
	Junta para cárter	PLAST 1	272111
55224457	Múltiple escape	AC 1	1 272015
7087745	Jgo. múltiple admisión (5)	S 1	1 272017
55227126	Guarnición frente motor bomba aceite	P	272027
	Arandela junta tapa válvulas	GS 12	12 272030
	Retén capuchón bujías	P 4	4 273530
7087746	Guarnición cuerpo mariposa	P 1	1 272032
46824135	Guarnición sensor temperatura	GS 1	1 270533
	Colector admisión	SLS 1	1 272033
7087876	Guarnición entrada aceite a bba G 27 x 32.5 x 4.5	P 1	1 272034
7087877	Guarnición salida aceite a bba G 22.5 x 27.5 x 5.5	P 1	1 272035
55231652	Guarnición base filtro aceite	GS	272037
55229989	O´ring G 12.37 x 2.62	GS	1
55229787	O´ring G 20.30 x 2.62	GS	1
	O´ring inyector G 10 x 2	GS 4	4
	Kit de retenes completo		R272000
55223481	Jgo. retén válvulas (16)	P 1	1 R272010P
55223567	Retén bancada trasera 91 x 111 x 10	V 1	1 R330511V
	Retén distribución 32 x 45 x 6.5	P 1	1 R230412P
55224542	Retén árbol de levas 40 x 55 x 7	V 1	1 R270713V

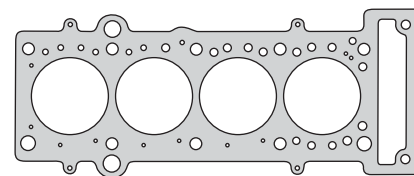

272608

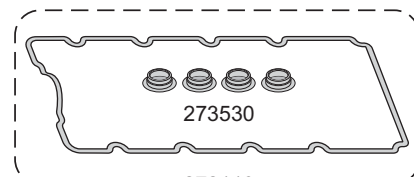

273530

272110

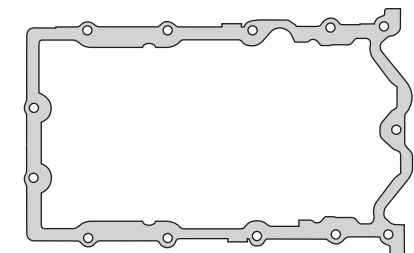

272011/272111

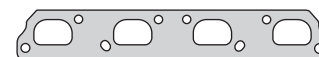

272015



272033

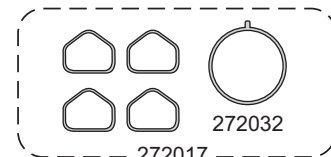

272032

272017

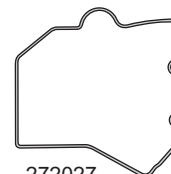

272027



272030



270533



272034



272035



272037



G 10 x 2



G 12.37 x 2.62



G 20.30 x 2.62



R330511V



R230412P



R270713V



R272010P

**FIAT**



Motor/Engine	Cm³	HP	Ø
E.torQ (SOHC) 16V	1747	135/139	80.5

Fiat: Argo, Bravo 2011/16, Doblo 2010/...  
Idea 2011/16, Linea 2009/16, Palio 2013/...  
Punto 2013/17, Strada 2013/..



Nº OE	Descripción/Description	Mat.	Ref.
	Jgo. de juntas para motor		● 272700-R MLS
	Jgo. de juntas superior (MLS)	●	272795
	Jta. tapa cilindros Ø 82.5 $\pm$ 1.40	NFT	272705
	Jta. tapa cilindros Ø 82.5 $\pm$ 1.20	NFT 1	272707
552628740	Jta. tapa cilindros Ø 82.5 $\pm$ 0.60	MLS	1 272708
55223509	Jgo. tornillos tapa cilindros (HAS15038)		B272000
55242412	Conj. junta tapa válvulas (5)	GS 1	1 272110
55226126	Junta para cárter	NFT	1 272011
	Junta para cárter	PLAST	272111
55224457	Múltiple escape	AC 1	1 272015
7087745	Jgo. múltiple admisión (5)	S 1	1 272017
55227126	Guarnición frente motor bomba aceite	P	272027
	Arandela junta tapa válvulas	GS 12	12 272030
55245355	Retén capuchón bujías	P 4	4 273530
7087746	Guarnición cuerpo mariposa	P 1	1 272032
46824135	Guarnición sensor temperatura	GS 1	1 270533
	Colector admisión	SLS 1	1 272033
7087876	Guarnición entrada aceite a bba G 27 x 32.5 x 4.5	P 1	1 272034
7087877	Guarnición salida aceite a bba G 22.5 x 27.5 x 5.5	P 1	1 272035
55231652	Guarnición base filtro aceite	GS	1 272037
55229989	O´ring G 12.37 x 2.62	GS	1
55229787	O´ring G 20.30 x 2.62	GS	1
	O´ring inyector G 10 x 2	V 4	4
	Kit de retenes completo		R272000
55223481	Jgo. retén válvulas (16)	P 1	1 R272010P
55223567	Retén bancada trasera 91 x 111 x 10	V 1	1 R330511V
	Retén distribución 32 x 45 x 6.5	P 1	1 R230412P
55224542	Retén árbol de levas 40 x 55 x 7	V 1	1 R270713V

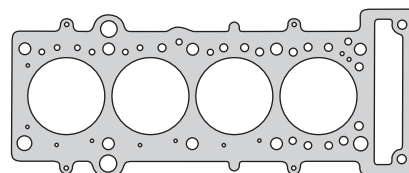

272708

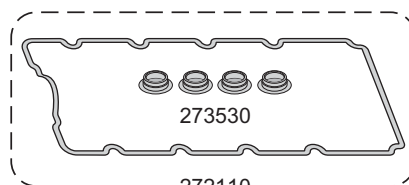

273530

272110

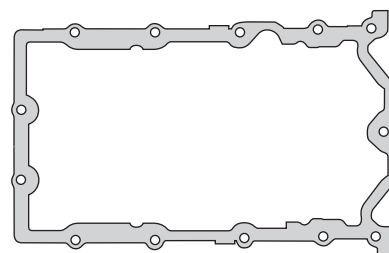

272011 - 272111

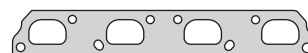

272015



272033

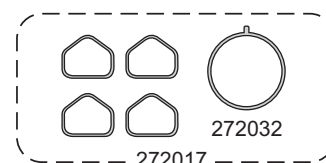

272032

272017

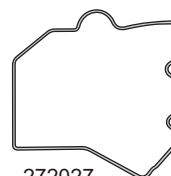

272027



272030



270533



272034



272035



272037



G 10 x 2

G 12.37 x 2.62

G 20.30 x 2.62



R330511V



R230412P



R270713V



R272010P

**FIAT**



Motor/Engine	Cm³	HP	Ø
310A4011 Torque 16V	1896	130/132	86.4

Fiat: Línea 1.9 2008/15



Nº OE	Descripción/Description	Mat.	Ref.
	Jgo. de juntas para motor		272800-R
	Jgo. de juntas superior		272895
	Jta. tapa cilindros Ø 88.0 ±1.20 NR	NFT 1 1	272807
	Jgo. tornillos tapa cilindros (HAR10168)		B260900
7773831	Junta tapa válvulas (metálica)	SLS 2 2	260931
7663366	Junta para cárter	NB 1	260911
7737203	Porta retén delantero	NB 1	250412
46412116	Múltiple escape	NFT 1 1	260916
46410505	Múltiple admisión	NFT 1 1	260917
1482930	Salida de escape	FCH 1 1	250618
7770023	Pasaje de agua a tapa	NB 1 1	260919
	Tapa bomba aceite	CU 1	260927
4947376	Mariposa aire	NB 1 1	260929
	Mariposa aire	NB 1 1	260930
7737204	Tapa inspección cigueñal	NB 1	250434
46413166	Salida de múltiple a catalizador	AC	260936
4179138	Base bomba aceite	NB 1	250439
4902267	Porta retén	NB 1	260241
46402220	Jgo. toberas múltiple admisión (4)	N 1 1	260939
	O'ring G 6.07 x 1.78	GS 1	
7792371	O'ring G 18.72 x 2.62	GS 1	
46428901	O'ring G 59.92 x 3.53	GS 2 2	
7792369	O'ring G 17.12 x 2.62	GS 1 1	
	O'ring G 55.25 x 2.62	GS 1 1	
	O'ring bomba de agua G 88.57 x 2.62	GS 1	
	O'ring bomba de agua G 31.34 x 3.53	GS 1	
	O'ring varilla aceite G 6.07 x 1.78	GS 1	
	O'ring llena aceite G 26.57 x 3.53	GS 1	
	O'ring árbol levas G 66.27 x 3.53	GS 1	
	O'ring tubo llenado G 50.39 x 3.53	GS 1	
	Kit de retenes completo		R260900
	Jgo. retén válvulas (16)	V 1	R260610V
	Porta retén bancada 64 x 81.50 x 8	V 1	PR260911V
	Retén distribución 40 x 56 x 7	P 1	R260312P
	Retén árbol levas bba. de aceite 30 x 42 x 7	P 1	R260113P
	Retén árbol levas 30 x 52 x 7	P 2	R260313P

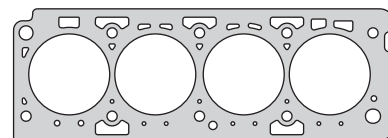

272807

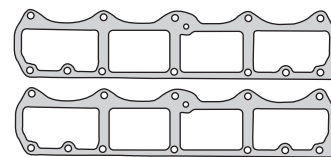

260931

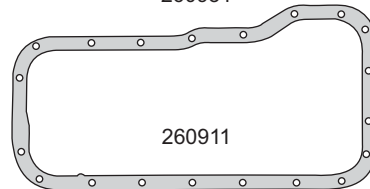

260911

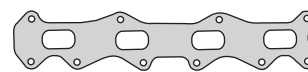

260916



260917



260939

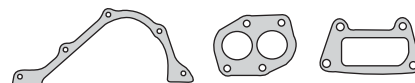

250412

250618

260919

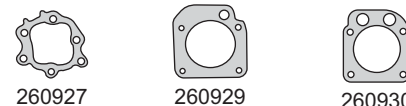

260927

260929

260930

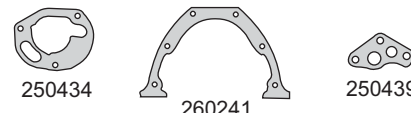

250434

260241

250439



G 66.27 x 3.53



G 55.25 x 2.62



G 59.92 x 3.53



G 88.57 x 2.62



G 50.39 x 3.53



G 17.12 x 2.62



G 26.57 x 3.53



G 6.07 x 1.78



G 18.72 x 2.62



G 31.34 x 3.53

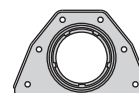

PR260911V



R260312P



R260313P



R260113P

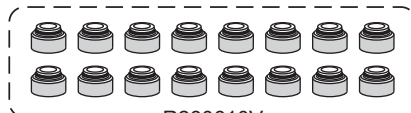

R260610V

FIAT



Motor/Engine

Cm³

HP

Ø

Fiat: Argo, Mobi, Uno 2018/...













Firefly  
(SOHC) 6V

999

77

70



N° OE	Descripción/Description	Mat.	Ref.
	Jgo. de juntas para motor 		● 272900-R MLS
	Jta. tapa cilindros Ø 72.0 $\pm$ 1.20 	NFT	272907
55267849	Jta. tapa cilindros Ø 71.0 $\pm$ 0.60 	MLS	1 272908
	Sellador líquido - caucho de silicona 		TRN0085G
7090228	Conj. junta tapa de válvulas (4) 	GS	1 272910
	Junta para cárter 		272911
52042057	Múltiple de escape 	AC	1 272915
7090209	Jgo. múltiple admisión (4) 	GS	1 272917
68095285AA	Anillo tapa válvulas	GS	3 271930
7090215	Junta TBI	GS	1 272932
	Kit de retenes completo 		R272900
55267937	Jgo. retén válvulas (6) 	V	1 R272910V
55267742	Retén de bancada 80 x 96 x 9 	V	1 R520811V
7091279	Retén distribución 34 x 47 x 5.5 	V	1 R272912V

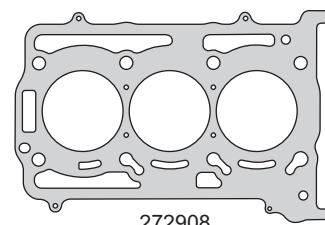

272908

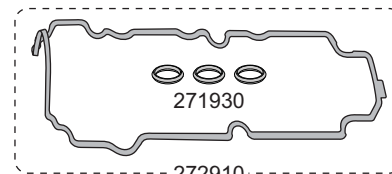

271930

- 272910 -

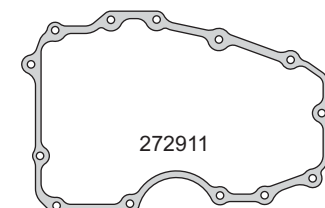

272911



272915

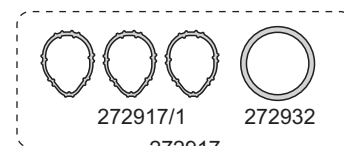

272917/1

272932

- 272917 -



R520811V



R272912V

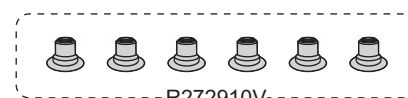

- R272910V -

**FIAT**



Motor/Engine **Cm³** **HP** **Ø**

**Firefly**  
(SOHC) 8V

1332

99

70

Fiat: Argo, Cronos 2018/...

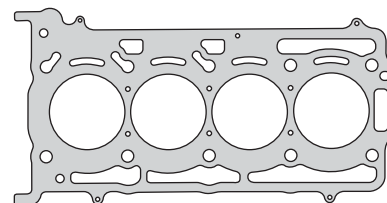

273008

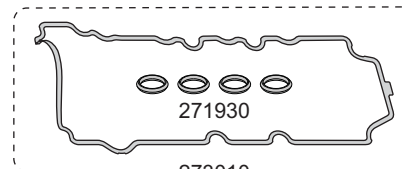

271930

273010

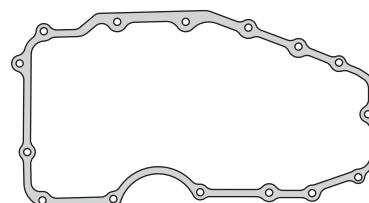

273011



273015

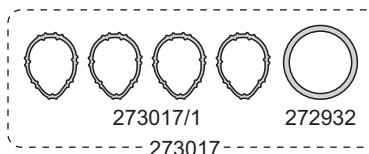

273017/1

272932

273017



R520811V



R272912V



-R273010V-

Nº OE	Descripción/Description	Mat.	Ref.
	<b>Jgo. de juntas para motor</b>		● 273000-R MLS
	<b>Junta tapa cilindros Ø 72.0 ± 1.20</b>	NFT	273007
55268170	<b>Junta tapa cilindros Ø 71.0 ± 0.60</b>	MLS	1 273008
7090246	Conj. juntas tapa de válvulas (5)	GS	1 273010
	Junta para cárter	NB	1 273011
52042058	Múltiple de escape	AC	1 273015
7090209	Jgo. múltiple admisión (5)	GS	1 273017
68095285AA	Anillo tapa válvulas	GS	4 271930
7090215	Junta TBI	GS	1 272932
	Kit de retenes completo		R273000
55267937	Jgo. retén válvulas (8)	V	1 R273010V
55267742	Retén de bancada 80 x 96 x 9	V	1 R520811V
7091279	Retén distribución 34 x 47 x 5.5	V	1 R272912V

**FIAT**



Motor/Engine	Cm³	HP	Ø
E.torq Evo (SOHC) 16V	1598	110	77

Fiat: Tipo 2017/...



Nº OE	Descripción/Description	Mat.	Ref.
	Jgo. de juntas para motor		● 273500-R MLS
	Jgo. de juntas superior (MLS)	●	273595 MLS
	Jta. tapa cilindros Ø 78.0 $\pm$ 1.20	NFT	272607
552637320	Jta. tapa cilindros Ø 78.0 $\pm$ 0.60	MLS	1 1 272608
55223509	Jgo. tornillos tapa cilindros (HAS15038)		B272000
55247838	Conj. junta tapa de válvulas (5)	GS	1 1 273510
55226126	Guarnición entre cárter y basamiento	NFT	1 272011
55224457	Múltiple escape	AC	1 1 272015
7087745	Jgo. múltiple admisión (5)	S	1 1 272017
55227126	Guarnición frente motor bomba aceite	P	272027
55245355	Retén capuchón bujías	P	4 4 273530
7087746	Guarnición cuerpo mariposa	P	1 1 272032
46824135	Guarnición sensor temperatura	GS	1 1 270533
	Colector admisión	SLS	1 1 272033
7087876	Guarnición entrada aceite a bba G 27 x 32.5 x 4.5	P	1 272034
7087877	Guarnición salida aceite a bba G 22.5 x 27.5 x 5.5	P	1 272035
55231652	Guarnición base filtro aceite	GS	272037
55229989	O´ring G 12.37 x 2.62	GS	
55229787	O´ring G 20.30 x 2.62	GS	
	O´ring inyector G 10 x 2	GS	4
	Kit de retenes completo		R272000
55223481	Jgo. retén válvulas (16)	P	1 R272010P
55223567	Retén bancada trasera 91 x 111 x 10	V	1 R330511V
	Retén distribución 32 x 45 x 6.5	P	1 R230412P
55224542	Retén árbol de levas 40 x 55 x 7	V	1 R270713V

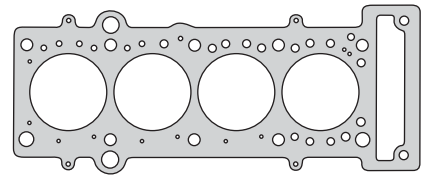

272608

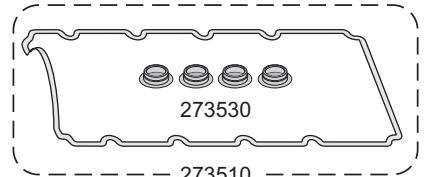

273530

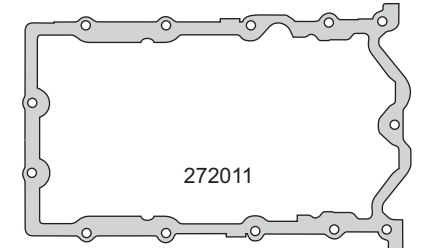

272011

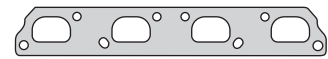

272015



272033

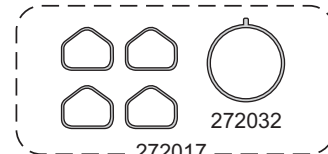

272032

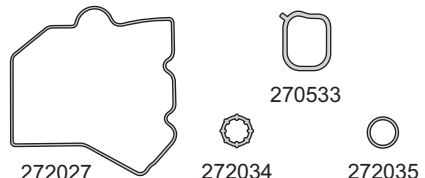

272027

270533

272034

272035



272037

G 12.37 x 2.62

G 20.30 x 2.62



G 10 x 2

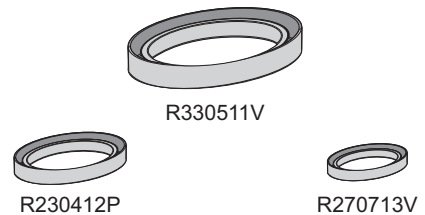

R330511V

R230412P

R270713V



R272010P



**FIAT**



Motor/Engine	Cm³	HP	Ø
Fire	1242	70	72
Fire Evo (SOHC) 8V	1368	80	72

Fiat: Mobi 1.3 BZ 2016/...  
Fiorino 1.4 XMF 2016/18



N° OE	Descripción/Description	Mat.	Ref.
7087532	Jgo. de juntas para motor		● 273600-R MLS
	Jgo. de juntas superior (MLS)	●	273695 MLS
	Jgo. de juntas superior		273695
	Jta. tapa cilindros Ø 73.0 ± 1.20	NFT	271205
	Jta. tapa cilindros Ø 73.0 ± 1.20 NR	NFT	271207
55190882	Jta. tapa cilindros Ø 72.5 ± 0.40 NR	MLS	1 1 271208
7696197	Jgo. tornillos tapa cilindros (HAS13038)		B270500
55247076	Conj. junta tapa válvulas (5)	GS	1 1 273610
46745223/1	Junta para cárter	CG	1 270711
7084019	Tapa distribución	NB	1 270712
	Bomba de agua	NH	251014
55194291	Jgo. múltiple escape (2)	AC	1 1 271915
7088383/350	Jgo. múltiple admisión (4)	GS	1 1 272217
7604488	Base termostato	NB	1 1 270519
14463580	O´ring bomba de agua a block G 29.74 x 3.53	GS	1 271219
	Anillo tapa válvulas	GS	4 4 271930
46824135	Conexión sensor temperatura	GS	1 1 270533
7082509	O´ring de válvula G 28.17 x 3.53	GS	1
	O´ring de válvula G 7.52 x 3.53	GS	1
	O´ring G 30.8 x 3.7	GS	1 1
	Kit de retenes completo		R271900
55190344	Jgo. retén válvulas (8)	V	1 R271210V
5210858	Porta retén bancada trasera	VF	PR271911VF
55206525	Retén árbol de levas 40 x 55 x 7	V	1 R270713V
46404094	Retén bomba de aceite 27 x 37 x 7	V	1 R270515V

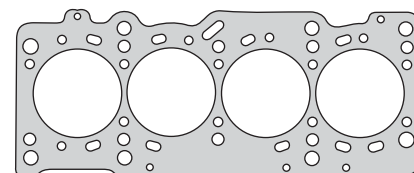

271208

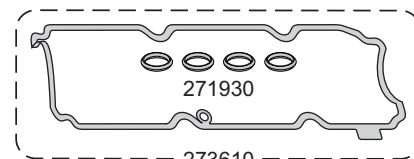

271930



273610

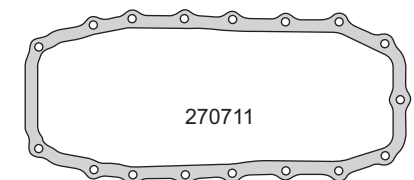

270711

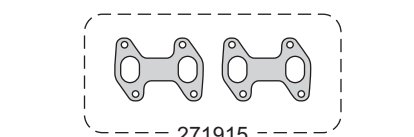

271915

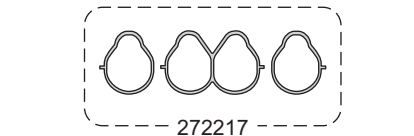

272217

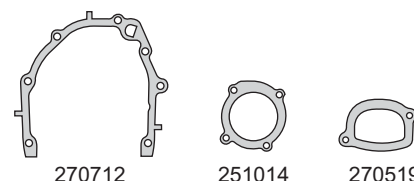

270712

251014

270519

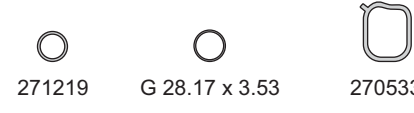

271219

G 28.17 x 3.53

270533



G 7.52 x 3.53

G 30.8 x 3.7

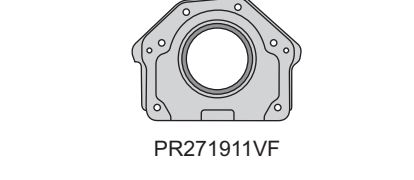

PR271911VF



R270713V

R270515V



R271210V

**FIAT**



Motor/Engine	Cm³	HP	Ø
E.torq Evo (SOHC) 16V	1598 1747	110 130	80.5 80.5

Fiat: Argo, Cronos 2017/...  
Jeep: Renegade 2017/...



Nº OE	Descripción/Description	Mat.	Ref.
	Jgo. de juntas para motor		● 273700-R MLS
	Jgo. de juntas superior (MLS)	●	273795 MLS
	Jta. tapa cilindros Ø 82.5 $\pm$ 1.40	NFT	272705
	Jta. tapa cilindros Ø 82.5 $\pm$ 1.20	NFT	272707
552628740	Jta. tapa cilindros Ø 82.5 $\pm$ 0.60	MLS	1 1 272708
55223509	Jgo. tornillos tapa cilindros (HAS15038)		B272000
55247838	Conj. junta tapa de válvulas (5)	GS	1 1 273510
55226126	Guarnición entre cárter y basamiento	NFT	1 272011
55224457	Múltiple escape	AC	1 1 272015
7087745	Jgo. múltiple admisión (5)	S	1 1 272017
55227126	Guarnición frente motor bomba aceite	P	272027
55245355	Retén capuchón bujías	P	4 4 273530
7087746	Guarnición cuerpo mariposa	P	1 1 272032
46824135	Guarnición sensor temperatura	GS	1 1 270533
	Colector admisión	SLS	1 1 272033
7087876	Guarnición entrada aceite a bba G 27 x 32.5 x 4.5	P	1 272034
7087877	Guarnición salida aceite a bba G 22.5 x 27.5 x 5.5	P	1 272035
55231652	Guarnición base filtro aceite	GS	272037
55229989	O´ring G 12.37 x 2.62	GS	
55229787	O´ring G 20.30 x 2.62	GS	
	O´ring inyector G 10 x 2	GS	4
	Kit de retenes completo		R272000
55223481	Jgo. retén válvulas (16)	P	1 R272010P
55223567	Retén bancada trasera 91 x 111 x 10	V	1 R330511V
	Retén distribución 32 x 45 x 6.5	P	1 R230412P
55224542	Retén árbol de levas 40 x 55 x 7	V	1 R270713V

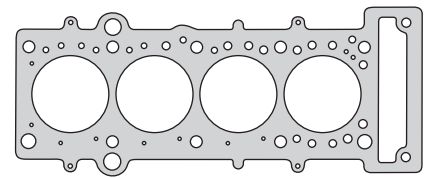

272708

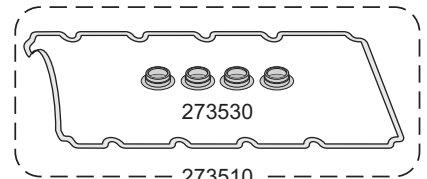

273530

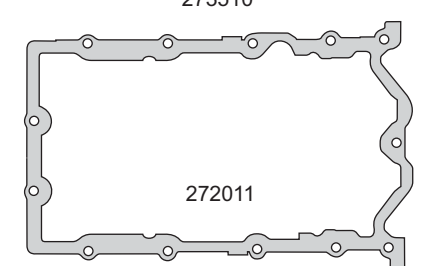

273510

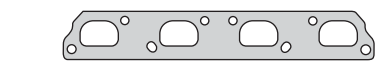

272015



272033

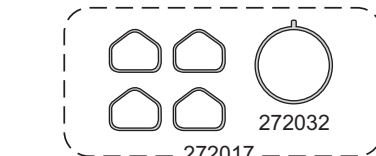

272032

272017

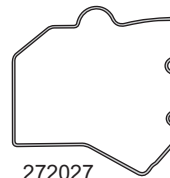

272027



270533



272034

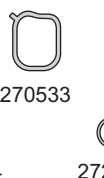

272035

G 12.37 x 2.62

G 20.30 x 2.62

272037

G 10 x 2



R330511V



R230412P



R270713V



R272010P







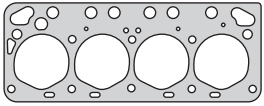
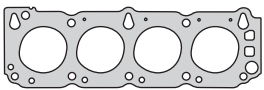
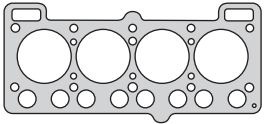
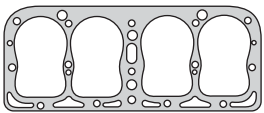
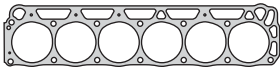
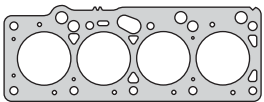
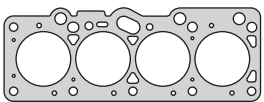
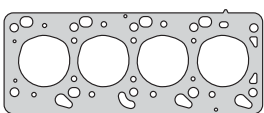
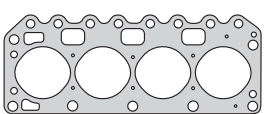
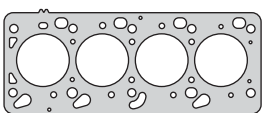



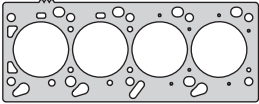

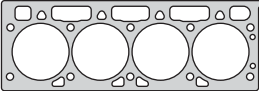

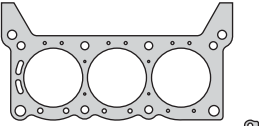

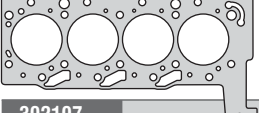

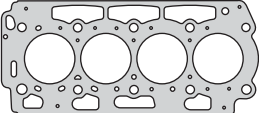

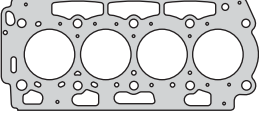
**MOTORES NAFTA Y DIESEL / PETROL AND DIESEL ENGINES**

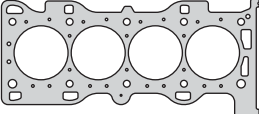
	<b>Código Code</b>	<b>Q</b>	<b>≠</b>	<b>Kit Bulón Bolt Set</b>	<b>Aplicación Application</b>	<b>Motor Engine</b>	<b>Juego</b>
	<b>220605 - 220607</b> 220605 220607	82.2 82.2	1.70 1.70	<b>B220400</b> HAN12055 HAN12100	Del Rey, Belina 1989/91, Escort, Scala Pampa 1989/..., Verona 1990/96, Royale Versailles 1991/96	<b>1781cc.</b> AP 85/87HP Ø81 (SOHC) 8V	<b>220600-R</b> pág. 534
	<b>223507 - 223508</b> 223507-1M 223507-2M 223507-3M 223508-1M 223508-2M 223508-3M	81.0 81.0 81.0 80.5 80.5 80.5	1.50 1.60 1.70 1.48 1.58 1.68	<b>B223500</b> HAN12055 HAN12100	Galaxy TDI 2000/... <b>DIESEL</b>	<b>1896cc.</b> AUY 115HP Ø79,5 (SOHC) 8V	<b>223501-R</b> pág. 554
	<b>230005 - 230007</b> 230005 230007	83.5 83.5	1.70 1.70	<b>B220400</b> HAN12055 HAN12100	Galaxy, Versailles, Verona, Escort 1992/96	<b>1984cc.</b> Audi 827 107/115HP Ø82.5 (SOHC) 8V	<b>230000-R</b> pág. 560
	<b>230707</b> 230707	83.0	1.60	<b>B230700</b> HAN12055 HAN12100	Galaxy 1995/00	<b>2792cc.</b> AAA/AMY 174HP Ø81 (DOHC) V6 12V	<b>230700-R</b> pág. 566
	<b>230907</b> 230907-1M 230907-2M 230907-3M 230908-1M 230908-2M 230908-3M	81.5 81.5 81.5 81.0 81.0 81.0	1.40 1.50 1.60 1.45 1.53 1.61	<b>B230100</b> HAN12055 HAN12100	Galaxy TDI 1995/... - 1997/... <b>DIESEL</b>	<b>1896cc.</b> VW19N (1Z/AHU) 90HP VW19P (AFN) 110HP Ø79.5 (SOHC) 8V	<b>230901-R</b> pág. 567
	<b>252508</b> 252508	70.5	0.70	<b>B252500</b> HAR10168	Ka TDCI 2008/... <b>DIESEL</b>	<b>1248cc.</b> FD4 75HP Ø69.6 (DOHC) 16V	
	<b>300005 - 300006 - 300007</b> 300005 300006 300007	96.7 96.7 96.7	1.40 2.40 1.40	<b>B300000</b>	Falcon, F100, Fairlane 1969/...  Falcon SP, Sprint 1973/...	<b>3052cc.</b> 187 7B 108HP Ø90.62 <b>3075cc.</b> 188 7B 108HP Ø93.47 <b>3618cc.</b> 221 7B 108HP Ø93.47  <b>3618cc.</b> 221 Sprint 7B 132HP Ø93.47	<b>300000-R</b> pág. 241  <b>300100-R</b> pág. 242
	<b>300205</b> 300205	97.0	1.40		F100, F350, F600, Fairlane 1961/70	<b>4458cc.</b> 272 V8 FI 170HP Ø92 <b>4785cc.</b> 292 V8 FI 170HP Ø95.25	<b>300200-R</b> pág. 243
	<b>300305</b> 300305	91.1	1.40	<b>B300300</b> HAD19038	Taurus L, GXL, Ghia 1974/...	<b>1990cc.</b> OHC 63HP Ø90.8 (SOHC) 8V	<b>300300-R</b> pág. 244
	<b>300405 - 300407</b> 300405 300407	98.0 98.0	1.40 1.40	<b>B300300</b> HAD19038	Taurus, Sierra, XR4, Falcon 1974/... GXL/GT, SP/Ghia, Maverick 1975/79 Mustang 1980/...  Ranger, Pinto, Taurus, Sierra, Capri Granada 1974/86	<b>2299cc.</b> OHC 100/114HP Ø96  <b>1993cc.</b> L4 122 72HP Ø96 <b>2302cc.</b> L4 140 86HP Ø96 (SOHC) 8V	<b>300400-R</b> pág. 245  <b>303600-R</b> pág. 274

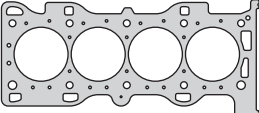

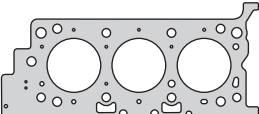

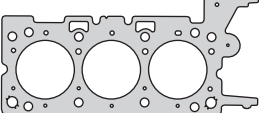

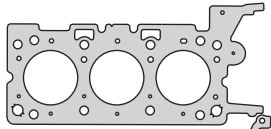
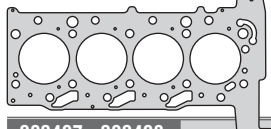

**MOTORES NAFTA Y DIESEL / PETROL AND DIESEL ENGINES**

	<b>Código Code</b>	<b>Q</b>	<b>≠</b>	<b>Kit Bulón Bolt Set</b>	<b>Aplicación Application</b>	<b>Motor Engine</b>	<b>Juego</b>
	<b>300505</b>	<b>98.0</b>	<b>1.40</b>		F100/350/600, Fairlane 1/8, LTD 500 Fase II 1969/76	<b>4785cc.</b> V8 FII 180HP Ø95.25	<b>300500-R</b> 🚗 pág. 246
	<b>300605</b>	<b>83.5</b>	<b>1.40</b>	<b>B300600</b> 🔩 HAT55055 HAT55100	Sierra 1.6L 1984/...	<b>1597cc.</b> OHC 75HP Ø81.3	<b>300600-R</b> 🚗 pág. 247
	<b>300705</b> <b>300707</b>	<b>78.0</b> <b>78.0</b>	<b>1.40</b> <b>1.40</b>	<b>B300700</b> 🔩 HAS17038	Escort, Saveiro, Gol, Corcel II Del Rey, Scala, Pampa 1983/... Belina, Verona 1989/...	<b>1555cc.</b> CHT/AE 73HP Ø77 (SOHC) 8V	<b>300700-R</b> 🚗 pág. 248
	<b>300805</b>	<b>100.5</b>	<b>1.65</b>		A, AA 1928/31	<b>2100cc.</b> 24HP Ø98.4	<b>300800</b> 🚗 pág. 249
	<b>300905</b>	<b>94.0</b>	<b>1.40</b>	<b>B300000</b>	Falcon 4B, STD, De Luxe, Futura Rural 1962/68	<b>2780cc.</b> 170 4B 84HP Ø88.9 <b>3052cc.</b> 187 4B 96HP Ø90.42	<b>300900-R</b> 🚗 pág. 250
	<b>301007</b>	<b>80.0</b>	<b>1.70</b>	<b>B301000</b> 🔩 HAS13038	Escort 1986/98, Orion 1986/94	<b>1392cc.</b> HL14G/CFI/EFI 73/75HP Ø77.2 (OHV) 8V	<b>301000-R</b> 🚗 pág. 251
	<b>301107</b>	<b>83.0</b>	<b>1.70</b>	<b>B301000</b> 🔩 HAS13038	Fiesta i, Orion i 1989/92, Escort Escort XR3 1980/85, Fiesta XR2 1984/85 Escort, Orion, Escort XR3i 1985/90	<b>1597cc.</b> CHV (HL16CFI) 90HP CVH (H16G/MFI/H) 79HP CVH (HL16I) 105HP CVH (HL16G/H) 79/96HP Ø80 (OHV) 8V	<b>301100-R</b> 🚗 pág. 252
	<b>301207</b>	<b>77.5</b>	<b>1.60</b>	<b>B320300</b> 🔩 HAT55055 HAT55100	Mondeo 1993/...  Escort, Orion 1992/..., Fiesta 1994/95	<b>1597cc.</b> ZETEC 16V 90HP Ø76  <b>1597cc.</b> ZETEC 16V 90HP Ø76	<b>301200-R</b> 🚗 pág. 253  <b>301400-R</b> 🚗 pág. 254
	<b>301307</b>	<b>77.0</b>	<b>1.20</b>		Fiesta 1976/88  Fiesta 1976/88, Escort 1982/88  Combi Van, Escort 1986/88	<b>957cc.</b> OHV (HCS) 40/45HP Ø73.96 <b>1118cc.</b> OHV (HCS) 53/55HP Ø73.96 <b>1297cc.</b> OHV (BL13H) 60HP Ø73.96	
	<b>301507</b> <b>301508</b>	<b>81.7</b> <b>81.5</b>	<b>1.20</b> <b>1.20</b>	<b>B320300</b> 🔩 HAT55055 HAT55100	Focus 1998/...  Focus 1998/04, Transit 2002/...	<b>1796cc.</b> ZETEC E 116HP Ø80.6 (DOHC) 16V  <b>1796cc.</b> ZETEC-E SFI 116HP Ø80.6 (DOHC) 16V	<b>301500-R</b> 🚗 pág. 255  <b>303300-R</b> 🚗 pág. 271

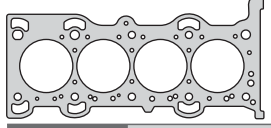

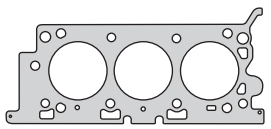
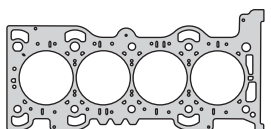
**MOTORES NAFTA Y DIESEL / PETROL AND DIESEL ENGINES**

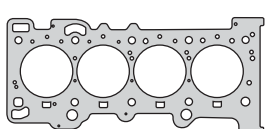
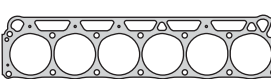
	<b>Código Code</b>	<b>Q</b>	<b>≠</b>	<b>Kit Bulón Bolt Set</b>	<b>Aplicación Application</b>	<b>Motor Engine</b>	<b>Juego</b>
<b>301607 - 301608</b> 	301607 301608	87.0 86.0	1.20 0.65	<b>B320300</b>  HAT55055 HAT55100	Focus 1999/02, Maverich 2000/... Cougar 1999/...	<b>1989cc.</b> YF - EDDBA - EDBB - EDBC EDBD 124/131HP Ø84.8 (DOHC) 16V	<b>302900-R</b>  pág. 267
<b>301705</b> 	301705	96.2	1.20		Ghia 1991/..., Topaz 1989/94  Topaz, GS/GLX 1984/88	<b>2300cc.</b> 140 F.I  <b>2300cc.</b> 140 Carburado	<b>301700-R</b>  pág. 256 <b>301800-R</b>  pág. 257
<b>301905 - 301907</b> 	301905 301907	99.0 99.0	1.20 1.20		V6 3.8 (USA) Mustang, Taurus Sable, Thunderbird, Cougar 1985/87	<b>3811cc.</b> 232 V6 130HP Ø96.8 (OHV) 12V	<b>301900-R</b>  pág. 258
<b>302007 - 302008</b> 	302007-1M 302007-2M 302007-3M 302008-1M 302008-2M 302008-3M	91.0 91.0 91.0 91.0 91.0 91.0	1.10 1.15 1.20 1.10 1.15 1.20	<b>B302000</b>  HAS13038 HAS17038	Transit TD 2000/...  <b>DIESEL</b>	<b>2402cc.</b> Duratorq 120/125HP Ø89.9 (DOHC) 16V	<b>302001-R</b>  pág. 259
<b>302107</b> 	302107-1M 302107-2M 302107-3M 302107-4M 302107-5M	76.0 76.0 76.0 76.0 76.0	1.20 1.30 1.40 1.45 1.50	<b>B302100</b>  HAE14038	Fiesta, Eco Sport TD 2003/... Duratorq TDCI  <b>DIESEL</b>	<b>1398cc.</b> F6JA - F6JB 68HP Ø74 (SOHC) 8V	<b>302101-R</b>  pág. 260
<b>302108</b> 	302108-1M 302108-2M 302108-3M 302108-4M 302108-5M	75.0 75.0 75.0 75.0 75.0	1.25 1.30 1.35 1.40 1.45	<b>B302100</b>  HAE14038	Fiesta, Eco Sport TD 2003/... Duratorq TDCI  <b>DIESEL</b>	<b>1398cc.</b> F6JA - F6JB 68HP Ø74 (SOHC) 8V	<b>302101-R</b>  pág. 260
<b>302207 - 302208</b> 	302207 302208	89.0 89.0	1.20 0.40	<b>B302200</b>  HAT55055 HAT55100	Mondeo 2001/..., Eco Sport 2003/... Ranger 2001/..., Focus, Focus EXE	<b>1999cc.</b> Duratec HE/EFI 145HP CJBA 143HP Ø87.5	<b>302200-R</b>  pág. 261
<b>302207 - 302208</b> 	302207 302208	89.0 89.0	1.20 0.40	<b>B302200</b>  HAT55055 HAT55100	Mondeo 2001/..., Eco Sport 2003/..., Ranger 2001/..., Focus, Focus EXE Maverick 2003/...	<b>1999cc.</b> Duratec HE/EFI 145HP CJBA 143HP Ø87.5 <b>2261cc.</b> 154HP Ø87.5	<b>302400-R</b>  pág. 263
<b>302507 - 302508</b> 	302507 302508	84.0 83.0	1.60 0.85	<b>B302500</b>  HAS13038	Mystique, Contour 1995/00 Mondeo 1994/00, Mondeo III 2000/...	<b>2495cc.</b> Duratec - LCBD 170HP Ø81.6 V6 24V (DOHC)	<b>302500-R</b>  pág. 264
<b>303008</b> 	303008	83.5	0.85	<b>B302500</b>  HAS13038	Mondeo II 1994/00	<b>2544cc.</b> M41D (174T1) 90HP Ø80	<b>303000-R</b>  pág. 268

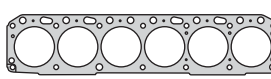
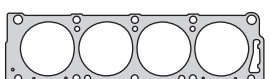
**MOTORES NAFTA Y DIESEL / PETROL AND DIESEL ENGINES**

	<b>Código Code</b>	<b>Q</b>	<b>≠</b>	<b>Kit Bulón Bolt Set</b>	<b>Aplicación Application</b>	<b>Motor Engine</b>	<b>Juego</b>
	<b>303108</b>	<b>91.5</b>	<b>0.85</b>	<b>B302500</b>	Mondeo V6, ST 2.20 2003/...	<b>2967cc.</b> Duratec - MEBA 226HP Ø89 (DOHC) V6 24V	<b>303100-R</b> 🚗 pág. 269
	<b>303207-1M</b> <b>303207-2M</b> <b>303207-3M</b> <b>303208-1M</b> <b>303208-2M</b> <b>303208-3M</b>	<b>87.0</b> <b>87.0</b> <b>87.0</b> <b>87.0</b> <b>87.0</b> <b>87.0</b>	<b>1.10</b> <b>1.15</b> <b>1.20</b> <b>1.10</b> <b>1.15</b> <b>1.20</b>	<b>B302000</b>  HAS13038 HAS17038	Mondeo TDCI 2000/02 - 2002/... Mondeo III DI 2002/02 Transit TDI-TDCI 2000/02 - 2002/... Transit DI 2000/02 <b>DIESEL</b>	1998cc. HJBA/B/C 85HP - F3FA 85HP F1FA 125HP - ABFA 100HP D3FA 75HP - D5BA 90HP D6BA 115HP (DOHC) Duratorq Ø86	<b>303201-R</b> 🚗 pág. 270
	<b>303407</b> <b>303408</b>	<b>90.0</b> <b>89.5</b>	<b>1.20</b> <b>0.50</b>	<b>B302200</b>  HAT55055 HAT55100	Focus 2011..., Mondeo 2013/...	<b>1999cc.</b> MGDA Duratec 170HP Ø87.5 (DOHC) 16V	<b>303400-R MLS</b> 🚗 pág. 272
	<b>303508</b>	<b>83.0</b>	<b>0.80</b>		Mondeo III 2002/...	<b>2495cc.</b> AJ25 - LD8E 170HP Ø81,6 (DOHC) V6 24V	<b>303500-R</b> 🚗 pág. 273
	<b>303807</b> <b>303808</b>	<b>90.0</b> <b>91.0</b>	<b>1.40</b> <b>0.60</b>	<b>B302200</b>  HAT55055 HAT55100	Ranger 2011/...	<b>2495cc.</b> GBVAF/GBVAL/GBVAK 166HP Ø89 (DOHC) 16V	<b>303800-R MLS</b> 🚗 pág. 275
	<b>303907</b>	<b>89.0</b>	<b>0.90</b>		Fusión 2016/..., Bronco 2021/... Maverick 2022/...	<b>1999cc.</b> Ecoboost 16V 248HP Ø87.5	<b>303900-R</b> 🚗 pág. 276
	<b>310005</b> <b>310007</b>	<b>96.7</b> <b>96.7</b>	<b>1.40</b> <b>1.40</b>	<b>B300000</b>	Falcon, Pick Up 1989/...	<b>3618cc.</b> Max Econo 106HP Ø93.47	<b>310000-R</b> 🚗 pág. 277
	<b>310105</b>	<b>104.0</b>	<b>1.40</b>		Ranger 1989/..., Galaxy Maverick 1976/83  Galaxy 500, Fairlane, Falcon, Maverick Mustang, Grand Marquis F150/F250 1965/84	<b>4942cc.</b> F302 V8 Ø101.6  <b>4300cc.</b> 260 V8 16V Ø96 <b>4800cc.</b> 289 V8 16V Ø96 <b>5000cc.</b> 302 V8 16V Ø96	<b>310100</b> 🚗 pág. 278  <b>321800-R</b> 🚗 pág. 304
	<b>310205</b>	<b>107.0</b>	<b>1.70</b>		Econoline, Delivery 1980/... Bronco 1980/92	<b>4917cc.</b> 300 CID 145HP Ø101.09 (OHV) 12V	<b>310200-R</b> 🚗 pág. 279
	<b>310307</b>	<b>109.0</b>	<b>1.20</b>		Fairlane 500, Galaxy 500, Monterey Thunderbird, Mustang 1960/71	<b>5400cc.</b> 390 CID V8 Ø102	<b>310300</b> 🚗 pág. 280

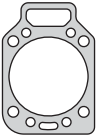
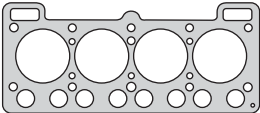
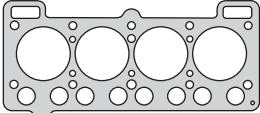
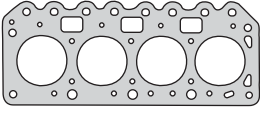
**MOTORES NAFTA Y DIESEL / PETROL AND DIESEL ENGINES**

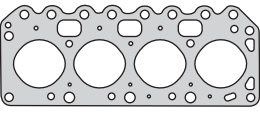
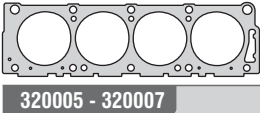
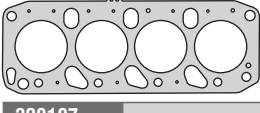
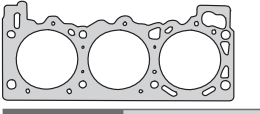
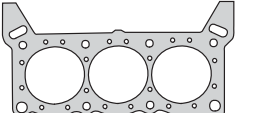



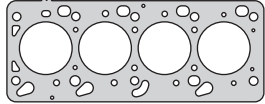
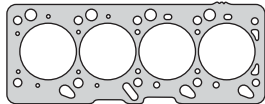
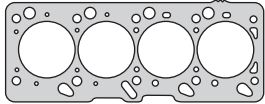
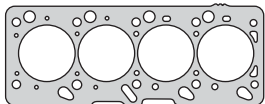
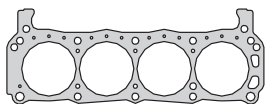
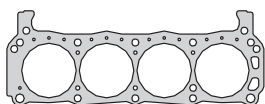
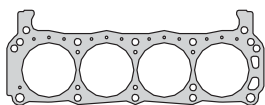
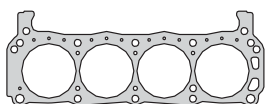
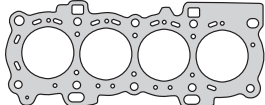
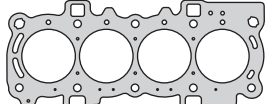





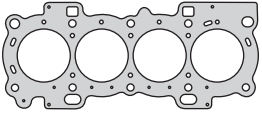

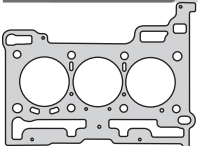

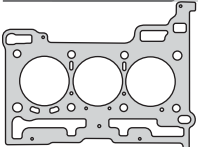

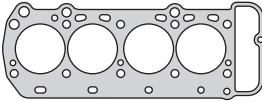

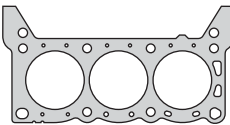
	<b>Código Code</b>	<b>Q</b>	<b>≠</b>	<b>Kit Bulón Bolt Set</b>	<b>Aplicación Application</b>	<b>Motor Engine</b>	<b>Juego</b>
	<b>310407</b> 310407	<b>110.0</b>	<b>1.45</b>	<b>B310400</b> HAS17038	F100 1993/95, F1000 1994/96 F4000 1992/93, F2000 1980/... FB4000 1985/...	<b>3922cc.</b> D229-4 96HP Ø102	<b>310400-R</b> 🚗 pág. 368
	<b>310605</b> 310605	<b>78.0</b>	<b>1.40</b>	<b>B300700</b> HAS17038	Corcel II 1979/83, Belina II Pampa 1982/83, Del Rey 1981/83 Scala 1983/...  Corcel 1971/77, Corcel II 1978/83 Belina, Coupe GT 1.4 BR	<b>1555cc.</b> CHT 73HP Ø77  <b>1300cc.</b> CHT 73HP Ø77 <b>1400cc.</b> CHT Ø77	<b>310600-R</b> 🚗 pág. 281  <b>320600-R</b> 🚗 pág. 293
	<b>310705</b> 310705	<b>73.0</b>	<b>1.40</b>	<b>B300700</b> HAS17038	Escort Hobby 1.0 1993/...  Escort 1.3 1983/...	<b>997cc.</b> CHT/AE Ø70.3 <b>1300cc.</b> CHT/AE Ø71.5	<b>310700-R</b> 🚗 pág. 282
	<b>310805 - 310807</b> 310805 310807	<b>76.0</b> <b>76.0</b>	<b>1.40</b> <b>1.40</b>	<b>B310800</b> HAS14038	Fiesta 1988/95, Courier 1991/... (cárter de aluminio)  Fiesta, Ka (cárter de acero) Escort, Fiesta, Courier, Ka (cárter de aluminio) 1995/...	<b>1297cc.</b> OHV (HCS) Endura 60HP Ø73.96 <b>1299cc.</b> OHV (HCS) Endura 50/60HP Ø73.96	<b>310800-R</b> 🚗 pág. 283
	<b>310907</b> 310907	<b>95.0</b>	<b>1.40</b>	<b>B310900</b> HAT55055 HAT55100	Ford V6 (USA) Ranger, Bronco II 1988/92 Sierra V6 B4A/B/C 1989/93 Granada BRC 1986/93	<b>2933cc.</b> 177/BRC V6 150HP Ø93	<b>310900-R</b> 🚗 pág. 284
	<b>311005 - 311007</b> 311005 311007	<b>70.5</b> <b>70.5</b>	<b>1.30</b> <b>1.30</b>	<b>B310800</b> HAS14038	Ka 1997/99, Fiesta 1996/99 53HP Fiesta 1988/95 45HP	<b>999cc.</b> OHV (HCS) Endura 45/53HP Ø68.7	<b>311000-R</b> 🚗 pág. 285
	<b>311105</b> 311105	<b>109.0</b>	<b>1.20</b>		Galaxie, Mustang, Torino 1964/78 Camión 1964/78 Camión 1964/78  V8 1964/72	<b>5400cc.</b> 330 V8 <b>5900cc.</b> 351 V8 <b>6400cc.</b> 391 V8  <b>5400cc.</b> 350 V8	<b>311100-R</b> 🚗 pág. 286  <b>311200-R</b> 🚗 pág. 287
	<b>320005 - 320007</b> 320005-2M 320005-3M 320005-4M 320007-2M 320007-3M 320007-4M	<b>84.0</b> <b>84.0</b> <b>84.0</b> <b>84.0</b> <b>84.0</b> <b>84.0</b>	<b>1.45</b> <b>1.50</b> <b>1.55</b> <b>1.40</b> <b>1.45</b> <b>1.50</b>	<b>B320000</b> HAT70100	Courier D, Fiesta D, Orion D, Pick Up TD Sierra TD, Escort TD, Orion TD Mondeo TD 1992/94	<b>1753cc.</b> D1.8T/TI 75/90HP D18NA 60HP Ø82.5	<b>320001-R</b> 🚗 pág. 288
	<b>320107</b> 320107	<b>103.5</b>	<b>1.40</b>	<b>B310900</b> HAT55055 HAT55100	Explorer, Ranger, Navajo 1991/... Bronco II 1990/91	<b>3996cc.</b> 244 CID 147/165HP Ø100.4 (SOHC) V6 12V	<b>320100-R</b> 🚗 pág. 289
	<b>320207</b> 320207	<b>99.7</b>	<b>1.40</b>		V6 3.8 (USA) Mustang , Taurus, Sable Thunderbird, Cougar  Windstar 1995/96	<b>3811cc.</b> 230 (232) V6 130HP Ø96.8  <b>3797cc.</b> 232 V6 130HP Ø96.8	<b>320200</b> 🚗 pág. 290  <b>323200-R</b> 🚗 pág. 316

**MOTORES NAFTA Y DIESEL / PETROL AND DIESEL ENGINES**

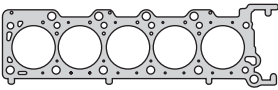
	<b>Código Code</b>	<b>Q</b>	<b>≠</b>	<b>Kit Bulón Bolt Set</b>	<b>Aplicación Application</b>	<b>Motor Engine</b>	<b>Juego</b>
	<b>320305 - 320307</b> 320305 320307	81.7 81.7	1.60 1.60	<b>B320300</b> HAT55055 HAT55100	Escort, Fiesta, Orion, Fiesta XR2 Escort RX3i 1992/... Mondeo 1993/...	<b>1796cc.</b> ZETEC 16V 105/115HP Ø80.6  <b>1796cc.</b> ZETEC 115HP Ø80.6 (DOHC) 16V	<b>320300-R</b> 🚗 pág. 291  <b>321300-R</b> 🚗 pág. 299
	<b>320507</b> 320507	87.0	1.70	<b>B320300</b> HAT55055 HAT55100	Escort Mondeo 1993/01	<b>1989cc.</b> ZETEC 16V 136HP Ø84.8  <b>1989cc.</b> ZETEC 136HP Ø84.8 (DOHC) 16V	<b>320500-R</b> 🚗 pág. 292  <b>321500-R</b> 🚗 pág. 301
	<b>320507</b> 320507	87.0	1.70	<b>B320300</b> HAT55055 HAT55100	Contour 1994/...	<b>1989cc.</b> ZETEC 16V 126HP Ø83	<b>340800-R</b> 🚗 pág. 339
	<b>320507</b> 320507	87.0	1.70	<b>B320300</b> HAT55055 HAT55100	Contour 1996/98, Mystique 1994/95 Escort ZX2 1998/...	<b>1998cc.</b> 4L 121 P.C.D. VIN "3" ZETEC 138HP Ø84,8 (DOHC) 16V	<b>324300-R</b> 🚗 pág. 322
	<b>320705 - 320707</b> 320705 320707	104.5 103.5	1.20 1.20		Cougar, Continental, Granada Fairmont, Thunderbird	<b>5000cc.</b> F302 V8 Ø101.6	<b>320700</b> 🚗 pág. 294
	<b>320705 - 320707</b> 320705 320707	104.5 103.5	1.20 1.20		F100/F250/F350, Mustang, Thunderbird, Bronco 1983/96 F100/F250/F350, Bronco 1985/95	<b>5000cc.</b> F302L V8 Ø101.6  <b>5800cc.</b> F351WL V8 Ø101.6	<b>321000</b> 🚗 pág. 296  <b>321100</b> 🚗 pág. 297
	<b>320705 - 320707</b> 320705 320707	104.5 103.5	1.20 1.20		F250/F350, Mustang Cougar, Thunderbird, F200/F350 1991/95	<b>5000cc.</b> F351W V8 Ø101.6  <b>5000cc.</b> 302 V8 Ø96	<b>321200-R</b> 🚗 pág. 298  <b>321900-R</b> 🚗 pág. 305
	<b>320705 - 320707</b> 320705 320707	104.5 103.5	1.20 1.20		F250/F350/F600, Microbus (Chasis) 1984/91 Grand Marquis, Galaxy, Camiónes Mustang, F250/F350/FB600 1969/84	<b>5500cc.</b> 335 V8 16V Ø101.6 <b>5752cc.</b> 351 V8 16V Ø101.6  <b>5000cc.</b> 351 V8 Ø101.6	<b>322000-R</b> 🚗 pág. 306  <b>322100-R</b> 🚗 pág. 307
	<b>320907 - 320908</b> 320907 320908	78.0 77.0	1.50 1.40	<b>B320900</b> HAT55055 HAT55100	Fiesta SE, Courier, Puma 1996/...	<b>1388cc.</b> Zetec SE 16V 90/75HP Ø76	<b>320900-R</b> 🚗 pág. 295
	<b>321408</b> 321408	77.0	0.30	<b>B320900</b> HAT55055 HAT55100	Fiesta VI 2008/... - B-Max 2012/... Fusion 2002/... - 2010/...	<b>1388cc.</b> FXJA/FXJB/FXJC 80HP RTJA/RTJB 92HP RTJC 86HP - SPJD 90HP SPJA/SPJC 97HP (DOHC) 16V Ø76	<b>321400-R MLS</b> 🚗 pág. 300

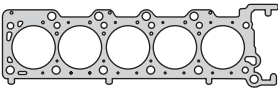

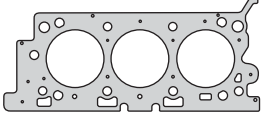
**MOTORES NAFTA Y DIESEL / PETROL AND DIESEL ENGINES**

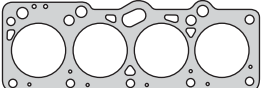
	<b>Código Code</b>	<b>Q</b>	<b>≠</b>	<b>Kit Bulón Bolt Set</b>	<b>Aplicación Application</b>	<b>Motor Engine</b>	<b>Juego</b>
	<b>321607 - 321608</b> 321607 321608	81.0 80.5	1.20 0.35	<b>B320900</b>  HAT55055 HAT55100	Ka 2016/... Fiesta, Fusión 2003/..., Focus 2004/... C-Max 2007/...	1499cc. Sigma 104HP Ø79 1596cc. L4 Sigma 100HP Ø79 HWDA/HWDB - FYJA 100HP (DOHC) 16V	<b>321600-R MLS</b>  pág. 302
	<b>321707 - 321708</b> 321707 321708	73.0 73.5	1.20 0.60	<b>B321700</b>	Ka 2016/...	<b>997cc.</b> Ti-VCT Eco Boost 85HP Ø71.9 (DOHC) 12V	<b>321700-R MLS</b>  pág. 303
	<b>321707 - 321708</b> 321707 321708	73.0 73.5	1.20 0.60	<b>B321700</b>	Fiesta 2016/...	<b>999cc.</b> Eco Boost 125HP Ø71.9 (DOHC) 12V	<b>325100-R MLS</b>  pág. 328
	<b>322205</b> 332205	82.0	1.20		Courier 1972/82 Courier 1972/82 Courier 1972/82	<b>1800cc.</b> 110 Ø78 <b>1900cc.</b> 121 Ø78 <b>2000cc.</b> 123 Ø78	<b>322200-R</b>  pág. 308
	<b>322307</b> 322307	99.0	1.30		Cougar Super Cargado Thunderbird 1988/93	<b>3797cc.</b> 232 V6 140/205HP Ø97	<b>322300-R</b>  pág. 309
	<b>322405</b> 322405	95.0	1.30		Bronco, Granada, Capri 1983/86	<b>2792cc.</b> 171 160HP Ø93 (OHV) V6 12V	<b>322400-R</b>  pág. 310
	<b>322708</b> 322708	92.0	0.88		Triton F-450 1997/99, Excursion, E-Series F-Series Super Duty	<b>6760cc.</b> Triton V10 310HP Ø90	<b>322700-R</b>  pág. 313
	<b>322708</b> 322708	92.0	0.88		F-450 2000/03, Excursion, E-Series F-Series Super Duty	<b>6760cc.</b> Triton V10 310HP Ø90	<b>322800-R</b>  pág. 314
	<b>322908</b> 322908	91.5	0.90	<b>B302500</b>  HAS13038	Maverick, Mondeo 2001/... Escape 2001/04	<b>2967cc.</b> Duratec RFF - MEBA 200HP Ø89 (DOHC) V6 24V	<b>322900-R</b>  pág. 315
	<b>323107</b> 323107	86.0	1.20		Escort 1997/01, Focus USA 2003/...	<b>1989cc.</b> 121 110HP Ø84.8 (SOHC) 8V	

**MOTORES NAFTA Y DIESEL / PETROL AND DIESEL ENGINES**

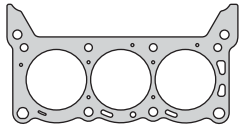
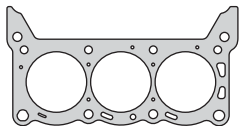
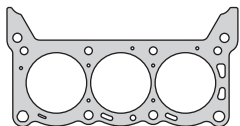
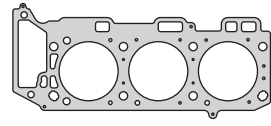
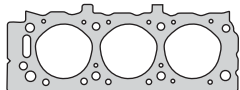
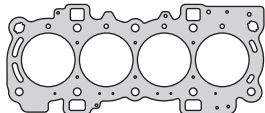
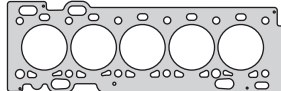
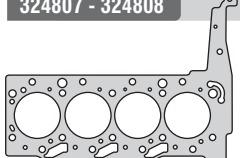
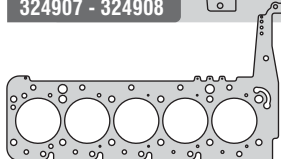
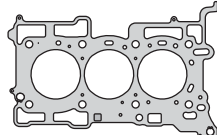
	<b>Código Code</b>	<b>Q</b>	<b>≠</b>	<b>Kit Bulón Bolt Set</b>	<b>Aplicación Application</b>	<b>Motor Engine</b>	<b>Juego</b>
	323307	100.0	1.20		Windstar 1997/98	<b>3797cc.</b> Essex (OHV) V6 155HP Ø96,8	<b>323300-R</b> 🚗 pág. 317
	323307	100.0	1.20		Windstar 1998/... Windstar 1999/00	<b>3797cc.</b> Essex (OHV) V6 145HP Ø96,8 <b>3797cc.</b> Essex (OHV) V6 200HP Ø96,8	<b>323900-R</b> 🚗 pág. 319 <b>324000-R</b> 🚗 pág. 320
	323307	100.0	1.20		Windstar 2001/03 Econoline, F150 1997/98	<b>3797cc.</b> Essex V6 200HP Ø96,8 <b>4195cc.</b> Essex V6 202HP Ø96,8	<b>324100-R</b> 🚗 pág. 321 <b>324400-R</b> 🚗 pág. 323
	323508	100.2	0.73		Explorer 4WD 1996/... Mustang 2004/10	<b>4009cc.</b> C40VSEX (OHV) V6 12V 162HP Ø100,4	
	323707	91.5	1.20		Ranger 1996/01	<b>2968cc.</b> Vulcan V6 147HP Ø89	<b>323700-R</b> 🚗 pág. 318
	324607-324608	81.0 80.5	1.20 0.35	<b>B320900</b> 🚗 HAT55055 HAT55100	Ka 2016/... Fiesta 2010, Focus 2013	<b>1499cc.</b> Sigma 104HP Ø79 <b>1596cc.</b> Sigma 115HP Ø79 (DOHC) 16V	<b>324600-R MLS</b> 🚗 pág. 324
	324707 - 324708	84.0 84.0	1.40 1.30		Focus, C-Max, S-Max, Mondeo Kuga 2005/... - 2007/...	<b>2522cc.</b> Duratec (25KDDTD) Duratec-VCT (25KDDTD) 220/226/300HP Ø83	<b>324700-R MLS</b> 🚗 pág. 325
	324807 - 324808	87.1 87.1 87.1 87.1 87.1 87.1	1.20 1.25 1.30 1.10 1.15 1.20	<b>B324800</b> 🚗 HAS13038 HAS17038	Ranger XL 4X2 / 4X4 Transit TDCi 2006/... <b>DIESEL</b>	<b>2198cc.</b> Puma TDCi 2.2L 125HP Ø86	<b>324801-R</b> 🚗 pág. 326
	324907 - 324908	91.0 91.0 91.0 91.0 91.0 91.0	1.20 1.25 1.30 1.10 1.15 1.20	<b>B324900</b> 🚗 HAS13038 HAS17038	Ranger XLS/XLT 4x2-4x4 TDCi 2013/... <b>DIESEL</b>	<b>3198cc.</b> Puma TDCi I5 eTGV 3.2L 200HP Ø90	<b>324901-R</b> 🚗 pág. 327
	325207 - 325208	87.0 87.0	1.20 0.50	<b>B325200</b>	Eco Sport, Fiesta 2016/...	<b>1497cc.</b> Dragon - Eco Boost 137HP Ø84 (DOHC) 12V	<b>325200-R MLS</b> 🚗 pág. 329



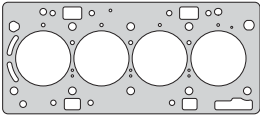
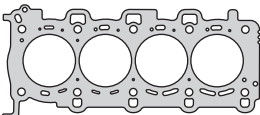
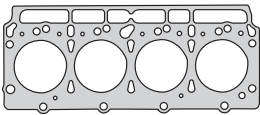
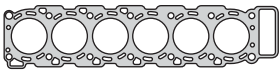
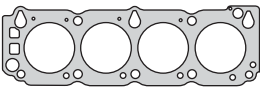
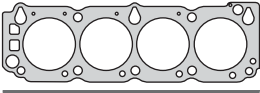
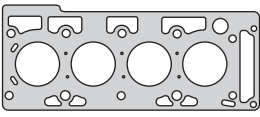
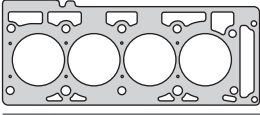
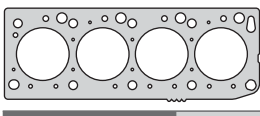
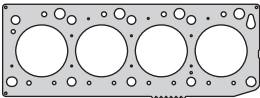



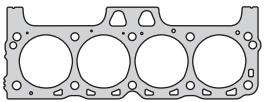
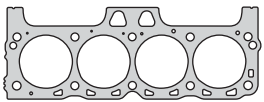
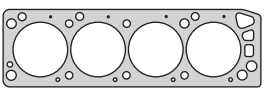
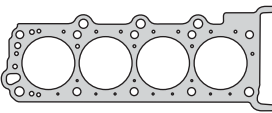
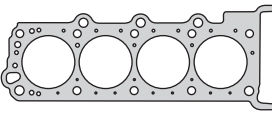
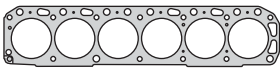
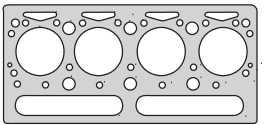
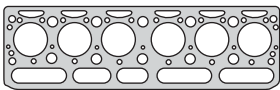
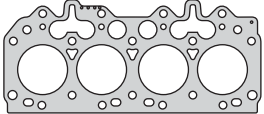
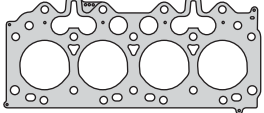



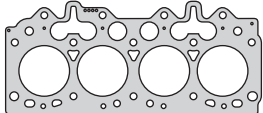

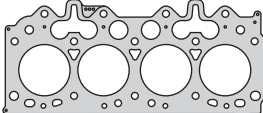

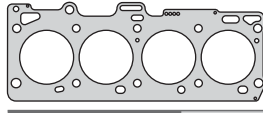

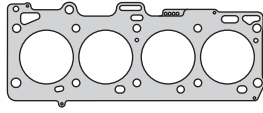

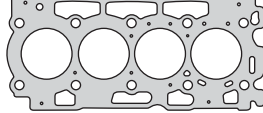

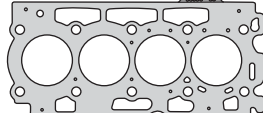
**MOTORES NAFTA Y DIESEL / PETROL AND DIESEL ENGINES**

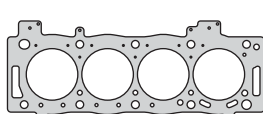
	<b>Código Code</b>	<b>Q</b>	<b>≠</b>	<b>Kit Bulón Bolt Set</b>	<b>Aplicación Application</b>	<b>Motor Engine</b>	<b>Juego</b>
	<b>325307</b> 325307	80.5	1.30		Kuga 2013/14, Mondeo 2011/15 C-Max, Grand C-Max 2010/19 Galaxy 2010/15, Focus 2010/14	<b>1596cc.</b> Eco Boost (DOHC) 16V 150HP Ø79	
	<b>325407 - 325408</b> 325407 325408	90.0 90.0	1.20 0.70	<b>B325400</b>	Transit, Transit D/DI 1985/99	<b>2496cc.</b> 4EB/BC/CA/FB 70/80HP 4HC/EA 100HP Ø93.64	<b>325400-R MLS</b> 🚗 pág. 330
	<b>330307</b> 330307 330307-1.20	96.0 96.0	1.40 1.20	<b>B330300</b> 🚗 HAS17038	Transit, Transit D/DI 1985/99	<b>2496cc.</b> 4EB/BC/CA/FB 70/80HP 4HC/EA 100HP Ø93.64	<b>330300-R</b> 🚗 pág. 331
	<b>330607</b> 330607 330607-1.70	96.0 96.0	1.40 1.70	<b>B330600</b> 🚗 HAS17038	F100 GMC Turbo 1999/...	<b>4200cc.</b> Sprint 6.07 TD 167HP Turbo Intercooler 198HP Ø93	<b>330600-R</b> 🚗 pág. 371
	<b>330905</b> 330905	90.0	1.40	<b>B300600</b> 🚗 HAT55055 HAT55100	Capri, Cortina, Sierra, Transit, Pick Up Granada 1973/...	<b>1593cc.</b> OHC TL16L/TL16H/TL16G 63/73/90HP Ø87.65	
	<b>340005</b> 340005	93.0	1.40	<b>B300600</b> 🚗 HAT55055 HAT55100	Granada, Transit, Escorpio, Sierra Capri, Taunus 1970/...	<b>1993cc.</b> OHC TL20L/H 102/105HP Ø91	
	<b>340105 - 340107 - 340108</b> 340105 340107 340108	70.0 70.0 70.0	1.20 1.20 0.35	<b>B340100</b> 🚗 HAT55055 HAT55100	Ka 1999/...	<b>999cc.</b> Zetec Rocam ZL 65HP Ø68.69 (SOHC) 8V	<b>340100-R</b> 🚗 pág. 332
	<b>340205 - 340207 - 340208</b> 340205 340207 340208	83.0 83.0 83.0	1.20 1.20 0.35	<b>B340100</b> 🚗 HAT55055 HAT55100	Ka 1997/..., Fiesta 1999/... Escort, Eco Sport, Focus, Courier 2003/...	<b>1598cc.</b> Zetec Rocam ZL 95/105/110HP Ø82 (SOHC) 8V	<b>340200-R</b> 🚗 pág. 333
	<b>340307</b> 340307-1M 340307-2M 340307-3M 340307-4M	84.0 84.0 84.0 84.0	1.20 1.30 1.40 1.50	<b>B340300</b> 🚗 HAT60055 HAT60100	Focus TD di 1998/..., Fiesta TD di 2000/... Focus TD ci 2001/..., Focus di 1999/... <b>DIESEL</b>	<b>1753cc.</b> Lynx (C9DC) 75/90HP Duratorq 115HP BHDA/BHDB 75HP Ø82.5	<b>340301-R</b> 🚗 pág. 334
	<b>340308</b> 340308-2M 340308-3M 340308-4M 340308-5M 340308-6M 340308-7M	83.5 83.5 83.5 83.5 83.5 83.5	1.20 1.25 1.30 1.35 1.40 1.42	<b>B340300</b> 🚗 HAT60055 HAT60100	Focus TD di 1998/..., Fiesta TD di 2000/... Focus TD ci 2001/..., Focus di 1999/... <b>DIESEL</b>	<b>1753cc.</b> Lynx (C9DC) 75/90HP Duratorq 115HP BHDA/BHDB 75HP Ø82.5	<b>340301-R</b> 🚗 pág. 334

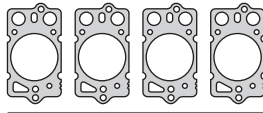

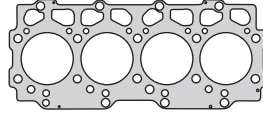
**MOTORES NAFTA Y DIESEL / PETROL AND DIESEL ENGINES**

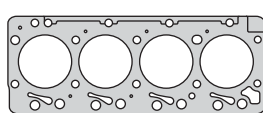
	<b>Código Code</b>	<b>Q</b>	<b>≠</b>	<b>Kit Bulón Bolt Set</b>	<b>Aplicación Application</b>	<b>Motor Engine</b>	<b>Juego</b>
	<b>340407</b>	<b>114.0</b>	<b>1.30</b>		F100/F250/F350, Econoline 250/350 1985/87	<b>7500cc.</b> F460L V8 Ø110	<b>340400-R</b> 🚗 pág. 335
	<b>340507</b>	<b>114.0</b>	<b>1.30</b>		Monterey, Torino, Cougar, Continental Mark III/IV/V 1988/94	<b>7500cc.</b> 460 CID V8 Ø110	<b>340500-R</b> 🚗 pág. 336
	<b>340607</b>	<b>100.0</b>	<b>1.30</b>	<b>B300300</b> <b>B302300</b> 🔧 HAD19038 HAT55055	Mustang - Ranger 1993/94 Ranger 1995/97 - Pick Up 1989/...  Pick Up, Ranger 1997/...	<b>2298cc.</b> F140L (SOHC) 106HP Ø96  <b>2500cc.</b> EFI - NAi4 117HP Ø96 (SOHC) 8V	<b>340600-R</b> 🚗 pág. 337  <b>302300-R</b> 🚗 pág. 262
	<b>340707</b> <b>340708</b>	<b>93.0</b> <b>92.0</b>	<b>1.30</b> <b>0.88</b>		E-Series - Mustang, Grand Marquis Crown Victoria, Pick Up F250 1997/99 E-Series - Mustang, Grand Marquis Crown Victoria, Pick Up F250 2000/03 Town Car, Cougar, Grand Marquis 1991/95 LTD Crown, Victoria 1992/...	<b>4600cc.</b> Triton 281V8 180HP Ø92  <b>4600cc.</b> Triton 281V8 180HP Ø92  <b>4600cc.</b> 281 CID V8 180HP Ø92	<b>302700-R</b> 🚗 pág. 265  <b>302800-R</b> 🚗 pág. 266  <b>340700-R</b> 🚗 pág. 338
	<b>340707</b> <b>340708</b>	<b>93.0</b> <b>92.0</b>	<b>1.30</b> <b>0.88</b>	<b>B322500</b> 🔧 HAT55055 HAT55100	E-Series - F-Series, Expedition Triton 1997/99  Triton 2000/03, E-Series, F-Series Expedition	<b>4600cc.</b> Triton 281 V8 180HP Ø92 <b>5408cc.</b> Triton 330 V8 260HP Ø92  <b>4600cc.</b> 281 V8 180HP Ø92 <b>5408cc.</b> 330 V8 260HP Ø92	<b>322500-R</b> 🚗 pág. 311  <b>322600-R</b> 🚗 pág. 312
	<b>340907</b>	<b>105.0</b>	<b>1.20</b>		F100, F150 1991/...	<b>4900cc.</b> 300 CID Inyección 145HP Ø101.6	<b>340900-R</b> 🚗 pág. 340
	<b>400005</b> <b>400007</b> <b>400008</b>	<b>92.5</b> <b>92.5</b> <b>92.5</b>	<b>1.40</b> <b>1.40</b> <b>1.15</b>	<b>B400000</b> 🔧 HAS19038	F100, Falcon 1970/...  F100 <b>DIESEL</b>	<b>3336cc.</b> 4.203-P4-192Z 71HP Ø91.49  <b>3336cc.</b> 74.206 Potenciado 71HP Ø91.44	<b>400000-R</b> 🚗 pág. 373  <b>410000-R</b> 🚗 pág. 376
	<b>400307</b> <b>400308</b>	<b>92.5</b> <b>92.5</b>	<b>1.40</b> <b>1.25</b>	<b>B400300</b> 🔧 HAS19038	F100 1974/...	<b>5004cc.</b> 6PF - 305 102HP Ø91.44	<b>400300-R</b> 🚗 pág. 374
	<b>430007-1M</b> <b>430007-2M</b> <b>430007-3M</b> <b>430007-4M</b>	<b>92.0</b> <b>92.0</b> <b>92.0</b> <b>92.0</b>	<b>1.40</b> <b>1.50</b> <b>1.60</b> <b>1.70</b>	<b>B430000</b> <b>B430000-1</b> 🔧 HAS19038	Ranger TDI 1995/...	<b>2507cc.</b> 95HP Ø90.7	<b>430001-R</b> 🚗 pág. 365
	<b>430008-1M</b> <b>430008-2M</b> <b>430008-3M</b>	<b>92.0</b> <b>92.0</b> <b>92.0</b>	<b>1.20</b> <b>1.30</b> <b>1.40</b>	<b>B430000</b> <b>B430000-1</b> 🔧 HAS19038	Ranger TDI 1995/...  <b>DIESEL</b>	<b>2507cc.</b> 95HP Ø90.7	<b>430001-R</b> 🚗 pág. 365

**MOTORES NAFTA Y DIESEL / PETROL AND DIESEL ENGINES**

	<b>Código</b> Code	<b>Q</b>	$\neq$	<b>Kit Bulón</b> Bolt Set	<b>Aplicación</b> Application	<b>Motor</b> Engine	<b>Juego</b>
	430607-1M	94.0	1.40	B430600	Ranger TD BR 2000-2002/...	<b>2758cc.</b> Power Stroke 135HP Ø93	<b>430001-R</b> (430600)  pág. 366
	430607-2M	94.0	1.50	 HAS19038	<b>DIESEL</b>		
	430607-3M	94.0	1.60				
	430607-4M	94.0	1.70				
	430608-1M	94.0	1.20	B430600	Ranger TD BR 2000-2002/...	<b>2758cc.</b> Power Stroke 135HP Ø93	<b>430001-R</b> (430600)  pág. 366
	430608-2M	94.0	1.30	 HAS19038			
	430608-3M	94.0	1.40				
	430807-1M	98.0	1.30	B430800	Ranger 3.0l, 4 x 4, Full BR Intercooler 2005/8	<b>2798cc.</b> NGD 3.0 E 163HP Ø96 (SOHC) 16V	<b>430801-R</b>  pág. 367
	430807-2M	98.0	1.40	 HAT60055			
	430807-3M	98.0	1.50	HAT60100			
	430807-4M	98.0	1.60				
	430808-1M	98.0	1.30	B430800	Ranger 3.0l, 4 x 4, Full BR Intercooler 2005/8	<b>2798cc.</b> NGD 3.0 E 163HP Ø96 (SOHC) 16V	<b>430801-R</b>  pág. 367
	430808-2M	98.0	1.40	 HAT60055			
	430808-3M	98.0	1.50	HAT60100			
	430808-4M	98.0	1.60				
	471307-1M	76.0	1.20	B302100	Focus C-Max TDCI 2003/... Fusion TDCI 2004/...	<b>1560cc.</b> G8DA 90HP Duratorq 109HP Ø75 (DOHC) 16V	<b>471301-R</b>  pág. 439
	471307-2M	76.0	1.30	 HAE14038			
	471307-3M	76.0	1.40				
	471307-4M	76.0	1.45				
	471307-5M	76.0	1.50				
	471308-1M	76.0	1.25	B302100	Focus C-Max TDCI 2003/... Fusion TDCI 2004/...	<b>1560cc.</b> G8DA 90HP Duratorq 109HP Ø75 (DOHC) 16V	<b>471301-R</b>  pág. 439
	471308-2M	76.0	1.30	 HAE14038			
	471308-3M	76.0	1.35				
	471308-4M	76.0	1.40				
	471308-5M	76.0	1.45				
	471408-1M	86.0	1.25	B470800	C-Max 2003/..., Focus, Galaxy S-Max 2006/..., Mondeo , C-Max Focus TDCI 2007/...	<b>1998cc.</b> DURATORQ (20DD0X) 110/115/130/135/140HP Ø85 (DOHC) 16V	<b>471401-R</b>  pág. 440
	471408-2M	86.0	1.30	 HAE14038			
	471408-3M	86.0	1.35				
	471408-4M	86.0	1.40				
	500507-SM	98.0	1.55		Scorpio TDI, Granada TDI 1993/94 Falcon 1988/...	<b>2499cc.</b> SCB 115HP Ø92	<b>500401</b>  pág. 521
	500507-2M	98.0	1.60				
	500507-1M	98.0	1.80				
	520307-1M	98.0	1.40	B520300	Scorpio TDI SCC/SCD 1994/98	<b>2499cc.</b> SCC/SCD 115/125HP Ø92	<b>520301-R</b>  pág. 522
	520307-2M	98.0	1.50	 HAN12055			
	520307-3M	98.0	1.60	HAN12100			
	520308-1M	98.0	1.42				
	520308-2M	98.0	1.52				
	520308-3M	98.0	1.62				
	870007	106.0	1.60	B870000	F100 1998/...	<b>3900cc.</b> 4B - 4BT - 4BTA 100/130HP Ø102	<b>870000-R</b>  pág. 19
	870007-1.85	106.0	1.85	 HAS17038	<b>DIESEL</b>		

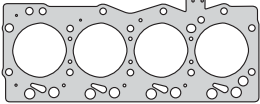
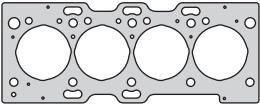
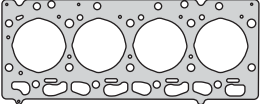
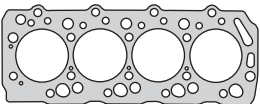
**MOTORES NAFTA Y DIESEL / PETROL AND DIESEL ENGINES**

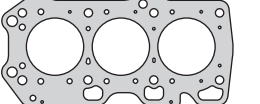
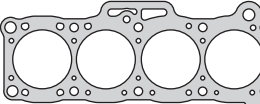
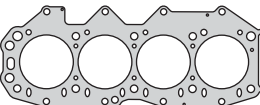
	<b>Código Code</b>	<b>Q</b>	<b>≠</b>	<b>Kit Bulón Bolt Set</b>	<b>Aplicación Application</b>	<b>Motor Engine</b>	<b>Juego</b>
	<b>870508</b>	<b>150.0</b>	<b>1.10</b>	<b>B870500</b>	F100 2006/..., Common Rail <b>DIESEL</b>	<b>3920cc.</b> ISBe 150/170HP Ø102	<b>870500-R</b> <b>870501-R</b> 📄 pág. 25
	<b>870808</b>	<b>95.0</b>	<b>1.00</b>		F350, F4000 2014/... <b>DIESEL</b>	<b>2776cc.</b> ISF2.8 150HP Ø94 (SOHC) 16V	<b>870800-R MLS</b> 📄 pág. 28
	<b>870908</b>	<b>130.0</b>	<b>1.20</b>		Pick Up <b>DIESEL</b>	<b>3759cc.</b> IISF3.8 148HP Ø102 (OHV) 16V	<b>870900-R MLS</b> 📄 pág. 29
	<b>910507</b>	<b>92.0</b>	<b>1.70</b>	<b>B910500</b> 🔩 HAH10055 HAH10140	Bronco II TD, Ranger 2WD 1985/... <b>DIESEL</b>	<b>2346cc.</b> 4D55T 8V 67HP Ø91 (SOHC) 8V	<b>910500-R</b> 📄 pág. 167
	<b>920208</b>	<b>97.8</b>	<b>1.58</b>	<b>B920200</b> 🔩 HAS17038	Maverick TD 1992/99	<b>2663cc.</b> TD27T 100/125HP Ø96 (SOHC) 8V	<b>920200-R</b> 📄 pág. 298
	<b>971607</b> <b>971608-1M</b> <b>971608-2M</b>	<b>94.5</b> <b>94.5</b> <b>94.5</b>	<b>1.30</b> <b>1.00</b> <b>1.05</b>	<b>B971200</b> 🔩 HAD14038	Ranger D, Ranger TD 1998/...	<b>2499cc.</b> WL/WLT 78/108HP Ø93 (SOHC) 12V	<b>971600-R MLS</b> 📄 pág. 142
	<b>971907</b>	<b>94.3</b>	<b>1.30</b>	<b>B971900</b> 🔩 HAD12038	Probe 1992/95 <b>DIESEL</b>	<b>2497cc.</b> KL 170HP Ø84.5 (DOHC) V6 24V	
	<b>963407</b>	<b>88.5</b>	<b>1.70</b>	<b>B973400</b> 🔩 HAS17038	Probe 1989/91 <b>DIESEL</b>	<b>2184cc.</b> F2 147HP Ø86 (SOHC) 12V	<b>973600-R</b> 📄 pág. 155
	<b>963908</b>	<b>96.5</b>	<b>0.95</b>	<b>B971200</b> 🔩 HAD14038	Ranger 2002/07 <b>DIESEL</b>	<b>2953cc.</b> 156HP Ø96 (SOHC) 12V	<b>973900-R MLS</b> 📄 pág. 158

**FORD****taranto**

Motor/Engine	Cm³	HP	Ø
187 - 7B	3052	108	90.62
188 - 7B	3075	108	93.47
221 - 7B (OHV) 12V	3618	108	93.47

Ford: Falcon, F100, Fairlane 1969/...



Nº OE	Descripción/Description	Mat.	Ref.
	Jgo. de juntas para motor		300000-R
	Jgo. de juntas superior		300095
BAD3DZ6051A	Jta. tapa cilindros Ø 96.7 $\pm$ 1.40	NFT 1 1	300005
	Jta. tapa cilindros Ø 96.7 $\pm$ 2.40	NFT	300006
BAD3DZ6051A	Jta. tapa cilindros Ø 96.7 $\pm$ 1.40 NR	NFT	300007
	Jgo. tornillos tapa cilindros		B300000
CODE6584B	Junta tapa válvulas superior	CG 1 1	300010
BAC9DZ6781A	Jgo. junta para cárter (4)	CG	300011
BAC9DZ6020A	Tapa distribución	NB	300012
CODE8507A	Bomba de agua	NB	300014
BAC8DZ9448A	Múltiple admisión y escape (fondo chapa)	FCH	300015
BAC8DZ9448A	Múltiple admisión y escape	NFT 1	300016
C6AZ9450D	Salida de escape	NFT 1 1	300018
CODE8255A	Salida agua termostato	CB 1 1	300019
BAC9AZ9502A	Jgo. juntas carburador HOLLEY M/188	VS	300020
BAC9AZ9502A	Jgo. juntas carburador HOLLEY M/221	VS	300120
BAD3DZ9502A	Jgo. juntas carburador GALILEO M/188	VS	300021
BAD3DZ9502A	Jgo. juntas carburador GALILEO M/221	VS	300121
BAE2DZ9502A	Jgo. juntas carburador HOLLEY ARGELITE	VS	300022
BAE2DZ9502A	Jgo. juntas carburador HOLLEY ARGELITE s/sep.	VS	300023
BAC4DZ9447A	Base carburador M/188	NB 1 1	300025
BAC9DZ9447B	Base carburador M/221	NB 1 1	300125
	Tapa cuba HOLLEY	CG	300026
	Bomba aceite	NB	300027
C3AZ9417C	Bomba nafta	NB	300028
BAC9DZ9447A	Base calefactor	NB 1 1	300031
CODE6626A	Cañería aceite	NB	300032
	Intermedia HOLLEY 188/221	NB	300033
	Válvula potencia	CB	300034
	Base carburador HOLLEY ARGELITE	NB	300035
	Intermedia HOLLEY ARGELITE	NB	300037
	Tapa carburador HOLLEY ARGELITE	CB	300038
	Salida escape	AC	300040
	Jgo. juntas caja velocidades FAE	VS	300050
	Jgo. juntas caja velocidades 3.03 1ra. Serie	VS	300051
	Jgo. juntas caja velocidades TRANSAX	VS	300052
	Plato freno a diferencial	CB	300056
	Apoyo retén ruleman	CB	300057
C9DZ6701A	Jgo. juntas empaquetadura bancada (2)	SNA	300058
BAC9DZ6781A	Jgo. juntas para cárter	CG	300060
CODE6584B	Tapa válvulas superior	CG	300061
	Porta retén ruleman palier	CB	300065
	Palier	CB	300069
	Junta tapa cilindros competición (0.60)	NFT	300090-0.60
	Junta tapa cilindros competición (0.80)	NFT	300090-0.80
	Junta tapa cilindros competición (1.00)	NFT	300090-1.00
	Junta tapa cilindros competición de lámina	AC	300090L
	Kit de retenes completo		R300000
	Jgo. retén válvulas (12)	P 1	R300010P
	Jgo. retenes válvulas capuchones (12)	P	R300010-1P
	Retén bancada 85.7 x 102.62 x 9.73	P 1	R300011P
	Retén reforma bancada 85.7 x 100 x 5.5	P 1	R300911P
	Retén distribución 44.45 x 60.3 x 11.11	P 1	R300012P

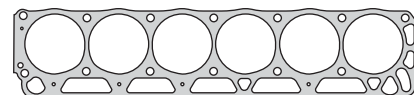

300005



300010

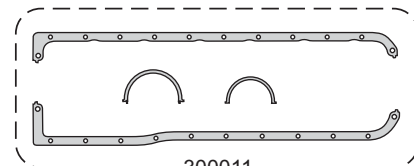

300011

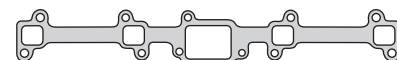

300015/16

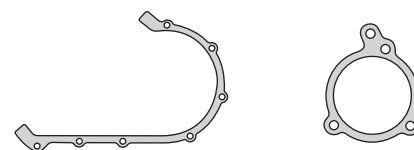

300012

300014



300018

300019

300025



300125

300026

300027



300028

300031

300032

300033

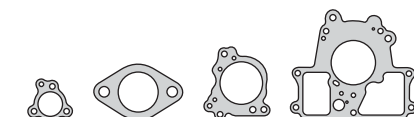

300034

300035

300037

300038



300058

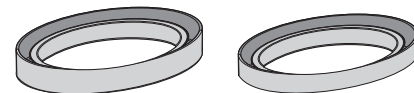

R300011P

R300911P



R300012P

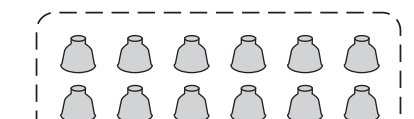

R300010-1P

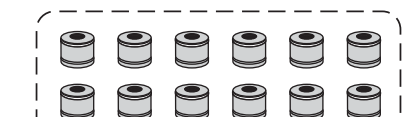

R300010P

**FORD**



Motor/Engine	Cm³	HP	Ø
221 Sprint 7B (OHV) 12V	3618	132	93.47

Ford: Falcon SP, Sprint 1973/...



Nº OE	Descripción/Description	Mat.	Ref.
	Jgo. de juntas para motor		300100-R
BAD3DZ6051A	Junta tapa cilindros Ø 96.7 $\pm$ 1.40	NFT 1	300005
	Junta tapa cilindros Ø 96.7 $\pm$ 2.40	NFT	300006
BAD3DZ6051A	Junta tapa cilindros Ø 96.7 $\pm$ 1.40	NFT	300007
	Jgo. tornillos tapa cilindros		B300000
CODE6584A	Junta tapa válvulas superior	CG 1	300010
	Junta tapa válvulas 1986/...		300110
BAC9DZ6781A	Jgo. junta para cárter (4)	CG 1	300011
BAC9DZ6020A	Tapa distribución	NB 1	300012
CODE8507A	Bomba de agua	NB 1	300014
BAD3DZ9448A	Múltiple admisión y escape	NFT 1	300116
C6AZ9450D	Salida de escape	FCH 1	300418
CODE8255A	Salida termostato	CB 1	300019
BAC7TZ	Jgo. juntas carburador HOLLEY ARGELITE	VS	300122
BAX9DZ9447B	Base carburador M/221	NB 1	300125
BAD00Z9447A	Base carburador	NB 2	300225
	Cuba abierta HOLLEY	CG	300226
	Bomba aceite	NB 1	300027
C3AZ9417C	Bomba nafta	NB 1	300028
BAC9DZ9447A	Base calefactor	NB 1	300031
CODE6626A	Cañería aceite	NB 1	300032
	Tapa diferencial DANA 44	CG	540034
	Placa HOLLEY cerrada	CG	300237
	Intermedio carburador HOLLEY 2b	NB	300238
	Jgo. juntas caja velocidades TRANSAX	VS	300052
C90Z6701A	Jgo. juntas empaquetadura bancada (2)	SNA	300058
BAC9DZ6781A	Jgo. juntas para cárter	CG	300060
CODE6584B	Tapa válvulas superior	CG	300061
	Tapa diferencial dana 44	CGT	540068
	Kit de retenes completo		R300000
	Jgo. retén válvulas (12)	P 1	R300010P
	Jgo. retén válvulas capuchones (12)	P	R300010-1P
	Retén bancada 85.70 x 102.62 x 9.73	P 1	R300011P
	Retén reforma bancada	P 1	R300911P
	Retén distribución 44.45 x 60.3 x 11.11	P 1	R300012P

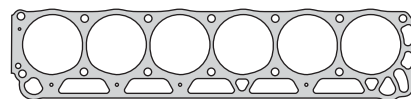

300005



300010

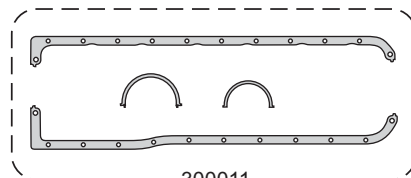

300011



300010

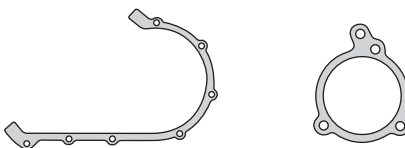

300014

300012



300418

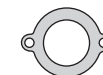

300019

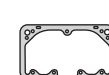

300226



300125

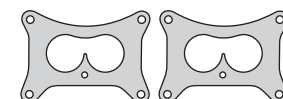

300225



300027



300028



300031



300032

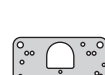

300237



300058



R300011P



R300911P



R300012P

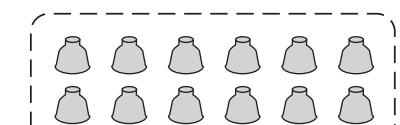

R300010-1P

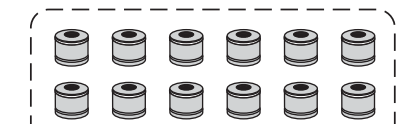

R300010P



**FORD****taranto**

Motor/Engine

Cm³

HP

Ø

Ford: F100, F350, F600, Fairlane 1961/70

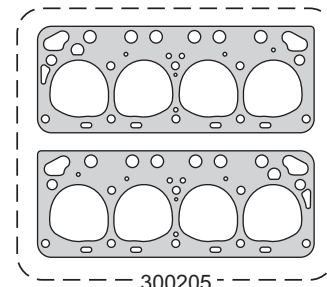
272 - V8 FI  
292 - V8 FI4458  
4785170  
17092  
95.25

300205

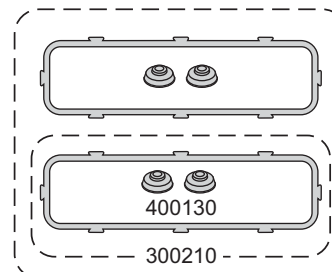

300210

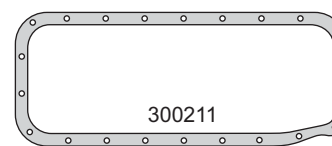

300211

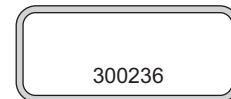

300236

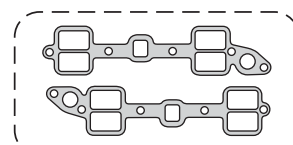

300217

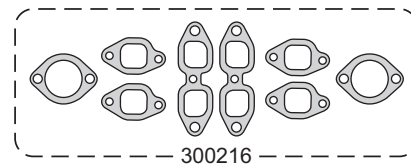

300216

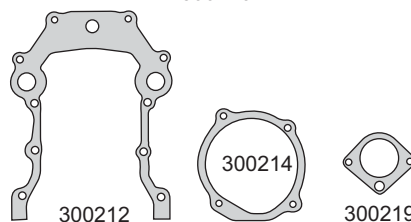

300212

300214

300219

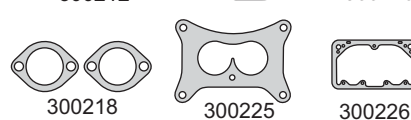

300218

300225

300226

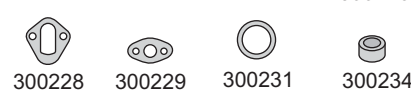

300228

300229

300231

300234

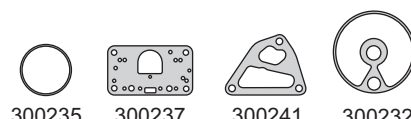

300235

300237

300241

300232



300258

R300212P

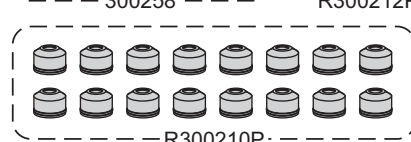

R300210P

Nº OE	Descripción/Description	Mat.	Ref.
	<b>Jgo. de juntas para motor</b>		<b>300200-R</b>
	<b>Jgo. junta tapa cilindros Ø 97.0 ± 1.40 (2)</b>		<b>1 300205</b>
COAE6584B	Conj. junta tapa válvulas superior (3)	CG	2 300210
COAE6710B	Junta para cárter	CG	1 300211
B4A6020A	Tapa distribución	NB	1 300212
B5A8507A	Tapa bomba de agua	NB	1 300214
BA7A9433	Jgo. múltiple escape (6)	NFT	1 300216
	Jgo. múltiple admisión (2)	NFT	1 300217
BA5A9450A	Salida de escape	FCH	2 300218
B5A8255A	Base termostato	CB	1 300219
	Jgo. juntas carburador HOLLEY ARGELITE	VS	300220
	Base carburador	NB	1 300225
	Cuba HOLLEY abierta	CG	300226
C3AZ9417C	Base bomba nafta	NB	1 300228
EAN8563B	Brida salida agua	NB	1 300229
B5A9450A	Acople múltiple escape	FCH	2 300230
	Arandela tapa válvulas	GS	4 400130
	Vaso combustible	CG	1 300231
EAA6838A	Base filtro aceite	CG	1 300232
B9A6570A	Arandela tapa válvulas	GS	300233
B4A6698A	Buje bomba aceite	GS	1 300234
B6Q6619A	Tapa bomba aceite	GS	1 300235
COAE6521A	Tapa lateral botadores	CG	1 300236
	Placa HOLLEY cerrada	CG	300237
	Intermedia carburador HOLLEY	NB	300238
B6Q6659A	Base bomba aceite	NB	1 300241
	Jgo. juntas caja velocidades Ford 62/63	VS	300250
	Jgo. juntas caja velocidades F350/600	VS	300251
	Jgo. juntas diferencial EATON 132 A y B	VS	300255
	Núcleo diferencial EATON 132	CB	350355
	Palier	CB	300256
	Palier F700/6000	NB	300557
C90Z6701A	Jgo. juntas empaquetadura bancada (2)	SNA	1 300258
	Palier DANA 60-350		300559
COAE6710B	Junta para cárter	CG	300260
COAE6584B	Tapa válvulas superior	CG	300261
	Tapa diferencial SPICER 70	CG	300264
	Tapa diferencial SPICER 70	NH	300265
	Tapa diferencial EATON 161/162	CG	350369
	Núcleo diferencial EATON 161/162 N	CB	350382
	Tapa diferencial EATON 132 A y B	CG	350388
	Kit de retenes completo		R300200
	Jgo. retén válvulas (16)	P	1 R300210P
	Retén distribución 47.65 x 65.05 x 11.83	P	1 R300212P

**FORD**



Motor/Engine	Cm³	HP	Ø
OHC (SOHC) 8V	1990	63	90.8

Ford: Taunus L, GXL, Ghia 1974/...



Nº OE	Descripción/Description	Mat.	Ref.
	Jgo. de juntas para motor		300300-R
	Jgo. de juntas superior		300395
76BH6051B	Junta tapa cilindros Ø 91.1 ± 1.40	NFT 1 1	300305
	Jgo. tornillos tapa cilindros (HAD19038)		B300300
74BR6584AE	Junta tapa válvulas	CG 1 1	300310
	Jgo. junta para cárter (4)	CG 1 1	300311
74BR6020A	Tapa distribución	NB 1 1	300312
74BR8507A	Bomba de agua	NB 1 1	300314
78BR9448A	Múltiple escape	NFT 1 1	300316
74BR9439A	Múltiple admisión	NB 1 1	300317
74BR8255A	Salida agua termostato	CB 1 1	300319
BAD3DZ9502	Jgo. juntas carburador GALILEO	VS	300320
	Base carburador	NB 1 1	300325
74BR6625A	Bomba aceite a block	NB 1	300327
74BR9417A	Base bomba nafta	CB 1	200028
	Tubo llenado aceite	NB 1	300329
	Jgo. juntas caja velocidades	VS	300350
	Tapa diferencial TRANSAX	CG	450355
	Palier	CB	300356
	Jgo. juntas para cárter	CGT	300360
	Junta tapa válvulas	CGT	300361
	Kit de retenes completo		R300300
	Jgo. retén válvulas (8)	P 1	R300310P
	Retén bancada 92 x 108 x 9.8	P 1	R300311P
	Retén reforma bancada 91.5 x 106.5 x 5.5	P 1	R300411P
	Retén distribución 43.41 x 56.02 x 9.3	P 3	R300312P

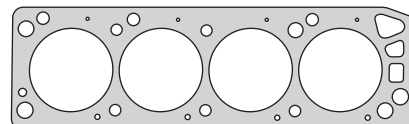

300305

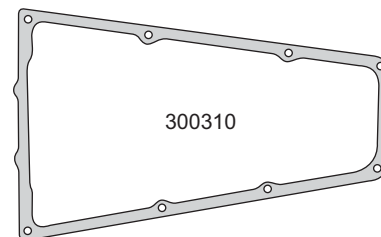

300310

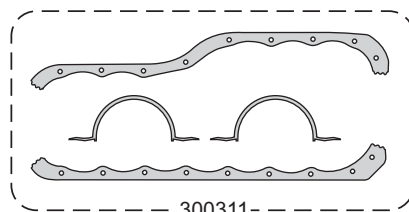

300311



300316

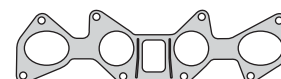

300317

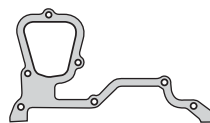

300312

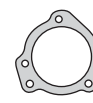

300314



300319



300325



300327



200028



300329



R300311P



R300411P



R300312P

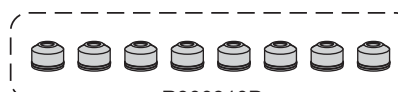

R300310P

**FORD**



Motor/Engine	Cm³	HP	Ø
OHC	2299	100/114	96

Ford: Taunus, Sierra, XR4, Falcon 1974/...  
GXL/GT, SP/Ghia  
Maverick 1975/79, Mustang 1980/...

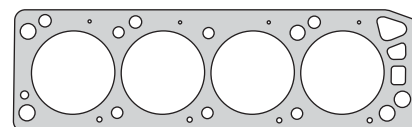

300405

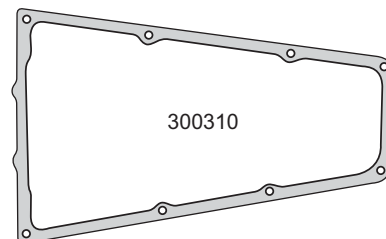

300310

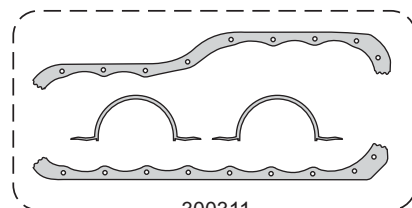

300311



300316



300317

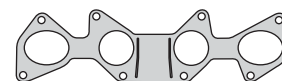

300417

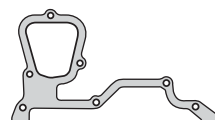

300312

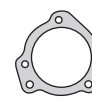

300314



300418



300319



300327



200028

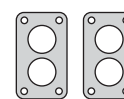

300425



300329



R300311P



R300411P



R300312P



R300310P

Nº OE	Descripción/Description	Mat.	Ref.
	Jgo. de juntas para motor		300400-R
	Jgo. de juntas superior		300495
76BR6051A	Junta tapa cilindros Ø98.0 ±1.40	NFT 1 1	300405
	Junta tapa cilindros Ø98.0 ±1.40 NR	NFT	300407
	Jgo. tornillos tapa cilindros (HAD19038)		B300300
74BR6584CE	Junta tapa válvulas	CG 1 1	300310
	Jgo. junta para cárter (4)	CG 1	300311
74BR6020A	Tapa distribución	NB 1	300312
74BR8507A	Bomba de agua	NB 1	300314
78BR9448A	Múltiple escape	NFT 1 1	300316
74BR9439A	Múltiple admisión	NB 1 1	300317
	Múltiple admisión sierra	NB 1 1	300417
	Salida de escape SP	FCH 1 1	300418
74BR8255A	Salida agua termostato	CB 1 1	300319
74BR9502A	Jgo. juntas carb. SOLEX 34 eies 74 BR-9502A	VS	300420
75BR9502A	Jgo. juntas carb. SOLEX 34 eies 82 BR-9502A	VS	300421
82BR9502A	Jgo. juntas carb. SOLEX 34eies Arg 82 BR-9502A	VS	300422
84BR9502A	Jgo. juntas carb. SOLEX 34 TEIE 84 BR-9502A	VS	300423
74BR9447A	Base carburador	NB 2 2	300425
74BR6625A	Bomba aceite a block	NB 1	300327
74BR9417A	Base bomba nafta	CB 1	200028
	Tubo llenado aceite	NB 1	300329
	Jgo. juntas caja velocidades 4ta.	VS	300350
	Jgo. juntas caja velocidades 5ta.	VS	300450
	Tapa diferencial TRANSAX	CG	450355
	Jgo. junta para cárter	CG	300360
74BR6584CE	Junta tapa válvulas	CG	300361
	Junta tapa cilindros competición (0.60)	NFT	300490-0.60
	Junta tapa cilindros competición (1.00)	NFT	300490-1.00
	Kit de retenes completo		R300400
	Jgo. retén válvulas (8)	P 1	R300310P
	Reten bancada 92 x 108 x 9.8	P 1	R300311P
	Retén reforma bancada 91.5 x 106.5 x 5.5	P 1	R300411P
	Retén distribución 43.41 x 56.02 x 9.3	P 3	R300312P

**FORD**



Motor/Engine **Cm³** **HP** **Ø**

**V8 FII** **4785** **180** **95.25**

**Ford:** F100, F350, F600, Fairlane 1/8, LTD 500  
Fase II 1969/76



Nº OE	Descripción/Description	Mat.	Ref.
	<b>Jgo. de juntas para motor</b>		<b>300500-R</b>
BAD0AZ6051A/B	<b>Jgo. junta tapa cilindros Ø 98.0 ± 1.40 (2)</b>	NFT	<b>1 300505</b>
COAE6584B	Conj. junta tapa válvulas superior (3)	CG	2 300210
COAE6710B	Junta para cárter	CG	1 300211
B4A6020A	Tapa distribución	NB	1 300212
B5A8507A	Tapa bomba de agua	NB	1 300214
BAD0TZ9433	Jgo. múltiple escape (2)	NFT	1 300516
BAD0AZ9339	Jgo. múltiple admisión (2)	NFT	1 300517
C6AZ9450D	Salida de escape	FCH	2 300018
B5A8255A	Base termostato	CB	1 300219
	Jgo. carburador HOLLEY ARGELITE	VS	300220
	Jgo. carburador HOLLEY 2300 BA-D2/3 9510-A	VS	300520
BADCOZ9447A	Base carburador	NB	1 300225
	Cuba HOLLEY abierta	CG	300226
C3AZ9417C	Base bomba nafta	NB	1 300228
EAN8563B	Brida salida agua	NB	1 300229
B5A9450A	Palier DANA 60 f-350 (al)	FCH	2 300230
	Acople múltiple escape	CG	1 300231
EAA6838A	Base filtro aceite	CG	1 300232
B9A6570A	Arandela tapa válvulas	GS	4 300233
B4A6698A	Buje bomba aceite	GS	1 300234
B6O6619A	Tapa bomba aceite	GS	1 300235
COAE6521A	Tapa lateral botadores	CG	1 300236
	Placa HOLLEY cerrada	CG	300237
	Intermedia carburador HOLLEY	NB	300238
B6O6659A	Base bomba aceite	NB	1 300241
BAC90Z6A636A	Acople filtro aceite	CG	1 300542
	Jgo. juntas caja velocidades 3.03 1ra. Serie	VS	300051
	Jgo. juntas caja velocidades TRANSAX	VS	300052
	Palier DANA 60 f-350	CB	300556
C90Z6701A	Jgo. juntas empaquetadura bancada (2)	SNA	1 300258
	Vaso nafta		300559
	Tapa diferencial SPICER 70	CG	300264
	Kit de retenes completo		R300200
	Jgo. retén válvulas (16)	P	1 R300210P
	Retén distribución 47.65 x 65.05 x 11.83	P	1 R300212P

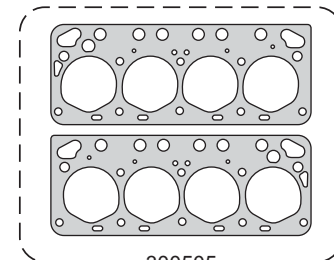

300505

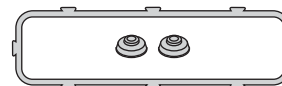

300210

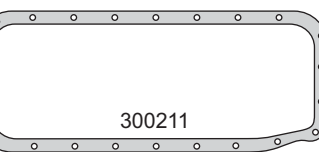

300211

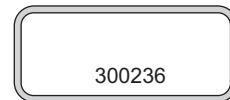

300229

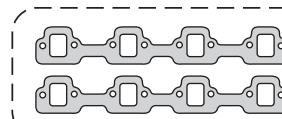

300231

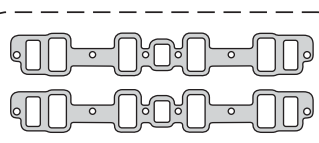

300516

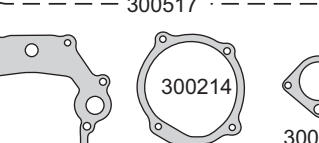

300212



300219



300234



300235



300225



300226

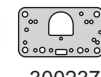

300237



300238



300229



300231



300234



300235



300241



300232



300542



300258



R300212P



R300210P

**FORD**



Motor/Engine	Cm³	HP	Ø
OHC	1597	75	81.3

Ford: Sierra 1.6L 1984/...



Nº OE	Descripción/Description	Mat.	Ref.
	Jgo. de juntas para motor		300600-R
	Jgo. de juntas superior		300695
84HM6051AC	Junta tapa cilindros Ø 83.5 ± 1.40	NFT 1 1	300605
	Jgo. tornillos tapa cilin. (HAT55055/55100)		B300600
83HM6584AA	Junta tapa válvulas	CG 1 1	300610
	Jgo. junta para cárter (4)	CG 1 1	300611
72HM6020AA	Tapa distribución	NB 1 1	300612
70HM8507AA	Bomba de agua	NB 1 1	300614
	Múltiple escape	NFT 1 1	300616
71HM9441AB	Múltiple admisión	NB 1 1	300617
81AB9451DA	Salida de escape	FCH 1 1	300618
70HM8255AB	Termostato	CB 1 1	300619
L84HF9447AA	Jgo. juntas carburador weber 84F-9502-AA	VS	300620
84HF9447AA	Base carburador	NB 2 2	300625
815M9417CIA	Base bomba nafta S/AA	NB 1	300628
71HM6659AB	Tubo aspiración bomba aceite	NB	300629
	Brida caño calefactor	NB 1	250430
85BR9417A	Base bomba nafta C/AA	NB 1	300630
	Jgo. juntas caja velocidades 5ta.	VS	300450
	Jgo. juntas carburador weber BR	VS	300621
	Tapa diferencial	NB	300659
	Jgo. junta para cárter	CGT	300660
	Kit de retenes completo		R300600
	Jgo. retén válvulas (8)	P 1	R300610P
	Retén bancada 79.38 x 95.25 x 11.11	P 1	R300611P
	Retén distribución árbol levas 42 x 56 x 7	P 3	R300612P

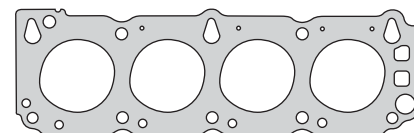

300605

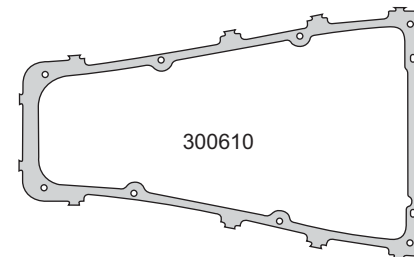

300610

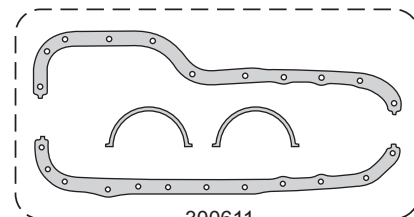

300611



300616

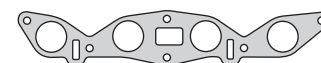

300617

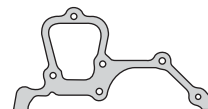

300612



300614



300618



300619

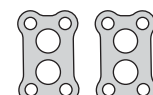

300625



300628



300629



250430



300630



R300611P



R300612P



R300610P

**FORD**



Motor/Engine	Cm³	HP	Ø
CHT/AE (SOHC) 8V	1555	73	77

**Ford:** Escort, Saveiro, Scala, Corcel II Del Rey, Pampa 1983/... Belina, Verona 1989/...  
**Volkswagen:** Saveiro, Voyage, Logus 1989/...



Nº OE	Descripción/Description	Mat.	Ref.
	Jgo. de juntas para motor		300700-R
	Jgo. de juntas superior		300795
84AU-6051R	Junta tapa cilindros Ø78.0 ±1.40	NFT 1 1	300705
84AU-6051B	Junta tapa cilindros Ø78.0 ±1.40 NR	NFT	300707
	Jgo. tornillos tapa cilindros (HAS17038)		B300700
64293	Conj. junta tapa válvulas (4)	N 1 1	300710
	Jgo. junta para cárter (4)	GS 1	300711
73MU-6020A	Tapa distribución	NB 1	300712
	Tapa bomba de agua	NB 1	300714
	Tapa bomba de agua	NB 1 1	560214
84AU-9448C	Múltiple admisión y escape	NFT 1 1	300716
	Entre múltiple	NFT 1 1	300717
	Salida de escape	FCH 1 1	220418
	Salida de escape	NFT	230218
85AU-9451A	Salida de escape	FCH 1 1	300718
86AU-8507AA	Base bomba de agua	NB 1 1	300719
	Jgo. juntas carburador	VS	300720
	Base carburador	NB 2 2	300725
	Tapa y toma bomba aceite	NB 1	550427
78MU-6659A	Bomba aceite	CB 1	300727
75MU-9417A	Base bomba nafta	NB 2	300728
84AU-6W021A	Placa tapa cilindros	NB 1 1	300729
E0FZ-6734AA	Tapón cárter A 15 x 21 x 2A	AL 1	300730
	Base bomba agua	NB 1 1	300731
86AU-8255AA	Termostato	NB 1 1	300733
	Arandela base distribuidor	NB 1	550338
	Unión caño escape	AC	300740
	O'ring tapa cilindros a calefactor G 36 x 3	GS 1 1	260142
	Arandela tapa válvulas	GS 3 3	300742
	Jgo. juntas caja velocidades	VS	300750
	Jgo. junta para cárter	CGT	300760
78MU-6055A	Jgo. supl. camisa cilindros superior (0.095) (4)	CU 1	300770-0.095
78MU-6055B	Jgo. supl. camisa cilindros superior (0.115) (4)	CU	300770-0.115
78MU-6055C	Jgo. supl. camisa cilindros superior (0.135) (4)	CU	300770-0.135
78MU-6055D	Jgo. supl. camisa cilindros superior (0.155) (4)	CU	300770-0.155
	Kit de retenes completo		R300700
	Jgo. retén válvulas (8)	V 1	R310810V
	Retén bancada 82 x 105 x 12	P 1	R300711P
	Retén árbol de levas 35 x 50 x 7	P 1	R470013P

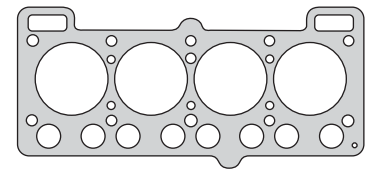

300705

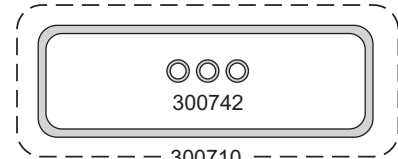

300742

300710

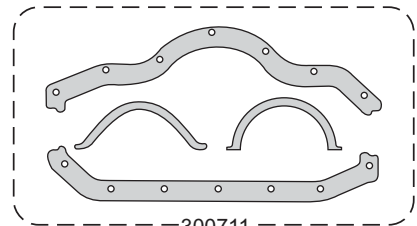

300711

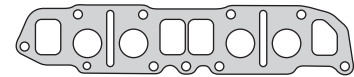

300716

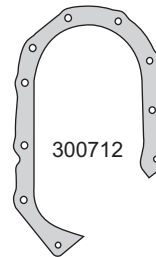

300712

300714

560214

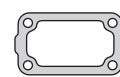

300717



230218

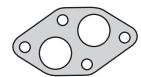

300718

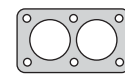

220418

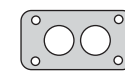

300725

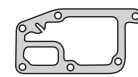
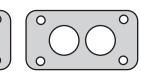

300719



550427



300728

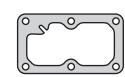

300729



300727

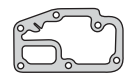

300731



300733



300730



550338



260142



300770-0.095



R4700013P



R300711P

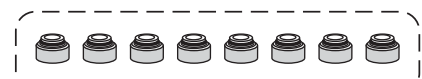

R310810V

**FORD****taranto**

Motor/Engine

Cm<sup>3</sup>

HP

Ø

2100

24

98.4

Ford: A - AA 1928/31

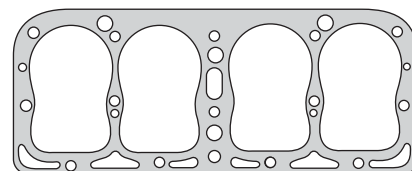

300805

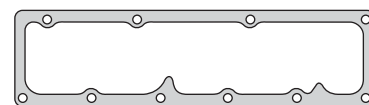

300810

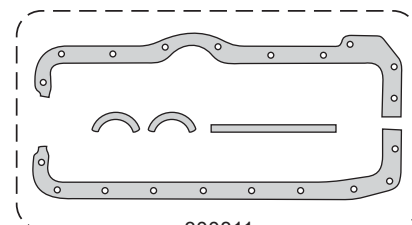

300811

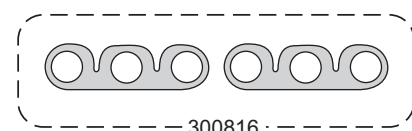

300816

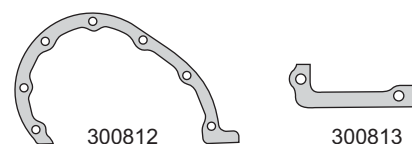

300812

300813



300814

300819

300825

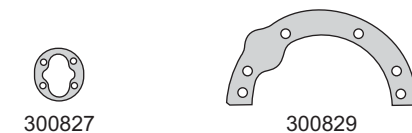

300827

300829



300830

300831

300832

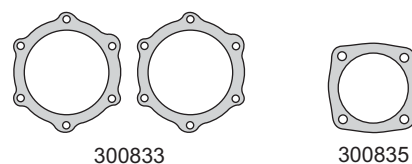

300833

300835

Nº OE	Descripción/Description	Mat.	Ref.
	Jgo. de juntas para motor		300800
A 6051 A	Junta tapa cilindros Ø 100.5 ± 1.65	FCH	1 300805
A 6521	Junta tapa válvulas lateral	NB	1 300810
A 6781	Jgo. junta para cárter (5)	CG	1 300811
B 6020	Tapa distribución	NB	1 300812
B 6018	Lateral distribución	NB	1 300813
A 8507	Tapa bomba de agua	NB	1 300814
A 18511	Jgo. múltiple admisión y escape (2)	NFT	1 300816
B 8280	Entrada agua	NB	1 300819
B 9447	Base carburador	NB	1 300825
A 6619 R	Tapa bomba aceite	NB	1 300827
	Cubre volante	NB	1 300829
A 8255	Salida agua	NB	1 300830
A 6648	Caño bomba aceite	NB	2 300831
A 9174	Vaso bomba nafta	CG	1 300832
B 6396	Tapa cruceta	NB	2 300833
	Porta piñón diferencial	NB	1 300835
B 6700	Empaquetadura cárter delantero	SNA	300880

**FORD**



Motor/Engine	Cm³	HP	Ø
170 4B	2780	84	88.9
187 4B	3052	96	90.42

Ford: Falcon 4B, STD, De Luxe, Futura Rural 1962/68



Nº OE	Descripción/Description	Mat.	Ref.
	Jgo. de juntas para motor		<b>300900-R</b>
<b>BAC4DZ6051</b>	Junta tapa cilindros Ø 94.0 ±1.40	NFT	<b>1 300905</b>
	Jgo. tornillos tapa cilindros		<b>B300000</b>
CODE6584B	Junta tapa válvulas superior	CG	1 300010
BAC9DZ6781A	Jgo. junta para cárter (4)	CG	1 300011
BAC9DZ6020A	Tapa distribución	NB	1 300012
CODE8507A	Bomba de agua	NB	1 300014
BAC8DZ9448A	Múltiple admisión y escape	FCH	1 300015
BAC8DZ9448A	Múltiple admisión y escape	NFT	300016
C6AZ9450D	Salida de escape	FCH	1 300918
CODE8255A	Salida agua termostato	CB	1 300019
BAC9AZ9502A	Jgo. juntas carburador HOLLEY	VS	300020
BAD3DZ9502A	Jgo. juntas carburador GALILEO	VS	300021
BAC4DZ9447A	Base carburador	NB	1 300025
BAC9DZ9447B	Base carburador	NB	1 300125
	Tapa cuba HOLLEY	CG	300026
	Bomba aceite	NB	1 300027
C3AZ9417C	Bomba nafta	NB	1 300028
BAC9DZ9447A	Base precalentador	NB	1 300031
CODE6626A	Cañería aceite	NB	1 300032
	Intermedio HOLLEY 188/221	NH	300033
	Válvula potencia	CB	300034
	Jgo. juntas caja velocidades FAE	VS	300050
C90Z6701A	Jgo. juntas caja velocidades importado	VS	300950
C90Z6701A	Jgo. juntas empaquetadura bancada (2)	SNA	1 300058
BAC9DZ6781A	Jgo. juntas para cárter	CG	300060
CODE6584B	Tapa válvulas superior	CG	300061
	Kit de retenes completo		R300900
	Jgo. retén válvulas (12)	P	1 R300010P
	Jgo. retén válvulas capuchones (12)	P	R300010-1P
	Retén bancada 85.7 x 100 x 5.5	P	1 R300911P
	Retén distribución 44.45 x 60.3 x 11.1	P	1 R300012P

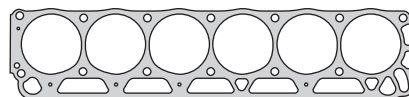

300905

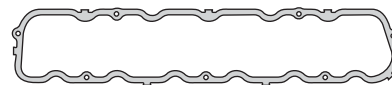

300010

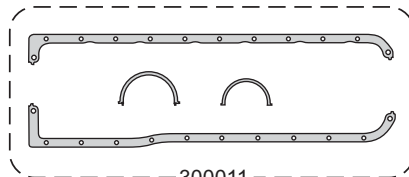

300011

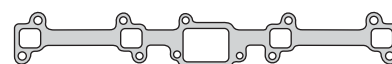

300015

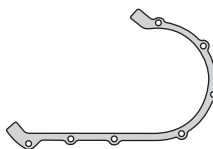

300012



300014



300918



300019



300025



300125



300026



300027



300028



300031



300032



300033

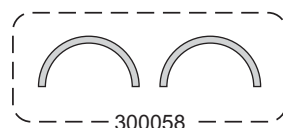

300058



R300012P



R300911P

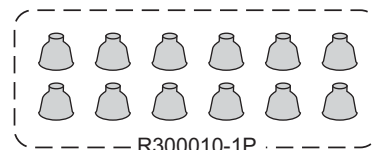

R300010-1P

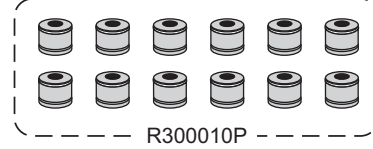

R300010P



**FORD**



Motor/Engine	Cm³	HP	Ø
HL14G/CFI/EFI (OHV) 8V	1392	73/75	77.2

Ford: Escort 1986/98, Orion 1986/94



Nº OE	Descripción/Description	Mat.	Ref.
	Jgo. de juntas superior		301095-R
	Junta tapas cilindros Ø 80.0 ± 1.70	NFT	1 301007
	Jgo. tornillos tapa cilindros (HAS13038)		B301000
	Junta tapa válvulas	CG	1 301010
	Múltiple escape	NFT	1 301016
	Múltiple admisión	NB	1 301017
	Aislante base bomba nafta	NB	1 301028
	Junta motor	NB	1 301040
	O'ring G 40.94 x 2.62	GS	1
	O'ring G 46.5 x 38.5 x 4	GS	1
	Jgo. retén válvulas (8)	V	1 R301010V
	Retén árbol de levas y distribución 42 x 56 x 7	V	1 R300612V

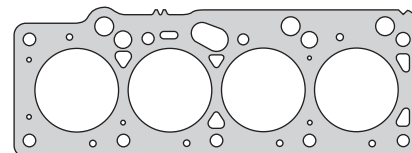

301007

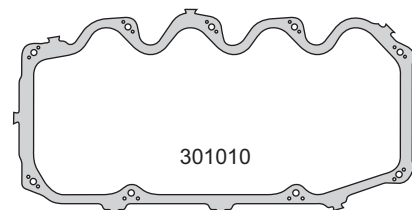

301010



301016

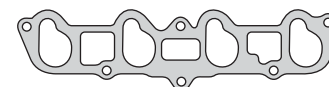

301017



301028



301040



G 40.94 x 2.62



G 46.5 x 38.5 x 4



R300612V



R301010V

**FORD**



Motor/Engine	Cm³	HP	Ø
CHV(HL16CFI)	1597	90	80
CVH(H16G/MFI)	1597	79	80
CVH(HL16H/I)	1597	79/105	80
CVH(HL16G/H) (OHV) 8V	1597	79/96	80

**Ford:** Fiesta i, Orion i 1989/92  
 Escort, Escort XR3 1980/85  
 Fiesta XR2 1984/85  
 Escort, Orion, Escort XR3i 1985/90



Nº OE	Descripción/Description	Mat.	Ref.
	Jgo. de juntas para motor		301100-R
	Jgo. de juntas superior	●	301195
	Jta. tapa cilindros Ø 83.0 ± 1.70  N.R.º  HAS13038	NFT 1 1	301107
	Jgo. tornillos tapa cilindros  (HAS13038)		B301000
	Junta tapa válvulas	CG 1 1	301010
	Jgo. junta para cárter (4)	CG 1 1	301111
	Tapa distribución	NB 1 1	301112
	Base distribución	NB 1 1	301113
	Múltiple escape	NFT 1 1	301116
	Múltiple admisión	NB 1 1	301017
	Múltiple admisión	NB 1 1	301117
	Junta aislante base bomba de agua	NB 1 1	301028
	Junta	NB 1 1	301130
	Múltiple admisión	NB 1 1	301131
	Junta	NB 1 1	301132
	Junta	NB 1 1	301133
	Junta	NB 1 1	301134
	Junta	NB 1 1	301135
	Junta	CB 1 1	320235
	Entrada aire	CB 1 1	340837
	Junta	NB 1 1	301137
	EGR válvula	NFT 1 1	320739
	Junta	NB 1 1	301040
	Arandela A 12 x 15 x 1.2 A	AL 1 1	
	Anillo G 35 x 28 x 1.6	GS 1 1	
	Anillo G 68 x 76 x 4	GS 1 1	
	O´ring G 31.3 x 2.62	GS 1 1	
	O´ring G 40.94 x 2.62	GS 1 1	
	Anillo G 46.5 x 38.5 x 4	GS 1 1	
	Kit de retenes completo		R301100
	Jgo. retén válvulas (8)	P 1 1	R301110P
	Retén bancada 88 x 108 x 10	V 1 1	R320311V
	Retén distribución 43.41 x 56.02 x 9.3	P 1 1	R300312P
	Retén árbol de levas 35 x 50 x 7	P 1 1	R470013P

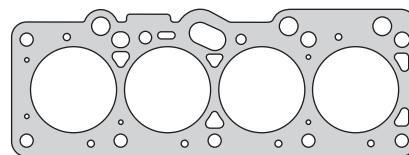

301107

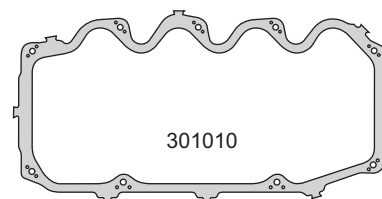

301010

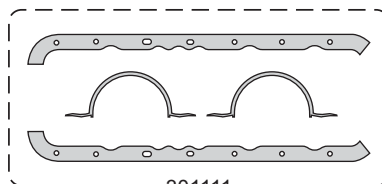

301111



301116



301017



301117



301131

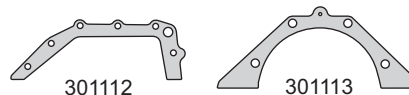

301112

301113



301028

301134

301135

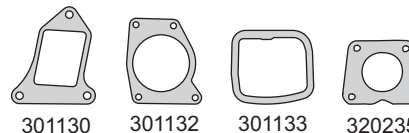

301130

301132

301133

320235

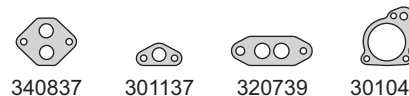

340837

301137

320739

301040

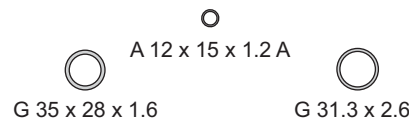

A 12 x 15 x 1.2 A

G 35 x 28 x 1.6

G 31.3 x 2.62

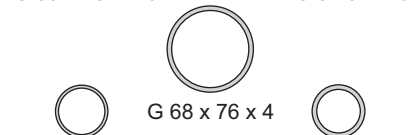

G 40.94 x 2.62

G 46.5 x 38.5 x 4



R320311V

R300312P

R470013P



R301110P

**FORD**



Motor/Engine Cm³ HP Ø

ZETEC (DOHC) 16V 1597 90 76

Ford: Mondeo 1993/...

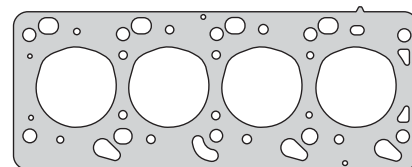

301207

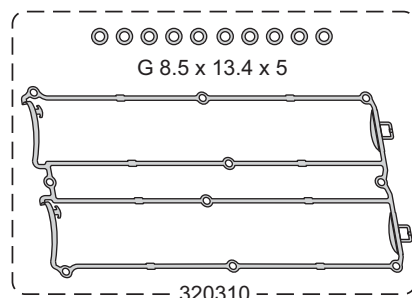

G 8.5 x 13.4 x 5

320310

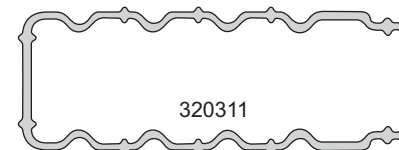

320311



320315/16

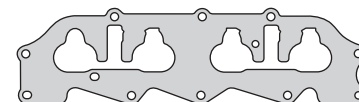

321517

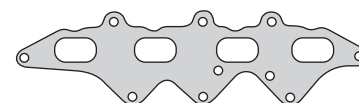

320329

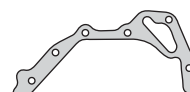

320312



320336



320314



320332



340833



320334



A 15 x 21 x 2A



320335



R320311V



R470013V



R320313V



R320310V

Nº OE	Descripción/Description	Mat.			Ref.
	Jgo. de juntas para motor				301200-R
	Jgo. de juntas superior		●		301295
	Jta. tapa cilindros Ø 77.5 ±1.60 <b>NR</b>	NFT	1	1	301207
	Jgo. tornillos tapa cilin. (HAT55055/55100)				B320300
1663394	Conj. junta tapa válvulas (11)	S	1	1	320310
7008824	Junta para cárter	N		1	320311
7378788	Frente bomba aceite	CB		1	320312
6691888	Bomba de agua	CB		1	320314
	Múltiple escape	AC	1		320315
7181761	Múltiple escape	NFT		1	320316
	Múltiple admisión	AL/GS	1	1	321517
1663383	Múltiple admisión	CB		1	320329
	Junta caja termostato	CB		1	320332
	Junta	SLS	1		340833
1663908	Chupador aceite	CB		1	320334
7090340	Mariposa gases	CB		1	320335
1663861	Bancada trasera	CB		1	320336
6759630	Anillo tapa válvulas G 8.5 x 13.4 x 5	GS	10	10	320337
	Arandela cárter A 15 x 21 x 2 A	AL		1	
	Kit de retenes completo				R320300
	Jgo. retén válvulas (16)	V		1	R320310V
	Retén bancada 88 x 108 x 10	V		1	R320311V
	Retén distribución 35 x 50 x 7	V		1	R470013V
	Retén árbol levas 42 x 53 x 7	V		2	R320313V

**FORD**



Motor/Engine Cm³ HP Ø

ZETEC (DOHC) 16V 1597 90 76

Ford: Escort, Orion 1992/...  
Fiesta 1994/95



Nº OE	Descripción/Description	Mat.		Ref.
	Jgo. de juntas para motor		●	301400-R
	Jgo. de juntas superior		●	301495
	Jta. tapa cilindros Ø 77.5 $\pm$ 1.60  NR	NFT	1 1	301207
	Jgo. tornillos tapa cilin. (HAT55055/55100)			B320300
1663394	Conj. junta tapa válvulas (11)	S	1 1	320310
7008824	Junta para cárter	N	1 1	320311
7378788	Frente bomba aceite	CB	1 1	320312
6691888	Bomba de agua	CB	1 1	320314
	Múltiple escape	AC	1 1	320315
7181761	Múltiple escape	NFT	1 1	320316
6669767	Bakelita aislante admisión	BAK	1 1	320317
1048093	Jgo. múltiple admisión (4) 1997/...	N	1 1	320517
1663383	Múltiple admisión	CB	1 1	320329
	Junta caja termostato	CB	1 1	320332
1663908	Chupador aceite	CB	1 1	320334
7090340	Mariposa gases	CB	1 1	320335
1663861	Bancada trasera	CB	1 1	320336
6759630	Anillo tapa válvulas G 8.5 x 13.4 x 5	GS	10 10	320337
	Arandela cárter A 15 x 21 x 2 A	AL	1	
	Kit de retenes completo			R320300
	Jgo. retén válvulas (16)	V	1 1	R320310V
	Retén bancada 88 x 108 x 10	V	1 1	R320311V
	Retén distribución 35 x 50 x 7	V	1 1	R470013V
	Retén árbol levas 42 x 53 x 7	V	2 2	R320313V

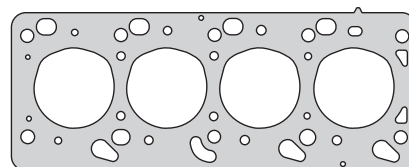

301207

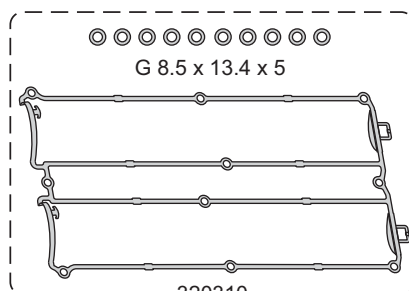

G 8.5 x 13.4 x 5

320310

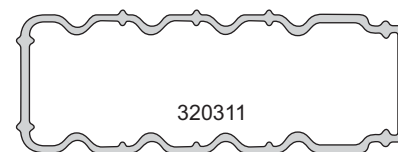

320311



320312

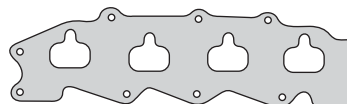

320314

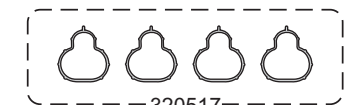

320315

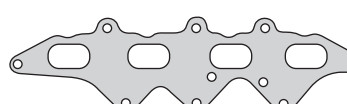

320316



320317



320517



320329

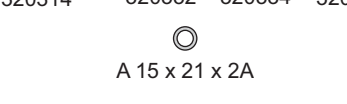

320332



320334

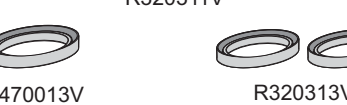

320335

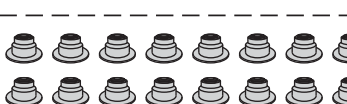

320336

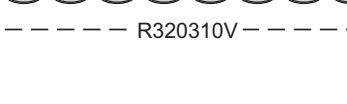

320337

A 15 x 21 x 2A



R320311V



R470013V



R320313V

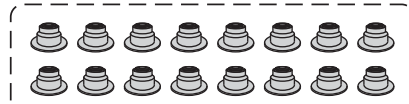

R320310V

**FORD**



Motor/Engine	Cm³	HP	Ø
ZETEC E EYDB/C/D/E/F G/I/J/L (DOHC) 16V	1796	116	80.6

Ford: Focus 1998/...



Nº OE	Descripción/Description	Mat.	Ref.
	Jgo. de juntas para motor		301500-R
	Junta tapa cilindros Ø 81.7 ± 1.20	NFT	1 301507
7114447	Junta tapa cilindros Ø 81.5 ± 1.20	MLS	301508
	Jgo. tornillos tapa cilindros (HAT55055/55100)		B320300
1061468	Conj. junta tapa válvulas (11)	N	1 301510
1078707	Junta para cárter	N	1 301511
1053902	Múltiple espape	AC	1 301515
1048093	Jgo. múltiple admisión 1997/... (4)	N	1 320517
	Junta sobre cárter	NB	1 301538
6974940	Guarnición base termostato	GS	320339
1092262	Guarnición termostato	GS	1 310940
	Kit de retenes completo		R301500
	Jgo. retén válvulas (16)	V	1 R320310V
	Retén bancada 88 x 108 x 10	V	1 R320311V
	Retén distribución 35 x 50 x 9	V	1 R550412V
	Retén árbol levas 42 x 53 x 7	V	2 R320313V

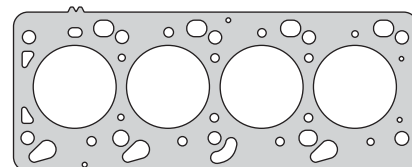

301507

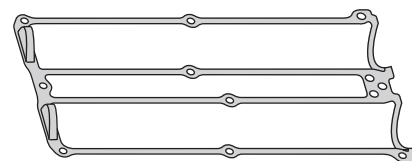

301510

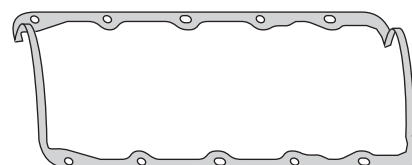

301511

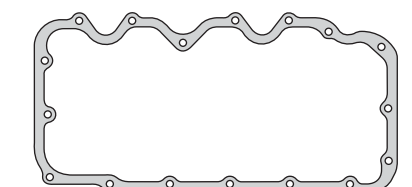

301538



301515

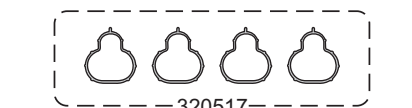

320517



320339

310940



R320311V



R550412V

R320313V



R320310V

**FORD**



Motor/Engine	Cm³	HP	Ø
140 F.I	2300		

Ford: Ghia 1991/..., Topaz 1989/94



Nº OE	Descripción/Description	Mat.	Ref.
	Jgo. de juntas para motor		301700-RMX
	Jgo. de juntas superior	●	301795
	Junta tapa de cilindros Ø 96.2 ±1.20	NFT 1 1	301705
	Junta tapa válvulas	CG 1 1	301710
	Junta para cárter	CG 1 1	301711
	Tapa distribución	NB 1 1	301812
	Jgo. múltiple escape (4)	NFT 1 1	301715
	Múltiple admisión	NFT 1 1	301717
	Junta carburador	CB 1 1	200028
	Junta	NB 1 1	301830
	Junta	NB 1 1	301831
	Junta	NB 1 1	301832
	Junta	NB 1 1	301733
	Junta	NB 1 1	301833
	Junta	NB 1 1	301834
	Arandela A 14 x 20 x 1.5 A	AL 1 1	
	Anillo G 10 x 16 x 2	GS 18 18	
	Arandela A 10 x 14 x 1.5 A	AL 10 10	
	Kit de retenes completo		R301800
	Jgo. retén válvulas (8)	P 1 1	R301810P
	Retén bancada 88 x 108 x 10	V 1 1	R320311V
	Retén distribución 45 x 63.8/77 x 10.8	S 1 1	R301712S

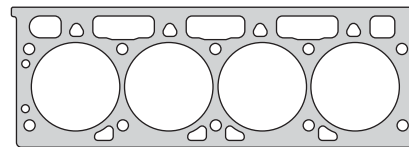

301705

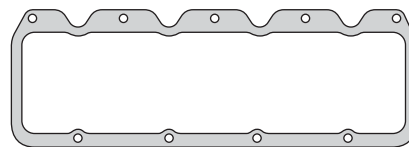

301710

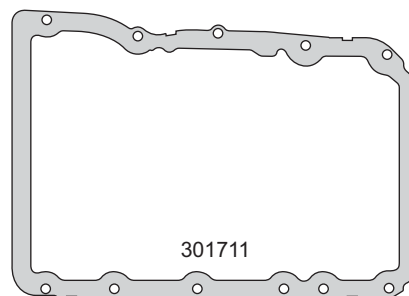

301711

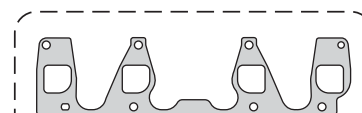

301717

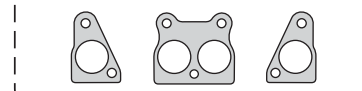

301715



301733

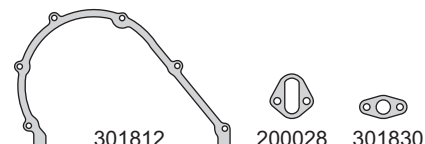

301812

200028

301830

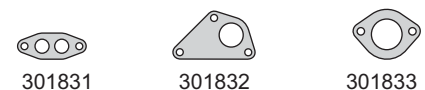

301831

301832

301833



301834

A 14 x 20 x 1.5 A

A 10 x 14 x 1.5 A

G 10 x 16 x 2



R320311V



R301712S



R301810P

**FORD****taranto**

Motor/Engine

Cm³

HP

Ø

Ford: Topaz, GS, GLX 1984/88

140 Carburado

2300

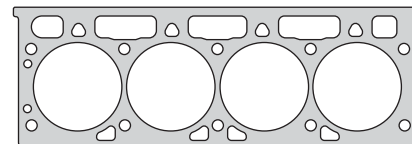

301705

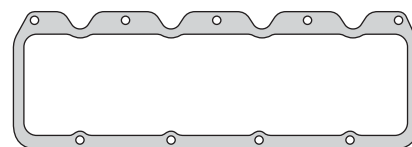

301710

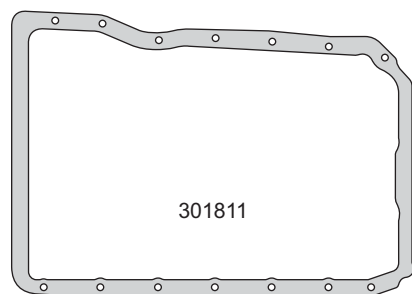

301811

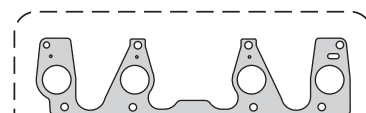

301817

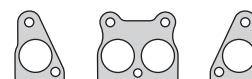

301815



301733

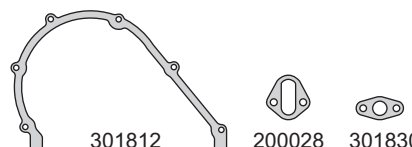

301812

200028

301830



301813

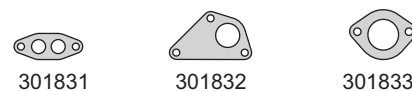

301831

301832

301833



301834



A 14 x 20 x 1.5 A

A 14 x 18 x 1.5 A



R320311V



R301712S



R301810P

Nº OE	Descripción/Description	Mat.	Ref.
	Jgo. de juntas para motor		● 301800-RMX
	Junta tapa cilindros Ø 96.2 ± 1.20	NFT	1 301705
	Junta tapa válvulas	CG	1 301710
	Junta para cárter	CG	1 301811
	Tapa distribución	NB	1 301812
	Junta	CG	1 301813
	Jgo. múltiple escape (4)	NFT	1 301815
	Múltiple admisión y escape	NFT	1 301817
	Junta carburador	CB	1 200028
	Junta	NB	1 301830
	Junta	NB	1 301831
	Junta	NB	1 301832
	Junta	NB	1 301733
	Junta	NB	1 301833
	Junta	NB	1 301834
	Arandela A 14 x 20 x 1.5 A	AL	1
	Arandela A 14 x 18 x 1.5 A	AL	1
	Kit de retenes completo		R301800
	Jgo. retén válvulas (8)	P	1 R301810P
	Retén bancada 88 x 108 x 10	V	1 R320311V
	Retén distribución 45 x 63.8/77 x 10.8	S	1 R301712S

**FORD**



Motor/Engine	Cm³	HP	Ø
232 V6 (OHV) 12V	3811	130	96.8

Ford: V6 3.8 (USA) Mustang, Taurus, Sable  
Thunderbird, Cougar 1985/87



Nº OE	Descripción/Description	Mat.		Ref.
	Jgo. de juntas para motor		●	301900-RMX
	Jgo. de juntas superior		●	301995
	Jgo. tapa cilin. Ø 99.0 ± 1.20 (2)	NFT	1 1	301905
	Jgo. tapa cilin. Ø 99.0 ± 1.20 (2)	NFT		301907
	Junta tapa valvulas	CG	2 2	301910
	Jgo. junta para cárter (2)	CG	1	301911
	Junta distribución	CB	1	320212
	Junta distribución	NB	1	320212-2
	Bomba de agua	CB	1	320214
	Bomba de agua	NB	1	320214-1
	Jgo. múltiple escape (2)	NFT	1 1	320215
	Jgo. multiple admisión (4)	NFT	1 1	301917
	Junta carburador	NB	1 1	301921
	Junta	NB	1	301922
	Junta tubo bomba de aceite	CB	1	320227
	Junta base bomba nafta	CB	1	200028
	Junta motor	NB	1	301930
	Sello múltiple admisión lateral	CG	1 1	320231
	Sello múltiple admisión frontal	CG	1 1	320232
	Kit de retenes completo			R320200
	Jgo. retén válvulas (12)	P	1	R320210P
	Retén bancada 92 x 108 x 9.8	P	1	R300311P
	Retén distribución 47 x 65/80 x 15	P	1	R340412P

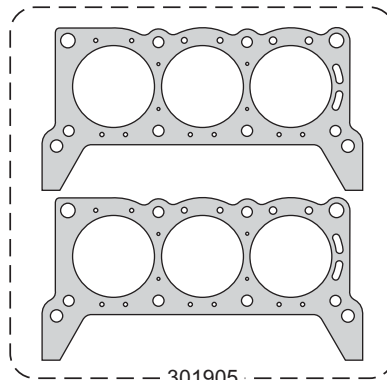

301905

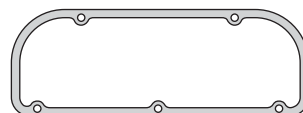

301910

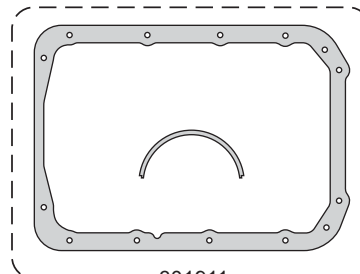

301911

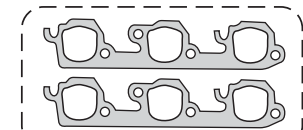

320215

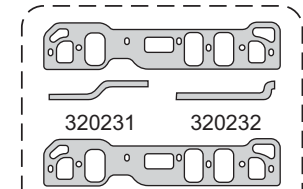

320231 320232

301917

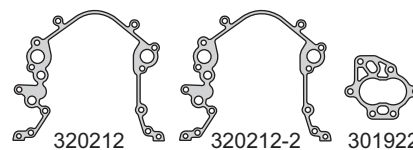

320212

320212-2

301922

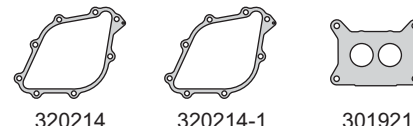

320214

320214-1

301921



320227

200028

301930



R300311P



R340412P



R320210P



**FORD**



Motor/Engine	Cm³	HP	Ø
Duratorq (DOHC) 16V	2402	120/125	89.9

Ford: Transit TD 2000/...

DIESEL



Nº OE	Descripción/Description	Mat.	Ref.
	Jgo. de juntas para motor		302001-R
	Junta tapa cilindros Ø 91.0 ± 1.10	NFT	302007-1M
	Junta tapa cilindros Ø 91.0 ± 1.15	NFT	302007-2M
	Junta tapa cilindros Ø 91.0 ± 1.20	NFT	302007-3M
1096227/1	Junta tapa cilindros Ø 91.0 ± 1.10	MLS	302008-1M
	Junta tapa cilindros Ø 91.0 ± 1.15	MLS	302008-2M
	Junta tapa cilindros Ø 91.0 ± 1.20	MLS	302008-3M
1102674/76	Jgo. tornillos tapa cilindros (HAS13038/17038)		B302000
1099778	Conj. junta tapa válvulas (5)	N	302010
1112953	Jgo. junta para cárter (2)	SLS	302011
	Junta para cárter	NB	303211
110268/1	Frente distribución	NB	302012
1121210	Distribución a block	SLS	302013
1096559	Apolo bomba de agua	SLS	302014
1120402	Múltiple escape	AC	302015
	Jgo. múltiple admisión (9)	N	302017
1098228	Guarnición termostato	N	302019
1721342	Sello filtro de aceite	GS	302027
1094599	Bomba inyectora	SLS	340328
1146959	Bomba vacío	SLS	302029
1105321	Chupador aceite	NB	302020
	Anillo cierre inyector	AC/GS	302030
1111912	Anillo refrigeración gases	SLS	302031
	Anillo admisión	N	302033
1754585	Junta tapa frontal	AL/GS	302034
1322526	Junta tubo refrigeración a block	SLS	302036
1794375	Junta bomba vacío	AC/GS	302044
4640315	Arandela sello retén de block A 28 x 39 x 2	AC/GS	
	Kit de retenes completo		R302000
1096253	Jgo. retén válvulas (16)	V	R302010V
1117435	Porta retén bancada	T	PR302011T
1201417	Porta retén distribución	V	PR302012V
1139357	Retén árbol de levas 35 x 50 x 7	V	R470013V

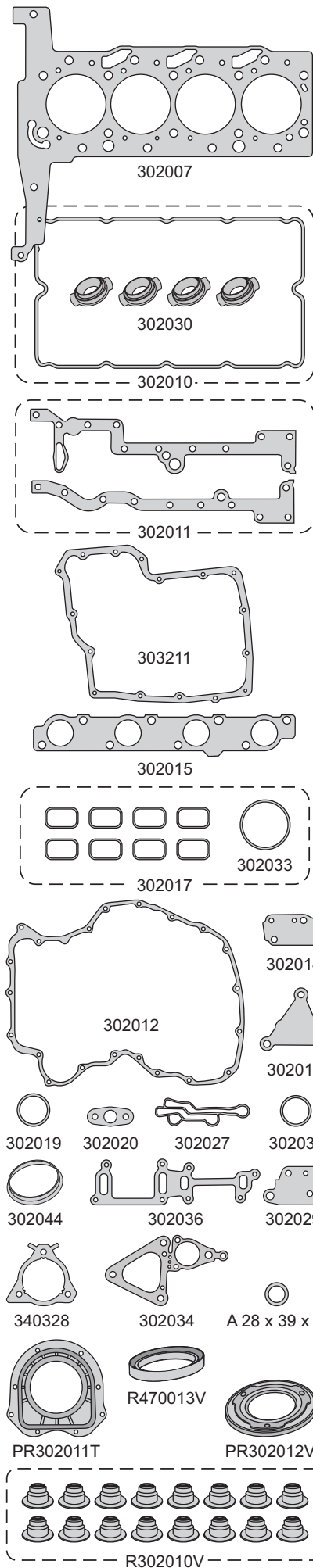

**FORD**



Motor/Engine	Cm³	HP	Ø
F6JA - F6JB	1398	68	74
DV4TD (8HX)	1398	70	74
DV4TD (8HZ) (SOHC) 8V	1398	68	74

**Citroën:** C3, C2 HDI, Xsara HDI 2002/...  
**Ford:** Fiesta, Eco Sport TD 2003/...  
 Duratorq TDCI  
**Peugeot:** 206 TDI, 307 HDI 2001/...



**DIESEL**

Nº OE	Descripción/Description	Mat.	1	2	Ref.
	Jgo. de juntas para motor				302101-R
	Jgo. de junta superior (MLS)		●		302195-1M MLS
	Jgo. de junta superior (MLS)				302195-2M MLS
	Jgo. de junta superior (MLS)				302195-3M MLS
	Jgo. de junta superior (MLS)				302195-4M MLS
	Jgo. de junta superior (MLS)				302195-5M MLS
	Jgo. junta superior sin JTC				302196
	Junta tapa cilindros Ø76.0 ± 1.20	NFT			302107-1M
	Junta tapa cilindros Ø76.0 ± 1.30	NFT			302107-2M
	Junta tapa cilindros Ø76.0 ± 1.40	NFT			302107-3M
	Junta tapa cilindros Ø76.0 ± 1.45	NFT			302107-4M
	Junta tapa cilindros Ø76.0 ± 1.50	NFT			302107-5M
1146049	Junta tapa cilindros Ø75.0 ± 1.25	MLS	1		302108-1M
1146050	Junta tapa cilindros Ø75.0 ± 1.30	MLS			302108-2M
1146051	Junta tapa cilindros Ø75.0 ± 1.35	MLS			302108-3M
1146052	Junta tapa cilindros Ø75.0 ± 1.40	MLS			302108-4M
1146053	Junta tapa cilindros Ø75.0 ± 1.45	MLS			302108-5M
0204.C5	Jgo. tornillos tapa cilindros (HAE14038)				B302100
1148101	Conj. junta tapa válvulas (6)	N	1	1	302110
12232358/1	Junta para cárter	NB		1	302111
1145938/1	Frente motor bomba aceite	NB		1	302112
	Bomba de agua	NB		1	302114
1152194	Múltiple escape	AC	1	1	302115
1148106	Jgo. múltiple admisión G 35 x 6 (4)	N	1	1	302117
2565/9451/AA/	Salida de escape	AC			302118
1145938	Anillo bomba aceite G 18 x 24 x 3	GS		1	302127
1145960	Chupador bomba aceite	P			302129
1145944	Jgo. anillo refrigerador aceite (4)	GS		1	302130
	Guarnición entrada filtro aceite	N		1	302131
	Guarnición salida filtro aceite	N		1	302132
	Junta	N	1	1	581036
	Jgo. juntas turbo (5)	VS			302140
	Junta acople turbo	AC			302141
	Junta base turbo	AC			302142
	Arandela A 10 x 14 x 1.25 C	CU			
	Arandela A 20 x 26 x 1.5 C	CU			
	O´ring G 28 x 4	S			
1210879	O´ring caja mariposa G 43 x 4	S	1	1	
	O´ring tapa válvulas G 6.5 x 1.5	GS	5	5	
	Kit de retenes completo				R302100
1145937	Jgo. retén válvulas (8)	V		1	R302110V
1142360	Retén bancada 85 x 105 x 8	V		1	R560111V
1145953	Retén árbol de levas 27 x 47 x 7	V		1	R470813V
1142359	Retén distribución 40 x 55 x 7	V		1	R270713V

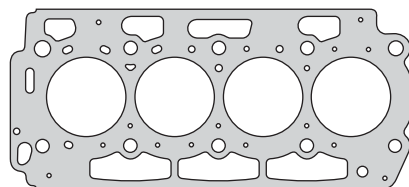

302107

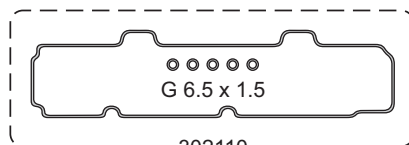

302110

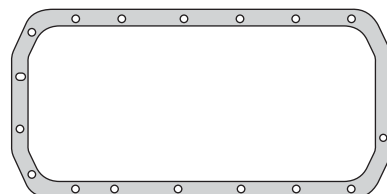

302111



302115



302117

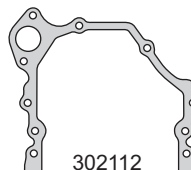

302112



302114



302118

302127

302131

302132

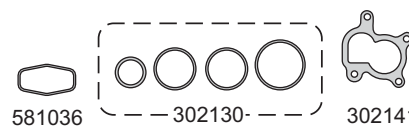

581036

302130

302141



302142

G 28 x 4

G 43 x 4



A 20 x 26 x 1.5 C

A 10 x 14 x 1.25 C



R560111V



R270713V



R470813V

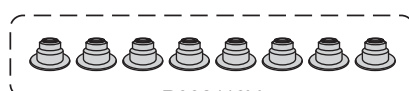

R302110V

**FORD**



Motor/Engine	Cm³	HP	Ø
CJBA	1999	145	87.5
Duratec HE/EFI	1999	143/145	87.5
LF	1999	104	87.5
L3 (DOHC) 16V	2261	104	87.5

**Ford:** Mondeo 2001/..., Eco Sport 2003/... BR  
Ranger 2.3 2001/..., Focus, Focus EXE  
**Mazda:** Mazda 6, MPV 2002/....



Nº OE	Descripción/Description	Mat.	Ref.
	Jgo. de juntas para motor		302200-R
	Jgo. de juntas superior	●	302295
	Jgo. de juntas superior (MLS)		302295 MLS
	Junta tapa cilindros Ø 89.0 ± 1.20	NFT 1 1	302207
	Junta tapa cilindros Ø 89.0 ± 0.40	MLS	302208
1220025	Jgo. tornillos tapa cilin. (HAT55055/55100)		B302200
1316023/1	Jgo. junta tapa válvulas (4)	N 1 1	302210
1142647/1	Junta para cárter	NB 1	302211
1119277	Frente motor	NB 1	302212
1S7Z-9448AA	O´ring bomba de agua G 63.09 x 3.53	GS 1 1	302214
1L5Z-9448-AB	Múltiple escape	AC 1 1	302215
1S71-9451AA	Jgo. múltiple admisión (7)	GS 1 1	302217
1S7Z-8255BC	Salida de escape	AC 1 1	302218
1S7Z-6659AA	Válvula termostática	N 1 1	302219
1S7Z-6B752AA	Base bomba aceite	SLS 1	302227
1S7Z-6840AA	Separador bomba aceite	N 1	302230
1119253	Base filtro aceite	SLS 1	302231
	Chupador bomba aceite	N 1	302232
1119275	Guarnición goma	N 1 1	302233
1S7Z-9F670AA	Conexión salida agua	SLS 1	302234
1S7Z-9E9360A	Válvula reguladora paso a paso	N 1 1	302235
1S7Z-943PAA	Válvula mariposa aceleración	N 1 1	302236
1S7G-6051BG	Junta admisión	N 4 4	302237
	Kit de retenes completo		R302200
1S7Z-6K301AA	Jgo. retén válvulas (16)	V 1	R302210V
1S7Z-6700AA	Porta retén bancada trasera	T	PR302211T
	Retén distribución 37 x 50 x 8	V 1	R302212V

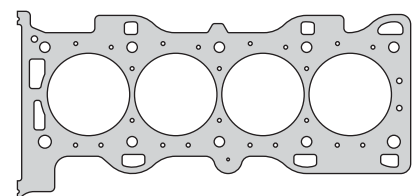

302207

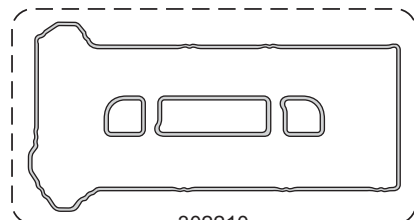

302210

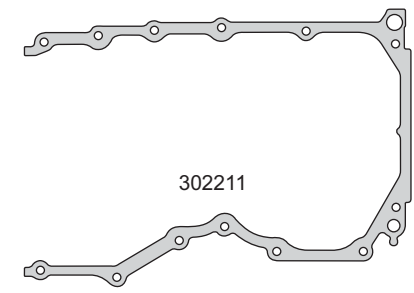

302211

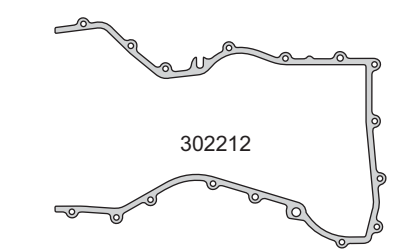

302212

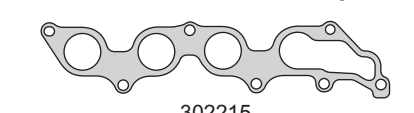

302215

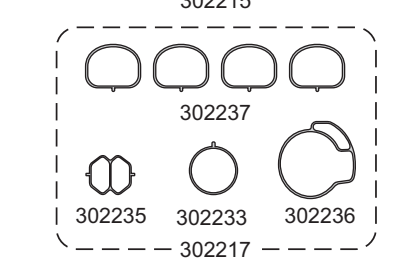

302237

302217

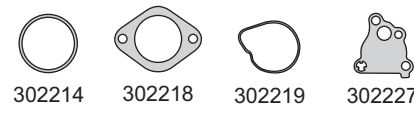

302214

302218

302219

302227

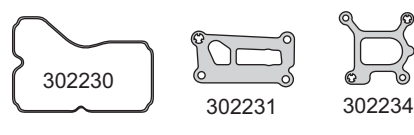

302230

302231

302234

302232

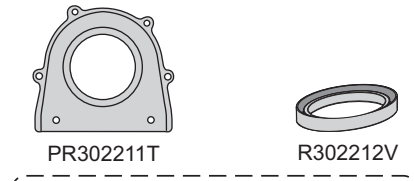

PR302211T

R302212V

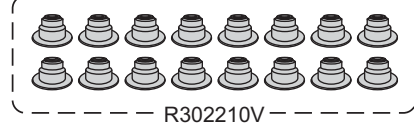











R302210V

**FORD****taranto**

Motor/Engine	Cm³	HP	Ø
EFI - NAI4 (SOHC) 8V	2500	117	96

Ford: Pick Up, Ranger 1997/...



Nº OE	Descripción/Description	Mat.	Ref.
	Jgo. de juntas para motor		302300-R
F47E-6051A5A	Junta tapa cilindros Ø 100.0 ± 1.30 	NFT	1 340607
	Jgo. tornillos tapa cilindros 		B302300
F57Z-6584A	Junta tapa de válvulas 	GS	1 340610
F87Z-6710A	Junta para cárter 	N	1 340611
F37Z-1448AB	Múltiple escape 	NFT	302315
E89E-3439A56	Múltiple admisión 	NFT	1 340617
F57Z-9H486C	Entre colectores 	NFT	302317
	Termostato	NFT	1 340619
F87Z-8255AA	Anillo termostato G 54 x 3 x 6.5	GS	302319
E57Z-9E936B	Base termostato	NB	302329
	Kit de retenes completo 		R302300
	Jgo. retén válvulas (8) 	P	1 R340610P
	Retén bancada 79.38 x 95.25 x 11.11 	V	1 R300611V
	Retén dist. y árbol de levas 43.41 x 56.02 x 9.3 	P	2 R300312P

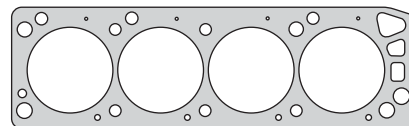

340607

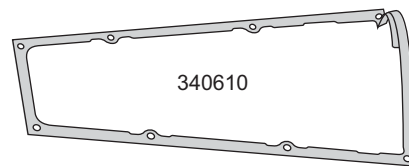

340610



340611



340617



340619



R300611V



R300312P



R340610P

**FORD**



Motor/Engine	Cm³	HP	Ø
CJBA	1999	143/145	87.5
Duratec HE/EFI	2261	145/154	87.5
LF (DOHC) 16V	1999	105/141	87.5

**Ford:** Mondeo 2001/..., Eco Sport 2003/... BR  
 Ford Ranger 2001/... BR  
 Maverick 2003/..., Focus, Focus EXE  
**Mazda:** Mazda 6 2002/..., Mazda 3 2003/...



Nº OE	Descripción/Description	Mat.	Ref.
	Jgo. de juntas para motor		302400-R
	Jgo. de juntas superior (MLS)		302495 MLS
1S7Z26051AA	Junta tapa cilindros Ø 89.0 ± 1.20 N.R.	NFT	1 302207
	Junta tapa cilindros Ø 89.0 ± 0.40 N.R.	MLS	1 302208
	Jgo. tornillos tapa cilin. (HAT55055/55100)		B302200
1S7Z6584AA	Conj. junta tapa válvulas (2)	N	1 302410
1316023/1	Junta para cárter	NB	1 302211
1142647/1	Frente motor	NB	1 302212
1119277	O'ring bomba de agua G 63.09 x 3.53	GS	1 1 302214
1S7Z-9448AA	Múltiple escape	AC	1 1 302215
	Jgo. múltiple admisión (6)	N	1 302217
1S71-9451AA	Salida de escape	AC	1 1 302218
1S7Z-8255BC	Válvula termostática	N	1 1 302219
1S7Z-6659AA	Base bomba aceite	SLS	1 302227
1S7Z-6B752AA	Separador bomba aceite	N	1 302230
1S7Z-6840AA	Base filtro aceite	SLS	1 302231
1119253	Chupador bomba aceite	N	1 302232
	Guarnición goma	N	1 1 302233
1119275	Conexión salida agua	SLS	1 302234
1S7Z-9F670AA	Válvula reguladora paso a paso	N	1 1 302235
1S7Z-9E9360A	Válvula mariposa aceleración	N	1 1 302236
1S7Z-943PAA	Junta admisión	N	4 4 302237
	Kit de retenes completo		R302200
1S7G-6051BG	Jgo. retén válvulas (16)	V	1 R302210V
1S7Z-6K301AA	Porta retén bancada trasera	T	PR302211T
1S7Z-6700AA	Retén distribución 37 x 50 x 8	V	1 R302212V

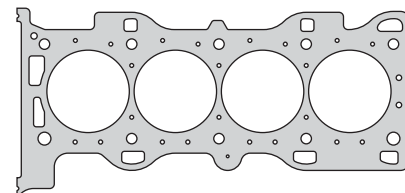

302207

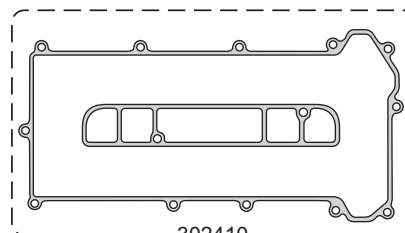

302410

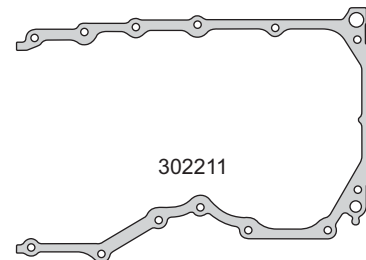

302211

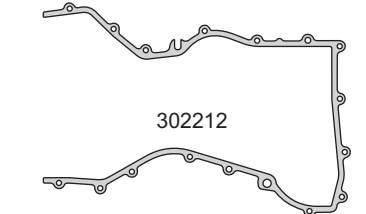

302212



302215

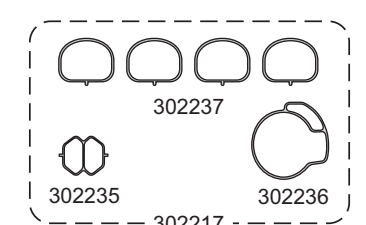

302237

302235

302236

302217

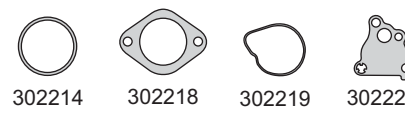

302214

302218

302219

302227

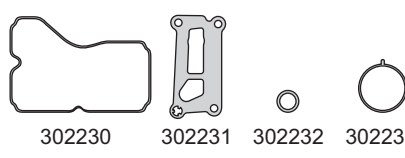

302230

302231

302232

302233



302234

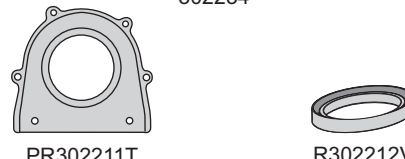

PR302211T

R302212V



R302210V

**FORD**



Motor/Engine	Cm³	HP	Ø
Duratec V6 LCBD V6 (DOHC) 24V	2495	170	81.6

Ford: Mystique, Contour 1995/00  
Mondeo 1994/00, Mondeo III 2000/...



Nº OE	Descripción/Description	Mat.	Ref.
	Jgo. de juntas para motor		302500-R
3922601/4028565	Jgo. junta tapa cilin. Ø 84.0 ± 1.60 (2)	NFT	302507
	Jgo. junta tapa cilin. Ø 83.0 ± 0.85 (2)	MLS	302508
	Jgo. tornillos tapa cilindros (HAS13038)		B302500
7381330	Junta tapa válvulas izquierda	N	302510-I
7381327	Junta tapa válvulas derecha	N	302510-D
4139726	Junta para cárter	AC/GS	302511
7224827	Junta distribución central	N	302512-1
7224828	Junta distribución izquierda	N	302512-2
7224826	Junta distribución derecha	N	302512-3
6691888	Bomba de agua	CB	320314
	Bomba de agua	NB	302514
4503102	Jgo. múltiple escape (2)	AC	302515
3902545	Jgo. múltiple admisión inferior (2)	PLAST	302517-1
3523225	Jgo. múltiple admisión superior (2)	PLAST	302517-2
13342711	Junta o ring termostato G 47.22 x 3.53	GS	302531
7318043	Junta válvula mariposa	NFT	302532
3699134	Junta abertura bujía	GS	302533
	Junta sello	AL/GS	302534
3780203	Junta o ring refrigerador aceite G 66.27 x 3.53	GS	302535
7156577	O ring tubo conector agua G 26.64 x 2.62	GS	6
	Kit de retenes completo		R302500
	Jgo. retén válvulas (24)	V	R302510V
F4AZ-6701A	Retén bancada 92 x 108 x 9.8	P	R300311P
F3AE-6700A	Retén distribución 47 x 63.4 x 8.8	P	R340712P

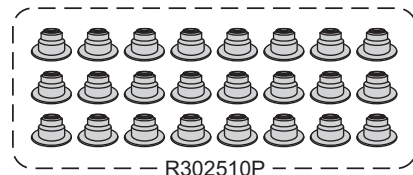
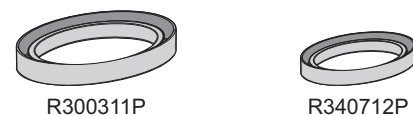
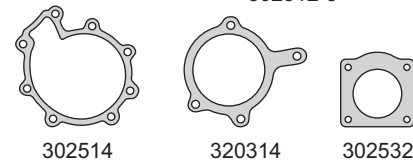
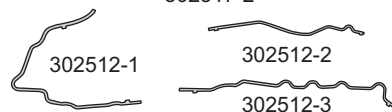
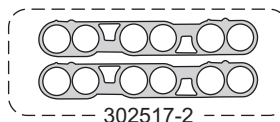
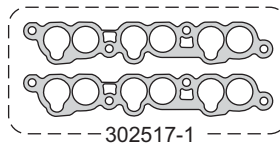
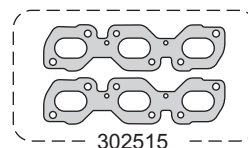
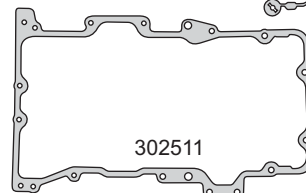
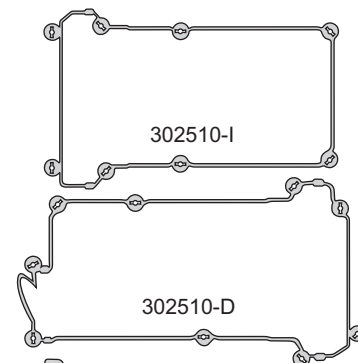
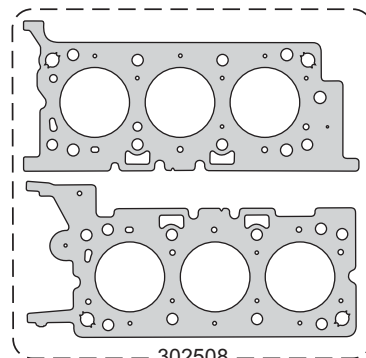

**FORD****taranto**

Motor/Engine

Cm³

HP

Ø

Triton 281 V8  
(SOHC) 16V

4600

180

92

**Ford:** E-Series, Mustang, Grand Marquis  
Crown Victoria, Pick Up F250 1997/99  
(incluye junta múltiple de admisión con  
ventana de gota)

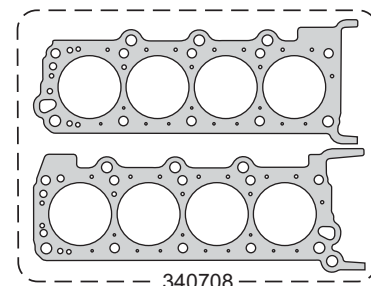

340708

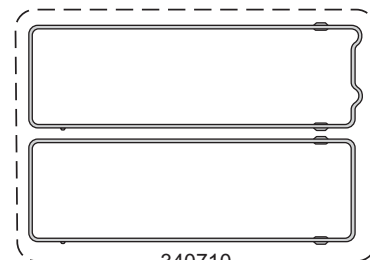

340710

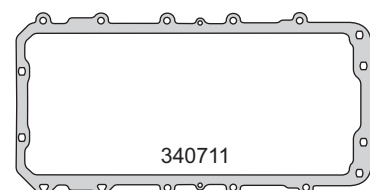

340711

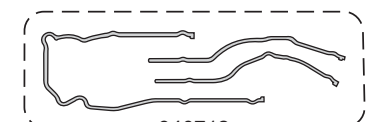

340712

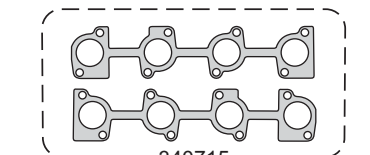

340715

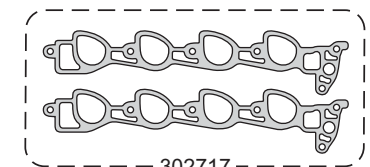

302717

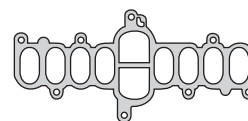

302732

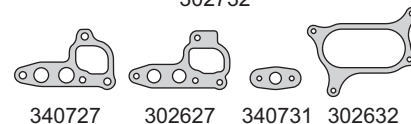

340727

302627

340731

302632



G 101.19 x 3.53

G 26.64 x 2.62

G 20.3 x 2.62

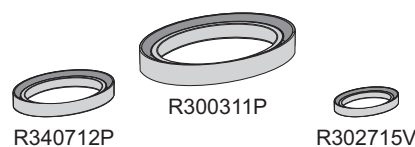

R340712P

R300311P

R302715V

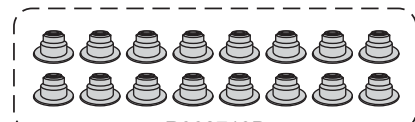

R302710P

Nº OE	Descripción/Description	Mat.	Ref.
	Jgo. de juntas para motor		● 302700-RMX
	Jgo. de juntas superior	●	302795
	Jgo. junta tapa cil. Ø 93 ± 1.30 (2)  N.R.	NFT	340707
	Jgo. junta tapa cil. Ø 92 ± 0.88 (2)  N.R.	MLS	1 1 340708
	Conj. junta tapa válvulas (2)	S	1 1 340710
	Junta para cárter	PLAST	1 340711
	Jgo. cierre distribución (3)	S	1 1 340712
	Jgo. múltiple escape (2)	NFT	1 1 340715
	Jgo. múltiple admisión (2)	PLAST	1 1 302717
	Base bomba aceite	PLAST	1 340727
	Base bomba aceite	PLAST	1 302627
	Junta varilla aceite	NFT	1 1 340731
	Junta entre colectores admisión	CB	1 1 302632
	Junta pleno admisión	PLAST	1 1 302732
	Junta o'ring tubo conector agua G 26.64 x 2.62	AL/GS	1 302534
	O'ring G 101.19 x 3.53	GS	1
	O'ring G 20.3 x 2.62	GS	1
	Kit de retenes completo		R302700
	Jgo. retén válvulas (16)	P	1 R302710P
	Retén bancada 92 x 108 x 9.8	P	1 R300311P
	Retén distribución 47 x 63.4 x 8.8	P	1 R340712P
	Retén auxiliar 47.63 x 63.5 x 8.5/12.3	V	1 R302715V

**FORD**



Motor/Engine **Cm³** **HP** **Ø**

**Triton 281 V8** **4600** **180** **92**  
(SOHC) 16V

**Ford:** E-Series, Mustang, Grand Marquis  
Crown Victoria, Pick Up F250 2000/03  
(incluye junta múltiple de admisión con  
ventana cuadrada)



Nº OE	Descripción/Description	Mat.		Ref.
	Jgo. de juntas para motor		●	302800-RMX
	Jgo. de juntas superior		●	302895
	Jgo. junta tapa cil. Ø 93 ±1.30 (2)	NFT		340707
	Jgo. junta tapa cil. Ø 92 ±0.88 (2)	MLS	1 1	340708
	Conj. junta tapa válvulas (2)	S	1 1	340710
	Junta para cárter	PLAST		340711
	Jgo. cierre distribución (3)	S	1 1	340712
	Jgo. múltiple escape (2)	NFT	1 1	340715
	Jgo. múltiple admisión (2)	PLAST	1 1	322617
	Base bomba aceite	PLAST		340727
	Base bomba aceite	PLAST		302627
	Junta varilla aceite	NFT	1 1	340731
	Junta entre colectores admisión	CB	1 1	302632
	Junta pleno admisión	PLAST	1 1	302732
	Junta o´ring tubo conector agua G 26.64 x 2.62	AL/GS		302534
	O´ring G 101.19 x 3.53	GS		
	O´ring G 20.3 x 2.62	GS		
	Kit de retenes completo			R302700
	Jgo. retén válvulas (16)	P	1	R302710P
	Retén bancada 92 x 108 x 9.8	P	1	R300311P
	Retén distribución 47 x 63.4 x 8.8	P	1	R340712P
	Retén auxiliar 47.63 x 63.5 x 8.5/12.3	V	1	R302715V

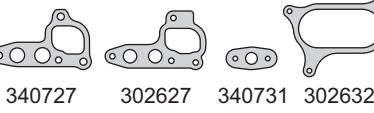
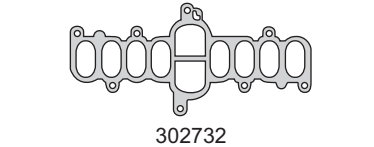
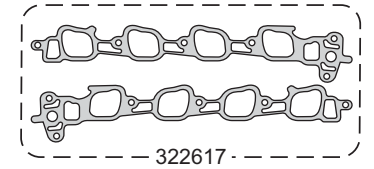
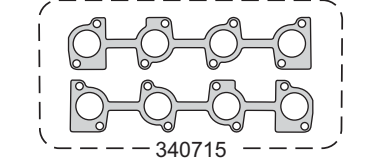
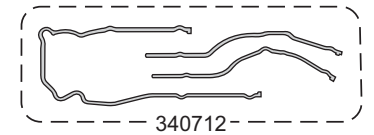
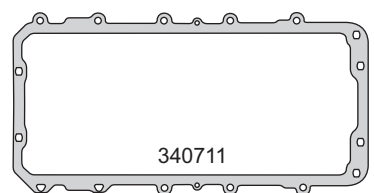
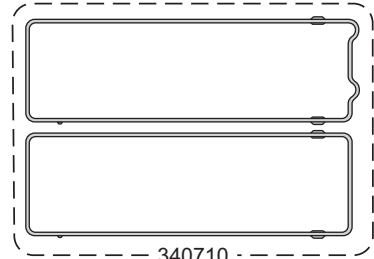
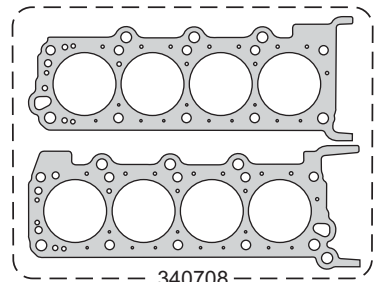



**FORD**



Motor/Engine	Cm³	HP	Ø
YF	1989	124	84.8
EDBA-EDBB	1989	124	84.8
EDBC-EDBD (DOHC) 16V	1989	131	84.8

Ford: Focus 1999/02  
Maverich 2000/... - Cougar 1999/...



Nº OE	Descripción/Description	Mat.	Ref.
	Jgo. de juntas para motor		302900-R
	Jgo. de juntas superior (MLS)		302995 MLS
1105772	Junta tapa cilindros Ø 87.0 ± 1.20 N.R.	NFT	1 301607
	Junta tapa cilindros Ø 86.0 ± 0.65 N.R.	MLS	1 301608
	Jgo. tornillos tapa cil. (HAT55055/HAT55100)		B320300
1126120	Junta tapa válvulas	GS	1 1 302910
1078307	Junta para cárter	N	1 301511
1211001	Frente y bomba de aceite	SLS	1 303312
1067759	O'ring bomba de agua G 69.44 x 3.53	GS	1 303314
1053902	Múltiple escape	AC	1 1 301515
1090949	Jgo. múltiple admisión 1999/... (4)	V	1 1 302917
1088965	Salida de escape	AC	302918
	Salida de escape a catalizador	AC	320918
1115070	Guarnición cierre bomba de agua	SLS	303319
958F/9F671/B	Válvula IAC reguladora marcha lenta	N	1 1 340133
978Z/6344AA	Junta bancada trasera	SLS	1 303334
7090340	Múltiple admisión a inyección	GS	303336
1053869/1	Junta sobre carter inferior	NB	1 301538
6974940	Guarnición base termostato	GS	320339
1092262	Guarnición termostato	GS	1 310940
	Kit de retenes completo		R320300
1086431/2	Jgo. retén válvulas (16)	V	1 R320310V
1045520	Retén bancada 88 x 108 x 10	V	1 R320311V
1102415	Retén distribución 35 x 50 x 7	V	1 R470013V
1063822	Retén árbol levas 42 x 53 x 7	V	2 R320313V

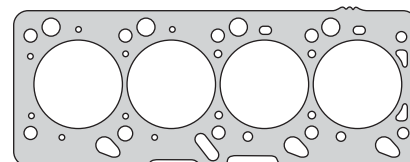

301607

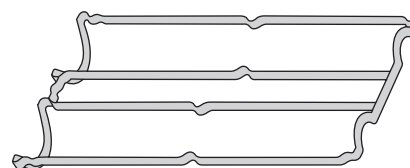

302910

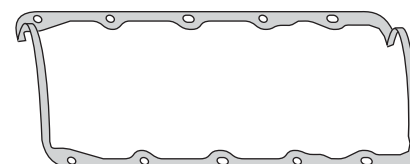

301511

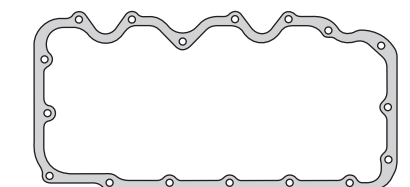

301538

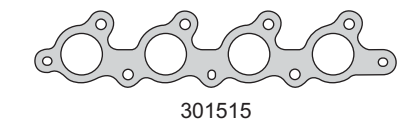

301515



302917



303312



303314



303319



340133



303334

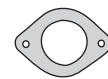

320918



320339



310940



R320311V



R470013V



R320313V

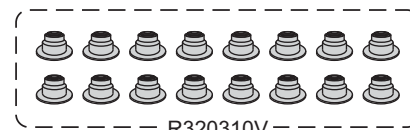

R320310V

**FORD**



Motor/Engine	Cm³	HP	Ø
Duratec SEA (DOHC) 24V	2544	170/173	82.4

Ford: Mondeo II 1994/00



Nº OE	Descripción/Description	Mat.	Ref.
	<b>Jgo. de juntas para motor</b>		<b>303000-R</b>
4129204/05	Jgo. junta tapa cil. Ø 83.5 ± 0.85 (2)	MLS	1 303008
3047926	Jgo. tornillos tapa cilindros (6 HAS13038)		B302500
7381330	Junta tapa de válvulas izq.	N	1 302510-I
7381327	Junta tapa de válvulas der.	N	1 302510-D
4139726	Junta para cárter	GS/AL	1 302511
7224827	Junta distribución central	N	1 302512-1
7224828	Junta distribución izq.	N	1 302512-2
7224826	Junta distribución der.	N	1 302512-3
4503102	Jgo. múltiple escape (2)	AC	1 302515
3902545	Jgo. múltiple admisión inf. (2)	PLAST	1 302517-1
3523225	Jgo. múltiple admisión sup. (2)	PLAST	1 302517-2
13342711	O´ring termostato G 47.22 x 3.53	GS	1 302531
7318043	Junta válvula mariposa	NFT	1 302532
3699184	Junta abertura bujía	S	6 302533
7156577	O´ring tubo conector agua G 26.64 x 2.62	GS	6 302534
3780203	O´ring refrigerador aceite G 66.27 x 3.53	GS	1 302535
	Kit de retenes completo		R303000
	Jgo. retén válvulas (24)	V	1 R302510V
F4AZ.6701.A	Retén bancada 92 x 107.58 x 9.5	V	1 R302511V
F3AE.6700.A	Retén distribución 47 x 63.4 x 8.8	P	1 R340712P

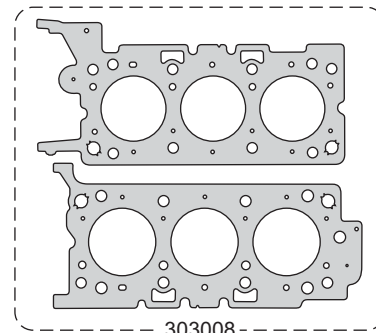

303008

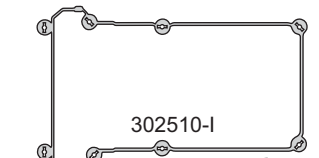

302510-I

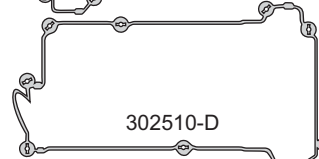

302510-D

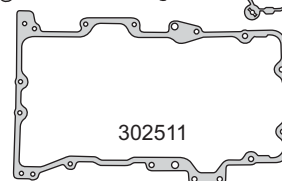

302511

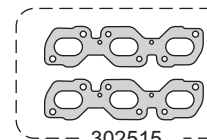

302515

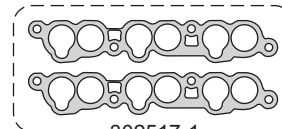

302517-1

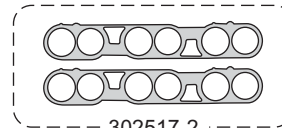

302517-2

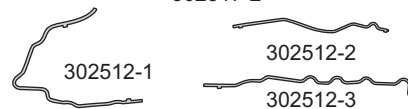

302512-1

302512-2

302512-3

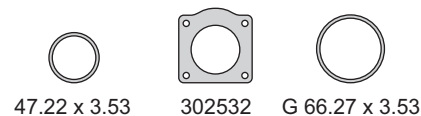

47.22 x 3.53

302532

G 66.27 x 3.53



302533



G 26.64 x 2.62



R302511V



R340712P

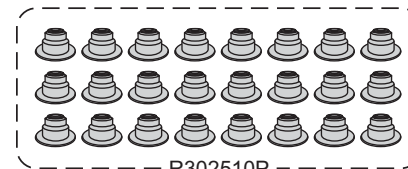

R302510P

**FORD****taranto**

Motor/Engine

Cm³

HP

Ø

Ford: Mondeo V6, ST 2.20 2003/...

Duratec V6  
MEBA V6  
(DOHC) 24V2967  
2967226  
22689  
89

Nº OE	Descripción/Description	Mat.	Ref.
	Jgo. de juntas para motor		303100-R
4.44.9245/3561	Jgo. junta tapa cil. Ø 91.5 $\pm$ 0.85 (2)	MLS	1 303108
73.8133G	Jgo. tornillos tapa cilindros (HAS13038)		B302500
73.8133G	Junta tapa válvulas izq.	N	1 302510-I
73.81327	Junta tapa válvulas der.	N	1 302510-D
4139726	Junta para cárter	GS/AL	1 302511
7224827	Junta distribución central	N	1 302512-1
7224828	Junta distribución izq.	N	1 302512-2
7224826	Junta distribución der.	N	1 302512-3
4503102	Jgo. múltiple escape (2)	AC	1 302515
4406061	Jgo. múltiple admisión (2) sup.	PLAST	1 303117-1
4367441	Jgo. múltiple admisión (2) inf.	PLAST	303117-2
13342711	O'ring termostato G 47.22 x 3.53	GS	1 302531
7318043	Junta válvula mariposa	NFT	1 302532
3699184	Junta abertura bujías	S	6 302533
7156577	O'ring tubo conector agua G 26.64 x 2.62	GS	6 302534
3780203	O'ring refrig. aceite G 66.27 x 3.53	GS	1 302535
	Kit de retenes completo		R303000
	Jgo. retén válvulas (24)	V	1 R302510V
F4A2.6701A	Retén bancada 92 x 107.58 x 9.5	V	1 R302511V
F3AE.6700A	Retén distribución 47 x 63.4 x 8.8	P	1 R340712P

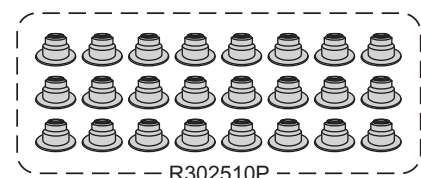
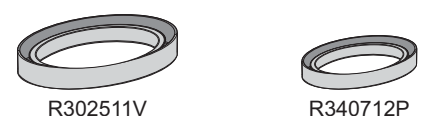
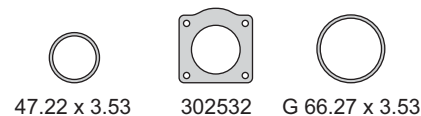
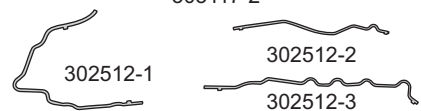
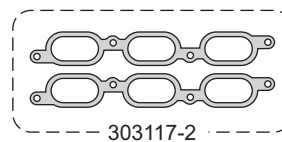
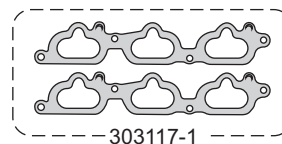
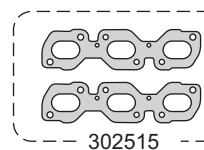
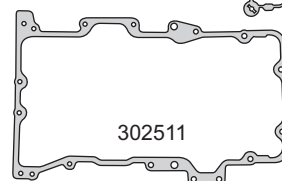
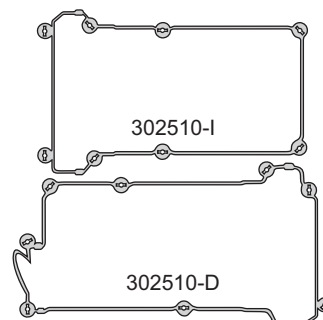
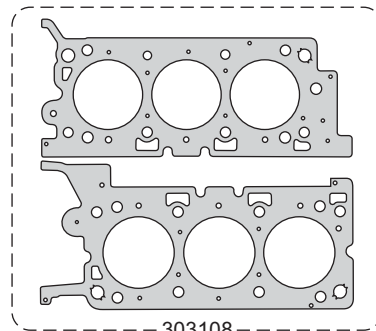

**FORD**



Motor/Engine	Cm³	HP	Ø
HJBA/B/C	1998	85	86
F3FA/F1FA	1998	85/125	86
ABFA/D3FA	1998	75/100	86
D5BA/D6BA (DOHC) 16V	1998	90/115	86

**Ford:** Mondeo TDCI 2000/02 - 2002/...  
 Mondeo III DI 2002/02  
 Transit TDI/TDCI 2000/02 - 2002/...  
 Transit DI 2000/02 - Duratorq



**DIESEL**

Nº OE	Descripción/Description	Mat.	Ref.
	Jgo. de juntas para motor		303201-R
	Jgo. de juntas superior		303295
	Jta. tapa cilindros Ø 87.0 ± 1.10	NFT	303207-1M
	Jta. tapa cilindros Ø 87.0 ± 1.15	NFT	303207-2M
	Jta. tapa cilindros Ø 87.0 ± 1.20	NFT	303207-3M
1250940	Jta. tapa cilindros Ø 87.0 ± 1.10	MLS	303208-1M
1250941	Jta. tapa cilindros Ø 87.0 ± 1.15	MLS	303208-2M
1250942	Jta. tapa cilindros Ø 87.0 ± 1.20	MLS	303208-3M
1102674/76	Jgo. tornillos tapa cilin. (HAS13038/17038)		B302000
1198000	Junta tapa válvula	N	302010
1112953	Jgo. junta para cárter (2)	SLS	302011
	Junta para cárter	NB	303211
11026811	Frente distribución	NB	302012
1121210	Placa tapa delantera distribución	SLS	302013
1116916	Bomba de agua	SLS	303214
1120402	Múltiple escape	AC	302015
1118392	Jgo. múltiple admisión (9)	N	302017
	Salida de escape	AC	302218
1116663	Tubo escape delantero	AC	303218
11098228	Guarnición termostato	N	302019
1225037	Base bomba inyectora	SLS	340328
1107482	Anillo enfriador aceite G 20 x 26 x 4	GS	303229
1130211	Refrigeración recirculación gases	MLS	303230
1203025	Entre válvulas vacío y refrigeración gases	MLS	303231
1114784	Convertidor de escape	AC	303232
	Anillo unión admisión	N	302033
1130311	O´ring caja termostato G 38 x 4	GS	303233
	Kit de retenes completo		R302000
1096253	Jgo. retén válvulas (16)	V	R302010V
1117435	Porta retén bancada	T	PR302011T
1201417	Porta retén distribución	V	PR302012V
1139357	Retén árbol de levas 35 x 50 x 7	V	R470013V

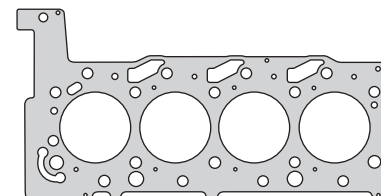

303208

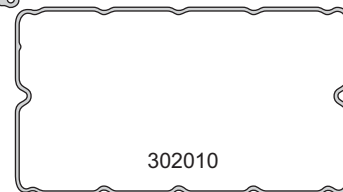

302010

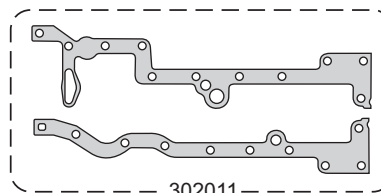

302011

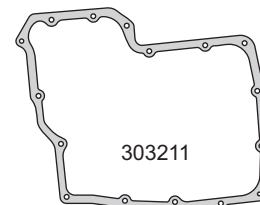

303211

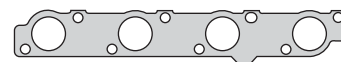

302015

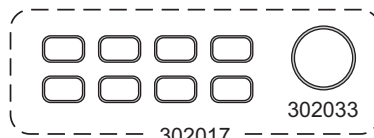

302033

302017

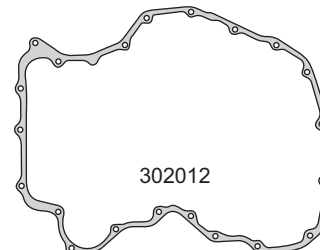

302012

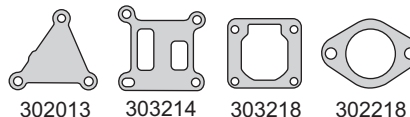

302013

303214

303218

302218



G 38 x 4

302019

340328

303232

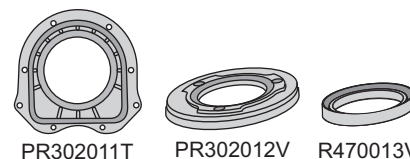

PR302011T

PR302012V

R470013V



R302010V

**FORD****taranto**

Motor/Engine

Cm³

HP

Ø

Ford: Focus 1998/04, Transit 2002/...

ZETEC-E SFI  
EYDB/C/D/E/F  
G/I/J/L  
(DOHC) 16V

1796

116

80.6



Nº OE	Descripción/Description	Mat.	Ref.
	Jgo. de juntas para motor		303300-R
1308083	Junta tapa cilindros Ø 81.7 $\pm$ 1.20	NFT	1 301507
	Junta tapa cilindros Ø 81.5 $\pm$ 1.20	MLS	301508
	Jgo. tornillos tapa cilindros (HAT55055/55100)		B320300
1126120	Junta tapa válvulas	GS	1 302910
1078307	Junta para cárter	N	1 301511
1211001	Frente y bomba de aceite	SLS	1 303312
1067759	O'ring bomba de agua G 69.44 x 3.53	GS	1 303314
1053902	Múltiple escape	AC	1 301515
1090949	Jgo. múltiple admisión 1999/... (4)	V	1 302917
1088965	Salida de escape	AC	302918
1115070	Guarnición cierre bomba de agua	SLS	303319
958F/9F671/B	Válvula IAC reguladora marcha lenta	N	1 340133
978Z/6344AA	Junta bancada trasera	SLS	1 303334
1053869/1	Junta sobre carter inferior	NB	1 301538
6974940	Guarnición base termostato	GS	320339
1092262	Guarnición termostato	GS	1 310940
	Kit de retenes completo		R320300
1086431/2	Jgo. retén válvulas (16)	V	1 R320310V
1045520	Retén bancada 88 x 108 x 10	V	1 R320311V
1102415	Retén distribución 35 x 50 x 7	V	1 R470013V
1063822	Retén árbol levas 42 x 53 x 7	V	2 R320313V

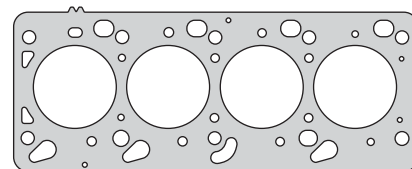

301507

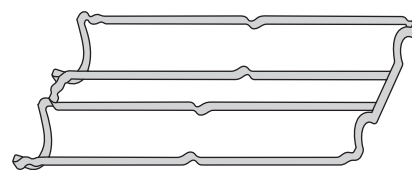

302910

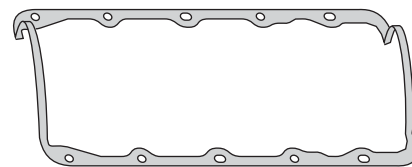

301511

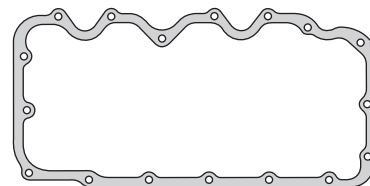

301538



301515



302917



303312



303314



303319



340133



303334



320339



310940



R320311V



R470013V



R320313V

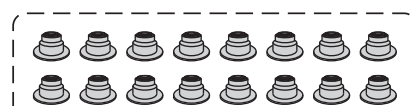

R320310V

**FORD**



Motor/Engine Cm³ HP Ø

**MGDA Duratec (DOHC) 16V** 1999 170 87.5

Ford: Focus 2011..., Mondeo 2013/...



Nº OE	Descripción/Description	Mat.	Ref.
	<b>Jgo. de juntas para motor</b>		● 303400-R MLS
	<b>Junta tapa cilindros Ø 90.0 ± 1.20</b>	NFT	303407
	<b>Junta tapa cilindros Ø 89.5 ± 0.50</b>	MLS	1 303408
<b>1220025</b>	<b>Jgo. tornillos tapa cilindros (HAT55055/55100)</b>		<b>B302200</b>
1316023/1	Jgo. junta tapa válvulas (6)	N	1 303410
1142647/1	Junta para cárter	NB	1 302211
1119277	Frente motor	NB	1 302212
1S7Z-9448AA	O´ring bomba de agua G 63.09 x 3.53	GS	1 302214
	Múltiple escape	AC	1 303415
1S71-9451AA	Jgo. múltiple admisión (7)	GS	1 302217
1S7Z-8255BC	Salida de escape	AC	1 302218
1S7Z-6659AA	Válvula termostática	N	1 302219
1S7Z-6B752AA	Base bomba aceite	SLS	1 302227
1S7Z-6840AA	Separador bomba aceite	N	1 302230
	Anillo cierre inyector	P	2 R303430P
1119253	Base filtro aceite	SLS	1 302231
	Chupador bomba aceite	N	1 302232
	Guarnición goma	GS	1 303432
1119275	Guarnición goma	N	1 302233
	Guarnición goma	GS	1 303433
1S7Z-9F670AA	Conexión salida agua	SLS	1 302234
1S7Z-9E9360A	Válvula reguladora paso a paso	N	1 302235
1S7Z-943PAA	Válvula mariposa aceleración	N	1 302236
1S7G-6051BG	Junta admisión	N	4 302237
	Kit de retenes completo		R302200
1S7Z-6K301AA	Jgo. retén válvulas (16)	V	1 R302210V
1S7Z-6700AA	Porta retén bancada trasera	T	PR302211T
	Retén distribución 37 x 50 x 8	V	1 R302212V

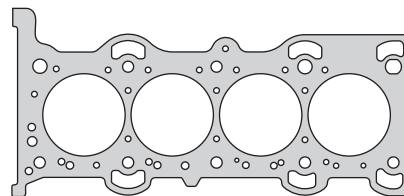

303408

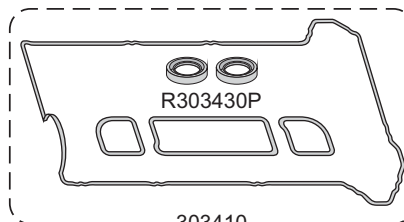

303410

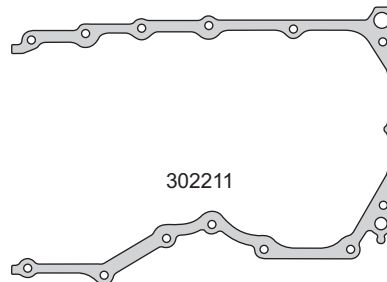

302211

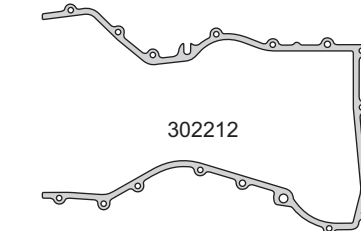

302212



303415

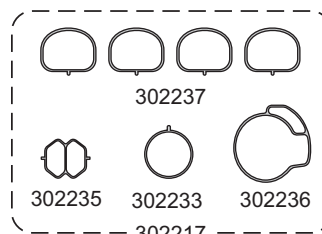

302237



302217

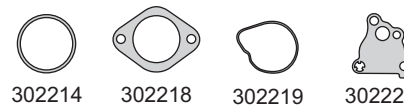

302214 302218 302219 302227

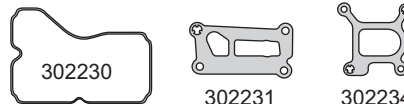

302230 302231 302234



303432 302232 303433

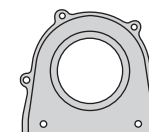

PR302211T



R302212V

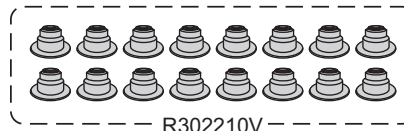

R302210V

**FORD**



Motor/Engine	Cm³	HP	Ø
AJ25 - LDBE V6 (DOHC) 24V	2495	170	81.6

Ford: Mondeo III 2002/...



Nº OE	Descripción/Description	Mat.	Ref.
	Jgo. de juntas para motor		303500-R
	Jgo. de juntas superior		303595
	Jgo. jta. tapa cil. Ø 83 ± 0.80 (2)	MLS	1 1 303508
7381330	Junta tapa válvulas izquierda	N	1 1 302510-I
7381327	Junta tapa válvulas derecha	N	1 1 302510-D
4139726	Junta para cárter	AC/GS	1 302511
7224827	Junta distribución central	N	1 302512-1
7224828	Junta distribución izquierda	N	1 302512-2
7224826	Junta distribución derecha	N	1 302512-3
	Bomba de agua	NB	1 302514
6691888	Bomba de agua	CB	1 320314
4503102	Jgo. múltiple escape (2)	AC	1 1 302515
3902545	Jgo. múltiple admisión inferior (2)	PLAST	1 1 302517-1
3523225	Jgo. múltiple admisión superior (2)	PLAST	1 1 302517-2
13342711	Junta o´ring termostato G 47.22 x 3.53	GS	1 302531
7318043	Junta válvula mariposa	NFT	1 1 302532
3699134	Junta abertura bujía	S	6 6 302533
	Guarnición	AC/GS	1 302534
3780203	Junta o´ring refrigerador aceite G 66.27 x 3.53	GS	1 302535
7156577	O´ring tubo conector agua G 26.64 x 2.62	GS	6 6
	Kit de retenes completo		R303000
	Jgo. retén válvulas (24)	V	1 R302510V
F4AZ-6701A	Retén bancada 92 x 107.58 x 9.5	V	1 R302511V
F3AE-6700A	Retén distribución 47 x 63.4 x 8.8	P	1 R340712P

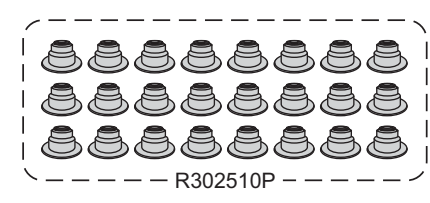
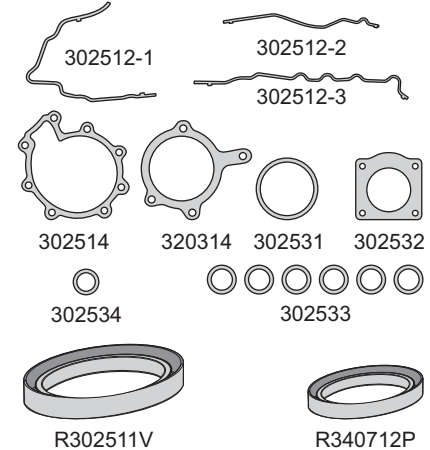
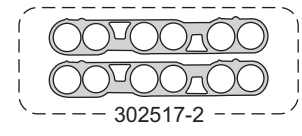
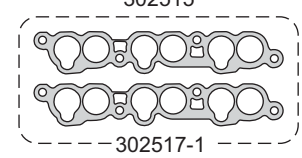
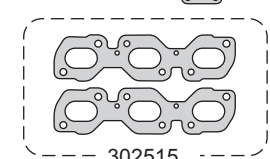
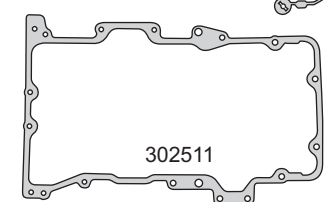
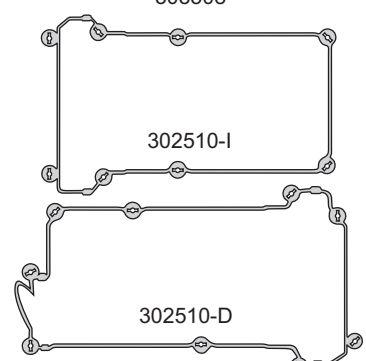
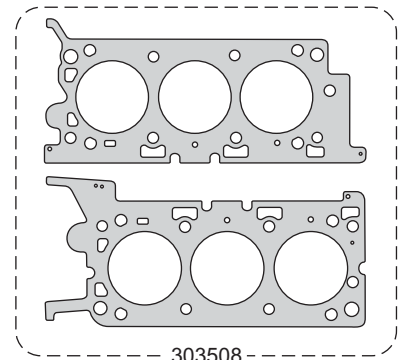

**FORD**



Motor/Engine	Cm³	HP	Ø
L4 122	1993	72	96
L4 140 (SOHC) 8V	2302	86	96

Ford: Ranger, Pinto, Taunus  
Sierra, Capri, Granada 1974/86



Nº OE	Descripción/Description	Mat.	Ref.
	Jgo. de juntas para motor		303600-R
76BR6051A	Junta tapa cilindros Ø 98.0 ± 1.40	NFT 1	300405
	Junta tapa cilindros Ø 98.0 ± 1.40  N.R.	NFT	300407
	Jgo. tornillos tapa cilindros (HAD19038)		B300300
74BR6584CE	Junta tapa válvulas	CG 1	300310
	Jgo. junta para cárter (4)	CG 1	300311
74BR6020A	Tapa distribución	NB 1	300312
74BR8507A	Bomba de agua	NB 1	300314
78BR9448A	Múltiple escape	NFT 1	300316
74BR9439A	Múltiple admisión	NB 1	300317
	Múltiple admisión sierra	NB 1	300417
	Salida de escape SP	GFT 1	300418-1
74BR8255A	Salida agua termostato	CB 1	300319
74BR6625A	Bomba aceite a block	NB 1	300327
74BR9417A	Base bomba nafta	CB 1	200028
	Tubo llenado aceite	NB 1	300329
	Junta	NH 1	300430
	Junta válvulas E.G.R.	NFT 1	321030
	Junta	NFT 1	300431
	Junta	NB 1	300432
	Junta	GS 1	300433
	Junta	GS 2	300434
	Junta	CB 1	340632
	Junta	CB 1	322433
	Junta	NFT 1	322234
	Junta	NFT 1	300435
	Kit de retenes completo		R303600
	Jgo. retén válvulas (8)	P 1	R300310P
	Retén bancada 92 x 106 x 5	P 2	R321811P
	Retén distribución 43.41 x 56.02 x 9.3	P 3	R300312P

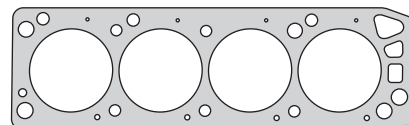

300405

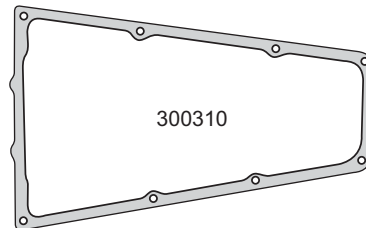

300310

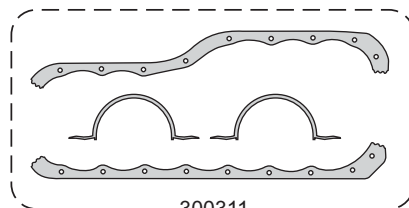

300311



300316



300317



300417

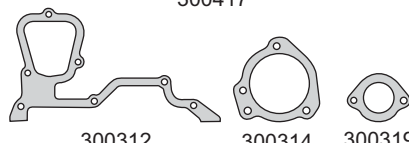

300312

300314

300319

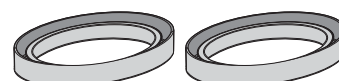
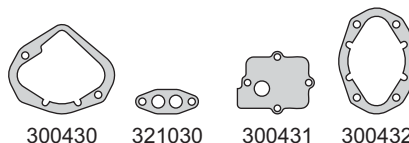

R321811P



R300312P

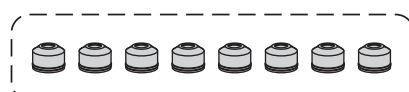

R300310P



**FORD**



Motor/Engine **Cm³** **HP** **Ø**

**GBVAF**  
**GBVAL**  
**GBVAK**  
(DOHC) 16V

**2495**    **166**    **89**

Ford: Ranger 2011/..



Nº OE	Descripción/Description	Mat.	Ref.
	Jgo. de juntas para motor		● 303800-R MLS
	Jgo. de juntas superior	●	303895 MLS
	Jta. tapa cilindros Ø 90.0 $\pm$ 1.40	NFT	303807
	Jta. tapa cilindros Ø 91.0 $\pm$ 0.60	MLS 1 1	303808
1220025	Jgo. tornillos tapa cilin. (HAT55055/55100)		B302200
1316023/1	Jgo. junta tapa válvulas (4)	N 1 1	302210
1142647/1	Junta para cárter	NB 1	302211
1119277	Frente motor	NB 1	302212
1S7Z-9448AA	O´ring bomba de agua G 63.09 x 3.53	GS 1	302214
1L5Z-9448-AB	Múltiple escape	AC 1 1	302215
1S71-9451AA	Jgo. múltiple admisión (6)	GS 1	303817
	Salida de escape	AC 1 1	303818
1S7Z-6659AA	Válvula termostática	N 1 1	302219
1S7Z-6840AA	Separador bomba aceite	N 1	302230
1119253	Base filtro aceite	SLS 1	302231
1119275	Guarnición goma	N 1 1	302233
	Guarnición goma	GS 1	303432
1S7Z-9F670AA	Conexión salida agua	SLS 1	302234
1S7Z-943PAA	Válvula mariposa aceleración	N 1 1	303836
1S7G-6051BG	Junta admisión	N 4 4	302237
	Junta válvula EGR	SLS 1 1	303839
	Tapón conducto admisión	V 1 1	303841
	Tapón conducto admisión	P 1 1	303842
	Junta colector escape a turbo	FCH 1 1	303845
	Kit de retenes completo		R302200
1S7Z-6K301AA	Jgo. retén válvulas (16)	V 1	R302210V
1S7Z-6700AA	Porta retén bancada trasera	T	PR302211T
	Retén distribución 37 x 50 x 8	V 1	R302212V

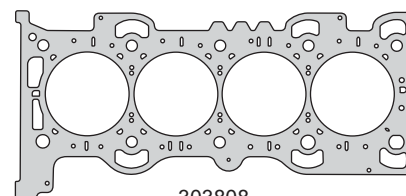

303808

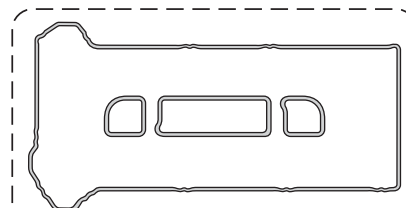

302210

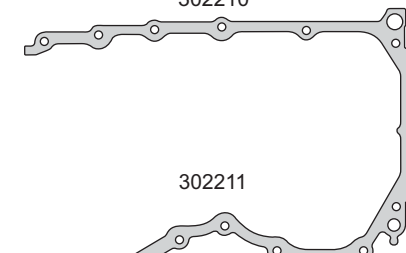

302211

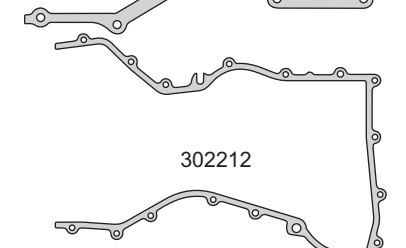

302212



302215

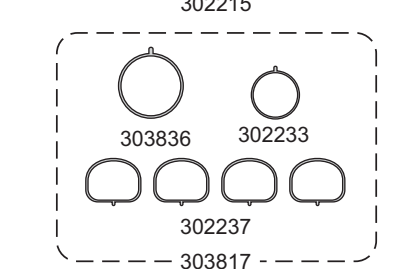

303836

302233

302237

303817



302214

303818

302219

303432

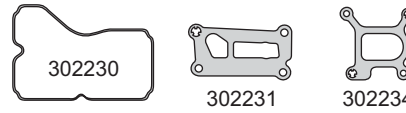

302230

302231

302234



303839

303841

303842

303845

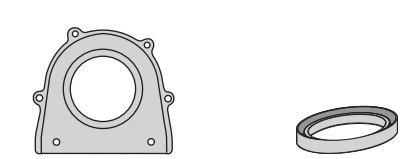

PR302211T

R302212V

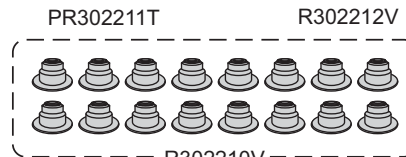

R302210V

**FORD**



Motor/Engine	Cm³	HP	Ø
Ecoboost 16V	1999	248	87.5

Ford: Fusión 2016/..., Bronco 2021/...  
Maverick 2022/...



Nº OE	Descripción/Description	Mat.	Ref.
	Jgo. de juntas para motor		● 303900-RMLS
FB5Z6051A	Junta tapa cilindros Ø 89.0 ± 0.90	MLS	1 303908
DM5Z6065B	Jgo. tornillos tapa cilindros (HAT55055/55100)		B302200
BB5Z6584A	Jgo. junta tapa de válvulas (6)	GS	1 303910
1S7G8507AF	O´ring bomba de agua G 63.09 x 3.53	SLS	1 302214
EJ7Z9448B	Múltiple de escape	GS	1 303915
CJ5Z9439A	Jgo. múltiple de admisión	GS	1 303917
3M4Z8255A	Junta termostato	GS	1 303919
FB5Z6840A	Junta soporte filtro de aceite	GS	1 303929
1S7Z6659AA	Base bomba de aceite	SLS	1 302227
1S7Z6B752AA	Separador bomba de aceite	GS	1 302230
BR3Z6C535B	Junta sello tapa válvulas	GS	2 303930
9L8Z9E936A	Junta TBI	GS	1 303932
	Kit de retenes completo		R302200
	Jgo. retén válvulas (16)	V	1 R302210V
1S7Z6K301BA	Porta retén bancada trasera	T	1 PR302211T
CM5Z6700C	Retén distribución 37 x 50 x 8	V	1 R302212V

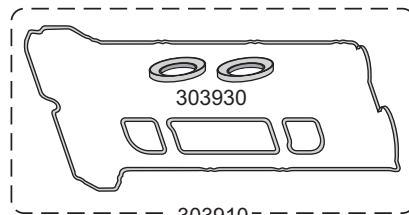
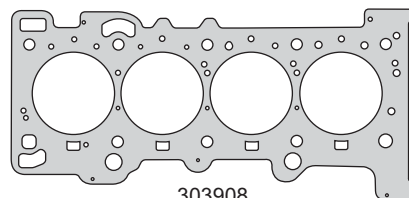

303910

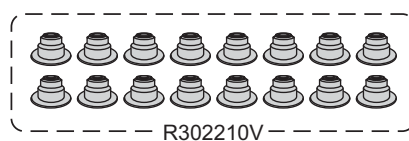
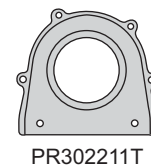
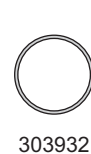
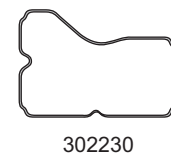
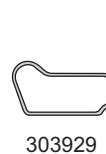
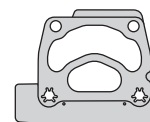

**FORD**



Motor/Engine	Cm³	HP	Ø
Max Econo	3618	106	93.47

Ford: Falcon, Pick Up 1989/...



Nº OE	Descripción/Description	Mat.	Ref.
	Jgo. de juntas para motor		31000-R
	Jgo. de juntas para motor		31002-R
	Jgo. de juntas superior		310095
	Jta. tapa cilindros Ø 96.7 ± 1.40	NFT 1 1	310005
	Jta. tapa cilindros Ø 96.7 ± 1.40	NFT	310007
CODE6584B	Jgo. tornillos tapa cilindros		B300000
BAC9DZ6781A	Junta tapa válvulas	CG 1 1	300010
BAC9DZ6020A	Jgo. junta para cárter (4)	CG 1	300011
CODE8507A	Tapa distribución	NB 1	300012
BAC9DZ9448A	Bomba de agua	NB 1	300014
C6AZ9450D	Múltiple admisión y escape	NFT 1 1	310016
CODE8255A	Salida de escape	FCH 1 1	300018
BAE-7DZ9502-A	Salida agua termostato	CB 1 1	300019
	Jgo. juntas carburador SOLEX 34 TEIE	VS	310020
	Junta base carburador	NB 1	300025
	Junta base carburador	NB 1	300125
	Base carburador	NB 2	310025
	Tapa cuba carburador	CB	310026
	Bomba aceite	NB 1	300027
BAC9DZ9447A	Bomba nafta	NB 1	300028
C3AZ9417C	Base calefactor	NB 1 1	300031
CODE6626A	Cañería aceite	NB 1	300032
	Tapa diferencial DANA 44	CG	540034
	Salida de escape	H	310040
	Jgo. juntas caja velocidades TRANSAX	VS	300052
C9OZ6701A	Jgo. juntas caja velocidades HUMMEL 5ta.	NH	310053
BAC9DZ6781A	Jgo. empaquetadura bancada (2)	SNA	300058
CODE6584B	Jgo. juntas para cárter	CG	300060
	Tapa válvulas superior	CG	300061
	Porta retén rulemán palier	CB	300065
	Tapa diferencial DANA 44	CGT	540068
	Palier	CB	300069
	Tapa diferencial DANA 44	NH	300086
	Kit de retenes completo		R300000
	Jgo. retén válvulas (12)	P 1	R300010P
	Jgo. retén válvulas capuchones (12)	P	R300010-1P
	Retén bancada 85.7 x 102.62 x 9.73	P 1	R300011P
	Retén reforma bancada 85.7 x 100 x 5.5	P 1	R300911P
	Retén distribución 44.45 x 60.3 x 11.11	P 1	R300012P

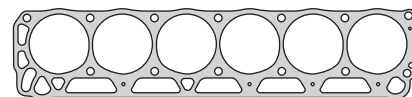

310005



300010

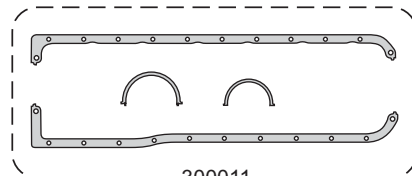

300011



310016

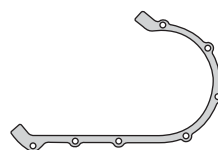

300012



300014



300018



300019

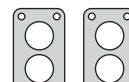

310025



310026



300025



300125



300027



300028



300031



300032

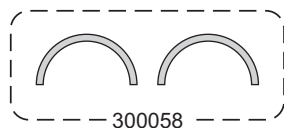

300058



R300011P



R300911P



R300012P

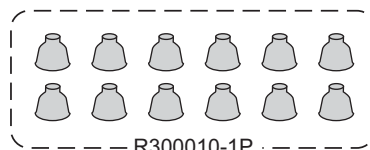

R300010-1P

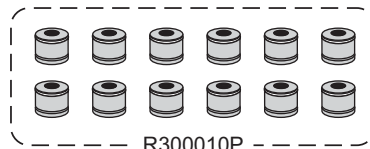

R300010P

**FORD**



Motor/Engine	Cm³	HP	Ø
F302 V8 (SOHC) V8 16V	4942	143	101.6

Ford: Ranger 1989/...  
Galaxy, Maverick 1976/83



Nº OE	Descripción/Description	Mat.	Ref.
	Jgo. de juntas para motor		310100
	Jgo. junta tapa cilindros Ø 104.0 ± 1.40 (2)	NFT	1 310105
	Junta tapa de válvulas	CG	2 310110
	Jgo. junta para cárter (4)	CG	1 310111
	Tapa distribución	NB	1 310112
	Tapa bomba de agua	NB	1 310114
	Jgo. múltiple escape (8)	NFT	1 310116
	Jgo. múltiple admisión (2)	NFT	1 310117
	Salida de escape	FCH	2 300018
	Placa bomba de agua	NB	1 310119
	Base bomba nafta	NB	1 540028
	Chupador bomba aceite	NB	1 310129
	Junta termostato	NB	1 310130
	Base Termostato	CB	1 320734
	Salida gases	NB	1 310132
	Base termostato	NB	310134
	Tapa bomba aceite	NB	1 310135
	Unión cierre ADM D	CG	1 310136
	Unión cierre ADM T	CG	1 310137
	Base bomba aceite	NB	1 310141
	Acople bomba aceite	NB	310142
	Jgo. empaquetadura bancada (2)	SNA	1 200658
	Acople bomba aceite	CB	1 320747

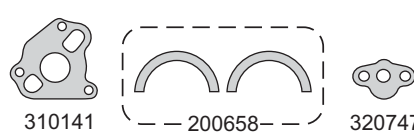
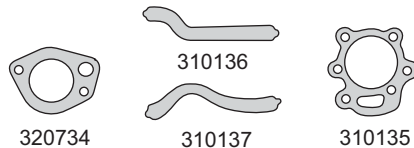
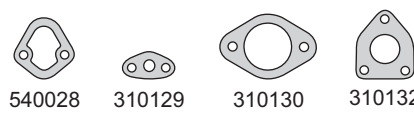
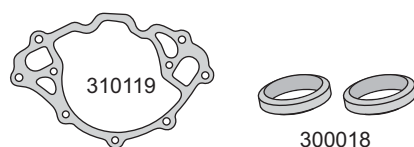
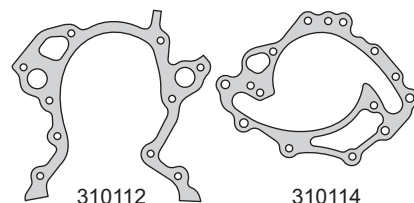
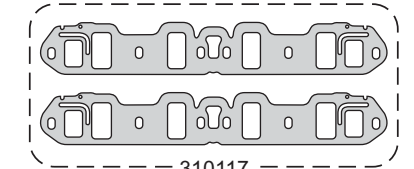
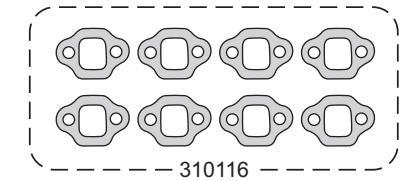
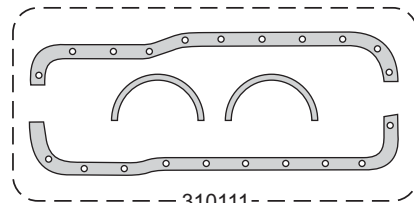
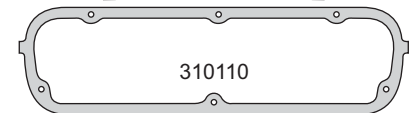
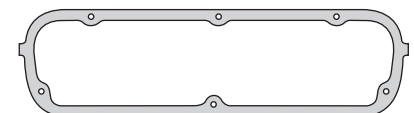
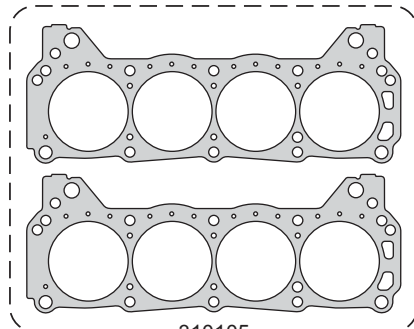

**FORD****taranto**

Motor/Engine

Cm³

HP

Ø

**300 CID**  
(OHV) 12V

4917

145

101.1

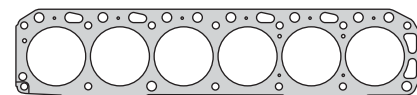
Ford: Econoline, Delivery 1980/...  
Bronco 1980/92

310205

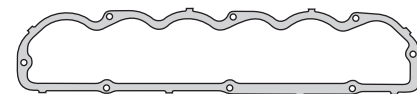

310210

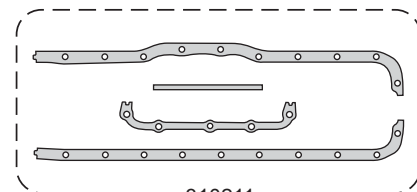

310211



310216



310236

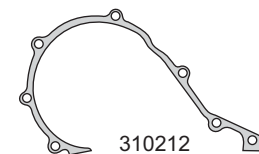

310212



310214



300018



310227



R300212P



R340911P

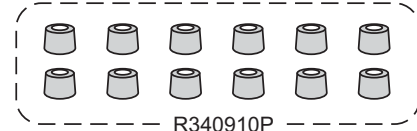

R340910P

Nº OE	Descripción/Description	Mat.	Ref.
	Jgo. de juntas para motor		<b>310200-R</b>
<b>F0UZ-6051A</b>	<b>Junta tapa cilindros Ø 107.0 ± 1.70</b>	<b>NFT</b>	<b>1 310205</b>
E9TZ-6584B	Junta tapa válvulas	<b>CG</b>	1 310210
E7TZ-6710B	Jgo. junta para cárter (4)	<b>CG</b>	1 310211
E6TZ-6020B	Tapa distribución	<b>NB</b>	1 310212
C5AZ-8507A	Bomba de agua	<b>NB</b>	1 310214
	Multiple admisión y escape	<b>NFT</b>	1 310216
	Salida de escape	<b>FCH</b>	2 300018
	Termostato	<b>NB</b>	1 310227
	Arandelas tapa lateral válvulas	<b>GS</b>	400130
E4TZ-6521A	Lateral de válvulas	<b>CG</b>	1 310236
	Kit de retenes completo		R340900
	Jgo. retén válvulas (12)	<b>P</b>	1 R340910P
	Retén bancada 95 x 114.5 x 11	<b>P</b>	1 R340911P
	Retén distribución 47.65 x 65.05 x 11.83	<b>P</b>	1 R300212P

**FORD**



Motor/Engine Cm³ HP Ø

390 CID V8 5400 102

Ford: Fairlane 500, Galaxy 500, Monterey Thunderbird, Mustang 1960/71



Nº OE	Descripción/Description	Mat.	Ref.
	<b>Jgo. de juntas para motor</b>		<b>310300</b>
	<b>Jgo. junta tapa cil. Ø109.0 ± 1.20 (2)</b>	<b>NFT 1</b>	<b>310307</b>
	Junta tapa válvulas	CG 2	310310
	Junta para cárter	CG 1	310311
	Tapa distribución	CB 1	310312
	Tapa distribución	CB 1	310313
	Bomba de agua	CB 1	310314
	Jgo. múltiple escape (2)	NFT 1	310316
	Jgo. múltiple admisión (4)	NFT 1	310317
	Salida de escape	AC	310318
	Termostato	CB 1	310319
	Bomba aceite	CB 1	310327
	Base bomba nafta	CB 1	200028
	Vaso bomba nafta	CG 1	310333
	Base termostato	CB 1	310334
	Retorno aceite	CB 1	310335
	Salida gases	CB 2	310336
	Guarnición		310337
	Entrada aceite	CB 1	310338
	Succión aceite	CB 1	310339
	Junta	CG 1	310340
	Junta	CG 1	310341
	O´ring G 34.59 x 2.62	GS 1	
	Retén distribución 47 x 65 x 10.30	P	R310312P

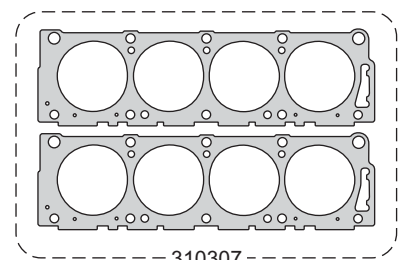

310307

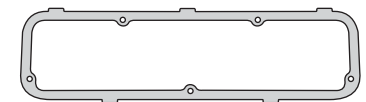

310310

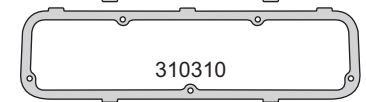

310311

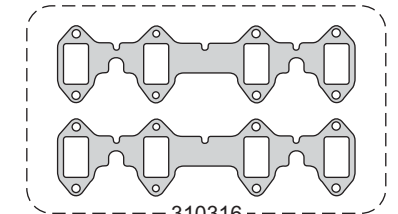
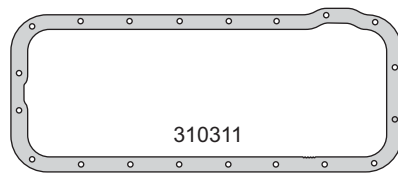

310316

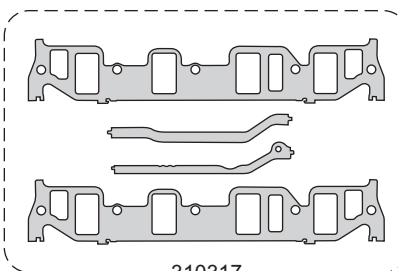

310317

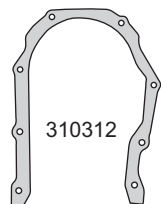

310312

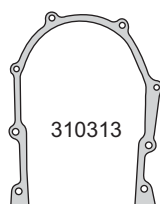

310313



310314

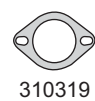

310319

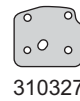

310327



200028



310333



310334



310335



310336



310337



310338

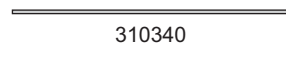

310340



310339

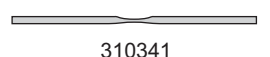

310341



G 34.59 x 2.62



R310312P

**FORD**



Motor/Engine	Cm³	HP	Ø
CHT	1555	73	77

**Ford:** Corcel II 1979/83  
Belina II, Pampa 1982/83  
Del Rey 1981/83, Scala 1983/...



Nº OE	Descripción/Description	Mat.	Ref.
	Jgo. de juntas para motor		310600-R
BD9M-6008A	Jgo. de juntas para motor	●	310600
	Jgo. de juntas superior		310695
78MU-6051A2	Junta tapa cilindros Ø 78.0 ±1.40	NFT 1 1	310605
	Jgo. tornillos tapa cilindros (HAS17038)		B300700
64293	Conj. junta tapa válvulas (4)	N 1 1	300710
BD9M-6781A	Jgo. junta para cárter (4)	CG 1	300711
BD9M-9448A	Tapa distribución	NB 1	300712
48469	Tapa bomba agua	NB 1	560214
BD9M-6781A	Multiple escape	NFT 1 1	310616
73MU-6020A	Salida de escape	FCH 1 1	550418
48437	Placa bomba de agua	NB 1	560219
BDIM-9417A	Base carburador	NB 2 2	550325
78MV-9417A	Tapa y toma bomba aceite	NB 1	550427
48470	Bomba aceite a block	NB 1	310627
59295	Base bomba nafta	NB 2	250128
75MU-9417A	Bomba nafta a block	NB 2	550428
65689	Bomba nafta	NB 2	310628
7057030	Arandela tapa válvulas A 7 x 17 x 1.5 F	NB 4 4	550430
57101	Tapa trasera tapa cilindros	NB 1 1	310631
65689	Bomba aceite a block	NB 1	310633
6071557	Tapón cárter A 16 x 22 x 1 F	F 1	310634
65583	Base distribuidor	NB 1	550338
78MV-6659A	Llenado aceite	CG 1 1	450041
7703061078	Arandela tapa válvulas	GS 3 3	300742
EOEE-6734AA	Jgo. superior camisa cilindros (0.095) (4)	CU 1	300770-0.095
78MU-6055B	Jgo. superior camisa cilindros (0.115)	S	300770-0.115
78MU-6055C	Jgo. superior camisa cilindros (0.135)	S	300770-0.135
78MU-6055D	Jgo. superior camisa cilindros (0.155)	S	300770-0.155
	Kit de retenes completo		R310600
	Jgo. retén válvulas (8)	V 1	R310810V
78MU-6055A	Retén bancada 82 x 105 x 12	P 1	R300711P
	Reten distribución 35 x 50 x 9	P 1	R550412P

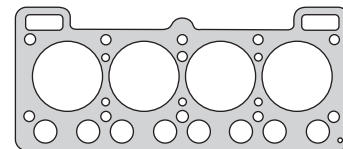

310605

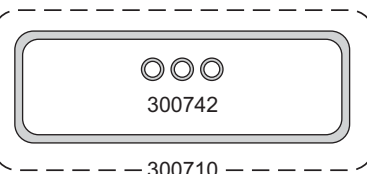

300742

300710

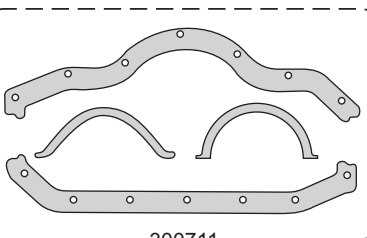

300711



310616

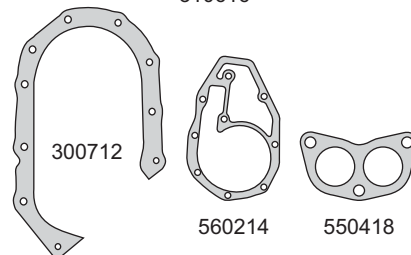

300712

560214

550418



560219

310627

550325



550427

310628

250128

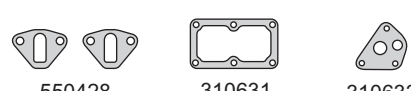

550428

310631

310633



550338

A 16 x 22 x 1 F

450041

A 7 x 17 x 1.5 FA

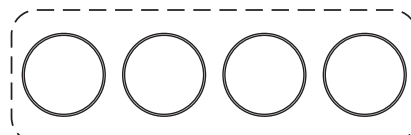

300770-0.095

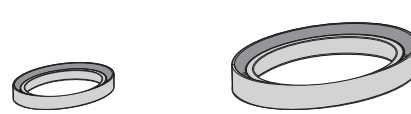

R550412P

R300711P

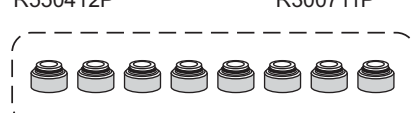

R310810V

**FORD**



Motor/Engine	Cm³	HP	Ø
CHT/AE CHT/AE (SOHC) 8V	997 1300		70.3 71.5

**Ford:** Escort 1.3 1983/...  
Escort Hobby 1.0 1993/...  
**Volkswagen:** Gol 1.0 1993/...



Nº OE	Descripción/Description	Mat.	1	1	Ref.
	Jgo. de juntas para motor				310700-R
	Jgo. de juntas superior		●	●	310795
84AU/6051/B	Junta tapa cilindros Ø 73.0 ± 1.40		NFT	1	310705
	Jgo. tornillos tapa cilindros (HAS17038)				B300700
64293	Conj. junta tapa válvulas (4)		N	1	300710
81NUNV6710/A	Jgo. junta para cárter (4)		CG	1	300711
73MU6020-A	Tapa distribución		NB	1	300712
84AU8513/A	Tapa bomba de agua		NB	1	300714
84AU9448/B	Múltiple escape		NFT	1	300716
84AU9435-A	Entre múltiple		NFT	1	300717
841253115B	Salida de escape		FCH	1	220418
84AU9451/A	Salida de escape		FCH	1	300718
86AU-8507-AA	Base bomba de agua		NB	1	300719
78MU6659A	Toma y tapa bomba de aceite		NB	1	550427
65689	Bomba de aceite		CB	1	300727
75MU9417A	Base bomba de nafta		NB	2	300728
84AU-6W021-A	Placa tapa de cilindro		NB	1	300729
84AU8507A	Base bomba agua		NB	1	300731
6071557	Base distribuidor		NB	1	550338
E0EE6734AA	Arandela tapón cárter A 15 x 21 x 2 A		AL	1	300730
65583	Arandela tapa válvulas		GS	3	300742
78MU6055A	Jgo. superior camisas cilindros (0.095) (4)		CU	1	300770-0.095
	Jgo. superior camisas cilindros (0.125)		CU		300770-0.125
	Jgo. superior camisas cilindros (0.135)		CU		300770-0.135
	Jgo. superior camisas cilindros (0.155)		CU		300770-0.155
	Kit de retenes completo				R310600
	Jgo. retén válvulas (8)		V	1	R310810V
	Retén bancada 82 x 105 x 12		P	1	R300711P
	Retén distribución 35 x 50 x 9		P	1	R550412P

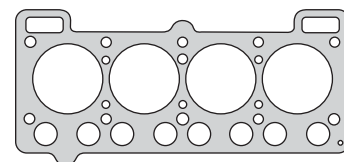

310705

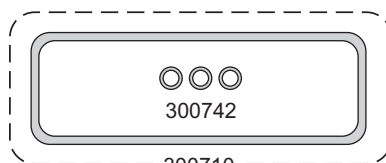

300742

300710

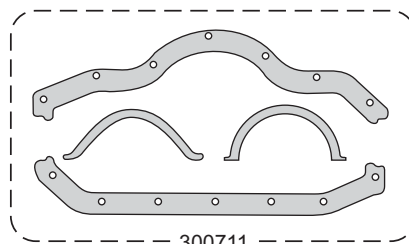

300711

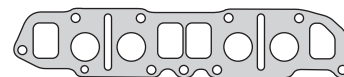

300716

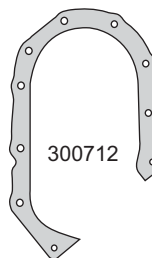

300712



300714

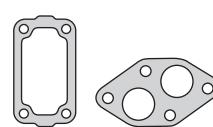

300717



300718



220418

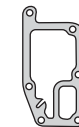

300719



300727



300728



550427



300729



300731



550338



A 15 x 21 x 2 A



300770-0.095



R550412P



R300711P



R310810V



**FORD****taranto**

Motor/Engine	Cm³	HP	Ø
OHV (HCS)	1297	50/60	73.96
OHV (HCS)	1299	50/60	73.96
Endura (SOHC) 8V			

**Ford:** Fiesta 1988/95, Courier 1991/...  
Fiesta, Ka (cárter de acero)  
Escort, Fiesta, Courier, Ka  
(cárter de aluminio) 1995/...

Nº OE	Descripción/Description	Mat.	Ref.
	Jgo. de juntas para motor		310800-R
	Jgo. de juntas superior		310895
6176727	Jta. tapa cilindros Ø 76.0 ± 1.40	NFT 1 1	310805
	Jta. tapa cilindros Ø 76.0 ± 1.40 <b>NR</b>	NFT	310807
	Jgo. tornillos tapa cilindros (HAS14038)		B310800
6038115	Junta tapa válvulas	CG 1 1	310810
6707927	Jgo. junta para cárter (4) 1988/95	CG 1	310811
6165295	Tapa distribución	CB 1	310812
6189107	Bomba de agua	CB 1	310814
7126483	Jgo. múltiple de escape (4)	FCH 1 1	310815
6173339	Múltiple de admisión 1988/95	NB 1 1	310817
	Salida de escape	NFT 1 1	310818
1628164	Termostato	CB 1 1	310819
1651769	Bomba de aceite	CB 1	310827
	O'ring bomba nafta G 23.52 x 1.78	GS 1	310828
6165221	Bancada trasera	CB 1	310829
6660137	O'ring int. para bomba aceite G 23.39 x 3.53	GS 2	310830
	Arandela tapón cárter A 15 x 21 x 2 A	AL 1	310831
	Múltiple admisión - Fiesta 1299cc. 1995/...	NB 1 1	310832
	Acople caño escape	AC/GS	310840
	Junta para cárter (para cárter aluminio)	AL/GS	310860
	Jgo. caja de velocidades	VS	300750
	Jgo. suplemento tapa de cilindros (4) (0.50)	AC	310885-0.50
	Kit de retenes completo		R310800
	Jgo. retén válvulas (8)	V 1	R310810V
	Retén bancada 79.38 x 95.25 x 11.11	V 1	R300611V
	Retén distribución 36.51 x 52.48 x 8	P 1	R310812P

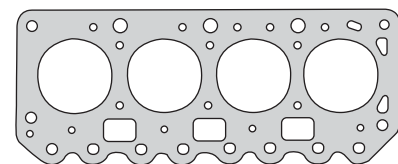

310805

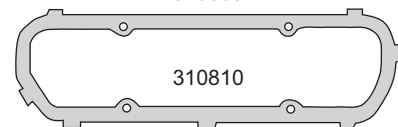

310810

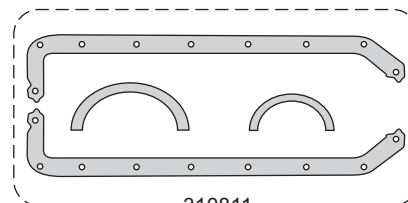

310811

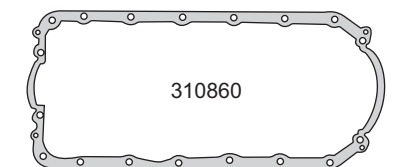

310860

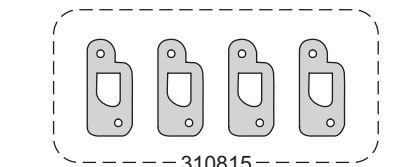

310815

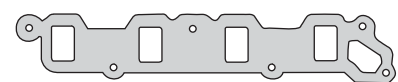

310817

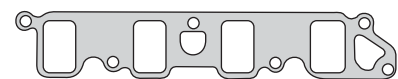

310832



310812

310814

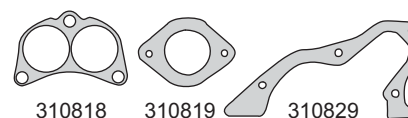

310818

310819

310829

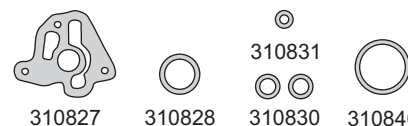

310827

310828

310831

310830

310840

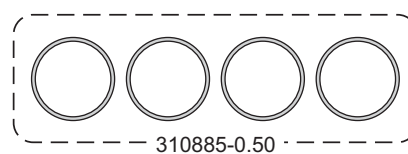

310885-0.50



R310812P

R300611V



R310810V

**FORD**



Motor/Engine	Cm³	HP	Ø
177/BRC (SOHC) V6 12V	2933	150	93

**Ford:** Ford V6 (USA) Ranger, Bronco II 1988/92  
Sierra V6 B4A/B/C 1989/93  
Granada BRC 1986/93



Nº OE	Descripción/Description	Mat.		Ref.
	Jgo. de juntas para motor		●	310900-R
	Jgo. de juntas superior		●	310995
	Jgo. jta. tapa cil. Ø 95 ± 1.40 (2)  NR <sup>2</sup>	NFT	1 1	310907
	Jgo. tornillos tapa cilin. (HAT55055/55100)			B310900
	Junta tapa válvulas	CG	2 2	310910
	Junta para cárter	N	1	310911
	Tapa distribución	CB	1	310912
	Tapa bomba de agua	CB	1	310914
	Jgo. múltiple escape (2)	NFT	1 1	310915
	Junta tapa admisión	NFT	1 1	310917
	Superior admisión	CB	1 1	310926
	Succión aceite	NFT	1	310927
	Arandela drenaje A 14 x 21 x 2	PLAST	1	310930
	Superior admisión	CB	1 1	310931
	Superior admisión	CB	1 1	310932
	Superior admisión	CB	1 1	310933
	Entrada aire	CB	1 1	310934
	Bomba aceite	NFT	1 1	310935
	Cuerpo válvula cierre	CB	1 1	310936
	Cuerpo válvula cierre	CB	1	310937
	Entrada aceite	CB	1	310938
	Sello de agua	GS	1	310940
	O´ring G 17.12 x 2.62	GS	1	
	O´ring G 21.89 x 2.62	GS	1	
	O´ring G 24.99 x 3.53	GS	2	
	O´ring G 26.64 x 2.62	GS	1	
	O´ring G 61.60 x 2.62	GS	1	
	O´ring G 63.09 x 3.53	GS	1	
	Kit de retenes completo			R310900
	Jgo. retén válvulas (12)	P	1	R310910P
	Retén bancada 60.45 x 76.18 x 10	V	1	R320111V
	Retén distribución 42 x 56 x 7	V	1	R300612V

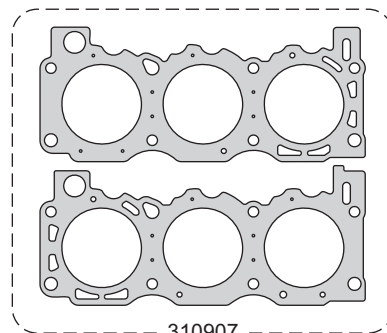

310907



310910

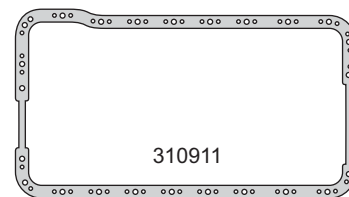

310911

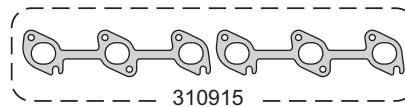

310915

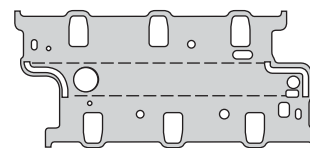

310917

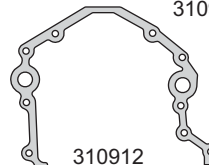

310912



310914



310926



310927



310930



310931



310932



310933



310934



310935



310936



310937



310938



310940



R300612V



R320111V

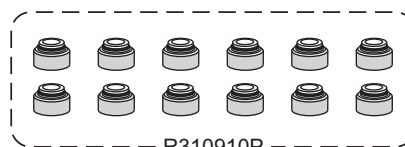

R310910P

**FORD**



Motor/Engine	Cm³	HP	Ø
OHV (HCS) Endura	999	45/53	68.7

Ford: Ka 1997/99, Fiesta 1996/99 53HP  
Fiesta 1988/95 45HP



Nº OE	Descripción/Description	Mat.	Ref.
	Jgo. de juntas para motor		311000-R
	Jgo. de juntas superior		311095
	Junta tapa cilindros Ø70.5 ±1.30	NFT 1 1	311005
	Junta tapa cilindros Ø70.5 ±1.30 NR	NFT	311007
	Jgo. tornillos tapa cilindros (HAS14038)		B310800
6038115	Junta tapa válvulas	CG 1 1	310810
6707927	Jgo. junta para cárter (4)	CG 1	310811
6165295	Tapa distribución	CB 1	310812
6189107	Bomba de agua	CB 1	310814
7126483	Jgo. múltiple de escape (4)	NFT 1 1	310815
6173339	Múltiple de admisión	NB 1 1	310817
	Salida de escape	NFT 1 1	310818
1628164	Termostato	CB 1 1	310819
1651769	Bomba de aceite	CB 1	310827
	O'ring bomba nafta G 23.52 x 1.78	GS 1	310828
6165221	Bancada trasera	CB 1	310829
6660137	O'ring int. para bomba aceite G 23.39 x 3.53	GS 2	310830
	Arandela tapón cárter A 15 x 21 x 2 A	AL 1	310831
	Múltiple admisión	NB 1 1	310832
	Acople caño escape	AC/GS	310840
	Junta para cárter (para cárter aluminio)	AL/GS	310860
	Juego caja de velocidades	VS	300750
	Kit de retenes completo		R310800
	Jgo. retén válvulas (8)	V 1	R310810V
	Retén bancada 79.38 x 95.25 x 11.1	V 1	R300611V
	Retén distribución 36.51 x 52.48 x 8	P 1	R310812P

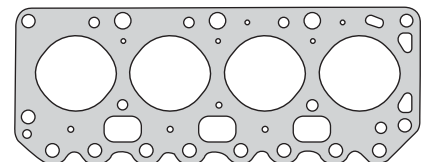

311005

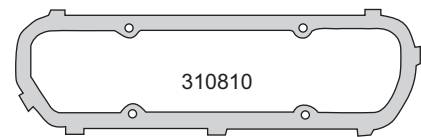

310810

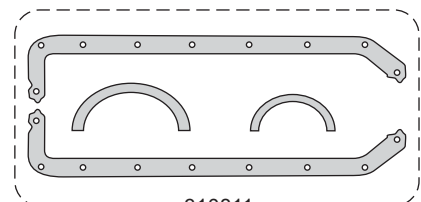

310811

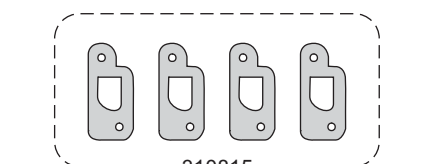

310815

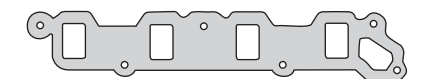

310817

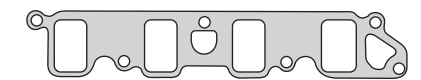

310832

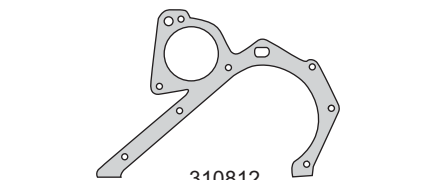

310812



310814

310818

310819

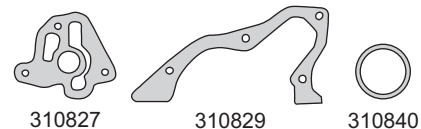

310827

310829

310840



G23.52 x 1.78

G23.39 x 3.53

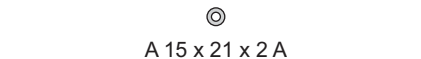

A 15 x 21 x 2 A

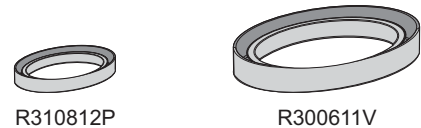

R310812P

R300611V



R310810V

**FORD**



Motor/Engine	Cm³	HP	Ø
330 V8	5400		
351 V8	5900		
391 V8	6400		

**Ford:** Galaxie, Mustang, Torino 1964/78  
Camión 1964/78



Nº OE	Descripción/Description	Mat.	Ref.
	<b>Jgo. de juntas para motor</b>		<b>311100-RMX</b>
	<b>Jgo. junta tapa cilindros Ø 109.0 ± 1.20 (2)</b>	NFT	1 311105
	Junta tapa válvulas	CG	2 310310
	Jgo. junta para cárter (3)	CG	1 311111
	Tapa distribución	CB	1 311112
	Bomba de agua	CB	1 310314
	Bomba de agua	CB	2 311114
	Jgo. múltiple escape (2)	NFT	1 311116
	Jgo. múltiple admisión (4)	NB	1 311117
	Termostato	CB	2 310319
	Bomba aceite	CB	1 311127
	Base bomba nafta	CB	1 200028
	Junta unión entre múltiples	GS	2 310330
	Entrada aceite	CB	1 310338
	Succión aceite	CB	1 310339
	O'ring G 7 x 10 x 2	GS	16
	Arandela A 14 x 18 x 1.5 A	AL	1
	Kit de retenes completo		R311100
	Jgo. retén válvulas (8)	P	1 R31110P
	Retén distribución 60.3 x 82.5 x 11	P	1 R330012P

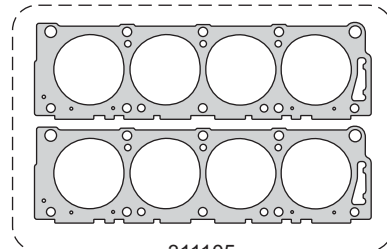

311105

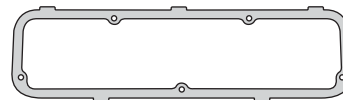

310310

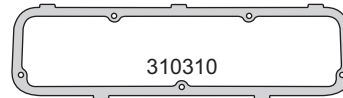

311111

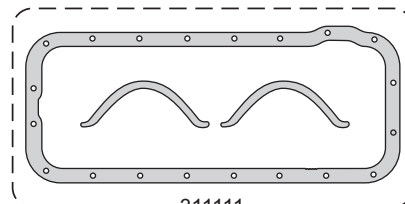

311116

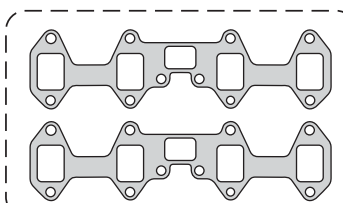

311117

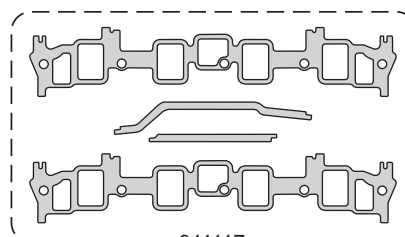

311112

311114

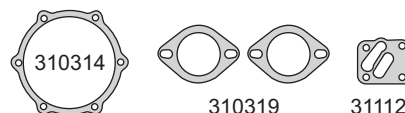

310314



310319



311127

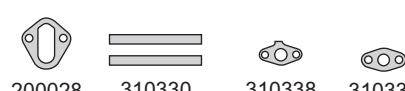

200028



310330



310338



310339



G 7 x 10 x 2

A 14 x 18 x 1.5 A



R330012P

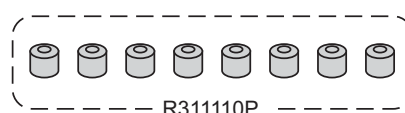

R31110P

**FORD**



Motor/Engine

Cm³

HP

Ø

Ford: V8 1964/72

350 V8

5400



Nº OE	Descripción/Description	Mat.	Ref.
	<b>Jgo. de juntas para motor</b>		<b>311200-R</b>
	<b>Jgo. junta tapa cilindros Ø 109.0 ± 1.20 (2)</b>	NFT	1 311105
	Junta tapa válvulas	CG	2 310310
	Junta para cárter	CG	1 310311
	Tapa distribución	CB	1 311112
	Bomba de agua	CB	1 310314
	Bomba de agua	CB	2 311114
	Jgo. múltiple escape (2)	NFT	1 311116
	Jgo. múltiple admisión (4)	NB	1 311117
	Termostato	CB	2 310319
	Bomba aceite	CB	1 310327
	Base bomba nafta	CB	1 200028
	Junta unión entre múltiples	GS	2 310330
	Guarnición goma	N	1 311230
	Entrada aceite	CB	1 310338
	Succión aceite	CB	1 310339
	Junta	NFT	2 320762
	O'ring G 7 x 10 x 2	GS	16
	Arandela A 14 x 18 x 1.5 A	AL	1
	Kit de retenes completo		R311200
	Jgo. retén válvulas (8)	P	1 R311110P
	Retén bancada (dos mitades)	N	1 R311211-1N
	Retén distribución 66.3 x 82.5 x 11	P	1 R330012P

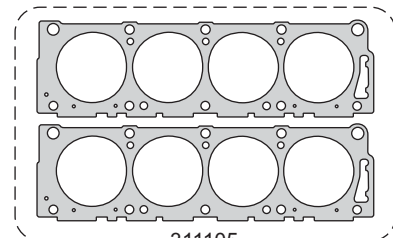

311105

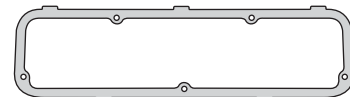

310310

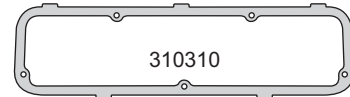

310311

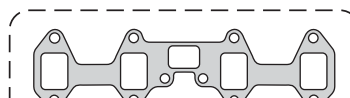
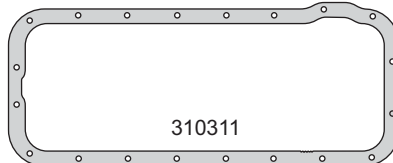

311114

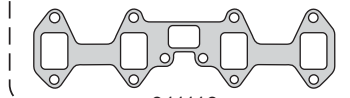
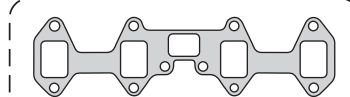

311116

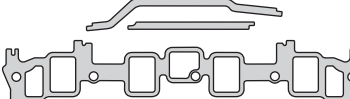
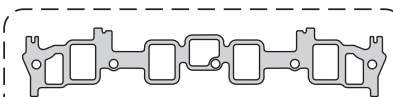

311117

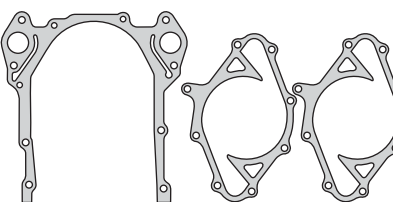

311112

311114

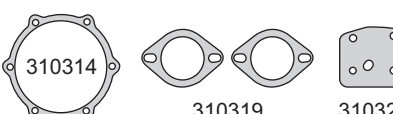

310314

310319

310327



200028

310330

311230

310338



310339

320762

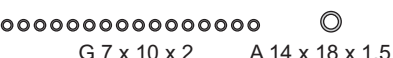

G 7 x 10 x 2

A 14 x 18 x 1.5 A

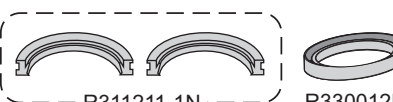

R311211-1N

R330012P

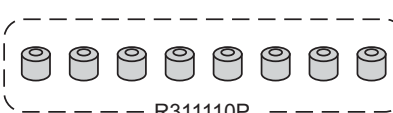

R311110P

**FORD**



Motor/Engine	Cm³	HP	Ø
D1.8T/TI	1753	75/90	82.5
D18NA	1753	60	82.5

**Ford:** Escort D, Fiesta D, Orion D 1989/92  
 Courier D, Fiesta D, Orion D 1992/94  
 Sierra TD, Pick Up 1988/91  
 Pick Up TD, Sierra TD, Escort TD  
 Orion TD, Mondeo TD 1992/94

DIESEL



Nº OE	Descripción/Description	Mat.	1	2	Ref.
	Jgo. de juntas para motor			●	320001-R
	Jgo. de juntas superior		●		320095-2M
	Jgo. de juntas superior				320095-3M
	Jgo. de juntas superior				320095-4M
	Jgo. de juntas superior				320096
	Junta tapa cilindros Ø 84.0 $\pm$ 1.45	NFT			320005-2M
	Junta tapa cilindros Ø 84.0 $\pm$ 1.50	NFT			320005-3M
	Junta tapa cilindros Ø 84.0 $\pm$ 1.55	NFT			320005-4M
6.562.341	Junta tapa cilindros Ø 84.0 $\pm$ 1.40	NFT	1		320007-2M
6.526.342	Junta tapa cilindros Ø 84.0 $\pm$ 1.45	NFT			320007-3M
6.526.343	Junta tapa cilindros Ø 84.0 $\pm$ 1.50	NFT			320007-4M
	Jgo. tornillos tapa cilindros (HAT70100)				B320000
6.765.358	Conj. junta tapa válvulas (4)	N	1	1	320010
1.075.963	Junta para cárter	S		1	320011
6.169.448	Junta frente motor	CB		1	320012
6.175.096	Bomba de agua	CB		1	320014
	Múltiple escape	NTF	1	1	320015
	Múltiple escape	AC			320016
6.740.296	Múltiple admisión	CB	1	1	320017
6.180.424	Múltiple admisión turbo	NFT	1	1	340317
6.740.297	Salida de escape turbo	NFT	1	1	320018
6.175.938	Salida de escape	NFT	1	1	310818
6.465.080	Junta termostato	CB	1	1	320019
6.561.244	Guarnición bomba aceite	S		1	320027
1.630.835	Brida trasera	CB		1	320029
	Válvula reguladora gases	AC	3	3	320030
6.465.680	Anillo termostato	GS		1	560131
89FF8255AA	Arandela tapa válvulas	GS	3	3	320033
91FF6344AA	Mando bomba vacío	CB		1	320041
6.148.285	Bomba de agua	CB		1	320042
6.175.909	Guarnición fijación placa de distribución	S		2	320043
1.665.178	Arandela pico inyector	CU	4	4	320044
	Jgo. colector admisión entre múltiples	N	4	4	320047
	Acople caño de escape Fiesta - Courier				320048
	O'ring G 40 x 3	GS		1	
	O'ring G 46 x 3	GS	4	4	
	O'ring G 20 x 2.5	GS		1	
	O'ring G 91 x 1.8	GS		1	
	O'ring G 47.22 x 3.53	GS		4	
	O'ring G 52.07 x 2.62	GS		1	
	O'ring G 53.09 x 3	GS		1	
6112230	Arandela tapón cárter A 15 x 21 x 2 A	AL		1	
	Kit de retenes completo				R320000
1.644.647	Jgo. retén válvulas (8)	V		1	R320010V
	Retén bancada 79.38 x 95.25 x 11.11	V		1	R300611V
1.078.528	Porta retén bancada	V			PR320011V
	Retén distribución 66.67 x 89.3 x 10	P		1	R320012P
	Retén árbol levas 28 x 38 x 7	V		1	R320013V
	Porta retén auxiliar 40 x 53.50 x 7.5/8.5	V			PR320015V

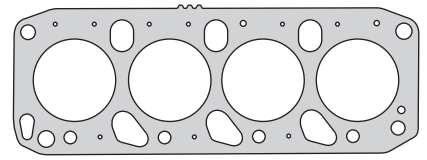

320007

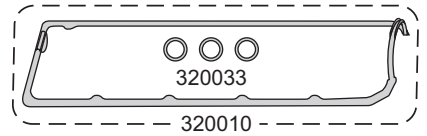

320033

320010

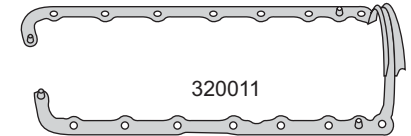

320011



320015

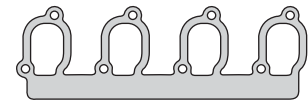

320017

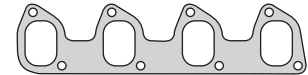

340317

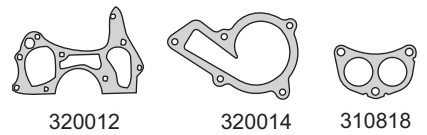

320012

320014

310818



320018

320019

320027

320029

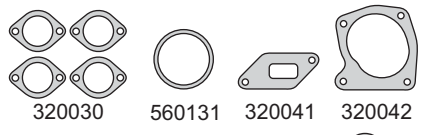

320030

560131

320041

320042



320043

320044

G 20 x 2.5



320047

G 40 x 3



G 47.22 x 3.53

G 52.07 x 2.62

A15 x 21 x 2 A



PR320011V

PR320015V



R300611V

R320013V

R320012P



R320010V

**FORD**



Motor/Engine	Cm³	HP	Ø
244 CID V6 (SOHC) 12V	3996	147/165	100.4

Ford: Explorer, Ranger, Navajo V6 1991/...  
Bronco II V6 1990/91



Nº OE	Descripción/Description	Mat.	Ref.
	Jgo. de juntas para motor		320100-R
	Jgo. de juntas superior		320195
	Jgo. tapa cil. Ø 103.5 ± 1.40 (2)  NR	NFT 1 1	320107
	Jgo. tornillos tapa cilin. (HAT55055/55100)		B310900
	Junta tapa válvulas	CG 2 2	320110
	Junta para cárter	N 1	320111
	Tapa distribución	CB 1	320112
	Tapa bomba agua	CB 1	320114
	Jgo. múltiple escape (2)	NFT 1 1	320115
	Jgo. multiple admisión (2)	CB 1 1	320116
	Junta tapa admisión	NFT 1 1	320117
	Junta adaptador bomba aceite	CB 1	320127
	Junta sello de calce	GS 1	320129
	Junta	NFT 1	320130
	Junta	NFT 1	320131
	Junta	NB 1	320132
	Junta	NFT 1	340731
	Arandela drenaje A 14 x 21 x 2	PLAST 1	310930
	Junta entrada paso aire	CB 1 1	310936
	Junta válvula paso	CB 1 1	310938
	Junta sello agua	GS 1	310940
	Junta cuerpo conducto	CB 1 1	320141
	O'ring bulones G 17.12 x 2.62	GS 1	310942
	O'ring adaptador G 63.09 x 3.53	GS 1	310944
	Limitador torque A 7 x 8.9 x 1.9 A	AC 16	
	Kit de retenes completo		R310900
	Jgo. retén válvulas (12)	P 1	R310910P
	Retén bancada 60.45 x 76.18 x 10	V 1	R320111V
	Retén distribución 42 x 56 x 7	V 1	R300612V

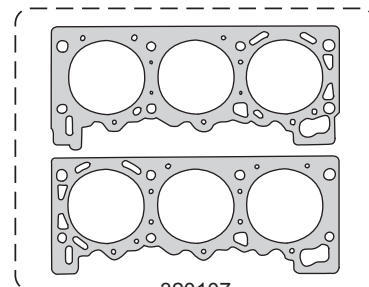

320107

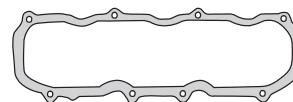

320110



320111

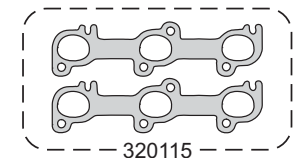
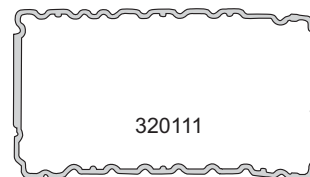

320115

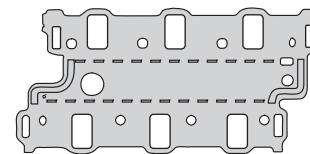

320117

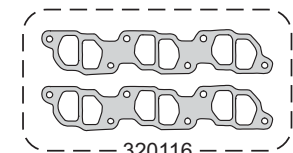

320116

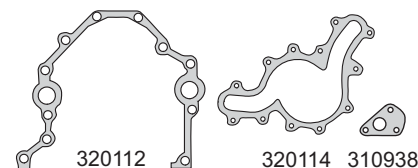

320112

320114

310938

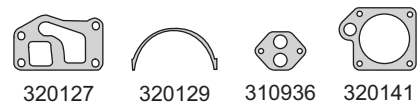

320127

320129

310936

320141



320130

320131

320132

340731



G17.12 x 2.62

310940

A 14 x 21 x 2 A



G 63.09 x 3.53



R320111V

R300612V

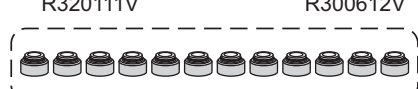

R310910P

**FORD**



Motor/Engine	Cm³	HP	Ø
230 (232) V6	3811	130	96.8

Ford: V6 3.8 (USA) Mustang, Taurus, Sable Thunderbird, Cougar



Nº OE	Descripción/Description	Mat.	Ref.
	<b>Jgo. de juntas para motor</b>	●	<b>320200</b>
	<b>Junta tapa cilindros Ø 99.7 ± 1.40</b>	GFT	<b>2 320207</b>
	Junta tapa valvulas	GS	2 320210
	Jgo. junta para cárter (2)	CG	1 320211
	Tapa distribución	CB	1 320212
	Tapa bomba de agua	CB	1 320214
	Jgo. múltiple escape (2)	NFT	1 320215
	Jgo. multiple admisión (2)	NFT	1 320216
	Múltiple admisión superior	NFT	1 320217
	Junta termostato	CB	1 320219
	Junta bomba aceite	CB	1 320227
	Junta succión aceite	NFT	1 310927
	Arandela drenaje cárter	PLAST	1 310930
	Junta cierre admisión delantera	CG	1 320231
	Junta cierre admisión trasera	CG	1 320232
	Junta	CB	1 320235
	Junta entrada aire	CB	1 310936
	O'ring G 34.52 x 3.53	GS	1
	O'ring G 28.24 x 2.62	GS	1
	Kit de retenes completo		R320200
	Jgo. retén válvulas (12)	P	R320210P
	Retén bancada 92 x 108 x 9.8	P	R300311P
	Retén distribución 47 x 65/80 x 15	P	R340412P

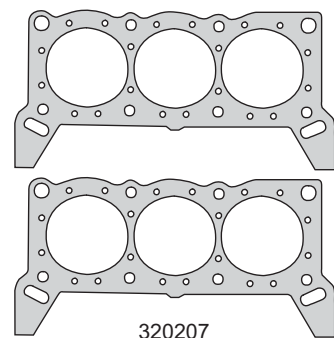

320207

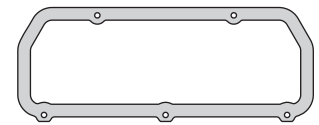

320210

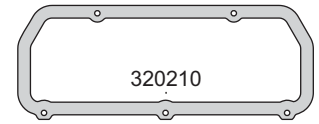

320211

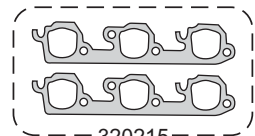

320215

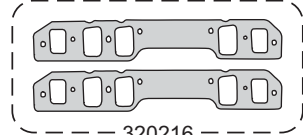

320216



320217

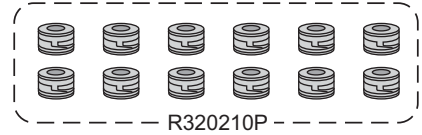
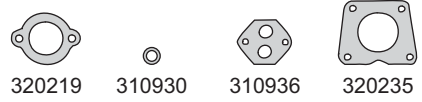
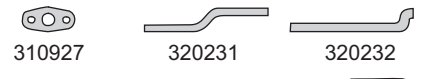
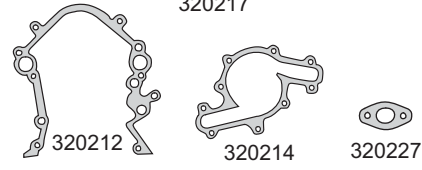



**FORD**



Motor/Engine	Cm³	HP	Ø
ZETEC (DOHC) 16V	1796	105/115	80.6

Ford: Escort, Fiesta, Orion, Fiesta XR2  
Escort RX3i 1992/...



Nº OE	Descripción/Description	Mat.	Ref.
	Jgo. de juntas para motor		320300-R
	Jgo. de juntas superior		320395
	Jgo. de juntas superior		320397
	Jta. tapa cilindros Ø 81.7 ± 1.60	NFT 1 1	320305
6847748	Jta. tapa cilindros Ø 81.7 ± 1.60 NR	NFT	320307
	Jgo. tornillos tapa cilin. (HAT55055/55100)	1 1	B320300
1663394	Conj. junta tapa válvulas (11)	GS 1	320310
7008824	Junta para cárter	N 1	320311
7378788	Frente bomba aceite	CB 1	320312
6691888	Bomba de agua	CB 1 1	320314
7181761	Múltiple escape	NFT 1 1	320316
6669767	Bakelita aislante admisión	BAK 1 1	320317
1048093	Jgo. múltiple admisión 1997/... (4)	N	320517
	Salida de escape	AC 1 1	320318
1663383	Múltiple admisión	CB 1	320329
	Junta caja termostato	CB	320332
	Válvula IAC	N 1	320333
1663908	Chupador aceite	CB 1	320334
7090340	Mariposa gases	CB 1	320335
1663861	Bancada trasera	CB 10 10	320336
6759630	Anillo tapa válvulas G 8.5 x 13.4 x 5	GS 1 1	320337
	Sello de agua	GS	310940
6692744	Acople caño de escape		320048
	Arandela cárter A 15 x 21 x 2 A	AL	
	Kit de retenes completo		1 R320300
	Jgo. retén válvulas (16)	V 1	R320310V
	Retén bancada 88 x 108 x 10	V 1	R320311V
	Retén distribución 35 x 50 x 7	V 2	R470013V
	Retén árbol levas 42 x 53 x 7	V	R320313V

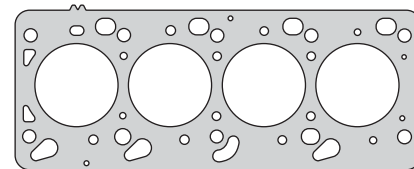

320307

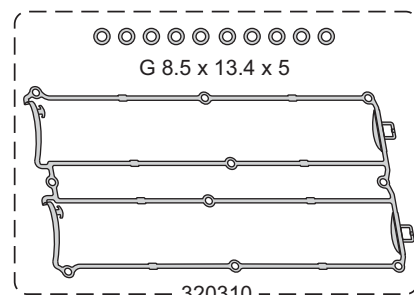

320310

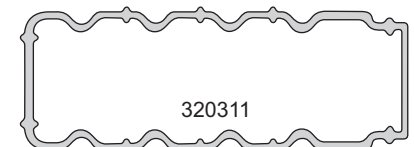

320311



320316

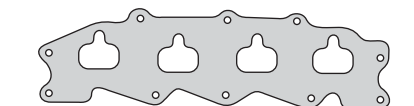

320317

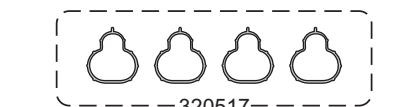

320517

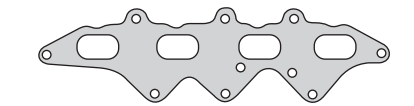

320329



320312

320336

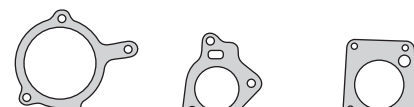

320314

320332

320335

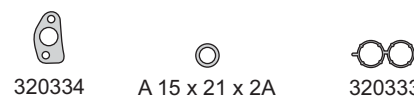

320334

A 15 x 21 x 2A

320333



R320311V



R470013V

R320313V



R320310V

**FORD**



Motor/Engine	Cm³	HP	Ø
ZETEC (DOHC) 16V	1989	136	84.8

Ford: Escort



Nº OE	Descripción/Description	Mat.	1	2	Ref.
	Jgo. de juntas para motor		●	●	320500-R
	Jgo. de juntas superior		●		320595
7114447	Jta. tapa cilindros Ø 87 $\pm$ 1.70 <b>NR</b>	NFT	1	1	320507
	Jgo. tornillos tapa cilin. (HAT55055/55100)				B320300
1663394	Conj. junta tapa válvulas (11)	GS	1	1	320310
7008824	Junta para cárter	N		1	320311
7378788	Frente bomba aceite	CB		1	320312
6691888	Bomba de agua	CB		1	320314
7181761	Múltiple escape	NFT	1	1	320316
6669767	Bakelita aislante admisión	BAK	1	1	320317
1048093	Jgo. múltiple admisión 1997/... (4)	N	1	1	320517
1663383	Multiple admisión	CB	1	1	320329
	Junta caja termostato	CB		1	320332
	Válvula IAC	N			320333
1663908	Chupador aceite	CB		1	320334
7090340	Mariposa gases	CB		1	320335
1663861	Bancada trasera	CB		1	320336
6759630	Anillo tapa válvulas G 8.5 x 13.4 x 5	GS	10	10	320337
	Sello de agua	GS	1	1	310940
6692744	Acople caño de escape				320048
	Arandela cárter A 15 x 21 x 2 A	AL		1	
	Kit de retenes completo				R320300
	Jgo. retén válvulas (16)	V		1	R320310V
	Retén bancada 88 x 108 x 10	V		1	R320311V
	Retén distribución 35 x 50 x 7	V		1	R470013V
	Retén árbol levas 42 x 53 x 7	V		2	R320313V

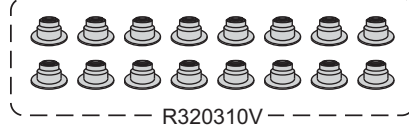
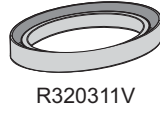
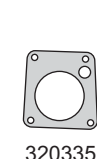
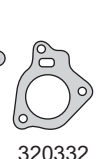
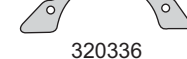
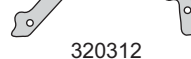
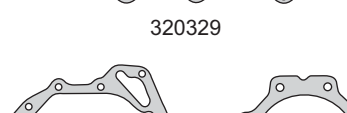
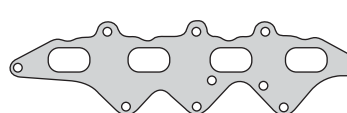
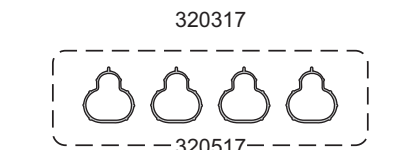
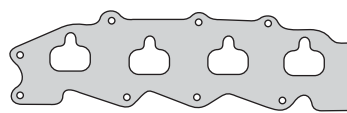
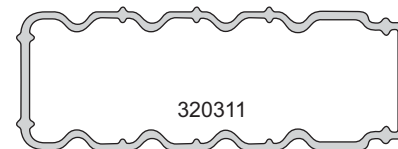
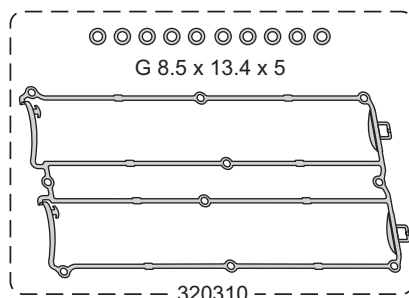
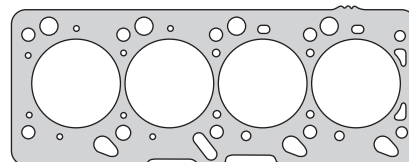

**FORD**



Motor/Engine	Cm³	HP	Ø
CHT	1300	73	77
CHT	1400	73	77

Ford: Corcel 1971/77, Corcel II 1978/83  
Belina, Coupe GT 1.4 BR



Nº OE	Descripción/Description	Mat.	Ref.
85959	Jgo. de juntas para motor		320600-R
	Jgo. de juntas superior		320695
78MU-6051A2	Junta tapa cilindros Ø 78.0 ± 1.40	NFT	1 1 310605
	Jgo. tornillos tapa cilindros (HAS17038)		B300700
64293	Conj. junta tapa válvulas (4)	N	1 1 300710
85958	Jgo. junta para cárter (4)	CG	1 1 320611
48625	Tapa distribución	NB	1 1 300712
48437	Tapa bomba de agua	NB	1 1 560214
48262	Múltiple admisión y escape	NFT	1 1 320616
7ZAU-9451A	Salida de escape	FCH	1 1 300018
48470	Placa bomba de agua	NB	1 1 560219
	Base carburador	NB	2 2 450025
59295	Base carburador	NB	2 2 550325
78MU-6659A	Tapa y toma bomba aceite	NB	1 1 550427
65689	Bomba aceite a block	NB	1 1 310627
BDIM-9417A	Bomba nafta a block	NB	2 2 550428
BD5M-9417A	Bomba nafta	NB	1 1 310628
BD5M-9417A	Base bomba nafta	NFT	2 2 320628
48469	Tapa trasera tapa cilindros	NB	1 1 310631
65689	Bomba aceite a block	NB	1 1 310633
17138	Tapón cárter A 19 x 24 x 1.5 A	AL	1 1 320634
6071557	Base distribuidor	NB	1 1 550338
65583	Arandela tapa válvulas	GS	3 3 300742
	Jgo. suplemento camisa cilindros (4)	CU	1 550470-0.08
	Kit retenes completo		R310600
	Jgo. retén válvulas (8)	V	R310810V
	Retén bancada 82 x 105 x 12	P	1 R300711P
	Retén distribución 35 x 50 x 9	P	1 R550412P

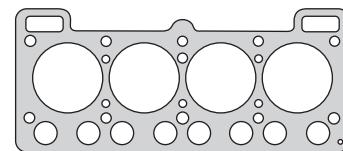

310605

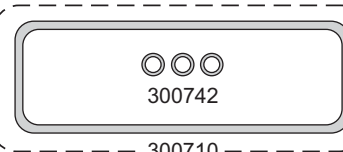

300742

300710

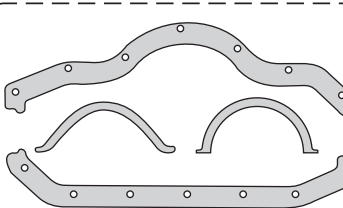

320611



320616

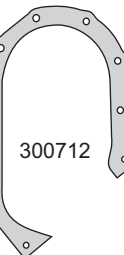

300712



560214



300018

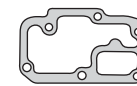

560219



310627



550325

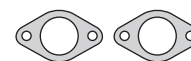

450025



320628



550427



550428



310631



310628



310633



550338



A 19 x 24 x 1.5 A



550470-0.08



R550412P



R300711P



R310810V

**FORD**



Motor/Engine	Cm³	HP	Ø
F302 V8	5000		101.6

Ford: Cougar, Continental, Granada  
Fairmont, Thunderbird



Nº OE	Descripción/Description	Mat.	Ref.
	Jgo. de juntas para motor	●	320700
	Jgo. jta. tapa cilin. Ø 104.5 ±1.20 (2)	NFT	320705
	Jgo. jta. tapa cilin. Ø 103.5 ±1.20 (2) NR	NFT	1 320707
	Junta tapa válvulas	CG	2 320710
	Jgo. junta para cárter (4)	CG	1 320711
	Tapa distribución	CB	1 320712
	Tapa bomba de agua	CB	1 320714
	Tapa bomba de agua	CB	1 320714-1
	Tapa bomba de agua	CB	1 320714-2
	Tapa bomba de agua	CB	1 320714-3
	Jgo. múltiple escape (2)	NFT	1 320715
	Jgo. múltipe admisión (2)	NFT	1 320717
	Salida de escape	FCH	2 300018
	Placa bomba de agua	CB	1 320719
	Bomba de nafta	CB	1 200028
	Chupador bomba de aceite	CB	1 320729
	Tapa bomba de agua	NFT	1 320730
	Base termostato	CB	1 320734
	Salida de gases	CB	1 320735
	Cierre admisión delantera	CG	1 320736
	Cierre admisión trasera	CG	1 320737
	EGR válvula	NFT	1 320739
	EGR tubo cónica 17 x 26	NFT	2 320740
	EGR tubo cónica 20 x 29	NFT	2 320741
	Acople bomba de aceite	CB	1 320744
	Filtro de aire 127 x 140	CB	1 320745
	Filtro de aire 134 x 146	CB	2 320746
	Acople bomba de aceite	CB	1 320747
	Jgo. de juntas sobreadmisión (2)	NFT	1 320748
	Arandela tapón cárter A 13 x 23 x 1.8 N	N	
	O´ring G 32.9 x 2.6	GS	
	Retén distribución 47.65 x 65.05 x 12	N	R300212N

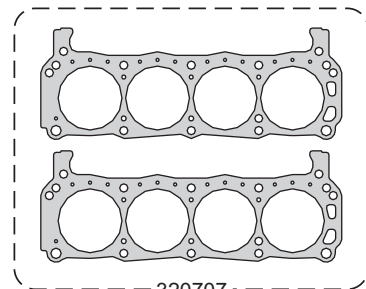

320707

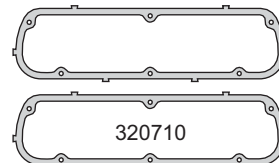

320710

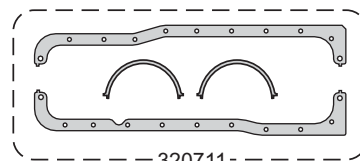

320711

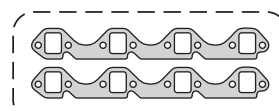

320715

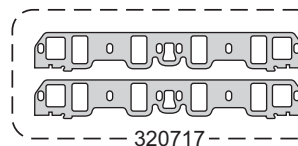

320717

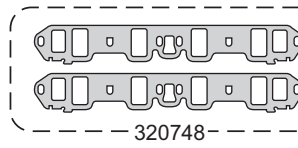

320748

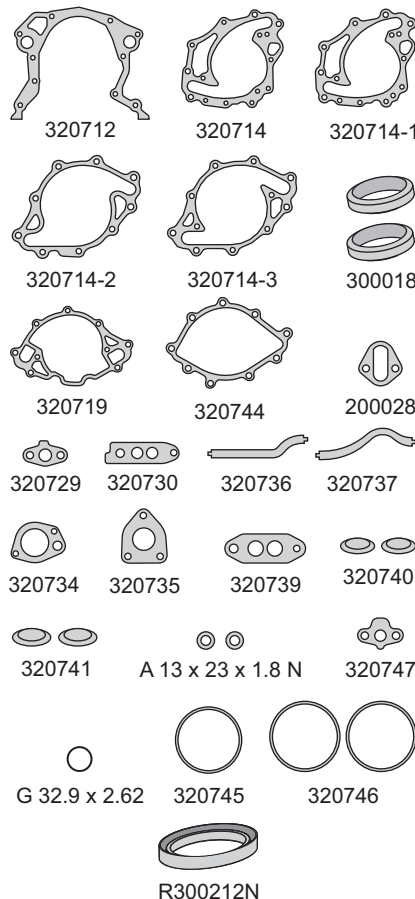

**FORD**



Motor/Engine Cm³ HP Ø

Zetec SE (DOHC) 16V 1388 90/75 76

Ford: Fiesta SE, Courier, Puma 1996/...



Nº OE	Descripción/Description	Mat.	Ref.
	Jgo. de juntas para motor		320900-R
	Jgo. de juntas superior	●	320995
	Jgo. de juntas superior (MLS)		320995 MLS
	Junta tapa cilindros Ø 78.0 ± 1.50	NFT 1 1	320907
	Junta tapa cilindros Ø 77.0 ± 1.40	MLS	320908
1012744 97MM6051BC	Jgo. tornillos tapa cilin. (HAT55055/55100)		B320900
1072018	Junta tapa válvulas	GS 1 1	320910
1004459	Junta para cárter	NFT 1	320911
1004452	Frente motor	NFT 1	320912
1007715	Bomba de agua	SLS 1	320914
1072066	Múltiple escape	AC 1 1	320915
1004476	Jgo. guarnición admisión (2)	V 1 1	320917
1018250	Termostato	NB 1 1	320919
	Junta goma	N 1	320929
	Junta cuerpo mariposa	N 1	320931
	Termostato	GS 1	560131
	Válvula IAC	N 1 1	320933
1663816	Arandela A 15 x 21 x 2 A	AL 1	
	Kit de retenes completo		R320900
	Jgo. retén válvulas (16)	V 1	R320910V
1143317	Porta retén bancada 80 x 128 x 19.4	T	PR320911T
1004457	Retén distribución 33 x 47 x 5	V 1	R320912V
1077686	Retén árbol levas 38 x 52 x 6	V 2	R320913V

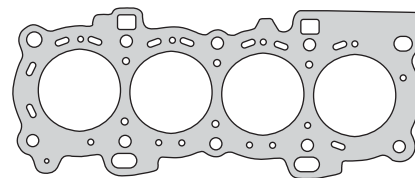

320907

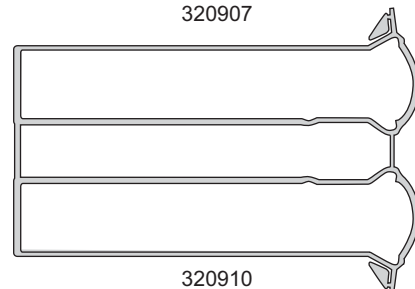

320910

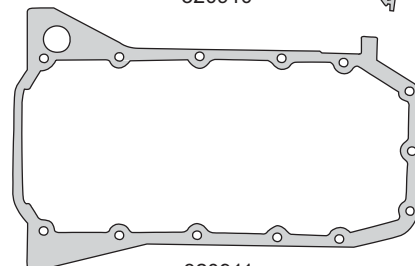

320911



320915

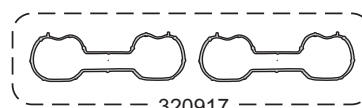

320917

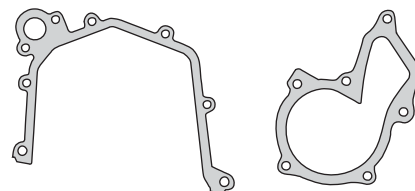

320912

320914



320919

320929

320931



560131

A 15 x 21 x 2 A

320933

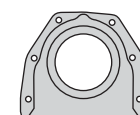

PR320911T



R320912V

R320913V



R320910V

**FORD**



Motor/Engine	Cm³	HP	Ø
F302L (OHV) V8 16V	5000		101.6

Ford: F100, F250, F350, Mustang  
Thunderbird, Bronco 1983/96



Nº OE	Descripción/Description	Mat.	Ref.
	<b>Jgo. de juntas para motor</b>		<b>321000-ET</b>
	Jgo. jta. tapa cilin. Ø 104.5 $\times$ 1.20 (2)	NFT	320705
	Jgo. jta. tapa cilin. Ø 103.5 $\times$ 1.20 (2) <b>NR</b>	NFT	1 320707
	Junta tapa válvulas	CG	2 320710
	Jgo. junta para cárter (4)	CG	1 320711
	Tapa distribución	CB	1 320712
	Tapa bomba de agua	CB	1 320714
	Tapa bomba de agua	CB	1 320714-1
	Tapa bomba de agua	CB	1 321014
	Tapa bomba de agua	CB	1 321014-1
	Jgo. múltiple escape (2)	NFT	1 320715
	Jgo. múltipe admisión (2)	NFT	1 320717
	Salida de escape	FCH	2 300018
	Placa bomba de agua	CB	1 320719
	Placa bomba de agua	CB	1 321019
	Junta base carburador	CB	1 321125
	Bomba de nafta	CB	1 200028
	Chupador bomba de aceite	CB	1 320729
	Junta válvulas E.G.R	NFT	1 321030
	Entre múltiple colector	CB	1 321033
	Entre múltiple colector	NFT	1 321034
	Base termostato	CB	1 320734
	Cierre admisión delantera	CG	1 320736
	Cierre admisión trasera	CG	1 320737
	Entrada aire	CB	1 340837
	Junta E.G.R	NFT	2 320739
	Junta brida	NB	2 321040
	EGR tubo cónica 17 x 26	NFT	2 320740
	EGR tubo cónica 20 x 29	NFT	2 320741
	Acople bomba de aceite	CB	1 320744
	Filtro de aire 127 x 140	CB	1 320745
	Filtro de aire 134 x 146	CB	2 320746
	Acople bomba de aceite	CB	1 320747
	Arandela tapón cárter A 13 x 23 x 1.5 C	CU	2
	O´ring G 32.99 x 2.62	GS	1

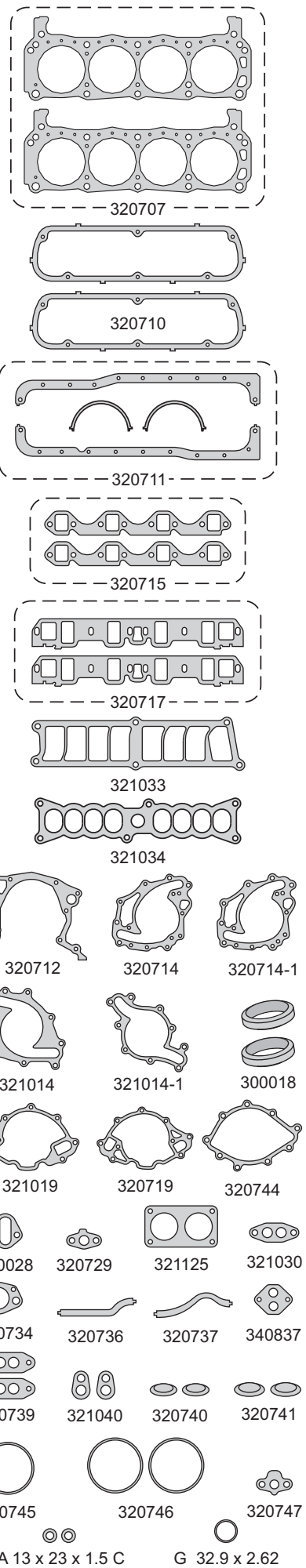

**FORD**



Motor/Engine	Cm³	HP	Ø
F351WL (OHV) V8 16V	5800		101.6

Ford: F100, F250, F350, Bronco 1985/95

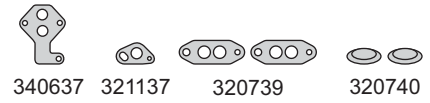
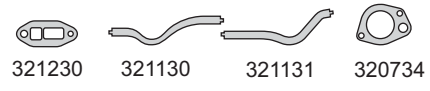
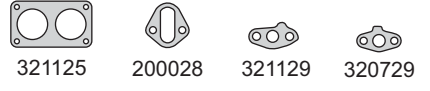
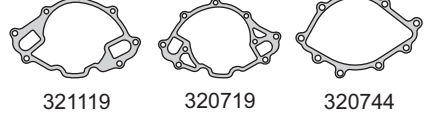
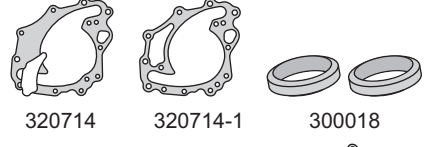
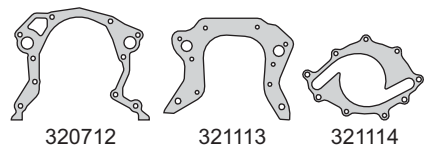
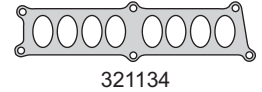
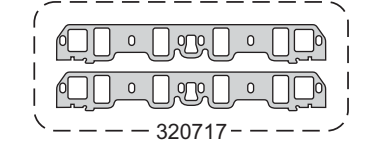
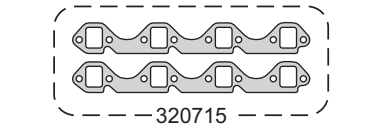
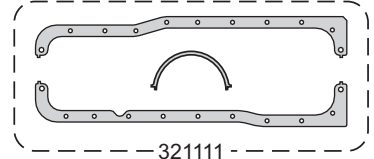
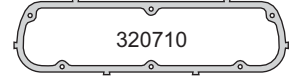
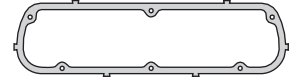
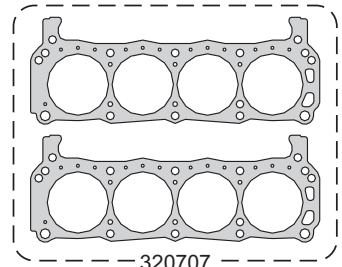

Nº OE	Descripción/Description	Mat.	Ref.
	Jgo. de juntas para motor		● 321100-ET
	Jgo. de juntas para motor		321101-ET
	Jgo. jta. tapa cilin. Ø 104.5 ± 1.20 (2)		NFT 320705
	Jgo. jta. tapa cilin. Ø 103.5 ± 1.20 (2)		NFT 1 320707
	Junta tapa válvulas		CG 2 320710
	Jgo. junta para cárter (3)		CG 1 321111
	Tapa distribución		CB 1 320712
	Placa distribución		CB 1 321113
	Tapa bomba de agua		CB 1 320714
	Tapa bomba de agua		CB 1 320714-1
	Tapa bomba de agua		CB 1 321114
	Jgo. múltiple escape (2)		NFT 1 320715
	Jgo. múltiple admisión (2)		NFT 1 320717
	Salida de escape		FCH 2 300018
	Placa bomba de agua		CB 1 321119
	Placa bomba de agua		CB 1 320719
	Base carburador		CB 1 321125
	Bomba de nafta		CB 1 200028
	Chupador bomba de aceite		CB 1 320729
	Junta brida		CB 1 321129
	Junta		NFT 1 321230
	Cierre admisión delantera		CG 1 321130
	Cierre admisión trasera		CG 1 321131
	Entre colector admisión		CB 1 321134
	Base termostato		CB 1 320734
	Junta brida		NB 1 321137
	Junta entrada de aire		CB 1 340637
	EGR válvula		NFT 2 320739
	EGR tubo cónica 17 x 26		NFT 2 320740
	EGR tubo cónica 20 x 29		NFT 2 320741
	Acople bomba de aceite		CB 1 320744
	Filtro de aire 127 x 140		CB 1 320745
	Filtro de aire 134 x 146		CB 2 320746
	Arandela tapon cárter A 13 x 23 x 1.5 C		CU 2
	O'ring G 32.99 x 2.62		GS 1

**FORD**



Motor/Engine Cm³ HP Ø

**F351W**  
(OHV) V8 16V **5000** **101.6**

Ford: F250, F350, Mustang



Nº OE	Descripción/Description	Mat.	Ref.
	<b>Jgo. de juntas para motor</b>		<b>321200-R-ET</b>
	<b>Jgo. jta. tapa cilin. Ø 104.5 ±1.20 (2)</b>	<b>NFT</b>	<b>320705</b>
	<b>Jgo. jta. tapa cilin. Ø 103.5 ±1.20 (2)</b>	<b>NFT</b>	<b>320707</b>
	Junta tapa válvulas	<b>CG</b>	<b>320710</b>
	Jgo. junta para cárter (3)	<b>CG</b>	<b>321111</b>
	Tapa distribución	<b>CB</b>	<b>320712</b>
	Tapa bomba de agua	<b>CB</b>	<b>320714</b>
	Tapa bomba de agua	<b>CB</b>	<b>320714-1</b>
	Tapa bomba de agua	<b>CB</b>	<b>320714-3</b>
	Jgo. múltiple escape (2)	<b>NFT</b>	<b>320715</b>
	Jgo. múltipe admisión (2)	<b>NFT</b>	<b>320717</b>
	Jgo. múltipe admisión (2)	<b>NFT</b>	<b>321217</b>
	Salida de escape	<b>FCH</b>	<b>300018</b>
	Placa bomba de agua	<b>CB</b>	<b>320719</b>
	Bomba de nafta	<b>CB</b>	<b>200028</b>
	Chupador bomba de aceite	<b>CB</b>	<b>320729</b>
	Junta brida	<b>CB</b>	<b>321129</b>
	Junta brida	<b>NFT</b>	<b>321230</b>
	Base termostato	<b>CB</b>	<b>320734</b>
	Cierre admisión delantera	<b>CG</b>	<b>321130</b>
	Cierre admisión trasera	<b>CG</b>	<b>321131</b>
	EGR válvula	<b>NFT</b>	<b>320739</b>
	EGR tubo cónica 17 x 26	<b>NFT</b>	<b>320740</b>
	EGR tubo cónica 20 x 29	<b>NFT</b>	<b>320741</b>
	Acople bomba de aceite	<b>CB</b>	<b>320744</b>
	Acople bomba de aceite	<b>CB</b>	<b>320747</b>
	Filtro de aire 127 x 140	<b>CB</b>	<b>320745</b>
	Filtro de aire 134 x 146	<b>CB</b>	<b>320746</b>
	Arandela tapon cárter A 13 x 23 x 1.5 C	<b>N</b>	<b>2</b>
	O´ring G 32.99 x 2.62	<b>GS</b>	<b>1</b>
	Retén distribución 47.65 x 65.05 x 12	<b>N</b>	<b>R300212N</b>

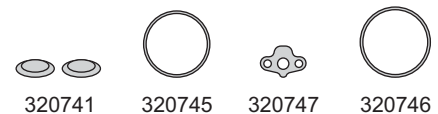
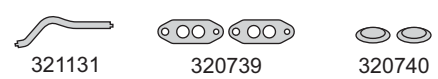
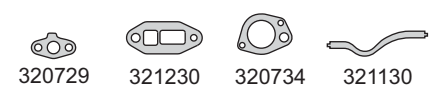
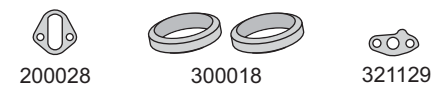
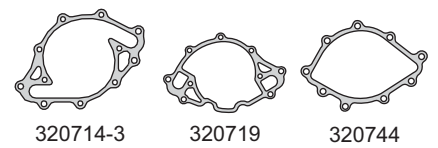
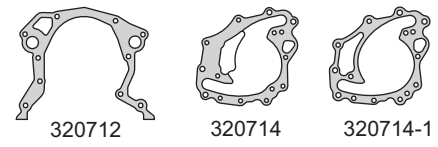
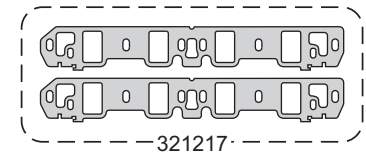
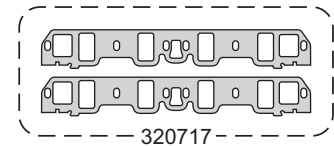
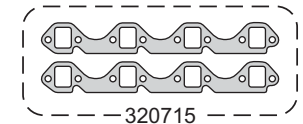
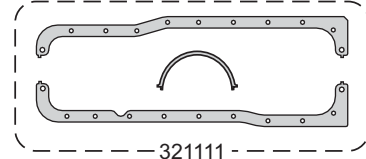
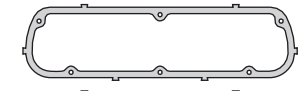
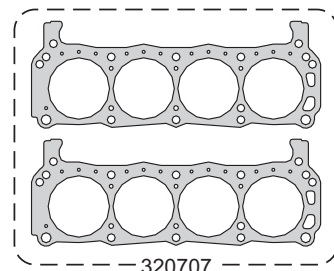



**FORD**



Motor/Engine	Cm³	HP	Ø
ZETEC (DOHC) 16V	1796	115	80.6

Ford: Mondeo 1993/...



Nº OE	Descripción/Description	Mat.	Ref.
	Jgo. de juntas para motor		321300-R
	Jgo. de juntas superior		321395
	Jta. tapa cilindros Ø 81.7 ±1.60	NFT	320305
7114447	Jta. tapa cilindros Ø 81.7 ±1.60 <b>NR</b>	NFT	320307
	Jgo. tornillos tapa cilin. (HAT55055/55100)		B320300
1663394	Conj. junta tapa válvulas (11)	GS	320310
7008824	Junta para cárter	N	320311
7378788	Frente bomba aceite	CB	320312
6691888	Bomba de agua	CB	320314
7181761	Múltiple escape	AC	320315
6669767	Junta aislante admisión	AL/GS	321517
	Entre placa admisión	CB	320329
	Junta caja termostato	CB	320332
	Junta	SLS	340833
1663908	Chupador aceite	CB	320334
7090340	Mariposa gases	CB	320335
1663861	Bancada trasera	CB	320336
6759630	Anillo tapa válvulas G 8.5 x 13.4 x 5	GS	320337
6692744	Acople caño de escape		320048
	Arandela cárter A 15 x 21 x 2 A	AL	
	Kit de retenes completo		R320300
	Jgo. retén válvulas (16)	V	R320310V
	Retén bancada 88 x 108 x 10	V	R320311V
	Retén distribución 35 x 50 x 7	V	R470013V
	Retén árbol levas 42 x 53 x 7	V	R320313V

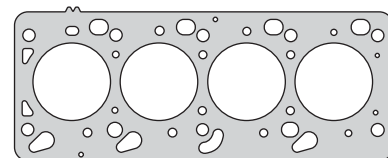

320307

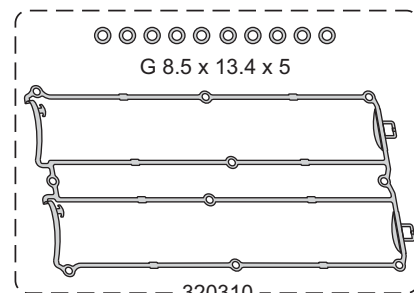

G 8.5 x 13.4 x 5

320310

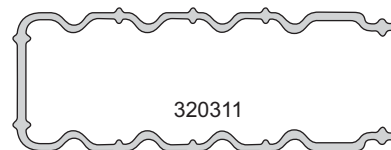

320311



320315

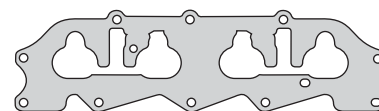

321517

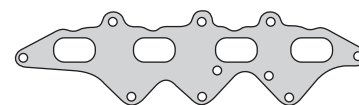

320329



320312

320336



320314

320332

340833



320334

A 15 x 21 x 2A

320335



R320311V



R470013V



R320313V

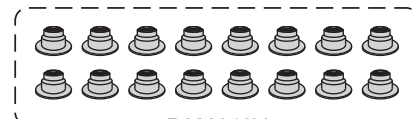

R320310V

**FORD**



Motor/Engine	Cm³	HP	Ø
FXJA/FXJB/FXJC	1388	80	76
RTJA/RTJB/RTJC	1388	86/92	76
SPJA/SPJC/SPJD (DOHC) 16V	1388	90/97	76

Ford: Fiesta VI 2008/... - B-Max 2012/...  
Fusion 2002/... - 2010/...



Nº OE	Descripción/Description	Mat.	Ref.
	Jgo. de juntas para motor		● 321400-R MLS
	Jgo. de juntas superior (MLS)	●	321495 MLS
	Junta tapa cilindros Ø 77 $\pm$ 0.30	MLS 1 1	321408
	Jgo. tornillos tapa cilin. (HAT55055/55100)		B320900
	Sellador líquido - caucho de silicona		TRN0085G
1S6G6K260AA	Junta tapa válvulas	GS 1 1	321610
1004459	Junta para cárter	NFT 1	320911
BM5G6659BA	Junta distribución	SLS	321612
1004452	Frente motor	NFT 1	320912
BE8Z8507A	Bomba de agua	SLS 1	320914
844524J2WP	Múltiple escape	SLS 1 1	321615
4M5G9441FA	Jgo. múltiple admisión (4)	GS 1 1	321417
2S619451AC	Salida de escape	AC 1	321618
7M5Z8255A	Bomba de agua	GS 1	321619
BE8Z8255A	Termostato	N 1	320929
BE8Z8255Z	Válvula IAC	GS 1	560131
4M5G9P84BCA	Guarnición	GS 1 1	321432
AM4S6G9186AA	O´ring Inyector G 7.52 x 3.53	V 8 8	
	Kit de retenes completo		R320900
	Jgo. retén válvulas (16)	V 1	R320910V
BM5Z6K301B	Porta retén bancada 80 x 128 x 19.4	T	PR320911T
	Retén distribución 33 x 47 x 5	V 1	R320912V
6M5G6K292BA	Retén árbol levas 38 x 52 x 6	V 2	R320913V

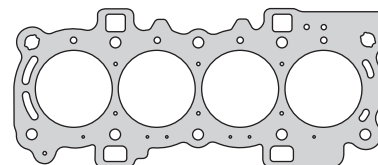

321408

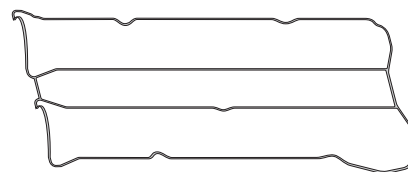

321610

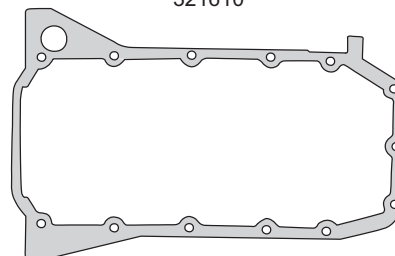

320911



321615



321417

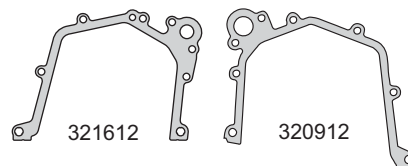

321612

320912

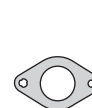

321618



320914



321619



320929



560131



321432



G 7.52 x 3.53

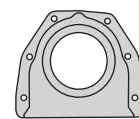

PR320911T



R320912V



R320913V

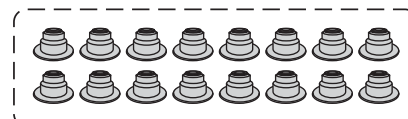

R320910V

**FORD**



Motor/Engine **Cm³** **HP** **Ø**  
**ZETEC**  
 (DOHC) 16V

Ford: Mondeo 1993/01



Nº OE	Descripción/Description	Mat.		Ref.
	Jgo. de juntas para motor			321500-R
	Jgo. de juntas superior		●	321595
7114447	Jta. tapa cilindros Ø 87.0 $\pm$ 1.70	NFT	1	320507
	Jgo. tornillos tapa cilin. (HAT55055/55100)			B320300
1663394	Conj. junta tapa válvulas (11)	GS	1	320310
7008824	Junta para cárter	N	1	320311
7378788	Frente bomba aceite	CB	1	320312
6691888	Bomba de agua	CB	1	320314
7181761	Múltiple escape	AC	1	320315
6669767	Jgo. junta aislante admisión	AL/GS	1	321517
1048093	Jgo. juntas múltiple admisión 1997/... (4)	N	1	320517
1663383	Múltiple admisión	CB	1	320329
	Junta caja termostato	CB	1	320332
	Junta	SLS	1	340833
1663908	Chupador aceite	CB	1	320334
7090340	Mariposa gases	CB	1	320335
1663861	Bancada trasera	CB	1	320336
6759630	Anillo tapa válvulas G 8.5 x 13.4 x 5	GS	10	320337
6692744	Acople caño de escape			320048
	Arandela cárter A 15 x 21 x 2 A	AL	1	
	Kit de retenes completo			R320300
	Jgo. retén válvulas (16)	V	1	R320310V
	Retén bancada 88 x 108 x 10	V	1	R320311V
	Retén distribución 35 x 50 x 7	V	1	R470013V
	Retén árbol levas 42 x 53 x 7	V	2	R320313V

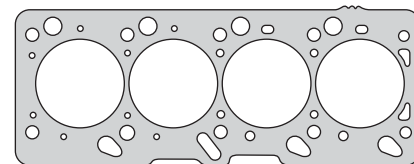

320507

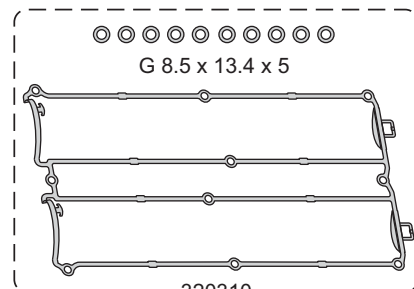

320310

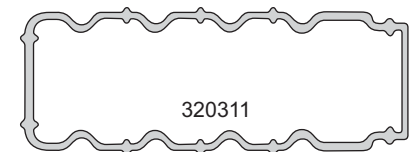

320311

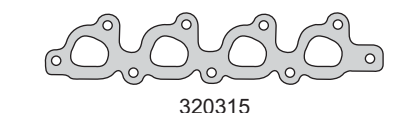

320312

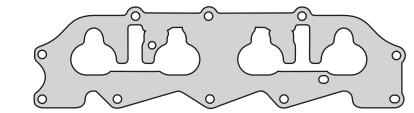

320314

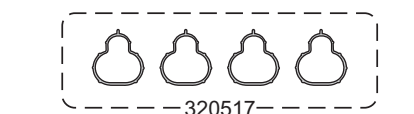

320315

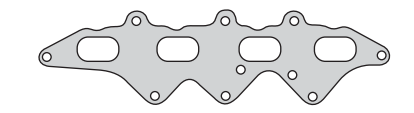

320517

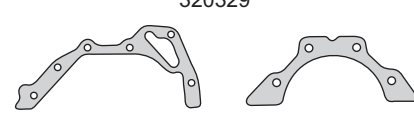

320329

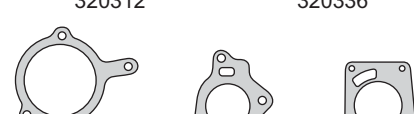

320332

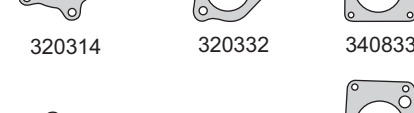

320334

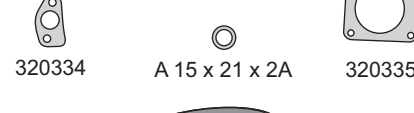

320335

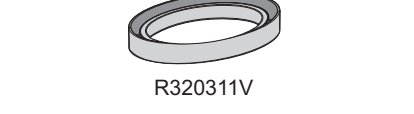

320336

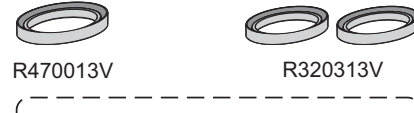

320337



R320310V



R320311V



R470013V



R320313V

**FORD**



Motor/Engine	Cm³	HP	Ø
Sigma	1499	104	79
L4 Sigma	1596	100	79
HWDA/HWDB	1596	100	79
FYJA	1596	100	79
B4164S3 (DOHC) 16V	1596	101	79

**Ford:** 1.5 Ka 2016/...  
1.6 Fiesta, Fusión 2003/...  
Focus 2004/..., C-Max 2007/...

**Volvo:** 1.6 C30, S40, V50 2005/...



Nº OE	Descripción/Description	Mat.	Ref.
	Jgo. de juntas para motor		321600-R MLS
	Jgo. de juntas superior (MLS)	●	321695 MLS
	Jgo. de juntas superior		321695
	Junta tapa cilindros Ø81.0 ± 1.20	NFT	321607
1471557	Junta tapa cilindros Ø80.5 ± 0.35	MLS 1 1	321608
	Jgo. tornillos tapa cilin. (HAT55055/55100)		B320900
	Sellador líquido - caucho de silicona		TRN0085G
1S6G6K260AA	Junta tapa válvulas	GS 1 1	321610
1004459	Junta para cárter	NFT 1	320911
BM5G6659BA	Junta distribución	SLS	321612
1004452	Frente motor	NFT 1	320912
BE8Z8507A	Bomba de agua	SLS 1	320914
	Bomba de agua	NB 1	321614
844524J2WP	Múltiple escape	SLS 1 1	321615
4M5G9441FA	Jgo. múltiple admisión (4)	1 1	321617
2S619451AC	Salida de escape	AC 1	321618
7M5Z8255A	Conexión carcasa de agua	GS	321619
	Termostato	N 1	320929
BE8Z8255A	Válvula termostato	GS	321629
BE8Z8255Z	Válvula IAC	GS 1	560131
4M5G9P84BCA	Guarnición	GS 1 1	321632
	Guarnición bomba de agua	GS 1	321633
AM4S6G9186AA	O'ring Inyector G 7.52 x 3.53	V 4 4	
	Kit de retenes completo		R320900
	Jgo. retén válvulas (16)	V 1	R320910V
BM5Z6K301B	Porta retén bancada 80 x 128 x 19.4	T	PR320911T
	Retén distribución 33 x 47 x 5	V 1	R320912V
6M5G6K292BA	Retén árbol levas 38 x 52 x 6	V 2	R320913V

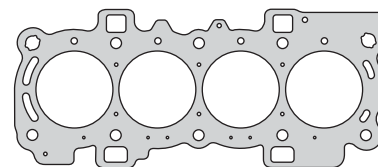

321608

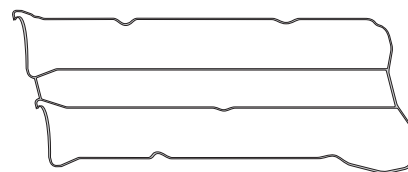

321610

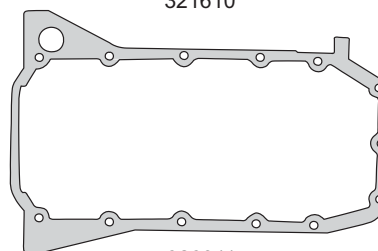

320911



321615

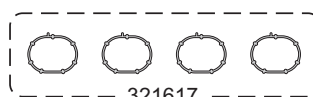

321617

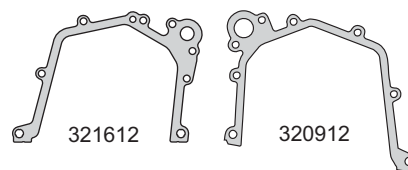

321612

320912

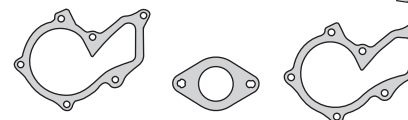

320914

321618

321614

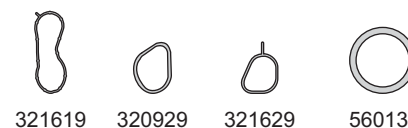

321619

320929

321629

560131

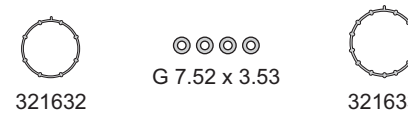

321632

G 7.52 x 3.53

321633

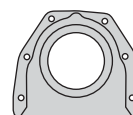

PR320911T

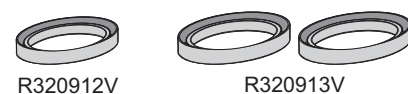

R320912V

R320913V

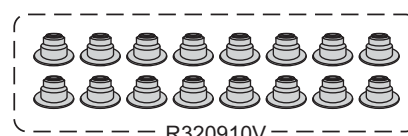

R320910V

**FORD**



Motor/Engine	Cm³	HP	Ø
Ti-VCT Eco Boost (DOHC) 12V	997	85	71.9

Ford: Ka 2016/...



Nº OE	Descripción/Description	Mat.	Ref.
	<b>Jgo. de juntas para motor</b>		● 321700-R MLS
	Junta tapa cilindros Ø 73.0 ± 1.20	NFT	321707
	Junta tapa cilindros Ø 73.5 ± 0.60	MLS	1 321708
CM5Z/6065/A	Jgo. tornillos tapa cilindros		B321700
E3BG/6K260/EA	Junta tapa válvulas	GS	1 321710
	Junta para cárter	NB	1 321711
CM5Z/8507/A	Bomba de agua	SLS	1 321714
	Bomba de agua	GS	1 321714-1
CM5G/9L461/BA	Colector escape	AC	1 321715
E3BZ/9424/A	Jgo. múltiple admisión (4)	GS	1 321717
2S61/9451/AC	Salida de escape	AC	1 321618
CM5Z/8255/A	Junta termostato	GS	1 321719
BM5Z/2A572/A	Junta inspección tapa de cilindros	SLS	1 321726
CM5Z/8255/B	Guarnición distribución	GS	1 321731
CM5Z/6C535/A	Anillo sellador avance guía de válvulas G 52 x 55.5 x 5.2	GS	1 321732
	Guarnición goma	GS	1 321733
	Junta brida	AC	1 321734
CM51/6M265/AB	Anillo impulsor	AC/N	1 321738
	Junta turbo	AC	1 321741
	Junta Turbo	AC	1 321742
W715775/S3/00	Anillo entrada bomba de agua G 32 x 3.5	GS	1
W715774/S3/00	Anillo entrada de agua G 10 x 3	GS	1
W715778/S3/00	Anillo válvula termostato G 43 x 3	GS	1
W715777/S3/00	Anillo válvula termostato G 28 x 2.5	GS	2
W704553/S3/00	Anillo válvula termostato G 46.7 x 55.8 x 7.25	GS	1
97JM/6734/BA	Anillo sellado de aceite A 12.5 x 22.5 x 3	GS	1
	Kit de retenes completo		R321700
BM5Z/6571/A	Jgo. retén válvulas (12)	V	1 R321710V
CM5Z/6335/A	Porta retén bancada	V	PR321711V
	Retén de distribución 55 x 70 x 8	V	1 R321712V
CM5Z/6700/B	Retén árbol de levas 42 x 55 x 7	V	1 R321713V

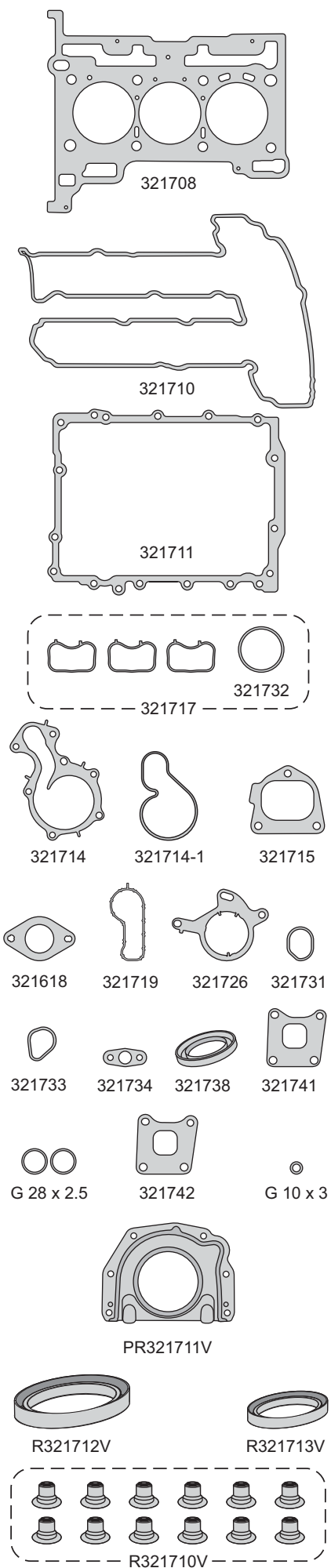

**FORD**



Motor/Engine	Cm³	HP	Ø
260 V8	4300		96
289 V8	4800		96
302 V8 (OHV) 16V	5000		96

**Ford:** Galaxy 500 - Fairlane - Falcon - Maverich  
Mustang - Grand Marquis - F150 - F250  
1965/84



Nº OE	Descripción/Description	Mat.		Ref.
	Jgo. de juntas para motor		●	321800-RMX
	Jgo. de juntas superior		●	321895
	Jgo. jta. tapa cilindros Ø104.0 ±1.40 (2)	NFT	1 1	310105
	Junta tapa de válvulas	CG	2 2	320710
	Jgo. junta para cárter	CG	1	320711
	Puntera para cárter	CG	1	320711/4
	Puntera para cárter	CG	1	320711/5
	Jgo. frente distribución (9)	VS	1	320712MX
	Tapa distribución	CB	1	320712
	Tapa bomba de agua	CB	1	320714
	Placa bomba de agua	CB	1	320714/2
	Placa bomba de agua	CB	1	320714/3
	Jgo. múltiple escape (2)	NFT	1 1	320715
	Salida de escape	FCH	2 2	300018
	Placa bomba de agua	CB	1	320719
	Junta motor	NB	1	320720
	Bomba de nafta	CB	1	200028
	Chupador bomba de aceite	CB	1	320729
	Base termostato	CB	1 1	320734
	Cierre admisión delantera	CG	1 1	320736
	Cierre admisión trasera	CG	1 1	320737
	Acople bomba de aceite	CB	1	320747
	Juntas sobre admisión	NFT	2 2	320748
	Jgo. de juntas sobreadmisión (4)	VS	1 1	320748MX
	Junta brida	CB	1	320761
	Junta motor	NFT	2	320762
	Arandela A 14 x 18 x 1.5 A	AL	1	
	Kit de retenes completo			R321800
	Jgo. retén válvulas (16)	P	1	R320710P
	Retén bancada 92 x 106 x 5	P	1	R321811P
	Retén distribución 48 x 65 x 7.85	N	1	R320712N

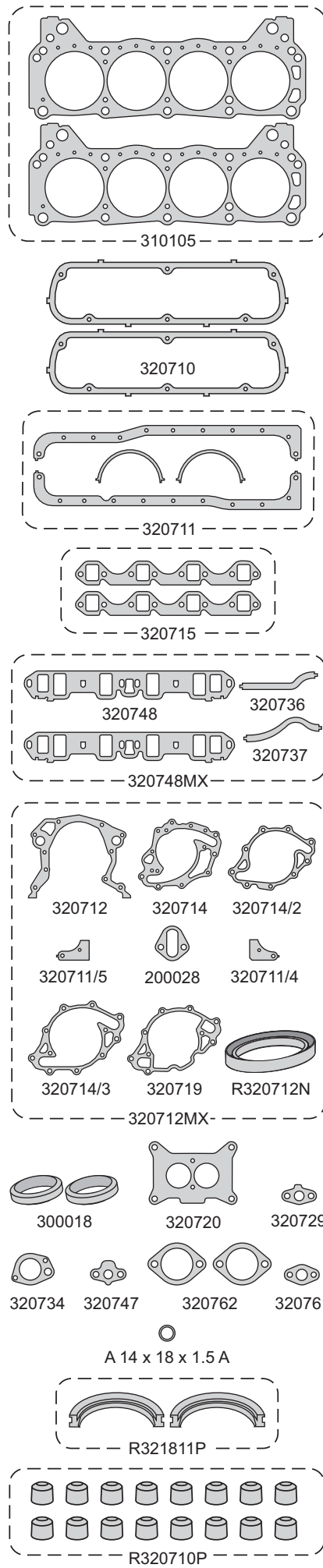

**FORD**



Motor/Engine Cm³ HP Ø

302 (OHV) V8 16V 5000 96

Ford: Cougar, Thunderbird, F200, F350 1991/95



Nº OE	Descripción/Description	Mat.	1	2	Ref.
	Jgo. de juntas para motor		●	●	321900-RMX
	Jgo. de juntas superior		●		321995
	Jgo. tapa cilin. Ø 104.5 ± 1.20 (2)	NFT	1	1	320705
	Jgo. tapa cilin. Ø 103.5 ± 1.20 (2)	NFT			320707
	Junta tapa de válvulas	CG	2	2	320710
	Jgo. junta para cárter (4)	CG		1	320711
	Tapa distribución	CB		1	320712
	Bomba de agua	CB		1	320214
	Tapa bomba de agua	CB		1	321014
	Tapa bomba de agua	CB		1	321014-1
	Jgo. múltiple escape (2)	NFT	1	1	320715
	Jgo. múltiple admisión (6)	NFT	1	1	320717-1
	Junta termostato	CB		1	321019
	Placa bomba de agua	CB		1	320719
	Bomba de nafta	CB		1	200028
	Chupador bomba de aceite	CB		1	320729
	Junta cierre admisión delantera	CG	1	1	321130
	Junta cierre admisión trasera	CG	1	1	321131
	Entre múltiple colector	CB	1	1	301033
	Entre múltiple colector	NFT	1	1	301034
	Base termostato	CB	1	1	320734
	Junta motor	NFT		1	340635
	Cierre admisión delantera	CG	1	1	320736
	Cierre admisión trasera	CG	1	1	320737
	Junta EGR	NFT	1	1	320739
	Arandela A 14 x 18 x 1.5 A	AL		1	
	O´ring G 31.42 x 2.62	GS		1	
	Kit de retenes completo				R321900
	Jgo. retén válvulas (16)	P		1	R340510P
	Retén bancada 92 x 108 x 9.8	P		1	R300311P
	Retén distribución 48 x 65 x 7.85	N		1	R320712N

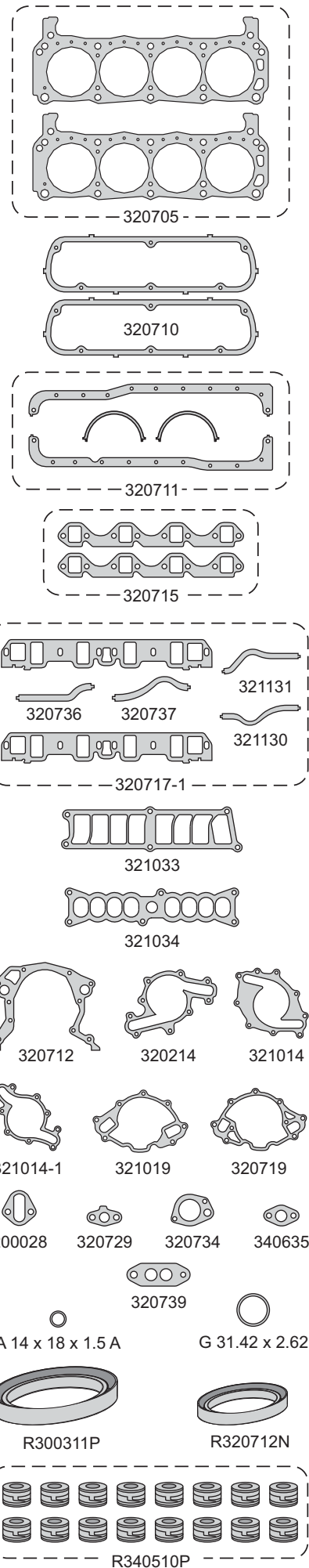

**FORD**



Motor/Engine	Cm³	HP	Ø
335	5500		101.6
351	5752		101.6
(OHV) V8 16V			

Ford: F250, F350, F600, Microbus (Chasis) 1984/91



Nº OE	Descripción/Description	Mat.		Ref.
	Jgo. de juntas para motor			322000-RMX
	Jgo. de juntas superior		●	322095
	Jgo. tapa cilin. Ø 104.5 ± 1.20 (2)		NFT 1 1	320705
	Jgo. tapa cilin. Ø 103.5 ± 1.20 (2) <b>NR</b>		NFT	320707
	Junta tapa de válvulas		CG 2 2	320710
	Jgo. junta para cárter (4)		CG 1 1	321111
	Tapa distribución		CB 1 1	320712
	Jgo. múltiple escape (2)		NFT 1 1	320715
	Jgo. junta sobre admisión (4)		VS 1 1	322017
	Salida de escape		FCH 2 2	300018
	Placa bomba de agua		CB 1 1	320719
	Junta		NB 1 1	320720
	Bomba de nafta		CB 1 1	200028
	Junta brida		CB 1 1	321129
	Junta cierre admisión delantera		CG 1 1	321130
	Junta cierre admisión trasera		CG 1 1	301131
	Entre múltiple colector		CB 1 1	321033
	Entre múltiple colector		NFT 1 1	321034
	Base termostato		CB 1 1	320734
	Junta sobre admisión		NFT 2 2	320748
	Junta brida		CB 1 1	320761
	O´ring G 7.52 x 3.53		GS 16 16	
	Arandela A 14 x 18 x 1.5 A		AL	1
	Kit de retenes completo (16)			R322000
	Jgo. retén válvulas (16)		P 1	R320710P
	Retén bancada 95 x 114.5 x 9.5		P 1	R340911P
	Retén distribución 48 x 65 x 7.85		N 1	R320712N

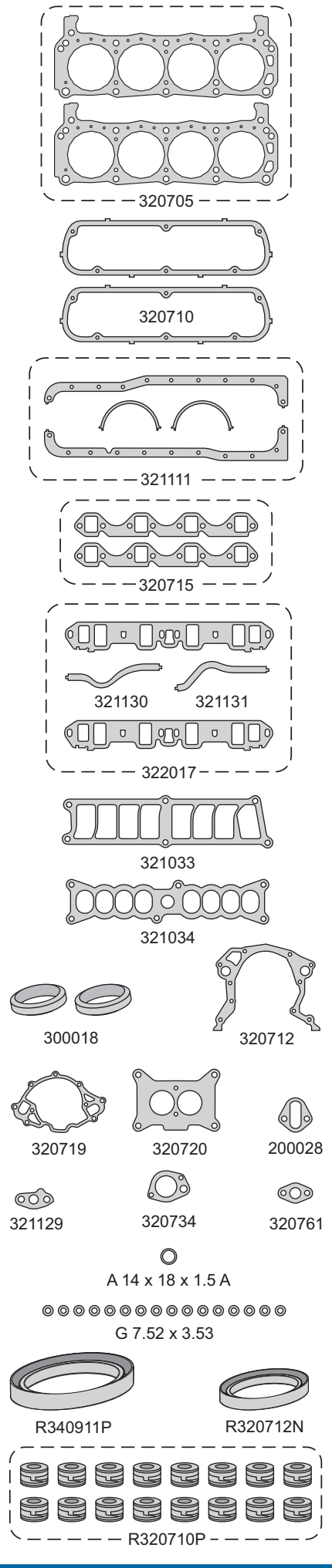



**FORD**



Motor/Engine	Cm³	HP	Ø
351 (OHV) V8 16V	5000		101.6

Ford: Grand Marquis - Galaxy - Camiones  
F250 - Mustang - F350 - FB 600 1969/84



Nº OE	Descripción/Description	Mat.	Ref.
	Jgo. de juntas para motor		322100-RMX
	Jgo. de juntas superior		322195
	Jgo. junta tapa cilin. Ø 104.5 ± 1.20 (2)	NFT 1 1	320705
	Jgo. tapa cil. Ø 103.5 ± 1.20 (2)	NFT	320707
	Junta tapa válvulas	CG 2 2	320710
	Jgo. junta para cárter (4)	CG 1 1	322111
	Tapa distribución	CB 1 1	320712
	Jgo. múltiple escape (2)	NFT 1 1	322116
	Jgo. junta sobre admisión (4)	VS 1 1	322017
	Salida de escape	FCH 2 2	300018
	Placa bomba de agua	CB 1 1	320719
	Junta	NB 1 1	320720
	Bomba de nafta	CB 1 1	200028
	Junta	CB 1 1	321129
	Junta	CG 1 1	321130
	Junta	CG 1 1	321131
	Base termostato	CB 1 1	320734
	Juntas sobreadmisión	NFT 2 2	320748
	Junta	CB 1 1	320761
	Arandela A 14 x 18 x 1.5 A	AL 1 1	
	Kit de retenes completo		R322100
	Jgo. retén válvulas (16)	P 1 1	R320710P
	Retén bancada 96 x 110 x 5.5	P 1 1	R322111P
	Retén distribución 48 x 65 x 7.9	N 1 1	R320712N

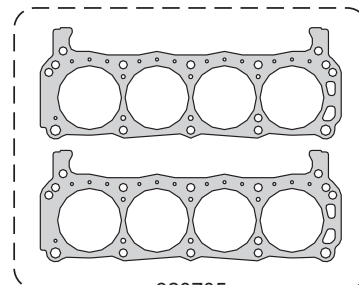

320705

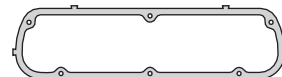

320710

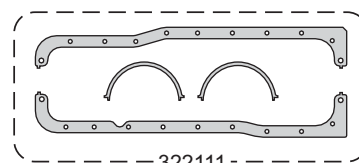

322111

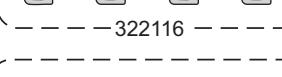

322116

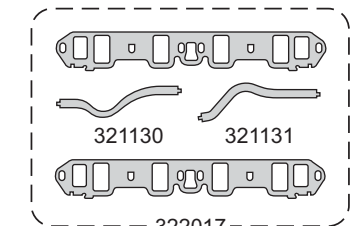

321130 321131

322017

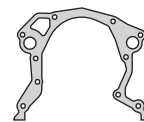

320712

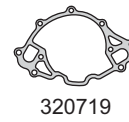

320719

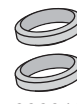

300018

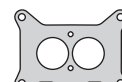

320720



200028



321129



320734

A 14 x 18 x 1.5 A

320761



R321111P



R320712N



R320710P

**FORD**



Motor/Engine	Cm³	HP	Ø
110	1769	104	78
121	1970	104	78
123	2000	104	80

Ford: Courier 1972/82



Nº OE	Descripción/Description	Mat.	Ref.
	<b>Jgo. de juntas para motor</b>		<b>322200-RMX</b>
	<b>Junta tapa de cilindros Ø 82.0 ± 1.20</b>	NFT 1	<b>322205</b>
	Jgo. junta tapa válvulas (3)	CG 1	322210
	Junta para cárter	CG 1	970311
	Tapa distribución	NB 1	970312
	Tapa distribución	NB 1	970313
	Bomba de agua	CB 1	322214
	Bomba de agua	CB 1	970314
	Jgo. múltiple escape (4)	NFT 1	322216
	Jgo. múltiple escape (2)	NFT 1	970316
	Múltiple admisión	NB 1	970317
	Salida de escape	NFT 1	970318
	Junta	NB 2	322220
	Junta	NB 2	322221
	Base bomba aceite	NB 1	970327
	Junta	NB 1	322231
	Junta	NB 1	322232
	Junta	NB 1	970332
	Junta	CG 1	322233
	Junta	NFT 1	322234
	Junta	NFT 1	322235
	Junta	NFT 1	322237
	Junta	CG 1	322238
	Junta	NB 1	322239
	Junta	NB 1	322240
	Junta	NB 1	322241
	Junta	GS 2	322242
	Arandela A 18 x 22 x 1.5 A	AL 1	
	O´ring G 9.25 x 1.78	GS 1	
	O´ring G 21.95 x 1.78	GS 1	
	O´ring G 15.54 x 2.62	GS 1	
	O´ring G 25.07 x 2.62	GS 1	
	O´ring G 29.74 x 3.53	GS 1	
	O´ring G 53.57 x 3.53	GS 1	
	Kit de retenes completo		R322200
	Jgo. retén válvulas (8)	P 1	R322210P
	Retén bancada 80 x 105 x 13	P 1	R970311P
	Retén distribución 48 x 70 x 9	P 1	R900012P

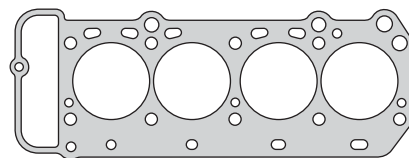

322205

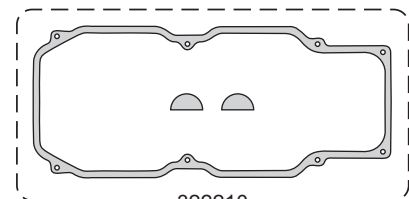

322210

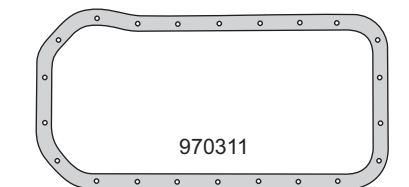

970311

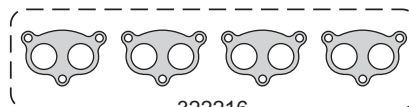

322216

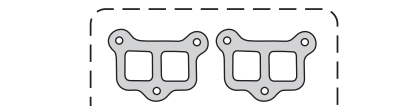

970316



970317

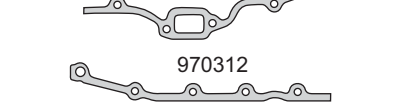

970312



970313

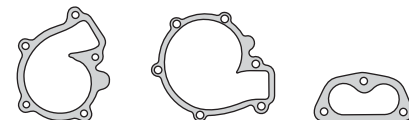

970314

322214

970318

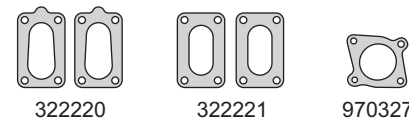

322220

322221

970327

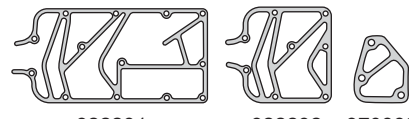

322231

322232

970332



322233

322234

322235

322237

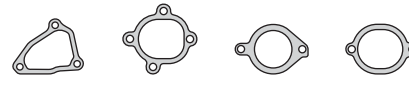

322238

322239

322240

322241



R970311P

R900012P

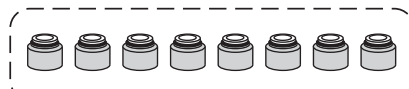

R322210P

**FORD**



Motor/Engine	Cm³	HP	Ø
232 (OHV) V6 12V	3797	140/205	97

Ford: Thunderbird, Cougar Super Cargado  
Taurus, Sable 1988/93



Nº OE	Descripción/Description	Mat.	Ref.
	Jgo. de juntas para motor		322300-RMX
	Jgo. de juntas superior	●	322395
	Jgo. jta. tapa cil. Ø 99 ± 1.30 (2)	NFT 1 1	322307
	Junta tapa valvulas	GS 2 2	320210
	Jgo. junta para cárter (2)	CG 1 1	320211
	Tapa distribución	CB 1 1	320212
	Tapa bomba de agua	CB 1 1	320214
	Jgo. múltiple escape (2)	NFT 1 1	320215
	Jgo. multiple admisión (2)	NFT 1 1	320216
	Junta succión aceite	NFT 1 1	310927
	Junta	NFT 1 1	322330
	Junta cierre admisión delantera	CG 1 1	320231
	Junta	CB 1 1	322331
	Junta cierre admisión trasera	CG 1 1	320232
	Junta	CB 1 1	322332
	Junta entrada aire	CB 1 1	310936
	Arandela A 16 x 19 x 1 C	CU 1 1	
	O'ring G 29.2 x 1.78	GS 1 1	
	O'ring G 28.24 x 2.62	GS 2 2	
	O'ring G 71.12 x 2.62	GS 1 1	
	O'ring G 7.52 x 3.53	GS 6 6	
	O'ring G 34.52 x 3.53	GS 1 1	
	Kit de retenes completo		R322300
	Jgo. retén válvulas (12)	P 1 1	R322310P
	Retén bancada 92 x 108 x 9.8	P 1 1	R300311P
	Retén distribución 47 x 65/80 x 15	P 1 1	R340412P

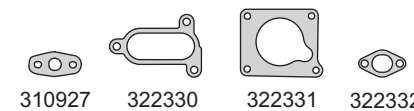
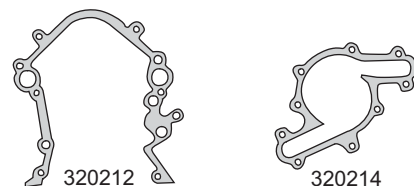
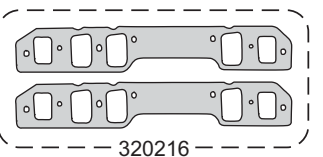
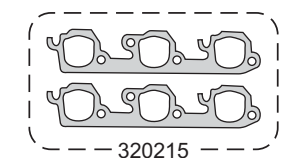
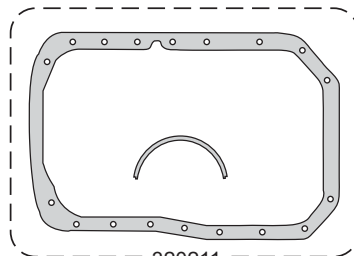
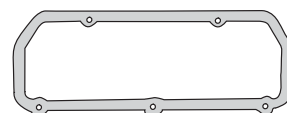
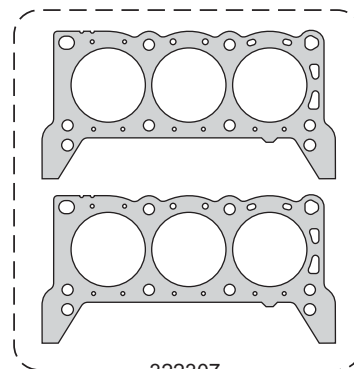

**FORD**



Motor/Engine	Cm³	HP	Ø
171 (OHV) V6 12V	2792	160	93

Ford: Bronco, Grandada, Capri 1983/86



Nº OE	Descripción/Description	Mat.	Ref.
	<b>Jgo. de juntas para motor</b>		<b>322400-RMX</b>
	<b>Jgo. junta tapa cilindros Ø 95.0 ± 1.30 (2)</b>	NFT	<b>1 322405</b>
	Conj. junta tapa válvulas (2)	CG	1 322410
	Jgo. junta para cárter (7)	CG	1 322411
	Tapa distribución	CB	1 322412
	Tapa distribución	CB	1 322413
	Bomba de agua	CB	1 322414-1
	Bomba de agua	CB	1 322414-2
	Jgo. múltiple escape (2)	NFT	1 322416
	Múltiple admisión	NFT	1 322417
	Junta	CB	1 322430
	Junta	NB	1 322431
	Junta	NB	1 322432
	Junta	CB	1 322433
	Junta	CB	1 322434
	Junta	NFT	1 322435
	Junta	NB	1 322436
	O´ring G 23.39 x 3.53	GS	1
	O´ring G 47.22 x 3.53	GS	1
	O´ring G 24.99 x 3.53	GS	1
	Anillo G 42 x 57 x 3	GS	1
	Kit de retenes completo		R322400
	Jgo. retén válvulas (12)	P	1 R322410P
	Retén bancada 60.45 x 76.18 x 10	V	1 R320111V
	Retén distribución 42 x 56 x 7	P	1 R300612P

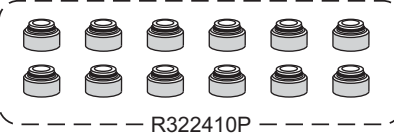
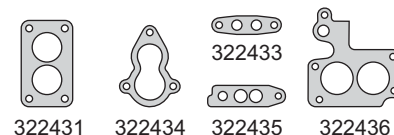
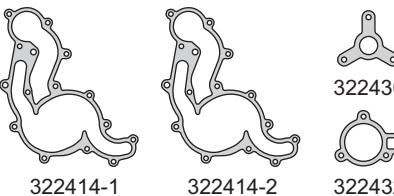
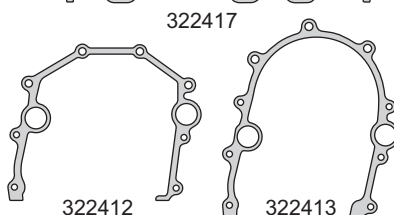
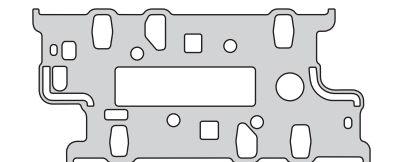
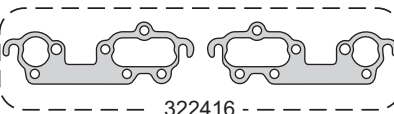
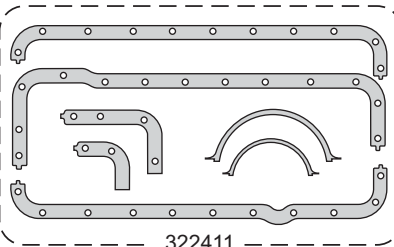
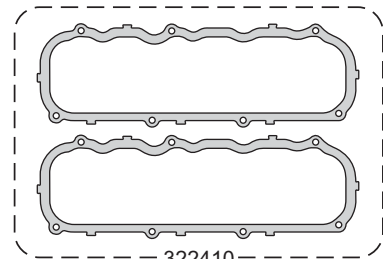
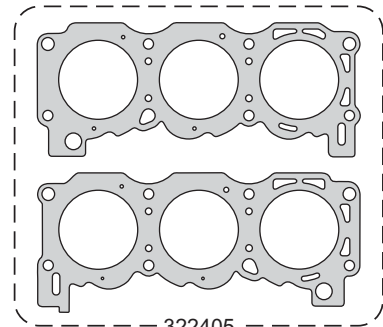

**FORD**



Motor/Engine	Cm³	HP	Ø
Triton 281	4600	180	90
Triton 330 (SOHC) V8 12V	5408	260	90

**Ford:** E-Series, F-Series, Expedition  
Triton1997/99  
(incluye junta múltiple de admisión con ventana de gota)



Nº OE	Descripción/Description	Mat.	Ref.
	Jgo. de juntas para motor		322500-R
	Jgo. de juntas superior	●	322595
	Jgo. jta. tapa cil. Ø 93.0 ± 1.30 (2)  N.R.	NFT	340707
	Jgo. jta. tapa cil. Ø 92.0 ± 0.88 (2)  N.R.	MLS 1 1	340708
	Jgo. tornillos tapa cilin. (HAT55055/55100)		B322500
	Junta tapa de válvulas	GS 1 1	322510-1
	Junta tapa de válvulas	GS 1 1	322510-2
	Junta para cárter	PLAST 1	340711
	Jgo. cierre distribución (3)	GS 1	340712
	Jgo. múltiple escape (2)	NFT 1 1	340715
	Jgo. múltiple adm. c/perno guía superior (2)	PLAST 1 1	322517
	Base bomba aceite	PLAST 1	340727
	Base bomba aceite	PLAST 1	302627
	Junta varilla aceite	NFT 1 1	340731
	Junta	CB 1 1	302632
	Cuerpo válvula reguladora	GFT 1	340732
	Junta pleno admisión	PLAST 1 1	302732
	Junta	CB 1 1	302634
	Entrada aire	CB 1 1	340837
	O´ring G 101.19 x 3.53	GS 1	
	O´ring G 50.39 x 3.53	GS 1	
	O´ring G 20.3 x 2.62	GS 1 1	
	O´ring G 7.52 x 3.53	GS 16 16	
	Kit de retenes completo		R322500
	Jgo. retén válvulas (16)	P 1	R302510P
	Retén bancada 92 x 108 x 9.8	P 1	R300311P
	Retén distribución 47 x 63.4 x 8.8	P 1	R340712P

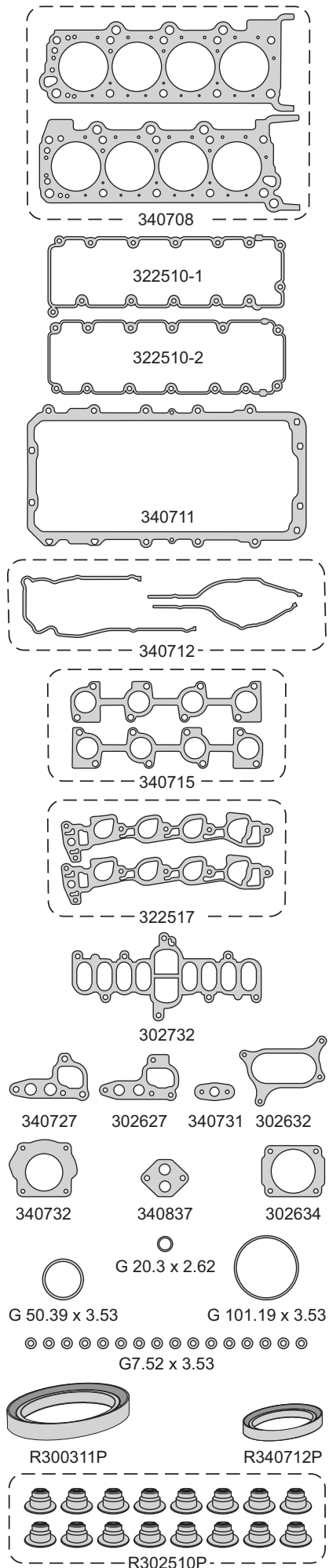

**FORD**



Motor/Engine	Cm³	HP	Ø
Triton 281	4600	180	90
Triton 330 (SOHC) V8 12V	5408	260	90

**Ford:** Triton 2000/03, E-Series, F-Series Expedition  
(incluye junta múltiple admisión con ventana cuadrada)



Nº OE	Descripción/Description	Mat.	Ref.
	Jgo. de juntas para motor		322600-R
	Jgo. de junta superior	●	322695
	Jgo. jta. tapa cil. Ø 93.0 ± 1.30 (2)  N.R. (6)	NFT	340707
	Jgo. jta. tapa cil. Ø 92.0 ± 0.88 (2)  N.R. (6)	MLS 1 1	340708
	Jgo. tornillos tapa cilin.  HAT55055/55100)		B322500
	Junta tapa de válvulas	GS 1 1	322510-1
	Junta tapa de válvulas	GS 1 1	322510-2
	Junta para cárter	PLAST 1	340711
	Jgo. cierre distribución (3)	GS 1 1	340712
	Jgo. múltiple escape (2)	NFT 1 1	340715
	Jgo. múltiple admisión (2)	PLAST 1 1	322617
	Base bomba aceite	PLAST 1	340727
	Base bomba aceite	PLAST 1	302627
	Junta varilla aceite	NFT 1 1	340731
	Junta	CB 1 1	302632
	Cuerpo válvula reguladora	GFT 1	340732
	Junta pleno admisión	PLAST 1 1	302732
	Junta	CB 1 1	302634
	Entrada aire	CB 1 1	340837
	O´ring G 101.19 x 3.53	GS 1	
	O´ring G 50.39 x 3.53	GS 1 1	
	O´ring G 20.3 x 2.62	GS 1	
	O´ring G 7.52 x 3.53	GS 16 16	
	Kit de retenes completo		R322500
	Jgo. retén válvulas (16)	P 1	R302510P
	Retén bancada 92 x 108 x 9.8	P 1	R300311P
	Retén distribución 47 x 63.4 x 8.8	P 1	R340712P

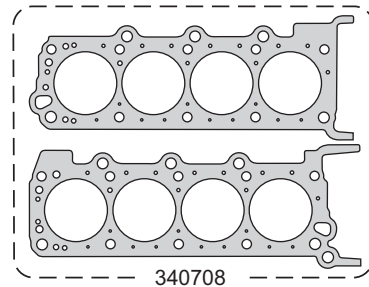

340708

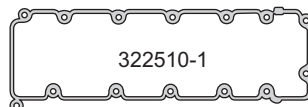

322510-1

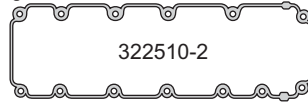

322510-2

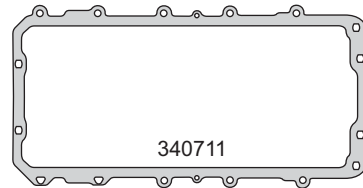

340711

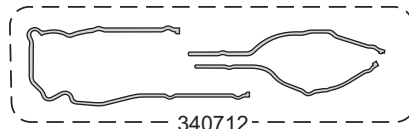

340712

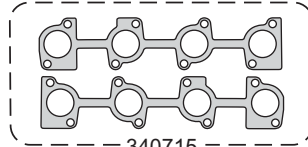

340715

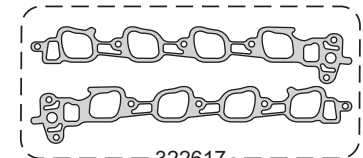

322617

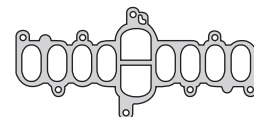

302732

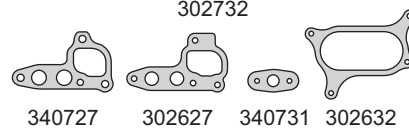

340727

302627

340731

302632



340732

340837

302634

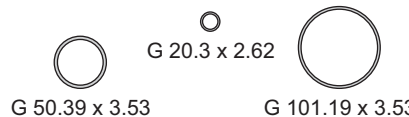

G 20.3 x 2.62

G 50.39 x 3.53

G 101.19 x 3.53

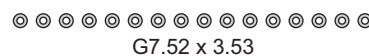

G7.52 x 3.53



R300311P

R340712P

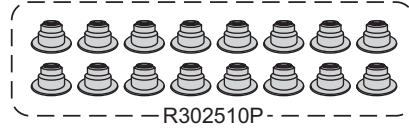

R302510P

**FORD**



Motor/Engine	Cm³	HP	Ø
Triton (SOHC) V10 20V	6760	310	90

**Ford:** Triton F-450 1997/99, Excursion E-Series, F-Series Super Duty (incluye junta múltiple de admisión con ventana de gota)



Nº OE	Descripción/Description	Mat.	Ref.
	<b>Jgo. de juntas para motor</b>		<b>322700-R</b>
	<b>Jgo. junta tapa cilin. Ø 92 x 0.88 (2)</b>	MLS	1 322708
	Junta para cárter	PLAST	1 322711
	Jgo. cierre distribución (3)	PLAST	1 340712
	Jgo. múltiple escape (4)	GFT	1 322716
	Jgo. múltiple admisión (2)	NFT	1 322717
	Base bomba aceite	PLAST	1 302627
	O'ring G 101.19 x 3.53	GS	1
	O'ring G 50.39 x 3.53	GS	1
	O'ring G 20.3 x 2.62	GS	1
	O'ring G 7.52 x 3.53	GS	20
	Kit de retenes completo		R322800
	Jgo. retén válvulas (20)	P	1 R322710P
	Retén bancada 92 x 108 x 9.8	P	1 R300311P
	Retén distribución 47 x 63.4 x 8.8	P	1 R340712P

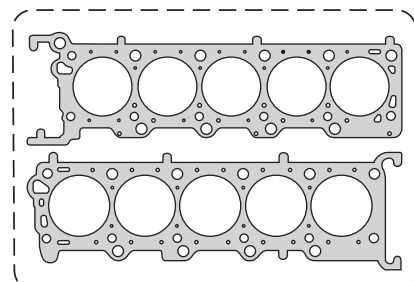

322708

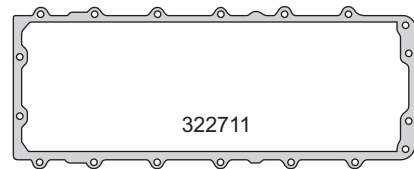

322711

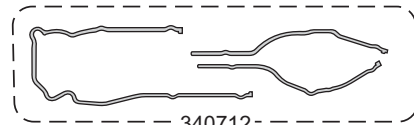

340712

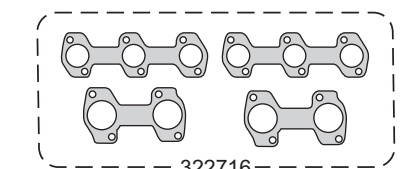

322716

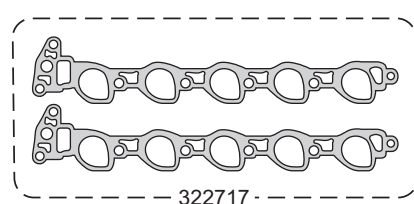

322717



302627



G 101.19 x 3.53



G 20.3 x 2.62



G 50.39 x 3.53



G 7.52 x 3.53



R300311P



R340712P



R322710P

**FORD**



Motor/Engine	Cm³	HP	Ø
Tritón (SOHC) V10 20V	6760	310	90

**Ford:** F-450 2000/03, Excursion E-Series, F-Series Super Duty (incluye junta múltiple de admisión con ventana cuadrada)



Nº OE	Descripción/Description	Mat.	Ref.
	Jgo. de juntas para motor	●	322800-R
	Junta tapa de cilindros Ø 92.0 ± 0.88	MLS	1 322708
	Junta para cárter	PLAST	1 322711
	Jgo. cierre distribución (3)	PLAST	1 340712
	Jgo. múltiple escape (4)	GFT	1 322716
	Jgo. múltiple admisión (2)	PLAST	1 322817
	Base bomba aceite	PLAST	1 302627
	O´ring G 101.19 x 3.53	GS	1
	O´ring G 50.39 x 3.53	GS	1
	O´ring G 20.3 x 2.62	GS	1
	O´ring G 7.52 x 3.53	GS	20
	Kit de retenes completo		R322800
	Jgo. retén válvulas (20)	P	1 R322710P
	Retén bancada 92 x 108 x 9.8	P	1 R300311P
	Retén distribución 47 x 63.4 x 8.8	P	1 R340712P

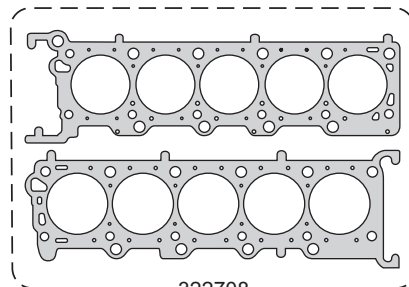

322708



322711

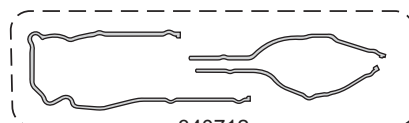

340712

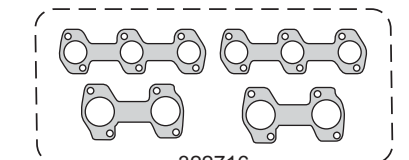

322716

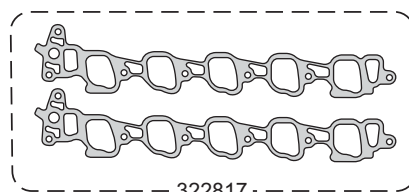

322817



302627



G 101.19 x 3.53



G 20.3 x 2.62



G 50.39 x 3.53



G 7.52 x 3.53



R300311P



R340712P

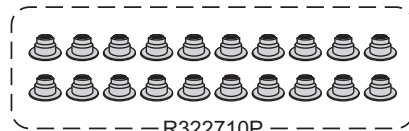

R322710P



**FORD**



Motor/Engine	Cm³	HP	Ø
Duratec RFF MEBA (DOHC) V6 24V	2967	200	89

Ford: Escape 2001/04  
Maverich, Mondeo 2001/...



Nº OE	Descripción/Description	Mat.	Ref.
	Jgo. de juntas para motor		322900-R
	Jgo. de juntas superior	●	322995
	Jgo. jta. tapa cil. Ø 91.5 ± 0.90 (2) NR <sup>2</sup>	MLS 1 1	322908
	Jgo. tornillos tapa cilindros (HAS13038)		B302500
	Junta tapa válvulas izquierda	GS 1 1	322910-I
	Junta tapa válvulas derecha	GS 1 1	322910-D
4139726	Junta para cárter	AC/GS 1	302511
7224827	Junta distribución central	GS 1	302512-1
7224828	Junta distribución izquierda	GS 1	302512-2
7224826	Junta distribución derecha	GS 1	302512-3
6691888	Bomba de agua	CB 1	320314
	Bomba de agua	NB 1	302514
4503102	Jgo. múltiple escape (2)	AC 1 1	302515
	Jgo. múltiple admisión (6)	GS 1 1	322917-1
	Jgo. múltiple admisión (6)	GS 1 1	322917-2
	Junta	GS 1	322930
13342711	Junta o´ring termostato G 47.22 x 3.53	GS 1	302531
	Junta	GS	322931
	Junta varilla aceite	NFT 1	340731
	Junta	GS 6 6	322933
	Junta	AC/GS 24 24	322934
1S7Z-9F670AA	Junta válvula reguladora paso a paso	GS 1	302235
3780203	Junta o´ring refrigerador aceite G 66.27 x 3.53	GS 1	302535
	Junta	AC/GS 1	322935
	O´ring G 20.30 x 2.62	GS 2	
	O´ring G 7.52 x 3.53	GS 12 12	
	Kit de retenes completo		R302500
	Jgo. retén válvulas (24)	V 1	R302510V
F4AZ-6701A	Retén bancada 92 x 108 x 9.8	P 1	R300311P
F3AE-6700A	Retén distribución 47 x 63.4 x 8.8	P 1	R340712P

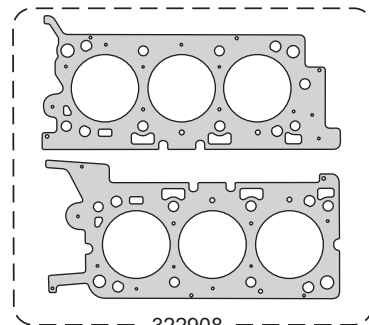

322908

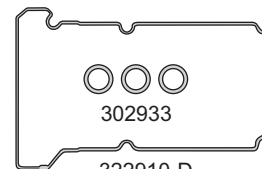

302933

322910-D

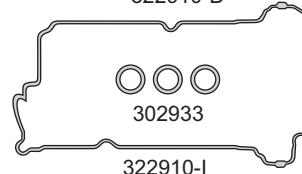

302933

322910-I

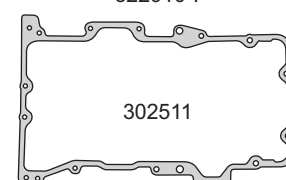

302511

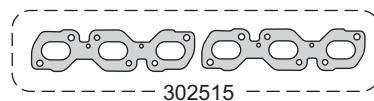

302515



322917-1



322917-2

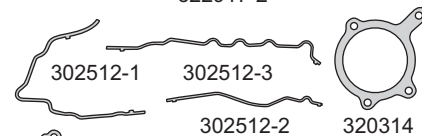

302512-1

302512-3

302512-2

320314

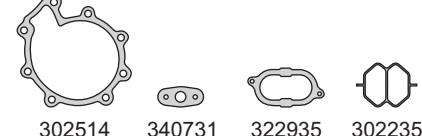

302514

340731

322935

302235



322934

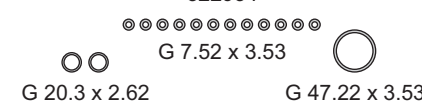

G 20.3 x 2.62

G 7.52 x 3.53

G 47.22 x 3.53

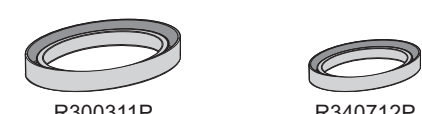

R300311P

R340712P

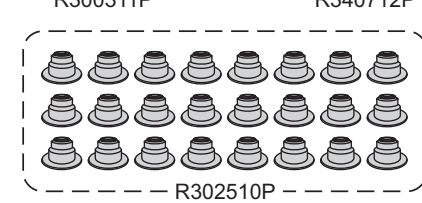

R302510P

**FORD**



Motor/Engine **Cm³** **HP** **Ø**

**232** **3797** **200** **97**

Ford: Windstar 1995/96



Nº OE	Descripción/Description	Mat.		Ref.
	Jgo. de juntas para motor		●	323200-R
	Jgo. de juntas superior		●	323295
	Junta tapa cilindros Ø99.7 $\pm$ 1.40 NR	GFT	2 2	320207
	Sellador líquido - caucho de silicona			TRN0085G
	Junta tapa válvulas	GS	2 2	323210
	Cogotera para cárter	CG	1	320211-3
	Tapa distribución	CB	1	320212
	Tapa bomba de agua	CB	1	320214
	Jgo. múltiple escape (2)	NFT	1	320215
	Junta múltiple admisión superior	NFT	1 1	320217
	Jgo. múltiple admisión (4)	NFT	1 1	320217-1
	Junta brida	NFT	1	340526
	Junta cierre admisión delantera	CG	1 1	323230
	Junta cierre admisión trasera	CG	1 1	323231
	Junta o ring tubo conector agua G 26.64 x 2.62	GS	2	302534
	Kit de retenes completo			R323200
	Jgo. retén válvulas (12)	P	1	R322310P
	Retén bancada 92 x 108 x 9.8	P	1	R300311P
	Retén distribución 47.62 x 67.07 x 8	V	1	R340512V

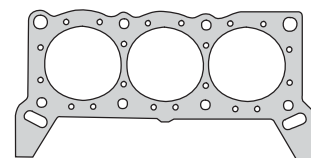

320207

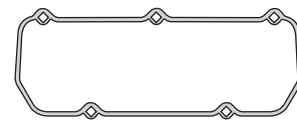
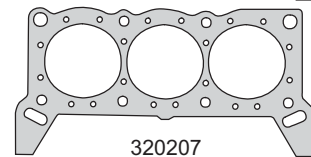

323210

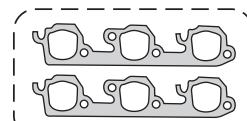

320215

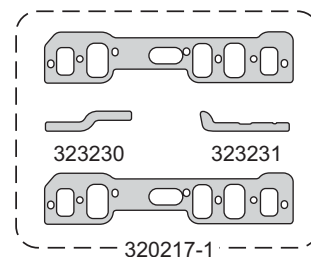

320217-1



320217



320212

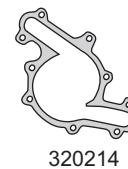

320214



320211-3



G 26.64 x 2.62



340526



R300311P



R340512V

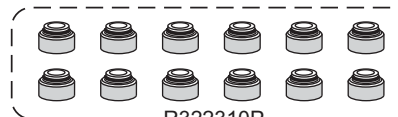

R322310P

**FORD**



Motor/Engine **Cm³** **HP** **Ø**

**Essex** **3797** **155** **96.8**

(OHV) V6 12V

Ford: Windstar 1997/98



Nº OE	Descripción/Description	Mat.	Ref.
	<b>Jgo. de juntas para motor</b>		<b>323300-R</b>
	<b>Jgo. junta tapa cil. Ø 100.0 ± 1.20 (2)</b>	<b>NFT</b>	<b>1 323307</b>
	<b>Sellador líquido - caucho de silicona</b>		<b>TRN0085G</b>
	Junta tapa válvulas	<b>GS</b>	<b>2 323210</b>
	Cogotera para cárter	<b>CG</b>	<b>1 320211-3</b>
	Tapa distribución	<b>CB</b>	<b>1 320212</b>
	Tapa bomba de agua	<b>CB</b>	<b>1 320214</b>
	Bomba de agua	<b>NB</b>	<b>1 323314</b>
	Jgo. múltiple escape (2)	<b>NFT</b>	<b>1 323316</b>
	Jgo. múltiple admisión (4)	<b>VS</b>	<b>1 323317</b>
	Junta termostato	<b>CB</b>	<b>1 320219</b>
	Junta brida	<b>NFT</b>	<b>1 340526</b>
	Junta	<b>CB</b>	<b>2 323128</b>
	Junta cierre admisión	<b>GS</b>	<b>1 323330</b>
	Junta cierre admisión	<b>GS</b>	<b>1 323331</b>
	Jgo. entre múltiple (8)	<b>GS</b>	<b>1 323332</b>
	Junta	<b>GS</b>	<b>1 323333</b>
	Junta	<b>GS</b>	<b>1 323334</b>
	Arandela A 15 x 19 x 1.5 A	<b>AL</b>	<b>1</b>
	O´ring G 37.69 x 3.53	<b>GS</b>	<b>1</b>
	O´ring G 7.52 x 3.53	<b>GS</b>	<b>6</b>
	Kit de retenes completo		<b>R323300</b>
	Jgo. retén válvulas (12)	<b>P</b>	<b>1 R323310P</b>
	Retén bancada 92 x 108 x 9.8	<b>P</b>	<b>1 R300311P</b>
	Retén distribución 47 x 65/80 x 15	<b>P</b>	<b>1 R340412P</b>

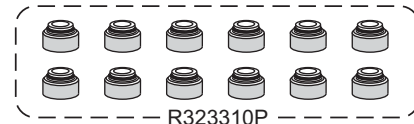
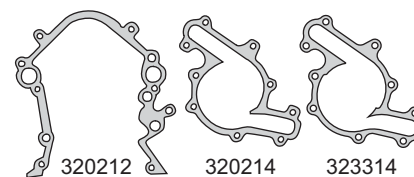
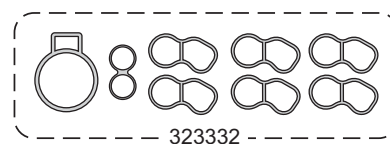
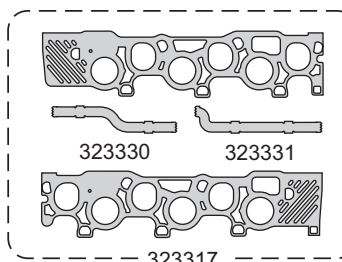
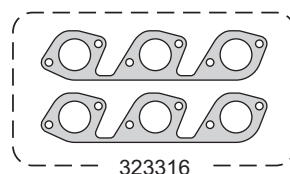
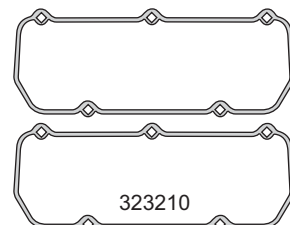
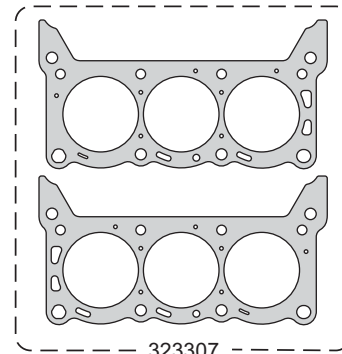

**FORD**



Motor/Engine Cm³ HP Ø

**Vulcan**  
(OHV) V6 12V

2986

147

89

Ford: Ranger 1996/01



Nº OE	Descripción/Description	Mat.	Ref.
	<b>Jgo. de juntas para motor</b>		<b>323700-R</b>
	<b>Jgo. junta tapa cil. Ø 91.5 ±1.20 (2)</b>	NFT	<b>1 323707</b>
	Junta tapa válvulas	GS	2 323010-2
	Junta para cárter	CG	1 323711
	Tapa distribución	NB	1 323012
	Tapa bomba de agua	NB	1 323014
	Jgo. múltiple escape (2)	NFT	1 323015
	Jgo. múltiple admisión (4)	NB	1 323017
	Junta termostato	CB	1 320219
	Arandela drenaje cárter A 14 x 21 x 2	PLAST	1 310930
	Junta	NB	1 323032
	Kit de retenes completo		R323700
	Jgo. retén válvulas (12)	V	1 R323010V
	Retén bancada 88 x 108 x 10	V	1 R320311V
	Retén distribución 47.62 x 67.07 x 8	V	1 R340512V

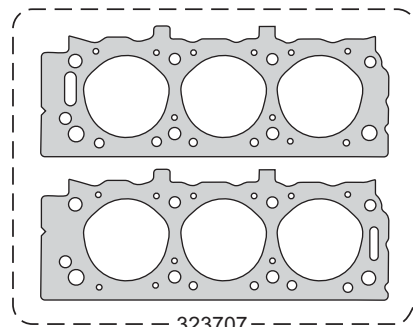

323707

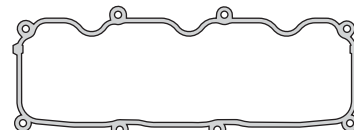
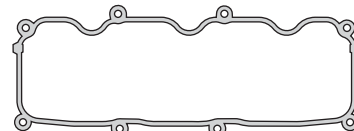

323010-2

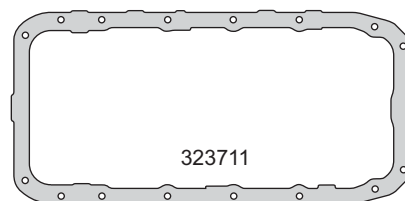

323711

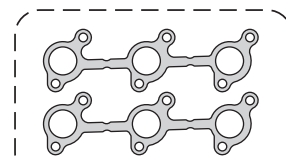

323015

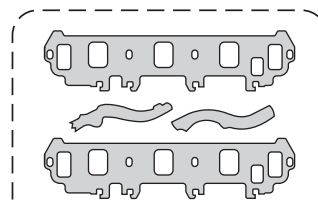

323017

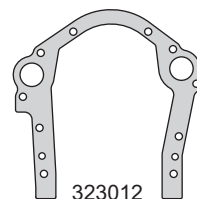

323012

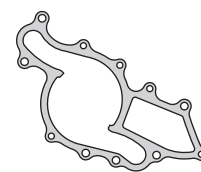

323014



320219



323032



310930



R320311V



R340512V

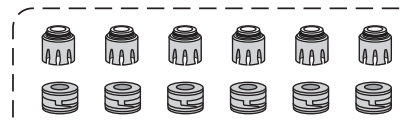

R323010V

**FORD**



Motor/Engine	Cm³	HP	Ø
Essex (OHV) V6 12V	3797	145	96.8

Ford: Windstar 1998/...



Nº OE	Descripción/Description	Mat.	Ref.
	Jgo. de juntas para motor		323900-R
	Jgo. de juntas superior		323995
	Jgo. jta. tapa cil. Ø100 ± 1.20 (2) NR	NFT 1 1	323307
	Junta tapa válvulas	GS 2 2	323210
	Cogotera para cárter	CG 1	320211-3
	Tapa distribución	CB 1	320212
	Tapa bomba de agua	CB 1	320214
	Bomba de agua	NB 1	323314
	Jgo. múltiple escape (2)	NFT 1 1	323316
	Jgo. múltiple admisión (4)	VS 1 1	323917
	Junta termostato	CB 1 1	320219
	Junta brida	NFT 1 1	340526
	Junta	NB 2 2	323128
	Junta cierre admisión	GS 1 1	323330
	Junta cierre admisión	GS 1 1	323331
	Jgo. entre múltiple (8)	GS 1 1	323332
	Junta	GS 1	323333
	Junta	GS 1	323334
	Arandela A 15 x 19 x 1.5 A	AL 1	
	O´ring G 37.69 x 3.53	GS 1 1	
	O´ring G 7.52 x 3.53	GS 6 6	
	Kit de retenes completo		R323300
	Jgo. retén válvulas (12)	P 1	R323310P
	Retén bancada 92 x 108 x 9.8	P 1	R300311P
	Retén distribución 47 x 65/80 x 15	P 1	R340412P

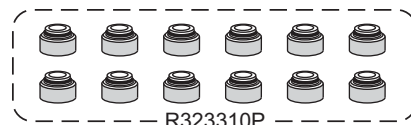
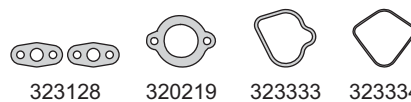
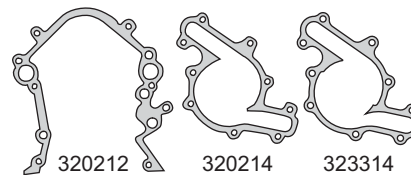
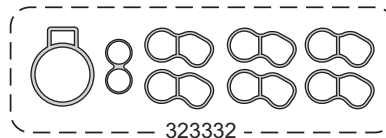
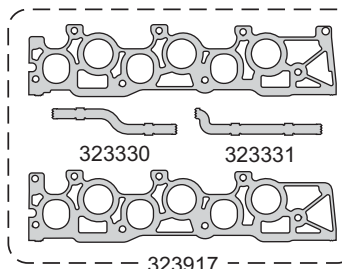
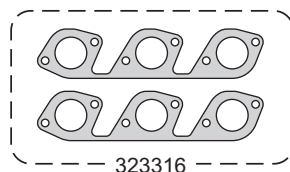
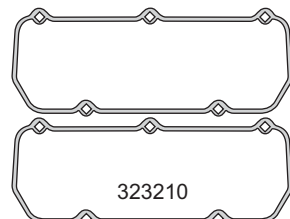
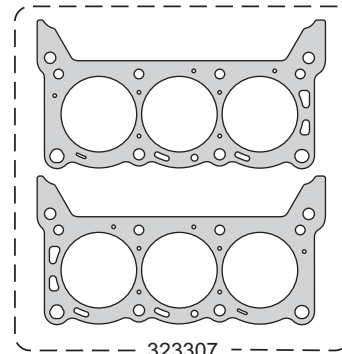

**FORD**



Motor/Engine	Cm³	HP	Ø
Essex (OHV) V6 12V	3797	200	96.8

Ford: Windstar 1999/00



Nº OE	Descripción/Description	Mat.	Ref.
	Jgo. de juntas para motor		324000-R
	Jgo. de juntas superior	●	324095
	Jgo. jta. tapa cil. Ø100 ± 1.20 (2)	NFT 1 1	323307
	Junta tapa válvulas	GS 2 2	323210
	Cogotera para cárter	CG 1	320211-3
	Tapa distribución	CB 1	320212
	Bomba de agua	NB 1	323314
	Jgo. múltiple escape (2)	NFT 1 1	323316
	Jgo. múltiple admisión (4)	VS 1 1	323917
	Junta brida	NFT 1 1	340526
	Junta cierre admisión	GS 1 1	323330
	Jgo. entre múltiples (7)	GS 1 1	324030
	Junta cierre admisión	GS 1 1	323331
	Junta	GS 1 1	324031
	Junta sello	AL/GS 1	302534
	Kit de retenes completo		R324100
	Jgo. retén válvulas (12)	P 1	R324010P
	Retén bancada 92 x 108 x 9.8	P 1	R300311P
	Retén distribución 47 x 65/80 x 15	P 1	R340412P

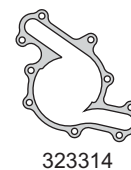
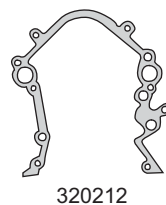
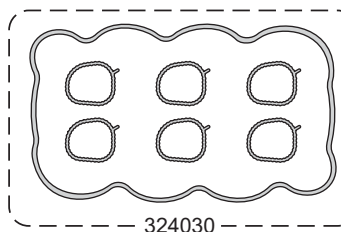
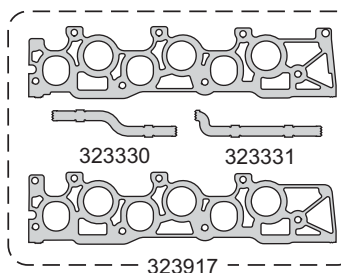
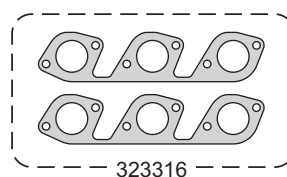
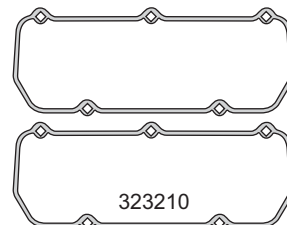
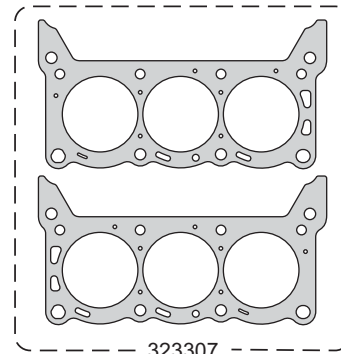

**FORD**



Motor/Engine	Cm³	HP	Ø
Essex (OHV) V6 12V	3797	200	96.8

Ford: Windstar 2001/03



Nº OE	Descripción/Description	Mat.	Ref.
	Jgo. de juntas para motor		324100-R
	Jgo. de juntas superior	●	324195
	Jgo. jta. tapa cil. Ø100 ± 1.20 (2)	NFT 1 1	323307
	Sellador líquido - caucho de silicona		TRN0085G
	Junta tapa válvulas	GS 2 2	323210
	Cogotera para cárter	CG 1	320211-3
	Tapa distribución	NFT 1	320212-1
	Bomba de agua	NB 1	323314
	Jgo. múltiple escape (2)	NFT 1 1	323316
	Jgo. múltiple admisión (4)	VS 1 1	324117
	Junta termostato	CB 1 1	320219
	Junta brida	NFT 1 1	340526
	Junta cierre admisión	GS 1 1	323330
	Junta cierre admisión	GS 1 1	323331
	Junta	GS 1 1	324031
	Jgo. entre múltiples (7)	GS 1 1	324032
	O´ring G 37.69 x 3.53	GS 1	
	Kit de retenes completo		R324100
	Jgo. retén válvulas (12)	P 1	R324010P
	Retén bancada 92 x 108 x 9.8	P 1	R300311P
	Retén distribución 47 x 65/80 x 15	P 1	R340412P

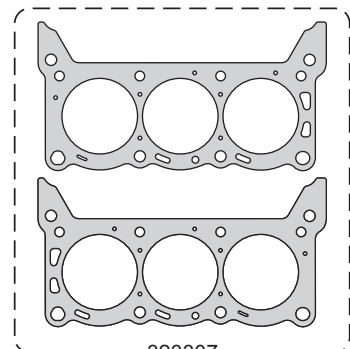

323307

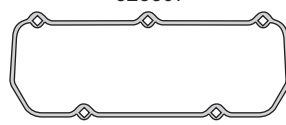

323210

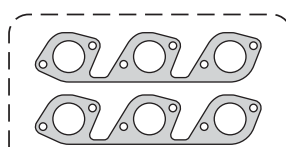

323316

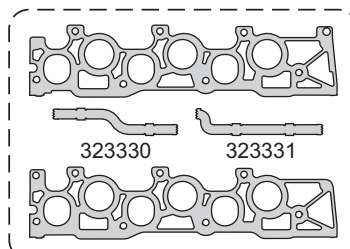

323330 323331

324117

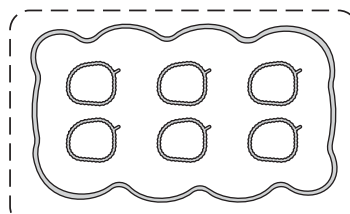

324032

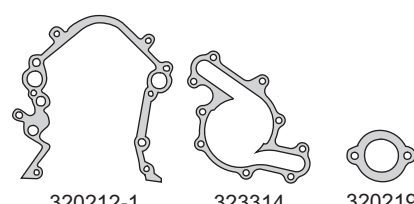

320212-1

323314

320219



320211-3

G 37.69 x 3.53

340526



R300311P

R340412P



R324010P

**FORD**



Motor/Engine **Cm³** **HP** **Ø**

**4L 121 P.C.D. ZETEC VIN "3" (DOHC) 16V** **1998** **138** **84.8**

Ford: Contour 1996/98, Mystique 1994/95  
Escort ZX2 1998/...



Nº OE	Descripción/Description	Mat.		Ref.	
	Jgo. de juntas para motor		●	324300-R	
	Jgo. de juntas superior		●	324395	
6847748	Jta. tapa cilindros Ø 87.0 ± 1.70  NR <sup>3</sup>	NFT	1	1	320507
	Jgo. tornillos tapa cilin. (HAT55055/55100)				B320300
1663394	Conj. junta tapa válvulas (11)	GS	1	1	324310
7008824	Junta para cárter	N	1	1	320311
7378788	Frente bomba aceite	CB	1	1	320312
6691888	Bomba de agua	CB	1	1	320314
	Junta múltiple escape	AC	1	1	320315
1048093	Jgo. múltiple admisión 1997/... (4)	GS	1	1	320517
6669767	Junta aislante admisión	AL/GS	1	1	321517
1663383	Múltiple admisión	CB	1	1	320329
	Junta caja termostato	CB	1	1	320332
1663908	Chupador aceite	CB	1	1	320334
7090340	Mariposa gases	CB	1	1	320335
1663861	Bancada trasera	CB	1	1	320336
6759630	Anillo tapa válvulas G 8.5 x 13.4 x 5	GS	10	10	320337
	Arandela cárter A 15 x 21 x 2 A	AL		1	
	Kit de retenes completo				R320300
	Jgo. retén válvulas (16)	V	1	1	R320310V
	Retén bancada 88 x 108 x 10	V	1	1	R320311V
	Retén distribución 35 x 50 x 7	V	1	1	R470013V
	Retén árbol levas 42 x 53 x 7	V	2	2	R320313V

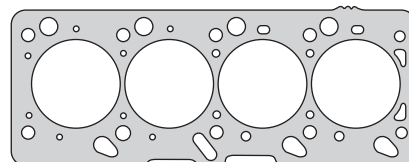

320507

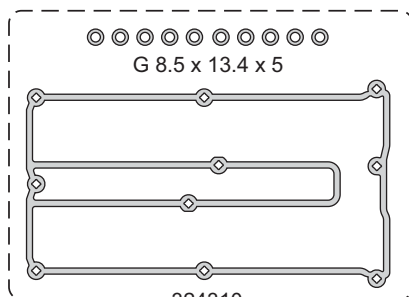

324310

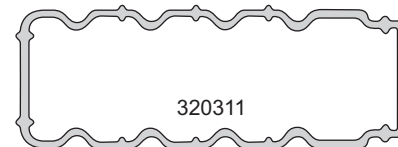

320311



320312

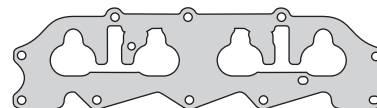

320314



320315

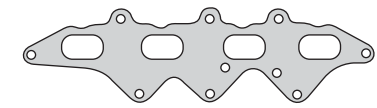

320517



321517



320329

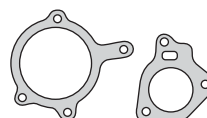

320332



320334



320335



A 15 x 21 x 2 A



R320310V



R470013V



R320313V

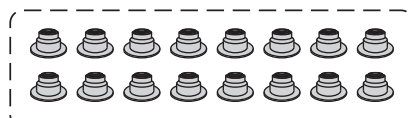

R320310V



**FORD**



Motor/Engine	Cm³	HP	Ø
Essex (OHV) V6 12V	4195	202	96.8

Ford: Econoline, F150 1997/98



Nº OE	Descripción/Description	Mat.	Ref.
	Jgo. de juntas para motor		324400-R
	Jgo. de juntas superior		324495
	Jgo. jta. tapa cil. Ø100 ± 1.20 (2)	NFT 1 1	323307
	Sellador líquido - caucho de silicona		TRN0085G
	Junta tapa válvulas	GS 2 2	323210
	Cogotera para cárter	GS 1	320211-3
	Tapa distribución	CB 1	320212
	Bomba de agua	NB 1	323314
	Jgo. múltiple escape (2)	NFT 1 1	323316
	Jgo. múltiple admisión (4)	VS 1 1	324117
	Junta termostato	CB 1 1	320219
	Junta	NB 2 2	323128
	Junta	NB 1 1	324430
	Junta cierre admisión	GS 1 1	323330
	Junta cierre admisión	GS 1 1	323331
	Junta	CB 1 1	322332
	Junta	GS 1	323334
	Cuerpo válvula cierre	CB 1 1	310936
	O´ring G 7.52 x 3.53	GS 6 6	
	Kit de retenes completo		R323300
	Jgo. retén válvulas (12)	P 1	R323310P
	Retén bancada 92 x 108 x 9.8	P 1	R300311P
	Retén distribución 47 x 65/80 x 15	P 1	R340412P

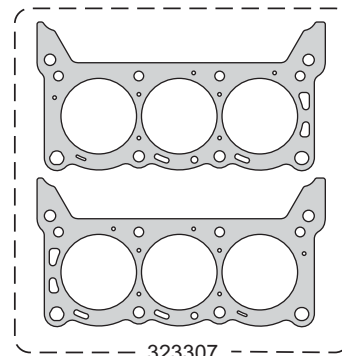

323307



323210

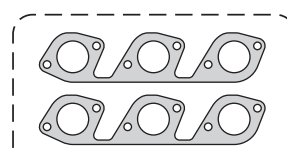
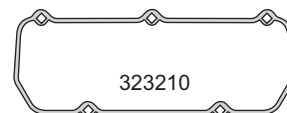

323316

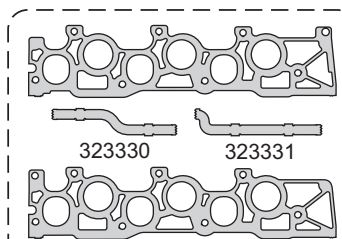

323330 323331

324117

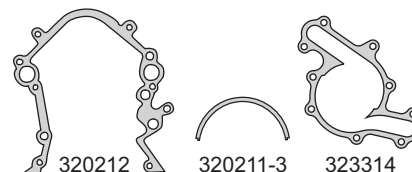

320212 320211-3 323314



323128 320219 324430



322332 323334 310936

○ ○ ○ ○ ○ ○  
G 7.52 x 3.53



R300311P R340412P

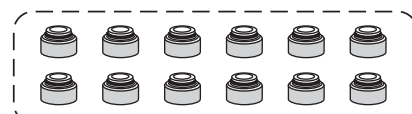

R323310P

**FORD**



Motor/Engine	Cm³	HP	Ø
Sigma (DOHC) 16V	1499 1596	104 115	79 79

Ford: 1.5 Ka 2016/...  
1.6 Fiesta 2010, Focus 2013



Nº OE	Descripción/Description	Mat.	Ref.
	Jgo. de juntas para motor		324600-R MLS
	Jgo. de juntas superior (MLS)	●	324695 MLS
	Junta tapa cilindros Ø 81.0 ± 1.20	NFT	324607
7S7G6051CB	Junta tapa cilindros Ø 80.5 ± 0.35	MLS 1 1	324608
	Jgo. tornillos tapa cilin. (HAT55055/55100)		B320900
	Sellador líquido - caucho de silicona		TRN0085G
	Junta tapa válvulas	GS 1 1	324610
1004459	Junta para cárter	NFT 1	320911
BM5G6659BA	Junta distribución	SLS	321612
1004452	Frente motor	NFT 1	320912
BE8Z8507A	Bomba de agua	SLS 1 1	320914
	Bomba de agua	NB 1	321614
	Bomba de agua	SLS 1	324614
844524J2WP	Múltiple escape	AC 1 1	321615
4M5G9441FA	Jgo. múltiple admisión (4)	GS 1 1	321617
2S619451AC	Salida de escape	AC 1	321618
7M5Z8255A	Bomba de agua	GS 1	321619
BE8Z8255A	Termostato	N 1	320929
BE8Z8255Z	Válvula IAC	GS 1	560131
4M5G9P84BCA	Guarnición	GS 1 1	321632
AM4S6G9186AA	O´ring inyector G 7.52 x 3.53	V 4 8	
	Kit de retenes completo		R324600
	Jgo. retén válvulas (16)	V 1	R320910V
BM5Z6K301B	Porta retén bancada 80 x 128 x 19.4	T	PR320911T
	Retén distribución 33 x 47 x 5	V 1	R320912V
	Retén distribución árbol levas 42 x 56 x 7	V 2	R300612V

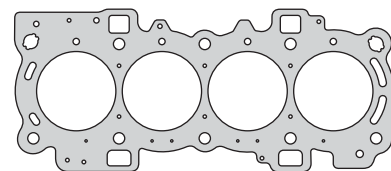

324608

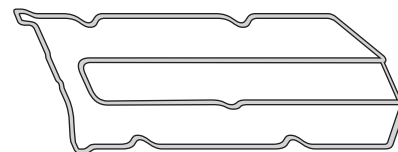

324610

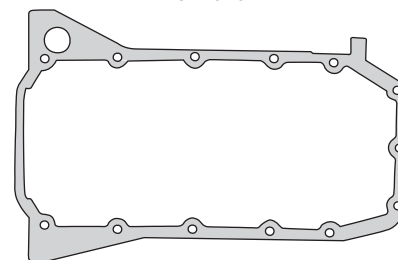

320911



321615

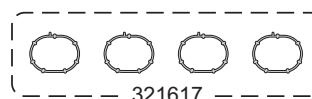

321617

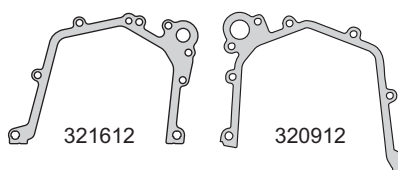

321612

320912



320914

321614

324614



321618



321619



320929



560131



G 7.52 x 3.53



321632

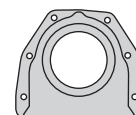

PR320911T



R320912V



R300612V

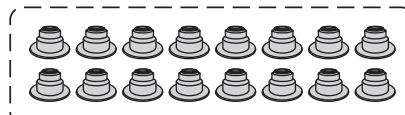

R320910V

**FORD**



Motor/Engine	Cm³	HP	Ø
Duratec-VCT (25KDTD)	2522	220/226 300	83
B5254T3/T6/T7/T8 (DOHC) 20V	2551	200/220 230	83

**Ford:** Focus, C-Max, S-Max, Mondeo, Kuga 2005/... - 2007/...  
**Volvo:** S40, V50, C70, C30, S80, V70 2004/08 - 2007/...



Nº OE	Descripción/Description	Mat.		Ref.
	Jgo. de juntas para motor			324700-R MLS
	Jgo. de juntas superior (MLS)		●	324795 MLS
	Jta. tapa cilindros Ø 84.0 $\pm$ 1.40	NFT		324707
1370373	Jta. tapa cilindros Ø 84.0 $\pm$ 1.30	MLS	1 1	324708
	Sellador líquido - caucho de silicona			TRN0085G
	Bomba de agua	NB	1	324714
1388503	Múltiple escape	AC	1 1	324715
1371948	Jgo. múltiple admisión (5)	GS	1 1	324717-1
	Múltiple admisión	SLS	1 1	324717
1370365	Salida escape	AC	1 1	324718
	Junta carcasa termostato	GS	1 1	324719
1371931	Bomba de aceite	NB	1	324727
1370471	Bomba de aceite	NB	1	324727-1
	Guarnición enfriador aceite	GS	1	324728
1371335	Guarnición enfriador aceite	GS	1	324729
1371340	Junta turbocompresor	NB	1 1	324731
	Válvula aceleradora G 74 x 78 x 6.1	GS	1 1	324732
1370361	Guarnición filtro de aceite	GS	1	324733
	Junta turbocompresor - 90 x 100 x 1.65	NFT	1 1	324739
	O´ring G 9 x 4	GS	1 1	
	O´ring G 38 x 3	GS	1	
1369796	Anillo G 48 x 52 x 6	GS	1	
1370364	O´ring G 20.30 x 2.62	GS	1	
1371661	O´ring G 26.64 x 2.62	GS	1	
1371658	O´ring G 29.82 x 2.62	GS	1	
1371660	O´ring G 66.27 x 3.53	GS	1	
	Kit de retenes completo			R324700
	Jgo. retén válvulas (20)	P	1 1	R324710P
	Retén bancada 98 x 110 x 7	P	1	R324711P
1369754	Retén distribución 34 x 47 x 5.5	P	1	R324712P
1431668	Retén árbol de levas 51 x 65 x 7	P	1 1	R324713P
1371718	Retén árbol de levas 45 x 65 x 7	P	1 1	R324715P

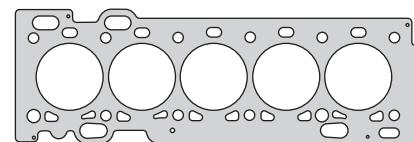

324708



324715

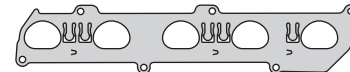

324717



324717-1

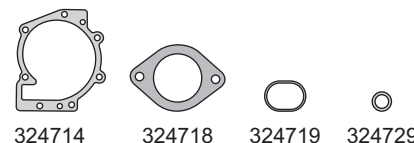

324714 324718 324719 324729

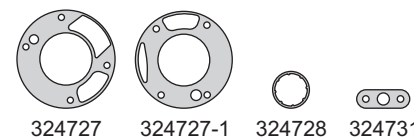

324727 324727-1 324728 324731



324732 324733 324739

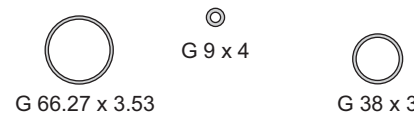

G 9 x 4 G 66.27 x 3.53 G 38 x 3

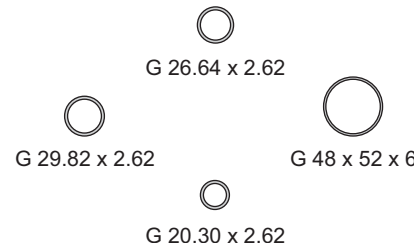

G 20.30 x 2.62 G 26.64 x 2.62 G 29.82 x 2.62 G 48 x 52 x 6



R324711P



R324712P R324713P R324715P



R324710P

**FORD**



Motor/Engine	Cm³	HP	Ø
Puma	2198	123	86
4HU (P22DTE)	2198	101/120	86
4HV (P22DTE) (DOHC) 16V	2198	101/120	86

**Citroën:** Jumper HDI 2006/...  
**Fiat:** Ducato 2006/...  
**Ford:** Ranger XL 4X2 - 4X4 TDCi  
 Transit TDCi 2006/...  
**Peugeot:** Boxer HDI 2006/...



**DIESEL**

Nº OE	Descripción/Description	Mat.	1	2	Ref.
	Jgo. de juntas para motor				324801-R
	Jgo. de juntas superior		●		324895-1M
	Jgo. de juntas superior				324895-2M
	Jgo. de juntas superior				324895-3M
	Jgo. de juntas superior (MLS)				324895-1M MLS
	Jgo. de juntas superior (MLS)				324895-2M MLS
	Jgo. de juntas superior (MLS)				324895-3M MLS
	Jgo. juntas superior sin JTC				324896
	Jta. tapa cilindros Ø 87.1 ± 1.20	NFT	1		324807-1M
	Jta. tapa cilindros Ø 87.1 ± 1.25	NFT			324807-2M
	Jta. tapa cilindros Ø 87.1 ± 1.30	NFT			324807-3M
1096227/1	Jta. tapa cilindros Ø 87.1 ± 1.10	MLS			324808-1M
	Jta. tapa cilindros Ø 87.1 ± 1.15	MLS			324808-2M
	Jta. tapa cilindros Ø 87.1 ± 1.20	MLS			324808-3M
1102674/76	Jgo. tornillos tapa cilin. (HAS13038/17038)				B302000
1099778	Conj. junta tapa válvulas (5)	N	1	1	324810
1112953	Jgo. junta para cárter (2)	SLS		1	302011
	Junta para cárter	NB		1	303211
110268/1	Frente distribución	NB		1	302012
1121210	Distribución a block	SLS		1	302013
1096559	Bomba de agua	SLS		1	302014
1120402	Múltiple escape	AC	1	1	302015
	Jgo. múltiple admisión (9)	N	1	1	302017
1098228	Guarnición termostato	N	1	1	302019
1105321	Chupador aceite	NB		1	302020
1721342	Sello filtro de aceite	GS		1	302027
1146959	Bomba vacío	SLS		1	302029
	Anillo cierre inyección	P	4	4	324830
1111912	Anillo refrigeración gases	SLS			302031
	Anillo admisión	N	1	1	302033
1754585	Junta tapa frontal	AL/GS	1	1	324834
1322526	Junta tubo refrigeración a block	SLS		1	302036
1794375	Junta bomba de vacío	AC/GS			302044
4640315	Arandela sello retén de block A 28 x 38 x 1.5 C	C			
	Kit de retenes completo				R302000
1096253	Jgo. retén válvulas (16)	V		1	R302010V
1117435	Porta retén bancada	T			PR302011T
1201417	Porta retén distribución	T		1	PR302012T
1139357	Retén árbol de levas 35 x 50 x 7	V		1	R470013V

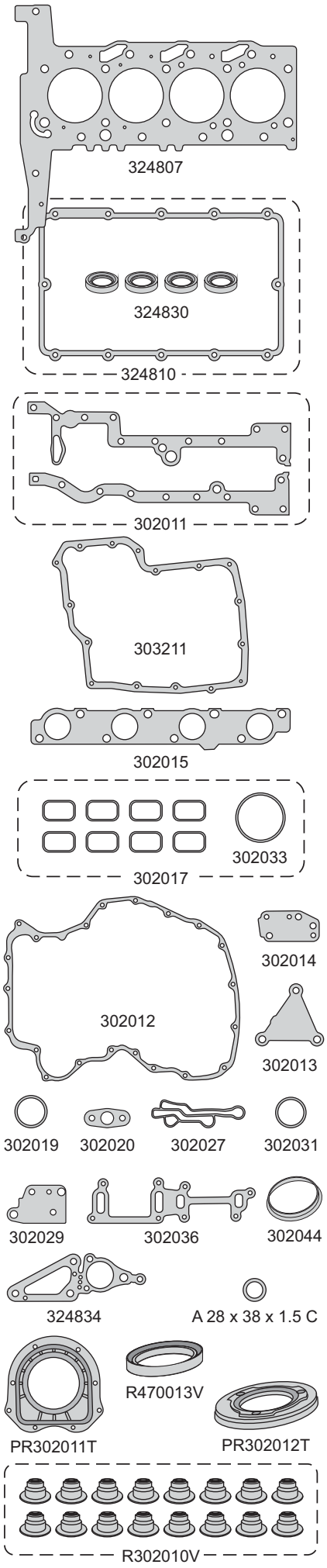

**FORD**



Motor/Engine	Cm³	HP	Ø
Puma TDCi 15 eTGV (DOHC) 20V	3198	200	90

Ford: Ranger XLS/XLT 4X2 - 4X4 TDCi 2013/...

DIESEL



Nº OE	Descripción/Description	Mat.	Ref.
	Jgo. de juntas para motor		324901-R
	Jgo. de juntas superior		324995-1M
	Jgo. de juntas superior		324995-2M
	Jgo. de juntas superior		324995-3M
	Jgo. de juntas superior (MLS)		324995-1M MLS
	Jgo. de juntas superior (MLS)		324995-2M MLS
	Jgo. de juntas superior (MLS)		324995-3M MLS
	Jgo. juntas superior sin JTC		324996
	Junta tapa cilindros Ø 91.0 $\pm$ 1.20 NR	NFT 1	324907-1M
	Junta tapa cilindros Ø 91.0 $\pm$ 1.25 NR	NFT	324907-2M
	Junta tapa cilindros Ø 91.0 $\pm$ 1.30 NR	NFT	324907-3M
1096227/1	Junta tapa cilindros Ø 91.0 $\pm$ 1.10 NR	MLS	324908-1M
	Junta tapa cilindros Ø 91.0 $\pm$ 1.15 NR	MLS	324908-2M
	Junta tapa cilindros Ø 91.0 $\pm$ 1.20 NR	MLS	324908-3M
BK3Q/6K260/AA	Jgo. tornillos tapa cilin. (HAS13038/17038)		B324900
1748634	Conj. junta tapa válvulas (6)	N 1 1	324910
	Conj. junta tapa válvulas (6)	N 1 1	324910-1
110268/1	Jgo. junta para cárter (2)	SLS 1	324911
1121210	Frente distribución	NB 1	324912
1096559	Distribución a block	SLS 1	302013
1712448	Bomba de agua	SLS 1	302014
	Múltiple escape	AC 1 1	324915
1098228	Jgo. múltiple admisión (11)	N 1 1	324917
1105321	Guarnición termostato	N 1 1	302019
1721342	Chupador aceite	NB 1	302020
1094599	Sello filtro de aceite	GS 1	302027
1111912	Bomba vacío	SLS 1	302029
	Anillo cierre inyector	P 5 5	324830
	Anillo refrigeración gases	SLS	302031
1754585	Anillo admisión	N 1 1	302033
1322526	Junta tapa frontal	AL/GS 1 1	324834
1794375	Junta tubo refrigeración a block	SLS 1	302036
	Junta entrada gases a turbo	AC 1	324938
	Junta entrada aire a turbo	NB 1	324939
	Kit de Turbo (6)	VS 1	324940
	Junta salida gases a turbo	AC 1	324941
	Junta lubricación turbo	NB 1	324942
4640315	Junta bomba de vacío	AC/GS	302044
	Arandelas Turbo A 10 x 14 x 1.5 A	AL 2	
	Arandela sello retén de block A 28 x 38 x 1.5 C	CU 1	
1096253	Kit de retenes completo		R324900
1117435	Jgo. retén válvulas (20)	V 1	R324910V
1201417	Porta retén bancada	T	PR302011T
BK2Q/6K780/BA	Porta retén distribución	T 1	PR302012T
	Retén auxiliar 21 x 40 x 7.3	P	R324915P

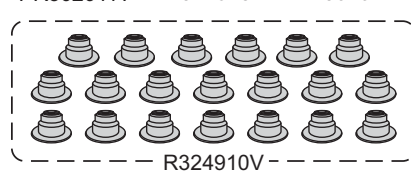
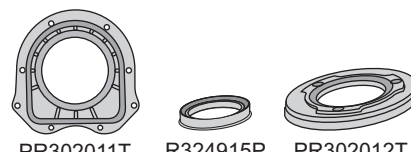
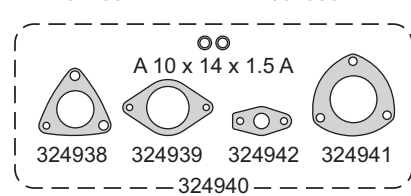
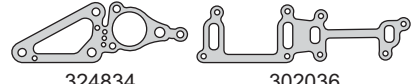
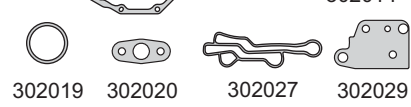
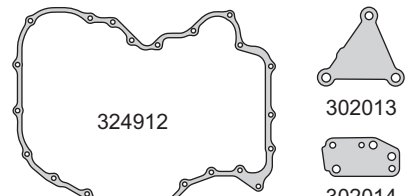
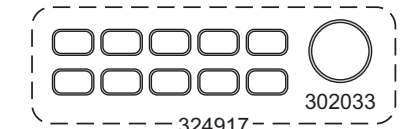
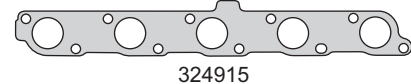
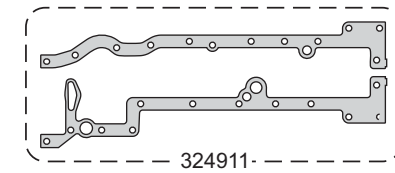
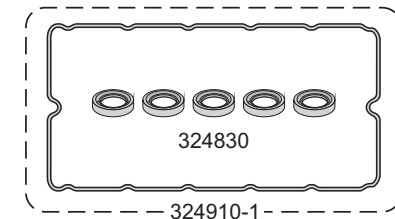
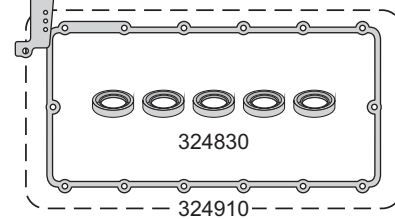
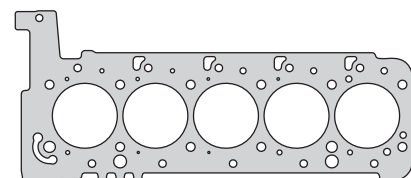

**FORD**



Motor/Engine	Cm³	HP	Ø
Eco Boost (DOHC) 12V	999	125	71.9

Ford: Fiesta 2016/...



Nº OE	Descripción/Description	Mat.	Ref.
	Jgo. de juntas para motor		● 325100-R MLS
	Junta tapa cilindros Ø 73.0 ± 1.20	NFT	321707
CM5Z/6051/B	Junta tapa cilindros Ø 73.5 ± 0.60	MLS	1 321708
CM5Z/6065/A	Jgo. tornillos tapa cilindros		B321700
	Sellador líquido - caucho de silicona		TRN0085G
CM5G/6K260/EB	Junta tapa válvulas	GS	1 325110
CM5Z/8507/A	Bomba de agua	SLS	1 321714
CM5G/9N454/DD	Jgo. múltiple escape (2)	AC	1 325115
CM5G/9441/AA	Jgo. múltiple admisión (4)	GS	1 325117
2S61/9451/AC	Salida de escape	AC	1 321618
CM5Z/8255/A	Junta termostato	GS	1 321719
BM5Z/2A572/A	Junta inspección tapa de cilindros	SLS	1 321726
	Guarnición enfriador aceite	GS	1 325127
CM5Z/8255/B	Guarnición distribución	GS	1 321731
CM5Z/6C535/A	Anillo sellador avance guía de válvulas G 52 x 55.5 x 5.2	GS	1 321732
4R8Q/6N652/AA	Junta retorno aceite	AC	1 321734
CM51/6M265/AB	Anillo impulsor	AC/N	1 321738
CM51/9451/AC	Salida escape a turbo	AC	1 325141
W715776/S3/00	O´ring G 21 x 3.5	GS	1
W715775/S3/00	O´ring entrada bomba de agua G 32 x 3.5	GS	1
2S7G/9E583/AA	O´ring bomba de combustible G 31.5 x 1.90	GS	1
W715778/S3/00	O´ring válvula termostato G 43 x 3	GS	1
W715777/S3/00	O´ring válvula termostato G 28 x 2.5	GS	1
W704553/S3/00	Anillo válvula termostato G 46.7 x 55.8 x 7.25	GS	1
97JM/6734/BA	Anillo sellado de aceite A 12.5 x 22.5 x 3	GS	1
	Kit de retenes completo		R321700
BM5Z/6571/A	Jgo. retén válvulas (12)	V	1 R321710V
CM5Z/6335/A	Porta retén bancada	V	PR321711V
	Retén de distribución 55 x 70 x 8	V	1 R321712V
CM5Z/6700/B	Retén árbol de levas 42 x 55 x 7	V	1 R321713V

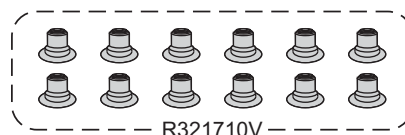
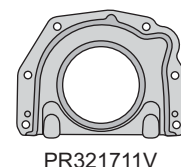
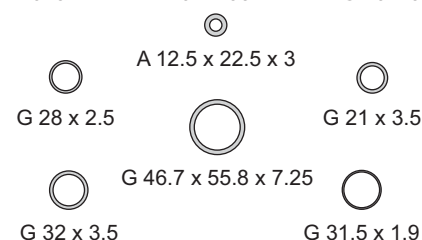
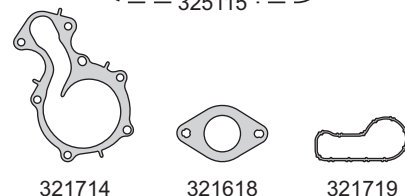
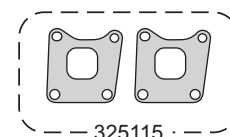
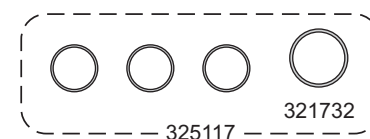
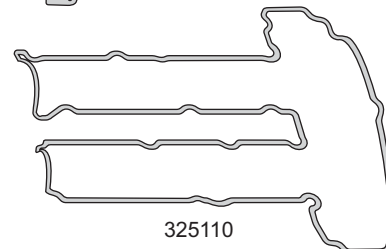
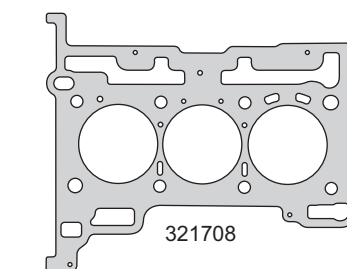

**FORD**



Motor/Engine	Cm³	HP	Ø
Dragon Eco Boost (DOHC) 12V	1497	137	84

Ford: Eco Sport, Fiesta 2016/...



Nº OE	Descripción/Description	Mat.	Ref.
	Jgo. de juntas para motor		● 325200-R MLS
	Junta tapa cilindros Ø 87.0 ± 1.20	NFT	325207
GN1G/6051/AC	Junta tapa cilindros Ø 87.0 ± 0.50	MLS	1 325208
GN1Z/6065/AA	Jgo. tornillos tapa cilindros		B325200
GN1G/6584/AA	Junta tapa válvulas	GS	1 325210
	Junta para cárter	NB	1 325211
CM5Z/8507/A	Bomba de agua	SLS	1 321714
GN1G/8501/AB	Bomba de agua	GS	1 325214
GN119451AB	Múltiple escape	AC	1 325215
GN1G/9441/AA	Jgo. múltiple admisión (3)	GS	1 325217
GN1G/8A531/AA	Junta termostato	GS	1 325219
GN1G/9461AA	Junta TBI	GS	1 325230
4R8Q/6N652/AA	Junta retorno aceite	AC	1 321734
GN1G/8K556/AB	Adaptador conexión de agua	GS	1 325234
CM51/9451/AC	Salida escape a turbo	AC	1 325141
GN159F596AA	Anillo pico inyector	GS	1
	Kit de retenes completo		R325200
GN1G/6A517/AA	Jgo. retén válvulas (12)	V	1 R325210V
GK2Q/6D354/AA	Porta retén bancada	V	PR325211V
GK2Z/6700/A	Retén de distribución 48 x 64 x 8	V	1 R325212V

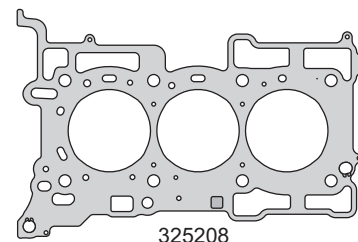

325208

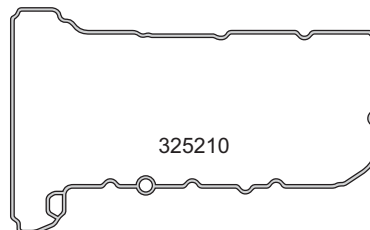

325210

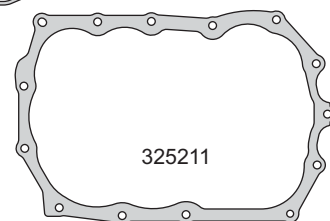

325211

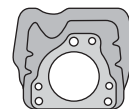

325215



325217



321714



325214



325219



325230



325234



321734



325141

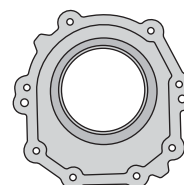

PR325211V



R325212V

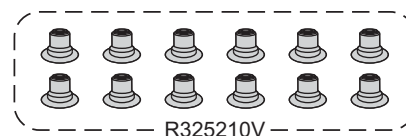

R325210V

**FORD**



Motor/Engine	Cm³	HP	Ø
JX4G15 EcoBoost (DOHC) 16V	1490	150	79.0

Ford: Territory 2021/...



Nº OE	Descripción/Description	Mat.	Ref.
	Jgo. de juntas para motor		● 325400-R MLS
	Junta tapa cilindros Ø 80.0 $\pm$ 1.20	NFT	325407
JS1-6051-AA	Junta tapa cilindros Ø 80.0 $\pm$ 0.70	MLS	1 325408
FS1-6065-AA	Jgo. tornillos tapa cilindros		B325400
FS1-8517-AA	Bomba de agua	GS	1 325414
JS1-9448-AA	Múltiple escape	AC	1 325415
JS1-9432-AC	Múltiple admisión	SLS	1 325417
FS1-6621-AB	Salida de escape	AC	1 325418
FS1-8516-AA	Junta termostato	GS	1 325419
CN3-9436-AB	Base TBI	SLS	1 325430
FS1-6N652-AB	Conducto aceite a turbo	NFT	1 325439
	Kit de retenes completo		R325400
JS1-6571-AA	Jgo. retén válvulas (16)	V	1 R325410V
JS1-6701-AC	Porta retén bancada trasera	T	PR302211T
JSI-6800-AA	Retén distribución 45 x 60 x 8	V	1 R302212V

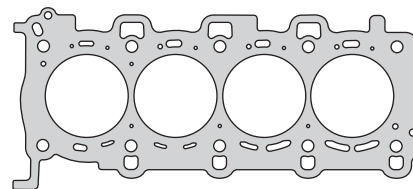

325408

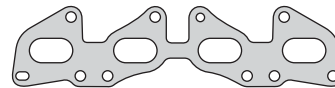

325415



325417



325414



325418



325419



325430



325439

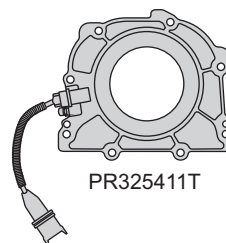

PR325411T



R325412V

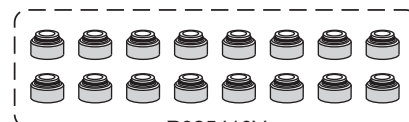

R325410V



**FORD**



Motor/Engine	Cm³	HP	Ø
4EB/BC/CA/FB	2496	70/80	93.64
4HC/EA (SOHC) 8V	2496	100	93.64

Ford: Transit, Transit D/DI 1985/99

DIESEL

Nº OE	Descripción/Description	Mat.	Ref.
	Jgo. de juntas para motor		330300-R
	Jgo. de juntas superior		330395
6518302	Junta tapa cilindros Ø96.0 $\pm$ 1.40	NFT	1 1 330307
	Junta tapa cilindros Ø96.0 $\pm$ 1.20	NFT	330307-1.20
	Jgo. tornillos tapa cilindros (HAS17038)		B330300
6201251	Junta tapa válvulas	N	1 1 330310
6193087	Junta para cárter	CG	1 330311
6182958	Tapa distribución	NB	1 330312
6193530	Placa distribución	NH	1 330313
6771114	Tapa bomba de agua	NB	1 330314
6193676	Múltiple escape	NFT	1 1 330316
6525915	Múltiple admisión	NB	1 1 330317
	Salida de escape	NFT	1 1 330318
	Termostato	NB	1 1 330319
	Junta cámara agua	NB	1 280229
	Brida	NB	1 330329
6175933	Válvula reguladora de gases	AC	3 3 320030
	Acople termostato	NB	1 1 330330
	Calefactor	NB	1 330331
6909744	Entre múltiples colectores	NFT	1 1 330334
	Porta retén	NB	1 330336
ERR/4621/B	Ar. iny. parallamas c/realse A 7.3 x 15.8 x 0.8 C	CU	4 4 330337
6197861	Salida de escape 1991/96 sin turbo		330338
6646724	Salida de escape múltiple		330348
7347007	Tapa diferencial tipo 34 (chico) 14 pulgadas		330359
6175734	Tapa diferencial tipo 51 (grande) 15 pulgadas		330361
	Anillos G 8.5 x 13.4 x 5	GS	4 4
	Arandela A 15 x 21 x 2 A	AL	1
	O´ring G 31.5 x 3.2	GS	2
	O´ring G 70 x 3	GS	1
ERR/4685/B	O´ring caja termostato G 21 x 3	GS	1
	O´ring G 18 x 3	GS	1
	O´ring G 19.25 x 2.9	GS	3
	O´ring G 21.89 x 2.62	GS	1
7092008	Arandela tapón cárter A 19 x 27 x 1.5 A	AL	
ERR/0894/A	Arandela tubo combustible A 12 x 18 x 1.5 A	AL	
70920120	Arandela bomba vacio A 10 x 15 x 1.5 A	AL	2
70920127	Arandela filtro gasoil A 6 x 10 x 1 C	CU	4
70920096	Arandela retorno gasoil A 14 x 20 x 1.5 C	CU	8
	Kit de retenes completo		R330300
6597036	Jgo. retén válvulas (8)	P	1 R330310P
6182960	Retén bancada 79.3 x 99 x 9.8	V	1 R330311V
6182959	Retén distribución 66.67 x 85.7 x 10	V	1 R330312V
6182957	Retén árbol de levas 47.6 x 66.7 x 11	V	1 R330313V

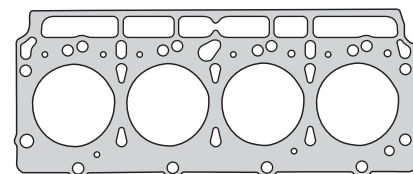

330307

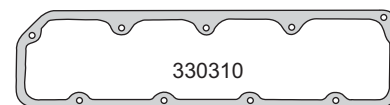

330310

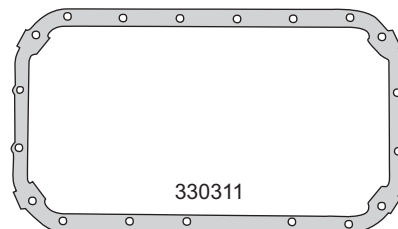

330311

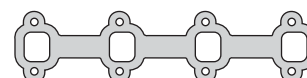

330316



330317

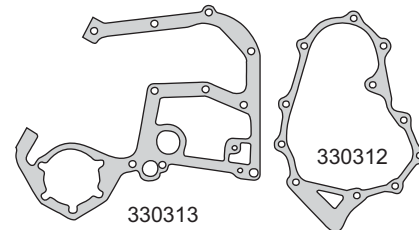

330313

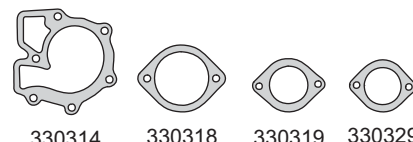

330314

330318

330319

330329

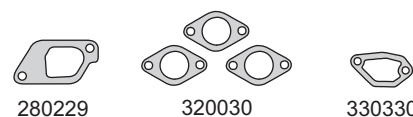

280229

320030

330330

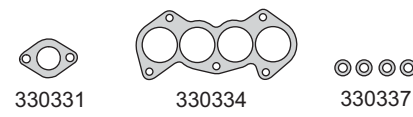

330331

330334

330337

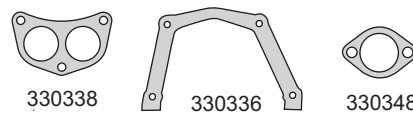

330338

330336

330348



R330311V



R330312V



R330313V



R330310P

**FORD****taranto**

Motor/Engine	Cm³	HP	Ø
Zetec Rocam ZL (SOHC) 8V	999	65	68.69

Ford: Ka 1999/...



Nº OE	Descripción/Description	Mat.		Ref.	
	Jgo. de juntas para motor		●	340100-R	
	Jgo. de juntas superior		●	340195	
	Jgo. de juntas superior (MLS)			340195 MLS	
	Junta tapa de cilin. Ø 70.0 $\pm$ 1.20	NFT	1	1	340105
XS6E/6051BE	Junta tapa de cilin. Ø 70.0 $\pm$ 1.20	NFT			340107
XS6E/6051BE	Junta tapa de cilin. Ø 70.0 $\pm$ 0.35	MLS			340108
	Jgo. tornillos tapa cilin. (HAT55055/55100)				B340100
XS6E/6584AB	Junta tapa válvulas	GS	1	1	340110
XS6E/6710/A2B	Junta para cárter	GS		1	340111
XS6E/9448AC	Múltiple escape	AC	1	1	340115
XS6E/9441BA	Jgo. múltiple admisión (2)	GS	1	1	340117
XS6E/8255BB	Carcasa termostato	GS	1	1	340119
XS6E/6659/A2B	Junta bomba aceite - agua	SLS		1	340127
W/703273/S300	Anillo termostato	GS			340129
XS6E/6K780AC	Guarnición salida gases	GS			340130
XS6E/9P848AA	Guarnición válvula mariposa	GS		1	340131
XS6E/6L621AD	SopORTE filtro aceite	NB		1	340132
958F/9F670BB	Válvula IAC	GS	1	1	340133
	O'ring G 47.22 x 3.53	GS	1	1	
	Kit de retenes completo				R340100
XS6E/6571AA	Jgo. retén válvulas (8)	V		1	R340110V
XS6E/6K301CA	Porta retén bancada trasera	V			PR340111V
XS6E/6700BA	Retén distribución 39.95 x 62 x 7.4	V		1	R340112V
	Retén bomba de aceite 40 x 62 x 7.4	V		1	R340115V

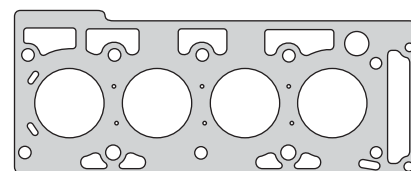

340107

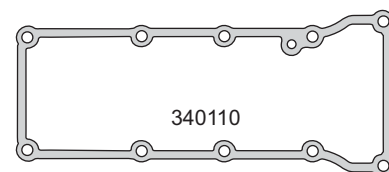

340110

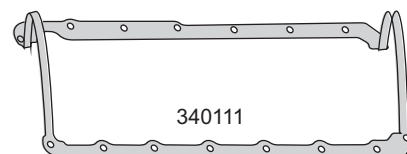

340111



340115

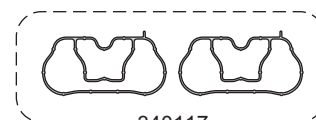

340117



340119



340127



340130



340131



G 47.22 x 3.53



340132



340133

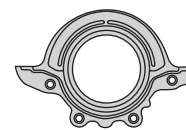

PR340111V



R340112V



R340115V



R340110V

**FORD**



Motor/Engine	Cm³	HP	Ø
Zetec Rocam ZL (SOHC) 8V	1598	95/105 110	82

Ford: Ka 1997/..., Fiesta 1999/..., Escort Eco Sport, Focus, Courier 2003/...

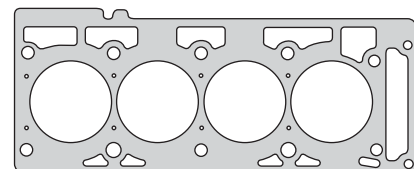

340207

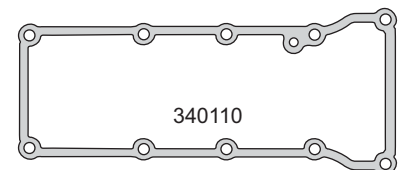

340110

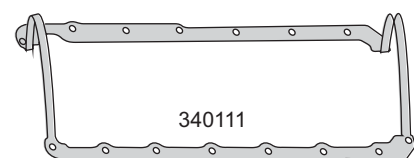

340111

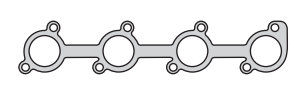

340215



340215-1

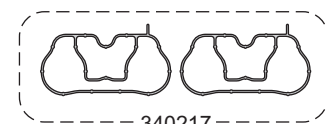

340217



340119

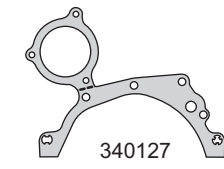

340127



340130



340131



G 47.22 x 3.53



340132



340133

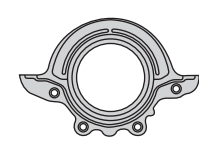

PR340111V



R340112V



R340115V



R340110V

Nº OE	Descripción/Description	Mat.	Ref.
	Jgo. de juntas para motor		340200-R
	Jgo. de juntas superior		340295
	Jgo. de juntas superior (MLS)		340295 MLS
	Junta tapa cilindros Ø83.0 x 1.20	NFT 1 1	340205
XS6E/6051AC	Junta tapa cilindros Ø83.0 x 1.20	NFT	340207
XS6E/6051AC	Junta tapa cilindros Ø83.0 x 0.35	MLS	340208
	Jgo. tornillos tapa cilin. (HAT55055/55100)		B340100
XS6E/6584AB	Junta tapa válvulas	GS 1 1	340110
XS6E/6710/A2B	Junta para cárter	GS 1 1	340111
XS6E/9448BB	Múltiple escape	SLS 1 1	340215
	Múltiple escape Ø35 - 2003/...	SLS	340215-1
XS6E/9441AB	Jgo. múltiple admisión (2)	GS 1 1	340217
XS6E/8255BB	Carcasa termostato	GS 1 1	340119
XS6E/6659/A2B	Junta bomba aceite - agua	SLS	1 340127
W/703273/S300	Anillo termostato	GS	340129
XS6E/6K780AC	Guarnición salida gases	GS	340130
XS6E/9P848AA	Guarnición válvula mariposa	GS	1 340131
XS6E/6L621AD	Soporte filtro aceite	NB	1 340132
958F/9F670BB	Válvula IAC	GS 1 1	340133
	O´ring 47.22 x 3.53	GS 1 1	
	Kit de retenes completo		R340200
XS6E/6571AA	Jgo. retén válvulas (8)	V 1	R340110V
XS6E/6K301CA	Porta retén bancada trasera	V	PR340111V
XS6E/6700BA	Retén distribución 39.95 x 62 x 7.4	V 1	R340112V
	Retén bomba de aceite 40 x 62 x 7.4	V 1	R340115V

**FORD**



Motor/Engine	Cm³	HP	Ø
Lynx (C9DC)	1753	90/75	82.5
Duratorq	1753	115	82.5
BHDA/BHDB (SOHC) 8V	1753	75	82.5

Ford: Focus TD di 1998/..., Fiesta TD di 2000/...  
Focus TD ci 2001/..., Focus di 1999/...

DIESEL



Nº OE	Descripción/Description	Mat.	Ref.
	Jgo. de juntas para motor		340301-R
	Junta tapa cilindros Ø 84.0 ± 1.20	NFT	340307-1M
	Junta tapa cilindros Ø 84.0 ± 1.30	NFT	340307-2M
	Junta tapa cilindros Ø 84.0 ± 1.40	NFT	340307-3M
	Junta tapa cilindros Ø 84.0 ± 1.50	NFT	340307-4M
	Junta tapa cilindros Ø 83.5 ± 1.20	MLS	340308-2M
	Junta tapa cilindros Ø 83.5 ± 1.25	MLS	340308-3M
	Junta tapa cilindros Ø 83.5 ± 1.30	MLS	340308-4M
	Junta tapa cilindros Ø 83.5 ± 1.35	MLS	340308-5M
	Junta tapa cilindros Ø 83.5 ± 1.40	MLS	340308-6M
	Junta tapa cilindros Ø 83.5 ± 1.42	MLS	340308-7M
1.079.925/926	Jgo. tornillos tapa cilin. (HAT60100/HAT60055)		B340300
1.078.524	Conj. junta tapa válvulas (4)	GS	1 340310
1.078.498	Junta para cárter	GS	1 340311
1.078.522	Junta frente	SLS	1 340312
1.078.500	Bomba de agua	SLS	1 340314
1.092.074	Múltiple escape	NFT	1 320015
	Múltiple escape	AC	320016
6.740.296	Múltiple admisión	CB	1 320017
6.180.424	Múltiple admisión turbo	NFT	1 340317
6.740.297	Salida de escape turbo	NFT	1 320018
1.032.504	Carcasa termostato	CB	1 320019
1.113.202	Frente motor bomba aceite (1104416)	SLS	1 340327
1.094.599	Junta bomba inyectora	SLS	1 340328
1.113.210	Junta intercooler	SLS	1 340329
1.102.444	Colector a turbo	SLS	340330
1.021.499	Anillo termostato	GS	1 560131
89FF8255AA	Arandela tapa válvulas	GS	3 320033
	Junta cárter inferior	NB	1 340338
	Kit de retenes completo		R340300
1.644.647	Jgo. retén válvulas (8)	V	1 R320010V
1.078.528	Porta retén bancada	V	PR320011V
	Porta retén bomba inyectora	P	PR340314P
1.101.468	Retén distribución 30 x 50 x 7.5	V	1 R340312V
6.135.090	Retén árbol de levas 28 x 38 x 7	V	1 R320013V

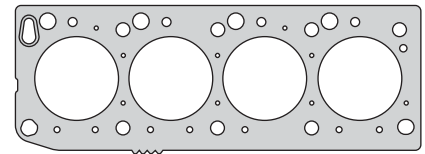

340307

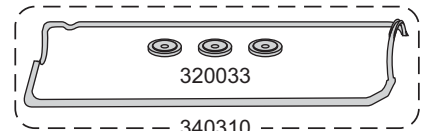

320033

340310

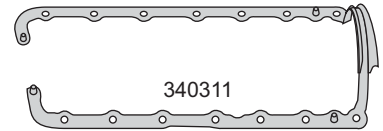

340311

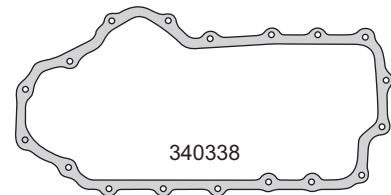

340338



320015

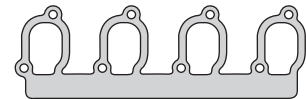

320017



340317

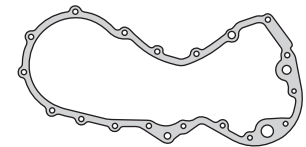

340327

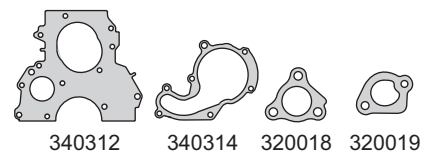

340312

340314

320018

320019

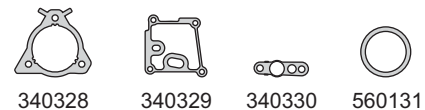

340328

340329

340330

560131



PR320011V

R340312V

PR340314P



R320013V



R320010V

**FORD**



Motor/Engine **F460L V8** Cm³ **7500** HP  Ø **110**

Ford: F100, F250/350 Econoline 250/350 1985/87



Nº OE	Descripción/Description	Mat.	Ref.
	<b>Jgo. de juntas para motor</b>		<b>340400-R</b>
	<b>Jgo. junta tapa cilindros Ø114 ± 1.30</b>	NFT	<b>1 340407</b>
	Junta tapa de válvulas	CG	2 340410
	Jgo. junta para cárter (4)	CG	1 340411
	Tapa distribución	CB	1 340412
	Bomba de agua	CB	1 340414
	Bomba de agua	CB	1 340414-1
	Jgo. múltiple escape (2)	NFT	1 340417
	Jgo. múltiple escape (4)	NFT	1 340417-1
	Salida de escape	FCH	2 300018
	Junta termostato	CB	1 310319
	Junta	CB	310419
	Junta	CB	1 340519
	Bomba de agua	CB	340421
	Junta	NFT	340422
	Junta	CB	340423
	Junta	CB	340424
	Base bomba nafta	CB	1 200028
	Junta	NH	1 340430
	Junta	NH	1 340431
	Junta	NH	1 340432
	Junta	CB	1 340532
	Jgo. juntas empaquetadura bancada (2)	SNA	1 300058
	Arandela A 14 x 18 x 1.5 A	AL	1
	Arandela A 130 x 142 x 1.6	CG	1
	O´ring G 34.59 x 2.62	GS	1
	O´ring G 67.95 x 2.62	GS	1
	Kit de retenes completo		R340400
	Jgo. retén válvulas (16)	P	1 R320710P
	Retén distribución 48 x 65 x 7.85	N	1 R320712N

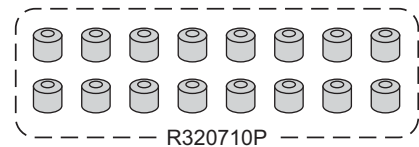
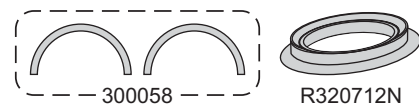
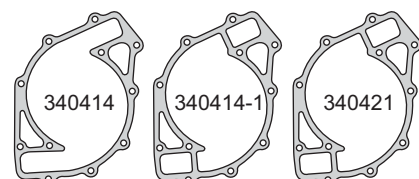
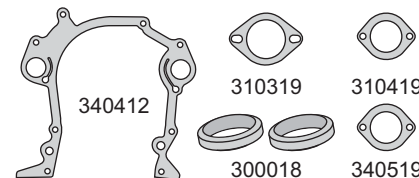
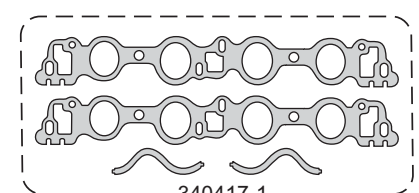
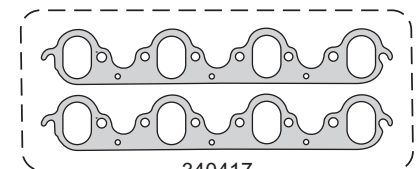
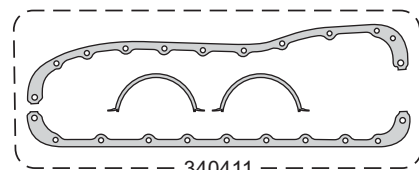
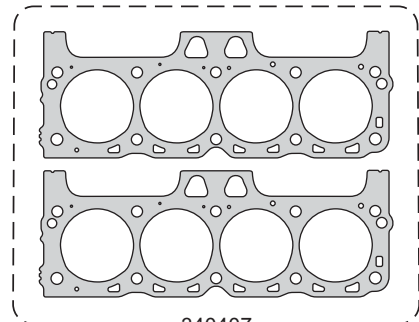

**FORD**



Motor/Engine Cm³ HP Ø

460 CID V8 7500 110

Ford: Monterey, Torino, Cougar, Continental Mark III/IV/V 1988/94



Nº OE	Descripción/Description	Mat.		Ref.
	Jgo. de juntas para motor		●	340500-R
	Jgo. de juntas superior		●	340595
	Jgo. jta. tapa cil. Ø114 ± 1.30 (2)  NR	NFT	1 1	340507
	Jgo. junta tapa de válvulas (2)	GS	1 1	340510
	Junta para cárter	GS	1 1	340511
	Tapa distribución	CB	1 1	340412
	Bomba de agua	CB	1 1	340414
	Bomba de agua	CB	1 1	340414-1
	Jgo. múltiple escape (2)	NFT	1 1	340515
	Jgo. múltiple admisión (4)	NFT	1 1	340517
	Junta	CB	1 1	340519
	Junta	NFT	1 1	340522
	Junta	NFT	2 2	340526
	Junta	CB	1 1	340527
	Base bomba nafta	CB	1 1	200028
	Junta	NFT	1 1	340528
	Junta	SLS	1 1	340529
	Junta unión múltiples	GS	2 2	340531
	Junta base carburador	CB	2 2	340532
	Junta	CB	1 1	340533
	Junta entrada aire	CB	1 1	340837
	O´ring G 32.99 x 2.62	GS	1 1	
	O´ring G 25.12 x 1.78	GS	1 1	
	O´ring G 23.52 x 1.78	GS	1 1	
	O´ring G 21.89 x 2.62	GS	1 1	
	O´ring G 7.52 x 3.53	GS	16 16	
	Kit de retenes completo			R340500
	Jgo. retén válvulas (16)	P	1 1	R340510P
	Retén bancada (dos mitades)	N	1 1	R340511-1N
	Retén distribución 47.62 x 67.07 x 8	V	1 1	R340512V

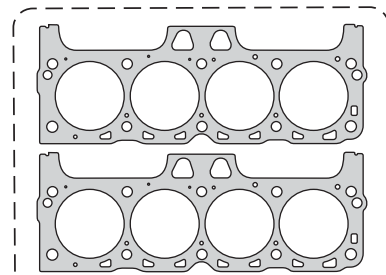

340507

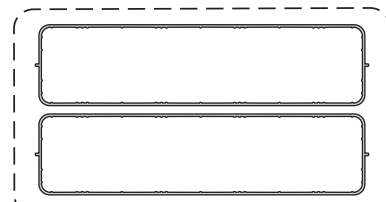

340510

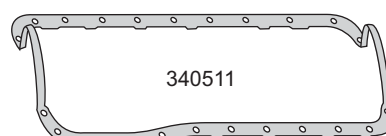

340511

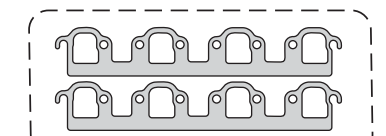

340515

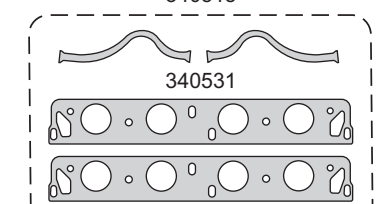

340517

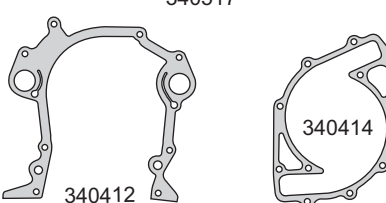

340412

340414

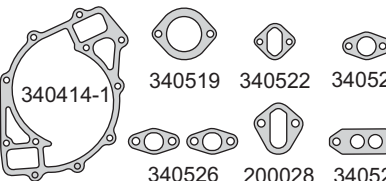

340414-1

340519

340522

340527

340526

200028

340528

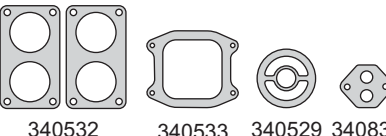

340532

340533

340529

340837



G 32.99 x 2.62

G 25.12 x 1.78

G 7.52 x 3.53

21.89 x 2.62

23.52 x 1.78



R340512V



R340510P

**FORD**



Motor/Engine **Cm³** **HP** **Ø**

**F140L**  
(SOHC) 8V **2298** **106** **96**

**Ford:** Mustang, Ranger 1993/94  
Ranger 1995/97, Pick Up 1989/...



Nº OE	Descripción/Description	Mat.	Ref.
	Jgo. de juntas para motor		<b>340600-R</b>
	Jgo. de juntas superior		<b>340695</b>
	Jta. tapa cilindros Ø100.0 ± 1.30 <b>NR</b>	<b>NFT</b>	<b>1 1 340607</b>
	Jgo. tornillos tapa cilindros (HAD19038)		<b>B300300</b>
	Junta tapa de válvulas	<b>GS</b>	<b>1 1 340610</b>
	Junta para cárter	<b>GS</b>	<b>1 1 340611</b>
	Junta para cárter	<b>GS</b>	<b>1 1 340611-1</b>
	Múltiple admisión	<b>GFT</b>	<b>1 1 340616-1</b>
	Múltiple admisión	<b>NFT</b>	<b>1 1 340617</b>
	Termostato	<b>NFT</b>	<b>1 1 340619</b>
	Base termostato	<b>NB</b>	<b>1 1 302329</b>
	Larguero	<b>GS</b>	<b>1 1 340633</b>
	Junta o´ring tubo conector agua G 26.7 x 2.62	<b>GS</b>	<b>1 1 302534</b>
	Junta entrada de aire	<b>NB</b>	<b>1 1 340636</b>
	Junta entrada de aire	<b>CB</b>	<b>1 1 340837</b>
	O´ring G 75.79 x 3.53	<b>GS</b>	<b>1 1 340616-1</b>
	Kit de retenes completo		<b>R340600</b>
	Jgo. retén válvulas (8)	<b>P</b>	<b>1 R340610-1P</b>
	Retén bancada 92 x 108 x 9.8	<b>P</b>	<b>1 R300311P</b>
	Retén distribución 43.41 x 56.02 x 9.3	<b>P</b>	<b>3 R300312P</b>

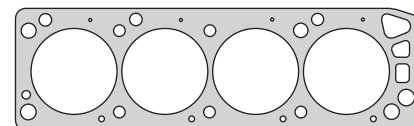

340607

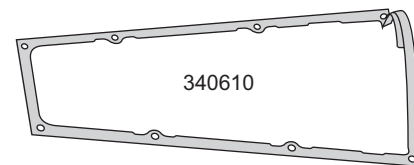

340610



340611

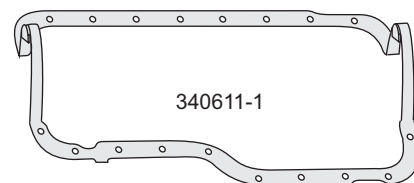

340611-1



340616-1



340617

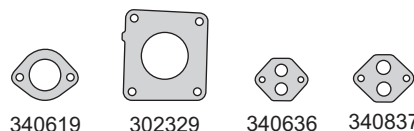

340619

302329

340636

340837



340633

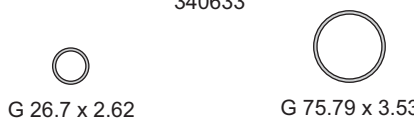

G 26.7 x 2.62

G 75.79 x 3.53

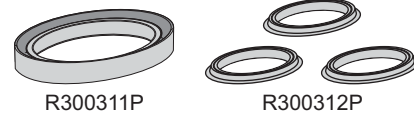

R300311P

R300312P



R340610-1P

**FORD**



Motor/Engine	Cm³	HP	Ø
281 CID (SOHC) V8 16V	4600	180	92

Ford: Town Car 1991/95, Grand Marquis 1993/95  
LTD Crown, Victoria 1992/...  
Cougar, Thunderbird 1994/95



Nº OE	Descripción/Description	Mat.			Ref.
	Jgo. de juntas para motor			●	340700-RMX
	Jgo. de juntas superior		●		340795
	Jgo. junta tapa cil. Ø93 $\pm$ 1.30 (2)  N.R.	MLS	1	1	340707
	Jgo. junta tapa cil. Ø92 $\pm$ 0.88 (2)  N.R.	MLS			340708
	Conj. junta tapa de válvulas (2)	GS	1	1	340710
	Junta para cárter	PLAST		1	340711
	Jgo. cierre distribución (3)	GS	1	1	340712
	Jgo. múltiple escape (2)	NFT	1	1	340715
	Jgo. múltiple admisión (2)	PLAST	1	1	302617
	Base bomba aceite	PLAST		1	340727
	Junta varilla aceite	NFT	1	1	340731
	Cuerpo válvula reguladora	GFT		1	340732
	Entrada aire	CB	1	1	340837
	Placa reguladora aire	CB	1	1	340734
	O´ring G 7.52 x 3.53	GS	16	16	
	O´ring G 101.19 x 3.53	GS		1	
	O´ring G 20.3 x 2.62	GS		1	
	O´ring G 50.39 x 3.53	GS	1	1	
	Kit de retenes completo				R340700
	Jgo. retén válvulas (16)	P		1	R340710P
	Retén bancada 92 x 108 x 9.8	P		1	R300311P
	Retén distribución 47 x 63.4 x 8.8	P		1	R340712P

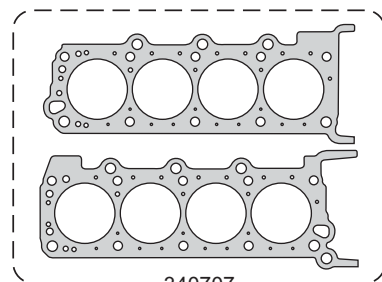

340707

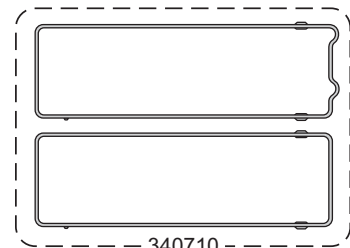

340710

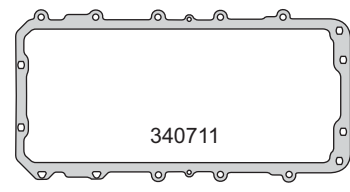

340711

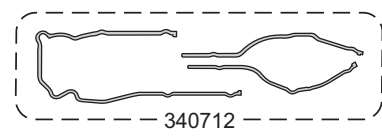

340712

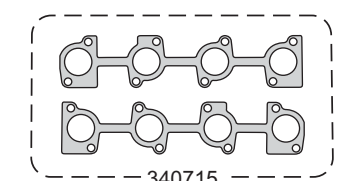

340715

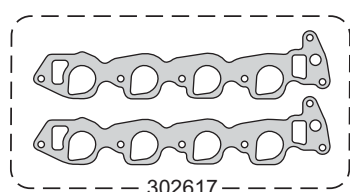

302617

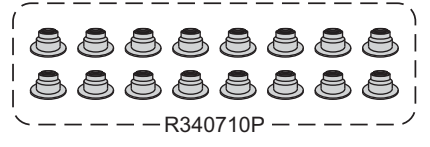
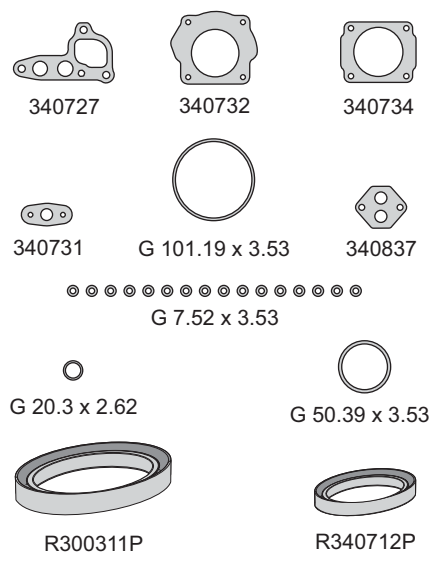

R340710P



**FORD**



Motor/Engine **Cm³** **HP** **Ø**

**ZETEC**  
(DOHC) 16V **1989** **126** **83**

Ford: Contour 1994/...



Nº OE	Descripción/Description	Mat.	Ref.
	<b>Jgo. de juntas para motor</b>		<b>340800-R</b>
<b>7114447</b>	<b>Junta tapa cilindros Ø 87.0 ± 1.70</b>	<b>NFT</b>	<b>1 320507</b>
	<b>Jgo. tornillos tapa cilindros (HAT55055/55100)</b>		<b>B320300</b>
1663394	Conj. junta tapa válvulas (11)	GS	1 320310
7008824	Junta para cárter	GS	1 320311
7378788	Frente bomba aceite	CB	1 320312
6691888	Bomba de agua	CB	1 320314
7181761	Múltiple escape	NFT	1 320316
	Múltiple admisión	AL/GS	1 321517
	Junta caja termostato	CB	1 320332
	Junta tapa	SLS	1 340833
1663908	Chupador aceite	CB	1 320334
	Catalizador de gases	NFT	1 340834
7090340	Mariposa gases	CB	1 320335
	Salida de gases	NFT	1 340835
1663861	Bancada trasera	CB	1 320336
	Base termostato	CB	1 340836
6759630	Anillo tapa válvulas G 8.5 x 13.8 x 5	GS	10 320337
	Entrada aire	CB	1 340837
	Sello de agua	GS	1 310940
	Arandela cárter A 15 x 21 x 2 A	AL	1
	O´ring G 7.52 x 3.53	GS	10
	Kit de retenes completo		R320300
	Jgo. retén válvulas (16)	V	1 R320310V
	Retén bancada 88 x 108 x 10	V	1 R320311V
	Retén árbol levas 42 x 53 x 7	V	2 R320313V
	Retén árbol levas 35 x 50 x 7	V	1 R470013V

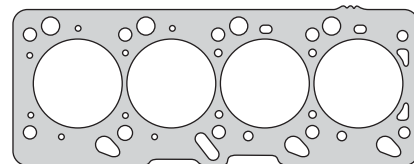

320507

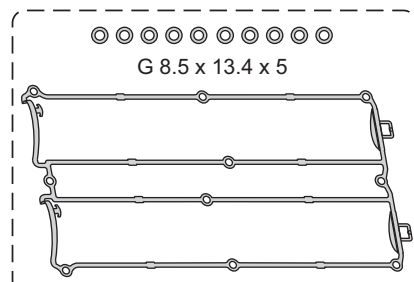

G 8.5 x 13.4 x 5

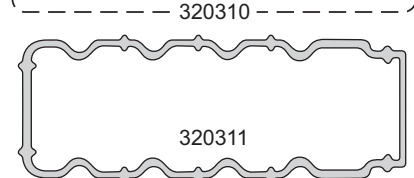

320311



320316

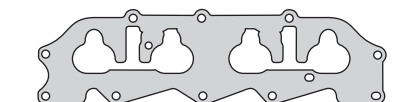

321517

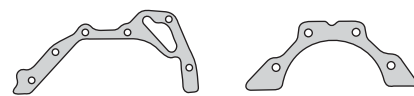

320312

320336

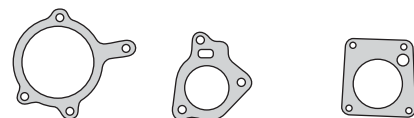

320314

320332

320335

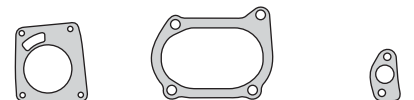

340833

340834

320334

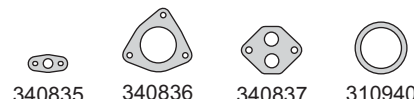

340835

340836

340837

310940



A 15 x 21 x 2A



G7.52 x 3.53



R320311V



R470013V



R320313V

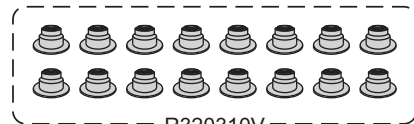

R320310V

**FORD**



Motor/Engine	Cm³	HP	Ø
300 CID Inyección (OHV) 12V	4900	145	101.6

Ford: F100, F150 1991/...



Nº OE	Descripción/Description	Mat.	Ref.
	Jgo. de juntas para motor		340900-R
	Jgo. de juntas superior		340995
FOUZ-6051-A	Jta. jta. tapa cilin. Ø105.5 ± 1.20	NFT	1 1 340907
	Junta tapa válvulas	GS	1 1 340910
E7TZ-6710B	Junta para cárter	GS	1 1 340911
E6TZ-6020B	Tapa distribución	NB	1 1 340912
C5AZ-8507A	Bomba de agua	NB	1 1 310214
E7TZ-9H486B	Múltiple escape	NFT	1 1 340916
E7TZ-9439A	Múltiple admisión	NB	1 1 340917
E67Z-8255B	Termostato	NB	1 1 340919
E7TZ-9E936B	Válvula mariposa	NB	1 1 340926
E0TZ-6626A	Aspiración bomba de aceite	NB	1 1 340927
E6FZ-90476A	Válvula ERG	NFT	1 1 340929
	Arandela tapa válvulas	GS	6 6 400130
E4TZ-6521A	Junta lateral válvulas	CG	1 1 310236
	Entrada aire	CB	1 1 340837
	Arandela A 67 x 80 x 1.6	CB	1 1 280142
	Arandela A 12.8 x 22.8 x 2	PLAST	1 1
	Arandela tapón cárter A 14 x 18 x 1.5 A	AL	1 1
	O'ring G 28.17 x 3.53	GS	1 1
E8AZ-6571A	Kit de retenes completo		R340900
F1TZ-6701A	Jgo. retén válvulas (12)	P	1 R340910P
E60Z-6700A	Retén bancada 95 x 114.5 x 11	P	1 R340911P
	Retén distribución 47.65 x 65.05 x 12	P	1 R300212P

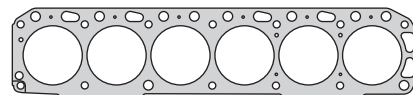

340907

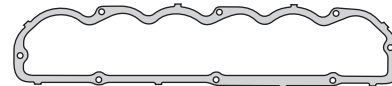

340910

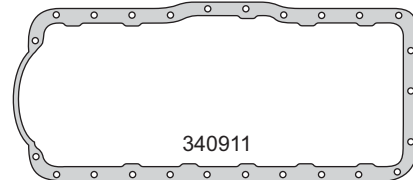

340911

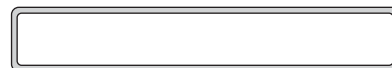

310236



340916

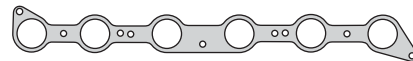

340917



340912

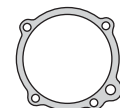

310214



340919



340926



340927



340929



340837



280142



400130



A 14 x 18 x 1.5 A



A 12.8 x 22.8 x 2



G 28.17 x 3.53



R300212P



R340911P

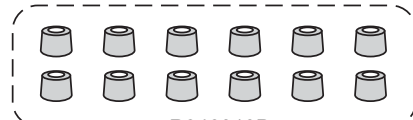

R340910P

**LADA**



Motor/Engine	Cm³	HP	Ø
BA3	1568	78	79

Lada: 2106, 2107, 2121, Niva 2121 1976/...  
Aleko 2141 1990/...



Nº OE	Descripción/Description	Mat.	Ref.
	Jgo. de juntas para motor		<b>970500-R</b>
21011-100320	Junta tapa cilindros Ø 81.6 ± 1.40	NFT	1 970505
2101-1003270	Junta tapa válvulas	CG	1 970510
2101-100970	Junta para cárter	CG	1 970511
2101-1002064	Tapa distribución	NB	1 970512
2105-1002064	Placa distribución	NB	1 970513
2101-130746	Tapa bomba de agua	NB	1 970514
2101-1008081	Jgo. múltiple admisión y escape (2)	NFT	1 970516
2101-1305020	Salida de escape	NFT	1 250618
2101-1307048	Placa bomba de agua	NB	1 970519
2101-1107015	Jgo. juntas carburador WEBER 26	VS	970520
2101-1107080	Jgo. juntas carburador SOLEX 26	VS	970521
2108-1107990	Jgo. juntas carburador SOLEX SAMARA 26	VS	970522
	Base carburador	NB	2 970525
2101-1106170	Base bomba nafta	NB	2 250128
2101-1005155	Porta retén bancada trasera	NB	1 250729
2105-1005255	Tapa árbol de levas	NB	1 970530
2101-1011021	Chupador bomba aceite	NB	1 250735
2101-1011020	Base bomba aceite	NB	1 970535
2101-1303017	Carcaza termostato	NB	1 970536
2101-1303038	Caño calefactor	NB	1 970537
	Unión caño escape	NFT	970538
	Kit de retenes completo		R970500
2108-1007026	Jgo. retén válvulas (8)	V	1 R250410V
	Retén bancada 70 x 90 x 10	P	1 R550411P
	Retén distribución 40 x 56 x 7	P	1 R260312P

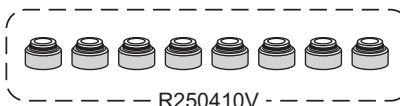
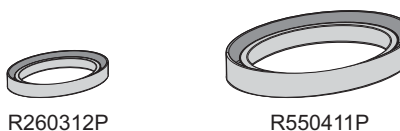
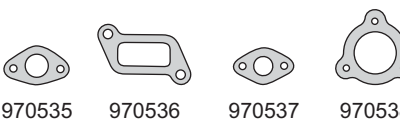
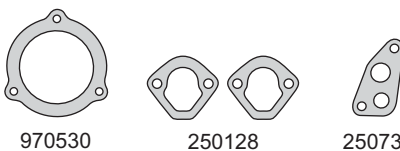
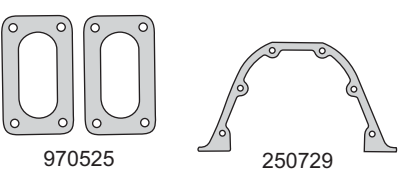
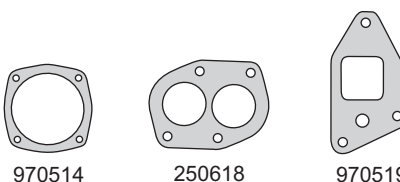
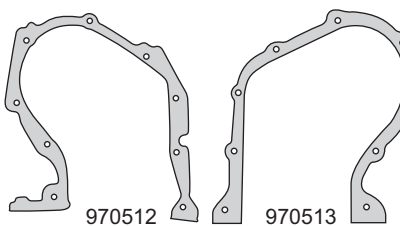
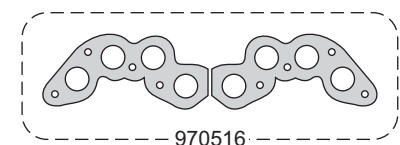
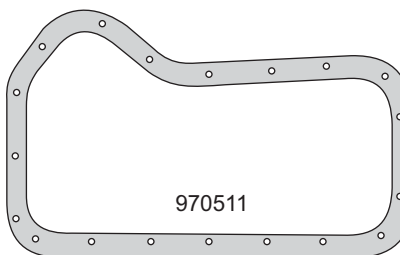
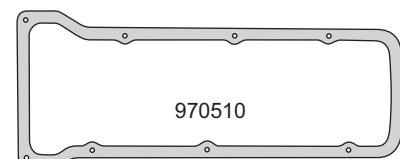
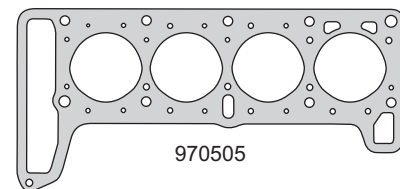

**LADA**



Motor/Engine	Cm³	HP	Ø
OHC	1198	60	76
OHC	1452	75	76

Lada: 2101, 2102 1970/...  
2103, 2107 1972/...



Nº OE	Descripción/Description	Mat.	Ref.
	Jgo. de juntas para motor		970600-R
2101-1003020	Junta tapa cilindros Ø 78.4 ± 1.40	NFT	1 970605
2101-1003270	Junta tapa válvulas	CG	1 970510
2101-1003070	Junta para cárter	CG	1 970511
2101-1002064	Tapa distribución	NB	1 970512
2105-1002064	Placa distribución	NB	1 970513
2101-1307046	Tapa bomba de agua	NB	1 970514
2101-1008081	Jgo. múltiple admisión y escape (2)	NFT	1 970516
2101-1303020	Salida de escape	NFT	1 250618
2101-1307048	Placa bomba de agua	NB	1 970519
	Jgo. juntas carburador weber 2B	VS	970520
2101-1107015	Jgo. juntas carburador SOLEX 2B	VS	970521
2101-1107080	Jgo. juntas carburador SOLEX SAMARA 2B	VS	970522
2108-1107990	Base carburador	NB	2 970525
2101-1106170	Base bomba nafta	NB	2 250128
2101-1005155	Porta retén bancada trasera	NB	1 250729
2105-1005255	Tapa árbol de levas	NB	1 970530
2101-100608	Bomba aceite	NB	1 970535
2101-1011021	Chupador bomba aceite	NB	1 250735
2101-1303017	Carcasa termostato	NB	1 970536
2101-1303038	Caño calefactor	NB	1 970537
	Unión caño escape	NFT	970538
	Kit de retenes completo		R970500
2108-1007026	Jgo. retén válvulas (8)	V	1 R250410V
	Retén bancada 70 x 90 x 10	P	1 R550411P
	Retén distribución 40 x 56 x 7	P	1 R260312P

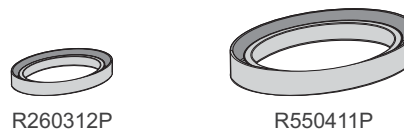
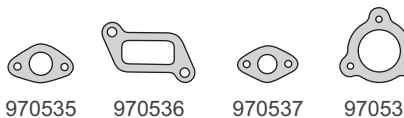
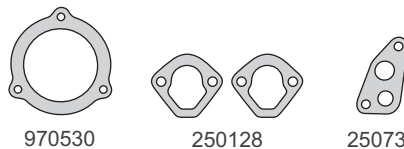
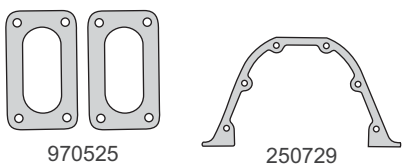
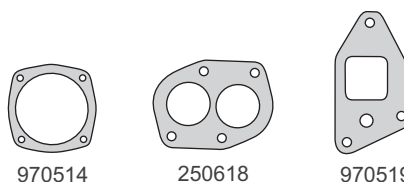
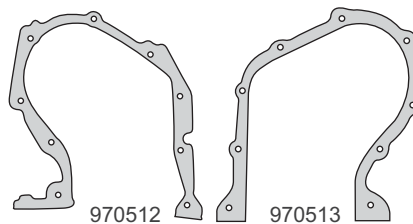
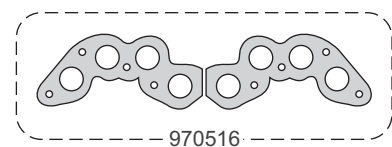
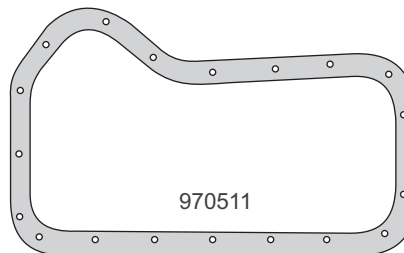
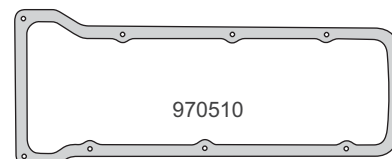
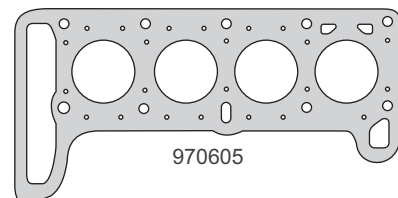

**LADA**



Motor/Engine	Cm³	HP	Ø
17LTBI (SOHC) 8V	1690	80	82

Lada: Vaz 21213, Niva 21213 1994/...



Nº OE	Descripción/Description	Mat.	Ref.
	Jgo. de juntas para motor		● 970700-R
21213-1003020	Junta tapa cilindros Ø 83.5 ±1.40	NFT	1 970705
2101-1003270	Junta tapa válvulas	CG	1 970510
2101-100970	Junta para cárter	CG	1 970511
2101-1002064	Tapa distribución	NH	1 970512
2105-1002064	Placa distribución	NH	1 970513
2101-130746	Tapa bomba de agua	NH	1 970514
2101-1008081	Jgo. múltiple admisión y escape (2)	NFT	1 970516
2101-1305020	Salida de escape	NFT	1 250618
2101-1307048	Placa bomba de agua	NH	1 970519
2101-1107015	Jgo. juntas carburador WEBER 26	VS	970520
2101-1107080	Jgo. juntas carburador SOLEX 26	VS	970521
2108-1107990	Jgo. juntas carburador SOLEX SAMARA 26	VS	970522
	Base carburador	NH	2 970525
2101-1106170	Base bomba nafta	NH	2 250128
2101-1005155	Porta retén bancada trasera	NH	1 250729
2105-1005255	Tapa árbol de levas	NH	1 970530
2101-1011021	Chupador bomba aceite	NH	1 250735
2101-1011020	Base bomba aceite	NH	1 970535
2101-1303017	Carcasa termostato	NH	1 970536
2101-1303038	Caño calefactor	NH	1 970537
	Unión caño escape	NFT	970538
	Kit de retenes completo		R970500
2108-1007026	Jgo. retén válvulas (8)	V	1 R250410V
	Retén bancada 70 x 90 x 10	P	1 R550411P
	Retén distribución 40 x 56 x 7	P	1 R260312P

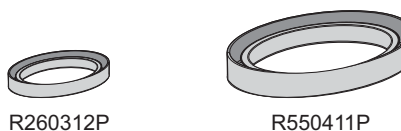
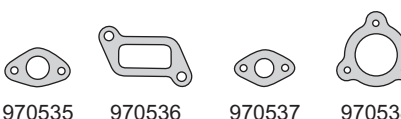
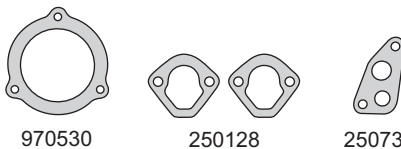
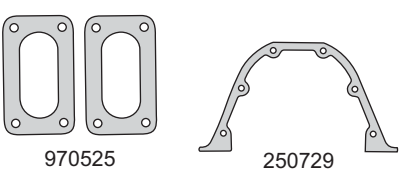
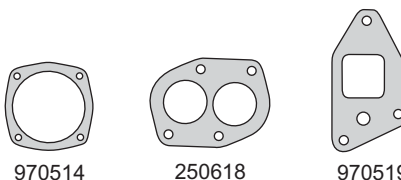
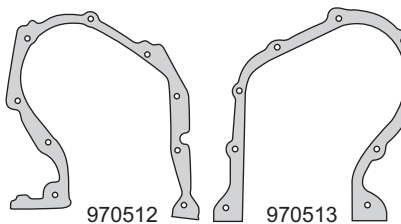
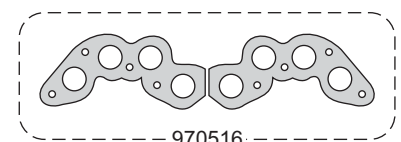
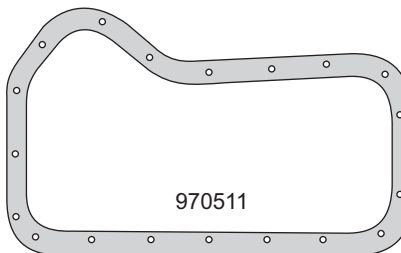
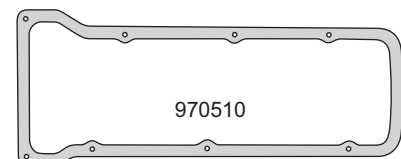
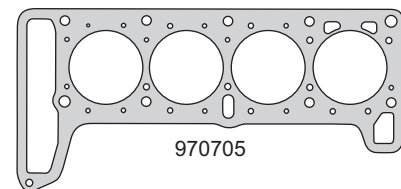



# taranto

## INSTRUCCIONES DE MONTAJE

1



Seleccionar el eje piloto para encajar el diámetro interno del retén guía de válvula e insertar.

2



Seleccionar el mandril con el diámetro interno más pequeño que encaja en el retén y montarlo a mano.

3



Deslizar el mandril en el eje piloto e insertar el mismo en la guía de válvulas. Deslizar hacia abajo y luego retirar la herramienta.



## HCRV - Herramienta de Instalación RGV Taranto.

Este dispositivo permite alinear correctamente el retén a la guía de válvula, eliminando el riesgo de dañar el mismo durante el montaje.

- ▶ Permite instalar el retén de guía de válvulas evitando su caída hacia el interior del cilindro, permitiendo así el recambio del retén sin desmontar la tapa de cilindros.
- ▶ Es aplicable en vehículos nacionales e importados.



# MERCEDES BENZ

## JUNTA TAPA DE CILINDROS / HEAD GASKETS

### MOTORES NAFTA Y DIESEL / PETROL AND DIESEL ENGINES

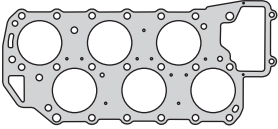
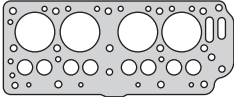
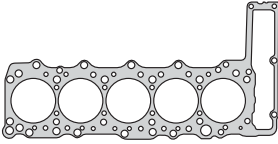
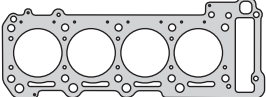
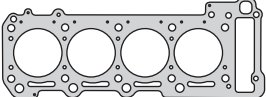
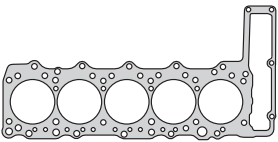
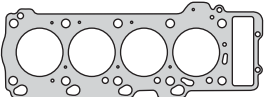
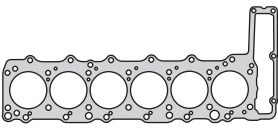
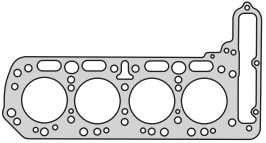
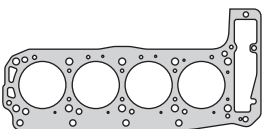
	Código Code	Q	≠	Kit Bulón Bolt Set	Aplicación Application	Motor Engine	Juego
	230707	83.0	1.60	B230700 HAN12055 HAN12100	V280 1998/...	2792cc. MB104.900 174HP Ø81 (DOHC) V6 12V	230700-R pág. 566
	350505	77.0	1.70		170DA/170DB/170DS/170SD/180D 180DB/O 319D/L405/L406 DIESEL	1767cc. OM 636.916/918/919/931 OM 636.930/934 40/45HP Ø75 (SOHC) 8V	350500 pág. 348
	351107	90.0	1.70	B351100 HAN10055 HAN10100	Sprinter T1N 1995/99, 290 TD E290 GTD 1994/... DIESEL	2874cc. OM 602.980/982/983 122/129HP Ø89 (SOHC) 10V	351100-R pág. 349
	351207-1M 351207-2M 351208-1M 351208-2M 351208	89.0 89.0 89.0 89.0 89.0	1.20 1.40 1.20 1.40 1.20	B351200 HAE18038	Sprinter 413 CDI 411/413/313/611/981 2000/..., C200-CDI 611.961/960 1998/... Vito 108/110/112 CDI Sprinter 208/211/213 CDI 611.980 DIESEL	2151cc. OM 611 - CDI 611.960/961 100/125HP 611.980 100/112HP Ø88 Iny. Directa (DOHC) 16V	351200-R pág. 350
	351207-1M 351207-2M 351208-1M 351208-2M 351208	89.0 89.0 89.0 89.0 89.0	1.20 1.40 1.20 1.40 1.20	B351200 HAE18038	E200, C220 CDI 2002/... CLC200/220 CDI 2005/... Viano CDI 2003/..., C220 CDI 2004/... DIESEL	2148cc. OM 646.951 102HP 646.962/963 122HP 646.966/963/982/983 150HP (DOHC) 16V Ø88	353201-R pág. 358
	351307	90.0	1.70	B351100 HAN10055 HAN10100	210D/310D/410D/G290/290GD 1992/... DIESEL	2874cc. MB602.940/942/947 95/98HP Ø89 (SOHC) 10V	351300-R pág. 351
	351408	81.0	1.20	B351400	A170 CDI 1998/01, Vaneo TD 2001/... DIESEL	1689cc. OM668.940 90HP OM668.941 91HP Ø90 (DOHC) 16V	
	351507	88.0	1.70	B351100 HAN10055 HAN10100	300 Turbo 1985/93, E300 Turbo 1993/96 300GD 1989/93 DIESEL	2996cc. OM603.931/950/960/963 143HP Ø87 (SOHC) 12V	351500-R pág. 352
	351607	88.0	1.95	B360100 HAN12055 HAN12100	L307/200D/N1300/MB90/ L307/MB100 L406D/L408D/0309D/306D/306DG 200D/L206/D61 DIESEL	1998cc. OM 615 55/60HP Ø87 (SOHC) 8V	351600-R pág. 353
	351707	91.0	1.70	B351700 HAN12055 HAN12100	190E 1990/93 190 1982/84, 190E 1985/93, 200 1984/93	1797cc. MB102.910/919 108HP 1996cc. MB102.962/922 105/122HP MB102.921 90/122HP Ø89 (SOHC) 8V	351700-R pág. 354

# MERCEDES BENZ

## JUNTA TAPA DE CILINDROS / HEAD GASKETS

### MOTORES NAFTA Y DIESEL / PETROL AND DIESEL ENGINES

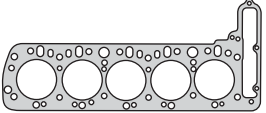
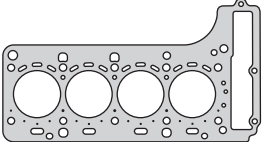
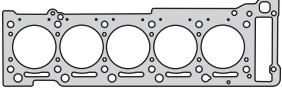
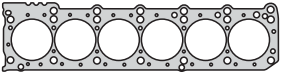
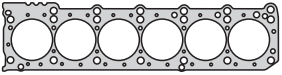
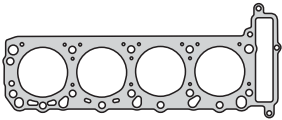
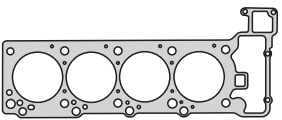
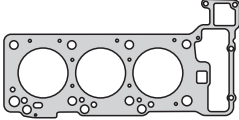
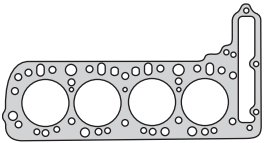
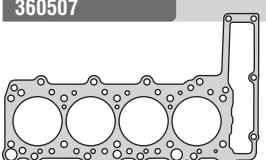
	Código Code	Q	≠	Kit Bulón Bolt Set	Aplicación Application	Motor Engine	Juego
	351807	92.0	1.70	B351800 HAN12055 HAN12100	300 GD, 300 GD (4 x 4) 209D/309D/ 409D/240D 300D/CD/TD 1974/89 <b>DIESEL</b>	2998cc. OM 617.910/913/931/932 80/88HP Ø91 (SOHC) 10V	351800-R pág. 355
	352108	84.0	1.30		Sprinter 2009/... <b>DIESEL</b>	2143cc. OM651 170/204HP Ø83 (DOHC) 16V	352100-R MLS pág. 356
	352407-1M 352407-2M 352408-1M 352408	90.0 90.0 90.0 90.0	1.20 1.40 1.20 1.40	B352400 HAE18038	E270 CDI, ML270 CDI, CLK270CDI C270 CDI/G270 CDI, Sprinter CDI 1999/... 2002/... C30 CDI AMG 2002/... <b>DIESEL</b>	2685cc. OM612.961/962/963/965/967 OM612.981 156/163/170HP Ø88 2950cc. OM 612.990 231HP Ø88 (DOHC) 20V	352401-R pág. 357
	352507	91.0	1.70	B352500 HAN12055 HAN12100	300/280 1992/... SL280/C280/S280/E280 1993/... 300CE/300E/300TE/300SL 1989/... 300SE 1991/..., 320CE/320E/320TE 1992/..., SL320/E320 1993/... G320/E320 1995/... S320 1999/...	2799cc. MB104 193/197/204HP Ø88,5 2960cc MB104 220/231HP Ø88,5 3199cc. MB104 231/220HP Ø89,9 (DOHC) 24V	
	352507	91.0	1.70	B352500 HAN12055 HAN12100	30SL 1992/... 300CE/300E/300TE 1993/... 300 TE 1994/96	3314cc MB104.980/981 231/251HP Ø88,5 3606cc. MB104.992 272HP Ø89,9 (DOHC) 24V	
	352607	93.0	1.80	B352600 HAN12055 HAN12100	400E/400SE/400SEL 1991/... 400A/E4001992/95 S500/E500/500E/500SE/500SEL 1991/...	4196cc. MB119.971/975 279/285HP 4973cc. MB119.970/972/974 320/326HP (DOHC) V8 32V Ø92	
	352708	91.5		B352700 HAN12055 HAN12100	ML430 1998/05 ML500 2001/05 - 2005/11 G5001998/...	4266cc. MB113.942 272HP Ø89,9 4966cc. MB113.964/964 215/225HP MB113.962 218HP Ø89,9 (DOHC) V6 24V	
	352808	92.0	0.65	B352800 HAT55055 HAT55100	C240, E240 1997/03 E320/G320/S320/SL320 1996/... C320/E320 2000/...	2398cc. MB112.910/911 170HP Ø84.5 2799cc. MB112.941/944/943/949/954 224HP MB112.940/942/946 947/953/955 218HP (SOHC) V6 18V Ø89,9	
	360107	92.0	1.70	B360100 HAN12055 HAN12100	240D/TD 1973/..., 207/307/407/507/510D L406/407DG, 0309D 1977/..., 240GD 1976/87, MB100/200/300/400 180D/150/170 <b>DIESEL</b>	2404cc. OM 616.912/934/960/916/940 961/963 65/72HP Ø91 (SOHC) 8V	360100-R pág. 359
	360507	88.0	1.70	B360500 HAN10055 HAN10100	E200D, C200D, 200D/TD 1984/93 190D 1984/... <b>DIESEL</b>	1997cc. MB601.911/912 72/75HP Ø87 2197cc. MB601.921 72HP Ø87 (SOHC) 8V	360500-R pág. 360



# MERCEDES BENZ

## JUNTA TAPA DE CILINDROS / HEAD GASKETS

### MOTORES NAFTA Y DIESEL / PETROL AND DIESEL ENGINES

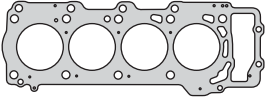
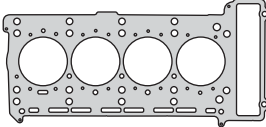
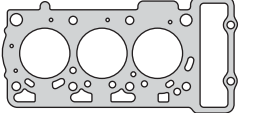
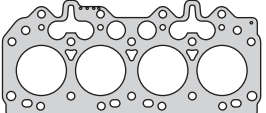
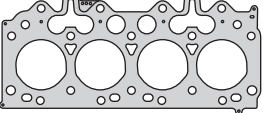
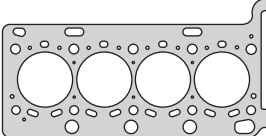
	Código Code	Q	≠	Kit Bulón Bolt Set	Aplicación Application	Motor Engine	Juego
	370008	81.0	0.60		Clase A 140 1997/... Clase A 160 1997/..., Vaneo 2001/...	<b>1397cc.</b> M166.940 82HP Ø80 <b>1598cc.</b> M166.960/961 102HP Ø80 (SOHC) 8V	
	370108	83.0	0.90		C180/C160/C200/CLK200 2002/... E200 2003/..., C230, SLK200 2004/...	<b>1796cc.</b> MB271.946 143HP MB271.921 122HP MB271.940/941 163HP MB271.948 192HP Ø82 (DOHC 16V)	<b>370100</b> 🚗 pág. 361
	380008	64.0	0.40	<b>B380000</b> 🔧 HAE12038	Pulse 1996/..., 2001/... Smart 1998/..., 2001/... City Coupe 2003/04	<b>599cc.</b> Suprex-t 45/54/70HP Ø63.5 <b>698cc.</b> 450.300 55HP - 450.330 64HP 450.332 70HP Ø63.5 (SOHC) 6V	
	<b>430007</b> 430007-1M 430007-2M 430007-3M 430007-4M	92.0 92.0 92.0 92.0	1.40 1.50 1.60 1.70	<b>B430000</b> <b>B430000-1</b> 🔧 HAS19038	Sprinter TDI 1997/... <b>DIESEL</b>	<b>2495cc.</b> 95HP Ø90.5	<b>430001-R</b> 🚗 pág. 365
	<b>430008</b> 430008-1M 430008-2M 430008-3M	92.0 92.0 92.0	1.20 1.30 1.40	<b>B430000</b> <b>B430000-1</b> 🔧 HAS19038	Sprinter TDI 1997/... <b>DIESEL</b>	<b>2495cc.</b> 95HP Ø90.5	<b>430001-R</b> 🚗 pág. 365
	582508	81.0	1.25	<b>B582500</b> 🔧 HAE18038	Vito 2014/... <b>DIESEL</b>	<b>1598cc.</b> 622 88/114HP Ø80 (DOHC) 16V	

# MERCEDES BENZ



Motor/Engine	Cm³	HP	Ø
OM 636.916/918	1767	40	75
OM 636.919/931	1767	40	75
OM 636.930/934 (SOHC) 8V	1767	45	75

Mercedes Benz: 170DA, 170DB, 170DS, 170SD  
180D, 180DB, O 319D  
L405, L406

DIESEL



Nº OE	Descripción/Description	Mat.	Ref.
	Jgo. de juntas para motor		350500
6360160820	Junta tapa cilindros Ø 77.0 ± 1.70	NFT 1	350505
6360160180	Junta tapa válvulas superior	CG 1	350510
	Jgo. junta para cárter (2)	NB 1	350511
63601500380	Tapa distribución	NB 1	350512
1360150120	Placa distribución	NB 1	350513
1532010080	Cuerpo bomba de agua	NB 1	350514
6361410179	Jgo. múltiple escape (2)	NFT 1	350516
6361420080	Jgo. múltiple admisión (2)	NB 1	350517
153492181	Salida de escape	CHA 1	350518
6361840480	Tapa filtro aceite	NB 1	350527
6360740480	Acople bomba inyectora	NB 1	350528
6361840380	Acople filtro bomba aceite	NB 1	350529
6360110180	Tapa lateral admisión	NB 1	350530
	Arandela bomba aceite	NB 1	350533
6360150180	Tapa válvulas lateral	CG 1	350536
	Bancada cigüeñal	SNA 1	350558
	Retén distribución 22 x 35 x 10		

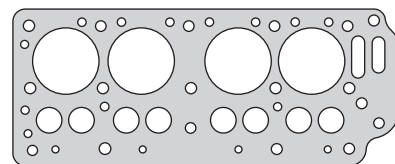

350505

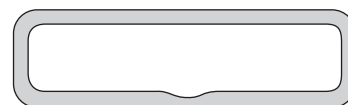

350510

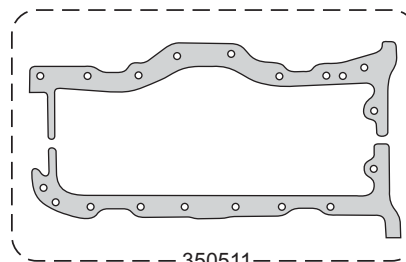

350511

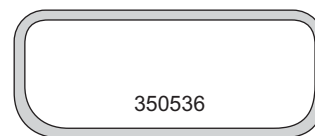

350512

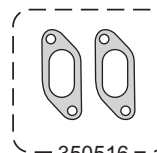

350516

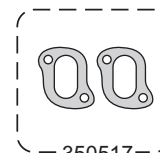

350517

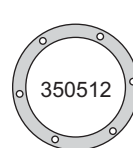

350514

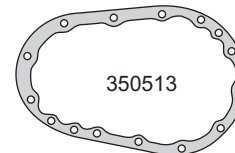

350513



350514



350518



350527



350528



350529



350530



350533



350558

# MERCEDES BENZ



Motor/Engine	Cm³	HP	Ø
OM 602.983	2874	129	89
OM 602.982	2874	129	89
OM 602.980	2874	122	89
OM 662 (SOHC) 10V	2874	120	89

**Mercedes Benz:** Sprinter T1N 1995/99  
290 TD, E290 GTD 1994/...

**SsangYong:** Korando KJ TDI, Musso MJ TDI  
1997/...



DIESEL

Nº OE	Descripción/Description	Mat.	Ref.
	Jgo. de juntas para motor		● 351100-R
6020163920	Junta tapa cilindros Ø 90.0 ± 1.70	NFT	1 351107
	Jgo. tornillos tapa cilindros (HAN10055/10100)		B351100
6020160221	Junta tapa válvulas	GS	1 351110
6120140122	Junta para cárter	NB	1 351111
	Tapa bomba de agua	NB	1 351114
6021420080	Múltiple escape	AC	1 351115
6021410880	Múltiple admisión	NB	1 351117
	Soporte bomba de agua	NB	1 351119
	Soporte bomba de agua	NH	351119-1
	Base soporte filtro de aceite	NB	1 351129
6612034132	Entrada agua a tapa de cilindros	NB	1 360530
	Base depresora a distribución	NH	1 351131
6050140122	Junta para cárter inferior	NB	1 351132
	Guarnición tapón aceite	GS/AC	351133
	Arandela pico inyector	AL	5 320046
	Arandela A 12 x 15 x 1.5 A	AL	
	Arandela A 22 x 28 x 1.25 A	AL	4
	Arandela A 27 x 32 x 2 A	AL	
	Arandela A 25 x 30 x 2 A	AL	
	Arandela A 10 x 13.8 x 1 A	AL	
	Arandela A 18.5 x 22 x 1.5 A	AL	
	Arandela A 14 x 18 x 1.25 A	AL	1
	Arandela A 14.5 x 20 x 1.5 C	CU	
	Arandela A 7 x 15 x 1.5 C	CU	
	Arandela A 10 x 13.3 x 1 A	AL	
	O´ring G 8 x 2	GS	
	O´ring G 17.04 x 3.53	GS	1
	O´ring G 38 x 3	GS	
	O´ring G 75 x 3	GS	
	O´ring G 35 x 2	GS	
	O´ring G 42 x 4	GS	1
	Kit de retenes completo		R351100
	Jgo. retén válvulas (10)	V	1 R351110V
0179977447	Retén bancada 93 x 114 x 13	V	1 R351111V
0219977647	Retén distribución 45 x 67 x 8	V	1 R351112V

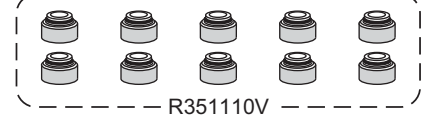
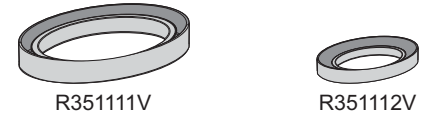
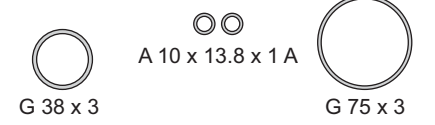
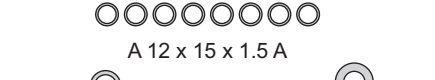
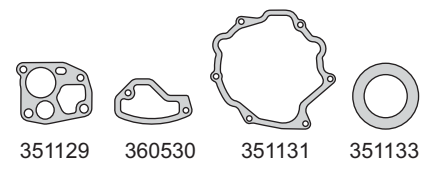
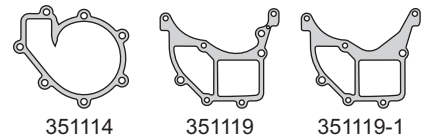
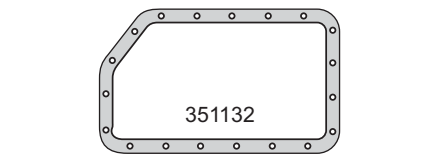
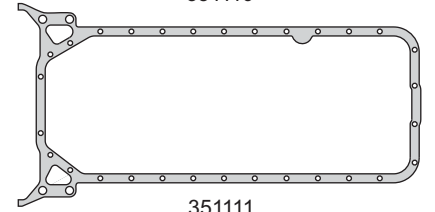
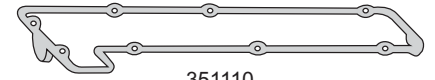
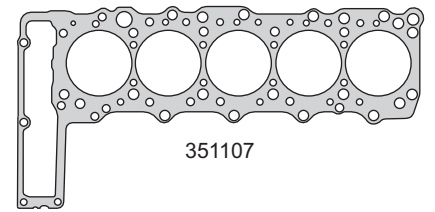

**MERCEDES  
BENZ**



Motor/Engine	Cm³	HP	Ø
OM611 CDI 611.960/961/980 (DOHC) 16V	2151	100/125	88
<b>DIESEL</b>			

**Mercedes Benz:** Sprinter 413 CDI  
411/413/313/611/981 2000/...  
C200-CDI 611.960/961 1998/...  
Vito 108/110/112 CDI  
Sprinter 208/211/213 CDI  
611.980



Nº OE	Descripción/Description	Mat.	Ref.
6110104520	Jgo. de juntas para motor		351201-R
	Jgo. de juntas superior		351295-1M
	Jgo. de juntas superior		351295-2M
	Junta tapa cilindros Ø 89.0 ± 1.20	NFT 1	351207-1M
	Junta tapa cilindros Ø 89.0 ± 1.40	NFT	351207-2M
6110160520	Junta tapa cilindros Ø 89.0 ± 1.20	MLS	351208-1M
6110160920	Junta tapa cilindros Ø 89.0 ± 1.40	MLS	351208-2M
6110160520	Junta tapa cilindros Ø 89.0 ± 1.20	MLS	351208
910143008011	Jgo. tornillos tapa cilindros (HAE18038)		B351200
6110160121	Jgo. junta tapa válvulas (9)	GS 1 1	351210
6110140222	Junta para cárter	NFT 1	351211
6112010280	Bomba de agua	SLS 1	351214
6111420380	Múltiple escape	AC 1 1	351215
6110980380	Múltiple admisión	SLS 1 1	351217
6112030380	Guarnición base termostato	GS 1 1	351219
6110160221	Guarnición protección bujías	GS 4 4	351231
	Arandela tapa válvulas	GS 4 4	351232
6110980180	Guarnición colector admisión	GS 1 1	351233
6110980280	Jgo. cierre colector admisión (4)	GS 1 1	351234
6110980380	Jgo. entre colectores inferior (4)	GS 1 1	351235
	Jgo. múltiple admisión entre múltiples (8)	GS 1 1	351237
	O´ring G 44 x 3	GS 1 1	
	Arandela pico inyector A 8 x 14 x 1.5 C	CU 4 4	
	Arandela A 15 x 20 x 1 C	CU 1 1	
	Kit de retenes completo		R351200
6120500058	Jgo. retén válvulas (16)	V 1	R351210V
6110100114	Porta retén bancada trasero	T	PR351211T
0219977647	Retén distribución 45 x 67 x 8	V 1	R351112V

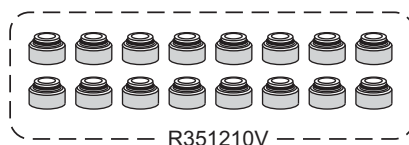
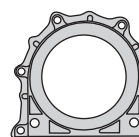
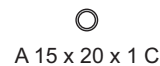
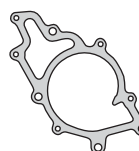
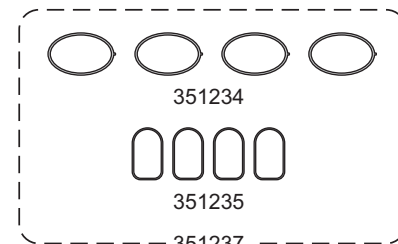
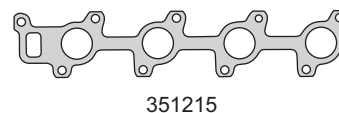
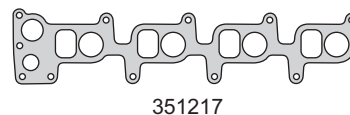
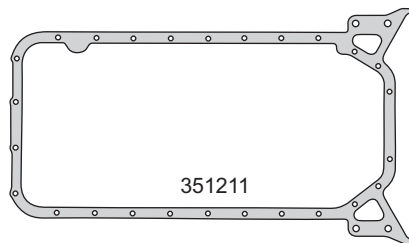
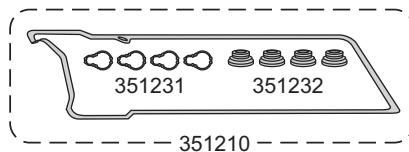
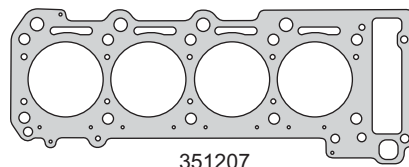

# MERCEDES BENZ



Motor/Engine	Cm³	HP	Ø
OM 602.940	2874	95	89
OM 602.942	2874	95/98	89
OM 602.947	2874	98	89
OM 662 (SOHC) 10V	2874	95	89

**Mercedes Benz:** 210D, 310D, 410D, G290  
290 GD 1992/...

**SsangYong:** Korando KJ 1996/....  
Musso MJ 1995/...



**DIESEL**

Nº OE	Descripción/Description	Mat.	Ref.
	<b>Jgo. de juntas para motor</b>		<b>351300-R</b>
	<b>Junta tapa cilindros Ø 90.0 ± 1.70</b>	NFT	<b>1 351307</b>
	<b>Jgo. tornillos tapa cilindros (HAN10055/10100)</b>		<b>B351100</b>
6020160321	Junta tapa válvulas	GS	1 351310
6120140122	Junta para cárter	NB	1 351111
	Tapa bomba de agua	NB	1 351114
6021420080	Múltiple escape	AC	1 351115
6021410880	Múltiple admisión	NB	1 351117
	Soporte bomba de agua	NB	1 351119
	Soporte bomba de agua	NB	351119-1
	Base soporte filtro de aceite	NB	1 351129
6612034132	Entrada agua a tapa de cilindros	NB	1 360530
	Base depresora a distribución	NB	1 351131
	Junta para cárter inferior	NB	1 351132
	Guarnición tapón aceite	GS	351133
	Arandela pico inyector A 7.8 x 20 x 2.6	AC	5 320046
	Arandela A 12 x 15 x 1.5 A	AL	
	Arandela A 22 x 28 x 1.25 A	AL	4
	Arandela A 27 x 32 x 2 A	AL	
	Arandela A 25 x 30 x 2 A	AL	
	Arandela A 10 x 13.8 x 1 A	AL	
	Arandela A 18.5 x 22 x 1.5 A	AL	
	Arandela A 14 x 18 x 1.25 A	AL	1
	Arandela A 14.5 x 20 x 1.5 C	CU	
	Arandela A 10 x 13.8 x 1 A	AL	
	O´ring G 8 x 2	GS	
	O´ring G 17.04 x 3.53	GS	1
	O´ring G 38 x 3	GS	
	O´ring G 75 x 3	GS	
	O´ring G 35 x 2	GS	
	O´ring G 42 x 4	GS	1
	Kit de retenes completo		R351100
	Jgo. retén válvulas (10)	V	1 R351110V
0179977447	Retén bancada 93 x 114 x 13	V	1 R351111V
0219977647	Retén distribución 45 x 67 x 8	V	1 R351112V

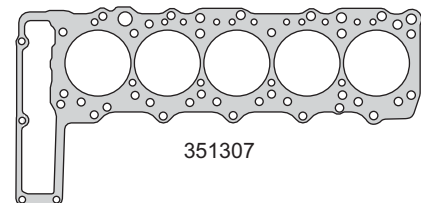

351307

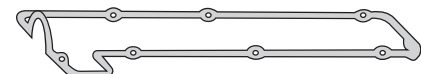

351310

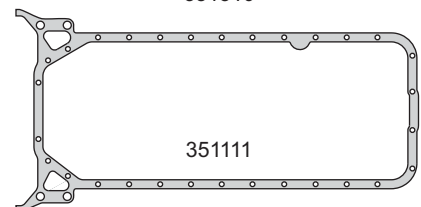

351111

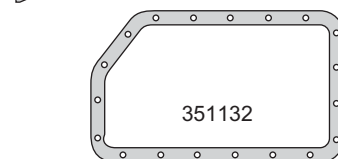

351132



351115



351117

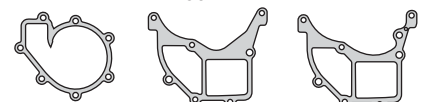

351114

351119

351119-1

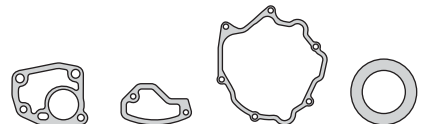

351129

360530

351131

351133



320046



A 22 x 28 x 1.25 A

A 18.5 x 22 x 1.5 A



A 12 x 15 x 1.5 A



A 14 x 18 x 1.25 A

A 27 x 32 x 2 A



G 35 x 2

G 17.04 x 3.53

G 42 x 4

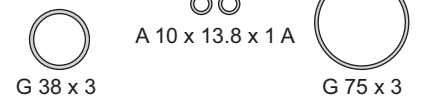

G 38 x 3

A 10 x 13.8 x 1 A

G 75 x 3



R351111V



R351112V

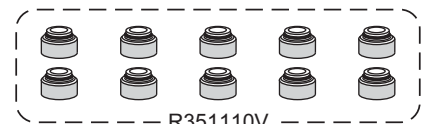

R351110V

# MERCEDES BENZ



Motor/Engine	Cm³	HP	Ø
OM 603.931 OM 603.950 OM 603.960 OM 603.963 (SOHC) 12V	2996	143	87

Mercedes Benz: 300 Turbo 1985/93  
E300 Turbo 1993/96  
300GD 1989/93

DIESEL



Nº OE	Descripción/Description	Mat.	Ref.
	Jgo. de juntas para motor		351500-R
6020163920	Junta tapa cilindros Ø 88.0 ± 1.70	NFT 1	351507
	Jgo. tornillos tapa cilindros (HAN10055/10100)		B351100
6020160221	Junta tapa válvulas	GS 1	351510
6120140122	Junta para cárter	NB 1	351511
6021420080	Múltiple escape	NFT 1	351515
6021410880	Múltiple admisión	NB 1	351517
	Soporte bomba de agua	NB 1	351119
	Base soporte filtro de aceite	NB 1	351529
	Entrada agua a tapa de cilindros	NB 1	351130
	Base depresora a distribución	NB 1	351131
	Jgo. de arandelas pico inyector (6)	CU 1	320044
	O´ring G 73.5 x 2.75	GS 1	
	O´ring G 17 x 3.75	GS 2	
	O´ring G 36 x 1.50	GS 1	
	O´ring G 38 x 3	GS 1	
	O´ring G 8 x 2	GS 2	
	Arandela A 22 x 28 x 1.25 A	AL 5	
	Anillo G 38.5 x 57 x 2.6	GS 1	
	Arandela A 25 x 30 x 2 A	AL 2	
	Arandela A 18 x 21.5 x 1.5 A	AL 1	
	Arandela A 10 x 13 x 1 A	AL 1	
	Arandela A 14 x 17.8 x 1.3 A	AL 1	
	Arandela A 12 x 15 x 1.5 A	AL 8	
	Arandela A 10 x 14 x 1 A	AL 2	
	Arandela A 20 x 15 x 1.5 C	CU 1	
	Kit de retenes completo		R351500
	Jgo. retén válvulas (12)	V 1	R351510V
0179977447	Retén bancada 93 x 114 x 13	V 1	R351111V
0219977647	Retén distribución 45 x 67 x 8	V 1	R351112V

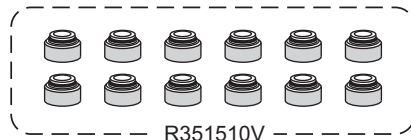
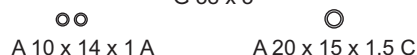
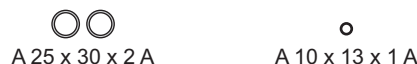
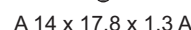
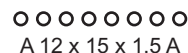
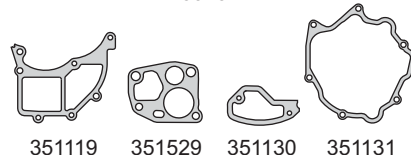
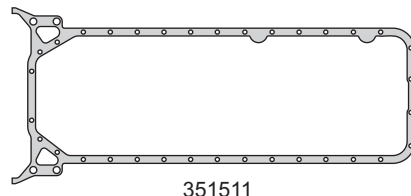
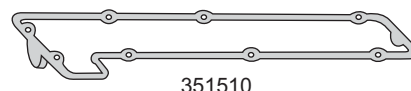
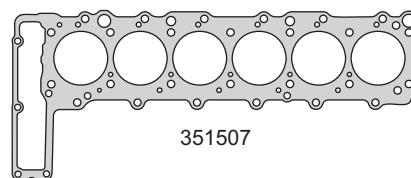

# MERCEDES BENZ



Motor/Engine	Cm³	HP	Ø
OM 615 (SOHC) 8V	1988	55/60	87
<b>DIESEL</b>			

**Mercedes Benz:** L307, 200D, N1300, MB90  
L307, MB100, L406D, L408D  
0309D, 306D, 306DG, 200D  
L206 D61

**Seat:** 131, 132

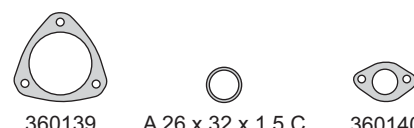
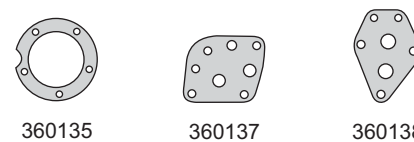
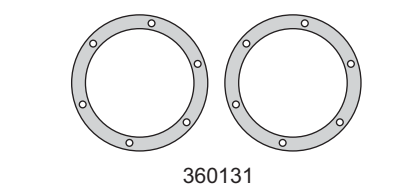
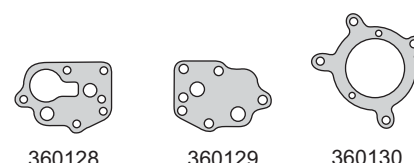
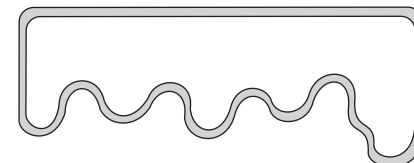
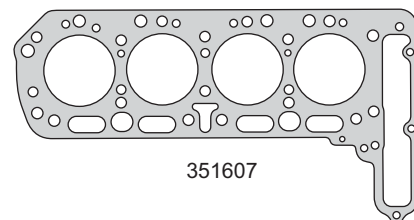

Nº OE	Descripción/Description	Mat.	Ref.
	Jgo. de juntas para motor		● 351600-R
	Junta tapa cilindros Ø 88.0 ± 1.95	NFT	1 351607
	Jgo. tornillos tapa cilindros (HAN12055/12100)		B360100
	Sellador líquido - caucho de silicona		TRN0085G
	Junta tapa válvulas	N	1 360110
	Múltiple admisión y escape	NFT	1 360116
	Base filtro aceite	NB	1 360128
	Intercambiador	NB	1 360129
	Bomba hidráulica	NB	1 360130
	Bomba vacío	NB	2 360131
	Tapa termostato	NB	1 360132
	Tensor hidráulico	NB	1 360133
	Acople termostato	NB	1 360134
	Junta	NB	1 360135
	Cuerpo aceite	NB	1 360137
	Junta	NB	1 360138
	Junta	NB	1 360139
	Junta	NB	1 360140
	Retén cigüeñal	SNA	1 360158
	O´ring G 25.07 x 2.62	GS	1
	O´ring G 7.65 x 1.78	GS	1
	Arandela A 26 x 32 x 1.5 C	AL	1
	Arandela A 27 x 32 x 1.5 C	CU	6
	Kit de retenes completo		R360100
	Jgo. retén válvulas (8)	P	1 R360110P
	Retén distribución 45 x 74.5/79 x 12/14.5	P	1 R360112P

# MERCEDES BENZ



Motor/Engine	Cm³	HP	Ø
MB102.910/919	1797	108	89
MB102.921	1996	90/122	89
MB102.962/922 (SOHC) 8V	1996	105/122	89

Mercedes Benz: 190E 1990/93  
190 1982/84, 190E 1985/93  
200 1984/93



Nº OE	Descripción/Description	Mat.	Ref.
1020162328	Jgo. de juntas para motor	●	351700-R
1020161221	Junta tapa cilindros Ø 91.0 ± 1.70  NRT	NFT	1 351707
	Jgo. tornillos tapa cilindros (HAN12055/12100)		B351700
1020140722	Junta tapa válvulas	GS	1 351710
	Junta para cárter	NH	1 351711
	Tapa distribución	NH	1 351712
	Bomba de agua	NB	1 351714
	Jgo. múltiple escape (5)	VS	1 351715
1021412780	Múltiple admisión	NFT	1 351717
	Múltiple admisión	AC	1 351717-1
	Base termostato	NB	1 351719
	Bomba nafta	NB	1 351728
	Junta	GS	1 351733
	Junta	NB	1 351734
	Junta	NB	1 351735
	Junta	NB	1 351740
	Junta	NB	1 351741
	Arandela A 10.3 x 13.8 x 1 A	AL	3
	Arandela A 14.3 x 17.8 x 1.34 A	AL	4
	Arandela A 27.8 x 31.7 x 2 A	AL	1
	Arandela A 22.4 x 27 x 1.36 A	AL	1
	Arandela A 18.4 x 24 x 1.36 A	AL	1
	Arandela A 14.4 x 19.82 x 1.90 A	AL	1
	Arandela A 12 x 16.8 x 1.39 C	CU	2
	Arandela A 14.45 x 19.8 x 1.36 C	CU	1
	Arandela A 8.4 x 11.8 x 0.82 C	CU	2
	O´ring G 42 x 4.5	GS	1
	O´ring G 30 x 2.6	GS	2
	O´ring G 37 x 2	GS	1
	O´ring G 39 x 2.9	GS	1
	O´ring G 18.4 x 5	GS	1
	O´ring G 12 x 2	GS	1
	Kit retenes completo		R360500
1020500158	Jgo. retén válvulas (8)	V	1 R360510V
0179977447	Retén de bancada 93 x 114 x 13	V	1 R351111V
1209970346	Retén distribución 45 x 67 x 8	V	1 R351112V

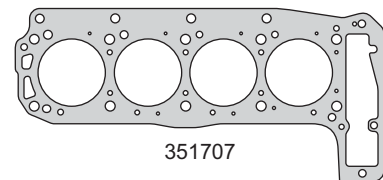

351707

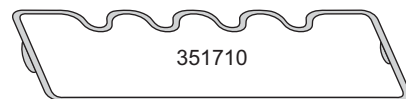

351710

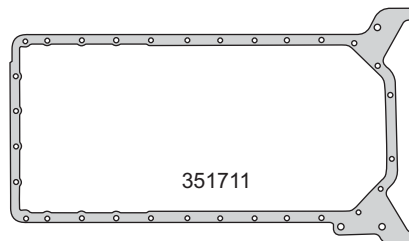

351711

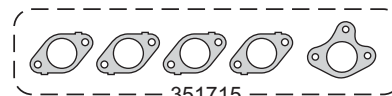

351715



351717

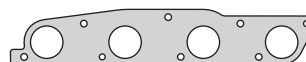

351717-1

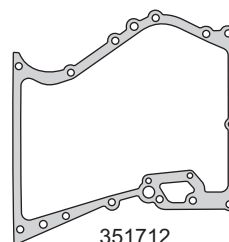

351712



351714



351719



351728



351733



351734



351735



351740



351741



G 37 x 2



G 42 x 4.5



G 30 x 2.6



G 39 x 2.9



G 18.4 x 5



A 27.8 x 31.7 x 2 A



G 12 x 2



A 10.3 x 13.8 x 1 A



A 22.4 x 27 x 1.36 A



A 14.3 x 17.8 x 1.34 A



A 12 x 16.8 x 1.39 C



A 18.4 x 24 x 1.36 A



R351111V



R351112V



R360510V



# MERCEDES BENZ



Motor/Engine	Cm³	HP	Ø
OM 617.910	2998	88	91
OM 617.913	2998	80	91
OM 617.931	2998	88	91
OM 617.932 (SOHC) 10V	2998	88	91

Mercedes Benz: 300 GD, 300 GD (4 x 4)  
209D, 309D, 409D, 240D  
300D/CD/TD 1974/89

DIESEL

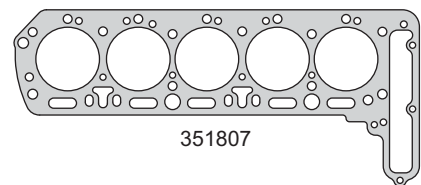

351807

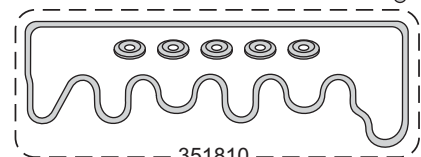

351810

Nº OE	Descripción/Description	Mat.	Ref.
	<b>Jgo. de juntas para motor</b>		<b>351800-R</b>
	<b>Junta tapa cilindros Ø 92.0 ± 1.70</b>	NFT	<b>1 351807</b>
	<b>Jgo. tornillos tapa cilindros (HAN12055/12100)</b>		<b>B351800</b>
	Conj. junta tapa válvulas (6)	GS	1 351810
	Junta para cárter	NH	1 351811
	Tubo de escape	NFT	1 351818
	Base termostato	NH	1 351819
	Base termostato	NH	1 351620
	Bomba hidráulica	NH	1 351621
	Base filtro aceite	NH	1 360128
	Bomba hidráulica	NH	1 360130
	Bomba vacío	NH	1 360131
	Termostato	NH	1 360132
	Arandela pico inyector	CU	5 351833
	Bomba aceite	NH	1 351837
	Aspiración admisión	NH	1 351838
	Acople admisión	NH	1 360139
	Brida retorno aceite	NH	1 360140
	O´ring tapón aceite G 105 x 4	GS	1
	O´ring G 60 x 3.53	GS	1
	O´ring G 10 x 2	GS	1
	O´ring G 12 x 2	GS	1
	O´ring G 7.5 x 1.83	GS	1
	O´ring G 4 x 1.63	GS	1
	O´ring G 26 x 2.63	GS	1
	Arandela A 37 x 32 x 2 A	AL	1
	Arandela A 11 x 8 x 1 A	AL	5
	Arandela A 11 x 8 x 1 C	CU	4
	Arandela A 15 x 12 x 1.30 A	AL	6
	Arandela A 17.9 x 14.3 x 1.50 A	AL	2
	Arandela A 13.8 x 8.2 x 1 A	AL	1
	Arandela A 16.9 x 12 x 1.60 A	AL	1
	Arandela A 43.8 x 38 x 2 A	AL	4
	Arandela A 36 x 30 x 2 A	AC	5
	Arandela A 28.8 x 24 x 2 A	AL	1
	Arandela A 24 x 18.2 x 1.30 A	AC	2
	Arandela A 21.8 x 18 x 1.30 A	AL	3
	Arandela A 19.9 x 14 x 1.80 A	AL	3
	Arandela A 17.9 x 14.3 x 1.5 C	CU	8
	Arandela A 32.2 x 28 x 1.80 C	CU	5
	Arandela A 30.9 x 26.3 x 2.30 C	CU	1
	Arandela A 16.85 x 12.3 x 1.50 C	CU	1
	Arandela A 17.9 x 14.3 x 1.30 A	AL	10
	Arandela A 30.7 x 26.5 x 1.82	AC	1
	Retén cigüeñal	SNA	1 360158
	Kit de retenes completo		R351800
	Jgo. retén válvulas (10)	V	1 R351810V
	Retén distribución 45 x 74.5/79 x 12/14.5	V	1 R360112V

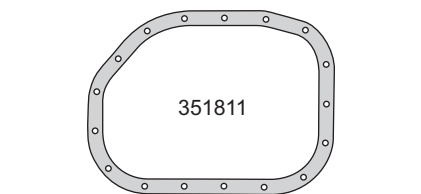

351811

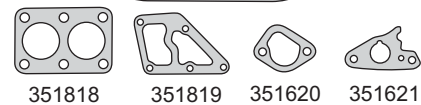

351818 351819 351620 351621

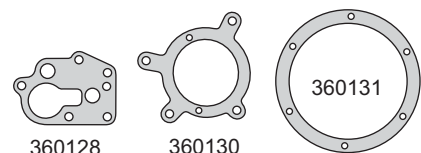

360128 360130 360131

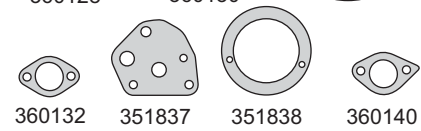

360132 351837 351838 360140

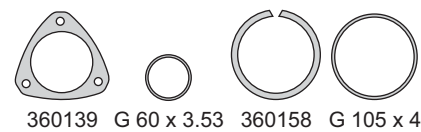

360139 G 60 x 3.53 360158 G 105 x 4

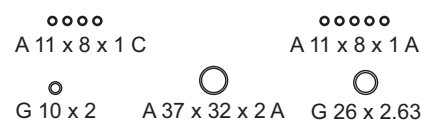

A 11 x 8 x 1 C A 11 x 8 x 1 A

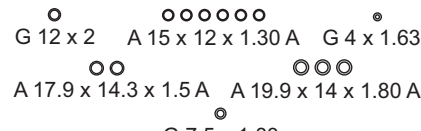

G 10 x 2 A 37 x 32 x 2 A G 26 x 2.63 G 12 x 2 A 15 x 12 x 1.30 A G 4 x 1.63 A 17.9 x 14.3 x 1.5 A A 19.9 x 14 x 1.80 A

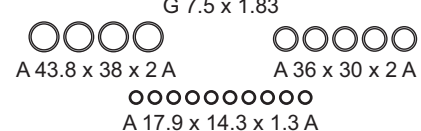

G 7.5 x 1.83 A 43.8 x 38 x 2 A A 36 x 30 x 2 A

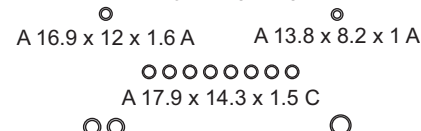

A 17.9 x 14.3 x 1.3 A A 16.9 x 12 x 1.6 A A 13.8 x 8.2 x 1 A

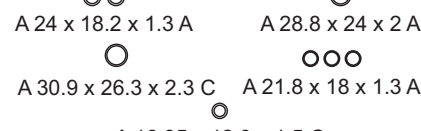

A 17.9 x 14.3 x 1.5 C A 24 x 18.2 x 1.3 A A 28.8 x 24 x 2 A A 30.9 x 26.3 x 2.3 C A 21.8 x 18 x 1.3 A

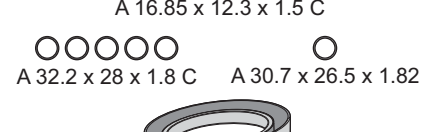

A 16.85 x 12.3 x 1.5 C A 32.2 x 28 x 1.8 C A 30.7 x 26.5 x 1.82



R360112V



R351810V

**MERCEDES  
BENZ**



Motor/Engine	Cm³	HP	Ø
OM651 (DOHC) 16V	2143	170/204	83

Mercedes Benz: Sprinter 2009/...

DIESEL



Nº OE	Descripción/Description	Mat.	Ref.
	<b>Jgo. de juntas para motor</b>		● 352100-R MLS
	<b>Jta. tapa cilindros Ø 84.0 ± 1.30</b>	MLS 1	352108
	Junta tapa válvulas	S 1	352110
	Junta tapa válvulas	S 1	352136
	Junta para cárter	NFT	352111
	Junta distribución	SLS 1	352112
	Bomba de agua	SLS 1	352114
	Múltiple escape	AC 1	352115
	Múltiple admisión	S 1	352117
	Salida de escape a turbo	AC 1	352118
	Guarnición termostato	S 1	352119
	Guarnición goma	S 1	352129
	Guarnición goma	S 1	352131
	Guarnición goma	S 1	352132
	Guarnición goma	S 1	352133
	Guarnición goma	S 1	352134
	Guarnición goma	S 1	352135
	Guarnición goma	S 1	352137
	Junta intercambiador de calor	SLS 1	352138
	Guarnición goma	S 1	352141
	Junta	SLS 2	352142
	Junta bomba depresora	SLS 1	352143
	Junta	SLS 1	352144
	Junta	AC 1	352145
	Junta	FCH 1	352146
	O´ring G 8 x 3	GS 1	
	O´ring G 15.47 x 3.53	GS 1	
	O´ring G 16 x 1.50	GS 4	
	O´ring G 16.5 x 1.50	GS 1	
	O´ring G 22 x 3.10	GS 1	
	O´ring G 24 x 3.10	GS 1	
	O´ring G 44 x 3.10	GS 11	
	O´ring G 101 x 5	GS 1	
	Arandela A 7.5 x 15 x 1.50 A	AL 4	
	Arandela A 10 x 14 x 1.50 A	AL 2	
	Kit de retenes completo		R352100
	Jgo. retén válvulas (16)	P 1	R352110P
	Retén bancada 96 x 114 x 9	P 1	R352111P
	Retén distribución 60 x 75 x 8	P 1	R352112P

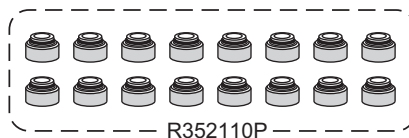
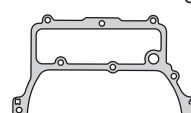
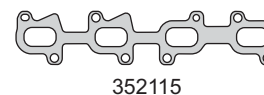
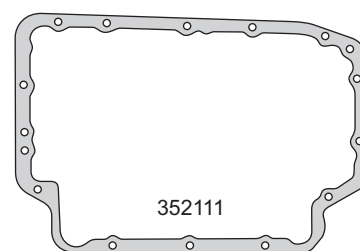
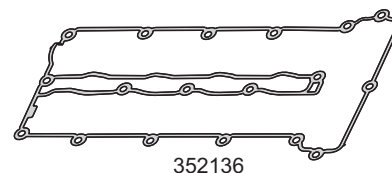
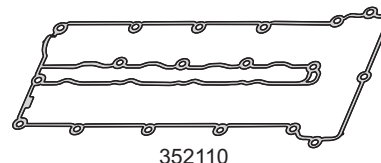
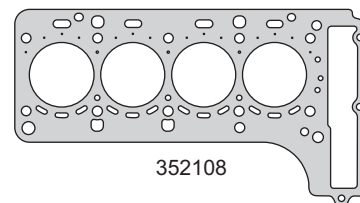

# MERCEDES BENZ



Motor/Engine	Cm³	HP	Ø
OM612.961/962	2685	163/170	88
963/965/967/981	2685	156/163	88
ENF	2685	163	88
OM 612.990 (DOHC) 20V	2950	231	88

**Jeep:** Grand Cherokee TD 2002/...  
**Mercedes Benz:** E270 CDI, ML270 CDI 1999/...  
 CLK270CDI, C270 CDI 2000/...  
 G270 CDI, Sprinter CDI 2000/...  
 C30 CDI AMG 2002/...

DIESEL

Nº OE	Descripción/Description	Mat.	Ref.
	Jgo. de juntas para motor		352401-R
	Jgo. de juntas superior		352495
6460160620	Jta. tapa de cilindro Ø 90.0 ± 1.20	NFT	352407-1M
6460160720	Jta. tapa de cilindro Ø 90.0 ± 1.40	NFT	352407-2M
6460160680	Jta. tapa de cilindro Ø 90.0 ± 1.20	MLS	352408-1M
6460160720	Jta. tapa de cilindro Ø 90.0 ± 1.40	MLS	352408
6119901022	Jgo. tornillos tapa cilindros (HAE18038)		B352400
6470160121	Jgo. junta tapa válvulas (11)	GS	1 1 352410
6120140122	Junta para cárter	NB	1 352411
6112011280	Bomba de agua	SLS	1 351214
6171420380	Múltiple escape	MLS	1 1 352415
6121410180	Múltiple admisión	SLS	1 1 352417
6461420080	Salida de escape a turbo	SLS	351218
6112030380	Guarnición base termostato	GS	1 1 351219
6460161321	Guarnición protección bujías	GS	5 5 351231
	Arandela tapa válvulas	GS	5 5 351232
6460160281	Enfriador aceite	GS	352432
6110940080	Jgo. colector admisión (5) 1999/05	GS	1 1 352435
6111840280	Enfriador aceite	GS	1 352436
	Varilla aceite	SLS	352437
	Guarnición llenado aceite 47 x 62 x 2.3	GS	352438
	Guarnición conductores 26 x 13 x 1.5	GS	352439
	O´ring G 28 x 2	GS	1
	O´ring G 44 x 3	GS	1
	O´ring G 37.77 x 2.62	GS	2
	O´ring G 32.2 x 2.2	GS	
	O´ring G 16 x 2.5	GS	1
	O´ring G 7.59 x 2.62	GS	1
	Arandela pico inyector A 8 x 15 x 1.5 C	CU	1 1
	Arandela tapón cárter A 27 x 32 x 2 A	AL	
	Arandela A 10 x 15 x 1 C	CU	
	Arandela A 14.3 x 20 x 1.3 C	CU	
	Arandela A 12 x 18 x 1.5 A	AL	1
	Kit de retenes completo		R352400
6120500058	Jgo. retén válvulas (20)	V	1 R352410V
6110100214	Porta retén bancada trasero	T	PR351211T
0219977647	Retén distribución 45 x 67 x 8	V	1 R351112V

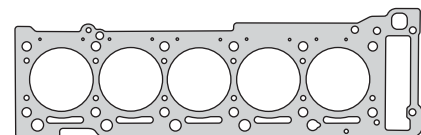

352408

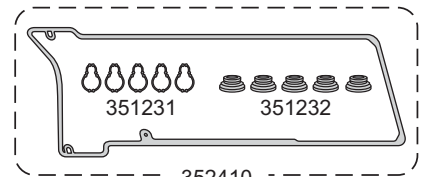

352410

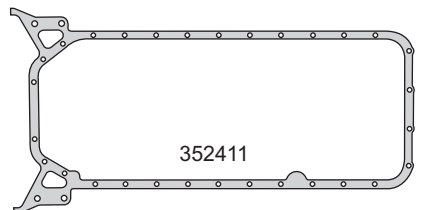

352411



352415



352417

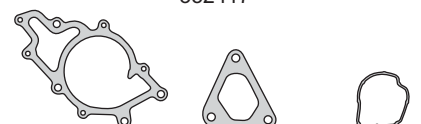

351214

351218

351219

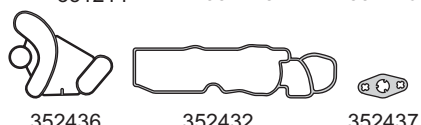

352436

352432

352437



352435



352438

352439

352439

G 32.2 x 2.2



G 37.77 x 2.62

G 44 x 3

G 7.59 x 2.62



G 16 x 2.5

A 27 x 32 x 2 A

G 28 x 2

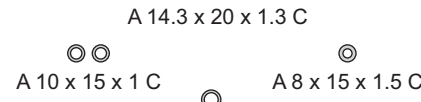

A 14.3 x 20 x 1.3 C

A 10 x 15 x 1 C

A 8 x 15 x 1.5 C

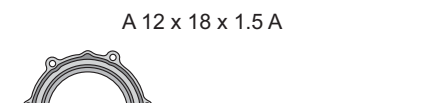

A 12 x 18 x 1.5 A

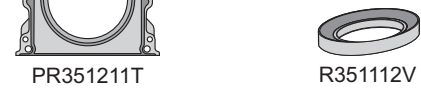

PR351211T

R351112V



R352410V

**MERCEDES  
BENZ**



Motor/Engine	Cm³	HP	Ø
OM646 CDI (DOHC) 16V	2148	122/150	88

Mercedes Benz: E200, C220 CDI 2002/...  
CLC200/220 CDI 2005/...  
Viano CDI 2003/...  
C220 CDI 2004/...



DIESEL

Nº OE	Descripción/Description	Mat.	Ref.
6110104520	Jgo. de juntas para motor		353201-R
	Jgo. de juntas superior		353295-1M
	Jgo. de juntas superior		353295-2M
	Junta tapa cilindros Ø 89.0 ± 1.20	NFT 1	351207-1M
	Junta tapa cilindros Ø 89.0 ± 1.40	NFT	351207-2M
6110160520	Junta tapa cilindros Ø 89.0 ± 1.20	MLS	351208-1M
6110160920	Junta tapa cilindros Ø 89.0 ± 1.40	MLS	351208-2M
6110160520	Junta tapa cilindros Ø 89.0 ± 1.20	MLS	351208
910143008011	Jgo. tornillos tapa cilindros (HAE18038)		B351200
6110160121	Jgo. junta tapa válvulas (9)	GS 1 1	353210
6110140222	Junta para cárter	NFT 1	351211
6112010280	Bomba de agua	SLS 1	351214
6111420380	Múltiple escape	AC 1 1	351215
6110980380	Múltiple admisión	SLS 1 1	351217
	Jgo. múltiple admisión (4)	GS 1 1	353217
6112030380	Guarnición base termostato	GS 1 1	351219
6110160221	Guarnición protección bujías	GS 4 4	351231
	Arandela tapa válvulas	GS 4 4	351232
6110980180	Guarnición colector admisión	GS 1 1	351233
6110980280	Jgo. cierre colector admisión (4)	GS 1 1	351234
6110980380	Jgo. entre colectores inferior (4)	GS 1 1	351235
	Jgo. múltiple admisión entre múltiples (8)	GS 1 1	351237
	O´ring G 44 x 3	GS 1 1	
	Arandela pico inyector A 8 x 14 x 1.5 C	CU 4 4	
	Arandela A 15 x 20 x 1 C	CU 1 1	
	Kit de retenes completo		R351200
6120500058	Jgo. retén válvulas (16)	V 1	R351210V
6110100114	Porta retén bancada trasero	T	PR351211T
0219977647	Retén distribución 45 x 67 x 8	V 1	R351112V

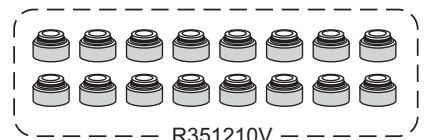
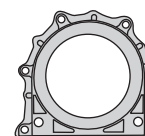
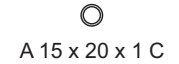
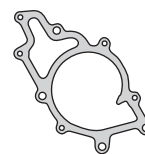
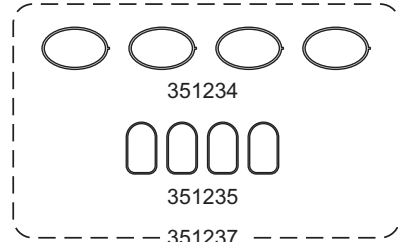
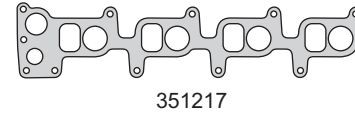
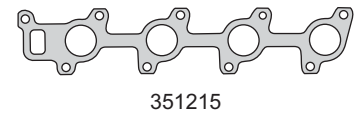
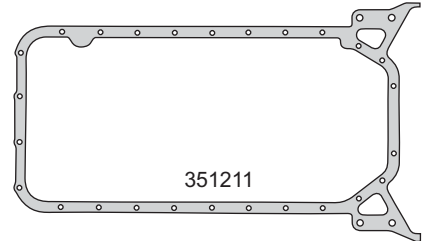
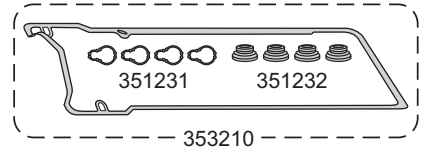
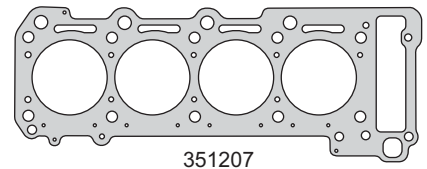

# MERCEDES BENZ



Motor/Engine	Cm³	HP	Ø
OM 616.912	2404	65	91
OM 616.934/960	2404	65	91
OM 616.916/940	2404	72	91
OM 616.961/963 (SOHC) 8V	2404	72	91

Mercedes Benz: 240D/TD 1973/..., 207/307D 407/507/510D, L406/407DG 0309D 1977/..., 240GD 76/87 MB100/200/300/400/180D MB150/170



DIESEL

Nº OE	Descripción/Description	Mat.	Ref.
	Jgo. de juntas para motor		● 360100-R
6210100321	Junta tapa cilindros Ø 92.0 ± 1.70	NFT	1 360107
	Jgo. tornillos tapa cilindros (HAN12100/12055)		B360100
6150160080	Junta tapa válvulas	N	1 360110
	Jgo. junta para cárter (3)	NB	1 360111
6211421180	Múltiple admisión y escape	NFT	1 360116
	Base filtro aceite	NB	1 360128
	Intercambiador	NB	1 360129
	Bomba hidráulica	NB	1 360130
	Bomba vacío	NB	2 360131
	Termostato	NB	1 360132
	Tensor hidráulico	NB	1 360133
	Acople termostato	NB	1 360134
	Junta	NB	1 360135
	Cuerpo aceite	NB	1 360137
	Junta	NB	1 360138
	Junta	NB	1 360139
	Junta	NB	1 360140
0019971241	Retén cigüeñal	SNA	1 360158
	Arandela A 28 x 34 x 1.5 A	AL	4
	Arandela A 26 x 32 x 2 A	AL	2
	Arandela A 14 x 18 x 1.5 A	AL	1
	O'ring G 25.07 x 2.62	GS	1
	O'ring G 7.59 x 2.62	GS	1
	O'ring G 6.07 x 1.78	GS	2
	Kit de retenes completo		R360100
	Jgo. retén válvulas (8)	P	1 R360110P
0119972247	Retén distribución 45 x 74.5/79.5 x 12/14.5	P	1 R360112P

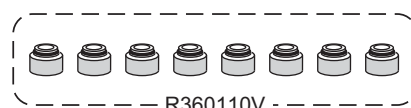
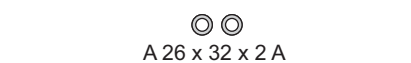
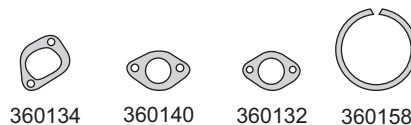
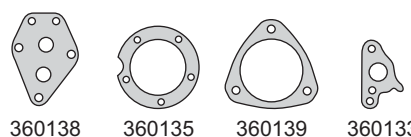
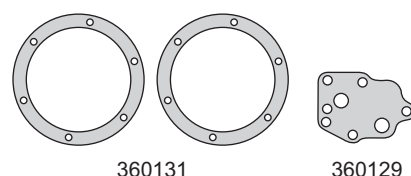
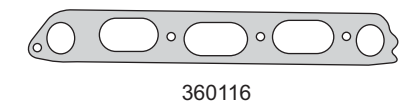
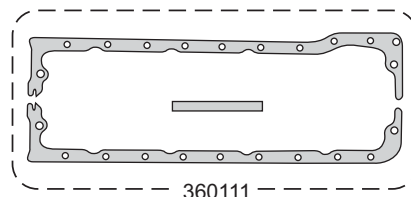
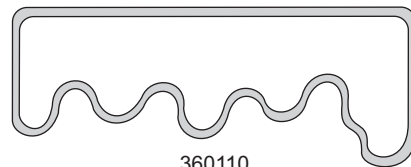
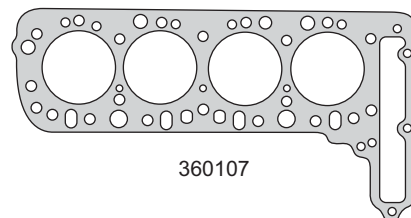

**MERCEDES  
BENZ**



Motor/Engine	Cm³	HP	Ø
OM 601.911/912	1997	72/75	87
OM 601.913	1997	72/75	87
OM 601.921 (SOHC) 8V	2197	72	87

Mercedes Benz: E200D, C200D, 200D/TD  
190D 1984/93

DIESEL



Nº OE	Descripción/Description	Mat.	Ref.
	<b>Jgo. de juntas para motor</b>		<b>360500-R</b>
	<b>Junta tapa cilindros Ø 88.0 ± 1.70</b>	NFT 1	<b>360507</b>
	<b>Jgo. tornillos tapa cilindros (HAN10055/10100)</b>		<b>B360500</b>
	Junta tapa de válvulas	GS 1	360510
	Junta para cárter	NB 1	360511
	Múltiple escape	GFT 1	360515
	Múltiple admisión	NFT 1	360517
	Soporte bomba de agua	NFT 1	351119
	Soporte bomba de agua	NH 1	351119-1
	Base soporte filtro de aceite	NH 1	351129
	Junta entrada agua a tapa cilindros	NH 1	351130
	Base depresora a distribución	NH 1	351131
	Guarnición tapón aceite	GS 1	351133
	Arandela A 12 x 15 x 1.5 A	AL 8	
	Arandela A 22 x 27 x 1.5 A	AL 3	
	Arandela A 27 x 32 x 2 A	AL 1	
	Arandela A 25 x 30 x 2 A	AL 1	
	Arandela A 10 x 13.8 x 1 A	AL 2	
	Arandela A 14 x 20 x 2 A	AL 1	
	Arandela A 18.5 x 22 x 1.5 A	AL 1	
	Arandela A 12 x 17 x 1.5 C	CU 1	
	Arandela A 14.5 x 20 x 1.5 C	CU 1	
	O´ring G 8 x 2	GS 1	
	O´ring G 17 x 4	GS 1	
	O´ring G 38 x 3	GS 1	
	O´ring G 75 x 3	GS 1	
	O´ring G 35 x 2	GS 1	
	Kit de retenes completo		R360500
	Jgo. retén válvulas (8)	V 1	R360510V
	Retén bancada 93 x 114 x 13	V 1	R351111V
	Retén distribución 45 x 67 x 8	V 1	R351112V

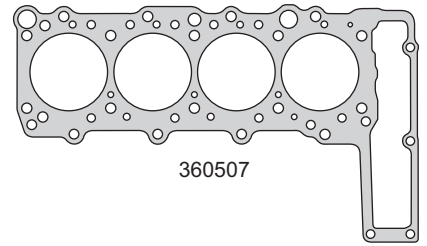

360507

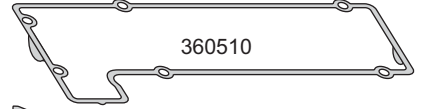

360510

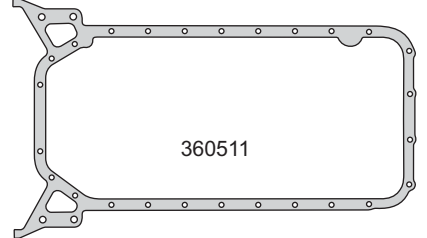

360511



360515



360517

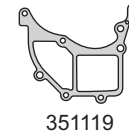

351119



351129

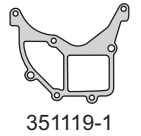

351119-1



351130

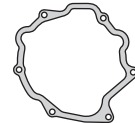

351131



351133



G 17 x 4

A 12 x 15 x 1.5 A

G 8 x 2



A 22 x 27 x 1.5 A



A 27 x 32 x 2 A



A 14 x 20 x 2 A



A 14.5 x 20 x 1.5 C



A 18.5 x 22 x 1.5 A



G 38 x 3



A 25 x 30 x 2 A



G 35 x 2



A 10 x 13.8 x 1 A



A 12 x 17 x 1.5 C

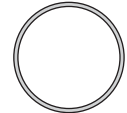

G 75 x 3



R351111V



R351112V

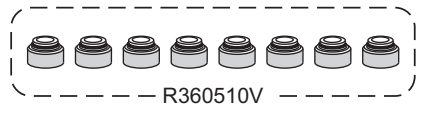

R360510V

# MERCEDES BENZ



Motor/Engine	Cm³	HP	Ø
MB271.946	1796	143	82
MB271.921	1796	122	82
MB271.940/941	1796	163	82
MB271.948 (DOHC) 16V	1796	192	82

Mercedes Benz: C180, C160, C200, CLK200 2002/..., E200 2003/..., C230, SLK200 2004/...

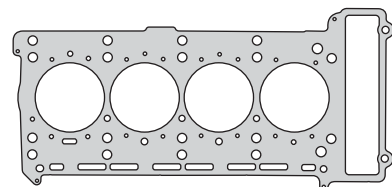

370108

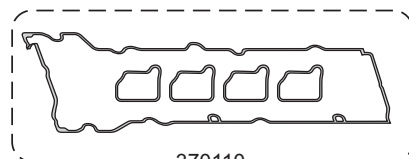

370110



370115

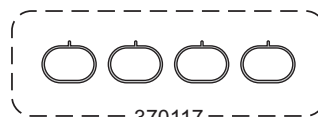

370117

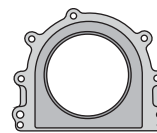

PR370110T

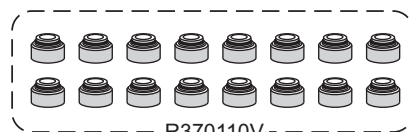

R370110V

Nº OE	Descripción/Description	Mat.	Ref.
	Jgo. de juntas para motor	●	370195MLS
	Junta tapa cilindros Ø 83.0 $\pm$ 0.90	MLS	1 370108
	Conj. junta tapa válvulas (5)	GS	1 370110
	Múltiple escape	AC	1 370115
	Jgo. múltiple admisión (4)	GS	1 370117
	Jgo. retén válvulas (16)	V	1 R370110V
	Porta reten bancada	T	PR370011T



# taranto

Para garantizar un trabajo óptimo, utilice el Kit de Herramientas Especiales HAK12-38, con su completa línea de puntas en todas la versiones aplicables para cada modelo de cabeza de ajuste.



## KIT HAK12-38

### Tubos Hexagonales

6 PT Socket



### Tubos Torx

Torx Socket



### Tubos Estriados

12 PT Socket



### Tubos con Punta Torx

Torx Socket Bit



### Tubos con Punta Ribe

Ribe Socket Bit



### Tubos con Punta Estriada

Torx Spline Socket Bit



### Tubos con Punta Hexagonal

Hex. Socket Bit



## Goniometro - Torquimetro Taranto.

Diseñado especialmente para facilitar el apriete de los tornillos de tapa de cilindros.

- ▶ HTORQ-110 - Herramienta Torquimetro 19-110NM
- ▶ HTORQ-210 - Herramienta Torquimetro 40-210NM
- ▶ HTORQ-350 - Herramienta Torquimetro 60-350NM
- ▶ HGONIOMETRO - Herramienta de Ajuste Angular - Goniometro
- ▶ HGONIOMETRO-M - Herramienta de Ajuste Angular - Goniometro Magnético





# MAXION / MWM / PERKINS

## JUNTA TAPA DE CILINDROS / HEAD GASKETS

### MOTORES NAFTA Y DIESEL / PETROL AND DIESEL ENGINES

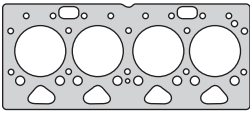
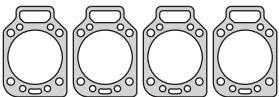
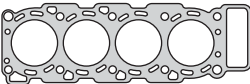
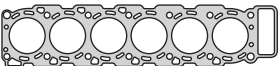
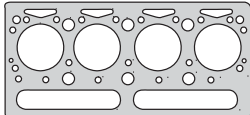
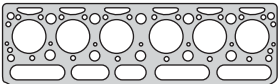
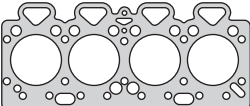
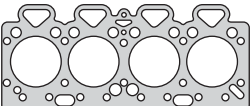
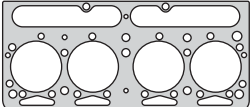
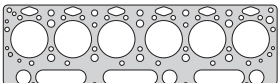
	Código Code	Q	≠	Kit Bulón Bolt Set	Aplicación Application	Motor Engine	Juego
	280307	105.0	1.80	B280300	GM D20/D40, Pick Up D20 <b>DIESEL</b>	3990cc. Maxion S4 102HP Ø100	280300-R pág. 71
	310407	110.0	1.45	B310400 HAS17038	F100 1993/95, F1000 1994/96 F4000 1992/93, F2000 1980/... FB4000 1985/..., Escavadora FB80 <b>DIESEL</b>	3922cc. D229-4 96HP Ø102	310400-R pág. 368
	330507 330507-1.7 330508	96.0 96.0 96.0	1.40 1.70 1.40	B330500 HAS17038	Agrale TD, Micro/Buses 2000/...  Blazer, S10 2000/... LT TDI Electronico 2002/06 <b>DIESEL</b>	2796cc. MWM 4.07 CA 131HP Ø93  2796cc. Sprint 4.07 TCA Commom Rail (SOHC) 12V 132HP Ø93	330500-R pág. 370  331100-R pág. 372
	330607 330607-1.7	96.0 96.0	1.40 1.70	B330600 HAS17038	GM Silverado 3500HD 1997/... Grand Blazer 1998/... F100 GMC Turbo 1999/... <b>DIESEL</b>	4200cc. OM 602.980/982/983 122/129HP Ø89 (SOHC) 18V	330600-R pág. 371
	400005 400007 400008	92.5 92.5 92.5	1.40 1.40 1.15	B400000 HAS19038	D100/D200 1987/... F100, Falcon 1970/...  F100 <b>DIESEL</b>	3336cc. 4.203-P4-192Z 71HP Ø91.49  3336cc. 4.203 Potenciado 71HP Ø91.44	400000-R pág. 373  410000-R pág. 376
	400307 400308	92.5 92.5	1.40 1.25	B400300 HAS19038	F100/F350/600 1974/... <b>DIESEL</b>	5004cc. 6PF - 305 102HP Ø91.44	400300-R pág. 374
	410605 410607	104.0 104.0	1.70 1.70		MF220, F290, Tractor MF85X  GM D10, F350, VW6.80, Case 550 GM D10/20/40 Aspirado Turbo <b>DIESEL</b>	4070cc. 4.248 70HP Ø101  3860cc. 4.236 70HP Ø98.4 Iny. Directa	410600-R pág. 377
	410605 410607	104.0 104.0	1.70 1.70		Vehicular GM D20 <b>DIESEL</b>	3860cc. Q20B4 70HP Ø98.4 Iny. Directa	401000-R pág. 375
	410807 410808	93.0 93.0	1.40 1.20		Pick Up, Camiónes livianos <b>DIESEL</b>	3330cc. T 4.33 Turbo 91/95HP Ø91.46 Iny. Directa	410800-R pág. 378
	410907	107.2	1.50		D60 - D70 BR <b>DIESEL</b>	5840cc. 6-357 Vehicular 120HP Ø104.14	410900-R pág. 379

# MAXION / MWM / PERKINS

## JUNTA TAPA DE CILINDROS / HEAD GASKETS

### MOTORES NAFTA Y DIESEL / PETROL AND DIESEL ENGINES

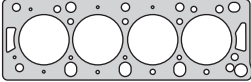
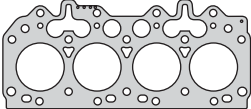
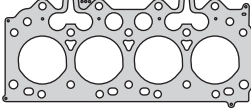
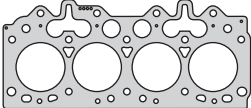
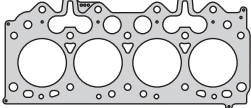
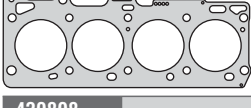
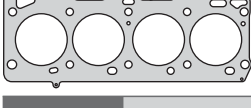
	Código Code	Q	≠	Kit Bulón Bolt Set	Aplicación Application	Motor Engine	Juego
	<b>420607</b>	86.0	1.50	<b>B420600</b> HAS15038	4.20 Marino D/TD 1986/.. <b>DIESEL</b>	<b>1994cc.</b> Prima 65/80T 58/80HP Ø84.5	<b>420600-R</b> pág. 380
	<b>430007</b>	92.0	1.40	<b>B430000</b> <b>B430000-1</b> HAS19038	Ranger TDI 1995/... Blazer TDI, S10TDI 1995/... <b>DIESEL</b>	<b>2507cc.</b> 95HP Ø90.7	<b>430001-R</b> pág. 365
	<b>430008</b>	92.0	1.20	<b>B430000</b> <b>B430000-1</b> HAS19038	Ranger TDI 1995/... Blazer TDI, S10TDI 1995/... <b>DIESEL</b>	<b>2507cc.</b> 95HP Ø90.7	<b>430001-R</b> pág. 366
	<b>430607</b>	94.0	1.40	<b>B430600</b> HAS19038	Ranger TD BR 2000-2002/... <b>DIESEL</b>	<b>2758cc.</b> Power Stroke 135HP Ø93	<b>430001-R</b> (430600) pág. 366
	<b>430608</b>	96.0	1.20	<b>B430600</b> HAS19038	Ranger TD BR 2000-2002/... <b>DIESEL</b>	<b>2758cc.</b> Power Stroke 135HP Ø93	<b>430001-R</b> (430600) pág. 366
	<b>430807</b>	98.0	1.30	<b>B430800</b> HAT60055 HAT60100	Ranger 3.0l, 4 x 4, Full BR Intercooler 2005/8 <b>DIESEL</b>	<b>2798cc.</b> NGD 3.0 E 163HP Ø96 (SOHC) 16V	<b>430801-R</b> pág. 367
	<b>430808</b>	98.0	1.30	<b>B430800</b> HAT60055 HAT60100	Ranger 3.0l, 4 x 4, Full BR Intercooler 2005/8 <b>DIESEL</b>	<b>2798cc.</b> NGD 3.0 E 163HP Ø96 (SOHC) 16V	<b>430801-R</b> pág. 367

# INTERNATIONAL MAXION-ROVER



Motor/Engine	Cm³	HP	Ø
200-300 TDI	2495 2507	95/112 95	90.5 90.7

**Ford:** Ranger TDI 1995/...  
**Chevrolet:** Blazer TDI, S10TDI 1995/...  
**Mercedes Benz:** Sprinter TDI 1997/...  
**Rover:** Range Rover, Discovery Defender TDI 1990/...



DIESEL

Nº OE	Descripción/Description	Mat.	Ref.
	Jgo. de juntas para motor		430001-R
	Jgo. de juntas superior		430095-1M
	Jgo. de juntas superior		430095-2M
	Jgo. de juntas superior		430095-3M
	Jgo. de juntas superior (MLS)		430095-1M MLS
	Jgo. de juntas superior (MLS)		430095-2M MLS
	Jgo. de juntas superior (MLS)		430095-3M MLS
	Jgo. juntas superior sin JTC		430096
ERR 5261	Junta tapa cilindros Ø 92.0 $\pm$ 1.40 NR	NFT 1	430007-1M
ERR 5262	Junta tapa cilindros Ø 92.0 $\pm$ 1.50 NR	NFT	430007-2M
ERR 5263	Junta tapa cilindros Ø 92.0 $\pm$ 1.60 NR	NFT	430007-3M
	Junta tapa cilindros Ø 92.0 $\pm$ 1.70 NR	NFT	430007-4M
ERR 5261	Junta tapa cilindros Ø 92.0 $\pm$ 1.20 NR	MLS	430008-1M
ERR 5262	Junta tapa cilindros Ø 92.0 $\pm$ 1.30 NR	MLS	430008-2M
ERR 5263	Junta tapa cilindros Ø 92.0 $\pm$ 1.40 NR	MLS	430008-3M
	Jgo. tornillos tapa cilindros (HAS19038)		B430000
	Jgo. tornillos tapa cilindros (HAS19038)		B430000-1
ERR 2409	Conj. junta tapa válvulas (4)	N 1	430010
	Junta para cárter	NB 1	430011
ERR 4120	Tapa distribución	CB 1	430012
ERR 4860	Placa distribución	NB 1	430013
	Placa distribución	NB 1	430613
ERR 3284	Bomba de agua	NB 1	430014
ERR 3785	Múltiple admisión y escape	NFT 1	430015
	Placa bomba de agua	NB 1	430019
ERR 2028	Bomba combustible	NB 1	430028
	Arandela tapa válvulas	AC/GS 3	430030
	Junta base filtro	NB 1	430630
	Porta retén trasero	NB 1	430034
ERR 3283	Filtro aceite	NB 1	430037
	Arandela pico inyector	CU 4	330337
ERR 2023	Frente bomba inyectora	CB 1	430038
ERR 1561	Inspección frente distribución	CB 1	430039
ERR 2027	Bomba vacío	NB 1	430040
ERR 2027/1	Bomba vacío	NB 1	430041
ERR 1653	Caño aceite	NB 2	430042
	Arandela A 9 x 18 x 0.8	CB 3	430043
ERR 3490	Termostato carcasa	NB 1	430044
	Entre múltiple turbo	AC 1	500546
	Jgo. empaquetadura bancada cigüeñal (2)	GS 1	430058
ERR 2344	Arandela A 9.4 x 18 x 1F	F 1	
	Arandela A 12 x 17 x 1.5 C	CU 6	
	Arandela A 14 x 20 x 1.5 A	AL 4	
	Arandela A 19 x 27 x 1.5 A	AL 1	
	Arandela A 6 x 10 x 1 C	CU 8	
	O´ring G 23 x 3	GS 2	
ERR4710	O´ring G 37.47 x 3	GS 1	
	O´ring G 67 x 74 x 3	GS 1	
	Kit de retenes completo		R430000
	Jgo. retén válvulas (8)	V 1	R430010V
ERR4179	Porta retén bancada	VF	PR430011VF
ERR4575	Retén distribución 57 x 71 x 9	V 1	R430012V
ERR3956	Retén árbol de levas 46.7 x 62 x 9	V 1	R430013V
ERR4576	Retén guardapolvo correa distr. 57.5 x 74 x 8	N	R430015N

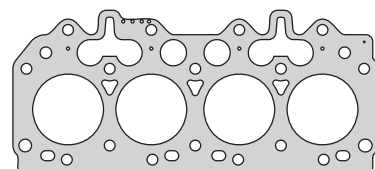

430007

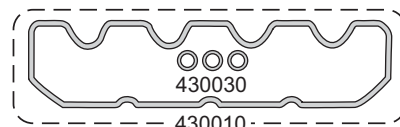

430030

430010

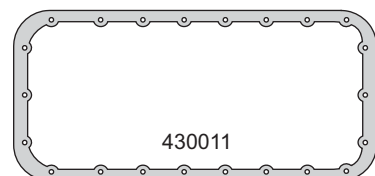

430011

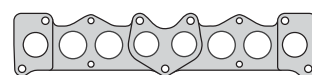

430015

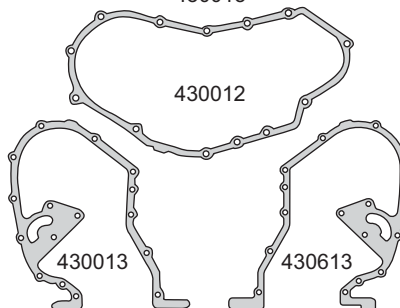

430012



430013

430613



430019

430014

430028

430630

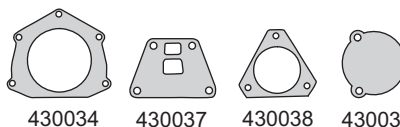

430034

430037

430038

430039

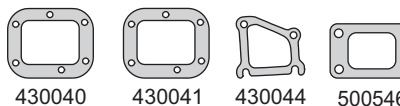

430040

430041

430044

500546



330337

430042

430058

G 23 x 3



A 14 x 20 x 1.5 A

A 12 x 17 x 1.5 C



G 67 x 74 x 3

A 9 x 18 x 0.8

A 9.4 x 18 x 1 F



G 37.47 x 3

A 6 x 10 x 1 C

A 19 x 27 x 1.5 A



PR430011VF R430012V R430013V



R430010V

**INTERNATIONAL  
MAXION-ROVER**



Motor/Engine	Cm³	HP	Ø
Power Stroke	2758	135	93
<b>DIESEL</b>			

Ford: Ranger TD BR 2000-2002/....



Nº OE	Descripción/Description	Mat.		Ref.
	Jgo. de juntas para motor			430001-R
	Jgo. de juntas superior (MLS)		●	430695-1M MLS
	Jgo. de juntas superior (MLS)			430695-2M MLS
	Jgo. de juntas superior (MLS)			430695-3M MLS
	Jgo. juntas superior sin JTC			430096
70490296	Junta tapa cilindros Ø 94.0 $\times$ 1.40	NFT		430607-1M
70490297	Junta tapa cilindros Ø 94.0 $\times$ 1.50	NFT		430607-2M
70490298	Junta tapa cilindros Ø 94.0 $\times$ 1.60	NFT		430607-3M
70490299	Junta tapa cilindros Ø 94.0 $\times$ 1.70	NFT		430607-4M
70490296	Junta tapa cilindros Ø 94.0 $\times$ 1.20	MLS	1	430608-1M
70490297	Junta tapa cilindros Ø 94.0 $\times$ 1.30	MLS		430608-2M
70490298	Junta tapa cilindros Ø 94.0 $\times$ 1.40	MLS		430608-3M
	Jgo. tornillos tapa cilindros (HAS19038)			B430600
ERR 2409	Conj. junta tapa válvulas (4)	N	1 1	430010
	Junta para cárter	NB		430011
ERR 4120	Tapa distribución	CB		430012
ERR 4860	Placa distribución	NB		430013
	Placa distribución	NB		430613
ERR 3284	Bomba de agua	NB		430014
ERR 3785	Múltiple admisión y escape	NFT	1 1	430015
	Placa bomba de agua	NB		430019
ERR 2028	Bomba combustible	NB		430028
	Arandela tapa válvulas	AC/GS	3 3	430030
	Junta base filtro	NB		430630
	Porta retén trasero	NB		430034
ERR 3283	Filtro aceite	NB		430037
	Arandela pico inyector	CU		330337
ERR 2023	Frente bomba inyectora	CB		430038
ERR 1561	Inspección frente distribución	CB		430039
ERR 2027	Bomba vacio	NB	1 1	430040
ERR 2027/1	Bomba vacio	NB	1 1	430041
ERR 1653	Caño aceite	NB	2	430042
	Arandela A 9 x 18 x 0.8	CB	3	430043
ERR 3490	Termostato carcaza	NB	1 1	430044
	Salida escape turbo	AC	1 1	500546
	Jgo. empaquetadura bancada cigüeñal (2)	GS		430058
ERR 2344	Arandela A 9.4 x 18 x 1F	F		1
	Arandela A 12 x 17 x 1.5 C	CU		6
	Arandela A 14 x 20 x 1.5 A	AL	4	4
	Arandela A 19 x 27 x 1.5 A	AL		1
	Arandela A 6 x 10 x 1 C	CU		8
	O´ring G 23 x 3	GS	2	2
	O´ring G 37.47 x 3	GS		1
	O´ring G 67 x 74 x 3	GS		1
	Kit de retenes completo			R430000
	Jgo. retén válvulas (8)	V	1	R430010V
ERR4179	Porta retén bancada	VF		PR430011VF
ERR4575	Retén distribución 57 x 71 x 9	V	1	R430012V
ERR3956	Retén árbol de levas 46.7 x 62 x 9	V	1	R430013V
ERR4576	Ret. guardapolvo correa distr. 57.5 x 74 x 8	N		R430015N

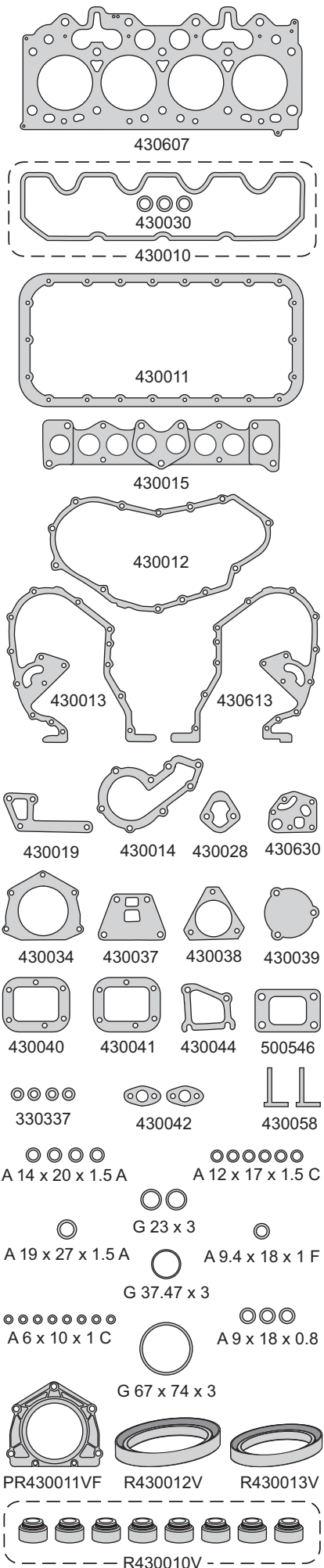

# INTERNATIONAL MAXION



Motor/Engine	Cm³	HP	Ø
NGD 3.0E (SOHC) 16V	2798	163	96

Ford: Ranger 3.0I - 4 x 4  
Full BR Intercooler



DIESEL

Nº OE	Descripción/Description	Mat.	Ref.
7073000/418	Jgo. de juntas para motor		430801-R
	Jgo. de juntas superior (MLS)	●	430895-1M MLS
	Jgo. de juntas superior (MLS)		430895-2M MLS
	Jgo. de juntas superior (MLS)		430895-3M MLS
	Jgo. de juntas superior (MLS)		430895-4M MLS
	Jgo. juntas superior sin JTC		430896
	Junta tapa cilindros Ø 98.0 $\pm$ 1.30 NR	NFT	430807-1M
	Junta tapa cilindros Ø 98.0 $\pm$ 1.40 NR	NFT	430807-2M
	Junta tapa cilindros Ø 98.0 $\pm$ 1.50 NR	NFT	430807-3M
	Junta tapa cilindros Ø 98.0 $\pm$ 1.60 NR	NFT	430807-4M
70490793	Junta tapa cilindros Ø 98.0 $\pm$ 1.30 NR	MLS 1	430808-1M
70490792	Junta tapa cilindros Ø 98.0 $\pm$ 1.40 NR	MLS	430808-2M
70490791	Junta tapa cilindros Ø 98.0 $\pm$ 1.50 NR	MLS	430808-3M
70490815	Junta tapa cilindros Ø 98.0 $\pm$ 1.60 NR	MLS	430808-4M
70740783	Jgo. tornillos tapa cilin. (HAT60055/60100)		B430800
70490701	Jgo. junta tapa válvulas (5)	GS 1	430810
70490859	Jgo. junta tapa válvulas (5)	GS 1	430910
	Junta para cárter	NB 1	430011
70490824	Tapa distribución	NB 1	430812
70490823	Placa distribución a block	S 1	430813
70490785	Jgo. múltiple escape (4)	AC 1	430815
70490786	Jgo. múltiple admisión (4)	SLS 1	430817
70490690	Junta enfriado en aceite	NH	430827
70490700	Adaptador inyectores	GS 4	430831
70490709	Guarnición tubo succión aceite	GS 1	430832
70490704	Guarnición conexión entrada agua	GS 1	430833
70490692	Junta brida levantamiento delantero	NB	430834
70730061	Anillo con injerto metálico A 27 x 18 x 6.8	ACGS	430836
	Junta	NB 1	430837
70490708	Entrada agua a block	GS 1	430838
70590021	Anillo cierre tapa inyectora distribución	GS 1	430839
	Guarnición cierre	GS 1	430840
	Guarnición cierre 68 x 62 x 2.5	GS	430841
70490814	Bomba inyectora	GS 1	430842
	Junta cañería agua	NB 1	430843
BF9T1036A	Arandela pico inyector A 7.5 x 15 x 2 C	CU 4	4
70680019	O´ring camisa inyector G 21.95 x 1.78	GS 4	4
70680020	O´ring G 10 x 2	GS	1
70590015	O´ring G 43 x 4	GS	1
	O´ring G 37.47 x 3	GS	1
	Arandela A 6 x 17 x 1 F	F	1
	Kit de retenes completo		R430800
70730060	Jgo. retén válvulas (16)	V 1	R430810V
70730043	Porta retén bancada	VF	PR430011VF
70730016	Retén distribución 60.32 x 79.36 x 9.5	V 1	R400012V

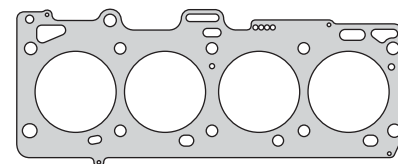

430808

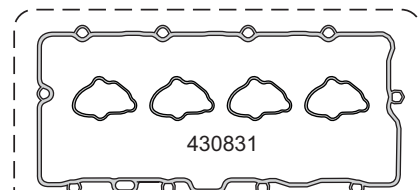

430831



430810

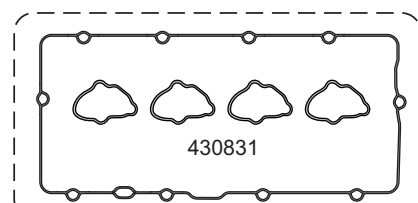

430831



430910

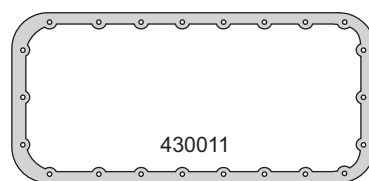

430011

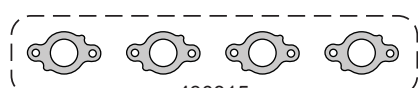

430815

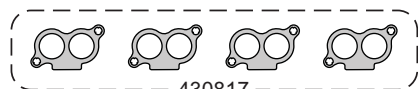

430817

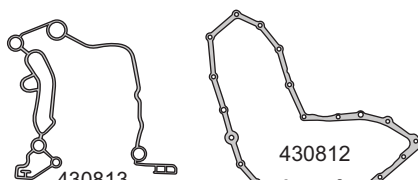

430813

430812



430832

430833

430834

430838

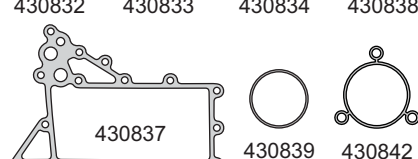

430837

430839

430842

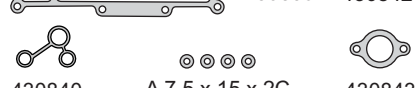

430840

A 7.5 x 15 x 2C

430843

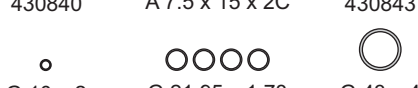

G 10 x 2

G 21.95 x 1.78

G 43 x 4

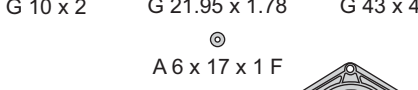

A 6 x 17 x 1 F



R400012V

PR430011VF

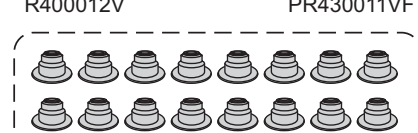

R430810V

MWM



Motor/Engine	Cm³	HP	Ø
D229-4 (SOHC) 8V	3922	96	102
<b>DIESEL</b>			

**Ford:** F100 1993/95, F1000 1994/96  
F4000 1992/93, F2000 1980/...  
FB4000 1985/...  
**Fiat:** Excavadora FB80



Nº OE	Descripción/Description	Mat.	1	2	Ref.
922900013005/87	Jgo. de juntas para motor				310400-R
	Jgo. de juntas superior		●	●	310495
622708541044	Jta. tapa cilindros Ø110.0 ± 1.45 NR3	NFT	4	4	310407
	Jgo. tornillos tapa cilindros (HAS17038)				B310400
920808530014	Junta tapa válvulas	N	4	4	310410
630508530164	Jgo. junta para cárter (4)	NB		1	310411
632508530184	Tapa distribución	NB		1	310412
632508530154	Distribución bomba aceite	NB		1	310413
922208530134	Tapa bomba de agua	NB		2	310414
632138530094	Jgo. múltiple escape y admisión (8)	NFT	1	1	310416
	Salida de escape 58 x 71 x 11	NFT	1	1	310418
620808530014	Placa bomba de agua	NB		1	310419
62290853052	Bomba alimentación	NB		1	220128
	Base bomba nafta	NB		1	550628
	Junta	NB		1	310430
	Junta	NB		1	310435
	Junta	NB		1	310434
922408530575	Base bomba inyección	NB		1	400435
930508530214	Base filtro aceite	NB		1	310437
632508530054	Tapa trasera bancada	NB		1	310438
604931060443	O'ring G 30.8 x 3.7	GS		1	310439
604931000202	O'ring G 20 x 2	GS	4	4	310440
604931000324	O'ring G 6 x 2	GS		1	310441
90411025515	Acople escape	NB	1	1	310541
632148530124	Bombin bomba inyectora	NB		1	310442
620508530124	Base bomba inyectora lineal	NB		1	310443
604931060204	O'ring G 42 x 3	GS		2	310444
922508510014	Curva escape	NFT	1	1	310445
630508530154	Acople con escape	NFT	1	1	310446
630508530164	Complemento cárter	NB		2	310447
632488510144	Fijación filtro aire	NB		1	310448
922508510044	Tapa inspección	NB		1	310449
	Caja velocidades F100/1000/clark 5V	VS			310450
604931040062	O'ring G 20 x 4	GS		1	310451
604931000344	O'ring G 45 x 3	GS		1	310452
	Palier F4000	CB			310456
	Diferencial DANA 46 F100-45/97- 96/98	NH			310459
	Tubo ventilación	AC		1	350462
	Colector a escape a turbo	NB		1	350662
	Junta caract. turabo MWM D229	AC		1	310463
6049313041124	Junta suplemento camisa cilindros G110 x 4	V		8	310470
904920101014	Arandela A 8 x 11 x 1 A	AL			
904920100814	Arandela A 8 x 12 x 1 A	AL			
904921101014	Arandela A 10 x 14 x 1.5 A	AL		4	
904920101418	Arandela A 14 x 18 x 1.5 A	AL		16	
604921100811	Arandela A 8 x 14 x 1 A	AL		3	
904921101018	Arandela A 10 x 16 x 1 A	AL			
	Arandela A 20 x 26 x 1 C	CU		1	
604920600211	Arandela tapón cárter A 22 x 27 x 1 A	AL		1	
606901281017	Arandela A 10 x 20 x 2 C	CU		4	
	Arandela A 40 x 60 x 1.5	NB		1	
	Arandela A 12 x 18 x 1.5 A	AL		2	
	Arandela A 14 x 20 x 1.5 A	AL		2	

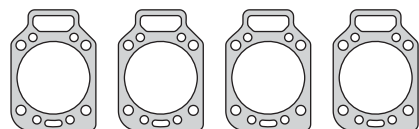

310407



310410

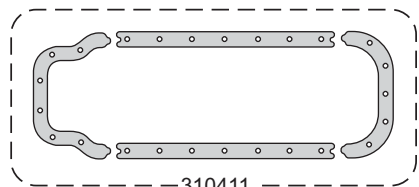

310411

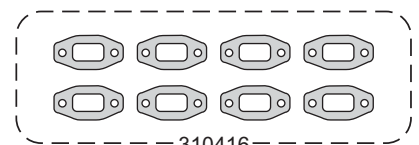

310416

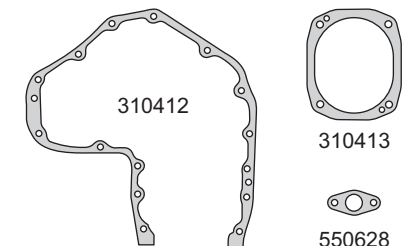

310412

310413

550628

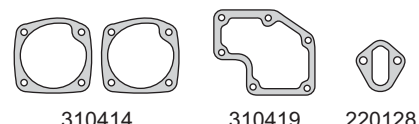

310414

310419

220128

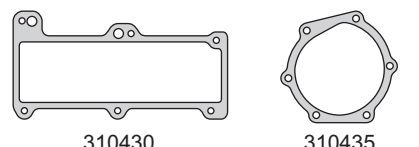

310430

310435



310437

310434

400435

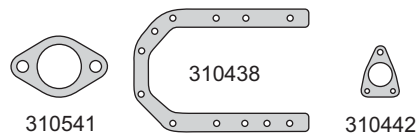

310438

310541

310442

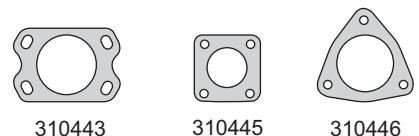

310443

310445

310446

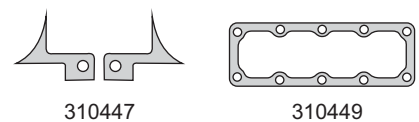

310447

310449

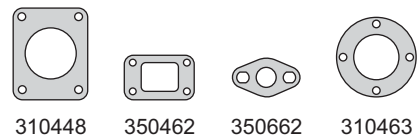

310448

350462

350662

310463



**MWM**



Motor/Engine	Cm³	HP	Ø
MWM 4.07CA	2796	131	93
Sprint 4.07CA	2796	125/132	93
AGK/ATA	2796	125/131	93
BCQ (SOHC) 12V	2796	158	93

**Chevrolet:** S10 TD, Blazer TD 2000/...  
**Nissan:** Frontier, X Terra 2003/6  
**MWM:** Agrale TD (Micro/Omnibus) 2000/...  
**Volkswagen:** LT TDI 1997/...  
 Electrónico 2003/06



**DIESEL**

Nº OE	Descripción/Description	Mat.	Ref.
	Jgo. de juntas para motor		330500-R
	Jgo. de juntas superior		330595
11044-880A	Junta tapa cilindros Ø 96.0 ±1.40	NFT 1 1	330507
	Junta tapa cilindros Ø 96.0 ±1.70	NFT	330507-1.7
	Junta tapa cilindros Ø 96.0 ±1.40	MLS	330508
	Jgo. tornillos tapa cilindros (HAS17038)		B330500
	Conj. junta tapa válvulas (6)	N 1 1	330510
	Junta para cárter	NB 1	330511
	Tapa distribución	NB 1	330512
0853-0/184	Junta bomba aceite frente motor	NB 1	330513
	Múltiple escape	NFT 4 4	330515
	Múltiple admisión	NB 1 1	330517
	Termostato	NB 1	330519
	Guarnición goma	GS 1 1	870232
	Junta radiador aceite	NB 1	330534
	Junta refrigerador aceite	NB 1	330535
	Radiador aceite	NFT 1	330536
	Tapa radiador aceite	NB 1	330537
	Guarnición goma inyectores	GS 4 4	330539
	Guarnición goma	GS 5 5	330540
	Junta entrada aceite turbo	NB 1	331141
	Junta salida aceite turbo	NB 1	331142
	Bomba inyectora	NB 1	400146
	O'ring G 105.46 x 3.53	GS 1	
	O'ring G 82.22 x 2.62	GS 1 1	
	O'ring G 76 x 2.5	GS 1 1	
	O'ring G 66.27 x 3.53	GS 1 1	
	O'ring G 44.12 x 2.62	GS 2 2	
	O'ring G 45 x 2.5	GS 1 1	
	O'ring G 40.87 x 3.53	GS 1 1	
	O'ring G 32.92 x 3.53	GS 1 1	
	O'ring G 20 x 2	GS 1 1	
	Arandelas A 21 x 30.5 x 2 A	AL 2	
	Arandelas A 20 x 24.5 x 1.5 A	AL 2	
	Arandelas A 18 x 22 x 1.5 A	AL 2	
	Arandelas A 16 x 20 x 1 A	AL 5	
	Arandelas A 14 x 18 x 1.5 A	AL 5	
	Arandelas A 14 x 18 x 1.5 C	CU 2	
	Arandelas A 12 x 18 x 1.5 A	AL 5	
	Arandelas A 7 x 15 x 2 C	CU 4 4	
	Arandelas A 10 x 14 x 1 A	AL 5	
	Arandelas A 8 x 12 x 1 C	CU 29	
	Arandelas A 6 x 10 x 1 C	CU 13	
	Kit de retenes completo		R330500
	Jgo. retén válvulas (12)	V 1	R330510V
	Retén bancada 91 x 111 x 10	V 1	R330511V
	Retén distribución 64 x 80 x 8	V 1	R250811V

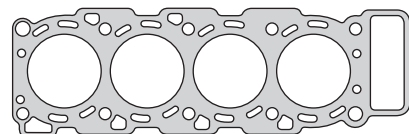

330507

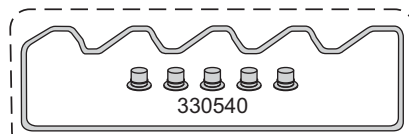

330540

330510

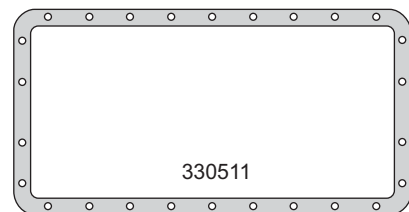

330511



330517



330515



330519

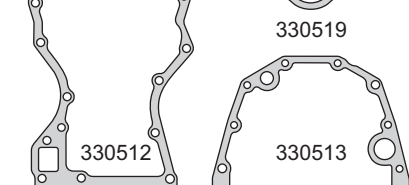

330512

330513

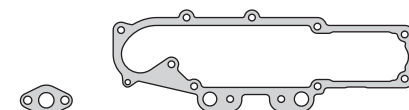

330535

330534

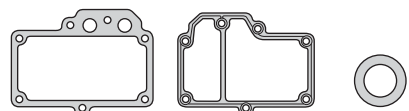

330537

330536

870232



400146

330539

331142

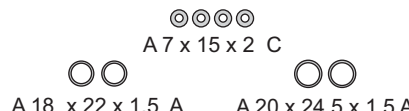

A 7 x 15 x 2 C

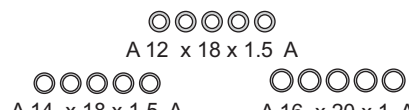

A 18 x 22 x 1.5 A

A 20 x 24.5 x 1.5 A

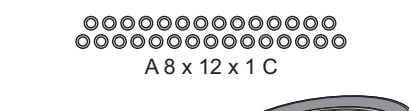

A 12 x 18 x 1.5 A



A 14 x 18 x 1.5 A

A 16 x 20 x 1 A

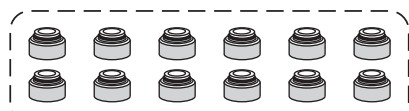

R250811V

R330511V

R330510V



**MWM**



Motor/Engine	Cm³	HP	Ø
<b>Sprint 6.07 TD Turbo Intercooler (SOHC) 18V</b>	<b>4200</b>	<b>167/198</b>	<b>93</b>

**Ford:** F100 GMC Turbo 1999/...  
**Chevrolet:** GM Silverado 3500HD 1997/...  
 GM Gran Blazer 1998/...



**DIESEL**

Nº OE	Descripción/Description	Mat.	Ref.
	Jgo. de juntas para motor		330600-R
	Jgo. de juntas superior		330695
	Junta tapa cilindros Ø 96.0 ± 1.40	NFT 1	330607
	Junta tapa cilindros Ø 96.0 ± 1.70	NFT	330607-1.7
	Jgo. tornillos tapa cilindros (HAS17038)		B330600
	Jgo. junta tapa válvulas (8)	N 1	330610
	Junta para cárter	NB 1	330611
	Tapa distribución	NB 1	330512
0853-0/184	Junta aceite bomba frente motor	NH 1	330513
	Múltiple escape	NFT 6	330515
	Múltiple admisión y escape	CG 1	330617
	Base termostato	NB 1	330619
	Base termostato	NB 1	330629
	Retorno	NB 1	330630
	Guarnición goma	GS 1	870232
	Radiador aceite	NFT 1	330536
	Radiador aceite	NB 1	330537
	Guarnición termostato	GS 2	330638
	Guarnición goma inyectores	GS 6	330539
	Guarnición goma	GS 7	330540
	Junta entrada aceite turbo	NB 1	331141
	Junta salida aceite turbo	NB 1	331142
	Bomba inyectora	NB 1	400146
	O´ring G 105.46 x 3.53	GS 1	
	O´ring G 102.99 x 3.2	GS 1	
	O´ring G 82.14 x 3.53	GS 1	
	O´ring G 79.5 x 3	GS 1	
	O´ring G 66.27 x 3.53	GS 1	
	O´ring G 44.12 x 2.62	GS 1	
	O´ring G 40 x 5	GS 2	
	O´ring G 40.87 x 3.53	GS 1	
	O´ring G 31.42 x 2.62	GS 1	
	O´ring G 31.55 x 3.72	GS 1	
	O´ring G 28.17 x 3.53	GS 1	
	O´ring G 21.89 x 2.62	GS 1	
	O´ring G 13.94 x 2.62	GS 2	
	Arandela A 21 x 30.5 x 2 A	AL 1	
	Arandela A 20 x 24 x 1.5 A	AL 4	
	Arandela A 18 x 22 x 1.5 A	AL 5	
	Arandela A 16 x 20 x 1 A	AL 3	
	Arandela A 14 x 18 x 1.5 A	AL 8	
	Arandela A 12 x 18 x 1.5 A	AL 6	
	Arandela A 7 x 15 x 2 C	CU 6	
	Arandela A 10 x 14 x 1 A	AL 4	
	Arandela A 8 x 14 x 1 A	AL 2	
	Arandela A 8 x 12 x 1 A	AL 5	
	Arandela A 8 x 12 x 1 C	CU 41	
	Arandela A 6 x 10 x 1 C	CU 18	
	Kit de retenes completo		R330600
	Jgo. retén válvulas (18)	V 1	R330610V
	Retén distribución 64 x 80 x 8	V 1	R250811V
	Retén bancada 91 x 111 x 10	V 1	R330511V

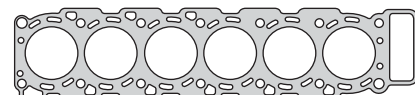

330607

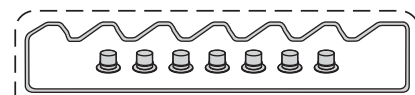

330540  
330610

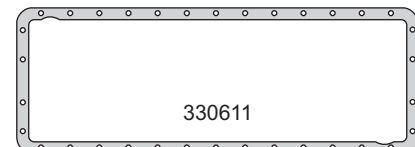

330611



330610

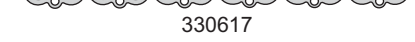

330617



330515



330619



330619



330512



330513



330629



330537



330536



330630



330539



870232

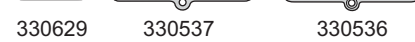

331141



331142



400146



A 7 x 15 x 2 C



A 18 x 22 x 1.5 A



A 20 x 24 x 1.5 A

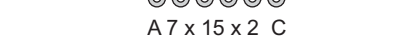

A 8 x 12 x 1 C



A 12 x 18 x 1.5 A



A 16 x 20 x 1 A



A 14 x 18 x 1.5 A

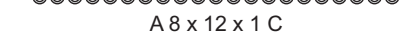

A 10 x 14 x 1 A



A 8 x 12 x 1 A



A 6 x 10 x 1 C



A 8 x 14 x 1 A



A 21 x 30.5 x 2 A

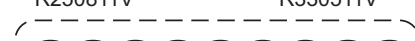
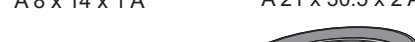
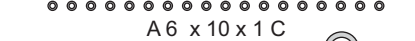

MWM



Motor/Engine	Cm³	HP	Ø
Sprint 4.07 TCA	2796	132	93
VW28TI	2796	132	93
BCQ (SOHC) 12V	2796	158	93

**Chevrolet:** Blazer, S10 2000/...  
**Nissan:** Frontier, X Terra Electrónico 2007/...  
**Volkswagen:** LT TDI Electrónico 2002/06  
 Common Rail



DIESEL

Nº OE	Descripción/Description	Mat.	Ref.
101012DB-OA	Jgo. de juntas para motor		331100-R MLS
	Jgo. de juntas superior (MLS)		331195 MLS
11044-880A	Junta tapa cilindros Ø 96.0 ± 1.40 NR	NFT	330507
	Junta tapa cilindros Ø 96.0 ± 1.70 NR	NFT	330507-1.70
110442	Junta tapa cilindros Ø 96.0 ± 1.40 NR	MLS	330508
1103565313	Jgo. tornillos tapa cilindros (HAS17038)		B330500
132706530	Junta tapa válvulas	GS	330510
111405300	Junta para cárter	NB	331111
94078853018	Frente motor	NB	330512
44070853115	Junta bomba aceite frente motor	NH	330513
35308401	Jgo. múltiple escape (4)	GFT	331115
2130465310	Múltiple admisión	NB	330517
206915700	Salida de escape	AC	331118
206925300	Junta acople caño escape	AC	331136
	Junta radiador aceite	NB	330537
	Guarnición llenado aceite	GS	870232
	Guarnición goma inyectores	GS	330539
21014-6N210	Guarnición goma	GS	330540
1519665300	Junta entrada aceite turbo	NB	331141
1518665300	Junta salida aceite turbo	NB	331142
	O'ring G 105.46 x 3.53	GS	331136
	O'ring G 94.84 x 3.53	GS	330537
	O'ring G 88.49 x 3.53	GS	870232
	O'ring G 85.32 x 3.53	GS	330539
	O'ring G 82.22 x 2.62	GS	331141
	O'ring G 72.62 x 3.53	GS	331142
	O'ring G 66.27 x 3.53	GS	331118
	O'ring G 62.87 x 5.33	GS	
	O'ring árbol de levas G 60.6 x 3.53	GS	1 1
	O'ring G 59.92 x 3.53	GS	1
	O'ring termostato G 54.5 x 3.53	GS	1
	O'ring G 45 x 2.5	GS	1
	O'ring G 44.12 x 2.62	GS	2
	O'ring G 40.87 x 3.53	GS	1
	O'ring G 32.92 x 3.53	GS	1
	O'ring G 28.17 x 3.53	GS	1
	O'ring G 13.87 x 3.53	GS	4
	Arandelas A 21 x 30 x 2 A	AL	1
	Arandelas A 20 x 26 x 1 A	AL	3
	Arandelas A 20 x 26 x 1.5 C	CU	5
	Arandelas A 18 x 22 x 1.5 A	AL	2
	Arandelas A 17 x 20 x 1.5 C	CU	3
	Arandelas A 15 x 18 x 1 A	AL	4 4
	Arandelas A 12 x 18 x 1.5 A	AL	2
	Arandelas A 7.5 x 15 x 2 C	AL	4 4
	Arandelas A 8.5 x 12 x 1 C	CU	4 4
	Kit de retenes completo		R330500
	Jgo. retén válvulas (12)	V	1 R330510V
	Retén bancada 91 x 111 x 10	V	1 R330511V
	Retén distribución 64 x 80 x 8	V	1 R250811V

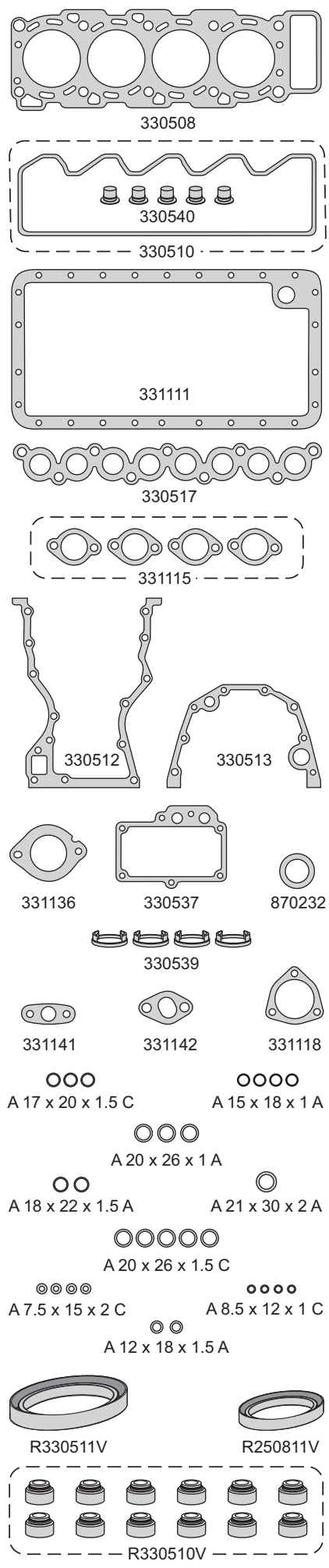

**PERKINS**



Motor/Engine	Cm³	HP	Ø
4.203-P4-192Z (OHV) 8V	3336	71	91.49

**Dodge:** D100, D200 1987/...  
**Ford:** F100, Falcon 1970/...

**DIESEL**



Nº OE	Descripción/Description	Mat.	Ref.
105379	Jgo. de juntas para motor		40000-R
	Jgo. de juntas superior		400095
	Jgo. de juntas superior		400095/7
	Junta tapa cilindros Ø92.5 ± 1.40		400005
36812125	Junta tapa cilindros Ø92.5 ± 1.40	NFT	400007
36812125	Junta tapa cilindros Ø92.5 ± 1.15	CNC	400008
	Jgo. tornillos tapa cilindros (HAS19038)		B400000
0490704	Conjunto junta tapa válvulas (4)	CG	1 1 400010
003248	Jgo. junta para cárter (4)	NB	1 400011
006072	Tapa distribución	NB	1 400012
36814112	Block caja distribución	NB	1 400013
36866417	Bomba de agua placa trasera	NB	1 400014
006002	Jgo. múltiple escape (2)	FCH	1 1 400015
006061	Múltiple admisión	NFT	1 1 400017
0490032	Salida de escape	FCH	1 1 400018
	Arandela tapa válvulas	GS	3 3 400130
	Arandela base inyector A 14 x 20 x 1.5 C	CU	400033
33825409	Tapa frontal a tapa inspección	NB	1 400034
066081	Tapa trasera cigüeñal	NB	1 400035
0490485	Tapa trasera tapa cilindro	NB	1 1 400036
0066054	Tapa precámara combustible	CU	4 4 400037
006054	Precámara combustión	AL	410037
33826111	Porta retén bancada trasera	NB	1 400038
36866416	Caja distribución bomba vacío	NB	1 400039
0490867	Tapa trasera termoarranque	CG	1 400140
36853105	Caja distribución tapa toma fuerza	NB	1 400045
0490685	Comando bomba combustible	NB	1 400146
0490699	Tapa trasera árbol levas	NB	1 400047
0490692	Conexión entrada agua	NB	1 400048
36835411	Conexión salida agua	NB	1 1 400051
0490024	Salida agua a tapa	NB	1 1 400052
0490391	Cuerpo codo paso agua	NB	1 400153
006007	Filtro aceite a block	NB	1 400057
36883106	Jgo. juntas bancada cigüeñal (2)	SLA	1 400158
	Junta base depresor	NB	1 400059
36866428	Bomba vacío tapa brida	NB	1 400062
006074	Bomba alimentación combustible	NB	1 400165
36865543	Soporte bomba inyectora	NB	1 400066
	Kit arandelas (57)	VS	1 400075
	Arandela A 10 x 14 x 1 A	AL	15
	Arandela A 13 x 20 x 1 A	AL	10
	Arandela A 17.5 x 22 x 1 A	AL	10
	Arandela A 19 x 27 x 2 A	AL	1
	Arandela A 8 x 12.5 x 1 A	AL	15
	Arandela A 14.5 x 20.5 x 1.5 C	CU	6
	Kit de retenes completo 4.203 hasta 1987		R400000
	Kit de retenes completo 4.203 1988/...		R400000-1
	Jgo. retén válvulas (8)	P	1 R300310P
	Jgo. retén válvulas (8)	P	1 R400010P
	Retén bancada 133.35 x 158.75 x 11/13	P	1 R400211P
	Retén distribución 60.32 x 79.36 x 9.5	P	1 R400012P

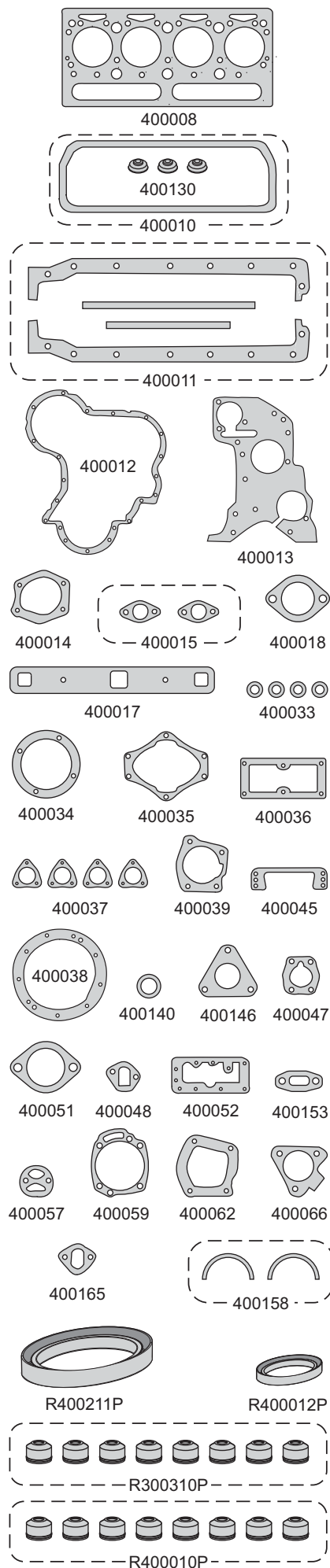

**PERKINS**



Motor/Engine	Cm³	HP	Ø
6PF - 305 (SOHC) 12V	5004	102	91.44
DIESEL			

Ford: F100, F350, F600 1974/...



Nº OE	Descripción/Description	Mat.	Ref.
105388	Jgo. de juntas para motor		400300-R
	Jgo. de juntas superior		400395
	Jgo. de juntas superior		400395/7
006063	Jta. tapa cilindros Ø 92.5 ± 1.40	NFT	400307
006063	Jta. tapa cilindros Ø 92.5 ± 1.25	FCH 1 1	400308
	Jgo. tornillos tapa cilindros (HAS19038)		B400300
0490760	Conj. junta tapa válvulas (4)	CG 1 1	400110
006000	Jgo. junta para cárter (4)	NB 1	400311
006072	Caja distribución tapa frontal	NB 1	400012
36814112	Block caja distribución	NB 1	400013
36866417	Bomba agua placa trasera	NB 1	400014
006002	Múltiple escape	FCH 3 3	400015
0490026	Jgo. múltiple admisión (2)	NFT 1 1	400117
0490032	Salida de escape	FCH 1 1	400018
	Arandela tapa válvulas (4)	GS 4 4	400130
0920113	Arandela base inyector A 14 x 20 x 1.25 C	CU 6	400033
33825409	Tapa frontal tubo venteo	NB 1	400034
006081	Tapa trasera cigüeñal	NB 1	400035
0490458	Tapa trasera tapa cilindros	NB 1 1	400036
006054	Precámara combustión	CU 6 6	400037
006054	Precámara combustión	AL	410037
33826111	Porta retén bancada trasera	NB 1	400038
36866416	Caja distribución bomba vacío	NB 1	400039
	Válvula reguladora a block	NB 1	400239
	Junta tapa trasera	CG 1	400140
36853105	Caja distribución tapa toma fuerza	NB 1	400045
0490685	Comando bomba combustible	NB 1	400146
0490699	Block tapa trasera	NB 1	400047
0490692	Conexión entrada agua	NB 1	400048
002742	Caño aceite a block	NB 1	400249
36835411	Conexión salida agua	NB 1 1	400051
0490024	Salida agua a tapa	NB 1 1	400052
0490391	Cuerpo codo paso agua	NB 2	400153
006007	Filtro aceite a block	NB 1	400057
36883106	Jgo. juntas bancada cigüeñal (2)	SLA 1	400158
36866428	Bomba vacío a tapa distribución	NB 1	400062
006074	Bomba vacío a bomba combustible	NB 1	400165
36865543	Soporte bomba inyectora	NB 1	400066
	Placa bomba agua	NB	400363
	Kit de arandelas (57)	VS 1	400175
	Arandela A 10 x 14 x 1 A	AL 15	
	Arandela A 13 x 20 x 1.25 A	AL 10	
	Arandela A 17 x 22 x 1 A	AL 10	
	Arandela A 19 x 27 x 2 A	AL 1	
	Arandela A 8 x 12 x 1 A	AL 15	
	Kit de retenes completo		R400300
	Jgo. retén válvulas (12)	P 1	R540210P
	Jgo. retén válvulas (12)	P 1	R400110P
	Retén bancada 133.35 x 158.75 x 11/13	P 1	R400211P
	Retén distribución 60.32 x 79.36 x 9.5	P 1	R400012P

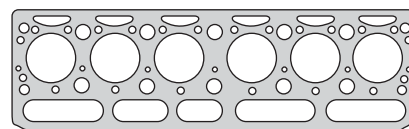

400308

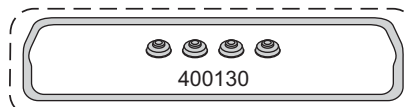

400130

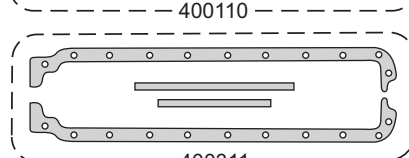

400110

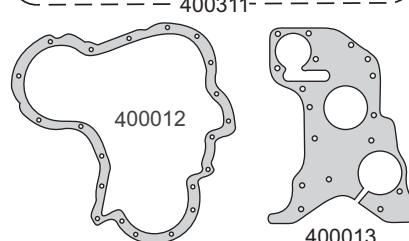

400311



400012

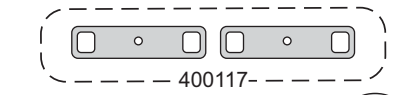

400013



400015

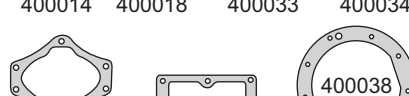

400117

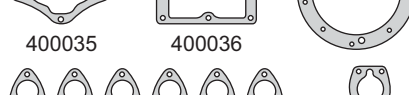

400014



400018



400033

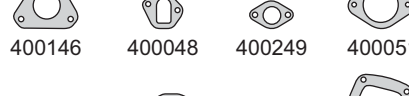

400034



400035

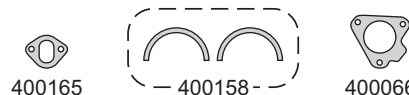

400036



400037

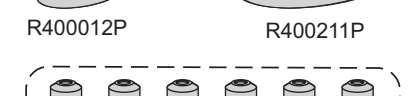

400047



400239



400140

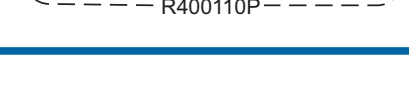

400039



400045



400146



400048



400249



400051



400052



400153



400057



400062



400165



400158



400066



R400012P



R400211P



R540210P



R400110P

**PERKINS**



Motor/Engine	Cm³	HP	Ø
<b>Q20B4</b> (OHV) 8V	<b>3860</b>	<b>70</b>	<b>98.4</b>

**Chevrolet:** Vehicular GM D20

**DIESEL**



Nº OE	Descripción/Description	Mat.	Ref.
424801/423607	Jgo. de juntas para motor		<b>401000-R</b>
	Jgo. de juntas superior		<b>401095</b>
	Jta. tapa cilindros Ø 104.0 ± 1.70	NFT	<b>410605</b>
<b>36812338</b>	Jta. tapa cilindros Ø 104.0 ± 1.70 NRT	NFT	<b>410607</b>
70490149	Junta tapa válvulas	CG 1	410610
70490178	Junta para cárter	CG	280311
36813138	Tapa distribución	NB	410612
36814127	Placa distribución	NB	410613
36866724	Tapa bomba de agua trasera	NB	410614
36862134	Jgo. múltiple escape (2)	FCH 1	410616
0490301	Salida de escape	FCH 1	400218
70490144	Bomba de agua a block	NB	410619
36866416	Adaptador bomba vacio	NB	410630
70490146	Block a bomba de agua	NB	410631
36867156	Bomba de agua a block	NB	410731
36853514	Cuerpo salida agua	NB 1	410632
36851409	Tapa trasera tapa cilindros	NB 1	410633
36862517	Filtro lubricación block y placa	NB	410634
36834143	Bomba inyectora	NB	400435
0490734	Carcasa termostato	NB 1	410635
36817157	Porta retén bancada trasera	NB	400236
36862133	Múltiple admisión central	NB 1	410636
36862151	Conexión superior salida de agua	NB 1	410637
36862131	Múltiple admisión trasera	NB 1	410638
36866462	Múltiple admisión frontal	NB 1	410639
7049145	Cuerpo delantero y trasero bomba de agua	NB	410640
36835425	Carcaza a conexión superior	CG	410641
32811113	Bastón placa interior a block	GS	400442
36851113	Bomba alimentación a block	NB	410642
36832122	Tubo succión bomba aceite	NB	410643
36825107	Cierre inspección distribución	NB	400244
0490355	Tubo succión a válvula alimentación	NB	410644
36822111	Colector escape	NFT 2	410645
0490773	Comando bomba inyectora	NB	400146
70490100	Acoplamiento bomba inyectora	NB	410546
	Anillo lubricación tapa cilindros G10.7 x 6.2 x 6	GS	400646
	Adaptador vacio	NB	410747
	Junta placa ventilación	NB	410649
	Junta base bomba de nafta	NB	410650
	Junta válvula alivio	NB	410651
	Junta válvula alivio	NB	410652
	Junta conexión	NB	410653
	Junta base bomba de nafta	NB	410654
	Bomba de vacio a brida	NB	400062
	Arandela A 10 x 20 x 2 C	CU 4	4
	Arandela A 10 x 14 x 1.5 A	AL	4
	Arandela A 14 x 20 x 1.5 A	AL	10
	Arandela A 20 x 26 x 1 A	AL	1
	Arandela A 8 x 10 x 1 A	AL	8
	O´ring G 21 x 35 x 13	GS 4	4
	Kit de retenes completo		R410600
	Jgo. retén válvulas (8)	P	1 R300310P
	Retén bancada 133.35 x 158.75 x 11/13	P	1 R400211P
	Retén distribución 60.32 x 79.36 x 9.5	P	1 R400012P

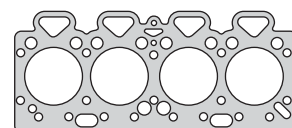

410607

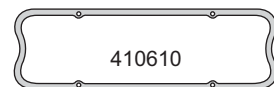

410610

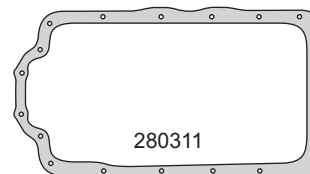

280311

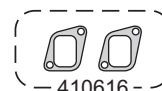

410616

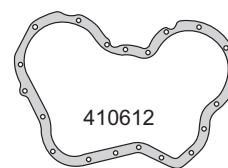

410612

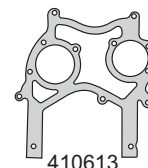

410613



410614



410619



400218



410630



410631

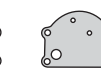

410731



410632



410633



410634



400435



410635



400236



410636



410637



410638



410639



410640



410641



410642



400442



410643



410644



400244



400146



410546



410645



410747



400062



410649



410650



410651



410652



410653

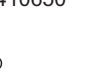

410654



R400211P



R400012P

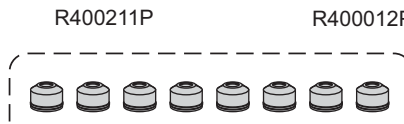

R300310P

**PERKINS**



Motor/Engine	Cm³	HP	Ø
4.203 Potenciado (OHV) 8V	3336	71	91.44
<b>DIESEL</b>			

Ford: F100



Nº OE	Descripción/Description	Mat.	Ref.
	Jgo. de juntas para motor		410000-R
	Junta tapa cilindros Ø 92.5 ± 1.40	NFT 1	400005
36812125	Junta tapa cilindros Ø 92.5 ± 1.40	NFT	400007
	Junta tapa cilindros Ø 92.5 ± 1.15	CNC	400008
	Jgo. tornillos tapa cilindros (HAS19038)		B400000
0490704	Conjunto tapa válvulas superior (4)	CG 1	400010
	Jgo. junta para cárter (4)	NB 1	410011
006072	Tapa distribución	NB 1	400012
36814112	Block caja distribución	NB 1	400013
36866417	Bomba de agua	NB 1	400014
006002	Jgo. múltiple escape (2)	FCH 1	400015
006061	Múltiple admisión	NFT 1	400017
0490032	Salida de escape	FCH 1	400018
36883106	Arandela tapa válvulas	GS 3	400130
	Arandela base inyector A 14 x 20 x 1.5 C	CU	400033
33825409	Tapa frontal a tapa inspección	NB 1	400034
0490485	Tapa trasera tapa cilindro	NB 1	400036
006054	Tapa precámara combustión	CU 4	400037
006054	Precámara combustión	AL	410037
33826111	Porta retén bancada trasera	NB 1	400038
36866416	Caja distribución a bomba vacío	NB 1	400039
0490867	Tapa trasera termoarranque	CG 1	400140
36853105	Caja distribución tapa toma fuerza	NB 1	400045
0490685	Comando bomba combustible	NB 1	400146
0490699	Tapa trasera árbol levas	NB 1	400047
0490692	Conexión entrada agua	NB 1	400048
36835411	Conexión salida agua	NB 1	400051
0490024	Salida agua a tapa	NB 1	400052
0490184	Termostato	NB	400053
0490391	Cuerpo codo paso agua	NB 1	400153
006007	Filtro aceite a block	NB 1	400057
36866428	Bomba vacío tapa brida	NB 1	400062
006074	Bomba alimentación combustible	NB 1	400165
36865543	Soporte bomba inyectora	NB 1	400066
003152	Tapa inspección cárter	NB 1	410167
	Kit arandelas (57)	VS 1	400075
	Arandelas A 10 x 14 x 1 A	AL 15	
	Arandelas A 13 x 20 x 1 A	AL 10	
	Arandelas A 14.5 x 20.5 x 1.5 C	CU 6	
	Arandelas A 17.5 x 22 x 1 A	AL 10	
	Arandelas A 19 x 27 x 2 A	AL 1	
	Arandelas A 8 x 12.5 x 1 A	AL 15	
	Kit de retenes completo		R400000-1
	Jgo. retén válvulas (8)	P 1	R400010P
	Jgo. retén válvulas (8)	P 1	R300310P
	Retén bancada 133.35 x 158.75 x 11/13	P 1	R400211P
	Retén distribución 60.32 x 79.36 x 9.5	P 1	R400012P

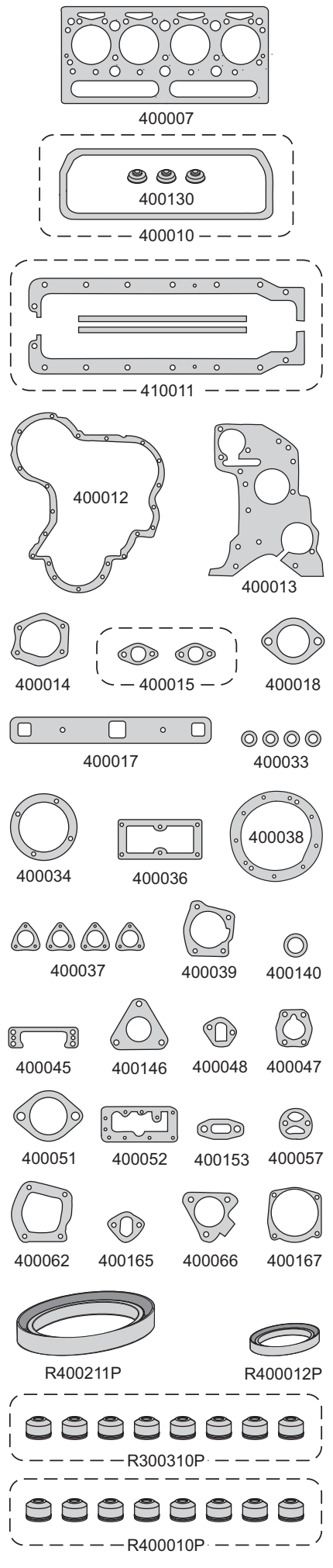

**PERKINS**



Motor/Engine	Cm³	HP	Ø
Q20B4 - 4.236	3860	70	98.4
4.248 (OHV) 8V	4070	70	101

**Chevrolet:** GM D10/20/40 Aspirado Turbo  
**Massey Ferguson:** MF220, F290, MF85X  
**Maxion-Perkins:** GM D10, F350, VW6.80  
 Case 550



DIESEL

Nº OE	Descripción/Description	Mat.	Ref.
424801/423607	Jgo. de juntas para motor		410600-R
	Jgo. de juntas superior		410695
	Jta. tapa cilindros Ø 104.0 ±1.70	NFT	410605
36812338	Jta. tapa cilindros Ø 104.0 ±1.70	NFT	410607
70490149	Junta tapa válvulas	CG	410610
36815706	Junta para cárter	NB	410611
36813138	Tapa distribución	NB	410612
36814127	Placa distribución	NB	410613
36866724	Tapa bomba de agua trasera	NB	410614
36862134	Jgo. múltiple escape (2)	FCH	410616
0490301	Salida de escape	FCH	400218
70490144	Bomba de agua a block	NB	410619
36866416	Adaptador bomba de vacio	NB	410630
70490146	Block a bomba de agua	NB	410631
36853514	Cuerpo salida agua	NB	410632
0921173	Arandela pico inyector A 10 x 20 x 1.5 C	CU	410533
36851409	Tapa trasera tapa cilindros	NB	410633
36862517	Filtro lubricación block y placa	NB	410634
36834143	Bomba inyectora	NB	400435
0490734	Carcasa termostato	NB	410635
36817157	Porta retén bancada trasera	NB	400236
36862133	Múltiple admisión central	NB	410636
36862151	Conexión superior salida de agua	NB	410637
002794	Base filtro aceite	NB	400238
36862131	Múltiple admisión trasera	NB	410638
36865511	Distribución a bomba de vacio	NB	400039
36866462	Múltiple admisión frontal	NB	410639
7049145	Cuerpo delantero y trasero bomba de agua	NB	410640
36835425	Carcasa a conexión superior	CG	410641
32811113	Bastón placa interior a block	GS	400442
36851113	Bomba alimentación a block	NB	410642
36832122	Tubo succión bomba aceite	NB	410643
	Junta succión a lubricación aceite	NB	410743
36825107	Cierre inspección distribución	NB	400244
0490355	Tubo succión a válvula alimentación	NB	410644
	Junta boca lubricación	NB	410744
36822111	Colector escape	NFT	410645
0490773	Comando bomba inyectora	NB	400146
70490100	Acoplamiento bomba inyectora	NB	410546
	Adaptador vacio	NB	410747
	Bomba de vacio a brida	NB	400062
36817136	Porta retén bancada trasera	NB	400283
36866416	Anillo lubricación tapa cilindros G 7.2 x 11 x 6	GS	
	Arandela A 10 x 20 x 2 C	CU	
	Kit de retenes completo		R410600
	Jgo. retén válvulas (8)	P	R300310P
	Jgo. retén válvulas (8)	P	R410610P
	Retén bancada 133.35 x 158.75 x 11/13	P	R400211P
	Retén distribución 60.32 x 79.36 x 9.5	P	R400012P

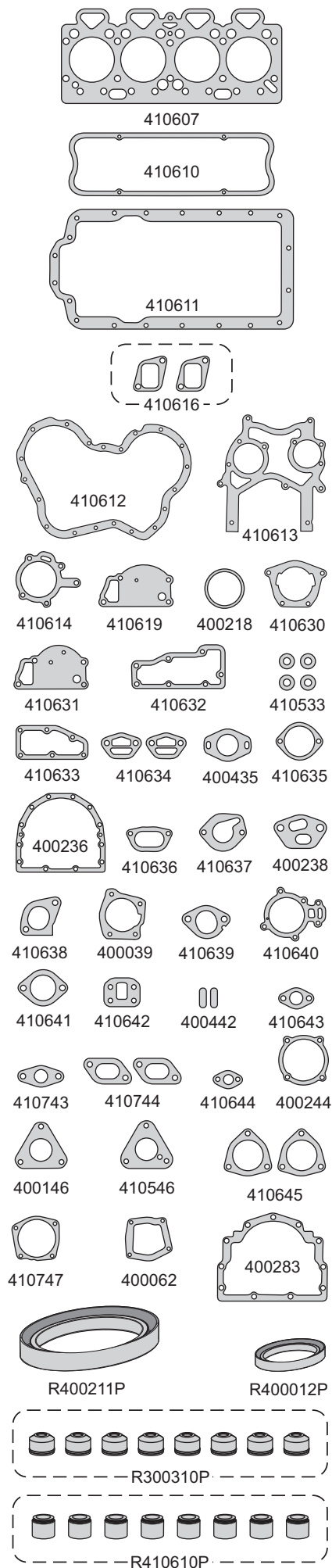

**PERKINS**



Motor/Engine	Cm³	HP	Ø
T 4.33 Turbo Iny. Directa	3330	91/95	91.46
<b>DIESEL</b>			

Perkins: Pick Up, Camiones livianos



Nº OE	Descripción/Description	Mat.	Ref.
005967	Jgo. de juntas para motor	●	410800-R
006283	Junta tapa cilindros Ø 93.0 $\pm$ 1.40	NFT	410807
	Junta tapa cilindros Ø 93.0 $\pm$ 1.20	CNC	1 410808
0490704	Conj. junta tapa válvulas (4)	CG	1 400010
006076	Jgo. junta para cárter (4)	NB	1 410011
006072	Tapa distribución	NB	1 400012
36814112	Placa distribución	NB	1 400013
36866417	Tapa bomba de agua	NB	1 400014
006322	Jgo. múltiple escape (2)	NFT	1 410816
006061	Múltiple admisión	NFT	1 400017
0490184	Conexión salida agua	CB	1 300019
	Arandelas tapa válvula	GS	3 400130
36833148	Drenaje aceite turbo	NB	1 400432
33825409	Tapa frontal	NB	1 400034
3686454	Turbo a descarga caño aceite	NB	1 410834
36832131	Entrada aceite turbo	NB	1 410835
0490485	Tapa trasera	NB	1 400036
006319	Múltiple admisión a codo admisión	NB	1 410836
006320	Turbo a codo salida de escape	NFT	1 410837
338261111	Porta retén bancada	NB	1 400038
36866416	Caja distribución bomba vacío	NB	1 400039
36822111	Codo a salida de escape	NFT	1 410645
006323	Comando bomba combustible	NB	1 400246
0490699	Tapa trasera árbol levas	NB	1 400047
0490692	Conexión entrada agua	NB	1 400048
3683211	Succión aceite	NB	1 400249
0490024	Salida agua a tapa cilindros	NB	1 400052
006007	Filtro aceite a block	NB	1 400057
36885008	Turbo a múltiple escape	AC	1 350462
006074	Bomba alimentación	NB	1 400165
L 311 FF 02	Arandela inyector A 15.1 x 18 x 1.5 C	CU	4
	Kit de retenes completo		R400000-1
	Jgo. retén válvulas (8)	P	1 R400010P
	Jgo. retén válvulas (8)	P	1 R300310P
	Retén bancada 133.35 x 158.75 x 11/13	P	1 R400211P
	Retén distribución 60.32 x 79.36 x 9.5	P	1 R400012P

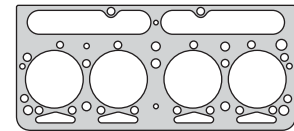

410808

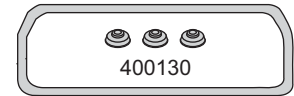

400130

400010

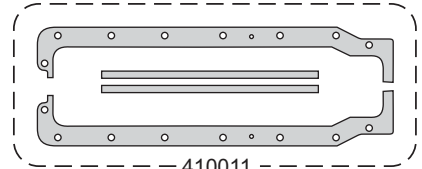

410011

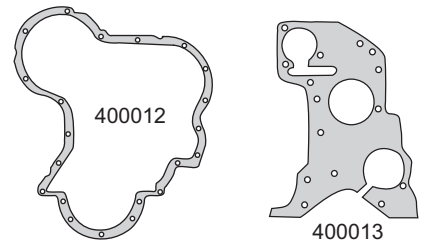

400012

400013

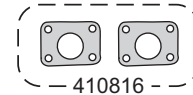

410816



400017



400014

300019

400034

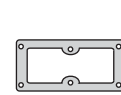

400036

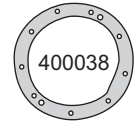

400038

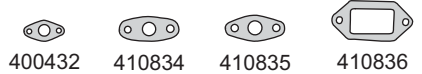

400432

410834

410835

410836

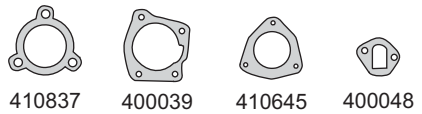

410837

400039

410645

400048

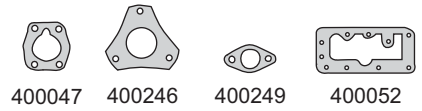

400047

400246

400249

400052

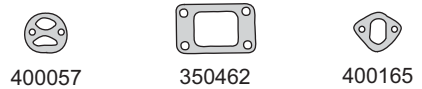

400057

350462

400165



R400211P



R400012P



R300310P



R400010P



# PERKINS



Motor/Engine	Cm³	HP	Ø
6-357 Vehicular	5840	120	104.1
6-357 Agrícola	5840	91	104.1
6-357 Industrial	5840	108	104.1

**Chevrolet:** Brasil D60 - D70  
**Chrysler:** P700D - P900  
**Ford:** F600/750/1100 - MF3366 - F6000  
 F7500/11000

DIESEL



Nº OE	Descripción/Description	Mat.	Ref.
635752/704	Jgo. de juntas para motor		410900-R
	Jgo. de juntas superior		410995
70490058	Junta tapa cilindros Ø 107.2 ± 1.50	NFT	1 1 410907
70490139	Junta tapa válvulas	CG	1 1 410910
70490132	Junta para cárter	CG	410911
70490132	Junta cárter versión agrícola	NB	1 420011
70490092	Tapa distribución	NB	1 410912
70490065	Inspección distribución	CG	2 410913
70490050	Tapa bomba de agua	NB	1 410914
0490675	Jgo. múltiple escape (3)	NFT	1 1 410916
70490087	Múltiple admisión	NB	1 1 410917
	Salida de escape	NB	1 1 400218
70490020	Tubo salida de escape	NFT	1 1 410918
70490071	Conexión salida agua	NB	1 1 410919
70490112	Placa adaptadora bomba alimentación	NB	1 410928
70490024	Accionamiento taquímetro	NB	1 410929
704900833	Adaptador distribución	NB	1 410630
70490136	Placa adaptadora bomba	NB	1 410930
70490135	Bomba alimentación a block	NB	2 410931
70490143	Filtro aceite	NB	2 410932
70490049	Succión bomba aceite	NB	2 410933
70490091	Succión bomba aceite	NB	1 410934
0490263	Porta retén trasero	NB	1 410936
70490101	Cámara de agua	NB	2 410937
0490300	Cámara de agua tapa cilindros	NB	1 1 410938
0490676	Carcasa termostato	NB	1 1 410939
0490307	Entrada admisión	NB	1 1 410941
70490093	Conexión superior salida agua	NB	1 1 410942
0490736	Entrada agua a block	NB	1 410943
0490288	Placa a block	NB	1 410944
049025	Tubo succión a block	NB	1 410945
70490100	Acople bomba inyectora	NB	1 410546
0490433	Tubo salida escape	NFT	1 1 410946
	Jgo. empaquetadura a cigüeñal (2)	SLA	1 400158
70730006	Jgo. empaquetadura a cigüeñal	SNA	410958
	Arandela A 10 x 16 x 1 C	CU	6
0921176	Arandela A 8 x 12 x 1 A	AL	7
	Arandela A 8 x 12 x 1 C	CU	6
0920113	Arandela A 14 x 20 x 1.5 C	CU	14
	Arandela A 14 x 20 x 1 C	CU	
	Arandela A 10 x 16 x 1 A	AL	8
	Arandela A 40 x 47 x 1 C	CU	
	Jgo. retén válvulas (12)	N	1 R410910N
	Retén distribución 50.9 x 69.8 x 9.5	N	1 R410912N

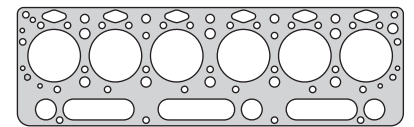

410907

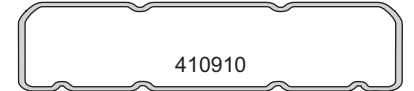

410910

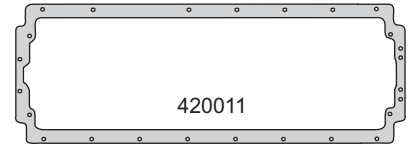

420011

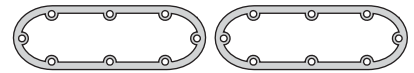

410912



410914

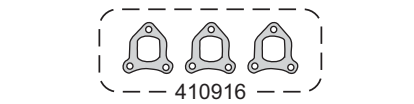

410916

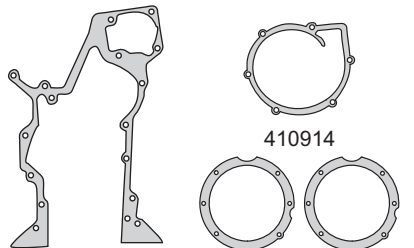

410912

410913

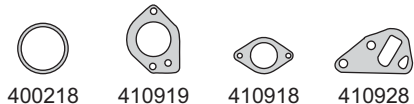

400218

410919

410918

410928

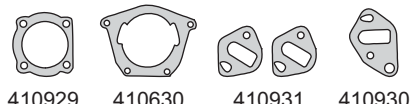

410929

410630

410931

410930

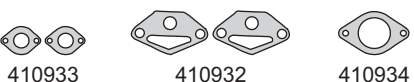

410933

410932

410934



410936

410938

410939

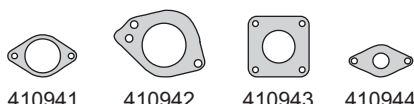

410941

410942

410943

410944

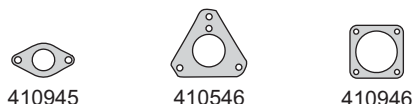

410945

410546

410946



400158

R410912N

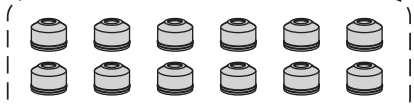

R410910N

**PERKINS**



Motor/Engine	Cm³	HP	Ø
Prima 65/80T Leyland Prima 65 Daf TN 44	1994	64/80	84.45

**Perkins:** Rover, Maestro D/TD  
Perkins, Marino 4.20 D/TD  
Leyland Sherpa 185/200/215/220/230  
240/255 1986/94  
Daf Ka 200/ VS 200 1986/...

DIESEL



Nº OE	Descripción/Description	Mat.	Ref.
	<b>Jgo. de juntas para motor</b>		<b>420600-R</b>
L681EF06	Junta tapa de cilindro Ø 86.0 ± 1.50	NFT	1 420607
	<b>Jgo. tornillos tapa cilindros (HAS15038)</b>		<b>B420600</b>
L681KF03	Junta para cárter	NB	1 420611
L687YF02	Frente motor para bomba aceite a block	NB	1 420612
L681VF02	Múltiple admisión y escape	NFT	1 420615
006155	Salida de escape	AC	1 420618
L683NF02	Retorno agua termostato	NB	1 420619
L687MF03	Conexión salida agua	NB	1 420621
L687MF13	Cuerpo salida agua a tapa de cilindros	NB	2 420622
L687MF05	Codo a múltiple admisión	NB	1 420623
006165	Caja drenaje aceite	NB	2 420624
L683NF02	Junta conexión salida agua	NB	2 420626
L683HF01	Junta carga aceite a block	NB	1 420627
L687MF14	Bomba aceite a cabezal	NB	1 420636
006167	Placa adaptador a block trasero	NB	1 420637
L683HF05	Tubo carga aceite a block	NB	1 420638
L688CF01	Turbo a salida escape	NFT	2 420639
	Entre múltiple turbo	AC	1 500546
36862126	Bomba combustible	NB	400165
	Arandela A 6.5 x 10 x 1 C	CU	8
	Arandela A 8 x 11 x 1 A	AL	8
	Arandela A 8 x 14 x 1.5 C	CU	4
	Arandela A 20 x 26 x 1 A	AL	2
	Arandela A 14 x 20 x 1.5 C	CU	1
	Arandela A 20 x 25 x 2 A	AL	1
	Arandela A 14 x 18 x 1.5 A	AL	1
	O´ring G 47.29 x 2.62	GS	1
	O´ring G 20 x 2	GS	1
	Kit de retenes completo		R420600
	Jgo. retén válvulas (8)	P	1 R420610P
	Retén bancada 88. 9 x 105 x 9.5	P	1 R420611P
	Retén distribución 35 x 45 x 7	P	1 R420612P
	Retén árbol de levas trasero 40 x 52 x 7	P	1 R420613P
	Retén árbol de levas trasero 45 x 60 x 7	P	1 R420614P

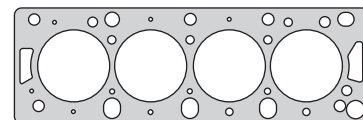

420607

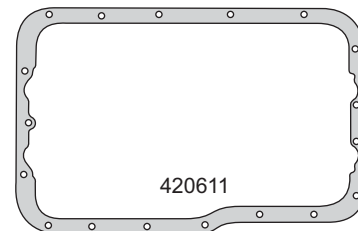

420611



420615

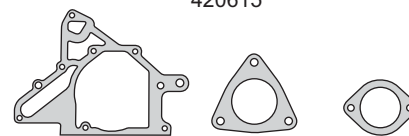

420612

420618

420619



420621

420622

420623



420624

420626



420627

420636

500546

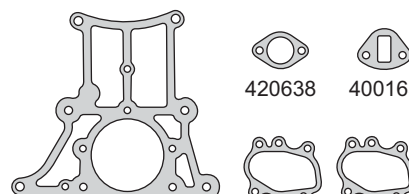

420637

420638

400165



420639

G 20 x 2



A 14 x 20 x 1.5 C

G 20 x 2

A 20 x 26 x 1 A

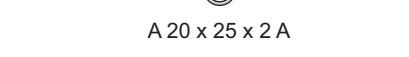

A 20 x 25 x 2 A

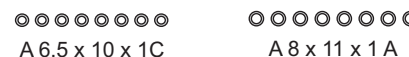

A 6.5 x 10 x 1 C

A 8 x 11 x 1 A



G 47.29 x 2.62

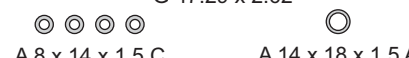

A 8 x 14 x 1.5 C

A 14 x 18 x 1.5 A



R420611P

R420614P

R420612P



R420610P

# PSA - PEUGEOT / CITROËN

## JUNTA TAPA DE CILINDROS / HEAD GASKETS

### MOTORES NAFTA Y DIESEL / PETROL AND DIESEL ENGINES

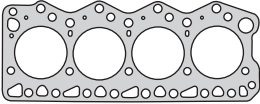
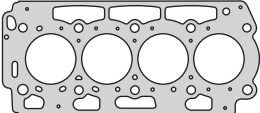
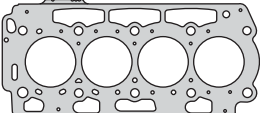
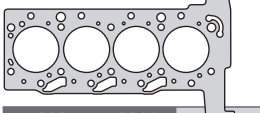
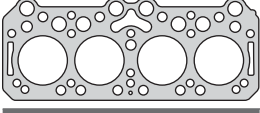
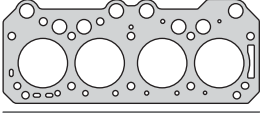
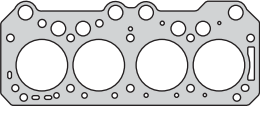
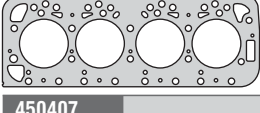
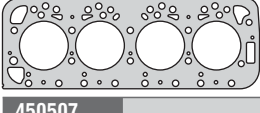
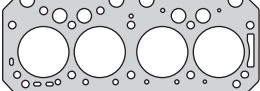
	Código Code	Q	≠	Kit Bulón Bolt Set	Aplicación Application	Motor Engine	Juego
	270107-SM	96.0	1.30	B270100	Boxer TDI/HDI 2001/09 <b>DIESEL</b>	2798cc. 8140.43 Euro II 8140.43S Euro III Common Rail 122/125HP Ø94.4 (SOHC) 8V	252901-R 🚗 pág. 181
	270107-1M	96.0	1.40	🔩 HAS17038			
	270107-2M	96.0	1.50				
	270107-3M	96.0	1.60				
	302107-1M	76.0	1.20	B302100	206 TDI, 307 HDI 2001/... <b>DIESEL</b>	1398cc. DV4TD (8HZ/8HX) 68HP Ø74 (SOHC) 8V	302101-R 🚗 pág. 260
	302107-2M	76.0	1.30	🔩 HAE14038			
	302107-3M	76.0	1.40				
	302107-4M	76.0	1.45				
	302107-5M	76.0	1.50				
	302108-1M	75.0	1.25	B302100	206 TDI, 307 HDI 2001/... <b>DIESEL</b>	1398cc. DV4TD (8HZ/8HX) 68HP Ø74 (SOHC) 8V	302101-R 🚗 pág. 260
	302108-2M	75.0	1.30	🔩 HAE14038			
	302108-3M	75.0	1.35				
	302108-4M	75.0	1.40				
	302108-5M	75.0	1.45				
	324807-1M	87.1	1.20	B324800	Boxer HDI 2006/... <b>DIESEL</b>	2198cc. 4HU/4HV (P22DTE) 101/120HP Ø86 (DOHC) 16V	324801-R 🚗 pág. 326
	324807-2M	87.1	1.25	🔩 HAS13038			
	324807-3M	87.1	1.30	HAS17038			
	324808-1M	87.1	1.10				
	324808-2M	87.1	1.15				
	324808-3M	87.1	1.20				
	450005	86.5	1.40	B450000	404 1962/80	1618cc. XC7-XC7P 59HP Ø84 (OHV) 8V	450000-R 🚗 pág. 392
	450006	86.5	2.40	🔩 HAS19038	504 GLS/GLSE 1969/80	1657cc. XC7-XC6A 59HP Ø85 (OHV) 8V	450100-R 🚗 pág. 394
	450205	86.5	1.40	B450200	504 XE/XL/XSE 1973/78	1796cc. XC7 - XM7 69/70HP Ø85 (OHV) 8V	450200-R 🚗 pág. 395
	450206	86.5	2.40	🔩 HAS19038			
	450207	86.5	1.40				
	450305	90.0	1.40	B450200	504 TN/GES/XNA 1976/80	1971cc. XN1 - XN2 78/85HP Ø88 (OHV) 8V	450300-R 🚗 pág. 397
	450306	90.0	2.40	B460200	505, 9R, J9/J5 1980/92	1971cc. GR/SR - XN1/XN2 85HP Ø88 (OHV) 8V	450500-R 🚗 pág. 401
	450307	90.0	1.40	🔩 HAS19038 HAT55055 HAT55100			
	450405-1M	96.0	1.55	B450700	XD2 504D 1976/93, 505D 1979/82, 505TD 1981/..., 604TD 1978/83, J7D1977/..., J9D 1980/... XD3 504 1987/..., 505 1982/93, J9 1986/94 <b>DIESEL</b>	2304cc. XD2 - XD2P 70/73HP Ø94  2498cc. XD3 - X3DP 76/90HP Ø94 (OHV) 8V	450701-R 450700-R-1M 450700-R-2M 450700-R-3M 450700-R-4M 🚗 pág. 399
	450405-2M	96.0	1.65	B450700-1			
	450405-3M	96.0	1.75	🔩 HAS12038			
	450405-4M	96.0	1.85	HAS17038			
	450407-1M	96.0	1.50	B450700	XD2 504D 1976/93, 505D 1979/82, 505TD 1981/..., 604TD 1978/83, J7D1977/..., J9D 1980/... XD3 504 1987/..., 505 1982/93, J9 1986/94 <b>DIESEL</b>	2304cc. XD2 - XD2P 70/73HP Ø94  2498cc. XD3 - X3DP 76/90HP Ø94 (OHV) 8V	450701-R 450700-R-1M 450700-R-2M 450700-R-3M 450700-R-4M 🚗 pág. 399
	450407-2M	96.0	1.60	B450700-1			
	450407-3M	96.0	1.70	🔩 HAS12038			
	450407-4M	96.0	1.80	HAS17038			
	450507-1.50	90.0	1.50	B450200	505 1983/86, 504 1970/84, 604 1982/86	1971cc. XN2 - XN6 105HP Ø88 (OHV) 8V	450600-R 🚗 pág. 403
	450507-1.80	90.0	1.80	B460200 🔩 HAS19038 HAT55055 HAT55100	505 1987/...	1971cc. XN1 - XNA - Gamma 90HP (OHV) 8V Ø88	450800-R 🚗 pág. 404

# PSA - PEUGEOT / CITROËN

## JUNTA TAPA DE CILINDROS / HEAD GASKETS







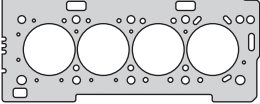

### MOTORES NAFTA Y DIESEL / PETROL AND DIESEL ENGINES

	Código Code	Q	≠	Kit Bulón Bolt Set	Aplicación Application	Motor Engine	Juego
	<b>450905 - 450906</b> 450905 450906	82.0 82.0	1.40 2.40		403/7 1959/66 403/8 1955/67	<b>1290cc.</b> 7CV 52HP Ø75 <b>1468cc.</b> 8CV 55/58 Ø80	<b>450900-R</b> 🚗 pág. 406
	<b>451307</b> 451307	87.0	1.20	<b>B460300</b> 🔩 HAT55055 HAT55100	Citroën XM 1989/94 - 1990/93 Peugeot 605 1989/98	<b>1998cc.</b> XU10M 107HP XU102C 114HP XU10J2 122/130HP Ø86 (SOHC) 8V	<b>451300-R</b> 🚗 pág. 408
	<b>451407</b> 451407	85.0	1.40		Citroën BX GTI 1987/93 Peugeot 309 1989/93, 405 1987/95	<b>1905cc.</b> XU9J4 147/155/160HP Ø83 (DOHC) 16V	
	<b>451507</b> 451507	73.5	1.30	<b>B470500</b> 🔩 HAE14038	Citroën C15 1988/..., AX 10 1986/... Saxo 1996/... Peugeot 205 1987/93, 106 1991/... Citroën Saxo, Berlingo, ZX 1996/... Peugeot 106, 306, Partner 1996/...	<b>954cc.</b> TU9M/MZ/K 41/45/50HP Ø70  <b>1124cc.</b> TU1M 54HP Ø72 (SOHC) 8V	<b>451500-R</b> 🚗 pág. 409
	<b>451607</b> 451607	76.0	1.30	<b>B470500</b> 🔩 HAE14038	Citroën AX14, BX14 1991/..., ZX 1994/... AX GT 1993/..., C15 1991/... Peugeot 106 1991/96, 309 1992/93 405 1993/94, 205 1991/93	<b>1360cc.</b> TU3F - TU3F2 - TU3FM TU3J2/Z - TU3MC (Motor con block de fundición gris) 75/94HP Ø75 (SOHC) 8V	<b>451600-R</b> 🚗 pág. 410
	<b>451705 - 451707</b> 451705 451707	76.0 76.0	1.30 1.30	<b>B470500</b> 🔩 HAE14038	Citroën AX11 1986/97, BX 11, C15 1988/... ZX 1991/98 - Peugeot 106 1991/..., 306 1993/97, 205 1987/96, 309 1990/93 Citroën BX 14, C15 1988/..., Saxo 1996/... ZX 1991/98, Berlingo, Xsara 1996/... Peugeot 106 1991/..., 206 1998/... 405, 205, 309 1987/96, Partner 1996/...	<b>1124cc.</b> TU1M/MZ 55HP Ø72  <b>1360cc.</b> TU3M/S/A/MC/JP 70/75/80/85HP Ø75 (Motor con block de aluminio) (SOHC) 8V	<b>451700-R</b> 🚗 pág. 411
	<b>451705 - 451707</b> 451705 451707	76.0 76.0	1.30 1.30	<b>B470500</b> 🔩 HAE14038	Citroën C2/C3, C3 Pluriel 2002/... Berlingo 1997/... Peugeot 206, 307 2001/... Partner 2005/..., 207 Compact	<b>1360cc.</b> TU3JP (KFW) - TU3-2 (K5A) 75HP Ø75 (SOHC) 8V	<b>452200-R</b> 🚗 pág. 415
	<b>451807</b> 451807	76.0	1.20		Peugeot 104 1972/86, 205 1983/86  Citroën Visa 11 1978/85, C15 1984/85 Peugeot 104 1975/86, 205 1983/86 Citroën Visa Super X 1981/83 Peugeot 104 1980/84	<b>954cc.</b> XV3 - XV5 - XV8 45HP Ø70 <b>1124cc.</b> 109/5/K - XW3/7 57HP Ø72 <b>1219cc.</b> 129/5 64HP - XZ5 57HP Ø75	<b>451800-R</b> 🚗 pág. 420
	<b>451807</b> 451807	76.0	1.20		Citroën Visa GT, BX 14 1982/85 Peugeot 104 1982/86, 205 1983/86	<b>1360cc.</b> 150 70/72HP Ø75 XY6B/XY8 - XY6B/XY7 70HP Ø75	<b>451800-R</b> 🚗 pág. 420
	<b>452008</b> 452008	93.0	1.40	<b>B452000</b> 🔩 HAE14038	Citroën Jumper TDI, Relay TDI 1997/... Peugeot Boxer TDI 1997/... <b>DIESEL</b>	<b>2445cc.</b> DJ5TED(THX) 107HP Ø92 (SOHC) 8V	<b>452000-R MLS</b> 🚗 pág. 413

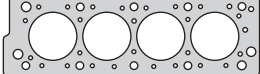
# PSA - PEUGEOT / CITROËN

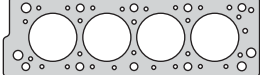
## JUNTA TAPA DE CILINDROS / HEAD GASKETS

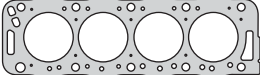
### MOTORES NAFTA Y DIESEL / PETROL AND DIESEL ENGINES

	Código Code	Q	≠	Kit Bulón Bolt Set	Aplicación Application	Motor Engine	Juego	
	452105	80.0	1.40	B452100	Citröen Berlingo, C3 Pluriel, Xsara 2000/... C2, C3 2002/... - 2004/... Peugeot 206, 307, Partner 2000/... 207 SW, 207 Compact	1587cc. TU5JP4 (NFU/N6A) 109HP Ø78.5 (DOHC) 16V	452100-R MLS 🚗 pág. 414	
	452107	80.0	1.20	 HAE14038				
	452107-1.4	80.0	1.40					
	452108	80.0	0.60					
452308	452308	89.0	0.74	B452300  HAE14038	Citröen C5 2000/... - C8 2002/... C6 2005/... Peugeot 406 1999/... - 607 - 807 2000/... 407 2004/...	2946cc. ES9J4S (XFX) 210HP ES9J4S (XFW) 204HP ES9A (XFV) 211HP Ø87 (DOHC) V6 24V		
452507	452507	90.0	1.40	B452500	Peugeot 504 Cabriolet - 604 1974/83  Volvo 260, 262, 264, 365 1975/80	2664cc. ZM 110HP Ø88  2664cc. B27E/B27F 114HP Ø88 (SOHC) 12V		
452607	452607	93.0	1.40	B452500	Peugeot 604 1983/87 - 505 1987/90  Volvo 760 1982/85 - 260/262/264/265 1980/..., 780 1986/91, 940/960/1990/...	2849cc. ZNJ 155/169HP Ø91  2849cc. B28E/B28F 155HP B28A 129HP (SOHC) 12V Ø91		
	460205	84.0	1.40	B460100  HAE14038	Citröen Xantia 1997/01, Xsara 1997/... Peugeot 306 1993/..., 405, 406 1992/... 406 1997/...  Citröen Berlingo 1997/... Peugeot Partner 1997/...	1761cc. XU7JP-XU7JB 90/103HP Ø83 (SOHC) 8V  1761cc. XU7JB 90HP Ø83 (SOHC) 8V	460100-R 🚗 pág. 416	
	460207	84.0	1.40					461100-R 🚗 pág. 425
	460207-1.2	84.0	1.20					
	460205	84.0	1.40	B460200  HAT55055 HAT55100	Citröen BX19 1984/93, BX19 GTI 1983/93 Peugeot 306, 405, 309GT, 305GTX 1986/93	1905cc. XU92C 96/104/125HP Ø83 (SOHC) 8V	460200-R 🚗 pág. 417	
	460207	84.0	1.40					
	460207-1.2	84.0	1.20					
460207	460207-1.2	84.0	1.20	B460200  HAT55055 HAT55100	Citröen BX 16 1982/93, BX 15 1987/91, Visa 1985/90, ZX 1991/97 Peugeot 305 1982/91, 205 1984/96, 309 1985/93, 405 1987/95 Citröen BX 19 1984/93 Peugeot 205, 309 1986/94, 305 1983/91, 405 1987/93	1580cc. XU5 75/90/115HP Ø83 (SOHC) 8V  1905cc. XU9 102/110/130HP Ø83 (SOHC) 8V	451200-R 🚗 pág. 407	
	460307-1M	84.0	1.50	B460300  HAT55055 HAT55100	Citröen Xantia 1993/98, Dispatch, Relay Jumper, Jumpy 1995/99, Berlingo 1996/99 Xsara 1997/... Peugeot 306 1993/99, 405 1988/95, 1995/... 305, 309 1982/93, 205, Express 1987/94 Boxer, Expert, Partner 1995/... <b>DIESEL</b>	1905cc. XUD9 64/69/71/90HP Ø83 (SOHC) 8V	460301-R	
	460307-2M	84.0	1.60					460300-R-1M
	460307-3M	84.0	1.70					460300-R-2M
	460307-4M	84.0	1.80					460300-R-3M 🚗 pág. 418
460507	460507	76.5	1.25		Citröen C15 1985/..., Visa 10 1986/88 Peugeot 104, 205 1986/87 Citröen Visa 11, C15 1985/... Peugeot 205 1986/87, 104 1986/... Citröen Visa GT, Bx14 1985/... Peugeot 205 1986/87	954cc 108C - XV8 45HP Ø70  1124cc. 109/5/K - XW7 55/57HP Ø72  1360cc. 150 - XY6B - XY7/XY8 70/72HP Ø75	460500-R 🚗 pág. 420	
460607	460607	87.0	1.50	B460300  HAT55055 HAT55100	Citröen ZX 1992/96, Xantia 1993/98 Peugeot 405 1992/..., 306 1993/...	1998cc. XU10J2C(RFX) 123HP Ø86 (SOHC) 8V	451900-R 🚗 pág. 412	

# PSA - PEUGEOT / CITROËN

## JUNTA TAPA DE CILINDROS / HEAD GASKETS



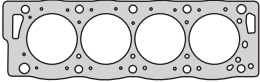
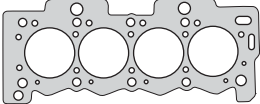
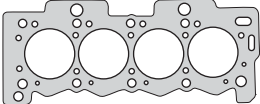
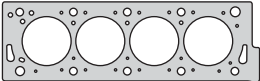
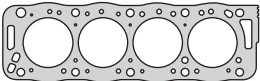
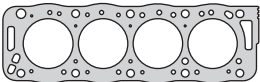
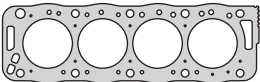
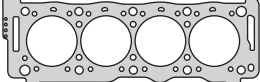
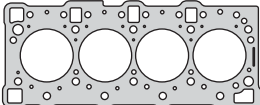
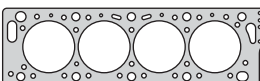







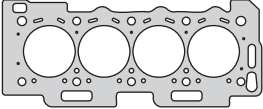

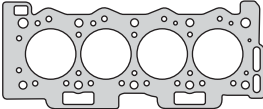

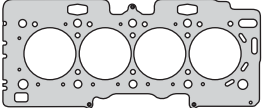

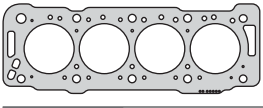

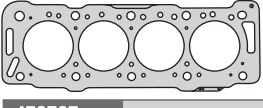

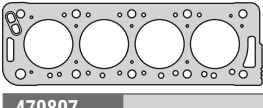
### MOTORES NAFTA Y DIESEL / PETROL AND DIESEL ENGINES

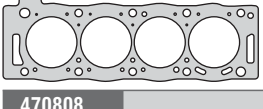
	Código Code	Q	≠	Kit Bulón Bolt Set	Aplicación Application	Motor Engine	Juego
	460607	87.0	1.50	B460300 HAT55055 HAT55100	Peugeot 406, 605, 806 Turbo 1996/...  Citroën ZX 1992/..., Xantia 1993/98 Peugeot 405 1992/..., 306 1993/...	<b>1998cc.</b> XU10J2TE 150HP Ø86 (SOHC) 8V	<b>460400-R</b> pág. 419  <b>460600-R</b> pág. 421
	460707	76.0	1.40	B470500 HAE14038	Citroën AX 11, BX 11, C15 1986/... ZX 1991/95 Peugeot 106 1991/..., 306 1993/97 205 1987/96, 309 1990/93 Citroën AX Sport 1987/91 Peugeot 205 Rallye 1988/93	<b>1124cc.</b> TU1M/MZ/K/Z 55/60HP Ø72 (SOHC) 8V  <b>1294cc.</b> TU24/M4A 94/102HP Ø75 (SOHC) 8V	<b>460700-R</b> pág. 422
	460707	76.0	1.40	B470500 HAE14038	Citroën BX 14, C15 1988/..., Saxo 1996/... AX 14, AX GT 1986/..., ZX 1991/98 Berlino, Xsara 1996/... Peugeot Partner 1996/..., 306 1993/... 106 1991/..., 205, 405 1987/96 309 1988/93, 206 1998/...	<b>1360cc.</b> TU3JP/S/M/MC/K/A TU3.2 65/70/75/80HP Ø75 (SOHC) 8V	<b>460700-R</b> pág. 422
	460807	84.0	1.40	B460800 HAE14038	Citroën Xsara 1997/..., Xantia 1995/96 Xantia 1997/2001, ZX 1997/98 Peugeot 306 1997/..., 406 1995/96 406 1997/...	<b>1761cc.</b> XU7JP4 112HP Ø83 (DOHC) 16V	<b>460800-R</b> pág. 423
	460907-1M 460907-2M 460907-3M	84.0 84.0 84.0	1.50 1.60 1.70	B460900 HAT55055 HAT55100	Citroën Xantia TD, ZX TD 1993/... Dispatch TD, Jumper TD Jumpy TD 1995/..., Xsara TD 1997/... Peugeot 306 TD 1993/97, 405 TD 1992/96 406 TD 1995/99, 806TD, Expert TD Boxer TD 1995/... <b>DIESEL</b>	<b>1905cc.</b> XUD9TE 90/92HP XUD9SD/TF 76/90/92HP XUD9TF 90/92HP XUD9UTF 90/92HP Ø83 (SOHC) 8V	<b>460301-R</b> (460900) pág. 424
	460908-1M 460908-2M 460908-3M 460908-4M 460908-5M	84.0 84.0 84.0 84.0 84.0	1.34 1.38 1.42 1.50 1.55	B460900 HAT55055 HAT55100	Citroën Xantia TD, ZX TD 1993/... Dispatch TD, Jumper TD Jumpy TD 1995/..., Xsara TD 1997/... Peugeot 306 TD 1993/97, 405 TD 1992/96 406 TD 1995/99, 806TD, Expert TD Boxer TD 1995/... <b>DIESEL</b>	<b>1905cc.</b> XUD9TE 90/92HP XUD9SD/TF 76/90/92HP XUD9TF 90/92HP XUD9UTF 90/92HP Ø83 (SOHC) 8V	<b>460301-R</b> (460900) pág. 424
	461307-1M 461307-2M 461307-3M 461307-4M 461307-5M	84.0 84.0 84.0 84.0 84.0	1.36 1.40 1.44 1.48 1.52	B460300 HAT55055 HAT55100	Citroën Dispatch, Relay, Jumpy, Xsara 1995/99, Berlino, ZX 1994/98, Jumper Peugeot 306, 405, Boxer, Partner Expert 1995/... <b>DIESEL</b>	<b>1905cc.</b> XUD9/XUD9A (D9B/DJY/HV/JZ) 69/71HP Ø83 (SOHC) 8V	
	461507-1M 461507-2M 461507-3M 461507-4M 461507-5M 461507-SM	86.0 86.0 86.0 86.0 86.0 86.0	1.52 1.57 1.62 1.67 1.72 1.77	B461500 HAE14038	Citroën XM TD 1989/00, Xantia TD 1995/98, Dispatch TD, Evasion TD Jumper TD, Jumpy TD, Synergie 1996/99 Peugeot 605 TD 1990/98 - 1995/98 406 TD 1995/..., 806 TD 1996/... <b>DIESEL</b>	<b>2088cc.</b> XUD11ATE/BTE 110HP Ø85 (SOHC) 12V	<b>461501-R</b> pág. 427
	470007	93.0	1.60	B470000 HAE14038	Citroën Jumper D/TD, XM TD Relay D/TD 1994/97 Peugeot Boxer D/TD 1994/... 605 TD 1995/99 <b>DIESEL</b>	<b>2445cc</b> DJ5 (T9A) 86HP DK5ATE 130HP DJ5T (T8A/THZ) 103HP Ø92 (SOHC) 12V	<b>470000-R</b> pág. 428
	470207	87.0	1.40	B470200 HAT55055 HAT55100	Citroën ZX 1992/97, Xantia 1993/95 Peugeot 405 MI, 405 TI Turbo 1992/95 306 1993/...	<b>1998cc.</b> XU10J4 152/155HP XU10J4TE 200HP Ø86 (DOHC) 16V	<b>470200-R</b> pág. 429

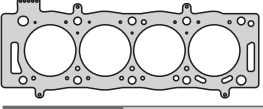
# PSA - PEUGEOT / CITROËN

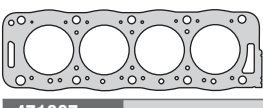
## JUNTA TAPA DE CILINDROS / HEAD GASKETS

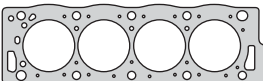









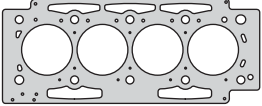

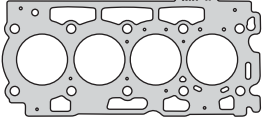

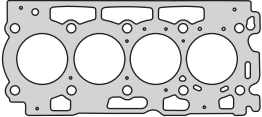

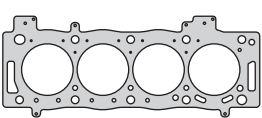

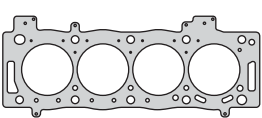

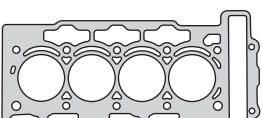

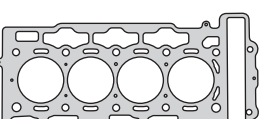
### MOTORES NAFTA Y DIESEL / PETROL AND DIESEL ENGINES

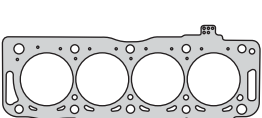
	Código Code	Q	≠	Kit Bulón Bolt Set	Aplicación Application	Motor Engine	Juego
<b>470307 - 470308</b> 	470307 470308	78.0 78.0	1.80 1.60	B470300  HAE14038	Citroën AX 15 1994/97, Saxo 1996/... Peugeot 106 1994/...	1527cc. TUD5 (VJY/VJZ) 55/58HP Ø77 (SOHC) 8V	470300-R  pág. 430
<b>470407 - 470408</b> 	470407 470408	76.0 76.0	1.80 1.60	B470400  HAE14038	Citroën AX 14 1988/94 Peugeot 106 1992/95	1360cc. TUD3(K9A) 50/52HP Ø75 (SOHC) 8V	470400-R  pág. 431
<b>470507 - 470508</b> 	470507-1.40 470507-1.60 470508-1.40 470508-1.60	80.0 80.0 80.0 80.0	1.40 1.60 1.40 1.60	B470500  HAE14038	Citroën ZX, Saxo 1996/..., Xsara 1997/... Peugeot 106 1994/..., 306 1993/... 206 1998/...	1587cc. TU5JP/J2 90/103HP Ø78.5 (SOHC) 8V	470501-R  pág. 432
<b>470607</b> 	470607-1M 470607-2M 470607-3M 470607-4M 470607-5M	84.0 84.0 84.0 84.0 84.0	1.26 1.30 1.34 1.38 1.42	B470600  HAE14038	Citroën Berlingo, Jumpy, Xsara 1998/... C5, Xsara, Jumpy 2000/... Peugeot 206, 306 1998/... Expert, Partner 1999/... <b>DIESEL</b>	1868cc. DW8 (WJZ/WJY) 71HP Ø82.2 (SOHC) 8V	470601-R  pág. 433
<b>460608</b> 	470608-1M 470608-2M 470608-3M 470608-4M 470608-5M	84.0 84.0 84.0 84.0 84.0	1.26 1.30 1.34 1.38 1.42	B470600  HAE14038	Citroën Berlingo, Jumpy, Xsara 1998/... C5, Xsara, Jumpy 2000/... Peugeot 206, 306 1998/... Expert, Partner 1999/... <b>DIESEL</b>	1868cc. DW8 (WJZ/WJY) 71HP Ø82.2 (SOHC) 8V	470601-R  pág. 433
<b>470707</b> 	470707-2M 470407-3M	82.0 82.0	1.65 1.80	B470700  HAT55055 HAT55100	Citroën BX 17 TD 1988/94 Peugeot 205 TD 1990/96, 405 TD 1988/94 309 TD 1990/93 <b>DIESEL</b>	1769cc. XUD7T/TE 78/90HP Ø80 (SOHC) 8V	460301-R (470700)  pág. 434
<b>470807</b> 	470807-1M 470807-2M 470807-3M 470807-4M 470807-5M	86.0 86.0 86.0 86.0 86.0	1.30 1.35 1.40 1.45 1.50	B470800  HAE14038	Citroën Xantia, Jumper, Xsara HDI 1998/... Berlingo, Evasion, Xsara Picasso, Jumper Dispatch HDI 1999/..., C5 HDI 2000/... Peugeot 306/406 HDI 1998/..., 206/806 Boxer, Expert, Partner HDI 1998/... 307, 607 2000/... <b>DIESEL</b>	1997cc. DW10TD/ATED 90/110HP DW10TD(RHV/RHY/RHX/RHZ) 90/94/110HP Ø85 (SOHC) 8V	470801-R  pág. 435
<b>470808</b> 	470808-1M 470808-2M 470808-3M 470808-4M 470808-5M	86.0 86.0 86.0 86.0 86.0	1.30 1.34 1.38 1.42 1.50	B470800  HAE14038	Citroën Xantia, Jumper, Xsara HDI 1998/... Berlingo, Evasion, Xsara Picasso, Jumper Dispatch HDI 1999/..., C5 HDI 2000/... Peugeot 306/406 HDI 1998/..., 206/806 Boxer, Expert, Partner HDI 1998/... 307, 607 2000/... <b>DIESEL</b>	1997cc. DW10TD/ATED 90/110HP DW10TD(RHV/RHY/RHX/RHZ) 90/94/110HP Ø85 (SOHC) 8V	470801-R  pág. 435
<b>470907</b> 	470907-1M 470907-2M 470907-3M 470907-4M 470907-5M 470907-6M	82.0 82.0 82.0 82.0 82.0 82.0	1.36 1.40 1.44 1.48 1.52 1.80	B460300  HAT55055 HAT55100	Citroën C15 1994/..., Berlingo 1996/99 Xsara 1997/..., ZX 1991/94 Peugeot 205/309 1983/96, 306 1993/... Partner 1996/... <b>DIESEL</b>	1769cc XUD7 (161A/A9A) 60HP Ø80 (SOHC) 8V	460301-R (470900)  pág. 436
<b>471007</b> 	471007	87.0	1.20	B471000  HAE14038	Citroën Xantia 1995/01, Xsara 1998/00 Evasion, Synergie 1998/... Peugeot 406, 605 1995/..., 306 1997/... 806 1998/01 <b>DIESEL</b>	1998cc. XU10J4R - XU10J4R (RFV) 132/135HP Ø86 (DOHC) 16V	471000-R  pág. 437

# PSA - PEUGEOT / CITROËN

## JUNTA TAPA DE CILINDROS / HEAD GASKETS

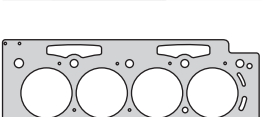
### MOTORES NAFTA Y DIESEL / PETROL AND DIESEL ENGINES

	Código Code	Q	≠	Kit Bulón Bolt Set	Aplicación Application	Motor Engine	Juego
	<b>471207 - 471208</b> 471207 471208	86.0 85.5	1.20 0.65	<b>B471200</b>  HAE14038	Citroën Jumpy, Dispatch, Xsara Evasion 1998/..., C5/C5 HPI 2001/... C8 2002/..., C4 2004/..., Xsara Picasso Peugeot 206/307/406/806/807 Expert 2000/..., 406 HPI, 607 2001/... 407 2004/...	<b>1997cc.</b> EW10J4 (RFN-RLZ) 136/140HP Ø85 (DOHC) 16V	<b>471200-R MLS</b>  pág. 438
	<b>471307</b> 471307-1M 471307-2M 471307-3M 471307-4M 471307-5M	76.0 76.0 76.0 76.0 76.0	1.20 1.30 1.40 1.45 1.50	<b>B302100</b>  HAE14038	Peugeot 207 Compact  Citroën Xsara, Picasso TD 1999/... C4/C5 TD 2004/... Peugeot 307 HDI, 407 TD 2004/...	<b>1398cc.</b> DV6TED4 70HP Ø75 <b>1560cc.</b> DV6TED4 109HP DV6TED4(9HZ) 108HP Ø75 (DOHC) 16V	<b>471301-R</b>  pág. 439
	<b>471308</b> 471308-1M 471308-2M 471308-3M 471308-4M 471308-5M	76.0 76.0 76.0 76.0 76.0	1.25 1.30 1.35 1.40 1.45	<b>B302100</b>  HAE14038	Peugeot 207 Compact  Citroën Xsara, Picasso TD 1999/... C4/C5 TD 2004/... Peugeot 307 HDI, 407 TD 2004/...	<b>1398cc.</b> DV6TED4 70HP Ø75 <b>1560cc.</b> DV6TED4 109HP DV6TED4(9HZ) 108HP Ø75 (DOHC) 16V	<b>471301-R</b>  pág. 439
	<b>471408</b> 471408-1M 471408-2M 471408-3M 471408-4M	86.0 86.0 86.0 86.0	1.25 1.30 1.35 1.40	<b>B470800</b>  HAE14038	Citroën C4/C5 HDI 2004/... C4 Picasso HDI, C8 HDI 2006/... C4 HDI FAP 2007/... Peugeot 307 HDI FAP 2003/... 407 HDI 2004/..., Expert HDI 2007/... 807 HDI 2006/...	<b>1997cc.</b> DW10BTED4 (RHR/RHK) 136HP Ø85 (DOHC) 16V	<b>471401-R</b>  pág. 440
	<b>471408</b> 471408-1M 471408-2M 471408-3M 471408-4M	86.0 86.0 86.0 86.0	1.25 1.30 1.35 1.40	<b>B470800</b>  HAE14038	Citroën Evasion HDI 2000/..., C8 HDI Jumpy HDI 2002/... Peugeot 806, Expert 99/..., 807 HDI 00/... Citroën C5 2001/..., C8 HDI 2002/... Peugeot 607, 406 00/..., 807 HDI 2002/...	<b>1997cc.</b> DW10ATED4 (RHW/RHT) 109HP (DOHC) 16V Ø85 <b>2179cc.</b> DW12TED4 (4HX) 133HP (DOHC) 16V Ø85	<b>471501-R</b>  pág. 441
	<b>471707 - 471708</b> 471707 471708	78.0 78.0	1.20 0.60	<b>B471700</b>  HAE14038	Citroën C3 Picasso, C3 2009/... , DS3 2010/... Peugeot 207/308, 207/308 SW 2007/... Citroën C4/C4 Coupe, C4/C3 Picasso 2008/..., Berlingo, DS3 2010/... Peugeot 207/308, 207/308 SW 2007/... Partner 2008/..., 3008, 5008 2009/...	<b>1397cc.</b> EP3 (8FS/8FP) - EP3C (8F01) (DOHC) 16V 95HP Ø77 <b>1598cc.</b> EP6 (5FW/5FS) - EP6C (5F01) (DOHC) 16V 120HP Ø77	<b>471700-R MLS</b>  pág. 442
	<b>471807 - 471808</b> 471807 471808	78.0 78.0	1.20 0.90	<b>B471700</b>  HAE14038	Citroën C4, C4 Grand Picasso C4 Picasso 2008/..., C5, C5 Tourer 2009/... DS3 2010/... Peugeot 207, 207 CC, 308, 308 SW 2007/... 3008 2009/..., 508, 508 SW, 5008 RCZ 2010/...	<b>1598cc.</b> EP6DT (5FX/5FR/5FV/5FT) EP6CDT (5F04) EP6DTS (5FY) 150/156/163HP (DOHC) 16V Ø77	<b>471800-R MLS</b>  pág. 443
	<b>471907</b> 471907-1M 471907-2M 471907-3M	87.0 87.0 87.0	1.30 1.40 1.50	<b>B470800</b>  HAE14038	Citroën C5, C5 HDI, C5 Tourer 2009/... C4 Picasso, C4 Grand Picasso 2010/... Peugeot 308 HDI -308 SW HDI 2007/... 308 CC HDI, 407 Coupe HDI, 3008 HDI 407 HDI, 407 SW HDI, 5008 HDI Expert Tepee, Expert 3 2009/...	<b>1997cc</b> DW10CTED4 (RH02/RHH) 163HP Ø85 (DOHC) 16V	<b>471901-R</b>  pág. 444
	<b>471908</b> 471908-1M 471908-2M 471908-3M 471908-4M	86.0 86.0 86.0 86.0	1.25 1.30 1.35 1.40	<b>B470800</b>  HAE14038	Citroën C5, C5 HDI, C5 Tourer 2009/... C4 Picasso, C4 Grand Picasso 2010/... Peugeot 308 HDI -308 SW HDI 2007/... 308 CC HDI, 407 Coupe HDI, 3008 HDI 407 HDI, 407 SW HDI, 5008 HDI Expert Tepee, Expert 3 2009/...	<b>1997cc</b> DW10CTED4 (RH02/RHH) 163HP Ø85 (DOHC) 16V	<b>471901-R</b>  pág. 444
	<b>472007 - 472008</b> 472007 472008	86.0 86.0	1.20 0.70	<b>B472000</b>  HAE14038	Citroën C4, C5 2005/... C4 Grand Picasso 2006/... C4 Picasso, Jumpy III 2007/... Peugeot 307, 407, 807 2005/... Expert 2007/..., 408 2011/...	<b>1997cc.</b> EW10A (RFJ/RFH) 136/140HP Ø85 (DOHC) 16V	<b>472000-R MLS</b>  pág. 445



# PSA - PEUGEOT / CITROËN

## JUNTA TAPA DE CILINDROS / HEAD GASKETS

### MOTORES NAFTA Y DIESEL / PETROL AND DIESEL ENGINES

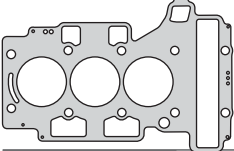
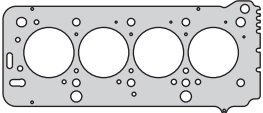
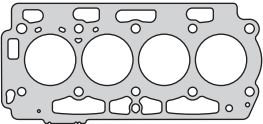
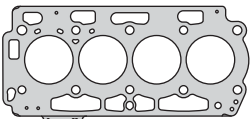
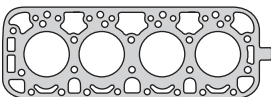
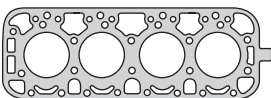
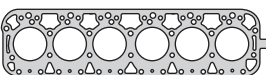
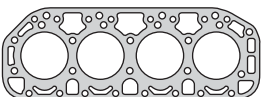
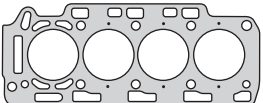
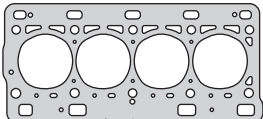
	Código Code	Q	≠	Kit Bulón Bolt Set	Aplicación Application	Motor Engine	Juego
	472107 - 472108 472107 472108	76.0 76.0	1.20 0.60	B472100 HAE12038	Citroën C4 Cactus, C4 Grand Picasso 2014/..., C3 Picasso, DS3, DS4 2015/... C4 Picasso 2016/... Peugeot 208 2012/..., 108 2014/... 2008, 3008, 5008 2013/... Partner 2016/...	1199cc. EB2DTS (HNY) 130HP EB2DT (HNZ) 110HP Ø75 (DOHC) 12V	472100-R MLS 🚗 pág. 446
	472207 - 472208 472207 472208	77.0 77.0	1.20 0.60	B470500 HAE14038	Citroën C3 2012/... Peugeot 208 2012/...	1499cc. TU4M 89/93HP Ø75 (SOHC) 8V	472200-R MLS 🚗 pág. 447
	472307 472307-1M 472307-2M 472307-3M 472307-4M 472307-5M	76.0 76.0 76.0 76.0 76.0	1.20 1.30 1.40 1.50 1.60	B302100 HAE14038	Citroën C3 HDI, DS3 HDI 2009/... Peugeot Partner, 308, 207 HDI 308 HDI 2009/..., 3008 2009/... 5008 2010/... <b>DIESEL</b>	1560cc. DV6C 92HP DV6DTE 112HP Ø75 (SOHC) 8V	472301-R 🚗 pág. 448
	472308 472308-1M 472308-2M 472308-3M 472308-4M 472308-5M	76.0 76.0 76.0 76.0 76.0	1.25 1.30 1.35 1.40 1.45	B302100 HAE14038	Citroën C3 HDI, DS3 HDI 2009/... Peugeot Partner, 308, 207 HDI 308 HDI 2009/..., 3008 2009/... 5008 2010/... <b>DIESEL</b>	1560cc. DV6C 92HP DV6DTE 112HP Ø75 (SOHC) 8V	472301-R 🚗 pág. 448
	500205 - 500207 - 500208 500205 500206 500207 500208	92.0 92.0 92.0 92.0	1.40 2.40 1.40 1.70	B500200 HAS17038	Peugeot 404, T4B, T5B Rastrojero 1972/... <b>DIESEL</b>	1948cc. XD/XDP 4.88 50/59HP Ø88	500200-R 🚗 pág. 449
	500707 - 500907 500707 500907	98.5 92.0	1.40 1.40	B500200 HAS17038	Peugeot 404, T4B, T5B Rastrojero 1972/... <b>DIESEL</b>	1948cc. XD/XDP 4.88 50/59HP Ø88	500200-R 🚗 pág. 449
	500305 - 500307 500305 500307	94.0 94.0	1.40 1.40	B500300 HAE17038	Peugeot Pick Up Camiónes Livianos 1976/... <b>DIESEL</b>	3168cc. XDP 6.90 95HP Ø90	500300-R 🚗 pág. 451
	500605 500605	94.0	1.70	B500200 HAS17038	Peugeot 504 1980/..., J7/J9 1980/87 Adaptables Pick Up <b>DIESEL</b>	2112cc. XD-XDP 4.90 59HP Ø90	500600-R 🚗 pág. 452
	550605 - 550607 550605 550607	89.0 89.0	1.40 1.20	B461200 HAS19038	Peugeot 505 Inyección ZEJ 1979/... Peugeot 505 GTI ZDJ 1982/91	1995cc. ZEJ 110HP Ø88 2165cc. ZDJ 123HP Ø88 (SOHC) 8V	461200-R 🚗 pág. 426
	581005 - 501007 - 501008 581005 581007 581007-1.40 581008	70.0 70.0 70.0 70.0	1.30 1.20 1.40 0.35	B581000 HAE12038	Peugeot 206 2000/...	999cc D4D 70HP Ø69 (DOHC) 16V	581000-R MLS 🚗 pág. 504

**CITROËN**



Motor/Engine	Cm³	HP	Ø
A 79/0 (OHV) 4V	425	24	66

Citroën: 2CV, AZ, AZAM, AZN, AZU, AZUB  
1966/68



Nº OE	Descripción/Description	Mat.	Ref.
	<b>Jgo. de juntas para motor</b>		<b>150000-R</b>
A-132-3	Junta tapa válvulas	GS 2	150010
AM-141-2A	Jgo. múltiple escape (2)	FCH 1	150015
	Jgo. juntas carburador	VS	150020
54-590	Base carburador	NB 2	150025
	Tapa carburador	CB	150026
	Bomba aceite	CB 1	150027
	Junta bomba de nafta	NB	150028
	Bomba nafta	NB 2	550428
	Arandela tapón cárter B 16 x 22 x 3 CN	CU	150029
	Arandela doble racord	CU 2	150031
	Arandela flexible frenos A 13 x 18 x 1 CN	CN	150032
	Arandela flexible frenos A 10.2 x 18 x 1 CN	CN	150033
	Arand. radiador aceite chica B 14 x 18 x 2 CN	CN	150034
	Arand. radiador aceite grande B 16 x 22 x 2.4 CN	CN	150035
	Arandela culata cilindros A 8 x 14 x 1 C	CU 4	150036
	Arand. tapón cárter supermed. A 18 x 23 x 1C	CU	150037
A-221-92	Tubo llenado	NB 1	150038
	Tapa platino	CG 1	150039
	Tambor frenos	CB	150040
	Tambor frenos	NB	150041
	Bomba aceite	NB	150042
AW-331-86	Salida caja 4 agujeros	CB	150043
A-224-956	Envolverte varilla balancines	GS 2	150044
	Arandela bulbo presión aceite A 12 x 16 x 1C	CU	150045
	Brazo suspensión	CB	150046
A-331-7	Cárter caja velocidades	CG 1	150050
	Arandela A 14 x 18 x 1.5 A	AL 4	
	Arandela A 16 x 22 x 1.5 A	AL 1	
	Kit de retenes completo		R150000
	Jgo. retén válvulas (4)	P 1	R150010P
	Retén bancada 48 x 65 x 10	N 1	R150011N
	Retén distribución 30 x 42.04 x 8	N 1	R150012N

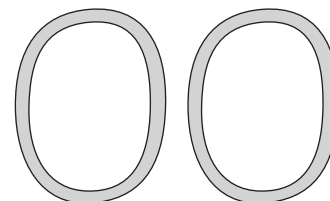

150010

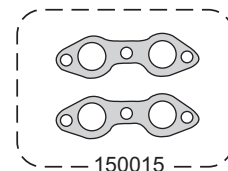

150015

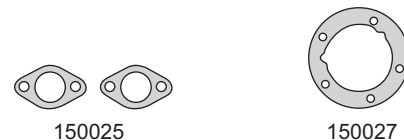

150025

150027

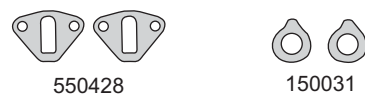

550428

150031



150038

150039

150044

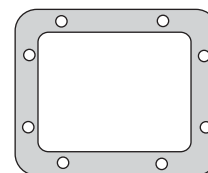

150050



A 14 x 18 x 1.5 A

A 8 x 14 x 1C



A 16 x 22 x 1.5 A



R150011N



R150012N

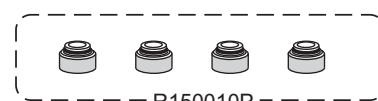

R150010P

**CITROËN**



Motor/Engine	Cm³	HP	Ø
A 79/1 (OHV) 4V	425	28	66

Citroën: 2CV, AZL 1968/69

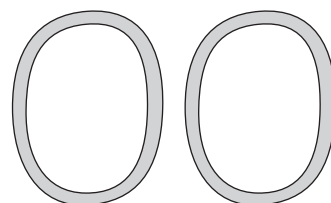

150010

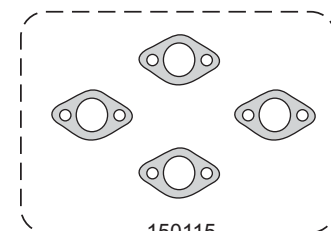

150115

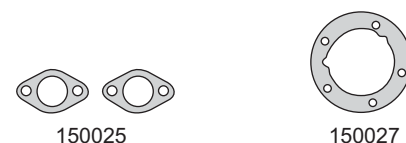

150025

150027



550428

150031



150038

150039

150044

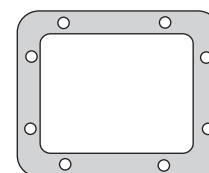

150050



A 14 x 18 x 1.5 A

A 8 x 14 x 1C



A 16 x 22 x 1.5 A



R150011N

R150012N

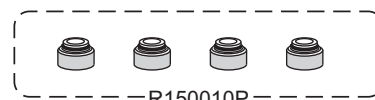

R150010P

Nº OE	Descripción/Description	Mat.	Ref.
	<b>Jgo. de juntas para motor</b>		<b>150100-R</b>
A-132-3	Junta tapa válvulas	GS	2 150010
AM-141-2A	Jgo. múltiple escape (4)	FCH	1 150115
	Jgo. juntas carburador	VS	150020
54-590	Base carburador	NB	2 150025
	Tapa carburador	CB	150026
	Bomba aceite	CB	1 150027
	Bomba nafta	NB	2 550428
	Arandela tapón cárter B 16 x 22 x 3 C	CU	150029
	Arandela doble raccord	CU	2 150031
	Arandela flexible frenos A 13 x 18 x 1 CN	CN	150032
	Arandela flexible frenos A 10 x 18 x 1 CN	CN	150033
	Arand. radiador aceite chica B 14 x 18 x 2 CN	CN	150034
	Arand. rad. aceite grande B 16 x 22 x 2.4 CN	CN	150035
	Arandela culata cilindros A 8 x 14 x 1 C	CU	4 150036
	Arand. tapón cárter supermedida A 18 x 23 x 1 C	CU	150037
A-221-92	Tubo llenado	NB	1 150038
	Tapa platino	CG	1 150039
	Tambor frenos	CB	150040
	Tambor frenos	NB	150041
	Bomba aceite	NB	150042
AW-331-86	Salida caja 4 agujeros	CB	150043
A-224-956	Envolvente varilla balancines	GS	2 150044
	Arandela bulbo presión aceite A 12 x 16 x 1 C	CU	150045
	Brazo suspensión	CB	150046
A-331-7	Cárter caja velocidades	CG	1 150050
	Arandela A 14 x 18 x 1.5 A	AL	4
	Arandela A 16 x 22 x 1.5 A	AL	1
	Kit de retenes completo		R150000
	Jgo. retén válvulas (4)	P	1 R150010P
	Retén bancada 48 x 65 x 10	N	1 R150011N
	Retén distribución 30 x 42.04 x 8	N	1 R150012N

**CITROËN**



Motor/Engine	Cm³	HP	Ø
M28/0 - M28/1 (OHV) 4V	602	35	74

Citroën: 3CV 1969/78



Nº OE	Descripción/Description	Mat.	Ref.
	<b>Jgo. de juntas para motor</b>		<b>150200-R</b>
AM-132-3A	Junta tapa válvulas	GS 2	150210
AM-141-2E	Jgo. múltiple escape (2)	NB 1	150215
AM-141-2D	Jgo. múltiple admisión (2)	NB 1	150217
	Jgo. juntas carburador 1ra. Serie	VS	150220
	Jgo. juntas carburador 2da. Serie	VS	150221
58-113	Base carburador	NB	150225
	Base carburador	NB 1	450025
	Tapa carburador 1ra. Serie	CB	150226
AM-222-17	Bomba aceite	CB 1	150027
	Bomba nafta	NB 2	550428
	Arandela doble racord	CU 3	150031
	Tapa carburador 2da. Serie	CB	150231
	Base carburador	NB	150232
	Jgo. juntas admisión y escape	NB	150233
	Arandela culata cilindros A 8 x 14 x 1 C	CU 6	150036
AM-221-923	Tubo llenado	NB 1	150338
	Tapa platino	CG 1	150039
	Mandíbula	CB	150241
	Mandíbula	NB	150242
AM-224-95B	Envolvente varilla balancines	GS 2	150244
	Tubo radiador aceite	GS 2	150245
	Tamiz aceite G 54 x 2	GS 1	150246
	Bomba aceite G 12.42 x 1.78	GS 1	150247
A0331-07	Cárter caja velocidades	CG 1	150050
	Kit de retenes completo		R150200
	Jgo. retén válvulas (4)	P 1	R150010P
	Retén bancada 55.95 x 69.1/70 x 10	N 1	R150211N
	Retén distribución 30 x 42.04 x 8	N 1	R150012N

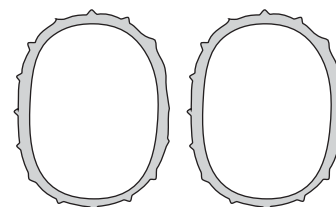

150210

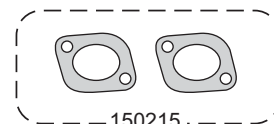

150215

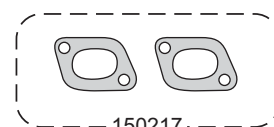

150217



150225

450025

150226

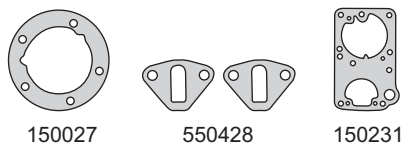

150027

550428

150231



150031

150232

150039

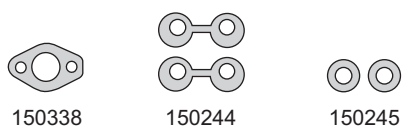

150338

150244

150245

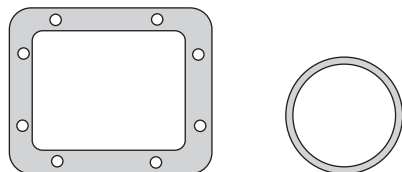

150050

G 54 x 2

G 12.42 x 1.78

A 8 x 14 x 1C



R150211N

R150012N

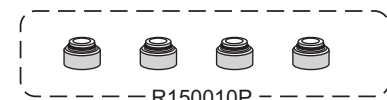

R150010P

**CITROËN**



Motor/Engine	Cm³	HP	Ø
M28/0 - M28/1 (OHV) 4V	602	33	74

Citroën: Ami 8, Mehari, Dyane, 3CV



Nº OE	Descripción/Description	Mat.	Ref.
	<b>Jgo. de juntas para motor</b>		<b>150300-R</b>
AM-132-3A	Junta tapa válvulas	GS	2 150210
AM-141-2E	Jgo. múltiple escape (2)	NB	1 150215
AM-141-2D	Jgo. múltiple admisión (2)	NB	1 150217
	Jgo. juntas carburador 1ra. Serie	VS	150320
	Jgo. juntas carburador 2da. Serie	VS	150321
58-113	Base carburador	NB	150225
	Base carburador	NB	1 450025
	Base carburador	CB	2 150325
	Tapa carburador 1ra. Serie	CB	150326
AM-222-17	Bomba aceite	CB	1 150027
	Bomba nafta	NB	2 550428
	Arandela doble racord	CU	3 150031
	Base carburador	NB	150331
	Tapa carburador 2da. Serie	NB	150332
	Jgo. juntas admisión y escape	NB	150233
	Arandela culata cilindros A 8 x 14 x 1 C	CU	6 150036
AM-221-923	Tubo llenado	NB	1 150338
	Tapa platino	CG	1 150039
AM-224-95B	Envolvente varilla balancines	GS	2 150244
	Salida caja 6 agujeros	CB	150344
	Tubo radiador aceite	GS	2 150245
	Salida caja 6 agujeros	NB	150345
	Tamiz aceite G 54 x 2	GS	1 150246
	Bomba aceite G 12.42 x 1.78	GS	1 150247
A-331-7	Cárter caja velocidades	CG	1 150050
	Kit de retenes completo		R150200
	Jgo. retén válvulas (4)	P	1 R150010P
	Retén bancada 55.95 x 69.1/70 x 10	N	1 R150211N
	Retén distribución 30 x 42.04 x 8	N	1 R150012N

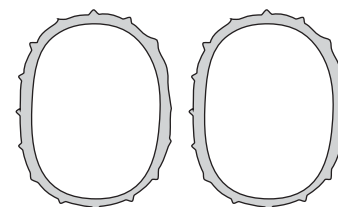

150210

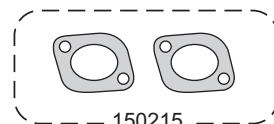

150215

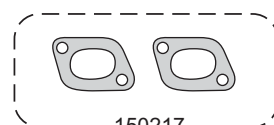

150217

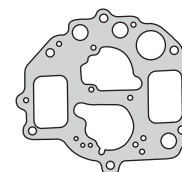

150326



150225

450025

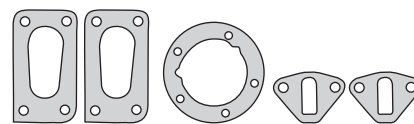

150325

150027

550428

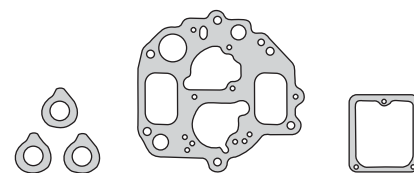

150031

150332

150039

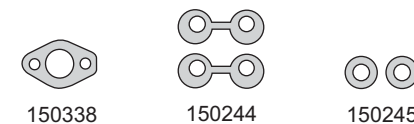

150338

150244

150245

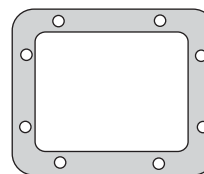

150050

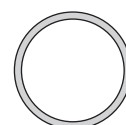

G 54 x 2



A 8 x 14 x 1C



G 12.42 x 1.78



R150211N



R150012N

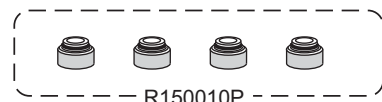

R150010P

















PEUGEOT



Motor/Engine	Cm³	HP	Ø
XC7 - XC7P (OHV) 8V	1618	59	84

Peugeot: 404 1962/80



Nº OE	Descripción/Description	Mat.			Ref.
0199.421	Jgo. de juntas para motor				450000-R
0199.414	Jgo. de juntas superior		●	●	450095
0203.240	Junta tapa cilindros Ø 86.5 ± 1.40		NFT	1	450005
0203.240	Junta tapa cilindros Ø 86.5 ± 2.40		NFT		450006
	Jgo. tornillos tapa cilindros (HAS19038)				B450000
0249.140	Conj. junta tapa válvulas (11)		N	1	450010
0304.030	Junta para cárter		CG	1	450011
0321.110	Tapa distribución		CG	1	450012
0321.110	Tapa distribución		CG		450112
0322.040	Placa distribución		CB	1	450013
1206.080	Bomba de agua		NB	1	450014
0349.030	Jgo. múltiple escape (4)		FCH	1	450015
0348.060	Múltiple admisión		NB	1	450017
1710.070	Salida de escape 1B		FCH	1	450018
1710.100	Salida de escape 2B		FCH	1	450118
1410.070	Jgo. juntas carburador SOLEX 34 PBICA		VS		450020
1406.340	Base carburador		NB	1	450025
1406.120	Tapa carburador		CB		450026
1104.040	Bomba aceite a block		CB	1	450027
1451.031	Base bomba nafta		CB	2	450028
0313.020	Arandela tapón cárter B 18 x 24 x 2.3 CN		CN		450029
	Arandela blindada B 16 x 22 x 2.4 CN		CN		450229
1166.020	Arandela cañería aceite a tapa cilin. A 8 x 14 x 1 C		CU	4	450030
1458.030	Tapa bomba nafta		CG		450031
1179.060	Tubo llenado aceite		CG	1	450032
0213.030	Arandela capuchón bujías		GS	4	450033
0253.050	Tubo separador balancines		GS	2	450034
	Respiradero carter		CG	1	500234
0127.050	Bastón retén bancada		GS	2	450035
6462.070	Grifo calefactor		NB		450036
1474.030	Cuerpo bomba nafta		CG		450037
5907.001	Base distribuidor		CB	1	450038
1031.030	Tórico bomba aceite G 12.42 x 1.78		GS	1	450039
1458.030	Vaso nafta		CG	1	450041
1528.070	Flotante tanque nafta		CG		450042
1451.031	Base bomba nafta		NB		450043
	Avance distribuidor		NB		450044
1912.001	Vaso filtro nafta		CG		450045
1104.040	Bomba aceite a block		NB	1	450048
2599.160	Jgo. juntas caja velocidades C3B		CB		450050
	Jgo. juntas caja velocidades BA7 71/...		CB		450350
	Tapa trasera s/fin diferencial		CB		450054
	Jgo. juntas diferencial 62/67 (4)		CB		450055
	Jgo. juntas diferencial 67/80 (4)		CB		450155
3040.071	Tubo empuje 62/67		CB		450056
3040.072	Tubo empuje 67/80		CB		450156
4222.060	Palier		CB		450057
	Cierre diferencial ancha 62/7		CB		450059
0304.030	Junta para cárter		CG		450060
	Cierre diferencial angosta 62/7		CB		450062
0112.170	Jgo. suplemento camisas cilindros (4)		GS	1	450070
	Suplemento tapa cilindros		AL		450085
	Arandela A 16 x 22 x 1.5 A		AL	1	

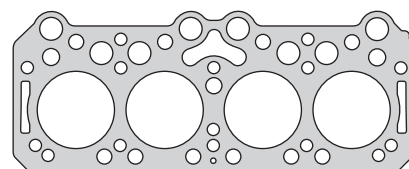

450005

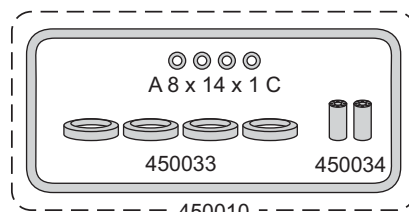

450010

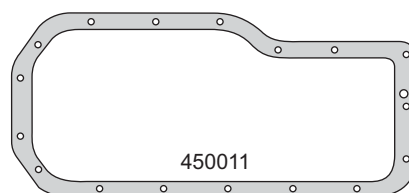

450011

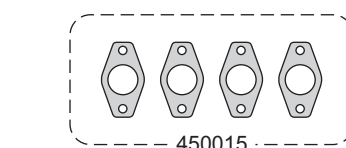

450015

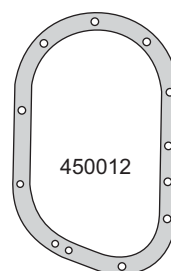

450012

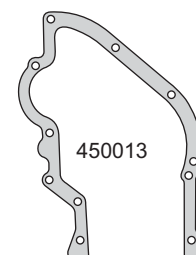

450013



450014

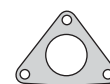

450017



450018



450118



450025



450027



450032



450028



500234



450035



450036



450037



450038



450048



450041

**PEUGEOT**



Motor/Engine	Cm³	HP	Ø
XC7 - XC7P (OHV) 8V	1618	59	84

Peugeot: 404 1962/80



Nº OE	Descripción/Description	Mat.	Ref.
	Arandela A 18 x 24 x 1.5 A	1	
	Kit de retenes completo		R450000
	Jgo. retén válvulas (8)	T	R450010T
0517.001	Jgo. retén válvulas (8)	P	1 R450010P
	Retén distribución 42 x 60 x 10	P	1 R450012P

○ A 16 x 22 x 1.5 A      ○ ○ A 18 x 24 x 1.5 A

○  
G 12.42 x 1.78

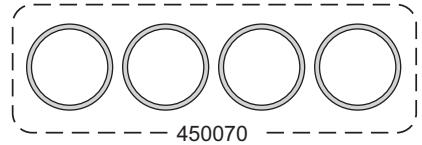

450070



R450012P

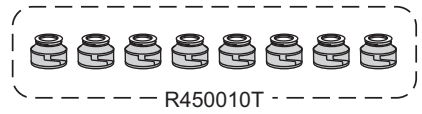

R450010T

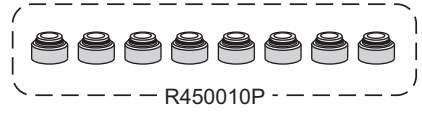

R450010P

**PEUGEOT**



Motor/Engine **Cm³** **HP** **Ø**

**XC7-XC6A** **1657** **59** **85**

Peugeot: 504 GLS/GLSE 1969/80



Nº OE	Descripción/Description	Mat.		Ref.
	Jgo. de juntas para motor			450100-R
	Jgo. de juntas superior			450195
0203.240	Junta tapa cilindros Ø 86.5 ± 1.40	NFT	1 1	450005
0203.240	Junta tapa cilindros Ø 86.5 ± 2.40	NFT		450006
	Jgo. tornillos tapa cilindros (HAS19038)			B450000
0249.140	Conj. junta tapa válvulas (11)	N	1 1	450010
0304.030	Junta para cárter	CG		450011
0321.110	Tapa distribución	CG		450012
0321.110	Tapa distribución	CG		450112
0322.240	Placa distribución	CB	1	450013
1206.080	Bomba de agua	NB	1 1	450014
0349.030	Jgo. múltiple escape (4)	FCH	1 1	450015
0348.181	Múltiple admisión	CB	1 1	450117
1710.070	Salida de escape	FCH	1 1	450018
1710.100	Salida de escape 2B	FCH	1 1	450118
1410.082	Jgo. juntas carburador SOLEX 34 PAIA-2	VS		450120
1405.006	Base carburador	NB	2 2	450125
1406.121	Tapa carburador	CB		450126
1104.040	Bomba aceite a block	CB		450027
1451.031	Base bomba nafta	CB	2	450028
0313.030	Arandela tapón cárter B 18 x 24 x 2.3 CN	CN		450029
	Arandela blindada B 16 x 22 x 2.4 CN	CN		450229
1166.020	Arandela cañería aceite a tapa cilin. A 8 x 14 x 1 C	CU	4 4	450030
1179.040	Tubo llenado aceite	CG		450032
0213.030	Arandela capuchón bujías	GS	4 4	450033
0253.050	Tubo separador balancín	GS	2 2	450034
1179.060	Respiradero cárter	CG		500234
0127.150	Bastón retén bancada	GS	2	450035
5907.001	Base distribuidor	CB	1	450038
1031.030	Tórica bomba aceite o'ring G 12.42 x 1.78	GS	1	450039
1458.030	Vaso nafta	CG	1	450041
1528.070	Flotante tanque nafta	CG		450042
1451.031	Base bomba nafta	NB		450043
	Avance distribuidor	NB		450044
1912.001	Base filtro nafta	CG		450045
1104.040	Bomba aceite a block	NB	1	450048
2599.160	Jgo. juntas caja velocidades C3B	CB		450050
	Jgo. juntas caja de velocidades BA7	CB		450350
	Tubo empuje sin fin diferencial	CB		450054
3298.030	Jgo. juntas diferencial 67/80	CB		450155
3040.072	Tubo empuje 67/80	CB		450156
4222.060	Palier	CB		450057
	Cierre diferencial ancha 67/80	CB		450159
0304.030	Junta para cárter	CG		450060
	Cierre diferencial angosto 67/80	CB		450162
0112.170	Jgo. suplemento camisas cilindros (4)	GS		450070
	Arandela A 16 x 22 x 1.5 A	AL	1	
	Arandela A 18 x 24 x 1.5 A	AL	1 2	
	Kit de retenes completo			R450000
	Jgo. retén válvulas (8)	T		R450010T
	Jgo. retén válvulas (8)	P	1	R450010P
0517.001	Retén distribución 42 x 60 x 10	P	1	R450012P

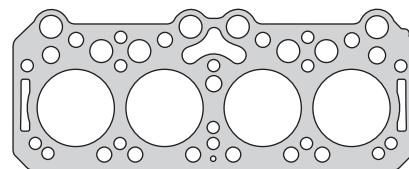

450005

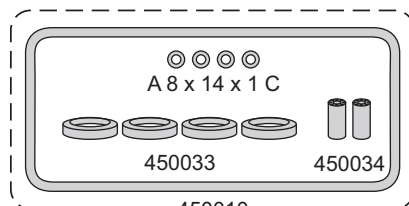

450010

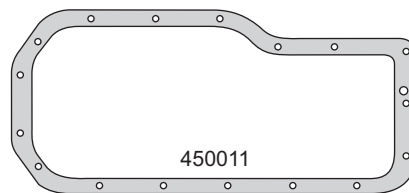

450011

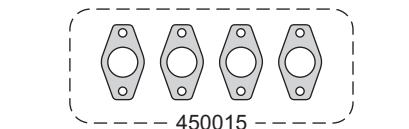

450015

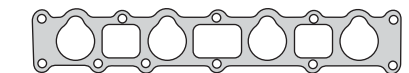

450117

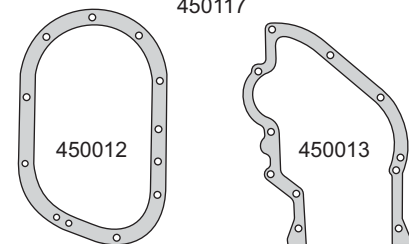

450012

450013

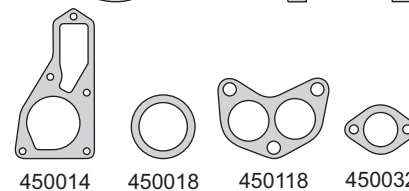

450014

450018

450118

450032

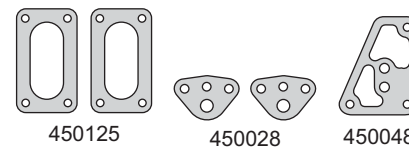

450125

450028

450048

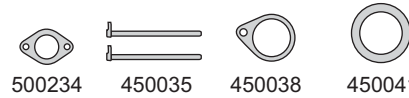

500234

450035

450038

450041



A 16 x 22 x 1.5 A

A 18 x 24 x 1.5 A



G 12.42 x 1.78

R450012P

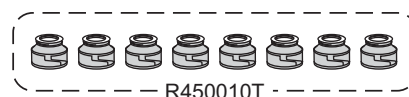

R450010T

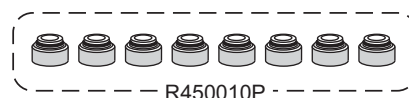

R450010P



# PEUGEOT



Motor/Engine	Cm³	HP	Ø
XC7 - XM7 (OHV) 8V	1796	69/79	85

Peugeot: 504 XE/XL/XSE 1973/78



Nº OE	Descripción/Description	Mat.	Ref.
0199.416	Jgo. de juntas para motor		450200-R
	Jgo. de juntas superior		450295
0203.450	Jta. tapa cilindros Ø 86.5 ± 1.40	NFT 1 1	450205
0203.450	Jta. tapa cilindros Ø 86.5 ± 2.40	NFT	450206
	Jta. tapa cilindros Ø 86.5 ± 1.40 NR	NFT	450207
	Jgo. tornillos tapa cilindros (HAS19038)		B450200
0249.140	Conj. junta tapa válvulas (11)	N 1 1	450010
0304.070	Junta para cárter	CG 1	450211
0321.110	Tapa distribución	CG 1	450012
0321.110	Tapa distribución	CG	450112
0322.040	Placa distribución	CB 1	450013
1206.080	Bomba de agua	NB 1 1	450014
0349.030	Jgo. múltiple escape (4)	FCH 1 1	450015
0348.181	Múltiple admisión	CB 1 1	450117
1710.100	Salida de escape	FCH 1 1	450118
1410.082	Jgo. juntas carburador SOLEX 34 PAIA-2	VS	450120
1410.072	Jgo. juntas carburador SOLEX C-34 EIES	VS	450220
	Base carburador	NB 1	450025
1405.006	Base carburador	NB 2 2	450125
1406.121	Tapa carburador SOLEX 34 PAIA	CB	450126
1406.122	Tapa carburador SOLEX 34 EIES	CB	450226
1104.040	Bomba aceite a block	CB	450027
1451.031	Base bomba nafta	CB 2	450028
	Arandela tapón cárter B 18 x 24 x 2.3 CN	CN	450029
0164.030	Arandela blindada B 16 x 22 x 2.4 CN	CN	450229
1166.020	Arandela para tapa válvulas A 8 x 14 x 1 C	CU 4 4	450030
1458.030	Tapa bomba nafta	CG	450031
1406.131	Base filtro aire	CB	450231
1179.040	Tubo llenado aceite	CG 1	450032
0213.030	Arandela capuchón bujías	GS 4 4	450033
0253.050	Tubo separador balancines	GS 2 2	450034
1179.060	Respiradero cárter	CG 1	500234
0127.050	Bastón cierre bancada	GS 2	450035
6462.070	Grifo calefactor	NB	450036
1474.030	Cuerpo bomba nafta	CG	450037
5907.001	Base distribuidor	CB 1	450038
1031.030	Tórica bomba aceite o'ring G 12.42 x 1.78	GS 1	450039
1528.070	Flotante tanque nafta	CG	450042
1451.031	Base bomba nafta	NB	450043
	Avance distribuidor	NB	450044
1104.040	Bomba aceite a block	NB 1	450048
3298.030	Jgo. juntas diferencial 67/80	CB	450155
	Tubo empuje 67/80	CB	450156
4222.060	Palier	CB	450057
	Cierre diferencial ancho 67/80	CB	450159
0304.070	Junta para cárter	CGT	450260
	Cierre diferencial angosta 67/80	CB	450162
3298.030	Jgo. suplemento camisa cilindros (0.050) (4)	CU	450270-0.050
0112.590	Jgo. suplemento camisa cilindros (0.075) (4)	CU	450270-0.075
0112.570	Jgo. suplemento camisa cilindros (0.100) (4)	CU 1	450270-0.100
0112.580	Jgo. suplemento camisa cilindros (0.125) (4)	CU	450270-0.125
	Jgo. juntas caja de velocidades BA7	CB	450350
	Palier 7 4B	CB	450257

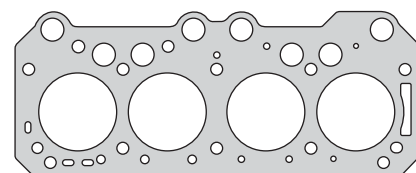

450205

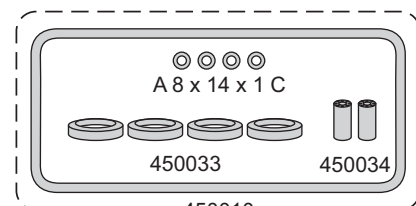

450010

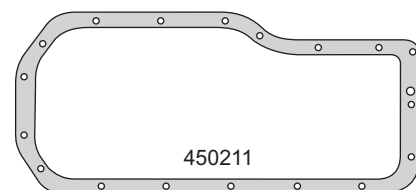

450211

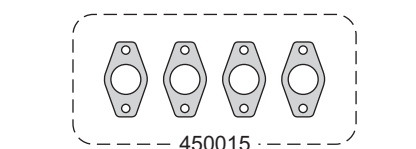

450015

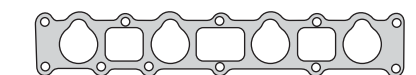

450117

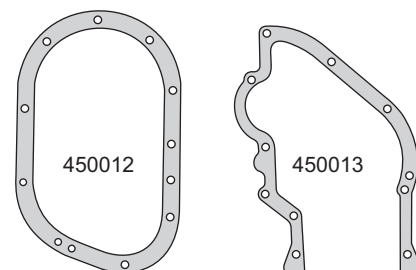

450012

450013

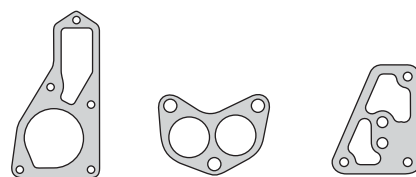

450014

450118

450027

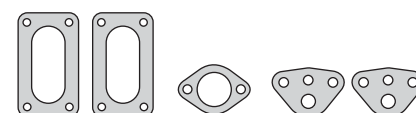

450125

450025

450028

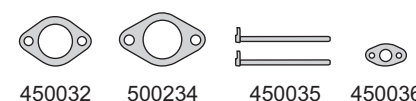

450032

500234

450035

450036



450037

450038

450048

**PEUGEOT**



Motor/Engine	Cm³	HP	Ø
XC7 - XM7 (OHV) 8V	1796	69/79	85

Peugeot: 504 XE/XL/XSE 1973/78

N° OE	Descripción/Description	Mat.			Ref.
	Tubo empuje 1981/...	CB			450156
	Arandela A 16 x 22 x 1.5 A	AL		1	
	Arandela A 18 x 24 x 1.5 A	AL	1	2	
	Kit de retenes completo				R450000
	Jgo. retén válvulas (8)	T			R450010T
	Jgo. retén válvulas (8)	P		1	R450010P
0517.001	Retén distribución 42 x 60 x 10	P		1	R450012P

○ A 16 x 22 x 1.5 A      ○ ○ A 18 x 24 x 1.5 A

○ G 12.42 x 1.78

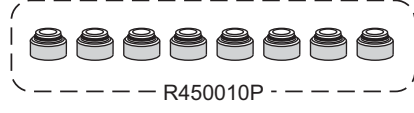
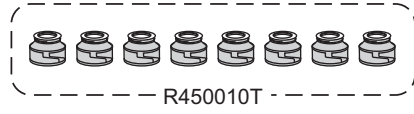
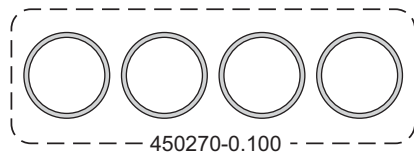

# PEUGEOT



Motor/Engine	Cm³	HP	Ø
XN1 - XN2 (OHV) 8V	1971	78/85	88

Peugeot: 504 TN/GES/XNA 1976/80



Nº OE	Descripción/Description	Mat.	Ref.
0199.413	Jgo. de juntas para motor		450300-R
0199.418	Jgo. de juntas superior		450395
0203.460	Jta. tapa cilindros Ø 90.0 ± 1.40	NFT 1 1	450305
0203.460	Jta. tapa cilindros Ø 90.0 ± 2.40	NFT	450306
0203.460	Jta. tapa cilindros Ø 90.0 ± 1.40 NR	NFT	450307
	Jgo. tornillos tapa cilindros (HAS19038)		B450200
	Jgo. tornillos tapa cilin. (HAT55055/55100)		B460200
0249.140	Conj. junta tapa válvulas (11)	N 1 1	450010
0304.070	Junta para cárter	CG 1	450211
0321.110	Tapa distribución	CG 1	450012
0322.040	Placa distribución	CB 1	450013
1206.050	Bomba de agua	NB 1 1	450314
0349.030	Jgo. múltiple escape (4)	FCH 1 1	450015
0348.330	Múltiple admisión	NB 1 1	450317
1710.100	Salida de escape	FCH 1 1	450118
1710.093	Salida de escape TN	FCH	450318
	Cierre termostato	NB	450319
	Termostato	GS	450519
1410.093	Jgo. juntas carburador solex 76/80	VS	450320
	Jgo. juntas carburador solex 33-pbica	VS	450321
1417.500	Jgo. juntas carburador solex 32/35 minsa	VS	450521
	Jgo. juntas carburador solex 34 teie	VS	450322
	Base carburador	NB 2	450225
1406.006	Base carburador	NB 2 2	450325
1406.122	Tapa carburador	CB	450226
	Tapa carburador	CB	450326
1104.040	Bomba aceite a block	CB	450027
1451.031	Base bomba nafta	CB 2	450028
	Arandela tapón cárter B 18 x 24 x 2.3 CN	CN	450029
0164.030	Arandela tapón cárter B 16 x 22 x 2.4 CN	CN	450229
1166.020	Arand. cañería aceite a tapa cilindro A 8 x 14 x 1 C	CU 4 4	450030
1458.030	Tapa bomba nafta	CG	450031
1406.131	Base filtro aire	CB	450231
1179.040	Tubo llenado aceite	CG 1	450032
0213.030	Arandela capuchón bujías	GS 4 4	450033
0253.050	Tubo separador balancines	GS 2 2	450034
1179.060	Respiradero cárter	CG 1	500234
0127.050	Bastón retén bancada	GS 2	450035
6462.070	Grifo calefactor	NB	450036
3015.001	Tubo empuje	NB	450136
1474.030	Cuerpo bomba nafta	CG	450037
5907.001	Base distribuidor	CB 1	450038
1031.030	Tórica bomba de aceite o'ring G 12.42 x 1.78	GS 1	450039
1528.070	Flotante tanque nafta	CG	450042
	Bomba aceite a block	NB 1	450048
	Jgo. junta caja velocidades BA7	CB	450350
	Jgo. juntas diferencial 67/80	CB	450155
3018.001	Tapa diferencial TRANSAX	CG	450355
	Palier TRANSAX	NB	450356
	Cierre diferencial ancha 67/80	CB	450159
0304.070	Junta para cárter	CGT	450260
	Cierre diferencial angosta 67/80	CB	450162
	Tapa diferencial TRANSAX	CGT	450362

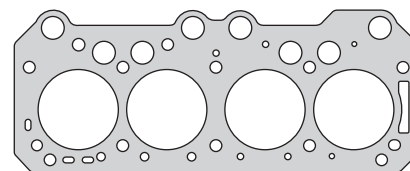

450305

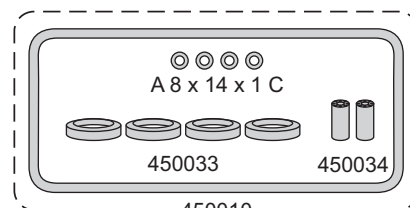

450010

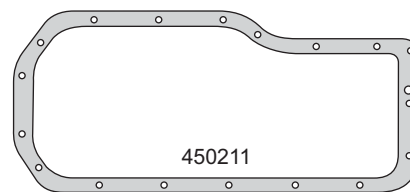

450211

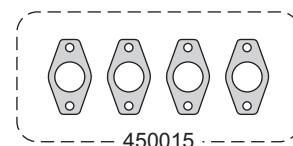

450015

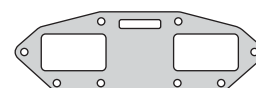

450317

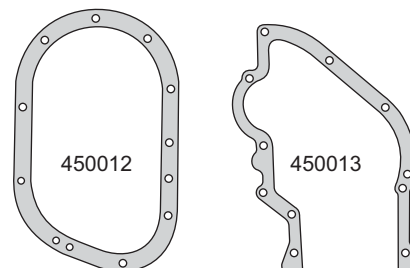

450012

450013

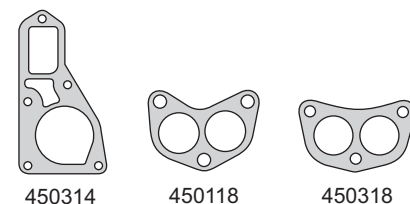

450314

450118

450318

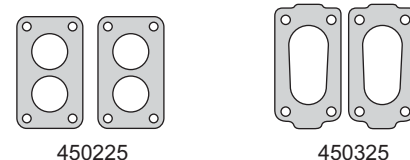

450225

450325

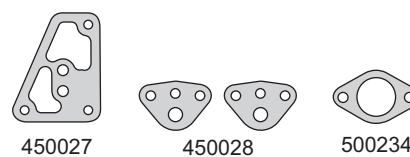

450027

450028

500234

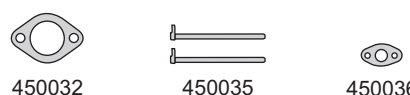

450032

450035

450036

**PEUGEOT**



Motor/Engine	Cm³	HP	Ø
XN1 - XN2 (OHV) 8V	1971	78/85	88

Peugeot: 504 TN/GES/XNA 1976/80

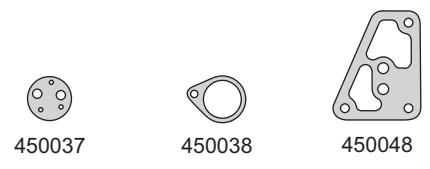

Nº OE	Descripción/Description	Mat.	1	2	Ref.
3298.030	Jgo. suplemento camisa cilindros (0.050) (4)	CU			450270-0.05
0112.590	Jgo. suplemento camisa cilindros (0.075) (4)	CU			450270-0.075
	Jgo. suplemento camisa cilindros (0.100) (4)	CU	1		450270-0.100
	Jgo. suplemento camisa cilindros (0.125) (4)	CU			450270-0.125
	Arandela A 16 x 22 x 1.5 A	AL	1	1	
	Arandela A 18 x 24 x 1.5 A	AL		2	
	Kit de retenes completo				R450000
	Jgo. retén válvulas (8)	T			R450010T
	Jgo. retén válvulas (8)	P	1		R450010P
0517.001	Retén distribución 42 x 60 x 10	P	1		R450012P

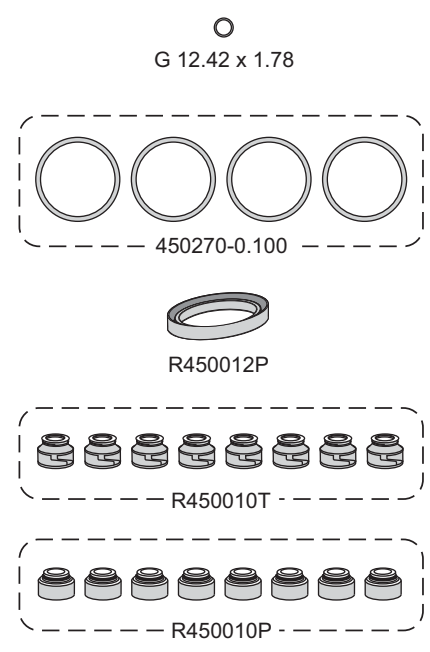

# PEUGEOT



Motor/Engine	Cm³	HP	Ø
XD2	2304	70/73	94
XD3	2498	76/90	94
XD3P (OHV) 8V	2498	79	94

**Peugeot:** XD2 504/505D, 505/604TD  
J7D/J9D  
XD3 504/505D, J9

**SsangYong:** Korando Family 1993/97



**DIESEL**

Nº OE	Descripción/Description	Mat.	Ref.
	Jgo. de juntas para motor		450700-R-1M
	Jgo. de juntas para motor		450700-R-2M
	Jgo. de juntas para motor		450700-R-3M
	Jgo. de juntas para motor		450700-R-4M
	Jgo. de juntas para motor		450701-R
	Jgo. de juntas superior		450795-1M
	Jgo. de juntas superior		450795-2M
	Jgo. de juntas superior		450795-3M
	Jgo. de juntas superior		450795-4M
	Jgo. juntas superior sin JTC		450796
	Junta tapa cilindros Ø 96.0 $\geq$ 1.55 N.R.		NFT 450405-1M
	Junta tapa cilindros Ø 96.0 $\geq$ 1.65 N.R.		NFT 450405-2M
	Junta tapa cilindros Ø 96.0 $\geq$ 1.75 N.R.		NFT 450405-3M
	Junta tapa cilindros Ø 96.0 $\geq$ 1.85 N.R.		NFT 450405-4M
	Junta tapa cilindros Ø 96.0 $\geq$ 1.50 N.R.		NFT 1 1 450407-1M
	Junta tapa cilindros Ø 96.0 $\geq$ 1.60 N.R.		NFT 450407-2M
	Junta tapa cilindros Ø 96.0 $\geq$ 1.70 N.R.		NFT 450407-3M
	Junta tapa cilindros Ø 96.0 $\geq$ 1.80 N.R.		NFT 450407-4M
	Junta tapa cilindros Ø 96.0 $\geq$ 1.60 N.R.		NFT 450409-2M
	Junta tapa cilindros Ø 96.0 $\geq$ 1.70 N.R.		NFT 450409-3M
	Junta tapa cilindros Ø 96.0 $\geq$ 1.80 N.R.		NFT 450409-4M
	Jgo. tornillos tapa cilindros (HAS17038)		B450700
	Jgo. tornillos tapa cilindros (HAS12038)		B450700-1
0249.250	Conj. junta tapa válvulas superior (11)		CG 1 1 500210
0313.190	Junta para cárter		NB 1 450411
0321.390	Tapa distribución		CB 1 450412
0322.081	Contratapa distribubición 88/...		CB 1 450413
0322.220	Contratapa distribubición 88/...		CB 1 450713
1206.230	Bomba de agua		NB 1 1 450414
	Tapa bomba de agua con prolongación		NB 1 1 450714
0349.080	Múltiple escape XD2		FCH 2 2 500215
	Múltiple escape XD3		NFT 2 2 450416
0349.540	Múltiple escape		NFT 2 2 450716
	Múltiple admisión		NB 2 2 500217
1710.200	Salida de escape T4B		FCH 1 1 450418
1720.270	Salida de escape XD3		NFT 1 1 450718
1104.130	Base filtro aceite		NB 1 500227
1927.070	Base bomba inyectora		CB 1 450427
	Arandela tapón cárter B 18 x 24 x 2.3 CN		CN 450029
0243.010	Arandela blindada B 16 x 21 x 2.2 CN		CN 3 450229
0253.031	Arandela tapa válvulas XD2 A 8 x 20 x 1.4		NB 4 4 500230
	Arandela tapa válvulas XD3 A 7 x 17 x 1.4		NB 4 4 550430
0147.100	Tapa botadores		NB 2 450431
	Múltiple admisión central		NB 1 1 500235
0127.050	Bastón bancada		GS 2 450435
1710.430	Múltiple escape a codo		FCH 1 1 450735
1981.020	Arandela parallamas pico inyector		AC 4 4 560036
	Jgo. admisión y escape XD2 (5)		VS 1 1 500236
	Jgo. admisión y escape XD3 (5)		VS 1 1 450736
1925.120	O'ring tapa bomba inyectora		GS 450737
0321.390	Tapa distribución		NB 450438
0322.081	Placa distribución XD2		NB 450439
0322.220	Placa distribución XD3		NB 450739

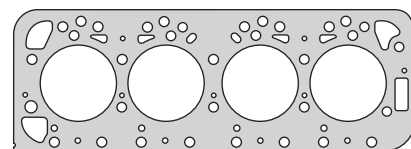

450407

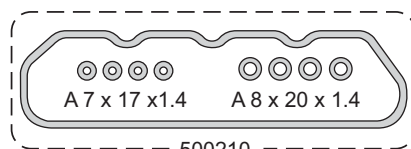

500210

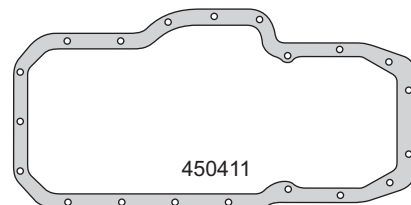

450411

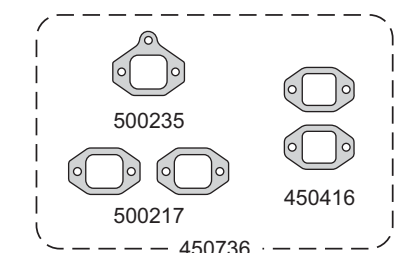

500235

500217

450416

450736

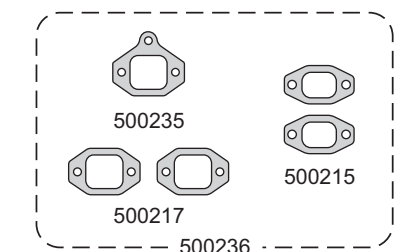

500235

500217

500215

500236

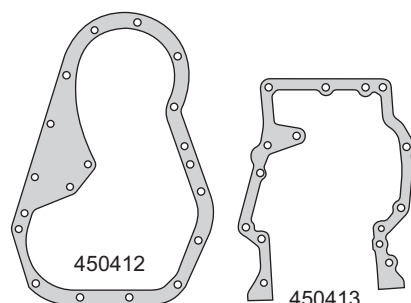

450412

450413

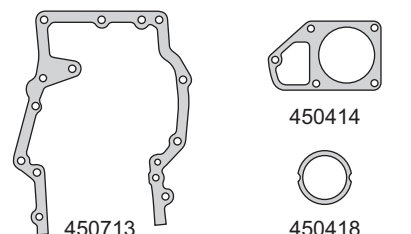

450713

450414

450418

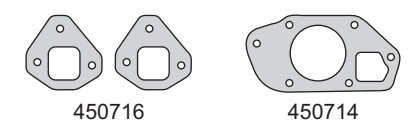

450716

450714

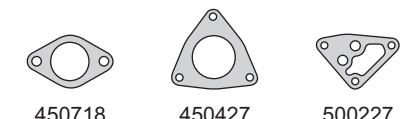

450718

450427

500227

# PEUGEOT



Motor/Engine	Cm³	HP	Ø
<b>XD2</b>	<b>2304</b>	<b>70/73</b>	<b>94</b>
<b>XD3</b>	<b>2498</b>	<b>76/90</b>	<b>94</b>
<b>XD3P</b> (OHV) 8V	<b>2498</b>	<b>76</b>	<b>94</b>

**Peugeot:** XD2 504/505D, 505/604TD  
J7D/J9D  
XD3 504/505D, J9

**SsangYong:** Korando Family 1993/96



**DIESEL**

Nº OE	Descripción/Description	Mat.	4	4	Ref.
1981.050	Arandela base inyector A 16 x 21 x 2 C	CU	4	4	500240
	O'ring inyector	GS			450440
0249.050	Arandela conduc. flauta balancines G 16 x 7 x 5	GS	1	1	500241
0133.966	Anillo termostato	GS	1	1	550641
1041.100	Bomba aceite a block	NB		1	500242
	Jgo. múltiple escape 505 / 92 XD3	NFT			450742
0236.070	Tapa cámara agua	NB	2	2	500243
	Escape turbo - E/PRIS Ø66	NB			560543
0956.010	Retén guía válvulas G 14 x 7 x 3	GS		8	500245
	Regulación bomba inyectora	NB		1	500246
	Escape turbo - E/ PRIS. Ø 63 mm.	AC			500546
1562.210	Arandela cañería gasoil A 12 x 16 x 1.5 C	CU	8	8	500251
1166.020	Arandela conexión presión aceite A 8 x 13 x 1 C	CU		6	500252
1562.490	Arandela ret. reb. inyectora A 8 x 12 x 1 C	CU	8	8	500253
0157.080	Arandela tapón desagote agua A 14 x 20 x 1.5 C	CU		1	500254
0119.120	Jgo. juntas empaquetadura bancada (2)	SNA		1	450758
0249.250	Tapa válvulas superior	CGT			500261
0119.180	Jgo. suplemento camisa cilindros (4)	GS			500270
0119.180	Jgo. suplemento camisa cilindros (4)	S			500271
	O'ring G 101.32 x 1.78	GS		1	
	Kit de retenes completo (polea angosta)				R450400
	Kit de retenes completo (hasta 4/86)				R450400-1
	Kit ret. compl. (desde 5/86 polea ancha)				R450400-2
	Jgo. retén válvulas (8)	V		1	R460210V
	Retén bancada (reforma expansible)	S			R450411-1S
0517.001	Ret. dist. 45 x 60 x 10 Ø45 (polea angosta)	P			R450412P
048.410	Ret. dist. 42 x 60 x 8 Ø42 (hasta 4/86)	P		1	R450412-1P
048.410	Ret. dist. 45 x 60 x 7 Ø45 (desde 5/86)	P		1	R450412-2P

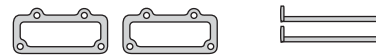

450431

450435

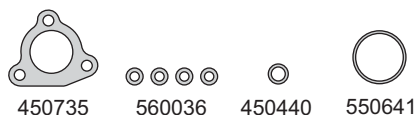

450735

560036

450440

550641

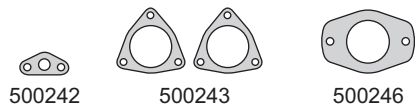

500242

500243

500246



B 16 x 21 x 2.2 CN

B 18 x 24 x 2.3 CN



G 101.32 x 1.78



A 7 x 17 x 1.4 NH

A 8 x 20 x 1.4 NH



A 8 x 13 x 1 C



G 14 x 7 x 3

A 12 x 16 x 1.5 C

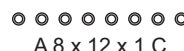

A 8 x 12 x 1 C



A 14 x 20 x 1.5 C

G 16 x 7 x 5



A 16 x 21 x 2 C

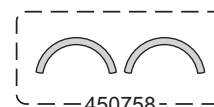

450758



500270/500271



R450412-1P



R450412-2P



R460210V

PEUGEOT

Motor/Engine  Cm³ HP ØGR/SR  
XN1/XN2  
(OHV) 8V 1971 85 88

Peugeot: 505, 9R, J9, J5 1980/92

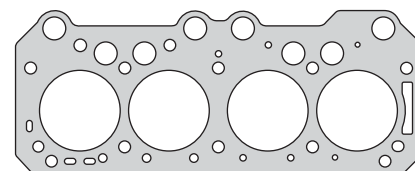

450305

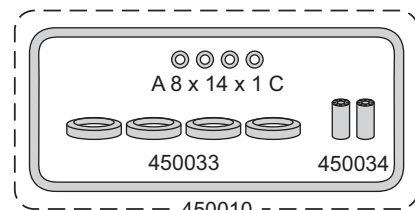

450033

450034

450010

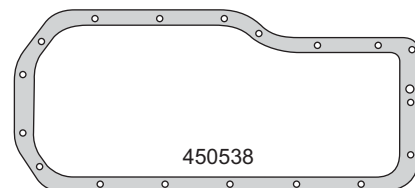

450538

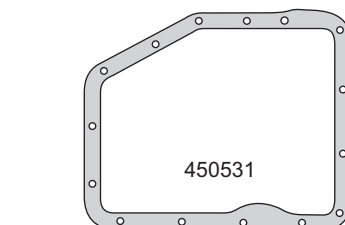

450531

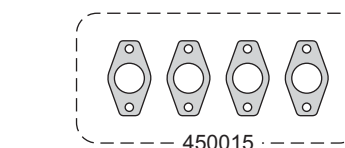

450015

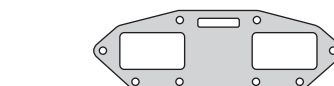

450317

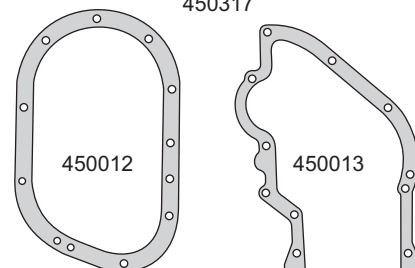

450012

450013

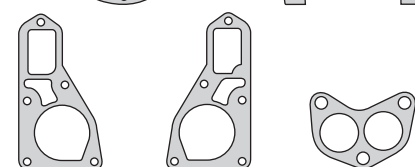

450314

450514

450118

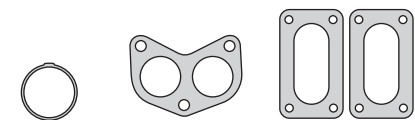

450519





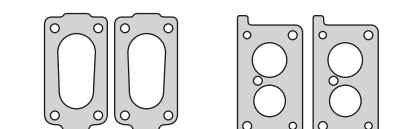















































450518

450125



450325

450525

Nº OE	Descripción/Description	Mat.	Ref.
0199.424	Jgo. de juntas para motor 		450500-R
0203.460	Junta tapa cilindros Ø 90.0 $\pm$ 1.40 	NFT 1	450305
0203.460	Junta tapa cilindros Ø 90.0 $\pm$ 2.40 	NFT	450306
0203.460	Junta tapa cilindros Ø 90.0 $\pm$ 1.40 	NFT	450307
	Jgo. tornillos tapa cilindros (HAS19038) 		B450200
	Jgo. tornillos tapa cilindros (HAT55055/55100) 		B460200
0249.140	Conj. junta tapa válvulas (11) 	N 1	450010
0304.070	Junta para cárter 	CG 1	450211
0321.110	Tapa distribución 	CG 1	450012
0321.110	Tapa distribución 	CGT 1	450112
0332.040	Placa distribución 	CB 1	450013
1206.050	Bomba de agua 	NB 1	450314
	Bomba de agua 	NB 1	450514
0349.030	Jgo. múltiple escape (4) 	FCH 1	450015
0348.330	Múltiple admisión 	NB 1	450317
1710.100	Salida de escape 	FCH 1	450118
1710.240	Salida de escape 	FCH 1	450518
	Guarnición termostato 	GS 1	450519
	Jgo. juntas carburador SOLEX C34 EIES/7 	VS 1	450520
	Jgo. juntas carburador SOLEX 32/35 MINSÁ 	VS 1	450521
	Jgo. juntas carburador SOLEX 34/34-ZI 	VS 1	450522
	Jgo. juntas carburador SOLEX 32/35-T MIMA 	VS 1	450523
1406.006	Base carburador 34 EIES'82 	NB 1	450125
1406.006	Base carburador C34 EIES 83/ 	NB 2	450325
	Base carburador MINSÁ 	NB 2	450525
1406.122	Tapa carburador 34 EIES 82 	CB 1	450226
	Tapa carburador MINSÁ 	CB 1	450526
1104.040	Bomba aceite a block 	CB 1	450027
1451.031	Base bomba nafta 	CB 2	450028
0164.030	Arandela tapón cárter B 16 x 22 x 2.4 CN 	CN 1	450229
1166.020	Arandela cañería ac.a tapa cilindro A 8 x 14 x 1C 	CU 4	450030
1458.030	Tapa bomba nafta 	CG 1	450031
0301.360	Junta para cárter chico con aire 	CG 1	450531
1179.040	Tubo llenado aceite 	CG 1	450032
0213.030	Arandela capuchón bujías 	GS 4	450033
0253.050	Tubo separador balancines 	GS 2	450034
1179.060	Respiradero cárter 	CG 1	500234
0127.050	Bastón retén bancada 	GS 2	450035
1031.030	Base distribuidor 	CB 1	450038
0304.070	Junta para cárter 	NB 1	450538
1031.030	Tórica bomba aceite o'ring G 12.42 x 1.78 	GS 1	450039
	Base carburador 34-34-Z1 	NB 1	450540
0301.360	Cárter chico (Accopac) 	CB 1	450541
1451.031	Base bomba nafta 	NB 1	450543
031.360	Junta para cárter chico 	NB 1	450545
0301.360	Junta para cárter chico 	CGT 1	450546
1104.040	Bomba aceite a block 	NB 1	450048
	Jgo. juntas caja velocidades BA7 	CB 1	450350
3018.001	Tapa diferencial TRANSAX 	CG 1	450355
	Jgo. juntas diferencial hipoidal 	CB 1	450555
	Palier TRANSAX 	NB 1	450356
	Tubo empuje 	CB 1	450556
0304.070	Junta para cárter 	CGT 1	450260

**PEUGEOT**



Motor/Engine	Cm³	HP	Ø
GR/SR XN1/XN2 (OHV) 8V	1971	85	88

Peugeot: 505, 9R, J9, J5 1980/92



Nº OE	Descripción/Description	Mat.	Ref.
	Tapa diferencial TRANSAX	CGT	450362
3292.030	Jgo. suplemento camisa cilindros (0.050) (4)	CU	450270-0.05
0112.590	Jgo. suplemento camisa cilindros (0.075) (4)	CU	450270-0.075
0112.570	Jgo. suplemento camisa cilindros (0.100) (4)	CU 1	450270-0.100
0112.580	Jgo. suplemento camisa cilindros (0.125) (4)	CU	450270-0.125
	Arandela A 16 x 22 x 1.5 A	AL	1
	Kit de retenes completo		R450000
	Jgo. retén válvulas (8)	T	R450010T
	Jgo. retén válvulas (8)	P	R450010P
0517.001	Retén distribución 42 x 60 x 10	P	R450012P

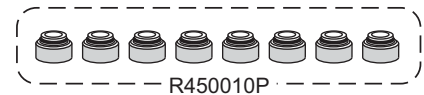
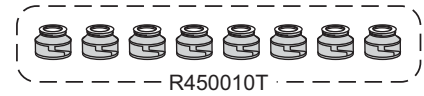
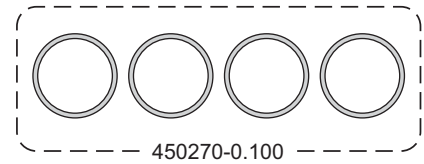
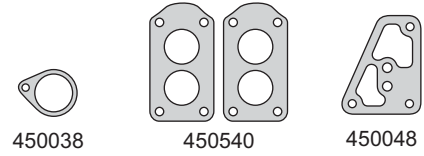
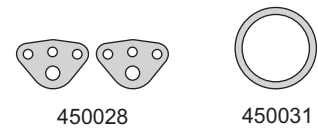



# PEUGEOT



Motor/Engine Cm³ HP Ø

**XN2 - XN6**  
(OHV) 8V **1971** **105** **88**

Peugeot: 505 1983/86, 504 1970/84  
604 1982/86

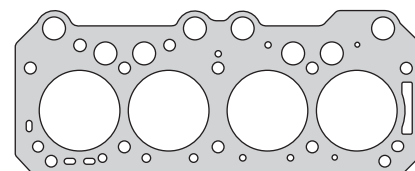

450507 - 1.80

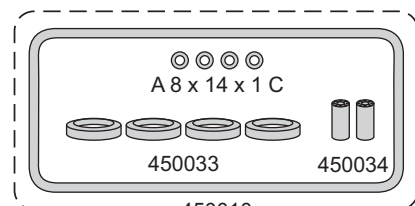

450010

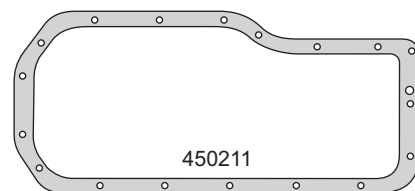

450211

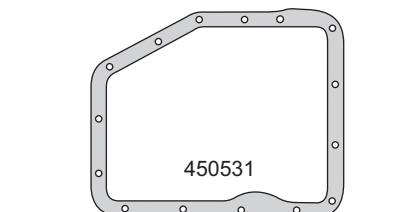

450531

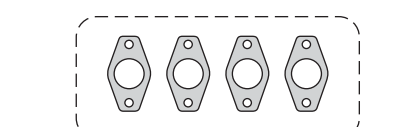

450015



450517

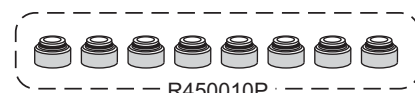
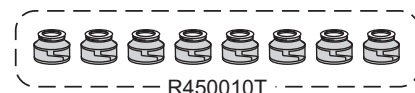
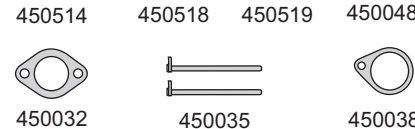
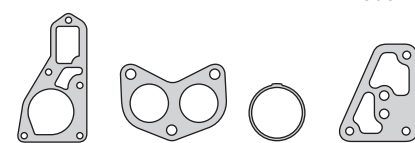
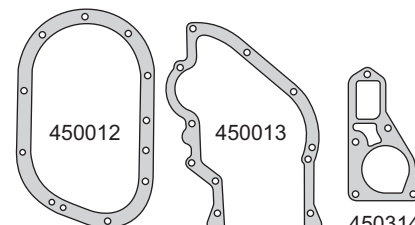

Nº OE	Descripción/Description	Mat.	Ref.
	<b>Jgo. de juntas para motor</b>		<b>450600-R</b>
	<b>Junta tapa cilindros Ø 90.0 ± 1.50</b>	NFT	<b>450507-1.50</b>
	<b>Junta tapa cilindros Ø 90.0 ± 1.80</b>	NFT	<b>450507-1.80</b>
	<b>Jgo. tornillos tapa cilindros (HAS19038)</b>		<b>B450200</b>
0249.140	Conj. junta tapa válvulas (11)	N	450010
0304.070	Junta para cárter	CG	450211
0321.110	Tapa distribución	CG	450012
0321.110	Tapa distribución	CG	450112
0322.040	Placa distribución	CB	450013
1206.050	Bomba de agua	NB	450314
	Bomba de agua	NB	450514
0349.030	Jgo. múltiple escape (4)	FCH	450015
	Múltiple admisión	NB	450517
1710.240	Salida de escape	FCH	450518
	Termostato	GS	450519
1104.040	Bomba aceite a block	CB	450027
0164.030	Arandela tapón cárter B 16 x 22 x 2.4 CN	CN	450229
1166.020	Arandela cañería ac. a tapa cilindros A 8 x 14 x 1 C	CU	450030
0301.360	Cárter chico	CG	450531
1179.040	Tubo llenado aceite	CG	450032
0213.030	Arandela capuchón bujías	GS	450033
0253.050	Tubo separador balancines	GS	450034
0127.050	Bastón retén bancadas	GS	450035
5907.001	Base distribuidor	CB	450038
0304.070	Junta para cárter	NB	450538
1031.030	Tórica bomba aceite o'ring G 12.42 x 1.78	GS	450039
0301.360	Junta para cárter chico (Accopac)	CB	450541
0301.360	Junta para cárter chico	NB	450545
0301.360	Junta para cárter chico	CG	450546
1104.040	Bomba aceite a block	NB	450048
	Jgo. juntas caja velocidades BA7	CB	450350
	Jgo. juntas diferencial Hipoidal	CB	450555
	Palier TRANSAX	NB	450356
	Tubo empuje	CB	450556
3040.070	Cierre diferencial	CB	450159
0304.070	Junta para cárter	CGT	450260
	Tapa diferencial TRANSAX	CGT	450362
3298.030	Jgo. suplemento camisa cilindros (0.050) (4)	CU	450270-0.05
0112.590	Jgo. suplemento camisa cilindros (0.075) (4)	CU	450270-0.075
0112.570	Jgo. suplemento camisa cilindros (0.100) (4)	CU	450270-0.100
0112.580	Jgo. suplemento camisa cilindros (1.125) (4)	CU	450270-0.125
	Arandela A 16 x 22 x 1.5 A	AL	1
	Kit de retenes completo		R450000
	Jgo. retén válvulas (8)	P	1 R450010P
	Jgo. retén válvulas (8)	T	R450010T
0517.001	Retén distribución 42 x 60 x 10	P	1 R450012P

# PEUGEOT



Motor/Engine	Cm³	HP	Ø
XN1 - XNA Gamma (OHV) 8V	1971	90	88

Peugeot: 505 1987/...



Nº OE	Descripción/Description	Mat.	Ref.
	<b>Jgo. de juntas para motor</b>		<b>450800-R</b>
0321.110	Junta tapa cilindros Ø 90.0 ± 1.50	NFT	450507-1.50
	Junta tapa cilindros Ø 90.0 ± 1.80	NFT	1 450507-1.80
	Jgo. tornillos tapa cilindros (HAS19038)		B450200
0321.110	Jgo. tornillos tapa cilindros (HAT55055/55100)		B460200
	Conj. junta tapa válvulas	N	1 450010
0249.140	Junta para cárter	CG	450211
0304.070	Tapa distribución	CG	1 450012
0321.110	Tapa distribución	CGT	450112
0321.110	Placa distribución	CB	1 450013
0322.040	Bomba de agua	NB	1 450314
1206.050	Bomba de agua	NB	450514
	Jgo. múltiple escape (4)	FCH	1 450015
0349.030	Múltiple admisión	NB	1 450317
0348.330	Salida de escape	FCH	1 450518
1710.240	Termostato	GS	450519
	Jgo. juntas carburador SOLEX C34 EIES/7	VS	450520
	Jgo. juntas carburador SOLEX 32/35 MINSÁ	VS	450521
	Jgo. juntas carburador SOLEX 34/34 ZI	VS	450522
	Base carburador 34 EIES '82	NB	450125
1406.006	Base carburador C34 EIES 83/	NB	2 450325
1406.006	Base carburador MINSÁ	NB	2 450525
	Tapa carburador 34 EIES '82	CB	450226
1406.122	Tapa carburador MINSÁ	CB	450526
	Bomba aceite a block	CB	450027
1104.040	Base bomba nafta	CB	2 450028
1451.031	Arandela tapón cárter B 16 x 22 x 2.4 CN	CN	450229
0164.030	Arandela cañería aceite a tapa cilindros A 8 x 14 x 1 C	CU	4 450030
1166.020	Tapa bomba nafta	CG	450031
1458.030	Junta para cárter chico con aire	CG	1 450531
0301.360	Tubo llenado de aceite	CG	1 450032
1179.040	Arandela capuchón bujías	GS	4 450033
0213.030	Tubo separador balancines	GS	2 450034
0253.050	Respiradero cárter	CG	1 500234
1179.060	Bastón retén bancada	GS	2 450035
0127.050	Grifo calefactor	NB	450036
6462.070	Base distribuidor	CB	1 450038
1474.030	Junta para cárter	NB	1 450538
0304.070	Tórica bomba de aceite G 12.42 x 1.78	GS	1 450039
1031.030	Base carburador 34-34 ZI	NB	450540
0301.360	Cárter chico (Accopac)	CB	450541
1451.031	Tapa carburador 34-34 ZI	NB	450043
0301.360	Junta para cárter chico con aire	NB	450545
0301.36	Junta para cárter chico con aire	CGT	450546
1104.040	Bomba aceite a block	NB	450048
3018.001	Tapa diferencial TRANSAX	CG	450355
	Jgo. juntas diferencial hipoidal	CB	450555
	Palier TRANSAX	NB	450356
	Tubo empuje	CB	450556
0304.070	Junta para cárter	CGT	450260
	Tapa diferencial	CGT	450362
3298.030	Jgo. suplemento camisa cilindros (0.050) (4)	CU	450270-0.05
0112.590	Jgo. suplemento camisa cilindros (0.075) (4)	CU	450270-0.075

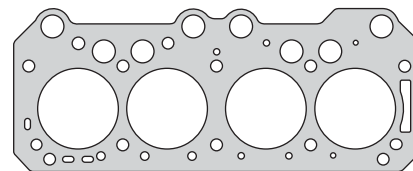

450507 - 1.80

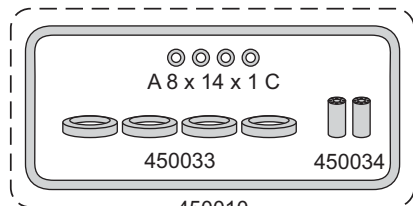

450010

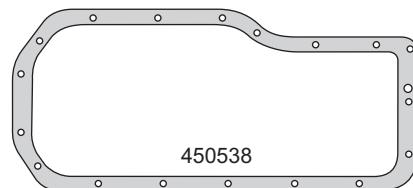

450538

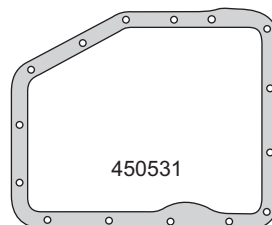

450531

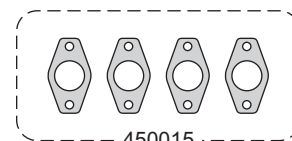

450015

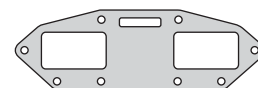

450317

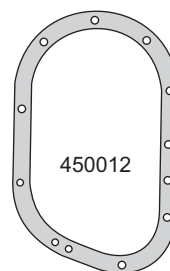

450012

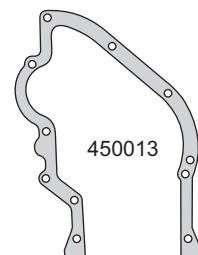

450013

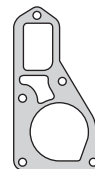

450314



450514



450519



450518

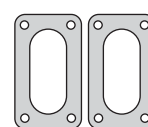

450125

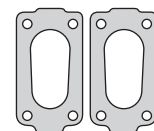

450325

# PEUGEOT



Motor/Engine **Cm³** **HP** **Ø**

**XN1 - XNA**  
**Gamma**  
(OHV) 8V

1971

90

88

Peugeot: 505 1987/...



Nº OE	Descripción/Description	Mat.	Ref.
0112.570	Jgo. suplemento camisa cilindros (0.100) (4)	CU	1 450270-0.100
0112.580	Jgo. suplemento camisa cilindros (0.125) (4)	CU	450270-0.125
	Arandela A 16 x 22 x 1.5 A	AL	1
	Kit de retenes completo		R450000
	Jgo. retén válvulas (8)	T	R450010T
	Jgo. retén válvulas (8)	P	1 R450010P
0517.001	Retén distribución 42 x 60 x 10	P	1 R450012P

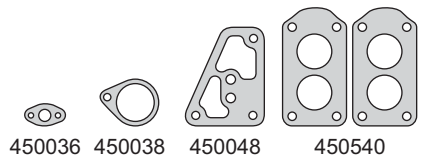
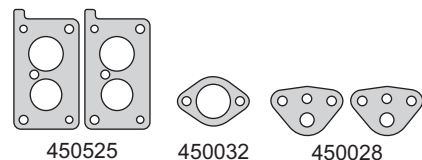

A 16 x 22 x 1.5 A      G 12.42 x 1.78

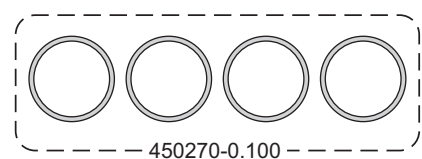

# PEUGEOT



Motor/Engine	Cm³	HP	Ø
7CV	1290	52	75
8CV	1468	55/58	80

Peugeot: 403/7 1959/66  
403/8 1955/67



Nº OE	Descripción/Description	Mat.	Ref.
0199.130	Jgo. de juntas para motor		450900-R
0203.180	Junta tapa cilindros Ø 82.0 ± 1.40	NFT 1	450905
0203.180	Junta tapa cilindros Ø 82.0 ± 2.40	NFT	450906
0249.090	Conj. junta tapa válvulas superior (11)	GS 1	450910
	Jgo. junta para cárter (4)	CG 1	450911
0321.050	Tapa distribución	CG 1	450912
0321.060	Placa distribución	CB 1	450913
1206.050	Bomba de agua	NB 1	450914
0349.030	Jgo. múltiple escape (4)	FCH 1	450015
0236.010	Múltiple admisión	CB 1	450917
1710.040	Salida de escape	FCH 1	450918
1410.070	Jgo. juntas carburador	VS	450020
1406.340	Base carburador	NB 1	450025
1406.120	Tapa carburador	CB	450026
1451.131	Base bomba nafta	CB 2	450028
0313.030	Arandela tapón cárter B18 x 24 x 2.3 CN	CN	450029
1166.020	Arandela tapa válvulas A 8 x 14 x 1 C	CU 4	450030
0313.030	Junta para cárter chico	CG 1	450931
0110.401	Filtro aceite a block	CB 1	450932
0213.030	Arandela capuchón bujías	GS 4	450033
0110.401	Filtro aceite a block		450933
0253.050	Tubo separador balancines	GS 2	450034
0111.502	Tapa filtro aceite	CB 1	450934
0127.050	Bastón retén bancada	GS 2	450035
5907.001	Base distribuidor	CB 1	450038
1912.001	Vaso nafta	CG 1	450041
1451.031	Base bomba nafta	NB	450043
	Arandela A 18 x 24 x 1.5 A	AL 1	
	Kit de retenes completo		R450000
	Jgo. reten válvulas	P 1	R450010P
	Jgo. reten válvulas (8)	T	R450010T
0517.001	Retén distribución 42 x 60 x 10	P 1	R450012P

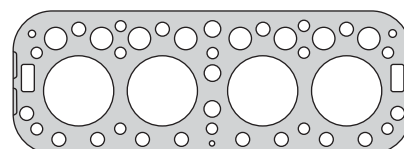

450905

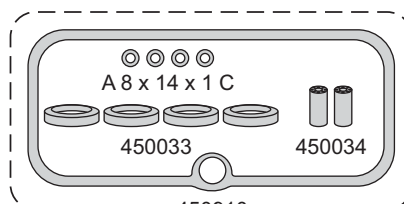

450910

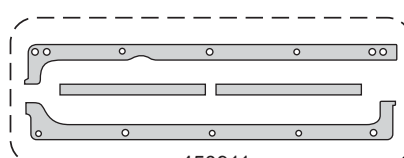

450911

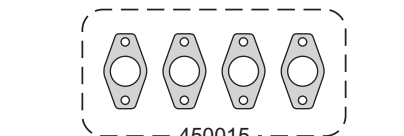

450917

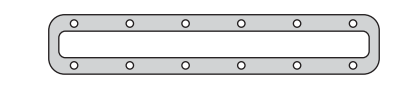

450918

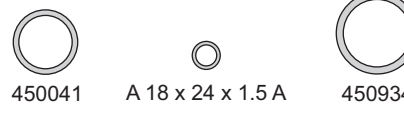
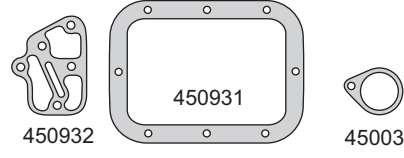
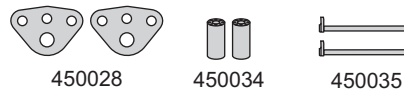
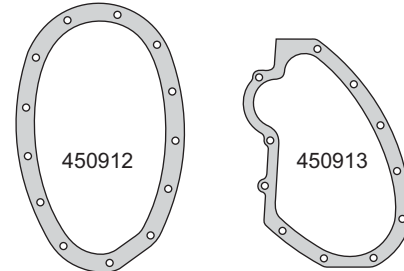

# PEUGEOT



Motor/Engine	Cm³	HP	Ø
XU5	1580	75/115	83
XU9 (SOHC) 8V	1905	110/130	83

**Citroën:** 1.5 BX 16 1982/93, BX 15 1987/91  
Visa 1985/90, ZX 1991/97  
1.9 BX 19 1984/93

**Peugeot:** 1.5 305 1982/91, 205 1984/96,  
309 1985/93, 405 1987/95  
1.9 205, 309 1986/94  
305 1983/91, 405 1987/93

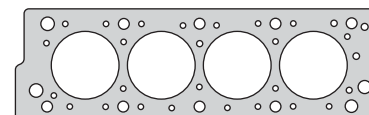

460207-1.20



460210/1

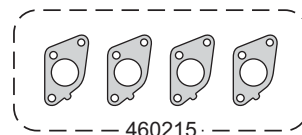

460215



460217



460226



460219



460233



460227



460228



A 6 x 11 x 2 C



R460213V



R450010P

Nº OE	Descripción/Description	Mat.	Ref.
	Jgo. de juntas superior		451295-R
	Junta tapa cilindros Ø 84.0 ± 1.20	NFT	1 460207-1.20
	Jgo. tornillos tapa cilindros (HAT55055/55100)		B460200
	Sellador líquido - caucho de silicona		TRN0085G
0249.480	Junta tapa válvulas	N	1 460210/1
0349.700	Jgo. múltiple escape (4)	NFT	1 460215
0348.910	Múltiple admisión inyección	NB	1 460217
1339.530	Termostato	GS	2 460219
	Tapa carburador	CB	1 460226
	Junta brida	NFT	1 460227
1451.070	Bomba nafta	NB	2 460228
1339.410	Alojamiento termostato	NB	1 460233
	Arandela tubería aceite A 6 x 11 x 2 C	CU	3 460239
	Jgo. retén válvulas (8)	P	1 R450010P
0236.44	Retén árbol levas 36 x 50 x 8	V	1 R460213V

# PEUGEOT



Motor/Engine	Cm³	HP	Ø
XU10M	1998	107	86
XU102C	1998	115	86
XU10J2 (SOHC) 8V	1998	122/130	86

Citroën: XM 1989/94 - 1990/93  
 Peugeot: 605 1989/98



Nº OE	Descripción/Description	Mat.	Ref.
	Jgo. de juntas superior		451395-R
0209.N1	Junta tapa cilindros Ø 87.0 ± 1.20	NFT 1	451307
0204.65	Jgo. tornillos tapa cilindros (HAT55055/55100)		B460300
	Sellador líquido - caucho de silicona		TRN0085G
0249.480	Junta tapa válvulas	N 1	460210/1
0349.700	Jgo. múltiple escape (4)	FCH 1	460215
0348.ED	Múltiple admisión	NH 1	451317
1339.530	Termostato	GS 2	460219
	Tapa carburador	CB 1	460226
	Guarnición	GS 1	451330
	Guarnición	GS 1	451331
1339.410	Junta alojamiento termostato	NB 1	460233
	Arandela A 6 x 10 x 1 C	CU 13	
	O´ring G 36.17 x 2.62	GS 1	
0956.22	Jgo. retén válvulas (8)	P 1	R450010P
0127.28	Retén bancada 90 x 110 x 7	V	R460211V
0326.12	Retén distribución 42 x 62 x 7	V	R460212V
0236.44	Retén árbol levas 36 x 50 x 8	V 1	R460213V

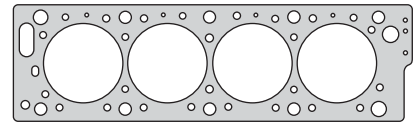

451307

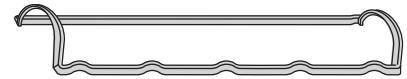

460210/1

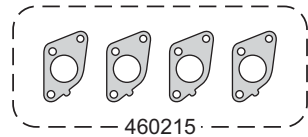

460215

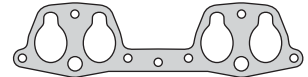
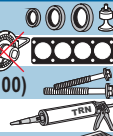

451317



460226



460219



460233



451330



451331

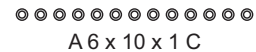

A 6 x 10 x 1 C



G 36.17 x 2.62



R460211V



R460212V



R460213V



R450010P

# PEUGEOT



Motor/Engine	Cm³	HP	Ø
TU9/K/MZ/M	954	45/50	70
TU1M (SOHC) 8V	1124	54/60	72

**Citroën:** C15 1988/..., AX 10 1986/...  
Saxo, ZX, Berlingo 1996/...  
**Peugeot:** 106, 306, Partner 1996/...  
205 1987/93, 106 1991/...



Nº OE	Descripción/Description	Mat.	Ref.
	Jgo. de juntas para motor		451500-R
	Jgo. de juntas superior	●	451595
	Jta. tapa cilindros Ø 73.5 ± 1.30  NR <sup>3</sup>	NFT 1 1	451507
	Jgo. tornillos tapa cilindros (HAE14038)		B470500
	Conj. junta tapa válvulas (3)	GS 1 1	460710
	Junta para cárter	NB 1 1	460711
	Jgo. múltiple escape (2)	NFT 1 1	460416
	Jgo. múltiple admisión (2)	NB 1 1	460717
	Salida de escape	NFT 1 1	451518
	Junta bomba combustible	NB 2 2	451528
	Junta brida	CB 1 1	451530
	Junta asiento carburador	NB 1 1	460730
	Arandela tapa válvulas	GS 2 2	451732
	Guarnición termostato	GS 1 1	460245
	Arandela A 12 x 18 x 1 C	CU 1 1	
	Arandela A 20 x 26 x 2 F	F 1 1	
	Arandela A 8 x 20 x 1.5 F	NB 3 3	
	Arandela A 16 x 22 x 1.5 A	AL 1 1	
	O´ring G 36 x 3	GS 1 1	
	O´ring G 52.07 x 2.62	GS	1
	O´ring G 79.5 x 3	GS 1 1	
	Kit de retenes completo		R470400
	Jgo. retén válvulas (8)	V 1	R460710V
	Retén bancada 85 x 105 x 12	V 1	R220411V
	Retén distribución 42 x 66 x 8	V 1	R460712V
0236.44	Retén árbol levas 36 x 50 x 8	V 1	R460213V

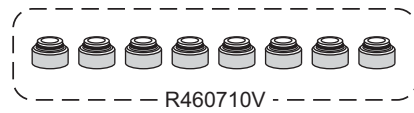
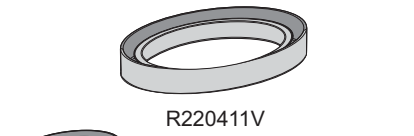
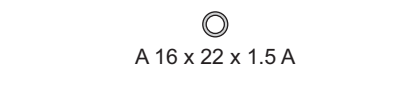
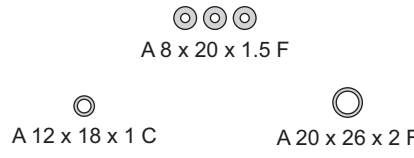
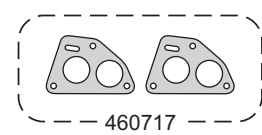
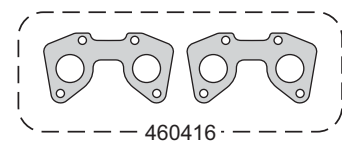
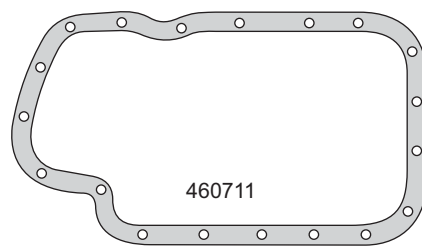
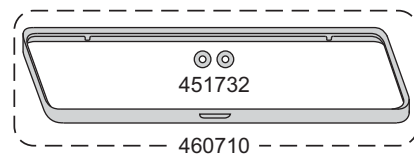
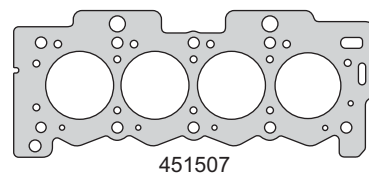

# PEUGEOT



Motor/Engine	Cm³	HP	Ø
TU3F/FM	1360	75/80	75
TU3F2/F2C	1360	75/80	75
TU3J2/Z (SOHC) 8V	1360	75/94	75

Motor con block de fundición gris

**Citroën:** AX14, BX14 1991/..., ZX 1994/..., AXGT 1993/... C15 1991/...  
**Peugeot:** 106 1994/96, 309 1992/93, 405 1993/94, 205 1991/93



Nº OE	Descripción/Description	Mat.	Ref.
	Jgo. de juntas para motor		451600-R
	Junta tapa cilindros Ø 76.0 ± 1.30	NFT 1	451607
	Jgo. tornillos tapa cilindros (HAE14038)		B470500
	Conj. junta tapa válvulas (3)	GS 1	460710
	Junta para cárter	NB 1	451611
	Jgo. múltiple escape (2)	AC 1	451615
	Jgo. múltiple admisión (4)	GS 1	451617
	Salido de escape	NFT 1	460718
	Jta. cuello bomba de agua	NB 1	451619
	Arandela tapa válvulas	GS 2	451732
	Guarnición termostato	GS 1	460245
	Junta base carburador	NB 2	06053
	O´ring G 36.17 x 2.62	GS 1	
	O´ring G 75.87 x 2.62	GS 1	
	Arandela A 12 x 18 x 1.5 A	AL 1	
	Arandela A 22 x 30 x 2 C	CU 3	
	Arandela A 17 x 22 x 1.5 C	CU 2	
	Arandela A 8 x 20 x 1.5	NB	
	Kit de retenes completo	1	R470500
	Jgo. retén válvulas (8)	V 1	R460710V
0514.74	Retén bancada 85 x 105 x 8	V 1	R560111V
0514.72	Retén distribución 42 x 66 x 8	V 1	R460712V
0236.44	Retén árbol de levas 36 x 50 x 8	V 2	R460213V

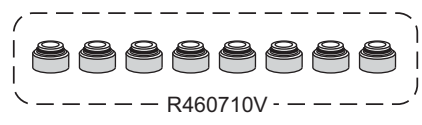
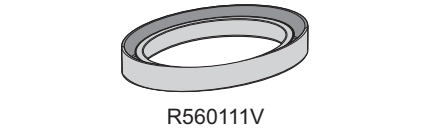
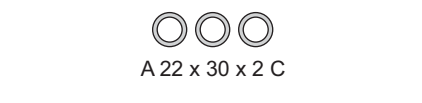
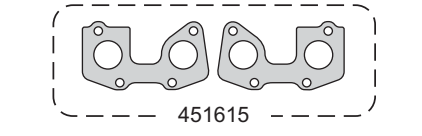
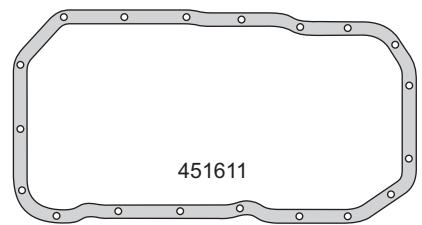
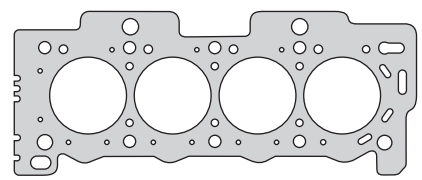



# PEUGEOT



Motor/Engine	Cm³	HP	Ø
TU1/K/Z/M/MZ	1124	55/60	72
TU3M/MC/A/JP	1360	70/75	75
TU3S/M (SOHC) 8V Motor con block de aluminio	1360	80/85	75

**Citroën:** BX 11, C15 1988/..., Saxo 1996/...  
AX 14, AX GT 1986/..., ZX 1991/98  
Berlingo - Xsara 1996/...

**Peugeot:** 106 1991/..., 306 1993/..., 405 1987/94  
205 1987/96, 1998/..., 309 1988/93  
Partner 1996/...



Nº OE	Descripción/Description	Mat.	Ref.
	Jgo. de juntas para motor		451700-R
	Jgo. de juntas superior	●	451795
	Jta. tapa cilindros Ø 76.0 ± 1.30	NFT	451705
	Jta. tapa cilindros Ø 76.0 ± 1.30	NFT	1 1 451707
	Jgo. tornillos tapa cilindros (HAE14038)		B470500
	Sellador líquido - caucho de silicona		TRN0085G
	Conj. junta tapa válvulas (3)	GS	1 1 460710
	Junta para cárter	NB	1 1 460711
	Jgo. múltiple escape (2)	NFT	1 1 460416
	Jgo. múltiple admisión (2)	NB	1 1 460717
	Salida de escape	NFT	1 1 451518
	Junta bomba combustible	NB	2 2 451528
	Junta brida	CB	1 1 451530
	Junta	CB	1 1 451730
	Junta asiento carburador	NB	1 1 460730
	Junta	CB	1 1 451731
	Arandela tapa válvulas	GS	2 2 451732
	Guarnición termostato	GS	1 1 460245
	Jgo. suplemento camisa cilindros (4)	S	1 550671
	Arandela A 12 x 18 x 1 C	CU	1 1
	Arandela A 20 x 26 x 2 F	F	1 1
	Arandela A 16 x 24 x 1 C	CU	1
	Arandela A 22 x 30 x 2 C	CU	2
	Arandela A 22 x 28 x 2 A	AL	2
	Arandela A 16 x 22 x 1.5 A	AL	1 2
	O´ring G 36 x 3	GS	1 2
	O´ring G 79.5 x 3	GS	1 1
	O´ring G 56.82 x 2.62	GS	1
	O´ring G 72.62 x 3.53	GS	1
	Kit de retenes completo		R470400
	Jgo. retén válvulas (8)	V	1 1 R460710V
0514.74	Retén bancada 85 x 105 x 12	V	1 R220411V
0514.72	Retén distribución 42 x 66 x 8	V	1 R460712V
0236.44	Retén árbol levas 36 x 50 x 8	V	1 1 R460213V

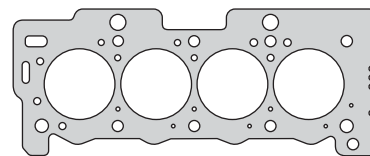

451707

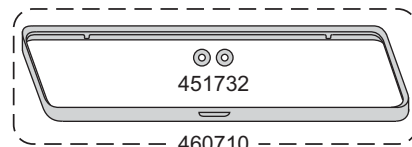

451732

460710

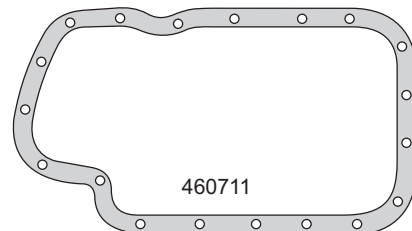

460711

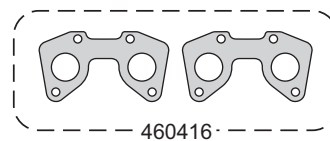

460416

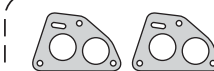

460717

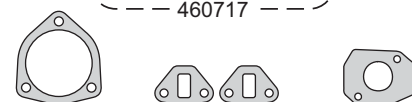

451518



451528



460730



451530



451730



451731



G 56.82 x 2.62



460245



G 72.62 x 3.53



A 12 x 18 x 1 C



A 20 x 26 x 2 F



A 22 x 30 x 2 C



A 22 x 28 x 2 A



A 16 x 24 x 1 C



G 79.5 x 3



A 16 x 22 x 1.5 A



G 36 x 3

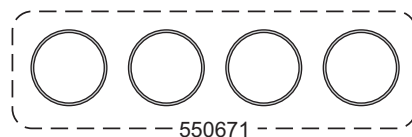

550671



R220411V



R460712V



R460213V



R460710V

# PEUGEOT



Motor/Engine	Cm³	HP	Ø
XU10J2C (RFX) (SOHC) 8V	1998	123	86

**Citroën:** ZX 1992/96, Xantia 1993/98  
**Peugeot:** 405 1992/..., 306 1993/...

Nº OE	Descripción/Description	Mat.	Ref.
	Jgo. de juntas superior		451995-R
2101-1003020	Junta tapa cilindros Ø 87.0 ± 1.50  NR3	NFT	1 460607
	Jgo. tornillos tapa cilindros  (HAT55055/55100)		B460300
0249.480	Junta tapa válvulas	N	1 460210/1
0349.700	Jgo. múltiple escape (4)	NFT	1 460215
0348.F60	Jgo. múltiple admisión (2)	N	1 460117
2105-1002064	Jgo. múltiple admisión (2)	V	1 460617
2101-1005155	Guarnición termostato	GS	1 460245
	Arandela A 16 x 24 x 1.5 A	AL	1
	Arandela A 7 x 12.5 x 2 C	CU	3
	Arandela A 14 x 18 x 1.5 A	AL	1
	Jgo. retén válvulas (8)	P	1 R450010P
0236.44	Retén árbol levas 36 x 50 x 8	V	1 R460213V

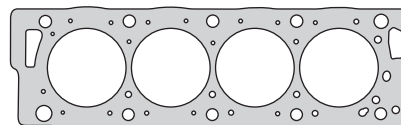

460607



460210/1

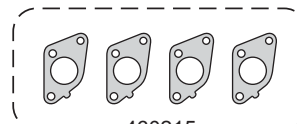

460215

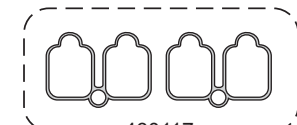

460117

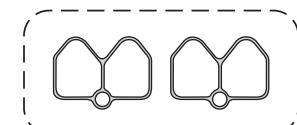

460617



460245



A 16 x 24 x 1.5 A



A 14 x 18 x 1.5 A



A 7 x 12.5 x 2 C



R460213V



R450010P

# PEUGEOT



Motor/Engine	Cm³	HP	Ø
DJ5TED (THX) (SOHC) 8V	2445	107	92

**Citroën:** Jumper TDI, Relay TDI 1997/...  
**Peugeot:** Boxer TDI 1997/...

DIESEL



Nº OE	Descripción/Description	Mat.	Ref.
	<b>Jgo. de juntas para motor</b>		● 452000-R MLS
	<b>Junta tapa cilindros Ø 93.0 ± 1.40</b>	ACG 1	452008
	<b>Jgo. tornillos tapa cilindros (HAE14038)</b>		B452000
	<b>Sellador líquido - caucho de silicona</b>		TRN0085G
	Junta tapa válvulas	N 1	470010
	Tapa bomba de agua	NFT 1	470014
	Múltiple escape	AC 1	452015
	Jgo. múltiple admisión (2)	NB 1	452017
	Placa termostato	NH 1	460232
	Lateral cuerpo bomba agua	NFT 1	470033
	Acople bomba agua	NFT 1	470034
	Junta	CB 1	470035
	Acople bomba de agua	NFT 1	470036
	O´ring entrada depresora G 44 x 2	GS	460340
	O´ring salida depresora G 16 x 2	GS	460341
	Kit de arandelas (5)	AC/GS 1	452075
	Arandela A 7 x 17 x 1 C	CU 4	
	Arandela A 6.5 x 10 x 1 C	CU 1	
	Arandela A 16.6 x 24 x 2.35	AC/GS 2	
	Arandela A 12.7 x 18 x 2.2	AC/GS 1	
	Arandela A 6.5 x 13.1 x 1.75	AC/GS 2	
	Kit de retenes completo		R452000
	Jgo. retén válvulas (8)	V 1	R452010V
	Retén bancada 98 x 120 x 7	V 1	R470011V
	Retén distribución 64 x 88 x 6	V 1	R470012V
	Retén árbol levas 35 x 50 x 7	V 1	R470013V
	Retén auxiliar 32 x 52 x 7	V 1	R471115V

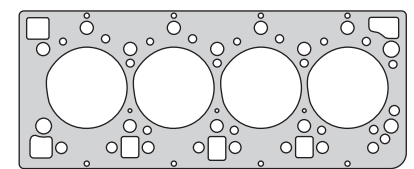

452008

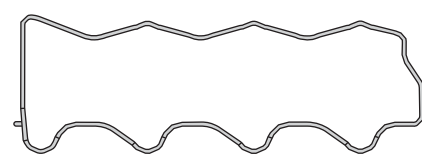

470010

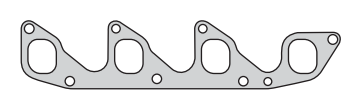

452015

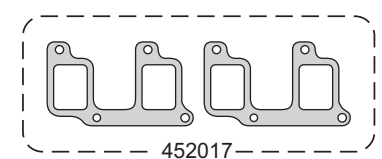

452017

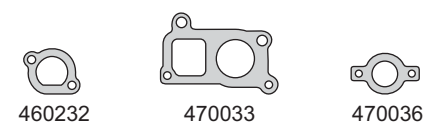

460232

470033

470036

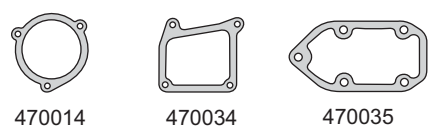

470014

470034

470035

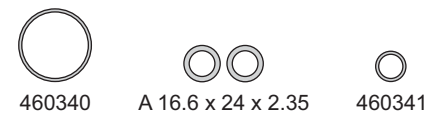

460340

A 16.6 x 24 x 2.35

460341

A 6.5 x 13.1 x 1.75

A 6.5 x 10 x 1 C

A 12.7 x 18 x 2.2

A 7 x 17 x 1 C

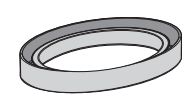

R470011V



R470012V



R470013V



R471115V

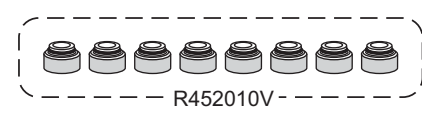

R452010V

# PEUGEOT



Motor/Engine	Cm³	HP	Ø
TU5JP4 (NFU/N6A) (DOHC) 16V	1587	106/109	78.5

**Citroën:** Berlingo, C3 Pluriel, Xsara 2000/...  
C2, C3 2002/..., 2004/...  
**Peugeot:** 206, 307, Partner 2000/...  
207 SW, 207 Compact



Nº OE	Descripción/Description	Mat.	Ref.
	Jgo. de juntas para motor		452100-R MLS
	Jgo. de juntas superior (MLS)		452195 MLS
	Jgo. de juntas superior		452195
	Junta tapa cilindros Ø 80.0 $\pm$ 1.40 NR	NFT	452105
	Junta tapa cilindros Ø 80.0 $\pm$ 1.20 NR	NFT	452107
	Junta tapa cilindros Ø 80.0 $\pm$ 1.40 NR	NFT	452107-1.4
0209.1E	Junta tapa cilindros Ø 80.0 $\pm$ 0.60 NR	MLS	1 1 452108
0204.81	Jgo. tornillos tapa cilindros (HAE14038)		B452100
0249.A9	Jgo. junta tapa válvulas (2)	N	1 1 452110
0304.C5	Junta para cárter	N	1 1 452111
1206.A0	O'ring bomba de agua G 74 x 3	GS	1 1 452114
0341.G2	Múltiple escape	AC	1 1 452115
0348.95	Jgo. múltiple admisión (4)	N	1 1 452117
1709.24	Salida de escape - hasta 2004	AC	1 1 452118
1709.33	Salida de escape - desde 8/2004	AC	452218
1340.60	Guarnición termostato	GS	471219
0348.Q4	Caja comando inyección	N	1 1 452125
0258.56	Carga de aceite	GS	452129
	Arandela	AC	452131
	Jgo. junta tapa de válvulas (2)	PLAST	1 1 452133
0127.40	Cierre bancada trasera	GS	2 460235
1981.53	O'ring inyector G 7.52 x 3.53	GS	8 8
0313.27	Arandela radiador aceite chica A 14 x 18 x 1.5 A	AL	1
1206.98	O'ring distribución agua G 37.77 x 2.62	GS	1
	Kit de retenes completo		R452100
0956.40	Jgo. retén válvulas (16)	V	1 R230510V
0514.74	Retén bancada 85 x 105 x 8	V	1 R560111V
0514.72	Retén distribución 42 x 66 x 8	V	1 R460712V
0807.246	Retén árbol de levas 38 x 50 x 6	V	2 R452113V

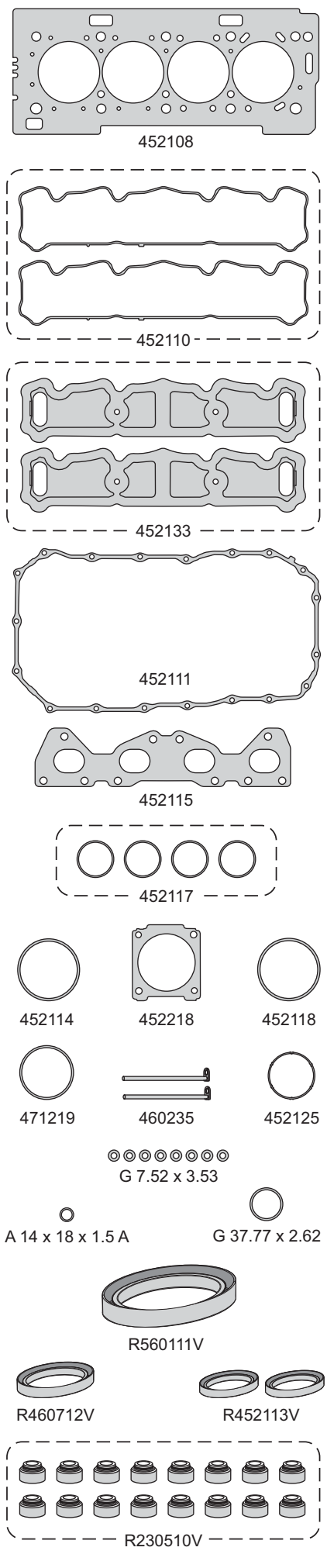

# PEUGEOT



Motor/Engine	Cm³	HP	Ø
TU3JP (KFW)	1360	75	75
TU3JP (K6D)	1360	75	75
TU3JP (KFV)	1360	75	75
TU3-2 (K5A) (SOHC) 8V	1360	75	75

**Citroën:** C2, C3, C3 Pluriel 2002/...  
Berlingo 1997/...

**Fiat:** Qubo, Fiorino Qubo

**Peugeot:** 206/307 2001/..., Partner 2005/...  
207 Compact



Nº OE	Descripción/Description	Mat.	Ref.
	Jgo. de juntas para motor		452200-R
	Jgo. de juntas superior	●	452295
	Junta tapa cilindros Ø 76.0 ± 1.30	NFT 1	451705
0209.CJ	Junta tapa cilindros Ø 76.0 ± 1.30	NFT 1	451707
0204.83	Jgo. tornillos tapa cilindros (HAE14038)		B470500
0249.54	Conj. junta tapa válvulas (3)	GS 1 1	460710
0304.30	Junta para cárter	NB 1 1	460711
01206.A0	O´ring bomba de agua G 75.87 x 2.62	N 1 1	451714
0347.K1	Múltiple escape	AC 1 1	452215
	Múltiple escape	NFT 1 1	452216
0342.E0	Jgo. múltiple admisión (4)	S 1 1	452217
1709.33	Junta catalizador	AC 1 1	452218
	Junta cuello bomba de agua	NB 1 1	451619
	Junta	NB 1 1	452219
	Junta	CB 1 1	451530
	Junta	CB 1 1	451730
	Junta	NFT 1	452230
0348.Q2	Junta acople mariposa	GS 1 1	452231
	Arandela tapa válvulas	GS 2 2	451732
	Junta	NB 1 1	452232
	Salida de escape	NFT 1 1	452245
	Jgo. sellos camisa cilindros (4)	GS 1	550671
	Arandela A 8 x 18 x 1.5 F	NB 2 2	
	Anillo G 45 x 49 x 5	GS 1	
	Kit de retenes completo		R460700
0956.25	Jgo. retén válvulas (8)	V 1	R460710V
0514.74	Retén bancada trasera 85 x 105 x 8	V 1	R560111V
0514.72	Retén distribución 42 x 66 x 8	V 1	R460712V
0236.21	Retén árbol levas 36 x 50 x 8	V 1	R460213V

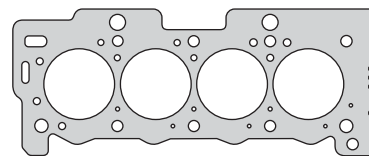

451705

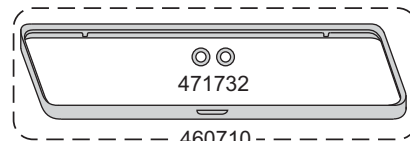

471732

460710

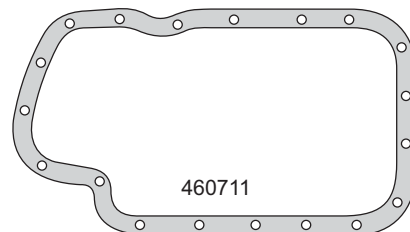

460711

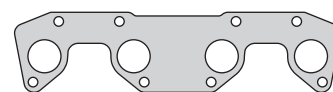

452215

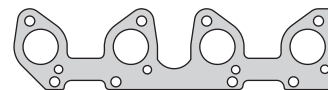

452216



452217

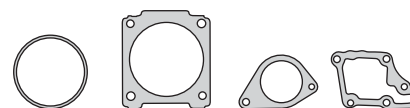

451714

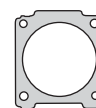

452218



451619



452219



451530



452230



451730



452231



452232



G 45 x 49 x 5



452245



A 8 x 18 x 1.5 F

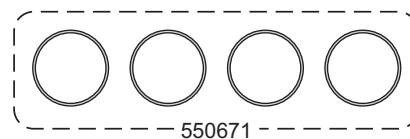

550671



R560111V



R460712V



R460213V

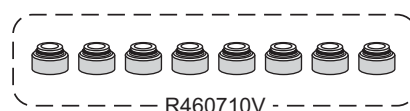

R460710V

# PEUGEOT



Motor/Engine	Cm³	HP	Ø
XU7JP-XU7JB (SOHC) 8V	1761	90/103	83

**Citroën:** Xantia 1997/01, Xsara 1997/...  
**Peugeot:** 306 1993/..., 405/406 1992/...  
 406 1997/...



Nº OE	Descripción/Description	Mat.	1	2	Ref.
	Jgo. de juntas para motor			●	460100-R
	Jgo. de juntas superior		●		460195
	Junta tapa cilindros Ø 84.0 ± 1.40	NFT			460205
	Junta tapa cilindros Ø 84.0 ± 1.20	NFT			460207-1.20
2101-1003020	Junta tapa cilindros Ø 84.0 ± 1.40	NFT	1	1	460207
0204.970	Jgo. tornillos tapa cilindros (HAE14038)				B460100
2101-1003270	Conj. junta tapa válvulas (4)	N	1	1	460610
2101-1003070	Junta para cárter	NB		1	460211
2101-1307046	Bomba de agua	NB		1	460214
2101-1002064	Jgo. múltiple escape (4)	NFT		1	460215
1723630	Múltiple escape - 405 SRI	NFT	1	1	460615
2105-1002064	Jgo. múltiple admisión (2) - 406	GS	1	1	460617
	Jgo. múltiple admisión (4)	GS	1	1	460617-1
0348 F60	Jgo. múl. admisión (2) -306/405/Xantia/Xsara	GS	1	1	460117
	Salida de escape (todos)	NFT	1	1	460618
0.147.140	Porta retén frente motor	CB		1	460329
0365.260	Anillo caja mariposa admisión	GS	1		460430
2101-1008081	Placa termostato	NB	1	1	460232
2108-1107990	Bastón cierre bancada	GS		2	460235
2101-1005155	Guarnición termostato	GS	1	1	460245
	Jgo. suplemento camisas de cilindros (4)	GS		1	460270
2101-1303020	Arandela A 14 x 18 x 1.5 A	AL		1	
2101-1307048	Arandela A 16 x 22 x 1.5 A	AL		1	
2105-1005255	Arandela A 12 x 18 x 3 C	CU		1	
2101-1011021	Arandela A 15 x 20 x 1 C	CU		1	
	Arandela A 18 x 24 x 1.5 C	CU		1	
2101-1106170	O'ring G 4.47 x 1.78	GS		5	
2101-100608	Arandela A 8 x 12 x 1 C	CU		4	
	Arandela A 8 x 14 x 1.5 F	NB	3	3	
	Kit de retenes completo				R460200
2101-1107080	Jgo. retén válvulas (8)	V		1	R460210V
2101-1303017	Retén bancada 90 x 110 x 7	V		1	R460211V
2101-1303038	Retén distribución 42 x 62 x 7	V		1	R460212V
2101-1107015	Retén árbol levas 36 x 50 x 8	V		1	R460213V

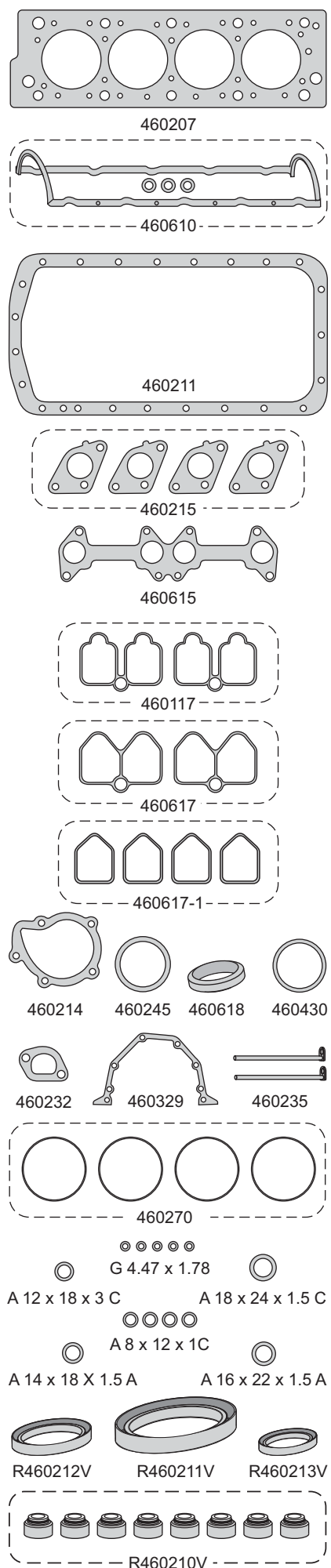

# PEUGEOT



Motor/Engine	Cm³	HP	Ø
XU92C	1905	96/104	83
XU92C (SOHC) 8V	1905	102/125	83

Citroën: BX19 1984/93, BX19 GTI 1983/93  
 Peugeot: 306, 405, 309GT, 305GTX 1986/93



Nº OE	Descripción/Description	Mat.	Ref.
	Jgo. de juntas para motor		460200-R
	Jgo. de juntas superior	●	460295
	Jta. tapa cilindros Ø 84.0 ±1.40	NFT	460205
0209.E10	Jta. tapa cilindros Ø 84.0 ±1.40	NFT	1 1 460207
	Jta. tapa cilindros Ø 84.0 ±1.20	NFT	460207-1.2
	Jgo. tornillos tapa cilin. (HAT55055/55100)		B460200
0249.480	Jgo. junta tapa válvulas (4)	N	1 1 460210
0304.340	Junta para cárter	NB	1 1 460211
1206.460	Bomba de agua	NB	1 1 460214
0349.700	Jgo. múltiple escape (4)	NFT	1 1 460215
0348.910	Múltiple admisión inyección	NB	1 1 460217
1710.390	Salida de escape	NFT	1 1 460218
1339.530	Termostato	GS	2 460219
	Guarnición termostato	GS	460719
	Jgo. juntas carburador solex 34-34	VS	460220
	Base carburador	NB	2 1 460225
	Tapa carburador	CB	460226
1451.070	Bomba nafta	NB	460228
	Base bomba nafta	NB	2 550628
0164.300	Tapón cárter/bulbo agua block B16 x 22 x 2.4 CN	CN	450229
0310.040	Junta alojamiento termostato	CG	1 460229
1339.790	Colector tubo agua	NB	1 460230
1451.070	Superior bomba agua	CB	460231
0147.120	Placa termostato	NH	1 1 460232
1339.410	Alojamiento termostato	NB	1 1 460233
1339.640	Colector canalización agua	GS	460234
0127.050	Bastón cierre bancada	GS	2 460235
0163.530	Arandela tapón block A 22.5 x 29 x 2 C	CU	2 460236
1505.580	Tubo llenado aceite	GS	1 1 460237
	Arandela tubería aceite A 6 x 11 x 2 C	CU	4 4 460239
	O´ring G 19.18 x 2.46	GS	1 460240
	Múltiple admisión carburador	NB	1 1 460241
	Base carburador superior	NB	1 1 460242
	Guarnición termostato	GS	1 460245
0112.780	Jgo. suplemento camisa cilindros (4)	S	1 460270
	Arandela A 14 x 22 x 1.5 C	CU	1
	Arandela A 7 x 17 x 1.5 FA	NB	3 3
	Arandela A 16 x 22 x 1.5 A	AL	4
	Kit de retenes completo		R460200
0119.060	Jgo. retén válvulas (8)	V	1 R460210V
0326.220	Retén bancada 90 x 110 x 7	V	1 R460211V
0514.150	Retén distribución 42 x 62 x 7	V	1 R460212V
0236.210	Retén árbol levas 36 x 50 x 8	V	1 R460213V

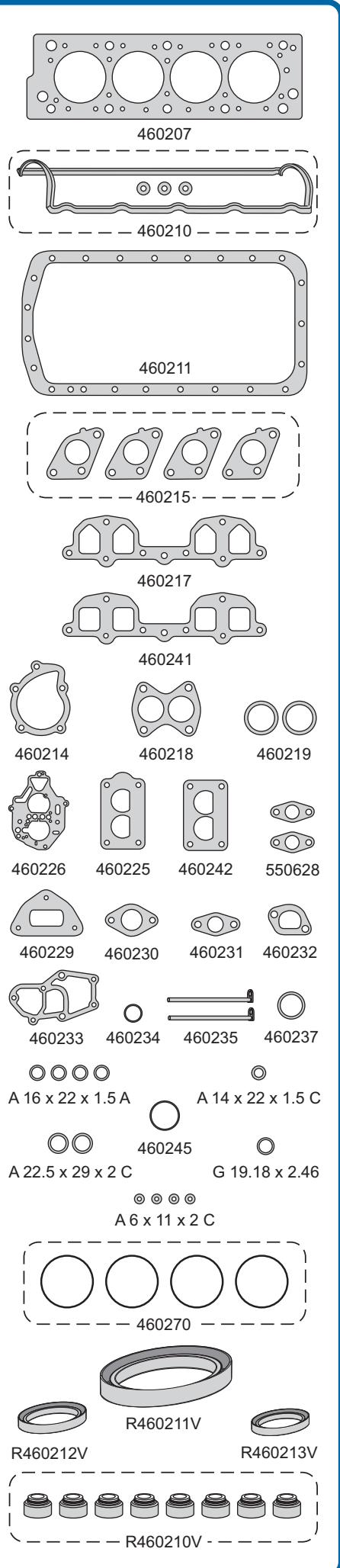

# PEUGEOT



Motor/Engine	Cm³	HP	Ø
XUD9 (SOHC) 8V	1905	64/71	83
<b>DIESEL</b>			

**Citroën:** Xantia, Dispatch, Xsara, Jumper  
**Hyundai:** Lantra 1998/...  
**Lada:** Niva 2121, Aleko 1990/...  
**Peugeot:** 205/305/306/309/405, Express, Boxer  
**Rover:** 218, 418 1991/96  
**Suzuki:** Vitara 1995/96



Nº OE	Descripción/Description	Mat.	Ref.
	Jgo. de juntas para motor		460301-R
	Jgo. de juntas para motor		460300-R 1M
	Jgo. de juntas para motor		460300-R 2M
	Jgo. de juntas para motor		460300-R 3M
	Jgo. de juntas superior		460395-1M
	Jgo. de juntas superior		460395-2M
	Jgo. de juntas superior		460395-3M
	Jgo. de juntas superior		460395-4M
	Jgo. juntas superior sin JTC		460396
0.209.S9	Junta tapa cilindros Ø 84.0 $\pm$ 1.50	NFT 1	460307-1M
0.209.K8	Junta tapa cilindros Ø 84.0 $\pm$ 1.60	NFT	460307-2M
0.209.K1	Junta tapa cilindros Ø 84.0 $\pm$ 1.70	NFT	460307-3M
	Junta tapa cilindros Ø 84.0 $\pm$ 1.80	NFT	460307-4M
0.204.65	Jgo. tornillos tapa cilin.		B460300
0.249.910	Conj. junta tapa válvula (4)	N 1 1	460310
0.304.340	Junta para cárter	NB 1	460211
1.206.460	Bomba de agua	NB 1	460214
0.349.780	Jgo. múltiple escape (2)	NFT 1 1	460316
0.348.J0	Múltiple admisión y escape	NFT 1 1	460317
0.365.34	Jgo. entre colec. adm. aspirado G 37 x 4 (4)	GS 1 1	460917
0.348.N8/P0	Jgo. múltiple admisión aspirado (3)	NB 1 1	470617
0.348.98/99	Jgo. múltiple admisión (3)	NB 1 1	470917
1.710.99	Salida de escape	AC 1 1	460318
1.339.730	Cuerpo termostato	NB 1 1	460319
0.236.32	Junta porta varilla a nivel aceite	CG 1	460229
0.147.140	Porta retén frente motor	CB 1	460329
0.147.120	Placa termostato	NB 1 1	460232
1.339.620	Base termostato	NB 1 1	460332
1.339.410	Inspección	NB 1	460333
0.236.320	Base termostato	NB 1 1	460334
0.197.050	Bastón bancada	GS 2	460235
	Arandela parallamas inyector	AC	560036
	Arandela A 7 x 17 x 1.5 FA	F 3 3	460339
7703061078	Arandela base inyector A 16 x 21 x 2 C	CU 4 4	500240
0.455605	O´ring entrada depresora G 44 x 2	GS 1 1	460340
0.455606	O´ring salida depresora G 16 x 2	GS 1 1	460341
	Cierre termostato	GS 1 1	550641
	O´ring G 18.72 x 2.62	GS 1	
	O´ring G 29.87 x 1.78	GS 1	
	O´ring G 37 x 4	GS 1	
	Arandela A 6 x 11 x 2 C	CU 2	
	Arandela A 14 x 17.2 x 2 C	CU 2	
1.981.050	Arandela A 12 x 18 x 3 A	AL 1	
0.164.300	Arandela A 22 x 29 x 1.5 A	AL 1	
0.956.220	Arandela cierre termostato A 15 x 21 x 1.5 C	CU 2	
	Arandela A 7 x 14 x 1 H	H 4	
0.313.270	Arandela tapón cárter A 14 x 21 x 2 C	CU	
	Arandela A 16 x 21 x 1.5 C	CU 2	
	Arandela A 16 x 22 x 1.5 A	AL 3	
	Kit de retenes completo		R460300
0.119.060	Jgo. retén válvulas (8)	V 1	R460210V
0.326.220	Retén bancada 90 x 110 x 7	V 1	R460211V
0.514.150	Retén distribución 42 x 62 x 7	V 1	R460212V
0236.44	Retén árbol de levas 35 x 50 x 7	V 1	R470013V

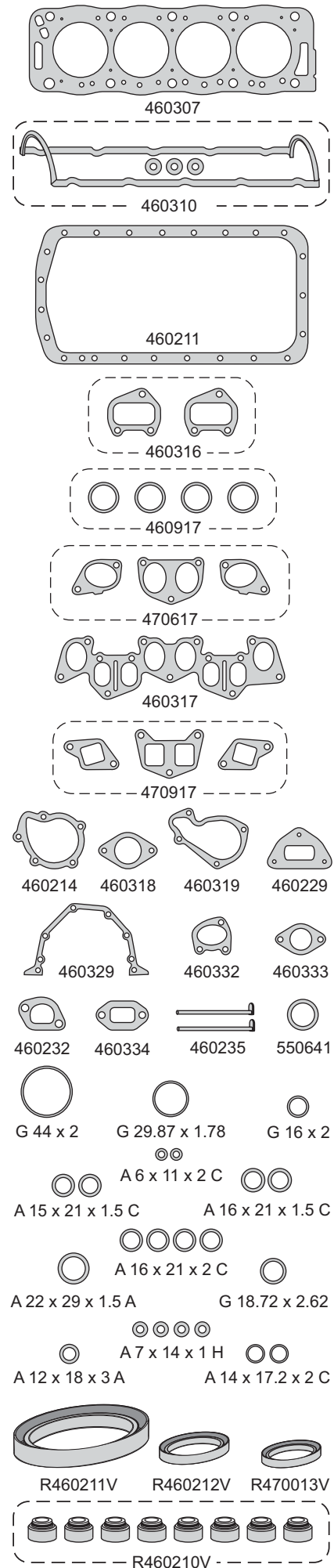



# PEUGEOT



Motor/Engine	Cm³	HP	Ø
XU10J2TE (SOHC) 8V	1998	150	86

Peugeot: 406, 605, 806 Turbo 1996/...



Nº OE	Descripción/Description	Mat.	Ref.
	Jgo. de juntas para motor		460400-R
	Jgo. de juntas superior		460495
2101-1003020	Jta. tapa cilindros Ø 87.0 ± 1.50	NFT	1 1 460607
	Jgo. tornillos tapa cilin. (HAT55055/55100)		B460300
0249.480	Junta tapa válvulas	N	1 1 460210/1
2101-1003070	Junta para cárter	NB	1 1 460211
2101-1307046	Bomba de agua	NB	1 1 460214
	Jgo. múltiple escape (4)	NFT	1 1 460215
1723630	Múltiple escape SRI	NFT	1 1 460615
0348.N00	Jgo. múltiple admisión (2)	GS	1 1 460417
	Salida de escape	NFT	1 1 460618
2101-1008081	Placa termostato	NH	1 1 460232
0365.260	Anillo caja mariposa admisión	GS	1 1 460430
	Guarnición sello de goma A 16.8 x 24 x 1.5	AC/GS	1 1 460431
2108-1107990	Bastón cierre bancada	GS	2 1 460235
1339.83	Guarnición distribuidora de agua	GS	1 1 470637
2101-1005155	Guarnición termostato	GS	1 1 460245
2101-1303020	Arandela A 14 x 18 x 1.5 A	AL	1 1
2101-1307048	Arandela A 16 x 22 x 1.5 A	AL	1 1
2105-1005255	Arandela A 12 x 18 x 3 C	CU	1 1
2101-1011021	Arandela A 16 x 20 x 1.5 C	CU	1 1
	Arandela A 18 x 22 x 1.5 C	CU	1 1
2101-1106170	O'ring G 4.47 x 1.78	GS	5 1
2101-100608	Arandela A 8 x 11 x 1 C	CU	4 1
	Arandela A 7 x 12.5 x 2 C	CU	3 1
	Kit de retenes completo		R460200
2101-1107080	Jgo. retén válvulas (8)	V	1 R460210V
2101-1303017	Retén bancada 90 x 110 x 7	V	1 R460211V
2101-1303038	Retén distribución 42 x 62 x 7	V	1 R460212V
2101-1107015	Retén árbol levas 36 x 50 x 8	V	1 R460213V
0236.240	Retén árbol levas trasero 32 x 45 x 8	S	R460414S

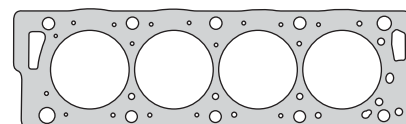

460607



460210/1

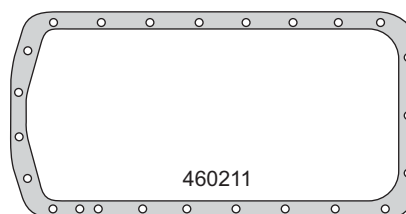

460211



460615

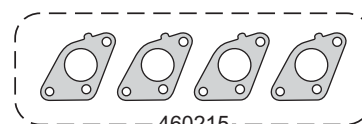

460215

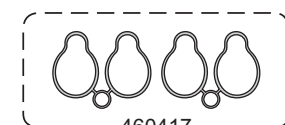

460417

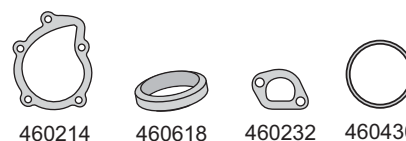

460214 460618 460232 460430

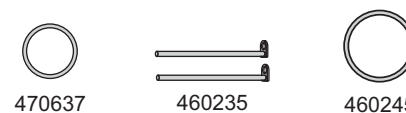

470637 460235 460245



A 8 x 11 x 1 C

A 14 x 18 x 1.5 A A 16 x 22 x 1.5 A



G 4.47 x 1.78

A 7 x 12.5 x 2 C A 18 x 22 x 1.5 C

A 12 x 18 x 3 C A 16 x 20 x 1.5 C



R460211V



R460212V R460213V R460414S



R460210V

# PEUGEOT



Motor/Engine	Cm³	HP	Ø
108C - XV3/5/8	954	45	70
109/5-109/K	1124	57	72
XW3/7	1124	55/57	72
129/5-XZ5	1219	57/64	75
150	1360	70/72	75
XY6B-XY7/8	1360	70	75

**Citroën:** C15 1985/..., Visa 10 1986/88  
 Visa 11, C15 197/85 - 1985/...  
 Visa GT, BX14 1982/85 - 1985/...  
**Peugeot:** 104, 205 1972/86 - 1986/87  
 205 1986/87, 104 1986/...  
 205 1986/87



Nº OE	Descripción/Description	Mat.	Ref.
	Jgo. de juntas para motor	●	460500-R
	Jgo. de juntas para motor		451800-R
	Junta tapa cilindros Ø 76.5 $\pm$ 1.25	NFT 1	460507
	Junta tapa cilindros Ø 76.0 $\pm$ 1.20	NFT 1	451807
	Junta tapa válvulas	GS 1	460510
	Junta para cárter	NB 1	460511
	Frente distribución BV4	GS 1	460512
	Frente distribución BV5	GS 1	460513
	Bomba de agua	NB 1	460514
	Múltiple escape	NFT 1	460516
	Jgo. múltiple admisión	NB 1	460517
	Salida de escape	FCH 1	450018
	Base carburador	NB 1	460525
	Base carburador	NB 1	460526
	Base bomba nafta	NB 1	550428
	Frente distribución	GS 1	460540
	Frente distribución	GS 1	460541
	Cubierta trasera embrague	NB 1	460552
	Cubre volante embrague	NB 1	460553
	Jgo. retén vávulas (8)	V 1	R460510V

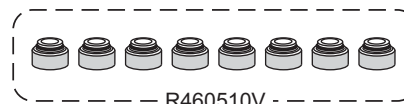
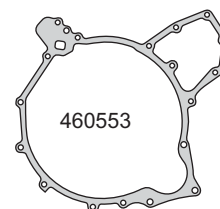
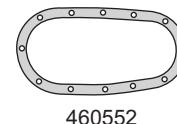
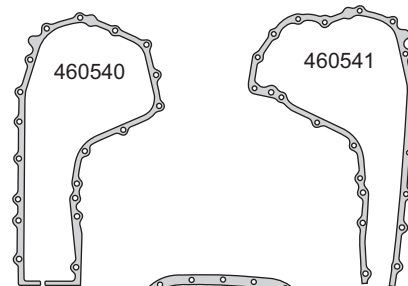
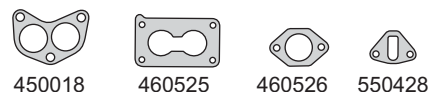
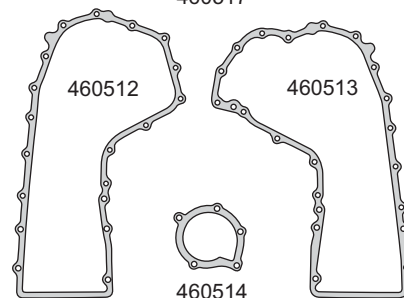
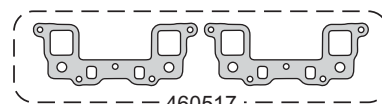
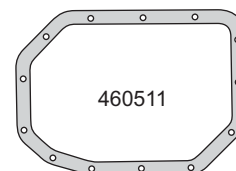
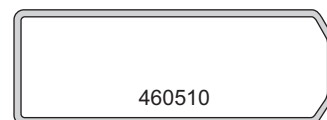
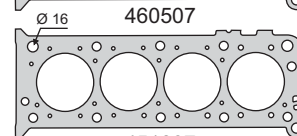
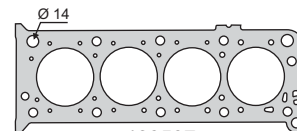

# PEUGEOT



Motor/Engine	Cm³	HP	Ø
XU10J2C (SOHC) 8V	1998	123	86

Citroën: ZX 1992/..., Xantia 1993/98  
 Peugeot: 405 1992/..., 306 1993/...

Nº OE	Descripción/Description	Mat.	Ref.
	Jgo. de juntas para motor		460600-R
	Jgo. de juntas superior		460695
2101-1003020	Jta. tapa cilindros Ø 87.0 ± 1.50	NFT	1 1 460607
	Jgo. tornillos tapa cilin. (HAT55055/55100)		B460300
2101-1003270	Conj. junta tapa válvulas (4)	N	1 1 460610
2101-1003070	Junta para cárter	NB	1 1 460211
2101-1307046	Bomba de agua	NB	1 1 460214
1723630	Múltiple escape SRI	NFT	1 1 460615
2101-1002064	Jgo. múltiple escape (4)	NFT	1 1 460215
	Jgo. múltiple admisión (2)	GS	1 1 460417
2105-1002064	Jgo. múltiple admisión (2)	GS	1 1 460617
	Salida de escape	NFT	460618
	Anillo termostato	GS	460719
0.147.140	Porta retén trasero motor	CB	1 460329
0365.260	Anillo caja mariposa admisión	GS	1 460430
2101-1008081	Placa termostato	NH	1 1 460232
1339.410	Alojamiento termostato	NB	1 1 460233
	Arandela radiador aceite chica B 14 x 18 x 2 CN	CN	150034
2108-1107990	Bastón cierre bancada	GS	2 460235
	Guarnición distribución agua	GS	1 470637
2101-1005155	Guarnición termostato	GS	1 1 460245
2101-1303020	Arandela B 14 x 20 x 2.5 CN	CN	
2101-1307048	Arandela blindada A 16 x 22 x 1.5 A	AL	1
2105-1005255	Arandela A 12 x 18 x 3 C	CU	1
2101-1011021	Arandela A 15 x 20 x 1 C	CU	1
	Arandela A 18 x 23 x 1 C	CU	1
	Arandela A 8 x 14 x 1.5 F	NB	3 3
2101-1106170	O'ring G 4.47 x 1.78	GS	5 5
2101-100608	Arandela A 8 x 12 x 1 C	CU	
	Arandela A 14 x 18 x 1.5 A	AL	1
	Kit de retenes completo		R460200
2101-1107080	Jgo. retén válvulas (8)	V	1 R460210V
2101-1303017	Retén bancada 90 x 110 x 7	V	1 R460211V
2101-1303038	Retén distribución 42 x 62 x 7	V	1 R460212V
2101-1107015	Retén árbol levas 36 x 50 x 8	V	1 R460213V

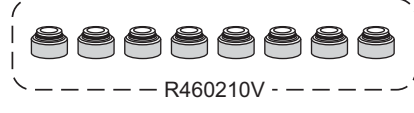
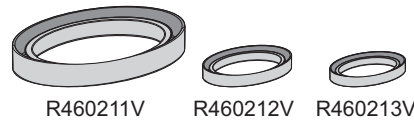
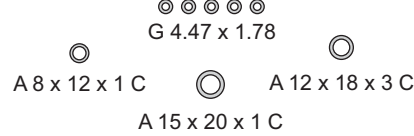
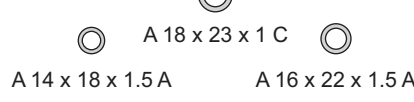
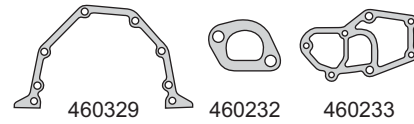
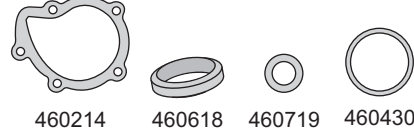
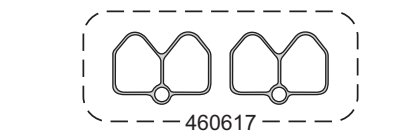
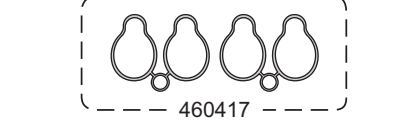
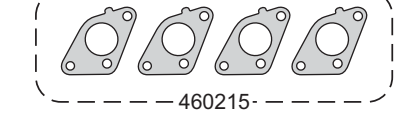
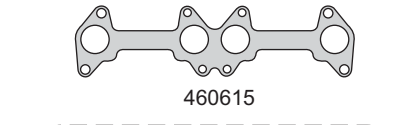
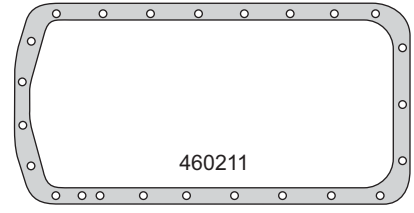
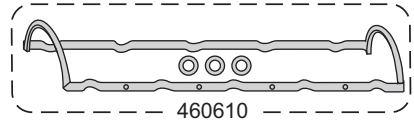
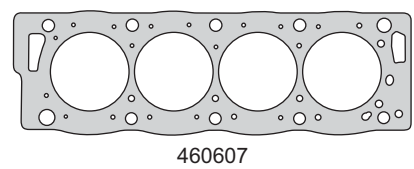

# PEUGEOT



Motor/Engine	Cm³	HP	Ø
TU1/M/MZ/K/Z	1124	55/60	72
TU24/M4A	1294	94/102	75
TU3MC/JPI/A	1360	65/70	75
TU3S/M/K (SOHC) 8V	1360	75/80	75

**Citroën:** AX 11, BX 11, C15, AX 14, AX GT  
 AX Sport, BX 14, C15 1986/...  
 ZX 1991/98, Saxo, Xsara 1996/...

**Peugeot:** 106 1991/..., 306 93/97, 205 1987/96  
 309, 205 Rallye 1988/93, 405 1987/96  
 Partner 1996/..., 206 1998/...



Nº OE	Descripción/Description	Mat.	Ref.
	Jgo. de juntas para motor		460700-R
	Jgo. de juntas superior	●	460795
	Jta. tapa cilindros Ø 76.0 ±1.40	NFT 1 1	460707
	Jgo. tornillos tapa cilindros (HAE14038)		B470500
	Conj. junta tapa válvulas (3)	GS 1 1	460710
	Junta para cárter	NB 1 1	460711
	Jgo. múltiple escape (2)	NFT 1 1	460716
	Jgo. múltiple escape (2)	AC	460715
	Jgo. múltiple admisión (2)	NB 1 1	460717
	Salida de escape	NFT 1 1	460718
	Junta cuello bomba de agua	NB 1	451619
	Guarnición termostato	GS	460719
	Junta asiento carburador	NB 1 1	460730
	Junta	NB 1 1	460731
	Arandela tapa válvulas	GS 2 2	451732
	Guarnición termostato	GS 1 1	460245
	Jgo. suplemento camisas cilindros (4)	S 1	550671
	Arandela A 12 x 18 x 1 C	CU 1	
	Arandela A 22 x 30 x 2 C	CU 2	
	Arandela A 8 x 20 x 1.5 F	NB	
	Arandela A 16 x 22 x 1.5 A	AL 2	
	O'ring G 79.5 x 3	GS 1	
	O'ring G 37.47 x 3	GS 3 3	
	O'ring G 21.82 x 3.53	GS 2	
	O'ring G 58.42 x 2.62	GS 1	
	Kit de retenes completo		R460700
	Jgo. retén válvulas (8)	V 1	R460710V
0514.74	Retén bancada 85 x 105 x 8	V 1	R560111V
0514.72	Retén distribución 42 x 66 x 8	V 1	R460712V
0236.44	Retén árbol de levas 36 x 50 x 8	V 1	R460213V

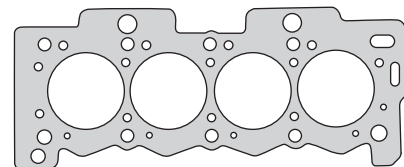

460707

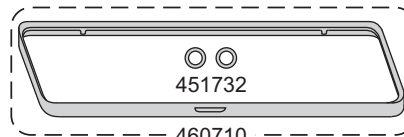

451732

460710

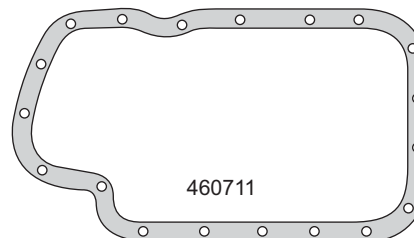

460711

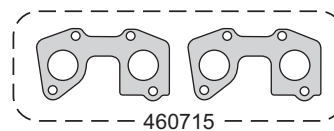

460715

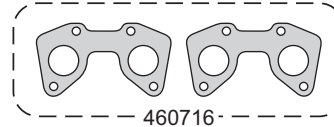

460716

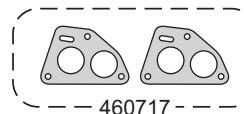

460717

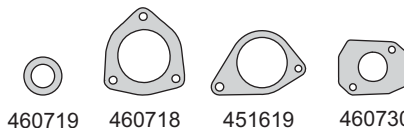

460719 460718 451619 460730

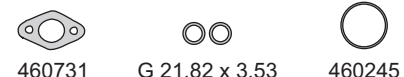

460731 G 21.82 x 3.53 460245

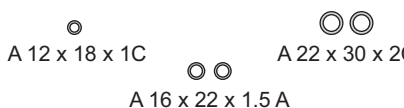

A 12 x 18 x 1C A 22 x 30 x 2C

A 16 x 22 x 1.5 A



G 58.42 x 2.62 G 37.47 x 3 G 79.5 x 3

A 8 x 20 x 1.5 NH



550671



R560111V



R460712V



R460213V



R460710V

# PEUGEOT



Motor/Engine	Cm³	HP	Ø
XU7JP4 (DOHC) 16V	1761	112	83

**Citroën:** Xsara 1997/..., Xantia 1995/96  
Xantia 1997/2001, ZX 1997/98  
**Peugeot:** 306 1997/..., 406 1995/96  
406 1997/...



Nº OE	Descripción/Description	Mat.	Ref.
B197.X170	Jgo. de juntas para motor Jgo. de juntas superior		460800-R 460895
B209.930	Jta. tapa cilindros Ø 84.0 ± 1.40 NR <sup>3</sup>	NFT	1 1 460807
B204.800	Jgo. tornillos tapa cilindros (HAE14038)		B460800
0249.A2/A3	Conj. junta tapa válvulas (2)	GS	1 1 460810
0340.340	Junta para cárter	NB	1 1 460211
1206.A40	Bomba de agua	NB	1 1 460214
0349.400	Múltiple escape - Hasta 1996	NFT	1 1 460815
0349.H0	Múltiple escape - Desde 1997	AC	460815-1
0348.C8	Múltiple admisión	NB	1 1 460817
0.147.140	Porta retén frente motor	CB	1 1 460329
	Arandela A 6.7 x 13.5 x 1	AC/GS	10 460830
1340.330	Alojamiento termostato	NB	1 1 460833
0127.050	Bastón cierre bancada	GS	2 460235
	Tubo llenado aceite	GS	1 1 460237
0348.K6	Jgo. múltiple admisión (5) 1997/...	GS	1 1 460841
	Múltiple admisión mariposa	GS	1 1 460842
1340.480	Guarnición termostato	GS	1 1 460245
0112.780	Jgo. suplemento camisas cilindros (4)	CU	1 460270
	Arandela A 7 x 14 x 1 A	AL	10
	Arandela A 16 x 21 x 1.5 C	CU	1
	Arandela A 14 x 18 x 1.5 A	CU	1
	Arandela A 6 x 10.5 x 2 C	AL	1
	Arandela A 6 x 10 x 1 A	GS	3
	O'ring G 9.25 x 1.78	GS	1
	Kit de retenes completo		R460800
0956.420	Jgo. retén válvulas (16)	V	1 R460810V
0127.280	Retén bancada 90 x 110 x 7	V	1 R460211V
0326.220	Retén distribución 42 x 62 x 7	V	1 R460212V
0236.440	Retén árbol levas 36 x 50 x 8	V	2 R460213V

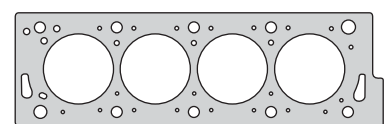

460807

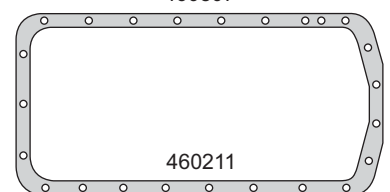

460211

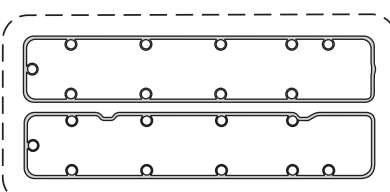

460810

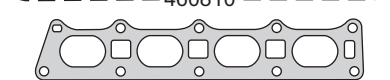

460815

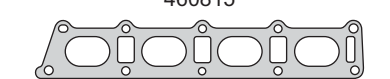

460815-1

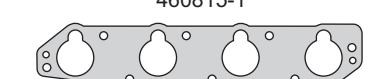

460817

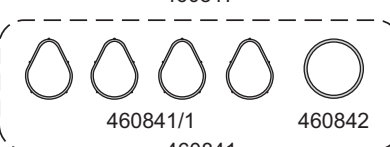

460841/1

460842

460841

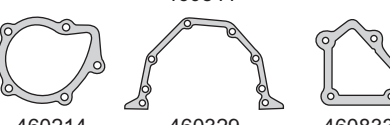

460214

460329

460833

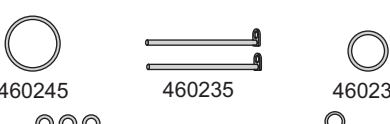

460245

460235

460237



A 6 x 10 x 1 A

G 9.25 x 1.78



A 6.7 x 13.5 x 1



A 14 x 18 x 1.5 A

A 6 x 10.5 x 2 C



A 7 x 14 x 1 A

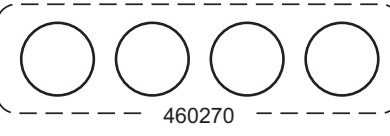

460270



R460211V



R460212V

R460213V

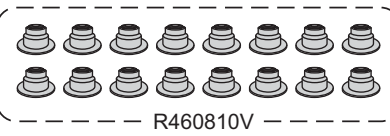

R460810V

# PEUGEOT



Motor/Engine	Cm³	HP	Ø
XUD9TE/TF	1905	90/92	83
XUD9SD/TF	1905	76/90	83
D8B/DHX (SOHC) 8V	1905	92	83

**Citroën:** Xantia, ZX, Jumpy, Dispatch Jumper TD, 1993/..., Xsara TD 1997/...  
**Fiat:** Ducato TD 1994/..., Scudo TD 1995/01  
**Peugeot:** 306/405 TD 1992/97, 406 TD 1995/99 806TD, Expert TD, Boxer TD 1995/...  
**Suzuki:** Vitara TD 1996/...



DIESEL

Nº OE	Descripción/Description	Mat.	Ref.
	Jgo. de juntas para motor		460301-R
	Jgo. de juntas superior (MLS)		460995-1M MLS
	Jgo. de juntas superior (MLS)		460995-2M MLS
	Jgo. de juntas superior (MLS)		460995-3M MLS
	Jgo. de juntas superior (MLS)		460995-4M MLS
	Jgo. de juntas superior (MLS)		460995-5M MLS
	Jgo. juntas superior sin JTC	NFT	460996
	Junta tapa cilindros Ø 84.0 $\pm$ 1.50	NFT	460907-1M
	Junta tapa cilindros Ø 84.0 $\pm$ 1.60	NFT	460907-2M
	Junta tapa cilindros Ø 84.0 $\pm$ 1.70	MLS	460907-3M
9621917180	Junta tapa cilindros Ø 84.0 $\pm$ 1.34	MLS 1	460908-1M
9621917280	Junta tapa cilindros Ø 84.0 $\pm$ 1.38	MLS	460908-2M
9621917380	Junta tapa cilindros Ø 84.0 $\pm$ 1.42	MLS	460908-3M
9621917480	Junta tapa cilindros Ø 84.0 $\pm$ 1.50	MLS	460908-4M
9621917580	Junta tapa cilindros Ø 84.0 $\pm$ 1.55		460908-5M
0204.65	Jgo. tornillos tapa cilin. (HAT55055/55100)	N	B460900
0249.910	Conj. junta tapa válvula (4)	NB 1 1	460310
0.304.26	Junta para cárter	NB 1 1	460211
1.206.460	Bomba de agua	NFT 1	460214
0.349.47	Jgo. múltiple admisión (2)	NFT 1 1	460316
0.348.50	Múltiple admisión y escape turbo	NB 1 1	460317
0.348.N1/N2	Jgo. múltiple admisión (3)	NB 1 1	470617
0348.98/99	Jgo. múltiple admisión (3)	AC 1 1	470917
1721.01	Salida de escape	NB 1 1	460318
1339.62	Cuerpo termostato	CN 1 1	460319
	Arandela B 16 x 22 x 2.4 CN	CG	450229
0.164.300	Junta alojamiento termostato	CB 1	460229
0.147.140	Junta porta retén b/atras	NH 1	460329
0.147.120	Placa termostato	NB 1 1	460232
1.339.620	Base termostato	NB 1 1	460332
1.339.410	Inspección	NB 1	460333
0.236.320	Base termostato	GS 1 1	460334
0.197.050	Bastón bancada	AC 2	460235
1.981.020	Arandela parallamas pico inyector	H	560036
	Arandela A 7 x 14 x 1 H	CU 4	460339
7703061078	Arandela base inyector A 16 x 21 x 2 C	GS 4 4	500240
0.455605	O´ring entrada depresora G 44 x 2	GS 1 1	460340
0.455606	O´ring salida depresora G 16 x 2	GS 1 1	460341
	Cierre termostato	AL 1 1	550641
1.981.050	Arandela A 12 x 18 x 3 A	AL 1	
0.164.300	Arandela A 22 x 29 x 1.5 A	NB 1	
0.127.050	Arandela tapa válvula A 7 x 17 x 1.5 F	CU 3 3	
	Arandela cierre termostato A 16 x 21 x 1.5 C	CU 2	
	Arandela A 6 x 11 x 2 C	CU 2	
	Arandela A 14 x 17.2 x 2 C	AL 2	
	Arandela A 16 x 22 x 1.5 A	GS 3	
	O´ring G 18.72 x 2.62	GS 1	
	O´ring G 29.87 x 1.78	GS 1	
	O´ring G 37 x 4	4 4	
	Kit de retenes completo	V	R460300
0956.22	Jgo. retén válvulas (8)	V 1	R460210V
0127.28	Retén bancada 90 x 110 x 7	V 1	R460211V
0326.22	Retén distribución 42 x 62 x 7	V 1	R460212V
0236.15	Retén árbol de levas 35 x 50 x 7	1	R470013V

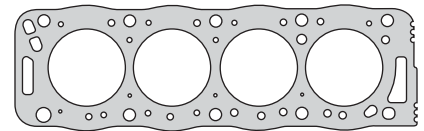

460907

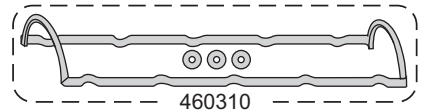

460310

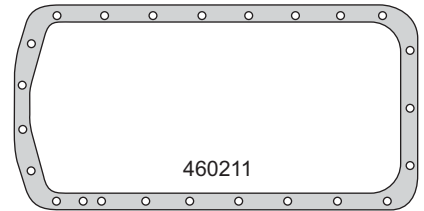

460211

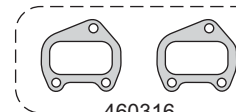

460316

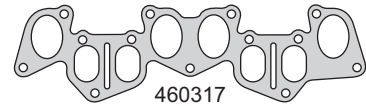

460317



470617

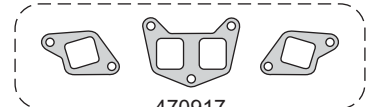

470917



460214 460318 460319 460229



460329 460332 460333

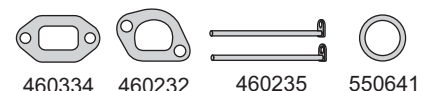

460334 460232 460235 550641



G 44 x 2 G 37 x 4 G 16 x 2



A 12 x 18 x 3 A



A 16 x 21 x 2 C A 16 x 22 x 1.5 A

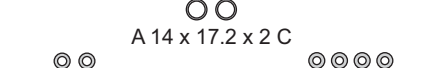

A 14 x 17.2 x 2 C A 6 x 11 x 2 C A 7 x 14 x 1 H

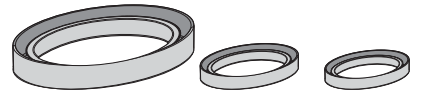

R460211V R460212V R470013V



R460210V

PEUGEOT



Motor/Engine

Cm³

HP

Ø

XU7JB  
(SOHC) 8V



















1761

90

83

Citroën: Berlingo 1997/...

Peugeot: Partner 1997/...

Nº OE	Descripción/Description	Mat.	Ref.
	Jgo. de juntas para motor 		461100-R
	Jgo. de juntas superior 	●	461195
	Jta. tapa cilindros Ø 84.0 ± 1.40 	NFT	460205
	Jta. tapa cilindros Ø 84.0 ± 1.40  N.R. 6	NFT 1	460207
	Jta. tapa cilindros Ø 84.0 ± 1.20  N.R. 6	NFT	460207-1.2
0204.89	Jgo. tornillos tapa cilindros (HAE14038) 		B460100
2101-1003270	Jgo. junta tapa válvulas (4) 	N	1 460610
2101-1003070	Junta para cárter 	NB	1 460211
2101-1307046	Bomba de agua 	NB	1 460214
1723630	Múltiple escape SRI 	NFT	1 460615
0348.263	Jgo. múltiple admisión (4) 	S	1 461117
	Salida de escape 	NFT	1 460618
0365.260	Anillo caja mariposa admisión 	S	1 460430
2101-1008081	Placa termostato	NH	1 460232
2108-1107990	Bastón cierre bancada	GS	2 460235
2101-1005155	Guarnición termostato	GS	1 460245
2101-1303020	Arandela A 14 x 18 x 1.5 A	AL	1
2101-1307048	Arandela A 16 x 22 x 1.5 A	AL	1
2105-1005255	Arandela A 12 x 18 x 3 C	CU	1
2101-1011021	Arandela A 15 x 20 x 1 C	CU	1
	Arandela A 8 x 14 x 1.5 F	NB	3 3
	Arandela A 18 x 23 x 1 C	CU	1
2101-1106170	O'ring G 4.47 x 1.78	GS	5 5
2101-100608	Arandela A 8 x 12 x 1 C	CU	4 4
	Kit de retenes completo 		R460200
2101-1107080	Jgo. retén válvulas (8) 	V	1 R460210V
2101-1303017	Retén bancada 90 x 110 x 7 	V	1 R460211V
2101-1303038	Retén distribución 42 x 62 x 7 	V	1 R460212V
2101-1107015	Retén árbol levas 36 x 50 x 8 	V	1 R460213V

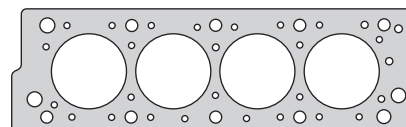

460207

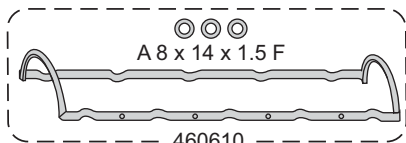

A 8 x 14 x 1.5 F

460610

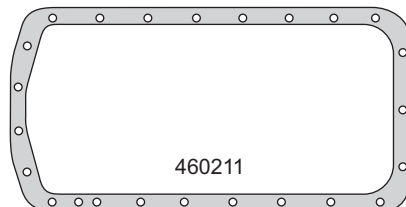

460211



460615



461117



460214



460618



460245



460430



460232



460235



A 14 x 18 x 1.5 A



A 16 x 22 x 1.5 A



G 4.47 x 1.78



A 8 x 12 x 1 C



A 12 x 18 x 3 C



A 8 x 14 x 1.5 F



A 15 x 20 x 1 C



A 18 x 23 x 1 C



R460211V



R460212V



R460213V



R460210V

# PEUGEOT



Motor/Engine	Cm³	HP	Ø
ZEJ	1995	110	88
ZDJ (SOHC) 8V	2165	123	88

Peugeot: 505 Inyección ZEJ, 1979/...  
505 GTI ZDJ, 1982/91



Nº OE	Descripción/Description	Mat.	Ref.
	Jgo. de juntas para motor		461200-R
0209.D9	Junta tapa cilindros Ø 89.0 ±1.40	NFT 1	550605
	Junta tapa cilindros Ø 89.0 ±1.20	NFT	550607
0204.39	Jgo. tornillos tapa cilindros (HAS19038)		B461200
0249.43	Conj. juntas tapa válvulas (4)	GS 1	550610
0304.20	Junta para cárter	CG 1	550611
1019.160	Eje intermedio distribución	NB 1	550613
0349.90	Múltiple escape	NFT	550616
1710.85	Salida de escape	FCH 1	450318
1206.740	Bomba de agua a block	NB 1	550619
	Base bomba aceite	NB 1	550627
7700622283	Base bomba nafta	NB 2	550628
0164.300	Arandela tapón cárter B 16 x 22 x 2.4 CN	CN	450229
0252.120	Arandela tapa válvulas A 8 x 18 x 1.5 F	NB 3	550630
1451.160	Cámara agua tapa cilindros	NB 1	550632
7700629742	Anillo o´ring base distribución G 39 x 3	GS 1	550633
1206.740	Cuerpo bomba de agua	NB 1	550634
0348.42	Jgo. múltiple admisión (4)	NB 1	560637
	O´ring tapón block mando b/ac. 47.3 x 2	GS 1	550638
1340.220	Termostato	NB 1	550639
1458.030	Llenado de aceite	CG	450041
1339.660	Anillo termostato	GS 1	550641
	Jgo. juntas caja velocidades	VS	550650
0127.260	Jgo. cierre bancada (4)	GS 1	550658
0304.20	Junta para cárter	CGT	550660
0112.740	Jgo. suplemento camisa cilindros (4)	S 1	550670
0304.20	Junta para cárter	CB	550682
	Arandela A 16 x 22 x 1.5 A	AL 1	
	Kit de retenes completo		R461200
0956.22	Jgo. retén válvulas (8)	T 1	R550610T
0127.28	Retén bancada 90 x 110 x 13	P 1	R550611P
0127.11	Retén distribución 50 x 68 x 10	P 1	R550612P
0236.09	Retén árbol levas 35 x 47 x 7	P 1	R550613P
	Retén auxiliar 30 x 40 x 7	P 1	R550615P

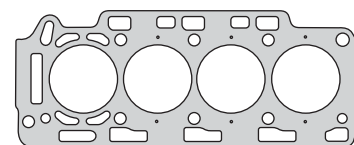

550605



A 8 x 18 x 1.5 F

550610

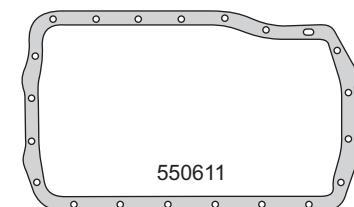

550611



550616

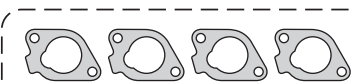

560637

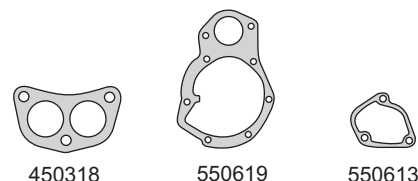

450318

550619

550613



550627

550628

550632

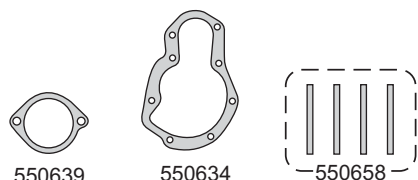

550639

550634

550658



G 39 x 3

550641

G 47.3 x 2

A 16 x 22 x 1.5 A



550670



R550611P



R550612P

R550613P

R550615P

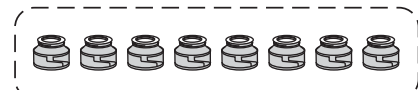

R550610T



# PEUGEOT



Motor/Engine	Cm³	HP	Ø
<b>P8C</b> <b>XUD11BTE/ATE</b> (SOHC) 12V	<b>2088</b>	<b>109</b>	<b>86</b>
<b>DIESEL</b>			

**Citroën:** XM TD 1989/97 - 1994/00, Jumpy TD Jumper TD, Synergie TD, Dispatch TD Evasión TD 1996/..., Xantia TD 1995/98  
**Fiat:** Ulysse TD 1996/99  
**Lancia:** Zeta TD 1996/00  
**Peugeot:** 406, 605. 806TD 1995/98



Nº OE	Descripción/Description	Mat.	Ref.
0197.H0	Jgo. de juntas para motor		461501-R
0209.R5	Junta tapa cilindros Ø 86.0 ± 1.52	MLS	461508-1M
0209.R6	Junta tapa cilindros Ø 86.0 ± 1.57	MLS	461508-2M
0209.R7	Junta tapa cilindros Ø 86.0 ± 1.62	MLS	461508-3M
0209.R8	Junta tapa cilindros Ø 86.0 ± 1.67	MLS	461508-4M
0209.T4	Junta tapa cilindros Ø 86.0 ± 1.72	MLS	461508-5M
0209.R4	Junta tapa cilindros Ø 86.0 ± 1.77	MLS	461508-SM
0204.99	Jgo. tornillos tapa cilindros (HAE14038)		B461500
0249.70	Junta tapa de válvulas	S	461510
0304.34	Junta para cárter	NB	460211
1206.A4	Tapa bomba de agua	NB	460214
1201.C50	Tapa bomba de agua	NB	461514
0349.76	Múltiple escape	AC	461515
0349.76/1	Múltiple escape	MLS	461515-1
0348.96	Múltiple admisión	NB	461517
	Arandela tapón cárter B16 x 22 x 2.4 CN	CN	450229
0236.320	Porta varilla nivel aceite	CG	460229
0236.40	Plaqueta tapa de cilindros	NB	461530
	Plaqueta block	NB	461531
1339.62	Base termostato	NB	460332
	Placa termostato	NH	460232
	Salida de agua	NB	461532
0147.120	Acople tapa	NB	461533
0230.32	Inspección tapa de cilindros	NB	460334
0127.050	Bastón cierre bancada	GS	460235
1981.020	Arandela pico inyector	AC	560036
	Cierre termostato	GS	550641
	Arandela base inyector A 15 x 21 x 2 C	CU	4
	Arandela A 12 x 18 x 3 C	CU	1
0205.30	Arandela asiento bulón tapa cilindros A 13 x 24 x 5 H	H	
	O'ring G 21.89 x 2.62	GS	1
	O'ring G 17.17 x 1.78	GS	1
	Arandela A 16 x 22 x 1.5 A	AL	1
	Kit de retenes completo		R461500
0956.22	Jgo. retén válvulas (12)	P	R461510P
0127.28	Retén bancada 90 x 110 x7	V	R460211V
0326.22	Retén distribución 42 x 62 x 7	V	R460212V
0236.14	Retén árbol de levas 35 x 50 x 7	V	R470013V

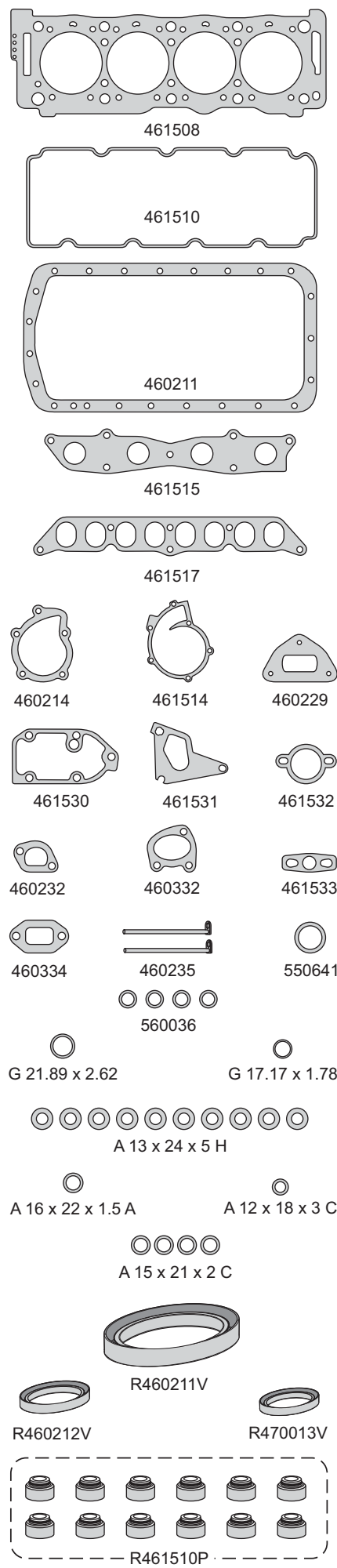

# PEUGEOT



Motor/Engine	Cm³	HP	Ø
DJ5 (T9A)	2445	86	92
DJ5T (T8A/THZ)	2445	103	92
DK5ATE (SOHC) 12V	2445	130	92

**Citroën:** Jumper D/TD, XM TD, Relay D/TD 1994/97  
**Peugeot:** DJ5 - Boxer D 1994/...  
 DJ5T - Boxer TD 1994/97  
 DK5ATE - 605 TD 1995/99

DIESEL



Nº OE	Descripción/Description	Mat.	Ref.
	Jgo. de juntas para motor		470000-R
0209.R3	Jgo. de juntas superior		470095
	Jta. tapa cilindros Ø 93.0 ± 1.60	NFT	470007
	Jgo. tornillos tapa cilindros (HAE14038)		B470000
	Sellador líquido - caucho de silicona		TRN0085G
0249.79	Junta tapa válvulas	GS	470010
	Tapa bomba de agua	NFT	470014
0349.E7	Múltiple escape	AC	470015
0348.K1	Múltiple admisión	CB	470017
	Entre múltiple admisión	CB	470031
	Placa termostato	NB	460232
	Lateral cuerpo bomba de agua	NFT	470033
	Acople bomba de agua	NFT	470034
	Junta	CB	470035
	Acople bomba de agua	NFT	470036
1981.020	Arandelas parallas pico inyector	AC	560036
46340	O'ring entrada depresora G 44 x 2	GS	460340
46341	O'ring salida depresora G 16 x 2	GS	460341
	Arandela A 6 x 11 x 2 C	CU	
	Arandela A 15 x 21 x 2 A	AL	
	Arandela inyector A 17 x 22 x 1.5 C	CU	
	O'ring G 28.3 x 1.78	GS	
	Kit de retenes completo		R470000
	Jgo. retén válvulas (12)	V	R470010V
	Retén bancada 98 x 120 x 7	V	R470011V
	Retén distribución 64 x 88 x 6	V	R470012V
0236.15	Retén árbol levas 35 x 50 x 7	V	R470013V
	Retén árbol levas trasero 40 x 62 x 7	V	R470014V
	Retén auxiliar trasero 47.5 x 62 x 7	V	R470015V

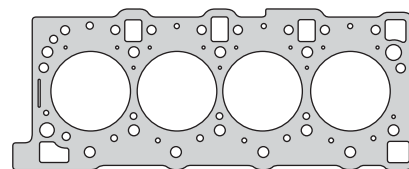

470007

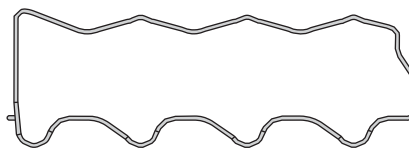

470010



470015



470017



470031

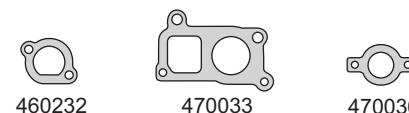

460232

470033

470036



470014

470034

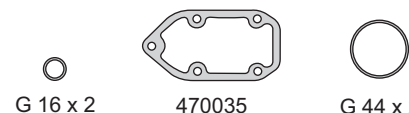

G 16 x 2

470035

G 44 x 2

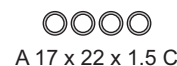

A 17 x 22 x 1.5 C



G 28.3 x 1.78



A 15 x 21 x 2 A

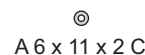

A 6 x 11 x 2 C

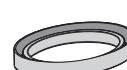

R470012V



R470011V



R470013V



R470014V



R470015V

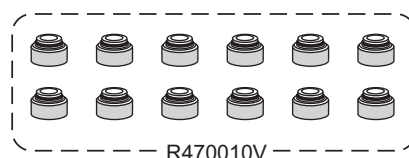

R470010V

# PEUGEOT



Motor/Engine	Cm³	HP	Ø
XU10J4	1998	152/155	86
XU10J4TE (DOHC) 16V	1998	200	86

**Citroën:** ZX 1992/97, Xantia 1993/95  
**Peugeot:** 405 MI, 405 TI Turbo 1992/95, 306 1993/...



Nº OE	Descripción/Description	Mat.	Ref.
	Jgo. de juntas para motor		● 470200-R
0209.110	Junta tapa de cilindros Ø 87.0 ± 1.40	NFT	1 470207
0204.AO	Jgo. tornillos tapa cilindros (HAT55055/55100)		B470200
0249.74	Junta tapa de válvulas	GS	1 451410
0304.34	Junta para cárter	NB	1 460211
1307.46	Bomba de agua	NB	1 460214
0349.98	Múltiple escape	NFT	1 470215
0348.88	Múltiple admisión	NH	1 471017
1798.680	Anillo salida de escape	NFT	1 470218
0365.260	Anillo caja mariposa admisión	GS	1 460430
2101.618181	Placa termostato	NH	1 460232
2108.1107990	Bastón cierre bancada	GS	2 460235
1339.83	Distribución agua	GS	1 470637
1340.48	O'ring termostato G 51.57 x 4.5	GS	1 460245
2101.130300	Arandela B 14 x 20 x 2.5 CN	CN	1
2105.1005255	Arandela A 12 x 18 x 3 C	CU	1
2101.1307048	Arandela B 16 x 22 x 2.5 CN	CN	1
2101.1011021	Arandela A 15 x 20 x 1 C	CU	1
2101.1106170	O'ring G 4.47 x 1.78	GS	5
2101.100608	Arandela A 8 x 12 x 1 C	CU	1
	Arandela A 18 x 23 x 1 C	CU	1
	Kit de retenes completo		R470200
0956.34	Jgo. retén válvulas (16)	V	1 R470110V
0127.80	Retén bancada 90 x 110 x 7	V	1 R460211V
0326.12	Retén distribución 42 x 62 x 7	V	1 R460212V
0236.21	Retén árbol de levas 36 x 50 x 8	V	2 R460213V

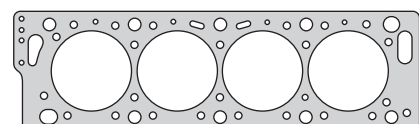

470207

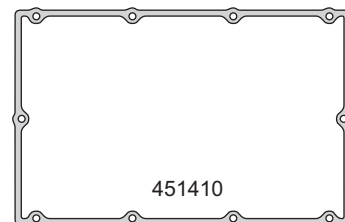

451410

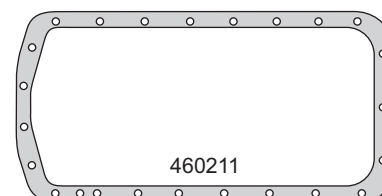

460211



470215



471017



460214



470218



460430



460232



460235



470637

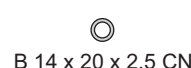

B 14 x 20 x 2.5 CN

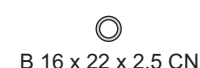

B 16 x 22 x 2.5 CN



G 4.47 x 1.78



A 12 x 18 x 3 C



A 18 x 23 x 1 C



A 15 x 20 x 1 C



A 8 x 12 x 1 C



G 51.57 x 4.5



R460211V



R460212V



R460213V

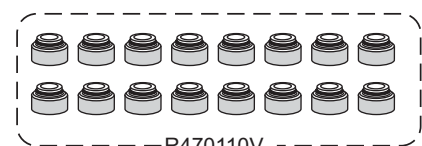

R470110V

# PEUGEOT



Motor/Engine	Cm³	HP	Ø
TUD5 (VJY)	1527	54	77
TUD5 (VJZ) (SOHC) 8V	1527	58	77

**Citroën:** AX 15 1994/97, Saxo 1996/03  
**Peugeot:** 106 1994/96  
**Nissan:** Micra 1997/...  
**Rover:** 115 D 1994/98

DIESEL



Nº OE	Descripción/Description	Mat.		Ref.
	Jgo. de juntas para motor			470300-R
	Jgo. de juntas superior			470395
0209.T8	Junta tapa cilindros Ø 78.0 ± 1.80	NFT	1 1	470307
0209.T8	Junta tapa cilindros Ø 78.0 ± 1.60	MLS		470308
0204.85	Jgo. tornillos tapa cilindros (HAE14038)			B470300
0249.93	Junta tapa de válvulas	GS	1 1	470310
	Junta para cárter	NB	1	451611
0304.304	Junta para cárter	NB	1	460711
0349.E4	Múltiple escape	AC	1 1	470315
1.709.10	Salida de escape	AC	1 1	470318
133.986	Termostato	GS	1 1	240419
	Arandela A 7 x 12 x 2 H	H	8	470340
1981.020	Arandela inyector parallamas	AC	4 4	560036
198.133	Arandela inyector A 17 x 20 x 1.5 C	CU	4 4	
	Arandela A 10 x 18 x 2 A	AL		1
	Arandela A 10 x 16 x 2.5 C	CU	2	
	Arandela A 12 x 17 x 2 C	CU		4
	Arandela A 12 x 18 x 1 C	CU	3	
	Arandela A 14 x 22 x 2 C	CU		2
	Arandela A 18 x 22 x 1.5 C	CU		1
	Arandela A 22 x 29 x 3 A	AL		3
	Arandela A 7 x 13 x 1.5 A	AL		8
	Arandela A 14 x 18 x 1.5 A	AL		1
	Anillo G 11 x 15 x 3	GS	8	
	O`ring G 37.77 x 2.62	GS		1
	O`ring G 47.35 x 1.78	GS	1 1	
120.696	O`ring G 74 x 3	GS		1
	O`ring G 9.19 x 2.62	GS	1	
	O`ring G 8 x 2.4	GS		1
	Kit de retenes completo			R460700
0956.19	Jgo. retén válvulas (8)	V	1	R460710V
0514.74	Retén bancada 85 x 105 x 8	V	1	R560111V
0514.72	Retén distribución 42 x 66 x 8	V	1	R460712V
0236.44	Retén árbol de levas 36 x 50 x 8	V	1	R460213V

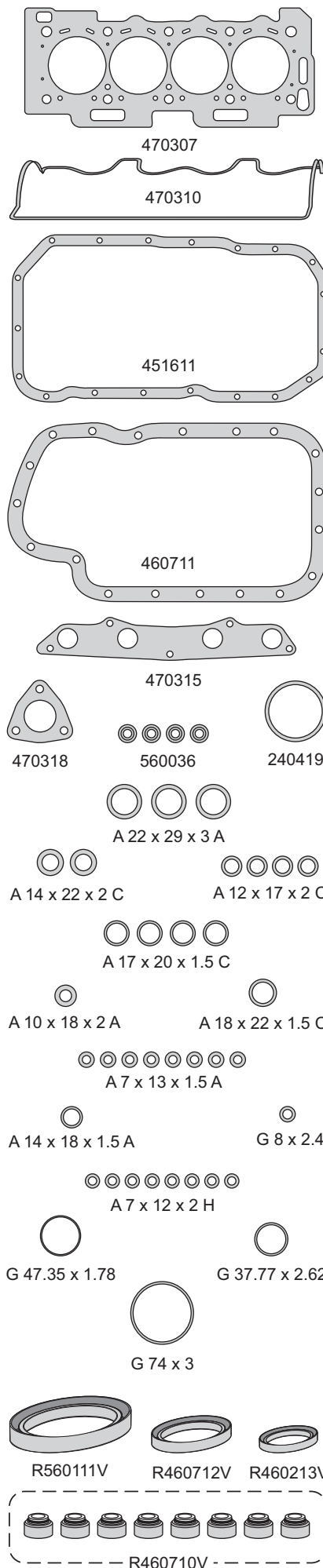

# PEUGEOT



Motor/Engine	Cm³	HP	Ø
TUD3	1360	50	75
TUD3 (K9A) (SOHC) 8V	1360	52	75

**Citroën:** AX 14 1988/94  
**Peugeot:** 106 1992/...  
**Rover:** 114, Metro 1992/94

DIESEL



Nº OE	Descripción/Description	Mat.	Ref.
	Jgo. de juntas para motor		<b>470400-R</b>
0209.E9	Junta tapa de cilindros Ø 76.0 ± 1.80	NFT	1 470407
0209.N4	Junta tapa de cilindros Ø 76.0 ± 1.70	MLS	470408
	Jgo. tornillos tapa cilindros (HAE14038)		<b>B470400</b>
0249.76	Junta tapa de válvulas	GS	1 470410
0304.304	Junta para cárter	NB	1 460711
0349.E4	Múltiple escape	AC	1 470315
1.709.10	Salida de escape	AC	1 470318
133.986	Termostato	GS	1 240419
1981.020	Arandela parallamas pico inyector	AC	4 560036
	Guarnición termostato	GS	460245
7701348178	Jgo. suplemento camisas cilindros (4)	GS	1 550671
	Arandela inyector A 16 x 22 x 2 C	CU	4
	Arandela A 14 x 18 x 1.5 A	AL	8
	Arandela A 16 x 22 x 1.5 A	AL	1
	Arandela A 22 x 29 x 3 A	AL	2
	Arandela A 16 x 24 x 1.5 A	AL	1
	Arandela A 12 x 18 x 1.5 C	CU	1
	Arandela A 12 x 17 x 2 C	CU	2
	Arandela A 11 x 18 x 2 C	CU	2
	Arandela A 6 x 11 x 2 C	CU	1
120.694	O´ring bomba de agua G 56.82 x 2.62	GS	1
593.360	O´ring derivación de agua G 36.5 x 3.2	GS	1
120.696	O´ring acople de agua G 74 x 3	GS	1
	O´ring derivación de agua t/cil. G 45.69 x 2.62	GS	1
	Kit de retenes completo		R470400
0956.19	Jgo. retén válvulas (8)	V	1 R460710V
0514.74	Retén bancada 85 x 105 x 12	V	1 R220411V
0514.72	Retén distribución 42 x 66 x 8	V	1 R460712V
0236.44	Retén árbol de levas 36 x 50 x 8	V	1 R460213V

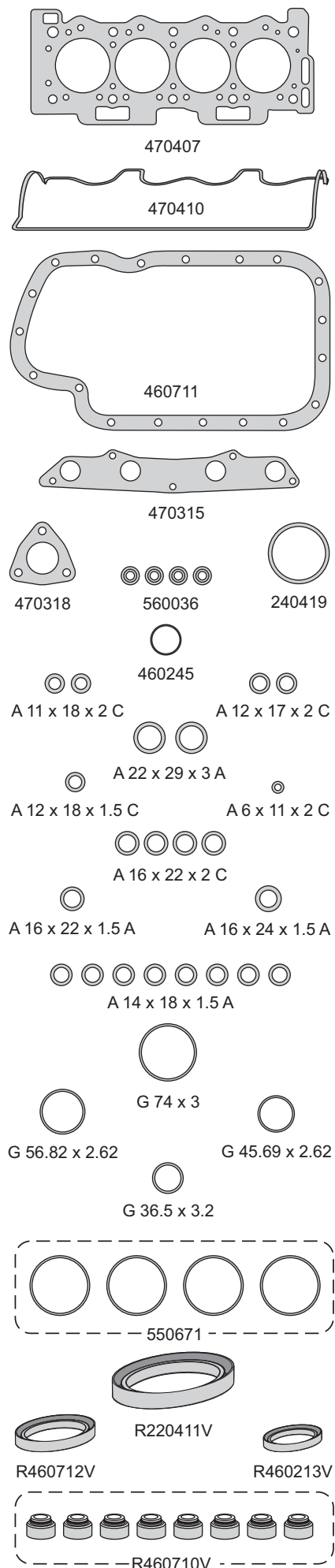

# PEUGEOT



Motor/Engine	Cm³	HP	Ø
TU5JP/J2 (SOHC) 8V	1587	90/103	78.5

**Citroën:** ZX, Saxo 1996/..., Xsara 1997/...  
**Peugeot:** 106 1994/..., 306 1993/..., 206 1998/...



Nº OE	Descripción/Description	Mat.	Ref.
	Jgo. de juntas para motor		470501-R
	Jgo. de juntas superior	●	470595
	Junta tapa cilindros Ø 80.0 ± 1.40	NFT	470507-1.40
	Junta tapa cilindros Ø 80.0 ± 1.60	NFT	470507-1.60
0209.W8	Junta tapa cilindros Ø 80.0 ± 1.40	MLS	470508-1.40
0209.W9	Junta tapa cilindros Ø 80.0 ± 1.60	MLS	470508-1.60
	Jgo. tornillos tapa cilindros (HAE14038)		B470500
	Conj. junta tapa válvulas (3)	GS 1 1	460710
	Junta para cárter	NB 1 1	451611
	Jgo. múltiple escape (2)	AC 1 1	451615
	Jgo. múltiple admisión (4)	GS 1 1	451617
	Salida de escape	NFT 1 1	460718
	Arandela tapa válvulas	NH 2 2	451732
	Guarnición termostato	GS 1 1	460245
	Junta base carburador	NB 2 2	06053
	O´ring G 36.17 x 2.62	GS 1 1	
	O´ring G 75.87 x 2.62	GS 1 1	
	Arandela A 12 x 18 x 1.5 A	AL 1 1	
	Arandela A 22 x 30 x 2 C	CU 3 3	
	Arandela A 17 x 22 x 1.5 C	CU 2 2	
	Kit de retenes completo		R470500
	Jgo. retén válvulas (8)	V 1 1	R460710V
0514.74	Retén bancada 85 x 105 x 8	V 1 1	R560111V
0514.72	Retén distribución 42 x 66 x 8	V 1 1	R460712V
0236.44	Retén árbol de levas 36 x 50 x 8	V 2 2	R460213V

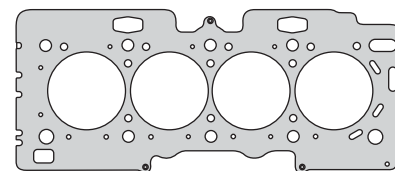

470508

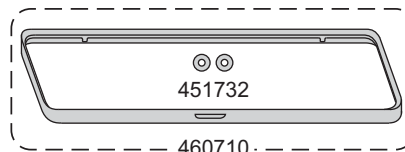

451732

460710

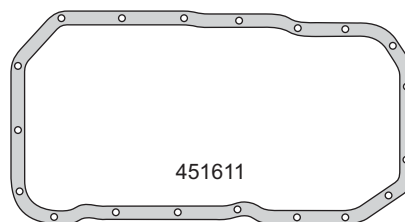

451611

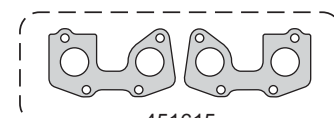

451615

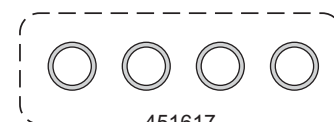

451617

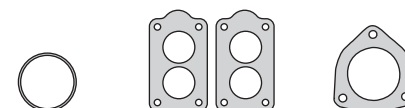

460245

06053

460718



A 22 x 30 x 2 C



G 36.17 x 2.62



G 75.87 x 2.62



A 17 x 22 x 1.5 C



A 12 x 18 x 1.5 A



R560111V



R460712V



R460213V



R460710V

# PEUGEOT



Motor/Engine	Cm³	HP	Ø
DW8 (WJZ/WJY) (SOHC) 8V	1868	71	82.2

**Citroën:** Berlingo, Jumpy, Xsara 1998/...  
C5, Xsara, Jumpy 2000/...  
**Peugeot:** 206, 306 1998/...  
Expert, Partner 1999/...

DIESEL



Nº OE	Descripción/Description	Mat.	Ref.
0197.X6	Jgo. de juntas para motor		470601-R
	Jgo. de juntas superior	●	470695-1M
	Jgo. de juntas superior		470695-2M
	Jgo. de juntas superior		470695-3M
	Jgo. de juntas superior		470695-4M
	Jgo. de juntas superior		470695-5M
	Jgo. de juntas superior (MLS)		470695-1M MLS
	Jgo. de juntas superior (MLS)		470695-2M MLS
	Jgo. de juntas superior (MLS)		470695-3M MLS
	Jgo. de juntas superior (MLS)		470695-4M MLS
	Jgo. de juntas superior (MLS)		470695-5M MLS
	Jgo. juntas superior sin JTC		470696
	Junta tapa cilindros Ø 84.0 ± 1.26	NFT 1	470607-1M
	Junta tapa cilindros Ø 84.0 ± 1.30	NFT	470607-2M
	Junta tapa cilindros Ø 84.0 ± 1.34	NFT	470607-3M
	Junta tapa cilindros Ø 84.0 ± 1.38	NFT	470607-4M
	Junta tapa cilindros Ø 84.0 ± 1.42	NFT	470607-5M
0209.X0	Junta tapa cilindros Ø 84.0 ± 1.26	MLS	470608-1M
0209.X1	Junta tapa cilindros Ø 84.0 ± 1.30	MLS	470608-2M
0209.X2	Junta tapa cilindros Ø 84.0 ± 1.34	MLS	470608-3M
0209.X3	Junta tapa cilindros Ø 84.0 ± 1.38	MLS	470608-4M
0209.X4	Junta tapa cilindros Ø 84.0 ± 1.42	MLS	470608-5M
	Jgo. tornillos tapa cilindros (HAE14038)		B470600
0249.95	Junta tapa válvulas	N	470610
	Junta tapa válvulas reforma 2005/...	N 1 1	470633
0249.97	Junta sobretapa de válvulas	N 1 1	470636
0304.34	Junta para cárter	NB	460211
1206.460	Tapa bomba de agua	NB	460214
0349.H7	Jgo. múltiple escape (2)	AC 1 1	470615
0348.N8/P0	Jgo. múltiple admisión (3)	NB 1 1	470617
	Anillo termostato	GS	240419
0164.300	Junta alojamiento termostato	CG	460229
0147.120	Placa termostato	NH	460232
0127.050	Bastón cierre bancada	GS	460235
1981.020	Arandela pico inyector	AC	560036
1339.83	Guarnición distribuidora de agua	GS	470637
	Arandela con inserto metálico A 19 x 30 x 3 H	H	470638
	Guarnición termostato	GS	460245
	Arandela inyector A 17 x 20 x 1.5 C	CU 4 4	
	Arandela A 22 x 28 x 2 A	AL	1
020513	Arandela A 13 x 24 x 3 H	H	
	Kit de retenes completo		R460300
	Jgo. retén válvulas (8)	V	1 R460210V
0127.28	Retén bancada 90 x 110 x 7	V	1 R460211V
0326.22	Retén distribución 42 x 62 x 7	V	1 R460212V
0236.15	Retén árbol de levas 35 x 50 x 7	V	1 R470013V

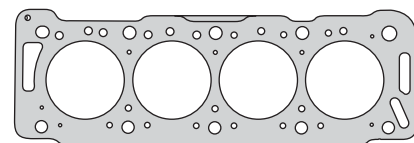

470608



470610



470633



470636

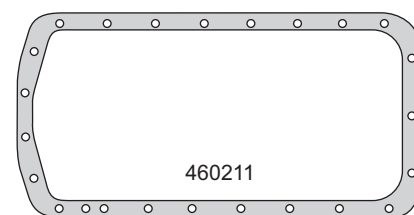

460211

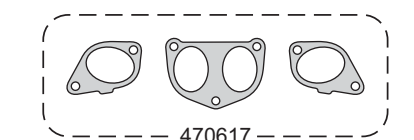

470617

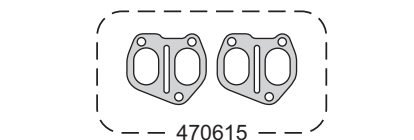

470615



460214



240419

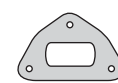

460229



460232



460235



470637



460245



A 19 x 30 x 3 H



A 17 x 20 x 1.50 C



A 13 x 24 x 3 H



A 22 x 28 x 2 A



R460211V



R460212V



R470013V



R460210V

# PEUGEOT



Motor/Engine	Cm³	HP	Ø
XUD7T/TE (SOHC) 8V	1769	78/90	80

**Citroën:** BX 17 TD 1988/92  
**Peugeot:** 205 TD 1990/96, 405 TD 1988/94, 309 TD 1990/93  
**Rover:** 218 TD, 418 TD 1991/96, Tourer TD 1996/...

DIESEL



Nº OE	Descripción/Description	Mat.	Ref.
	Jgo. juntas para motor		460301-R
0209.90	Junta tapa cilindros Ø 82.0 ±1.65	NFT	470707-2M
0209.91	Junta tapa cilindros Ø 82.0 ±1.80	NFT	470707-3M
	Jgo. tornillos tapa cilindros (HAT55055/55100)		B470700
0.249.910	Conj. junta tapa válvulas (4)	N	460310
0.304.340	Junta para cárter	NB	460211
1.206.460	Bomba de agua	NB	460214
0349.780	Jgo. múltiple escape (2)	NFT	460316
0348.98/99	Jgo. múltiple admisión (3)	NB	470917
0348.N8/P0	Jgo. múltiple admisión (3)	NB	470617
0348.JO	Múltiple admisión y escape turbo	NFT	460317
1.710.99	Salida de escape	AC	460318
1339.730	Cuerpo termostato	NB	460319
	Arandela B 16 x 22 x 2.4 CN	CN	450229
0.164.300	Junta alojamiento termostato	CG	460229
0.147.140	Porta retén frente motor	CB	460329
0.147.120	Placa termostato	NH	460232
1.339.620	Base termostato	NB	460332
1.339.410	Inspección	NB	460333
0.236.320	Inspección bomba trasera	NB	460334
0.197.050	Bastón bancada	GS	460235
1981.020	Arandela pico inyector parallamas	AC	560036
7703061078	Arandela base inyector A 16 x 21 x 2 C	CU	500240
0.455605	O´ring entrada depresora G 44 x 2	GS	460340
0.455606	O´ring salida depresora G 16 x 2	GS	460341
	Cierre termostato	GS	550641
	O´ring G 18.72 x 2.62	GS	
	O´ring G 29.87 x 1.78	GS	
	O´ring G 37 x 4	GS	
	Arandela A 6 x 11 x 2 C	CU	
	Arandela A 7 x 14 x 1 H	H	
	Arandela A 14 x 17.2 x 2 C	CU	
1.981.050	Arandela A 12 x 18 x 3 A	AL	
0.164.300	Arandela A 22 x 29 x 1.5 A	AL	
0.127.050	Arandela tapa válvula A 7 x 17 x 1.5 FA	NB	
	Arandela A 16 x 21 x 1.5 C	CU	
	Arandela A 16 x 22 x 1.5 A	AL	
	Kit de retenes completo		R460300
0.119.060	Jgo. retén válvulas (8)	V	R460210V
0326.220	Retén bancada 90 x 110 x 7	V	R460211V
0514.150	Retén distribución 42 x 62 x 7	V	R460212V
0.236.44	Retén árbol de levas 35 x 50 x 7	V	R470013V

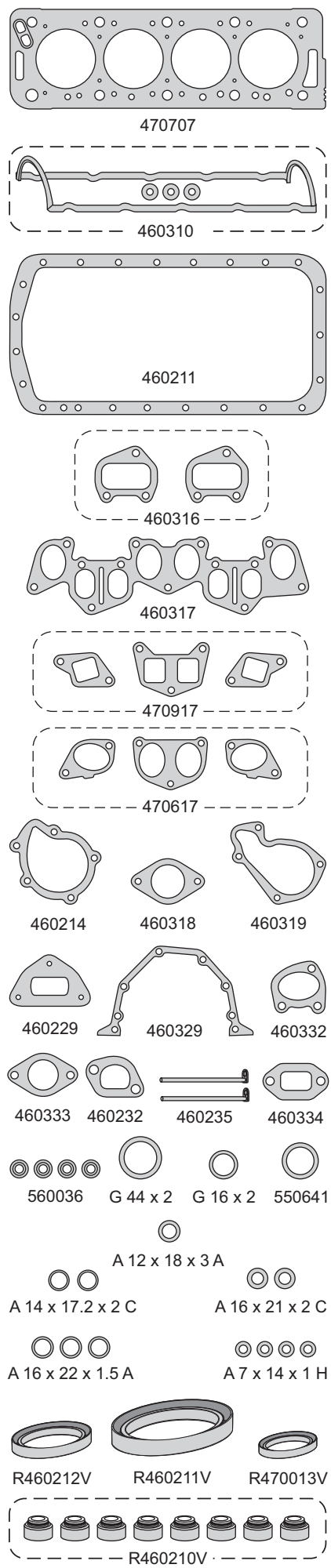



# PEUGEOT



Motor/Engine	Cm³	HP	Ø
DW10TD/ATED (RHV/RHX/RHS RHZ/RHY) (SOHC) 8V	1997	90/110	85

**Citroën:** Xantia, Xsara HDI 1998/..., Jumper Berlingo, Evasion, Xsara HDI 1999/...

**Chevrolet:** Tracker 2001/04

**Peugeot:** 306, 406 HDI 1998/..., 206, 806 HDI Boxer HDI, Expert HDI, Partner

**Suzuki:** Vitara, Grand Vitara HDI 2000/...



DIESEL

Nº OE	Descripción/Description	Mat.	Ref.
	Jgo. de juntas para motor		470801-R
0209.X5	Junta tapa de cilindros Ø 86.0 ± 1.30	NFT	470807-1M
0209.X6	Junta tapa de cilindros Ø 86.0 ± 1.35	NFT	470807-2M
0209.X7	Junta tapa de cilindros Ø 86.0 ± 1.40	NFT	470807-3M
0209.X8	Junta tapa de cilindros Ø 86.0 ± 1.45	NFT	470807-4M
0209.X9	Junta tapa de cilindros Ø 86.0 ± 1.50	NFT	470807-5M
0209.X5	Junta tapa de cilindros Ø 86.0 ± 1.30	MLS	470808-1M
0209.X6	Junta tapa de cilindros Ø 86.0 ± 1.34	MLS	470808-2M
0209.X7	Junta tapa de cilindros Ø 86.0 ± 1.38	MLS	470808-3M
0209.X8	Junta tapa de cilindros Ø 86.0 ± 1.42	MLS	470808-4M
0209.X9	Junta tapa de cilindros Ø 86.0 ± 1.50	MLS	470808-5M
0204.900	Jgo. tornillos tapa cilindros (HAE14038)		B470800
0249.99	Junta tapa de válvulas	N	1 470810
0304.34	Junta para cárter	NB	1 470811
1.206.460	Bomba de agua	NB	1 460214
0349.H4	Múltiple escape	AC	1 470815
0348W4	Múltiple admisión	NB	1 470817
1340.48	Guarnición termostato	GS	1 450519
	SopORTE distr. de agua trasero y termostato	SLS	1 470819
0127.050	Bastón cierre bancada	GS	2 460235
1339.83	Guarnición agua	GS	1 470637
	Arandela tapón cárter B 14 x 18 x 2 CN	CN	150034
1981.43	Arandela inyector A 7 x 15 x 1.5 C	CU	4 470840
	Salida de escape	AC	1 470862
	Arandela A 18 x 23 x 1 C	CU	1
	Arandela A 12 x 18 x 2 C	CU	1
	Arandela A 14 x 18 x 1.5 A	AL	1
	Kit de retenes completo		R470800
0956.48	Jgo. retén válvulas (8)	V	1 R470810V
0127.28	Retén bancada 90 x 110 x 7	V	1 R460211V
0326.22	Retén distribución 42 x 62 x 7	V	1 R460212V
0807.28	Retén árbol de levas 27 x 47 x 7	V	1 R470813V

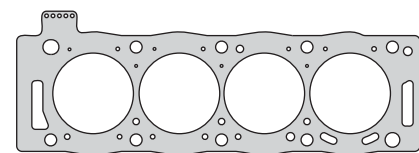

470807

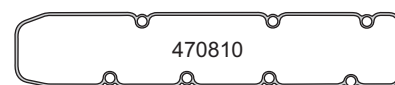

470810

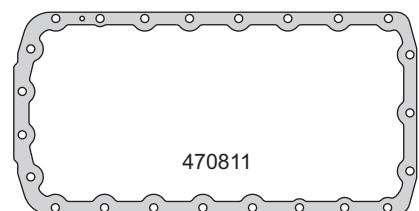

470811



470815



470817

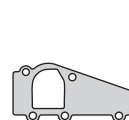

470819



460214



450519



470637



460235



470862



A 14 x 18 x 1.5 A



A 18 x 23 x 1 C



A 12 x 18 x 2 C



A 7 x 15 x 1.5 C



R460211V



R460212V



R470813V

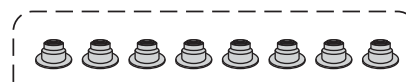

R470810V

# PEUGEOT



Motor/Engine	Cm³	HP	Ø
XUD7 (161A/A9A) (SOHC) 8V	1769	60	80
<b>DIESEL</b>			

**Citroën:** C15 1994/..., Berlingo 1996/99  
Xsara 1997/..., ZX 1991/94  
**Peugeot:** 205, 309 1983/96, 306 1993/...  
Partner 1996/...



Nº OE	Descripción/Description	Mat.	Ref.
	Jgo. de juntas para motor		460301-R
0.209.S0	Junta tapa de cilindros Ø 82.0 ± 1.36	NFT	470907-1M
0.209.S1	Junta tapa de cilindros Ø 82.0 ± 1.40	NFT	470907-2M
0.209.S2	Junta tapa de cilindros Ø 82.0 ± 1.44	NFT	470907-3M
0.209.S3	Junta tapa de cilindros Ø 82.0 ± 1.48	NFT	470907-4M
0.209.S4	Junta tapa de cilindros Ø 82.0 ± 1.52	NFT	470907-5M
0.209.S5	Junta tapa de cilindros Ø 82.0 ± 1.80	NFT	470907-6M
0.204.65	Jgo. tornillos tapa cilindros (HAT55055/55100)		B460300
0.249.910	Conj. junta tapa válvulas (3)	N	460310
0.304.340	Junta para cárter	NB	460211
1.206.440	Tapa bomba de agua	NB	460214
0.349.780	Jgo. múltiple escape (2)	NFT	460316
0.348.J0	Jgo. múltiple admisión y escape	NFT	460317
0.365.340	Jgo. entre colec. adm. aspirado G 37 x 4 (4)	GS	460917
0.348.N8/P0	Jgo. múltiple admisión aspirado (3)	NB	470617
0.348.980/90	Jgo. múltiple admisión (3)	NB	470917
1.710.990	Salida de escape	AC	460318
1.339.730	Cuerpo termostato	NB	460319
	Arandela tapón cárter B 16 x 22 x 2.4 CN	CN	450229
0.236.320	Junta porta varilla a nivel aceite	CG	460229
0.147.140	Porta retén frente motor	CB	460329
	Arandela tapa válvulas A 7 x 17 x 1.5 FA	NB	550430
0.147.120	Placa termostato	NH	460232
1.339.620	Base termostato	NB	460332
0.230.320	Inspección bomba aceite	NB	460334
1.451.160	Inspección bomba aceite	NB	460333
0.127.050	Bastón cierre bancada	GS	460235
	Arandela A 22 x 29 x 1.5 A	AL	460336
	Arandela inyector A 16 x 21 x 2 C	CU	500240
	Cierre termostato	GS	550641
455.606	Bomba depresora G 44 x 2	GS	460340
455.605	O´ring bomba depresora salida G 16 x 2	GS	460341
1981.020	Arandela parallamas pico inyector	AC	560036
	Arandela A 12 x 18 x 3 A	AL	
	Arandela A 6 x 11 x 2 C	CU	
	Arandela A 14 x 17.2 x 2 C	CU	
	Arandela A 7 x 14 x 1 H	H	
	Arandela A 16 x 21 x 1.5 C	CU	
	Arandela A 16 x 22 x 1.5 A	AL	
	O´ring G 18.72 x 6.62	GS	
	O´ring G 29.87 x 1.78	GS	
	Kit de retenes completo		R460300
0.956.22	Jgo. retén válvulas (8)	V	R460210V
0127.28	Retén bancada 90 x 110 x 7	V	R460211V
0326.22	Retén distribución 42 x 62 x 7	V	R460212V
0236.44	Retén árbol de levas 35 x 50 x 7	V	R470013V

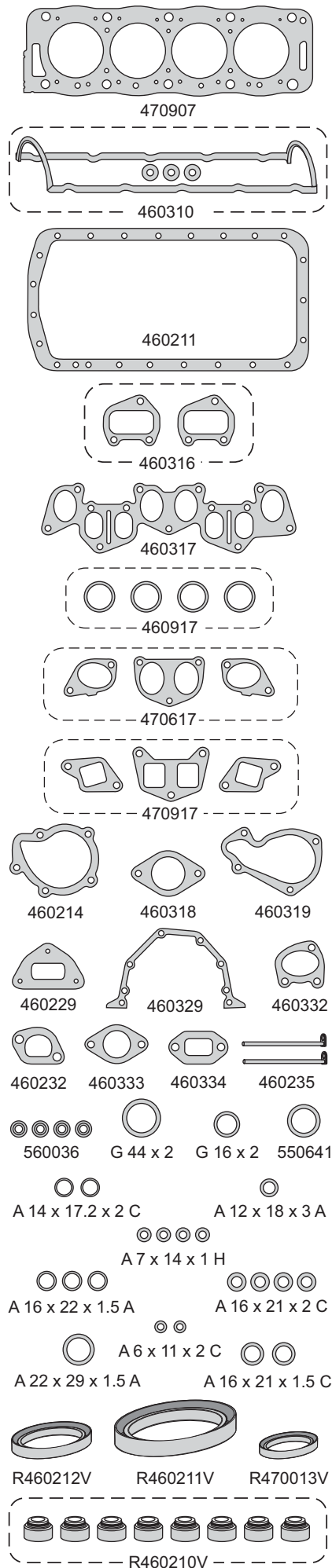

# PEUGEOT



Motor/Engine	Cm³	HP	Ø
XU10J4R	1998	132/135	86
XU10J4R (RFV) (DOHC) 16V	1998	132/135	86

**Citroën:** Xantia 1995/2001, Xsara 1998/00  
Evasion, Synergie 1998/...

**Peugeot:** 406, 605 1995/..., 306 1997/...  
806 1998/...



Nº OE	Descripción/Description	Mat.	Ref.
	Jgo. de juntas para motor		● 471000-R
0209.N6	Junta tapa de cilindros Ø 87.0 ± 1.20	NFT	1 471007
0204.AO	Jgo. tornillos tapa cilindros (HAE14038)		B471000
0249.A2/A3	Conj. juntas tapa válvulas (2)	N	1 460810
0304.34	Junta para cárter	NH	1 460211
13070.46	Bomba de agua	NH	1 460214
0349.HO	Múltiple escape	AC	1 471015
0348.C8	Múltiple admisión	NH	1 460817
0365.260	Anillo caja mariposa admisión	S	1 460430
2101.1018080	Placa termostato	CB	1 460232
2108.1107990	Bastón cierre bancada	GS	2 460235
1339.83	Distribución bomba de agua	GS	1 470637
1340.48	O'ring termostato	GS	1 460245
0348.K6	Jgo. múltiple admisión (5) 1997/...	S	1 460841
	Múltiple admisión mariposa	S	1 460842
2101.1303020	Arandela A 14 x 18 x 1.5 A	AL	1
2101.1307048	Arandela A 16 x 22 x 1.5 C	CN	
2105.1005255	Arandela A 12 x 18 x 3 C	CU	1
2101.1011021	Arandela A 15 x 20 x 1 C	CU	1
	Arandela A 18 x 23 x 1 A	AL	1
2101.1186170	O'ring G 4.47 x 1.78	GS	5
2101.100608	Arandela A 8 x 12 x 1 C	CU	1
	Kit de retenes completo		R460800
0956.420	Jgo. retén válvulas (16)	V	1 R460810V
0127.28	Retén bancada 90 x 110 x 7	V	1 R460211V
0326.22	Retén distribución 42 x 62 x 7	V	1 R460212V
0236.44	Retén árbol de levas 36 x 50 x 8	V	2 R460213V

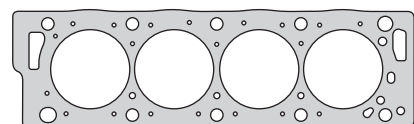

471007

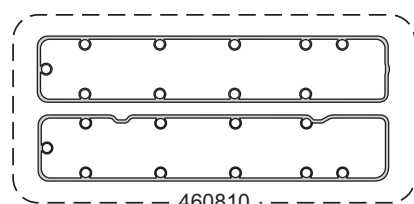

460810

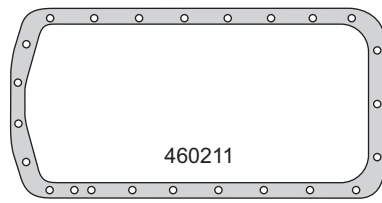

460211

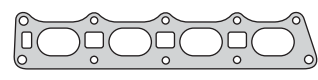

471015

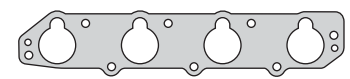

460817

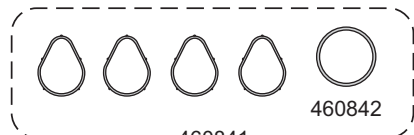

460841



460842

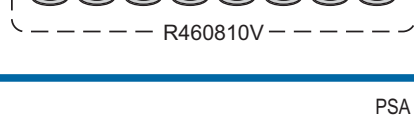
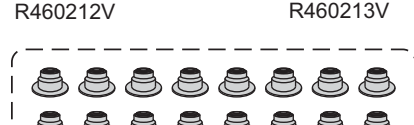
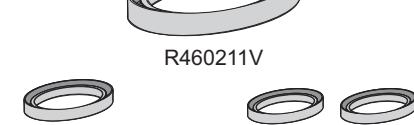
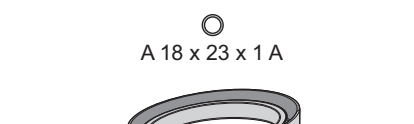
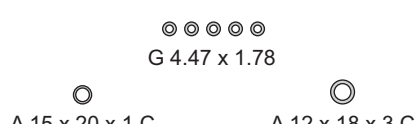
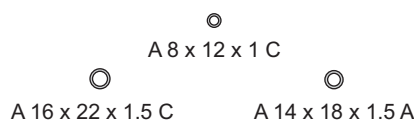
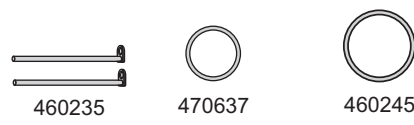

# PEUGEOT



Motor/Engine	Cm³	HP	Ø
<b>EW10J4 (RFN-RLZ) (DOHC) 16V</b>	1997	136/140	85

**Citroën:** Jumpy, Dispatch, Xsara, Evasion 1998/..., C5, C5 HPI 2001/... C8 2002/..., C4 2004/...

**Peugeot:** 206, 307, 406, 806, 807, Expert 2000/..., 406 HPIV, 607 2001/... 407 2004/...



Nº OE	Descripción/Description	Mat.	Ref.
0197.Y1	Jgo. de juntas para motor		● 471200-R MLS
	Jgo. de juntas superior (MLS)	●	471295 MLS
	Jgo. de juntas superior		471295
	Junta tapa cilindros Ø 86.0 ± 1.20	NFT	471207
0209.Z3	Junta tapa cilindros Ø 85.5 ± 0.65	MLS	1 1 471208
0204.A7	Jgo. tornillos tapa cilindros (HAE14038)		B471200
	Sellador líquido - caucho de silicona		TRN0085G
0249.A5/A4	Jgo. juntas tapa válvulas (2)	GS	1 1 471210
0349.H8	Múltiple escape	AC	1 1 471215
0348.P1	Jgo. múltiple admisión (5)	NFT	1 1 471217
1340.60	Guarnición termostato	GS	1 471219
	Junta soporte filtro aceite	NB	1 471227
	Junta base soporte filtro aceite	NB	1 471230
	Arandela con inserto A 22 x 32 x 1.5 A	AL	2 471231
	Junta canalizador agua	NB	1 471232
	Jgo. múltiple admisión (4)	GS	1 1 471235
	Arandela A16 x 22 x 1.5 A	AL	1
	Arandela A 14 x 20 x 1.5 C	CU	1
	Guarnición G 45 x 49 x 5	GS	1
	Arandela A 6 x 10.5 x 2 C	CU	1
	O'ring G 48.9 x 2.62	GS	1
	O'ring G 31.47 x 1.78	GS	1
	Kit de retenes completo		R471200
0956.45	Jgo. retén válvulas (16)	V	1 R460810V
0127.28	Retén bancada 90 x 110 x 7	V	1 R460211V
0326.27	Retén distribución 40 x 55 x 7	V	1 R270713V
0236.44	Retén árbol levas 36 x 50 x 8	V	2 R460213V
0.807.240	Retén auxiliar 38 x 50 x 6	V	1 R452113V

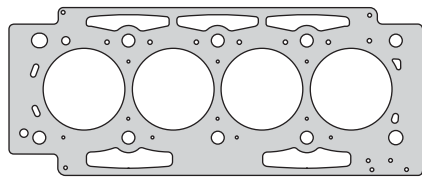

471208

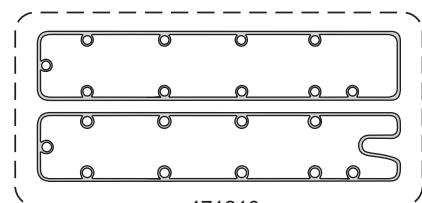

471210

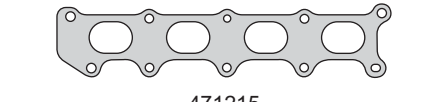

471215

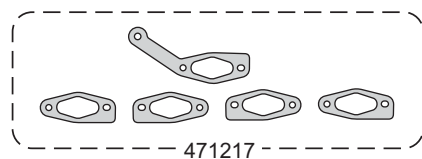

471217

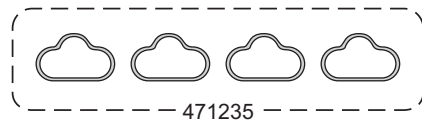

471235



471219

471227

471230

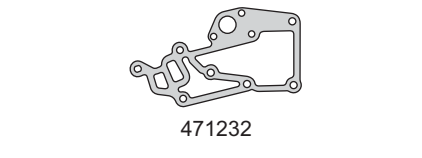

471232

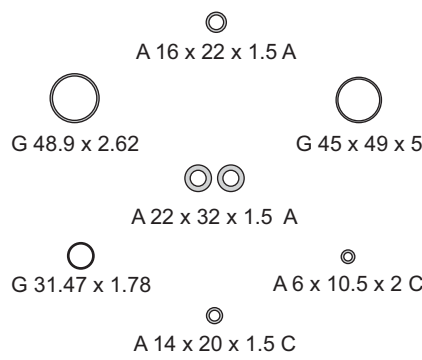

A 16 x 22 x 1.5 A

G 48.9 x 2.62

G 45 x 49 x 5

A 22 x 32 x 1.5 A

G 31.47 x 1.78

A 6 x 10.5 x 2 C

A 14 x 20 x 1.5 C

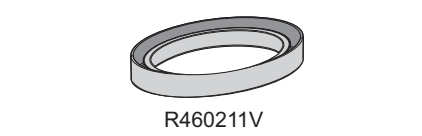

R460211V



R452113V

R460213V

R270713V

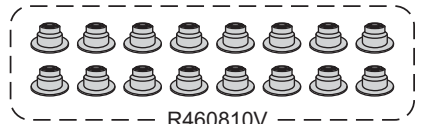

R460810V

# PEUGEOT



Motor/Engine	Cm³	HP	Ø
DV6TED4	1398	70	75
DV6TED4	1560	109	75
DV6TED4(9HY/Z)	1560	104/108	75
G8DA (DOHC) 16V			

**Citroën:** Xsara, Picasso TD 1999/...  
C4/C5 TD 2004/...

**Ford:** Focus C-Max TDCI 2003/...  
Fusion TDCI 2004/...

**Peugeot:** 307 HDI, 407 TD 2004/...  
207 Compact



**DIESEL**

Nº OE	Descripción/Description	Mat.	Ref.
	Jgo. de juntas para motor		471301-R
	Jgo. juntas superior sin JTC		471396
0209.CA	Junta tapa cilindros Ø 76.0 ± 1.20	NFT	471307-1M
0209.CC	Junta tapa cilindros Ø 76.0 ± 1.30	NFT	471307-2M
0209.CE	Junta tapa cilindros Ø 76.0 ± 1.40	NFT	471307-3M
0209.CF	Junta tapa cilindros Ø 76.0 ± 1.45	NFT	471307-4M
0209.CG	Junta tapa cilindros Ø 76.0 ± 1.50	NFT	471307-5M
0209.CA	Junta tapa cilindros Ø 76.0 ± 1.25	MLS	471308-1M
0209.CC	Junta tapa cilindros Ø 76.0 ± 1.30	MLS	471308-2M
0209.CE	Junta tapa cilindros Ø 76.0 ± 1.35	MLS	471308-3M
0209.CF	Junta tapa cilindros Ø 76.0 ± 1.40	MLS	471308-4M
0209.CG	Junta tapa cilindros Ø 76.0 ± 1.45	MLS	471308-5M
0204.C5	Jgo. tornillos tapa cilindros		B302100
0249.C2	Junta tapa válvulas	N	1 1 471310
12232358/1	Junta para cárter	NB	1 302111
01206.E2	Bomba de agua	NB	1 302114
0349.V8	Múltiple escape	AC	1 1 302115
0348.R4	Jgo. múltiple admisión (7)	GS	1 1 471317
1336.Y0	Junta frente termostato	GS	1 1 471319
1019.30	Guarnición base filtro aceite bomba	GS	1 581036
1981.55	Arandela asiento inyector A 7 x 15 x 2 C	CU	4 4 471329
0348.55	Guarnición entrada admisión	GS	1 1 471336
	Junta	GS	1 581036
	Jgo. juntas turbo (5)	VS	302140
	Junta acople turbo	AC	302141
	Junta base turbo	AC	302142
	Arandela A 10 x 14 x 1.25 C	CU	
	Arandela A 20 x 26 x 1.5 C	CU	
	O´ring G 28 x 4	S	
1336.X4	O´ring bomba de agua G 36.09 x 3.53	GS	1
0313.33	Arandela tapón cárter A 17 x 21 x 1.5 C	CU	1
1013.07	Guarnición bomba aceite G 18 x 24 x 3	GS	1
	O´ring G 35 x 6	GS	4 4
	O´ring G 30 x 6	GS	4 4
	Kit de retenes completo		R471300
0956.51	Jgo. retén válvulas (16)	V	1 R471310V
0514.74	Retén bancada 85 x 105 x 8	V	1 R560111V
0326.22	Retén distribución 40 x 55 x 7	V	1 R270713V
0807.30	Retén árbol de levas 27 x 47 x 7	V	1 R470813V

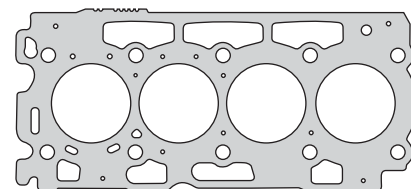

471308



471310

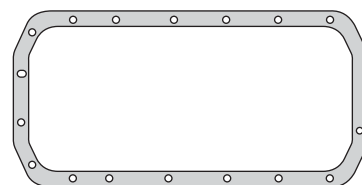

302111



302115

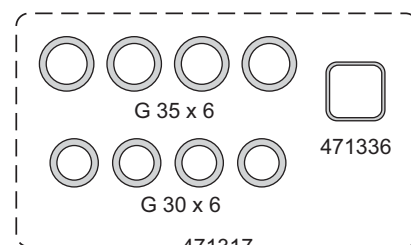

471317



302114



471319



581036



302141



A 7 x 15 x 2 C



302142



G 36.09 x 3.53



G 28 x 4



G 18 x 24 x 3



A 10 x 14 x 1.25 C



A 20 x 26 x 1.5 C



A 17 x 21 x 1.5 C



R560111V



R270713V



R470813V

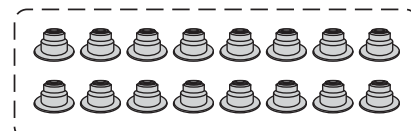

R471310V

# PEUGEOT



Motor/Engine	Cm³	HP	Ø
DW10BTED4 (RHR/RHK)	1997	136	85
DURATORQ (20DD0X) (DOHC) 16V	1998	110/115 130/140	85

DIESEL

**Citroën:** C4, C5 HDI 2004/..., C4 HDI FAP 07/...  
C8, C4 Picasso HDI 2006/...

**Ford:** C-Max TDCI, Focus TDCI, S-Max TDCI  
Galaxy TDCI, Mondeo TDCI 2006/...

**Peugeot:** 307 HDI FAP 2003/..., 407 HDI 2004/...  
Expert HDI, 807 HDI 2006/...



Nº OE	Descripción/Description	Mat.	Ref.
	Jgo. de juntas para motor		471401-R
0209.0S	Junta tapa cilindros Ø 86.0 $\pm$ 1.25	MLS	471408-1M
0209.0T	Junta tapa cilindros Ø 86.0 $\pm$ 1.30	MLS	471408-2M
0209.0V	Junta tapa cilindros Ø 86.0 $\pm$ 1.35	MLS	471408-3M
0209.0W	Junta tapa cilindros Ø 86.0 $\pm$ 1.40	MLS	471408-4M
0204.A6	Jgo. tornillos tapa cilindros (HAE14038)		B470800
0.348.S3	Conj. tapa de válvulas (5)	GS	1 471410
0304.34	Junta para cárter	NB	1 470811
	Bomba de agua	NB	1 460214
0349.J2	Múltiple admisión y escape	AC	1 471415
	Jgo. múltiple admisión (4)	GS	1 451617
1709.28	Salida de escape a turbo	AC	471418
	Guarnición termostato	GS	471419
	Bastón cierre bancada	GS	2 460235
	Guarnición termostato	GS	1 460245
0313.27	Arandela tapón cárter A 14 x 21 x 1.5 C	CU	1
1981.49	Arandela pico inyector A 7.5 x 15 x 2 C	CU	4
	Kit de retenes completo		R471400
0956.48	Jgo. retén válvulas (16)	V	1 R471410V
0127.45	Retén bancada trasera 90 x 110 x 7	V	1 R460211V
0127.47	Retén distribución 42 x 62 x 7	V	1 R460212V
0807.28	Retén árbol de levas 27 x 47 x 7	V	1 R470813V

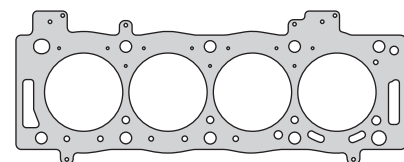

471408

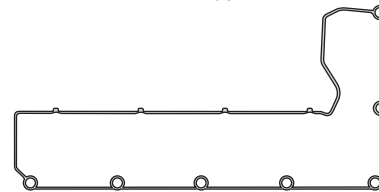

471410

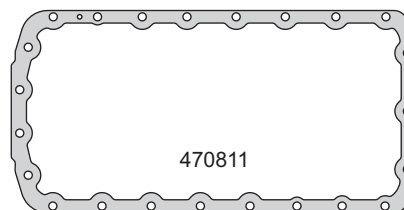

470811

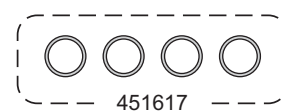

451617



471415



460214



471418



471419



460235



A 7.5 x 15 x 2 C



460245



A 14 x 21 x 1.5 C



R460211V



R460212V



R470813V

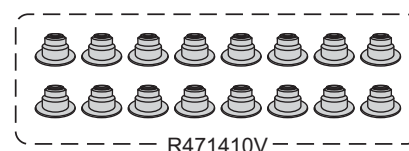

R471410V

# PEUGEOT



Motor/Engine	Cm³	HP	Ø
DW10ATED4	1997	109	85
DW10JATED4	1997	110	85
G6DA/G6DC	1998	135	85
DW12TED4 (DOHC) 16V	2179	130/133	85

**Citroën:** Evasion HDI 2000/..., C5/8 HDI 2001/..., C8, Jumpy HDI 2002/...  
**Ford:** Focus C-Max TDCI 2003/...  
**Lancia:** Phedra JTD, Zeta JTD 2000/..., 2002/...  
**Peugeot:** 806, Expert HDI 1999/... 406, 607, 807 HDI 2000/...



**DIESEL**

Nº OE	Descripción/Description	Mat.	Ref.
	Jgo. de juntas para motor		471501-R
0209.AV	Jta. tapa de cilindro Ø 86.0 ± 1.25	MLS	471408-1M
0209.AW	Jta. tapa de cilindro Ø 86.0 ± 1.30	MLS	471408-2M
0209.AX	Jta. tapa de cilindro Ø 86.0 ± 1.35	MLS	471408-3M
0209.AY	Jta. tapa de cilindro Ø 86.0 ± 1.40	MLS	471408-4M
0204.A6	Jgo. tornillos tapa cilindros (HAE14038)		B470800
0249-A6	Junta tapa válvulas	GS 1	471510
0304.34	Junta para cárter	NB 1	470811
0349.V8	Múltiple admisión y escape	AC 1	471415
0313.27	Arandela tapón cárter A 14 x 21 x 1.5 C	CU 1	
1981.43	Arandela pico inyector A 7.5 x 15 x 2 C	CU 4	
	Kit de retenes completo		R471400
0956.48	Jgo. retén válvulas (16)	V 1	R471410V
0127.28	Retén bancada 90 x 110 x 7	V 1	R460211V
0326.22	Retén distribución 42 x 62 x 7	V 1	R460212V
0807.28	Retén árbol de levas 27 x 47 x 7	V 1	R470813V

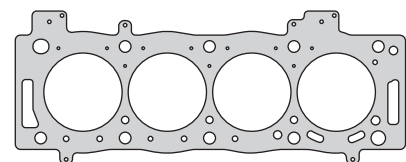

471408

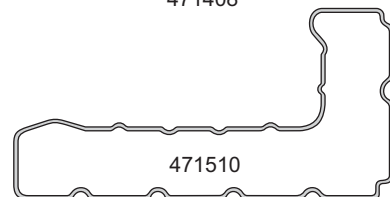

471510

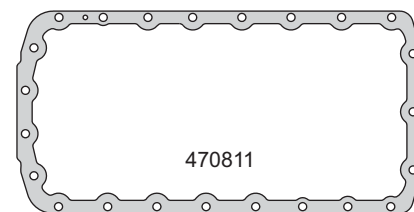

470811



471415



A 14 x 21 x 1.5 C



A 7.5 x 15 x 2 C



R460211V



R460212V



R470813V

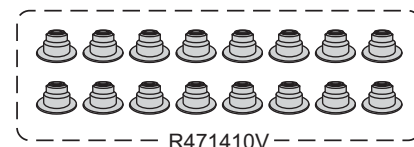

R471410V

# PEUGEOT



Motor/Engine	Cm³	HP	Ø
EP3 (8FS/8FP)	1397	95	77
EP3C (8F01)	1397	95	77
EP6 (5FW/5FS)	1598	120	77
EP6C (5F01)	1598	120	77

**Citroën:** C3 Picasso, C3, Berlingo 2009/...  
C4, C4 Coupe, C3 Picasso 2008/...  
C4 Picasso 2008/..., DS3 2010/...

**Peugeot:** 207, 207 SW, 308, 308 SW 2007/...  
Partner 2008/..., 3008, 5008 2009/...

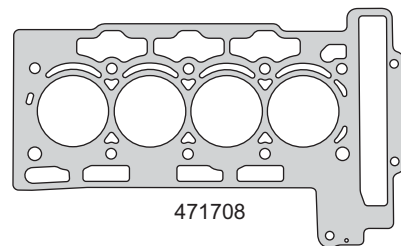

Nº OE	Descripción/Description	Mat.	Ref.
	Jgo. de juntas para motor		● 471700-R MLS
	Junta tapa cilindros Ø 78.0 ± 1.20	NFT	471707
	Junta tapa cilindros Ø 78.0 ± 0.60	MLS 1	471708
	Jgo. tornillos tapa cilindros (HAE14038)		B471700
	Sellador líquido - caucho de silicona		TRN0085G
	Conj. junta tapa válvulas (7)	GS 1	471710
	Junta para cárter	NB 1	471711
	Múltiple admisión	GS 1	471717
	Guarnición goma	GS 1	471727
	Guarnición goma	GS 1	471731
	O´ring G 72 x 4	GS 1	
	O´ring G 38 x 1.78	GS 2	
	Arandela especial A 13.6 x 24.3 x 1.2 A	AC/GS 1	
	Arandela especial A 16 x 21.8 x 2.2 C	CU 1	
	Arandela A 9.5 x 20 x 1.5 A	AL 1	
	Kit de retenes completo		R471700
	Jgo. retén válvulas (16)	V 1	R471710V
	Retén bancada 85 x 105 x 8	T 1	R560111T
	Retén distribución 61 x 75 x 8	T 1	R471712T

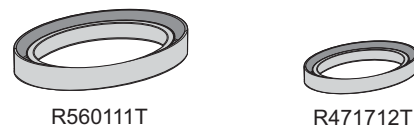
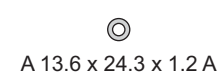
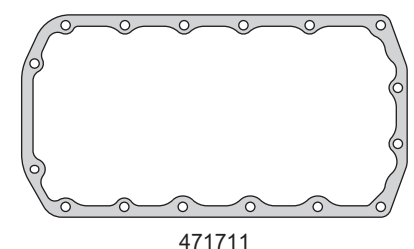
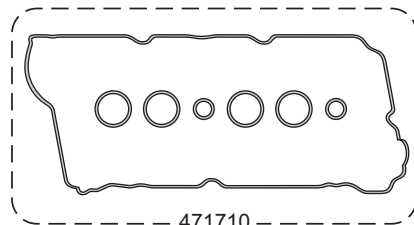



# PEUGEOT



Motor/Engine	Cm³	HP	Ø
EP6DT(5FX/5FR)	1598	150/156	77
EP6DT(5FV/5FT)	1598	150/163	77
EP6CDT (5F04)	1598	156	77
EP6DTS (5FY) (DOHC) 16V	1598	156	77

**Citroën:** C4, C4 Grand Picasso, C4 Picasso 2008/..., C5, C5 Tourer 2009/... DS3 2010/...

**Peugeot:** 207, 207 CC, 308, 308 SW 2007/... 3008 2009/..., 508, 508 SW, 5008 RCZ 2010/...

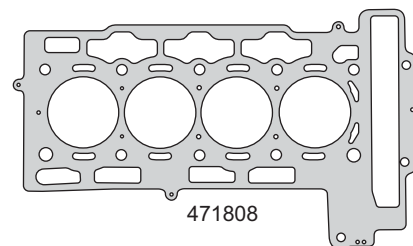

Nº OE	Descripción/Description	Mat.	Ref.
	Jgo. de juntas para motor		● 471800-R MLS
	Junta tapa cilindros Ø 78.0 ± 1.20	NFT	471807
	Junta tapa cilindros Ø 78.0 ± 0.90	MLS	1 471808
	Jgo. tornillos tapa cilindros (HAE14038)		B471700
	Sellador líquido - caucho de silicona		TRN0085G
	Conj. junta tapa válvulas (3)	GS	1 471810
	Múltiple admisión	GS	1 471717
	Guarnición goma	GS	1 471727
	Guarnición goma	GS	1 471731
	O´ring G 74 x 3.6	GS	1
	O´ring G 35 x 2	GS	2
	Arandela especial A 13.6 x 24.3 x 1.2 A	AC/GS	1
	Arandela especial A 16 x 21.8 x 2.2 C	CU	1
	Arandela A 11 x 21.3 x 2 C	CU	1
	Kit de retenes completo		R471700
	Jgo. retén válvulas (16)	V	1 R471710V
	Retén bancada 85 x 105 x 8	V	1 R560111V
	Retén distribución 61 x 75 x 8	T	1 R471712V

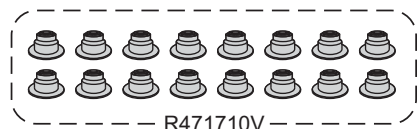
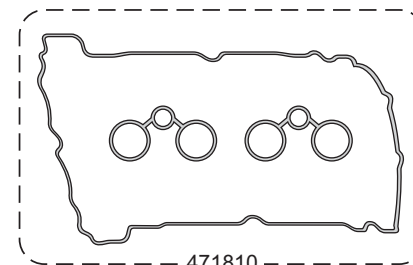

# PEUGEOT



Motor/Engine	Cm³	HP	Ø
DW10CTED4 (RH02/RHH) (DOHC) 16V	1997	150/163	85

**Citroën:** C5, C5 HDI, C5 Tourer HDI 2009/...  
C4 Picasso, C4 Grand Picasso 2010/...  
**Peugeot:** 308 HDI, 308 SW HDI, CC HDI 2007/...  
407 SW, Coupe HDI, 3008, 5008 HDI  
Expert Tepee, Expert 3 2009/...



DIESEL

Nº OE	Descripción/Description	Mat.	Ref.
	Jgo. de juntas para motor		471901-R
	Junta tapa cilindros Ø 87.0 $\pm$ 1.30	NFT	471907-1M
	Junta tapa cilindros Ø 87.0 $\pm$ 1.40	NFT	471907-2M
	Junta tapa cilindros Ø 87.0 $\pm$ 1.50	NFT	471907-3M
	Junta tapa cilindros Ø 86.0 $\pm$ 1.25	MLS	471908-1M
	Junta tapa cilindros Ø 86.0 $\pm$ 1.30	MLS	471908-2M
	Junta tapa cilindros Ø 86.0 $\pm$ 1.35	MLS	471908-3M
	Junta tapa cilindros Ø 86.0 $\pm$ 1.40	MLS	471908-4M
	Jgo. tornillos tapa cilindros (HAE14038)		B470800
	Sellador líquido - caucho de silicona		TRN0085G
	Junta tapa válvulas	PLAST 1	471910
	Bomba de agua	SLS 1	472014
	Múltiple escape	AC 1	471915
	Múltiple admisión	NB 1	471917
	Salida escape	AC	471918
	Junta termostato	GS 1	471919
	Base filtro aceite	GS	471927
	Capuchón inyector	PLAST 4	471930
	Kit de retenes completo		R471900
	Jgo. retén válvulas (16)	V 1	R471910V
	Retén bancada 90 x 110 x 7	P 1	R460211P
	Retén distribución 42 x 62 x 7	P 1	R460212P
	Retén árbol de levas 27 x 47 x 7	P 1	R470813P

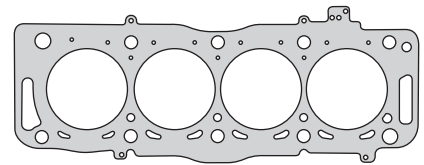

471908

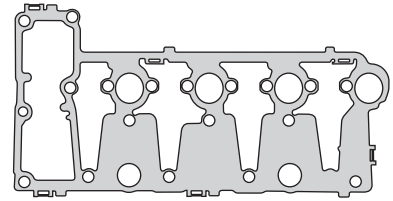

471910



471915



471917

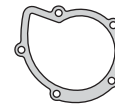

472014



471918



471919



471927



471930



R460211P



R460212P



R470813P

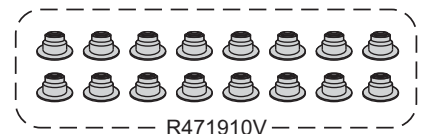

R471910V

# PEUGEOT



Motor/Engine	Cm³	HP	Ø
EW10A (RFJ/RFH) (DOHC) 16V	1997	136/140	85

**Citroën:** C4, C5 2005/...  
C4 Grand Picasso 2006/...  
C4 Picasso, Jumpy III 2007/...

**Peugeot:** 307, 407, 807 2005/...  
Expert 2007/..., 408 2011/...



Nº OE	Descripción/Description	Mat.	Ref.
	Jgo. de juntas para motor		472000-R MLS
	Jgo. de juntas superior	●	472095
	Junta tapa cilindros Ø 86.0 $\pm$ 1.20 NR	NFT 1	472007
0209 FS	Junta tapa cilindros Ø 86.0 $\pm$ 0.70 NR	MLS 1	472008
0204 A3	Jgo. tornillos tapa cilindros (HAE14038)		B472000
	Sellador líquido - caucho de silicona		TRN0085G
0249 H0/H1	Conj. junta tapa de valvulas (2)	PLAST 1 1	472010
	Junta para cárter	NB 1	472011
1206 F0	Bomba de agua	SLS 1	472014
0349 L4	Múltiple escape	AC 1 1	472015
0348 S2	Jgo. múltiple admisión (4)	GS 1 1	472017
16 090 701 80	Junta termostato	GS 1 1	472019
1104 40	Junta cambiador aceite motor	GS 1	472027
1104 38	Junta soporte cartucho filtro	GS 1	472028
0348 V5	Junta colector admisión	GS 1 1	472032
	Junta termostato	SLS 1 1	472033
	Junta termostato	SLS 1 1	472034
1019 22	Guarnición bomba aceite motor G 18 x 24 x 3	GS 1	
0313 27	Arandela tapón cárter A 14 x 21 x 1.5 C	CU 1	
	Kit de retenes completo		R472000
	Jgo. retén válvulas (16)	V 1	R460810V
0127 45	Retén bancada 90 x 110 x 7	V 1	R460211V
16 089 406 80	Retén distribución 40 x 55 x 7	V 1	R270713V
0807 32	Retén árbol levas 36 x 50 x 8	V 2	R460213V
0236 74	Retén auxiliar 38 x 50 x 6	V 1	R452113V

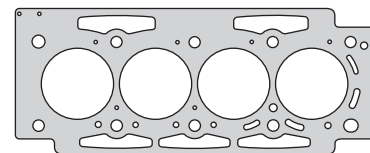

472008

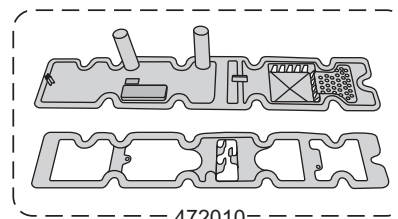

472010

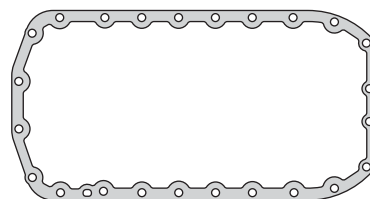

472011

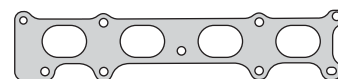

472015

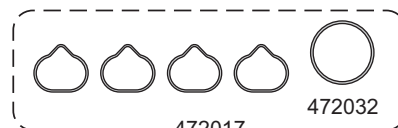

472017

472032



472014



472019



472027

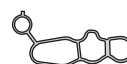

472028



472033



472034



G 18 x 24 x 3



A 14 x 21 x 1.5 C



R460211V



R270713V



R460213V



R452113V

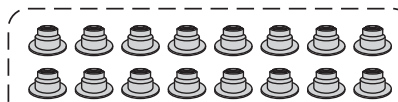

R460810V

# PEUGEOT



Motor/Engine	Cm³	HP	Ø
EB2DTS (HNY)	1199	130	75
EB2DT (HNZ) (DOHC) 12V	1199	110	75

**Citroën:** C4 Cactus, C4 Grand Picasso 2014/...  
C3 Picasso, DS3, DS4 2015/...  
C4 Picasso 2016/...

**Peugeot:** 208 2012/..., 108 2014/..., 2008, 3008,  
5008 2013/..., Partner 2016/...

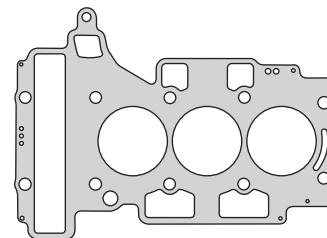

472108

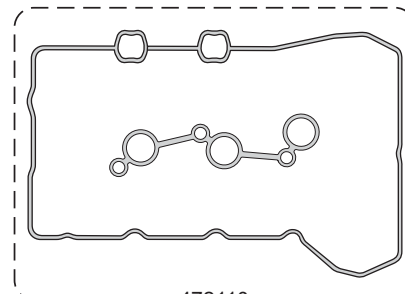

472110



472117

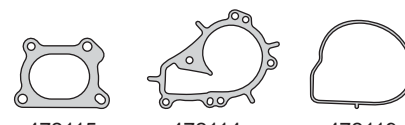

472115

472114

472119



472136



472138



A 13.5 x 24 x 2.40



B 16 x 21.5 x 2.1



A 9.7 x 20 x 1 A

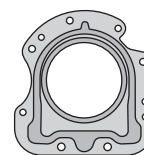

PR472111T



R472111T

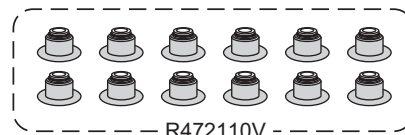

R472110V

Nº OE	Descripción/Description	Mat.	Ref.
	Jgo. de juntas para motor		● 472100-R MLS
	Junta tapa cilindros Ø 76.0 $\pm$ 1.20	NFT	472107
9676148680	Junta tapa cilindros Ø 76.0 $\pm$ 0.60	MLS	1 472108
	Jgo. tornillos tapa cilindros (HAE12038)		B472100
	Sellador líquido - caucho de silicona		TRN0085G
	Conj. junta tapa de válvulas (2)	S	1 472110
9677855380	Bomba de agua	SLS	1 472114
	Jgo. múltiple admisión (3)	GS	1 472117
9688031280	Colector de escape	AC	1 472115
	Junta termostato	GS	1 472119
	Guarnición cierre de block	GS	1 472136
	Guarnición radiador aceite	GS	1 472138
	Arandela tapón cárter A 13.5 x 24 x 2.40	AC/GS	1
	Arandela blindada B 16 x 21.5 x 2.1	CN	1
	Arandela A 9.7 x 20 x 1 A	AL	1
	Kit de retenes completo		R472100
	Jgo. retén válvulas (12)	V	1 R472110V
	Porta retén bancada	T	1 PR472111T
	Retén bancada lado distribución 61 x 75 x 8	T	1 R472111T

# PEUGEOT



Motor/Engine Cm³ HP Ø

**TU4M**  
(SOHC) 8V **1449** **89/93** **75**

Citroën: C3 2012/...

Peugeot: 208 2012/...



Nº OE	Descripción/Description	Mat.		Ref.
	Jgo. de juntas para motor			472200-R MLS
	Jgo. de juntas superior		●	472295 MLS
	Jta. tapa cilindros Ø 77.0 $\pm$ 1.20	NFT		472207
96 756 540	Jta. tapa cilindros Ø 77.0 $\pm$ 0.60	MLS	1	472208
0204.83	Jgo. tornillos tapa cilindros (HAE14038)			B470500
0249.54	Conj. junta tapa válvulas (3)	GS	1	460710
0304.30	Junta para cárter	NB	1	460711
1206.96	O´ring bomba de agua G 73.09 x 3.53	N	1	472214
0349 K1	Múltiple escape	AC	1	472215
0342.E0	Jgo. múltiple admisión (4)	S	1	452217
1709.33	Salida de escape	AC	1	452218
1340.60	Guarnición termostato	GS	1	471219
0348.Q2	Guarnición caja admisión	GS	1	452231
	Arandela tapa válvulas	GS	2	451732
	Jgo. suplemento camisa cilindros (4)	S	1	550671
0164.88	Arandela tapón cárter A 14 x 22 x 2 A	AL	1	
1103 L8	Anillo base filtro de aceite G 62 x 66 x 4.9	GS		
1103 L8	Anillo base filtro de aceite G 12 x 15 x 4	GS		
1206.94	O´ring G 56.82 x 2.62	GS	1	
5933.60	O´ring G 36.5 x 3.53	GS	1	
1103 L8	O´ring base filtro de aceite G 72.62 x 3.53	GS	1	
	Kit de retenes completo			R460700
0956.25	Jgo. retén válvulas (8)	V	1	R460710V
0514.74	Retén bancada trasera 85 x 105 x 8	V	1	R560111V
0514.72	Retén distribución 42 x 66 x 8	V	1	R460712V
0236.21	Retén árbol levas 36 x 50 x 8	V	1	R460213V

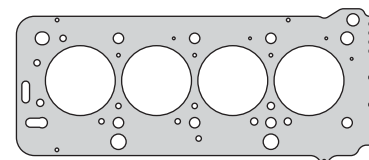

472208

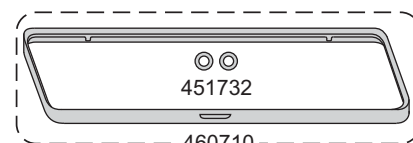

451732

460710

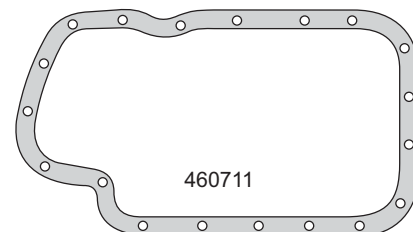

460711

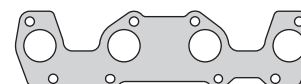

472215



452217

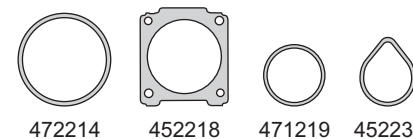

472214

452218

471219

452231

G 36.5 x 3.53

A 14 x 22 x 2 A

G 12 x 15 x 4

G 72.62 x 3.53

G 56.82 x 2.62

G 62 x 66 x 4.9

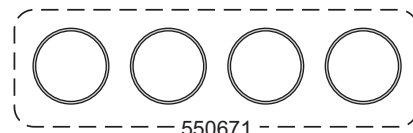

550671



R560111V



R460712V



R460213V

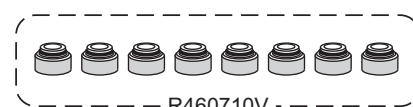

R460710V

# PEUGEOT



Motor/Engine	Cm³	HP	Ø
DV6C	1560	92/112	75
DV6DTE (SOHC) 8V	1560	112	75

**Citroën:** C3 HDI, DS3 HDI 2009/...  
**Peugeot:** Partner, 308, 207 HDI, 308 HDI 2009/...  
 3008 2009/..., 5008 2010/...

DIESEL



Nº OE	Descripción/Description	Mat.	Ref.
	Jgo. de juntas para motor		472301-R
	Jgo. juntas superior sin JTC	●	472396
	Junta tapa cilindros Ø 76.0 ± 1.20	NFT	472307-1M
	Junta tapa cilindros Ø 76.0 ± 1.30	NFT	472307-2M
	Junta tapa cilindros Ø 76.0 ± 1.40	NFT	472307-3M
	Junta tapa cilindros Ø 76.0 ± 1.50	NFT	472307-4M
	Junta tapa cilindros Ø 76.0 ± 1.60	NFT	472307-5M
0209.JN	Junta tapa cilindros Ø 76.0 ± 1.25	MLS	472308-1M
0209.JP	Junta tapa cilindros Ø 76.0 ± 1.30	MLS	472308-2M
0209.JQ	Junta tapa cilindros Ø 76.0 ± 1.35	MLS	472308-3M
0209.JR	Junta tapa cilindros Ø 76.0 ± 1.40	MLS	472308-4M
0209.JS	Junta tapa cilindros Ø 76.0 ± 1.45	MLS	472308-5M
0205.57	Jgo. tornillos tapa cilindros  (HAE14038)		B302100
0249.G2	Junta tapa válvulas	PLAST	1 1 472310
12232358/1	Junta para cárter	NB	1 302111
1145938/1	Frente motor bomba aceite	NB	1 302112
	Bomba de agua	NB	1 302114
9810697380	Múltiple de escape	AC	1 1 472315
0382 QW	Jgo. múltiple admisión G 48 x 53 x 6.5 (2)	GS	1 1 472317
2565/9451/AA//	Salida de escape	AC	1 302118
	Guarnición entrada filtro aceite	N	1 302131
	Guarnición salida filtro aceite	N	1 302132
9805583380	Junta bomba aceite motor	GS	2 472331
1019 34	Junta chupador bomba aceite	GS	1 1 581036
1104 36	Jgo. cambiador aceite motor (4)	GS	1 1 472338
0380 37	Junta turbo retorno de aceite	SLS	1 1 472341
0380 36	Junta de turbo compresor	MLS	1 1 472342
9671152980	Junta tubo racor aire G 48 x 52 x 5	GS	1 472344
0164 80	Arandela contacto aceite motor A 14 x 24 x 1.5 A	AL	1
0313 40	Arandela tapón vaciado motor A 10 x 20 x 2 A	AL	1
	Anillo G 32 x 36.5 x 3.9	GS	2
	Anillo G 40 x 43.7 x 3.9	GS	1
	Anillo G 22 x 26 x 3.9	GS	1
	Kit de retenes completos		R302100
1145937	Jgo. retenes de válvulas (8)	V	1 R302110V
1142360	Retén bancada 85 x 105 x 8	V	1 R560111V
1145953	Retén árbol de levas 27 x 47 x 7	V	1 R470813V
1142359	Retén distribución 40 x 55 x 7	V	1 R270713V

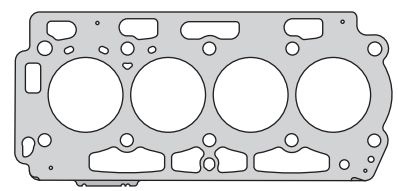

472308

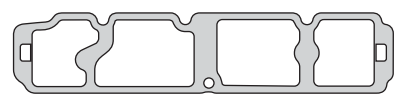

472310

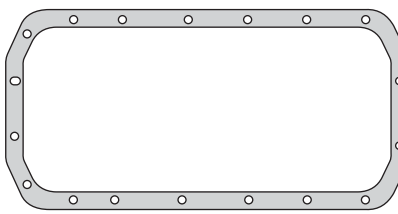

302111



472315



472317

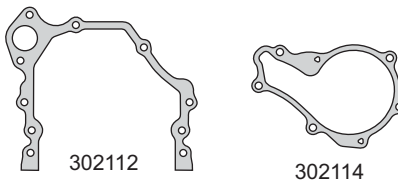

302112

302114

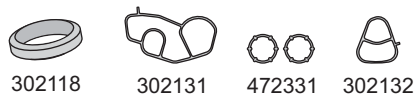

302118

302131

472331

302132

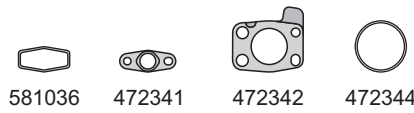

581036

472341

472342

472344

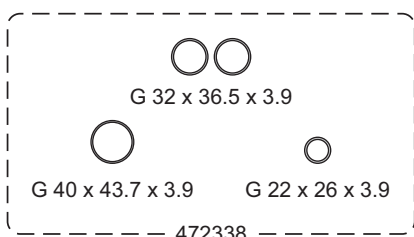

G 32 x 36.5 x 3.9

G 40 x 43.7 x 3.9

G 22 x 26 x 3.9

472338



A 14 x 24 x 1.5 A

A 10 x 20 x 2 A

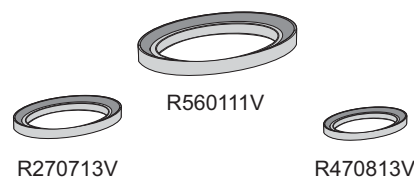

R560111V

R270713V

R470813V



R302110V

PEUGEOT



Motor/Engine

Cm³

HP

Ø

XD/XDP 4.88

1948

50/59

88

Peugeot: 404, T4B, T5B, Rastrojero 1972/...

DIESEL

Nº OE	Descripción/Description	Mat.	Ref.
0199541	Jgo. de juntas para motor		500200-R
	Jgo. de juntas superior		500295
0203510	Junta tapa cilindros Ø 92.0 ± 1.40	NFT 1 1	500205
0203510	Junta tapa cilindros Ø 92.0 ± 2.40	NFT	500206
0203510	Junta tapa cilindros Ø 92.0 ± 1.40	NFT	500207
	Junta tapa cilindros Ø 98.5 ± 1.40	NFT	500707
	Junta tapa cilindros Ø 92.0 ± 1.40	NFT	500907
0203510	Junta tapa cilindros Ø 92.0 ± 1.70	CNC	500208
	Jgo. tornillos tapa cilindros (HAS17038)		B500200
0249250	Conj. junta tapa de válvulas superior (9)	CG 1 1	500210
0313070	Junta para cárter	CG 1	500211
0321090	Tapa distribución	CB 1	500212
0321100	Placa distribución	CB 1	500213
1206070	Bomba de agua	NB 1 1	500214
0349080	Múltiple de escape	NFT 2 2	500215
	Múltiple de admisión	NB 2 2	500217
1710070	Salida de escape	NFT 1 1	450018
	Salida de escape	NFT 1 1	300918
0321090	Tapa distribución	NB	500225
1104030	Base filtro de aceite	NB 1	500227
0253031	Arandela tapa de válvulas A 8 x 20 x 1.5 F	NB 4 4	500230
7700513014	Arandela tapa válvulas A 7 x 17 x 1.5 F	NB 4 4	550430
0147080	Lateral inspección botadores	CG 2	500231
1925040	Bomba inyectora	CB 1	500233
1179060	Respiradero de cárter	CG 1	500234
0243010	Arandela B16 x 21 x 2.4CN	CN	150035
0127050	Bastón cierre bancada	GS 2	450035
	Central de admisión	NB 1 1	500235
1981.020	Arandela parallamas pico inyector	AC 4 4	560036
	Jgo. múltiple admisión y escape (5)	VS 1	500236
0313070	Junta para cárter	NB	500238
0249050	Tapa de válvulas superior	GS	500239
1981050	Arandela base inyector A 16 x 21 x 2 C	CU 3	500240
	Arandela asiento flauta balancines	GS 1 1	500241
1041100	Base filtro aceite a bomba	NB 1	500242
0236070	Tapa cámara de agua tapa cilindros	NB 2 2	500243
1170031	Varilla nivel aceite	CG 1	500244
0956010	Guía de válvulas G 14 x 7 x 3	GS 8 8	500245
	Regulación bomba inyectora	NB 1	500246
	Arandela cañería gas oil A 12.5 x 15 x 1 C	CU 10	500251
	Arandela conexión pres. Aceite A 8 x 14 x 1 C	CU 6	500252
	Arandela retorno base inyectora A 8 x 12 x 1 C	CU 8	500253
	Arandela tapón des. agua block A 14 x 20 x 1.5 C	CU	500254
0119.010	Soporte motor	CB 1	500255
0313.070	Jgo. empaquetadura bancada (2)	SNA 1	500258
0249.260	Junta para cárter	CGT	500260
0321.100	Junta tapa de válvulas superior	CGT	500261
1925.040	Placa distribución	NH	500262
1041.100	Bomba inyectora	NH	500263
0112.118	Base filtro de aceite bomba	NH	500264
	Jgo. suplemento camisa cilindros (4)	GS 1	500270
	Arandela A16 x 22 x 1C	CU 1	
	Arandela A 14 x 20 x 2 C	CU 4	

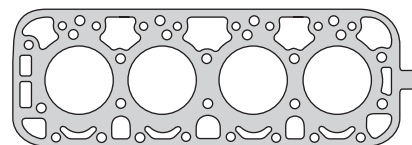

500205

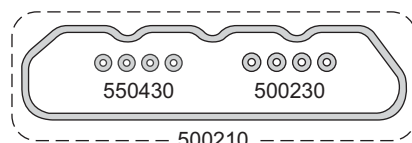

500210

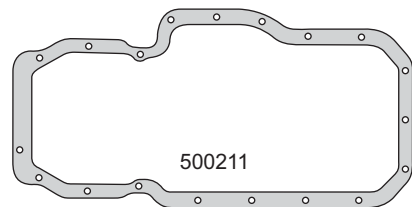

500211



500231

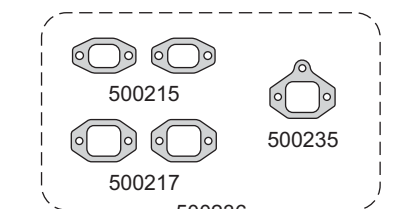

500215

500235

500217

500236

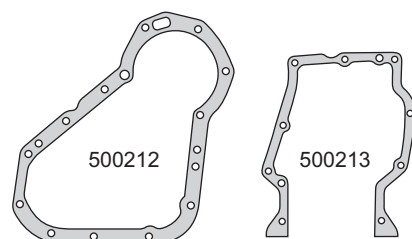

500212

500213

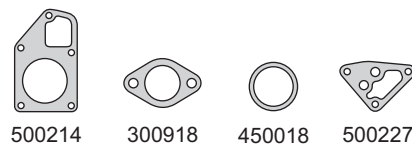

500214

300918

450018

500227



500233

500234

450035

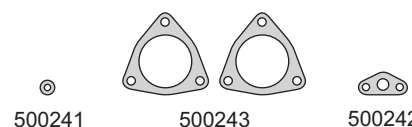

500241

500243

500242

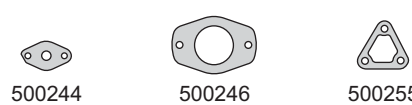

500244

500246

500255



560036



500270

**PEUGEOT**



Motor/Engine	Cm³	HP	Ø
<b>XD/XDP 4.88</b>	<b>1948</b>	<b>50/59</b>	<b>88</b>

Peugeot: 404, T4B, T5B, Rastrojero 1972/...

**DIESEL**

Nº OE	Descripción/Description	Mat.	Ref.
	Arandela A 7 x 11 x 1C	CU	2
	Arandela A 8 x 18.5 x 1.5 NH	NB	4
	Arandela A 16 x 22 x 1.5 A	AL 3	
	O´ring G 7.5 x 15 x 11.5	GS	1
	Kit de retenes completo		R500200
	Jgo. retén válvulas (8)	V	1 R460210V
0517.001	Ret. distrib. 42 x 60 x 10 Ø 42 Hasta 1978	P	1 R450012P
048.410	Ret. distrib. 45 x 60 x 10 Ø 45 Desde 1978	P	1 R450412P

A 16 x 21 x 1.5 A      A 16 x 21 x 2 C  
 A 12.5 x 15 x 1 C  
 A 8 x 14 x 1 C      A 8 x 12 x 1 C  
 A 16 x 22 x 1 C  
 A 14 x 20 x 2 C      A 7 x 11 x 1 C  
 A 8 x 18.5 x 1.5  
 G 7.5 x 15 x 11.5      G 14 x 7 x 3  
 500258  
 R450012P      R450412P  
 R460210V



**PEUGEOT**



Motor/Engine	Cm³	HP	Ø
XDP 6.90	3168	95	90

Peugeot: Pick Up, Camiones Livianos 1976/...

DIESEL



Nº OE	Descripción/Description	Mat.	Ref.
	Jgo. de juntas para motor		500300-R
7932564965	Junta tapa de cilindros Ø 94.0 ± 1.40	NFT	500305
7932564965	Junta tapa de cilindros Ø 94.0 ± 1.40 NR <sup>2</sup>	NFT	1 500307
	Jgo. tornillos tapa cilindros (HAS17038)		B500300
705811400	Conj. junta tapa de válvulas superior (8)	CG	2 500310
7581117000	Junta para cárter	CG	1 500311
7058122700	Tapa distribución	CB	1 500212
7058122000	Contratapa distribución	CB	1 500213
758120300	Bomba de agua	NB	1 500314
7058145700	Jgo. múltiple escape (4)	NFT	1 500215
	Jgo. múltiple admisión (6)	NB	1 500217
	Salida de escape	NFT	1 500318
7932564965	Codo termostato tapa cilindros	NB	1 500319
7932561837	Base filtro de aceite	NB	1 500227
	Arandela tapa de válvulas A 8 x 20 x 1.5 F	NB	6 500230
A-56271500	Lateral botadores	CG	2 500331
7580642000	Bomba inyectora	CB	1 500233
	Respiradero de cárter	CG	1 500234
	Arand. pres. ac./temp./t.cár. B 16 x 22 x 2.4 CN	CN	150035
0127.050	Bastón bancada	GS	2 450035
1981.020	Arandela parallamas inyector	AC	6 560036
	Arandela base inyector A 16 x 21 x 2 C	CU	6 500240
	Arandela conducto flauta balanc. G 16 x 7 x 5	GS	1 500241
	Bomba de aceite a block	NB	1 500242
	Varilla nivel aceite	CG	1 500244
	Retén guía de válvulas G 14 x 7 x 3	GS	12 500245
K-370082	Jgo. empaquetadura bancada (2)	SNA	1 500258
	Jgo. suplemento camisa cilindros (6)	GS	1 500370
	Arandela A 16 x 22 x 1.5 A	AL	3
	Kit de retenes completo		R500300
	Jgo. retén válvulas (12)	P	1 R461510P
0517.001	Retén distribución 42 x 60 x 10	P	1 R450012P

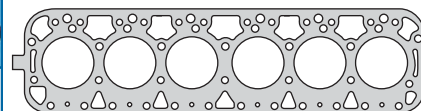

500307

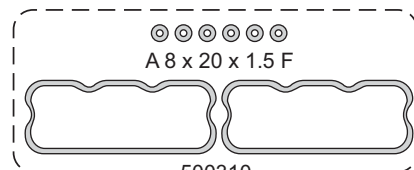

A 8 x 20 x 1.5 F

500310

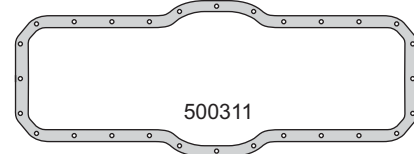

500311



500331

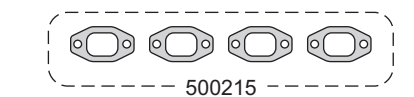

500215

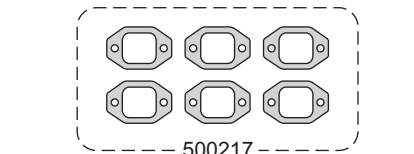

500217

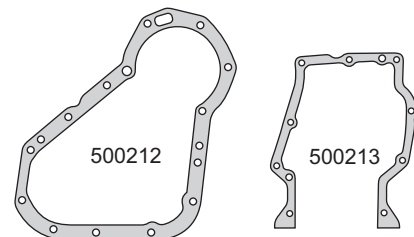

500212

500213

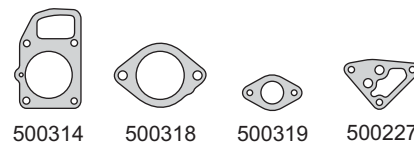

500314

500318

500319

500227

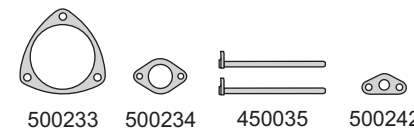

500233

500234

450035

500242



500244

G 16 x 7 x 5

A 16 x 21 x 2 C

G 14 x 7 x 3



560036

A 16 x 22 x 1.5 A



500370



500258

R450012P

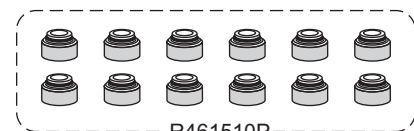

R461510P

# PEUGEOT



Motor/Engine	Cm³	HP	Ø
<b>XD-XDP 4.90</b>	<b>2112</b>	<b>59</b>	<b>90</b>

Peugeot: 504 1980/..., J7, J9 1980/87  
Adaptables Pick Up

DIESEL



Nº OE	Descripción/Description	Mat.	Ref.
	<b>Jgo. de juntas para motor</b>		<b>500600-R</b>
	<b>Junta tapa cilindros Ø 94.0 ± 1.70</b>	<b>NFT 1</b>	<b>500605</b>
	<b>Jgo. tornillos tapa cilindros (HAS17038)</b>		<b>B500200</b>
0.249.250	Junta tapa de válvulas superior	CG 1	500210
0.313.070	Junta para cárter	CG 1	500211
0.321.090	Tapa distribución	CB 1	500212
0.321.100	Placa distribución	CB 1	500213
1.206.070	Bomba de agua	NB 1	500214
0.349.080	Múltiple escape	NFT 2	500215
	Múltiple admisión	NB 2	500217
	Salida de escape	NFT 1	300918
1.710.070	Salida de escape	NFT 1	450018
0.321.090	Tapa distribución	NB 1	500225
1.104.030	Base filtro de aceite	NB 1	500227
0.253.031	Arandela tapa de válvulas	NB 4	500230
0.147.080	Lateral inspección botadores	CG 2	500231
1.925.040	Bomba inyectora	CB 1	500233
1.179.060	Respiradero de cárter	CG 1	500234
0.243.010	Arandelas tapón cárter B 16 x 22 x 2.4 CN	CN 3	150035
0.127.050	Bastón cierre bancada	GS 2	450035
	Central de admisión	NB 1	500235
	Jgo. admisión y escape (5)	VS 1	500236
0.313.070	Junta para cárter	NB	500238
0.249.050	Junta tapa de válvulas superior	GS	500239
1.981.050	Arandela base inyector A 16 x 21 x 2 C	CU 4	500240
	Arandela asiento flauta balancines	GS 1	500241
1.041.100	Base filtro aceite a bomba	NB 1	500242
0.236.070	Tapa cámara de agua tapa cilindros	NB 2	500243
1.170.031	Varilla nivel aceite	CG 1	500244
0.956.010	Guía de válvulas	GS 8	500245
	Regulación bomba inyectora	NH 1	500246
	Jgo. empaquetadura cigüeñal (2)	SNA 1	500258
0517.001	Retén distribución 42 x 60 x 10	P 1	R450012P

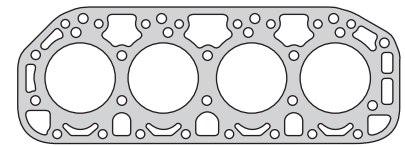

500605

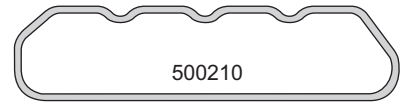

500210

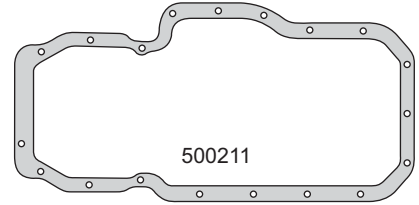

500211

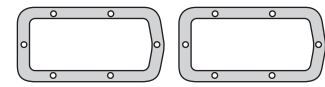

500231

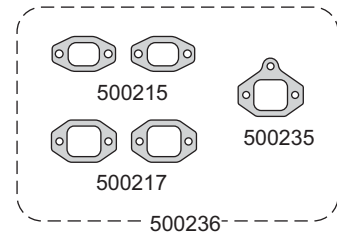

500215

500235

500217

500236

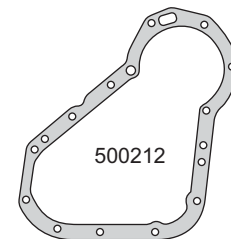

500212

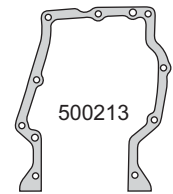

500213



500214



300918



450018



500227



500230



500233



500234



450035



500241



500242



500244

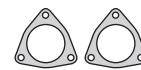

500243



500245



500246

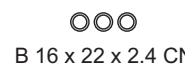

B 16 x 22 x 2.4 CN



A 16 x 21 x 2 C

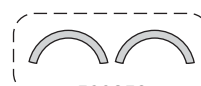

500258



R450012P

# RASTROJERO



















Motor/Engine  **Cm³** **HP** **Ø**  
**Borgward D4M** **1758** **42** **78**

Rastrojero: Pick Up, NP6 1955/66

**DIESEL**



Nº OE	Descripción/Description	Mat.	Ref.
	Jgo. de juntas para motor 		<b>500000-R</b>
<b>C-46-12-1</b>	<b>Junta tapa cilindros Ø 78.0 ±1.40</b> 	<b>NFT 1</b>	<b>500005</b>
C-46-12-1	Junta tapa válvulas superior 	CG 1	500010
E-41-12-24	Junta para cárter 	CG 1	500011
0713015600	Tapa distribución 	CB 1	500012
B-41-11-4	Placa distribución 	CB 1	500013
B-41-11-5	Bomba de agua 	NB 1	500014
E-15-16-5	Jgo. múltiple escape (4) 	NFT 1	500015
36 DIN 71511	Tubo admisión 	GS 2	500017
E-41-12-35	Salida de escape 	NFT 1	500018
1401123	Bomba agua a block 	NB 1	500019
E-15-16-7	Termostato	CB 1	500030
E-12-12-36	Base carcasa termostato	CB 1	500031
E-12-12-24	Tapa filtro aceite	NB 1	500032
E-41-11-11	Filtro aceite a block	NB 1	500033
E-41-11-12	Base bomba aceite	NB 1	500034
E-12-15-19	Válvula reguladora	NB 2	500035
E-41-17-7	Junta tapa válvulas inferior 	CG 1	500036
0463023400	Buje porta engranaje bomba aceite	CG 1	500037
E-46-15-3	Tapa bomba agua	NB 1	500038
	Tubo descarga gases cárter	NB 1	500039
E-12-11-57	Bomba inyectora distribución	NB 1	500040
E-41-17-3	Base bomba combustible	NB 1	500041
0713064700	Acople bomba agua	NB 1	500042
E-11-16-21	Ajuste bomba inyectora	NB 1	500043
036067000	Arandela porta tobera A 23 x 28 x 2	NH 4	500044
E-41-12-7	Bomba alimentación bomba inyectora	NB 1	500045
	Junta retén distribución	FIE 1	500046
	Arandela porta inyector A 32 x 36 x 0.5 C	CU 4	500047
E-41-12-6	Arandela asiento inyector A 32 x 36 x 1 C	CU 4	500048
	Caja dirección	CB	500049
	Jgo. juntas caja velocidades	VS	500050
	Diferencial	CB	500055
P-6332003	Palier	CB	500056
E-28-24-43	Jgo. empaquetadura cigüeñal (2) 	SNA 1	500258
	Jgo. juntas para cárter 	CGT	500060
	Kit de arandelas (12)	VS 1	500075
	Kit de retenes completo 		R500100
	Jgo. retén válvulas (8) 	P 1	R500010P
	Retén distribución 42 x 68 x 10/16 	N 1	R500012N

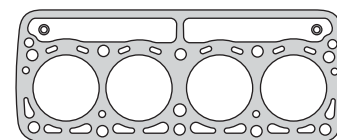

500005

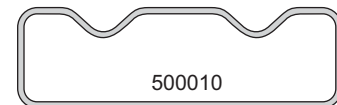

500010

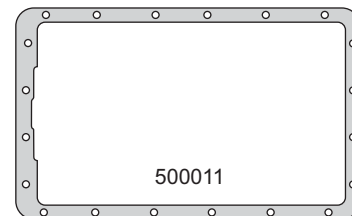

500011

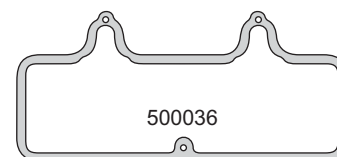

500012

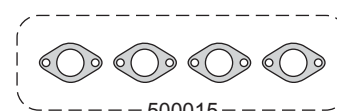

500013

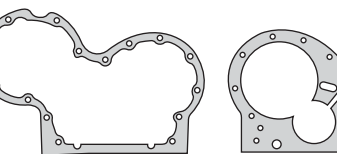

500015



500014

500013

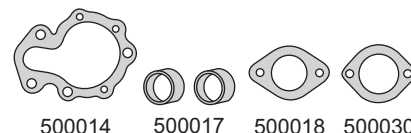

500014

500017

500018

500030



500019

500031

500033

500032

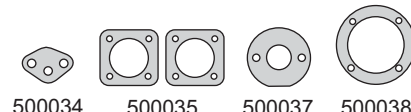

500034

500035

500037

500038

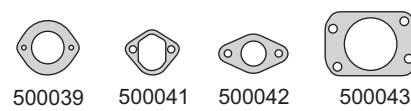

500039

500041

500042

500043

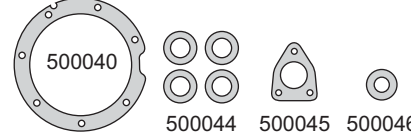

500040

500044

500045

500046



500047

500048



500258



R500012N



R500010P

# RASTROJERO



Motor/Engine	Cm³	HP	Ø
Borgward D301 - E1D	1797	52	78

**Rastrojero:** Pick Up, Kombi, Frontal  
NC62/NP66, P63/P64  
C66/P67 1964/71



DIESEL

Nº OE	Descripción/Description	Mat.	Ref.
	Jgo. de juntas para motor		500100-R
130906146	Junta tapa cilindros Ø 80.0 ±1.40	NFT	1 500105
130906146	Junta tapa válvulas	CG	1 500110
130907111	Junta para cárter	CG	1 500011
0713015600	Tapa distribución	CB	1 500112
130903110	Placa distribución	CB	1 500113
130903104	Cuerpo bomba de agua	NB	1 500114
130920108	Jgo. múltiple escape (4)	NFT	1 500015
	Múltiple admisión	GS	2 500017
36 DIN 71511	Múltiple admisión	NH	500117
130946105	Salida de escape	NFT	1 500118
P6337001	Placa bomba de agua	NB	1 500119
130920109	Termostato	CB	1 500030
E-12-12-36	Base carcasa termostato	CB	1 500031
E-12-12-24	Bomba inyectora distribución	NB	1 500131
130903111	Tapa filtro aceite	NB	1 500032
E-41-11-11	Tubo descarga gases cárter	NH	1 500132
130901122	Filtro aceite a block	NB	1 500033
E-41-11-12	Separador filtro aceite a block	NB	1 500133
130932105	Base bomba aceite	NB	1 500034
E-12-15-18	Soporte bomba inyectora	NB	1 500134
130942101	Válvula reguladora	NB	2 500035
E-41-17-7	Separador filtro aceite a carcasa	NB	1 500135
130924104	Buje porta engranaje bomba aceite	CG	1 500037
E-46-15-3	Arandela porta tobera A 28 x 36 x 0.5 A	AL	4 500137
130906143	Anillo o'ring admisión G 42 x 3.5	GS	1 500138
	Base bomba combustible	NB	1 500041
0713064700	Bomba alimentación bomba inyectora	NB	1 500045
	Palier diferencial TRANSAX	CB	500156
	Jgo. caja velocidades	CB	500050
	Palier TRANSAX	CB	500156
	Jgo. empaquetadura cigüeñal (2)	SNA	1 500258
	Kit de retenes completo		R500100
	Jgo. retén válvulas (8)	P	1 R500010P
	Retén distribución 45 x 68 x 10/16	N	1 R500012N

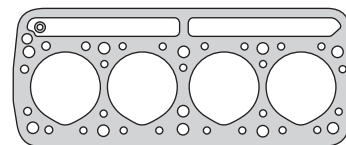

500105

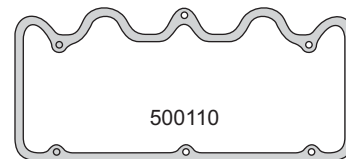

500110

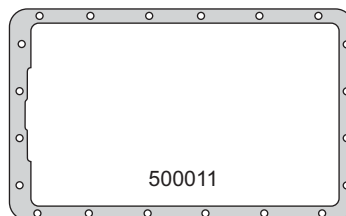

500011

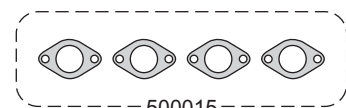

500015

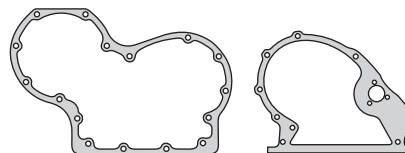

500112

500113

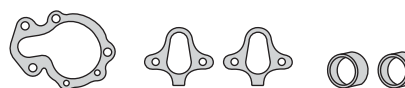

500114

500117

500017



500118

500119

500030

500031

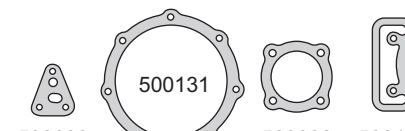

500033

500131

500032

500132



500133

500134

500034

500135



500035

500137

500138



500037

500041

500045



500258

R500012N

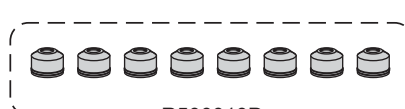

R500010P

# RENAULT / IKA / DACIA

## JUNTA TAPA DE CILINDROS / HEAD GASKETS



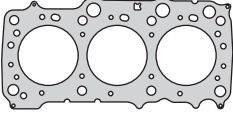
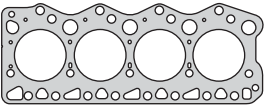
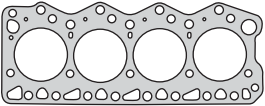
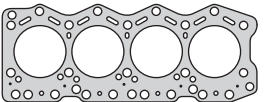
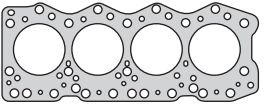
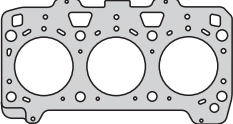
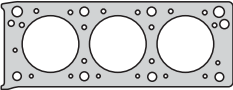
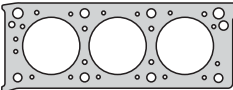
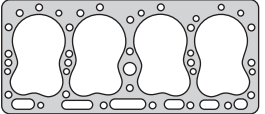
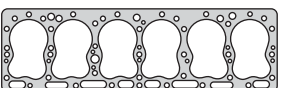

### MOTORES NAFTA Y DIESEL / PETROL AND DIESEL ENGINES

	Código Code	Q	≠	Kit Bulón Bolt Set	Aplicación Application	Motor Engine	Juego
	243908	88.5	1.10	B243900 HAD14038	Espace IV DCI 2002/06 DIESEL	2958cc. P9X-701 180HP Ø87.5 (DOHC) V6 24V	
	251407	95.0	1.40	B270100 HAS17038	B90 1986/88 DIESEL	2445cc. 8140.21 92HP Ø93 (SOHC) 8V	251400-R 🚗 pág. 172
	270107	96.0	1.30	B270100 HAS17038	Master TD 1998/... Jumper HDI 2001/09 DIESEL	2799cc. S9W 700/702 115HP Ø94.4 (SOHC) 8V 2798cc. 8140.43 Euro II - 8140.43S Euro III - Common Rail (SOHC) 8V 122/125HP Ø94.4	270300-R 270301-R 🚗 pág. 200 252901-R 🚗 pág. 181
	270407	95.0	1.70	B270100 HAS17038	Master 1990/... - 1998/... Trafic 1990/... DIESEL	2499cc. S8U 742/748/770/772/758 780/782 55/75/80HP (SOHC) 8V Ø93	270400-R 270401-R 🚗 pág. 202
	270807	95.0	1.70	B270100 HAS17038	Master 1981/88 DIESEL	2445cc. S8U 730/731 52HP Ø93	
	452308	89.0	0.74	B452300 HAE14038	Avatime, Clio II Sport 2000/... Laguna 2001/...	2946cc. L7X-721/722/731 207/226HP Ø87 (DOHC) V6 24V	
	452507	90.0	1.40	B452500	R25 1984/91	2664cc. Z7V-708/709 144HP Ø88 (SOHC) 12V	
	452607	93.0	1.40	B452500	R25 Turbo, Alpine Turbo 1986/92 R25 1987/89	2458cc. Z7U-700/702/734 181/205HP Ø91 2849cc. Z7W-702/706/707 150HP Ø91 (SOHC) 12V	
	540005	86.5	1.70		Jeep Continental, Bergantin 1954/74	2470cc. 4L - 151 80HP Ø84.14	540000-R 🚗 pág. 461
	540105	87.0	1.70		Estanciera, Baqueano, Gladiator Continental, Kaiser Carabela Manhattan 1955/... Bergantin Super 1954/67	3705cc. L226 110HP Ø84.14	540100-R 🚗 pág. 462

# RENAULT / IKA / DACIA

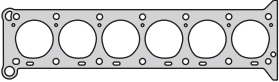
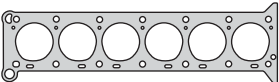
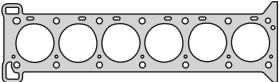
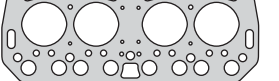
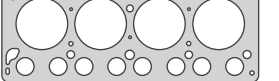
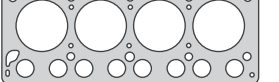
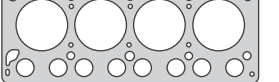
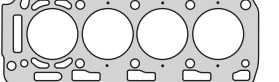
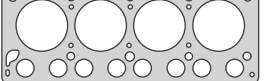
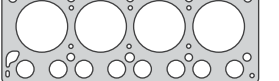
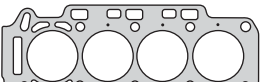
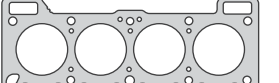
## JUNTA TAPA DE CILINDROS / HEAD GASKETS











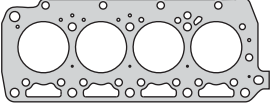

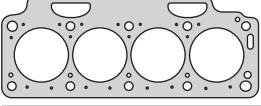

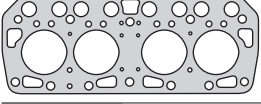

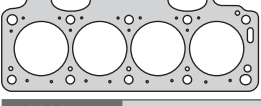



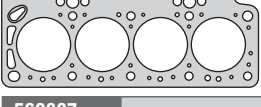

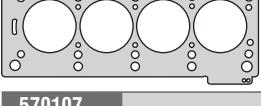

### MOTORES NAFTA Y DIESEL / PETROL AND DIESEL ENGINES

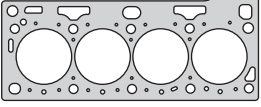
	Código Code	Q	≠	Kit Bulón Bolt Set	Aplicación Application	Motor Engine	Juego
	540205	87.5	1.40		Torino, Rambler, Utilitario, Gladiator Jeep T80 1966/73	<b>2966cc.</b> OHC 181 4B 300/300S/380 Ø84.94	<b>540200-R</b> 🚗 pág. 463
	540205	87.5	1.40		Rambler, Torino Tornado 300SL Gladiator 1966/73	<b>2966cc.</b> OHC 181/230/300 140/160HP Ø84.94	<b>540400-R</b> 🚗 pág. 465
	540305	87.5	1.40		Torino Tornado Reforma 1972/74	<b>3770cc.</b> OHC 4B 180HP Ø84.94	<b>540500-R</b> 🚗 pág. 466
	540305	87.5	1.40		Torino 1973/...	<b>3770cc.</b> OHC 181/230/300/380 7B Ø84.94	<b>540300-R</b> 🚗 pág. 464
	550005 550006	59.0 59.0	1.40 2.40		Gordini, Floride, Dauphine 4L - 4F 1960/64	<b>845cc.</b> 670-04/05 26HP Ø58	<b>550000-R</b> 🚗 pág. 467
	550405 550406 550407	74.0 74.0 74.0	1.40 2.40 1.40	<b>B550400</b> 🚗 HAS17038	R12/R4L/4S/R6/R4 1970/... R12TS/R15 1972/75	<b>1289cc.</b> 688.01/10-810.88 54HP Ø73 (OHV) 8V	<b>550400-R</b> 🚗 pág. 468
	550505 550506 550507	77.0 77.0 77.0	1.40 2.40 1.20	<b>B550400</b> 🚗 HAS17038	R12TS/R5TX 1976/80	<b>1397cc.</b> 847 63/68HP Ø76 (OHV) 8V	<b>550500-R</b> 🚗 pág. 469
	550505 550506 550507	77.0 77.0 77.0	1.40 2.40 1.20	<b>B550400</b> 🚗 HAS17038	TXL 1310/1410	<b>1397cc.</b> TXL 60HP Ø76 (SOHC) 8V	<b>560200-R</b> 🚗 pág. 476
	550505 550506 550507	77.0 77.0 77.0	1.40 2.40 1.20	<b>B550400</b> 🚗 HAS17038	R12/R18, Junior, Trafic 1982/...	<b>1397cc.</b> 847 (OHV) 8V 48HP Ø76	<b>550800-R</b> 🚗 pág. 472
	550605 550606 550607	89.0 89.0 89.0	1.40 2.40 1.20	<b>B550600</b> <b>B550600-1</b> 🚗 HAS19038	Master 1981/93, R18, Fuego 1981/86 Trafic, R21/R25 1983/94, Espace 1984/97 R20 1977/84	<b>1995cc.</b> 829 - J5R 80HP - J6R 102/105/110/116/120HP J7R105/120HP Ø88	<b>550600-R</b> 🚗 pág. 470
	550605 550606 550607	89.0 89.0 89.0	1.40 2.40 1.20	<b>B550600</b> <b>B550600-1</b> 🚗 HAS19038	R25 1984/92, R18 1985/..., R21, Fuego Espace 1986/97, Trafic, Master 1989/...	<b>2165cc.</b> 851 - J7T 95/107/115/120HP Ø88	
	550705 550707	77.0 77.0	1.40 1.20	<b>B550400</b> 🚗 HAS17038	R9 1981/89, R11 1983/89, R19/R21 1988/93, Super Cinco 1985/93	<b>1397cc.</b> C1J - C2J 60/67HP 104/110HP Ø76 (OHV) 8V Turbo	<b>550700-R</b> 🚗 pág. 471
	550705 550707	77.0 77.0	1.40 1.20	<b>B550400</b> 🚗 HAS17038	Twingo, Clio, Express 1992/...	<b>1239cc.</b> C3G 55HP Ø74 (OHV) 8V	<b>570000-R</b> 🚗 pág. 483
	550905 550906 550907	78.0 78.0 78.0	1.40 2.40 1.20	<b>B550400</b> 🚗 HAS17038	R9/R11/R12/R18/R19 1988/...	<b>1565cc.</b> C1L - C2L Carburador Ø77	<b>550900-R</b> 🚗 pág. 473
	550905 550906 550907	78.0 78.0 78.0	1.40 2.40 1.20	<b>B550400</b> 🚗 HAS17038	R19, Clio, Express 1996/98	<b>1597cc.</b> C3L Inyección 74HP Ø76	<b>560500-R</b> 🚗 pág. 479

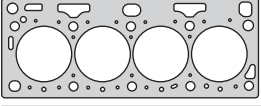
# RENAULT / IKA / DACIA

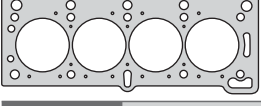
## JUNTA TAPA DE CILINDROS / HEAD GASKETS

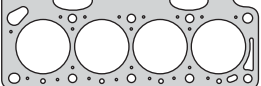









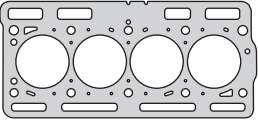

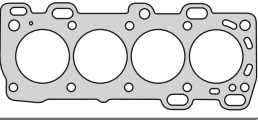

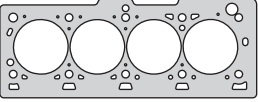





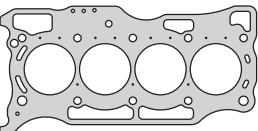

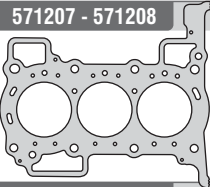
### MOTORES NAFTA Y DIESEL / PETROL AND DIESEL ENGINES

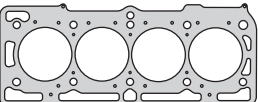
	Código Code	Q	≠	Kit Bulón Bolt Set	Aplicación Application	Motor Engine	Juego
	560007-1M	87.0	1.70	B560000	R18 1981/86, R21 1984/97, Trafic Master 1981/97	<b>2068cc.</b> 121 80HP Ø86 (SOHC) 8V	<b>560001-R</b>  pág. 474
	560007-2M	87.0	1.60	 HAH10055	<b>DIESEL</b>		
	560007-3M	87.0	1.80	HAE18038			
				HAS19038			
	560107	81.7	1.20	B560600 B560600-1	R19 1989/95, R11 1986/89, Clio 1990/93 R21, Trafic, Super Cinco 1986/94	<b>1721cc.</b> F2N - F3N 75/92HP Ø81 (SOHC) 8V	<b>560100-R</b>  pág. 475
				 HAT55055 HAT55100 HAE14038			
	560305	59.0	1.40		R5 1973/84	<b>845cc.</b> 839.01 - 800.10 39HP Ø58 (OHV) 8V	<b>560300-R</b>  pág. 477
	560307	59.0	1.40				
	560407	83.5	1.40	B560600 B560600-1	R19, Clio, Laguna 1991/98	<b>1794cc.</b> F3P Inyección 90/96HP Ø82.7 (SOHC) 8V  <b>1998cc.</b> F3R 722/796/729 115HP Ø82.7 (SOHC) 8V	<b>560400-R</b>  pág. 478  <b>570400-R</b>  pág. 487
				 HAT55055 HAT55100 HAE14038	Megane RT, Scenic, Laguna RT, RXE		
	560607-2M	81.0	1.60	B560600 B560600-1	R9, Express, Clio, Kangoo, Trafic Scenic, Megane	<b>1870cc.</b> F8Q 65HP Ø80 (SOHC) 8V  <b>1870cc.</b> F8Q (con cárter de aluminio) 65HP Ø80 (SOHC) 8V	<b>560601-R</b>  pág. 480  <b>560701-R</b>  pág. 481
	560607-1M	81.0	1.70	 HAT55055	R9, Express, Clio, Kangoo, Trafic Scenic, Megane		
	560607-3M	81.0	1.80	HAT55100 HAE14038			
	560807	77.0	1.40	B560800	E5F/E7F Clio, R19 1990/98	<b>1171cc.</b> E5F/E7F 55/60HP Ø75.8 <b>1390cc.</b> E6J/E7J Energy 77/80HP Ø75.8 (SOHC) 8V	<b>560800-R</b>  pág. 482
				 HAE12038	E6J/E7J Clio, R19, Express 1990/95 Kangoo 2001/..., Megane 1995/97		
	570107	84.0	1.30	B570100	Clio 1991/97, R19 1989/96	<b>1764cc.</b> F7P 700/704 133/137HP F7P 720/722 16V 135/140HP <b>1998cc.</b> F7R 700/710/714 147/150HP Ø82 (DOHC) 16V	<b>570100-R</b>  pág. 484
				 HAT55055 HAT55100	Clio, Clio Williams 1993/... Megane Coupe 1995/99 Spider Sport 1993/...		
	570107	84.0	1.30	B570100	Clio 1991/97, R19 1989/96	<b>1764cc.</b> F7P 700/704 133/137HP 720/722 135/140HP Ø82 (DOHC) 16V	<b>580400-R</b>  pág. 499
				 HAT55055 HAT55100			
	570205	80.0	1.30	B570200 B570200-1	Megane Scenic RN, Clio 1998/... Clio II 1998/05, Sandero 2007/...	<b>1598cc.</b> K7M - 744 75/90/95HP Ø79.5 (SOHC) 8V	<b>570200-R</b>  pág. 485
	570207	80.0	1.30	 HAE12038 HAE14038	Symbol		
	570307-1M	81.0	1.50	B570300	Megane DTI, RN, RT, Laguna 716/730/734/750, Scenic 736 Espace 722 1999/..., Kangoo 2000/... Megane Coupe DTI 731 2000/...	<b>1870cc.</b> F9Q Turbo Inyec. directa 80/100HP Ø80 (SOHC) 8V	<b>570300-R</b>  pág. 486
	570307-2M	81.0	1.40	 HAE14038			
	570307-3M	81.0	1.60				
					<b>DIESEL</b>		

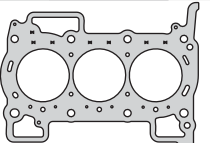
# RENAULT / IKA / DACIA

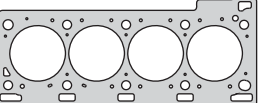
## JUNTA TAPA DE CILINDROS / HEAD GASKETS

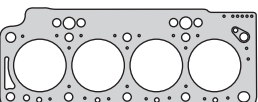
### MOTORES NAFTA Y DIESEL / PETROL AND DIESEL ENGINES

	Código Code	Q	≠	Kit Bulón Bolt Set	Aplicación Application	Motor Engine	Juego
	570507	70.0	1.40	B570500  HAE12038	Twingo 1996/..., Clio 1995/... Kangoo 1997/..., D7D, Twingo 2001/...	<b>1149cc.</b> D7F-D7D 734/730/700/701/710 55/60HP Ø69 (SOHC) 8V	<b>570500-R</b>  pág. 488
	570607	85.0	1.70	B570600  HAE14038	Laguna 700/704 1994/99 Safrane 710/711 1996/99, Space 1996/...	<b>1948cc.</b> N7Q 138/140HP Ø83 (DOHC) 16V	<b>570600-R</b>  pág. 489
	570905 570907 570908	80.5 80.5 80.5	1.40 1.40 1.40	B570900  HAE12038	K4J - Clio II 2001/..., Scenic 1999/..., Megane II 2003/... K4M -Clio, Scenic, Megane, Symbol Laguna 1998/00, Logan 2007/... Fluence, Duster, Logan, Sandero Stepway Kangoo 2015/..., Duster 2016/...	<b>1390cc.</b> K4J 95/98HP Ø79.5 <b>1598cc.</b> K4M 106/110HP Ø79.5 (DOHC) 16V	<b>570900-R</b> <b>570900 MLS</b>  pág. 490
	571007 571008	80.5 80.5	1.20 0.42	B570200  HAE12038	Sandero 2008/..., Logan 2004/...	<b>1390cc.</b> K7J 710/714 75HP Ø79.5 <b>1598cc.</b> K7M 710/718/810/814 90HP Ø79.5 (SOHC) 8V	<b>571000-R</b>  pág. 491
	571107 571108	80.5 80.5	1.20 0.60	B571100	Capture, Kangoo 2016/...	<b>1598cc.</b> H4M 111/120HP Ø78 (DOHC) 16V	<b>571100-R MLS</b>  pág. 492
	571207 571208	73.0 71.3	1.20 0.60	B571200	Kwid 2017	<b>999cc.</b> B4D 66HP Ø70 (DOHC) 12V	<b>571200-R MLS</b>  pág. 493
	571307 571308	80.5 80.5	1.20 1.00	B571300  HAE12038	Logan 2007/13, Sandero 2007/14 Symbol 2009/12, Logan II 2014/19 Sandero II 2015/19	<b>1598cc.</b> K7M - Flex 90HP Ø79.5 (SOHC) 8V	<b>571300-R MLS</b> <b>571300-R</b>  pág. 494
	571407 571408	73.0 71.5	1.20 0.60	B571200	Sandero II y Logan 2017/...	<b>999cc.</b> B4D 409 66HP Ø70 (DOHC) 12V	<b>571400-R MLS</b>  pág. 495
	580007 580008	83.7 84.0	1.20 0.60	B580000  HAE14038	Laguna 1998/..., Laguna, Scenic Megane, Kangoo 2001/... Megane, Scenic, Espace, Grand Espace Laguna, Master, Trafic 1999/... Clio II Sport 2001/..., Duster 2011/...	<b>1783cc.</b> F4P 120HP Ø82.7 <b>1998cc.</b> F4R 1140/169HP Ø82.7 (DOHC) 16V	<b>580000-R</b>  pág. 496
	580107-1M 580107-2M 580107-3M	80.7 80.7 80.7	1.50 1.40 1.60	B570300  HAE14038	Clio II 630/632/662, Kangoo 630/632/662 1998/..., Rodeo Trafic 600/606 1998/... Express 644/648 1997/..., Scenic 1999/..., Megane 1997/... <b>DIESEL</b>	<b>1870cc.</b> F8Q 8V 65HP Ø80 Iny. Indirecta (SOHC)	<b>560701-R</b> (580100)  pág. 497



# RENAULT / IKA / DACIA

## JUNTA TAPA DE CILINDROS / HEAD GASKETS

### MOTORES NAFTA Y DIESEL / PETROL AND DIESEL ENGINES

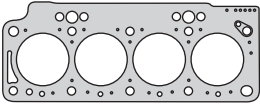
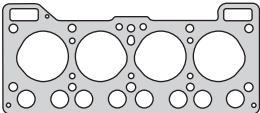
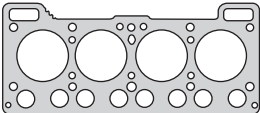
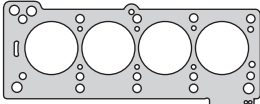
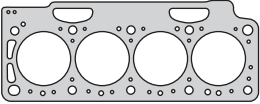
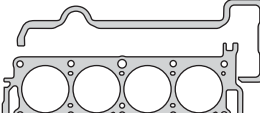
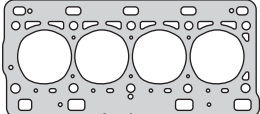
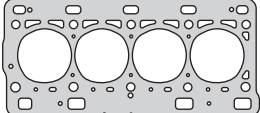
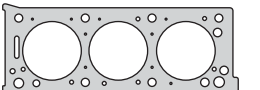
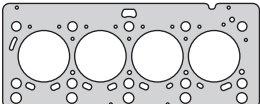
	Código Code	Q	≠	Kit Bulón Bolt Set	Aplicación Application	Motor Engine	Juego
	580107-1M	80.7	1.50	B570300	R19 DT 1991/96, Megane DT 1996/97	<b>1870cc.</b> F8Q 740/741/768/784/786 90/93HP Ø80 (SOHC) 8V	<b>580901-R</b> 🚗 pág. 503
	580107-2M	80.7	1.40	🔩 HAE14038	Scenic DT 19986/...		
	580107-3M	80.7	1.60		<b>DIESEL</b>		
	580207	72.0	1.30	B550400 🔩 HAS17038	Express, Super Cinco 1985/93  R9, R11 1981/89, Super Cinco 1985/93 Clio, Express 1990/93	<b>956cc.</b> C1C 700/706 41HP Ø65 <b>1108cc.</b> C1E 688/752/756 45/49HP Ø70 (OHV) 8V	<b>580200</b> 🚗 pág. 498
	580507	74.0	1.30	B550400 🔩 HAS17038	R12 1969/75, R12TS 1973/75, R12 R15 1976/80, R5 1974/84, Rodeo 1980/81 Estafette 1974/81	<b>1289cc.</b> 810.02/05/09 54/63HP Ø73 (OHV) 8V	<b>580500</b> 🚗 pág. 500
	580607	77.0	1.95	B550400 🔩 HAS17038	Super Cinco, R11, R9 Turbo 1984/93	<b>1289cc.</b> C1J 782/788/760/764 57HP Ø76 (OHV) 8V	<b>580600</b> 🚗 pág. 501
	580707-1M	79.0	1.75	B560600	Express 1987/96, Super Cinco 1988/96 R9, R11 1988/89	<b>1595cc.</b> F8M 720/730/736/760 55HP Ø78 Iny. Indirecta (SOHC) 8V	<b>560601-R</b> (580700) 🚗 pág. 502
	580707-2M	79.0	1.65	B560600-1			
	580707-3M	79.0	1.85	🔩 HAT55055 HAT55100 HAE14038			
	580807	80.5	1.25		Trafic - Fuego - R18 1978/... Fuego 1980/85 R12/R15/R16/R18/R20/R17 1972/...	<b>1647cc.</b> 841.705 - 843.105/110/115/123 79/92HP Ø79	
	581005	70.0	1.30	B581000	Clio 2000/..., Kangoo 2003/...	<b>999cc.</b> D4D 68/70HP Ø69 <b>1149cc.</b> D4D 700/712/720 D4F 702/706/712 75HP Ø69 (DOHC) 16V	<b>581000-R MLS</b> 🚗 pág. 504
	581007	70.0	1.20	🔩 HAE12038	Clio II, Kangoo .../00, Twingo, Clio II, Kangoo 2001/...		
	581007-1.40	70.0	1.40				
	581008	70.0	0.35				
	581005	70.0	1.30	B581000	Clio II 2005/... Twingo 2004/...	<b>1149cc.</b> D4F 708/728 75HP Ø69	<b>581700-R MLS</b> 🚗 pág. 508
	581007	70.0	1.20	🔩 HAE12038			
	581007-1.40	70.0	1.40				
	581008	70.0	0.35				
	581107	95.0	1.60		Laguna, Safrane, Espace 1992/98	<b>2963cc.</b> Z7X 167/170HP V6 Ø93	
	581207-1M	78.0	1.20	B581200	Clio II DCI 2001/... Series 700/702/704/710 Kangoo DCI 2001/... Series 700/702 Megane DCI 2002/... Series 722/728 729/704/710, Symbol	<b>1461cc.</b> K9K DCI 65/80/82HP Ø76 (SOHC) 8V	<b>581201-R</b> 🚗 pág. 505
	581207-2M	78.0	1.00	🔩 HAE16038			
	581207-3M	78.0	1.40				
	581208	77.5	0.65				

# RENAULT / IKA / DACIA

## JUNTA TAPA DE CILINDROS / HEAD GASKETS

### MOTORES NAFTA Y DIESEL / PETROL AND DIESEL ENGINES

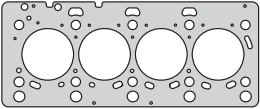
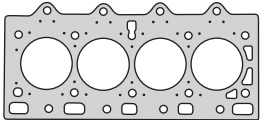
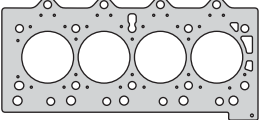
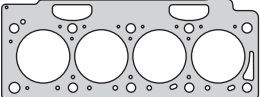
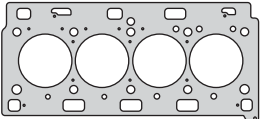
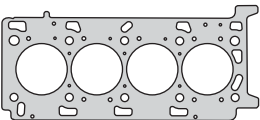
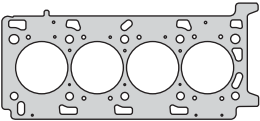
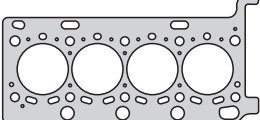
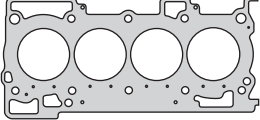
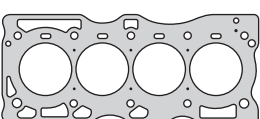
	Código Code	Q	≠	Kit Bulón Bolt Set	Aplicación Application	Motor Engine	Juego
	581307-1M	78.0	1.20	B581200	Megane II, Sandero DCI Serie 794 Sandero Stepway DCI, Symbol DCI Logan 2006/... <b>DIESEL</b>	<b>1461cc.</b> K9K DCI 68/100HP Ø76 (SOHC) 8V	<b>581301-R</b> 🚗 pág. 506
	581307-2M	78.0	1.00	🔩			
	581307-3M	78.0	1.40	HAE16038			
	581308	77.5	0.65				
	581407	88.0	1.80	B581400	Laguna D 706/790 1996/... Laguna TD 752/792/794 1996/... Laguna TD 760/740 1997/... <b>DIESEL</b>	<b>2188cc.</b> G8T D/TD 85/115HP Ø87 (SOHC) 12V	<b>581400-R</b> 🚗 pág. 507
	581507	88.0	1.80		Laguna 1996/98 <b>DIESEL</b>	<b>2188cc.</b> GT8 752/792 12V 85HP Ø87	
	581608	81.0	1.35	B570300	Laguna DCI, Trafic DTI, Kangoo, Master II DTI, Megane Cabriolet DTI Avatime, Espace DTI Volvo S40, V40 TD 2001/... <b>DIESEL</b>	<b>1870cc.</b> F9Q-782/790/820 F9Q-731/732/733 F9Q-722/736/760 F9Q-762 80/110HP Ø80 (SOHC) 8V	
	581807	90.0	1.30	B581800	Master 2001/..., Trafic 2003/... <b>DIESEL</b>	<b>2463cc.</b> G9U-720/724/730/750/754 115HP Ø87 (SOHC) 16V	<b>581800-R MLS</b> 🚗 pág. 509
	581808	90.0	1.20	🔩 HAE18038			
	582307	85.0	1.20	B581800	Espace IV 2006/..., Laguna II .../2005 Megane II 2006/10, Koleos <b>DIESEL</b>	<b>1995cc.</b> M9R 700/740 150HP Ø84 (DOHC) 16V	<b>582300-R MLS</b> 🚗 pág. 512
	582308	85.0	0.80	🔩 HAE18038			
	582407	86.0	1.20	B581800	Master III DCI 2010/... <b>DIESEL</b>	<b>2298cc.</b> M9T 670/676/690/692 125HP M9T 680/698 146HP Ø85	<b>582400-R MLS</b> 🚗 pág. 513
	582408	86.0	1.00	🔩 HAE18038			
	582508	81.0	1.30	B582500	Koleos II 2016/..., Megane III Scenic III 2011/..., Megane IV 2015/... <b>DIESEL</b>	<b>1598cc.</b> RM9 90/95/130HP Ø80 (DOHC) 16V	
	903407	84.5	1.10	B903400	Fluence, Megan III 2001/... <b>DIESEL</b>	<b>1998cc.</b> M4R 714 (DOHC) 16V Ø84	<b>582200-R MLS</b> 🚗 pág. 511
	903408	84.5	0.48	🔩 HAH10055 HAH10100			
	903507	90.0	1.20	B903500	Koleos 4x2/4x4 <b>DIESEL</b>	<b>2488cc.</b> 2TR (DOHC) 16V 170HP Ø89	<b>582100-R MLS</b> 🚗 pág. 510
	903508	89.5	0.65	🔩 HAH10055 HAH10100			

**JEEP IKA**

Motor/Engine

Cm³

HP

Ø

4L - 151

2470

80

84.14

Jeep Ika: Jeep Continental, Bergantin 1954/74

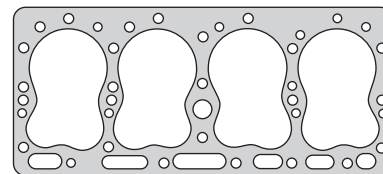

540005

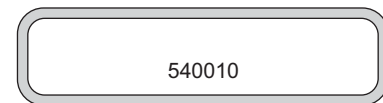

540010

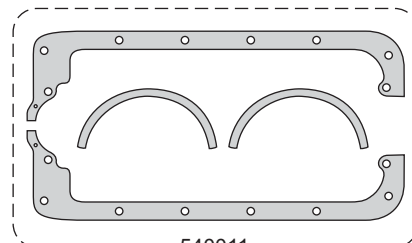

540011

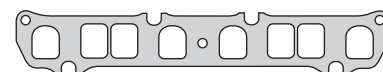

540016

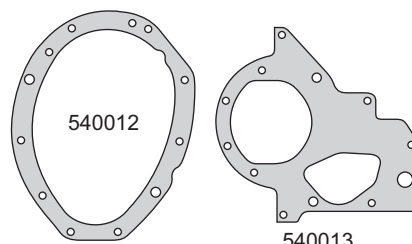

540012

540013

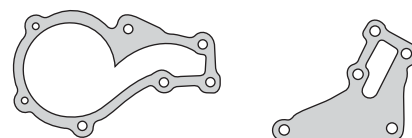

540014

540019

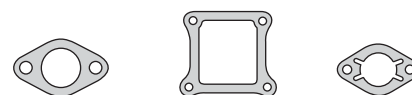

540018

540017

540025



540027

540028

540029



540041



540032



540058



R540012P

Nº OE	Descripción/Description	Mat.	Ref.
2090523	Jgo. de juntas para motor		540000-R
2009064	Junta tapa cilindros Ø 86.5 ± 1.70	NFT	1 540005
2000343	Junta tapa válvulas	CG	1 540010
2016713	Jgo. junta para cárter (4)	CG	1 540011
701290	Tapa distribución	CG	1 540012
711930	Placa distribución	CB	1 540013
733809	Tapa bomba de agua	NB	1 540014
2009065	Múltiple admisión y escape	NFT	1 540016
2000129	Entre múltiples	NFT	1 540017
2009067	Salida de escape	FCH	1 540018
733612	Bomba de agua a block	NB	1 540019
2091527	Jgo. juntas carburador cárter	VS	540020
2000437	Base carburador	NB	1 540025
701392	Tapa bomba aceite	CU	1 540027
2016726	Base bomba nafta	NB	1 540028
	Entre múltiple	NFT	1 540029
731377	Salida agua a termostato	CB	1 540032
2017354	Tapa diferencial - Dana 44	CG	540034
733612	Bomba de agua a block	NB	540039
	Tacitas block	GS	540040
	Vaso bomba nafta	CG	1 540041
2092024	Jgo. juntas caja velocidades simple	VS	540050
	Jgo. juntas caja velocidades doble tracción	VS	540051
2005932	Palier	CB	540056
731046	Jgo. juntas empaquetadura bancada (2)	SNA	1 540058
	Palier	CB	540062
2017354	Tapa diferencial - Dana 44	CGT	540068
2017354	Tapa diferencial - Dana 44	NB	300086
	Retén distribución 52.38 x 81.02 x 11	P	1 R540012P

IKA



Motor/Engine

Cm<sup>3</sup>

HP

Ø

L226

3705

110

84.14

*Ika:* Estanciera, Baqueano, Gladiator  
Continental, Kaiser Carabela  
Manhattan 1955/...  
Bergantin Super 1954/67



Nº OE	Descripción/Description	Mat.	Ref.
2090610	Jgo. de juntas para motor		540100-R
733567	Junta tapa cilindros Ø 87.0 ± 1.70	NFT 1	540105
706158	Junta tapa válvulas	CG 1	540110
2016712	Jgo. junta para cárter (4)	CG 1	540111
701290	Tapa distribución	CG 1	540012
711930	Placa distribución	CB 1	540013
733809	Tapa bomba de agua	NB 1	540014
2009066	Múltiple admisión y escape	NFT 1	540116
735493	Entre múltiples	NFT 1	540117
745608	Salida de escape	FCH 1	540118
733612	Bomba de agua a block	NB 1	540019
2090684	Jgo. juntas carburador CARTER WCD	VS	540120
2093836	Jgo. juntas carburador CARTER RBS	VS	540121
746043	Base carburador	NB 1	540125
701392	Tapa bomba aceite	CU 1	540027
2016726	Base bomba nafta	NB 1	540028
731377	Salida agua a termostato	CB 1	540032
2017354	Tapa diferencial - Dana 44	CG	540034
733612	Bomba de agua a block	NB	540039
	Tacitas block	GS	540040
	Vaso bomba nafta	CG 1	540041
2092024	Jgo. juntas caja velocidades simple	VS	540050
	Jgo. juntas caja velocidades doble tracción	VS	540051
2005932	Palier	CB	540056
731046	Jgo. juntas empaquetadura bancada (2)	SNA 1	540058
	Palier	CB	540062
2017354	Tapa diferencial - Dana 44	CGT	540068
2017354	Tapa diferencial - Dana 44	NB	300086
	Retén distribución 52.38 x 81.02 x 11	P 1	R540012P

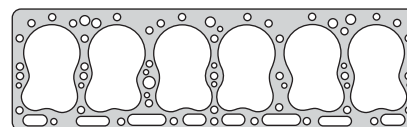

540105



540110

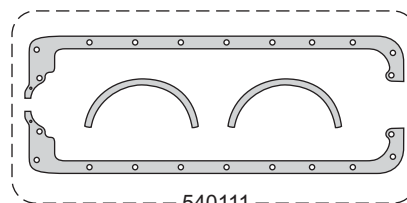

540111



540116

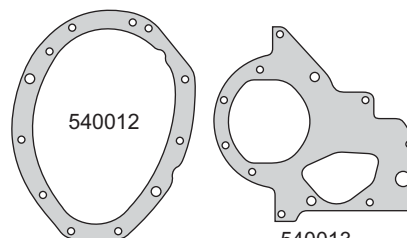

540012

540013

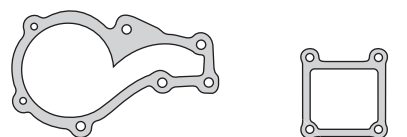

540014

540017

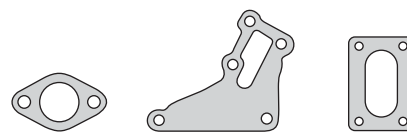

540018

540019

540125

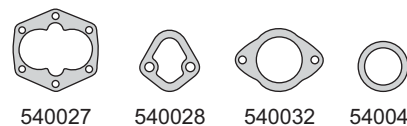

540027

540028

540032

540041



540058



R540012P

IKA



Motor/Engine

Cm³

HP

Ø

OHC 181 4B  
300/300S/380

2966

84.94

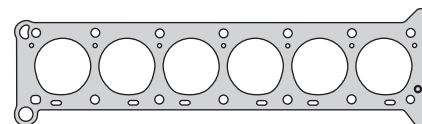
Ika: Torino, Rambler, Utilitario  
Gladiator, Jeep T80 1966/73

540205

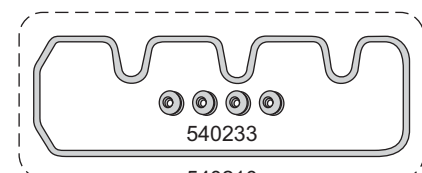

540233

540210

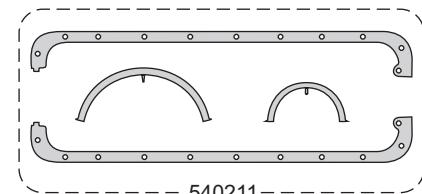

540211



540216



540217

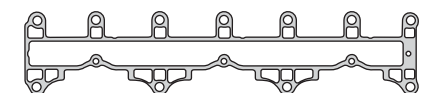

540236

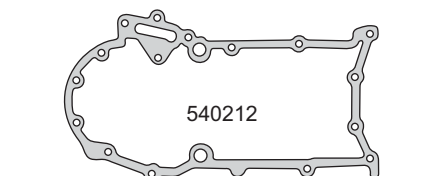

540212



540213

540214

540218

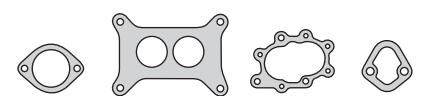

220119

540225

540227

540028

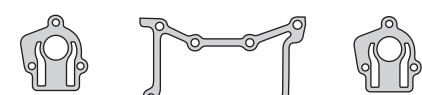

540332

540230

540232



540041

540258

540269



R540012P

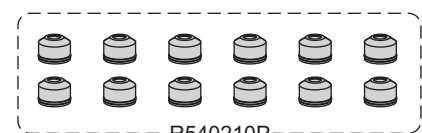

R540210P

Nº OE	Descripción/Description	Mat.	Ref.
2096686	Jgo. de juntas para motor		540200-R
2069497	Junta tapa cilindros Ø 87.5 ± 1.40	NFT	1 540205
2019161	Conj. junta tapa válvulas (5)	GS	1 540210
2093746	Jgo. junta para cárter (4)	CG	1 540211
2069554	Tapa distribución	NB	1 540212
2017031	Tapa inspección distribución	NB	1 540213
2017008	Tapa bomba de agua	NB	1 540214
2069066	Múltiple escape	NFT	1 540216
2068824	Múltiple admisión	NFT	1 540217
2058422	Salida de escape	FCH	1 540218
2068331	Termostato	CB	1 220119
2096476	Jgo. juntas carburador Holley 2B	VS	540220
	Jgo. juntas carburador Holley importado	VS	540221
2096382	Jgo. juntas carburador Weber 45DCDE	VS	540222
2069022	Base carburador	NB	1 540225
2018961	Tapa bomba aceite	CU	1 540227
2016726	Base bomba nafta	NB	1 540028
	Media distribución	NB	540230
	Junta salida termostato	CB	540231
2018235	Base bomba aceite	NB	1 540232
	Base bomba aceite	NB	1 540332
2068764	Arandelas tapa válvulas	GS	4 540233
2017354	Tapa diferencial Dana 44	CG	540034
2017008	Bomba agua	CB	540234
	Base caballete levas	NFT	540236
	Junta vaso bomba nafta	CG	1 540041
2019532	Jgo. juntas empaquetadura bancada (2)	SNA	1 540258
2017354	Tapa diferencial - Dana 44	CGT	540068
2086863	O´ring conducto aceite a distrib. G 12.29 x 3.53	GS	4 540269
2017354	Tapa diferencial - Dana 44	NB	300086
	Kit de retenes completo		R540200
	Jgo. retén válvulas (12)	P	1 R540210P
	Retén distribución 52.38 x 81.02 x 11	P	1 R540012P

# TORINO



Motor/Engine	Cm³	HP	Ø
OHC 181 - 230 300 - 380 7B	3770		84.94

Ika: Torino 1973/...



Nº OE	Descripción/Description	Mat.	Ref.
	<b>Jgo. de juntas para motor</b>		<b>540300-R</b>
<b>2077745</b>	<b>Junta tapa cilindros Ø 87.5 ± 1.40</b>	<b>NFT 1</b>	<b>540305</b>
2214786	Conj. junta tapa válvulas superior (5)	GS 1	540310
2098986	Jgo. junta para cárter (4)	CG 1	540311
2077747	Tapa distribución	NB 1	540312
2017031	Tapa inspección distribución	NB 1	540213
2077537	Bomba de agua	NB 1	540314
2214826	Múltiple escape	NFT 1	540315
2068824	Múltiple admisión	NFT 1	540217
2068331	Junta termostato	CB 1	220119
2215063	Salida de escape	FCH 1	540318
	Jgo. juntas carburador carter c/separador	VS	540320
	Jgo. juntas carburador carter s/separador	VS	540321
2096382	Jgo. juntas carburador Weber 45DCDE	VS	540222
2069022	Base carburador	NB 1	540225
2018961	Tapa bomba aceite	CU 1	540227
2016726	Base bomba nafta	NB 1	540028
2068331	Salida termostato	CB	540231
2018235	Base bomba aceite	NB 1	540232
	Base bomba aceite	NB 1	540332
	Arandelas tapa válvulas	GS 4	540333
2017354	Tapa diferencial - Dana 44	CG	540034
2077537	Bomba de agua	CB	540334
	Separador carburador CARTER ABD		540335
	Vaso bomba nafta	CG 1	540041
2019532	Jgo. juntas empaquetadura bancada (2)	SNA 1	540258
2017354	Tapa diferencial - Dana 44	CGT	540068
2086863	O'ring conducto aceite a distr. G 12.29 x 3.53	GS 2	540269
2017354	Tapa diferencial - Dana 44	NB	300086
	Kit de retenes completo		R540200
	Jgo. retén válvulas (12)	P 1	R540210P
	Retén distribución 52.38 x 81.02 x 11	P 1	R540012P

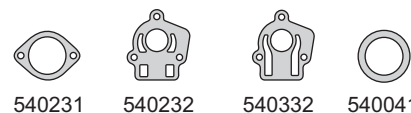
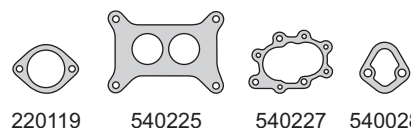
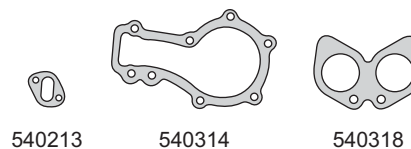
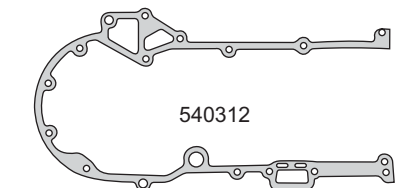
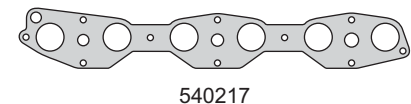
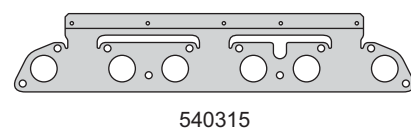
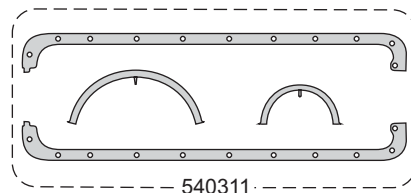
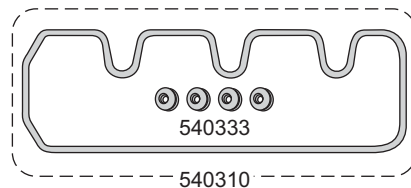
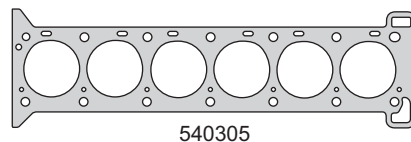

G 12.29 x 3.53

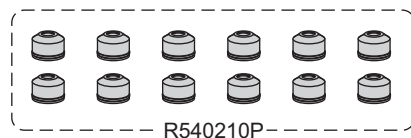

IKA



Motor/Engine

Cm³

HP

Ø

OHC 181/230/300

2966

140/160

84.94

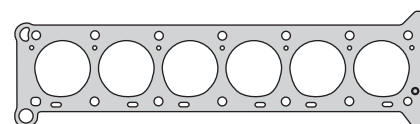
Ika: Rambler, Torino Tornado 300SL  
Gladiator 1966/73

540205

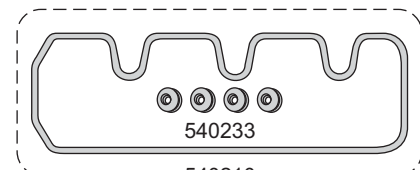

540233

540210

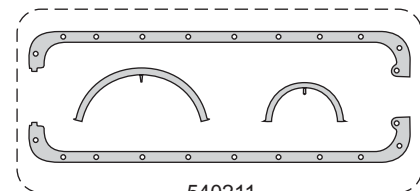

540211



540216

540216

540235

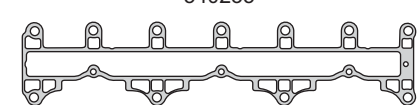

540236

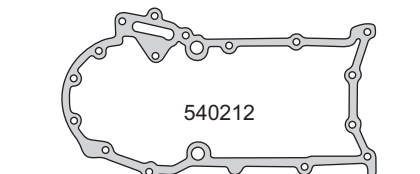

540212

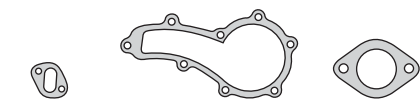

540213

540214

540118



220119

540219

540425

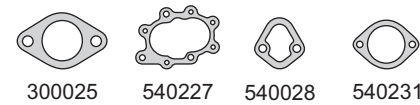

300025

540227

540028

540231



540232

540230

540332



G12.29 x 3.53

540041



540258

R540012P

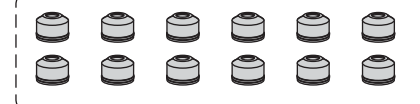

R540210P

Nº OE	Descripción/Description	Mat.	Ref.
	Jgo. de juntas para motor		540400-R
2069497	Junta tapa cilindros Ø 87.5 ±1.40	NFT	1 540205
2019161	Conj. junta tapa válvulas (5)	GS	1 540210
2093746	Jgo. junta para cárter (4)	CG	1 540211
2069554	Tapa distribución	NB	1 540212
2017031	Tapa inspección distribución	NB	1 540213
2017008	Tapa bomba de agua	NB	1 540214
2069066	Múltiple escape	NFT	1 540216
745608	Salida de escape	FCH	1 540118
	Junta termostato	CB	1 220119
648852	Salida agua termostato	CB	2 540219
2093836	Jgo. juntas carburador cárter RBS	VS	540121
	Junta base carburador HOLLEY	NB	300025
2018041	Base carburador		540425
2018961	Tapa bomba aceite	CU	1 540227
2016726	Base bomba nafta	NB	1 540028
	Media distribución	NB	540230
2068331	Salida termostato	CB	540231
2018235	Base bomba aceite	NB	1 540232
2068764	Arandelas tapa válvulas	GS	4 540233
2017354	Tapa diferencial dana 44	CG	540034
	Junta base bomba aceite	NB	1 540332
2077537	Bomba de agua	CB	540334
	Múltiple admisión	NFT	1 540235
	Separador carburador carter ABD		540335
	Base caballete levas	NFT	540236
	Vaso bomba nafta	CG	1 540041
2019532	Jgo. juntas empaquetadura bancada (2)	SNA	1 540258
2017354	Tapa diferencial dana 44	CGT	540068
2086863	O´ring conducto aceite a distribución G 12.29 x 3.53	GS	4 540269
2017354	Tapa diferencial dana 44	NB	300086
	Kit de retenes completo		R540200
	Jgo. retén válvulas (12)	P	1 R540210P
	Retén distribución 52.38 x 81.02 x 11	P	1 R540012P

**IKA**



Motor/Engine	Cm³	HP	Ø
OHC 4B	3770	180	84.94

Ika: Torino Tornado Reforma 1972/74



Nº OE	Descripción/Description	Mat.	Ref.
	<b>Jgo. de juntas para motor</b>		<b>540500-R</b>
<b>2069497</b>	<b>Junta tapa cilindros Ø 87.5 ±1.40</b>	<b>NFT</b>	<b>1 540205</b>
2019161	Conj. junta tapa válvulas (5)	GS	1 540210
2098986	Jgo. junta para cárter (4)	CG	1 540311
2077747	Tapa distribución	NB	1 540312
2017031	Tapa inspección distribución	NB	1 540213
2077537	Bomba de agua	NB	1 540314
2214826	Múltiple escape	NFT	1 540315
2068824	Múltiple admisión	NFT	1 540217
2058422	Salida de escape	FCH	1 540218
	Junta termostato	CB	1 220119
	Junta base carburador	NB	1 540225
2018961	Tapa bomba aceite	CU	1 540227
2016726	Base bomba nafta	NB	1 540028
2068331	Salida termostato	CB	540231
2018235	Base bomba aceite	NB	1 540232
	Base bomba aceite	NB	1 540332
	Arandelas tapa válvulas	GS	4 540233
2017354	Tapa diferencial dana 44	CG	540034
2077537	Bomba de agua	CB	540334
	Vaso bomba nafta	CG	1 540041
2019532	Jgo. juntas empaquetadura bancada (2)	SNA	1 540258
2017354	Tapa diferencial dana 44	CGT	540068
2086863	O ring conducto aceite a distr. G 12.29 x 3.53	GS	2 540269
	Tapa diferencial dana 44	NB	300086
	Kit de retenes completo		R540200
	Jgo. retén válvulas (12)	P	1 R540210P
	Retén distribución 52.38 x 81.02 x 11	P	1 R540012P

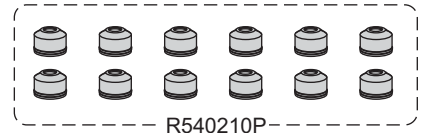
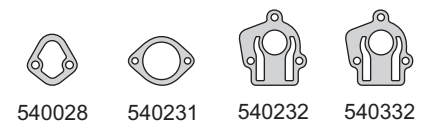
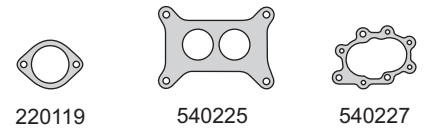
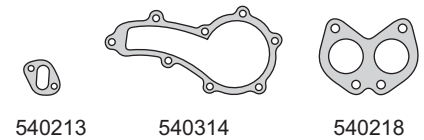
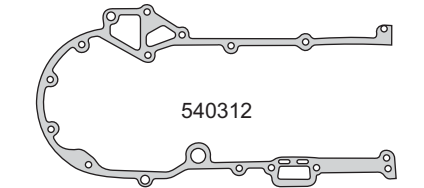
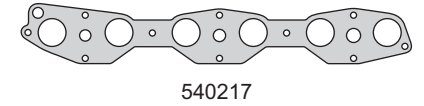
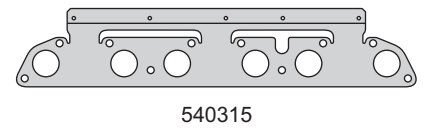
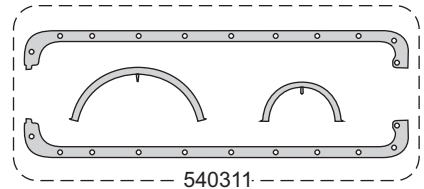
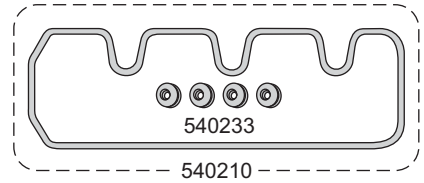
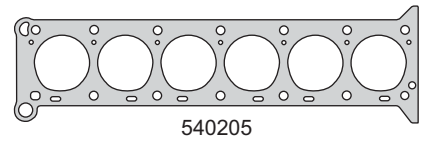



**RENAULT****taranto**

Motor/Engine

Cm³

HP

Ø

670-04/05

845

25

58

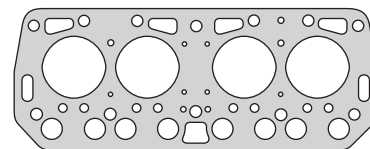
Renault: Gordini, Floride, Dauphine 4L - 4F  
1960/64

550005

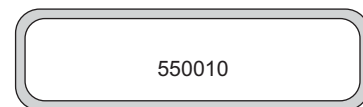

550010

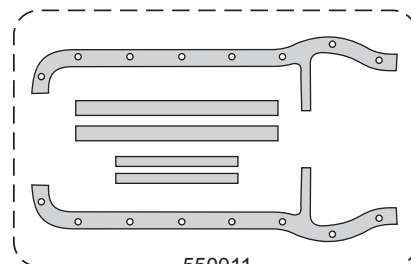

550011

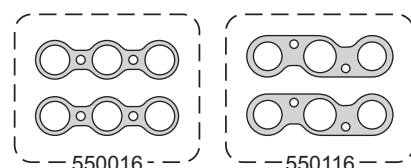

550016

550116

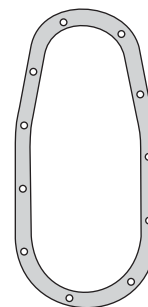

550012

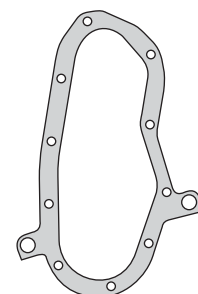

550013



550014

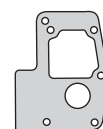

550019



550025



550225



550027



550028



550428



550034



550036



450037



550039



450041



G 4.34 x 3.53



540041



R550012N

Nº OE	Descripción/Description	Mat.	Ref.
9803903	Jgo. de juntas para motor		550000-R
5544952	Junta tapa cilindros Ø 59.0 ± 1.40	NFT 1	550005
5544952	Junta tapa cilindros Ø 59.0 ± 2.40	NFT	550006
5540379	Junta tapa válvulas superior	CG 1	550010
4261399	Jgo. junta para cárter (6)	CG 1	550011
4261155	Tapa distribución	CG 1	550012
4261156	Placa distribución	CB 1	550013
6030957	Tapa bomba de agua	NB 1	550014
6069482	Jgo. múltiple admisión y escape DAUPH (2)	NFT 1	550016
6066788	Jgo. múltiple admisión y escape GORD (2)	NFT 1	550116
6069546	Bomba de agua a block	NB 1	550019
8548582	Jgo. juntas carburador SOLEX 28 IBT	VS	550020
	Jgo. juntas carburador SOLEX 28 IDT	VS	550021
	Jgo. juntas carburador SOLEX 32 PIBT	VS	550122
949938	Jgo. juntas carburador cárter RBS	VS	550222
6061372	Base carburador IBT	NB 1	550025
1032068	Base carburador RBS	NB	550225
6027824	Bomba aceite	NB 1	550027
6028670	Bomba nafta	NB 1	550028
6023496	Bomba nafta a block	NB 1	550428
6051531	Entre múltiples	NFT 1	550034
6038375	Caño bomba agua	NB 1	550036
8540067	Cuerpo bomba nafta	CG	450037
6042349	Cámara agua a tapa cilindros	CB 1	550039
7062434	Boca carga aceite	CG	450041
8513050	Vaso bomba combustible	CG 1	540041
9807295	Jgo. juntas caja velocidades	VS	550050
	Jgo. juntas para cárter	CGT	550060
6051846	Jgo. suplemento camisa cilindros (0.90) VE	CU	550070-0.90
6051845	Jgo. suplemento camisa cilindros (0.95) AM	CU	550070-0.95
6066250	Jgo. suplemento camisa cilindros (1.00) AZ	CU	550070-1.00
7109306	Jgo. suplemento camisa cilindros (1.05) BL	CU	550070-1.05
	Jgo. suplemento camisa cilindros (1.10) RO	CU	550070-1.10
	Jgo. suplemento camisa cilindros (0.10)	CU	550070-0.10
	Jgo. suplemento camisa cilindros (0.20)	CU	550070-0.20
	Jgo. suplemento camisa cilindros (0.30)	CU	550070-0.30
	Jgo. suplemento camisa cilindros (0.50)	CU	550070-0.50
	O'ring G 4.34 x 3.53	GS 8	
	Retén distribución 32 x 50 x 10	N 1	R550012N

**RENAULT**



Motor/Engine Cm³ HP Ø

688.01/10  
810.88  
(OHV) 8V

Renault: R12, R4L, 4S, R6, R4 1970/...  
R12TS, R15 1972/75



Nº OE	Descripción/Description	Mat.	1	2	Ref.
7700509107	Jgo. de juntas para motor				550400-R
7700509107	Jgo. de juntas superior		●	●	550495
7700509107	Jta. tapa cilindros Ø 74.0 ± 1.40	NFT	1	1	550405
7702220551	Jta. tapa cilindros Ø 74.0 ± 2.40	NFT			550406
1018413	Jta. tapa cilindros Ø 74.0 ± 1.40 <b>NR</b>	NFT			550407
1018413	Jgo. tornillos tapa cilindros (HAS17038)				B550400
7702057213	Conj. junta tapa válvulas superior (4)	N	1	1	550410
7700513014	Jgo. junta para cárter (4)	CG		1	550411
7702020652	Tapa distribución	NB			550312
7702057848	Tapa distribución	CG		1	550412
7702057848	Tapa bomba de agua R 6	NB	1	1	550314
	Tapa bomba de agua	NB	1	1	550414
7700513015	Múltiple admisión y escape	FCH		1	550415
7702020651	Múltiple admisión y escape	NFT	1		550416
	Salida de escape	FCH	1	1	550418
7701003167	Bomba de agua a block R 6	NB	1	1	550319
770202836	Placa bomba de agua	NB	1	1	550419
7701008701	Jgo. juntas carburador SOLEX 28 IBS	VS			550220
7701013761	Jgo. juntas carburador SOLEX F 32 PDIS 3	VS			550320
0855253900	Jgo. juntas carburador WEBER 30 ICF	VS			550221
7700524853	Jgo. juntas carburador SOLEX 32 EISA 3	VS			550421
7702023149	Jgo. juntas carburador WEBER 32 DIR 21	VS			550521
0857726400	Base carburador	NB	1	1	550325
7702023292	Base carburador	NB	1	1	550425
7703061078	Base carburador 2B	NB		1	550525
7704000287	Toma y tapa bomba aceite	NB		1	550427
0857714400	Base bomba nafta	NB		2	550428
7700513014	Arandela tapa válvulas A 7 x 17 x 1.5 F	NB	3	3	550430
7702020652	Tapa cámara agua trasera	NB	1	1	550331
0607155200	Tapa cámara agua trasera	NB	1	1	550332
0555497400	Tapa bomba de agua R 6				550334
7702053261	Tapa bomba de agua R 12				550434
6071557	Bomba aceite a block	NB		1	550435
	Junta tapa válvulas superior	CG			550436
	Tapa bomba nafta	NB			550437
	Base distribuidor	NB		1	550338
7700513015	Bomba de agua a block				550339
7702020651	Placa bomba de agua	CB			550439
	Tapa llenado de aceite	CG	1	1	450041
	Jgo. juntas caja velocidades	CB			550350
1018413	Jgo. junta para cárter	CGT			550460
	Jgo. suplemento camisa cilindros (0.08) AZ (4)	CU			550470-0.08
	Jgo. suplemento camisa cilindros (0.10) RO (4)	CU		1	550470-0.10
	Jgo. suplemento camisa cilindros (0.12) VE (4)	CU			550470-0.12
1018413	Junta para cárter	ACO			550482
	Arandela tapón carter A 16 x 22 x 1A	AL			
	Kit de retenes completo				R550400
	Jgo. retén válvulas (8)	P		1	R550410P
	Retén bancada 70 x 90 x 10	P		1	R550411P
	Retén bancada 80 x 100 x 13	P			R550811P
	Retén distribución 35 x 50 x 9	P		1	R550412P
	Retén árbol levas 30 x 42 x 8	P		1	R550413P

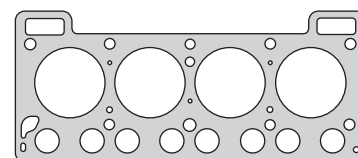

550405

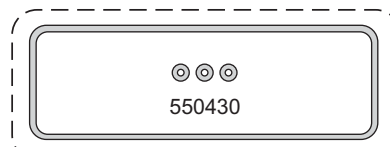

550430

550410

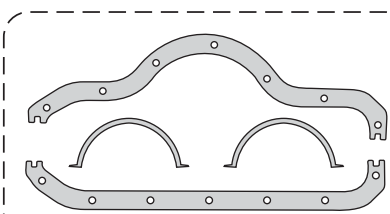

550411

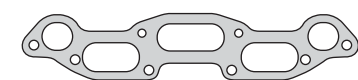

550415/550416

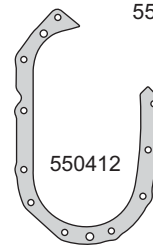

550412

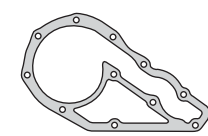

550414

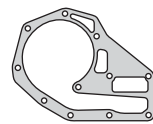

550314



550418

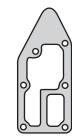

550319

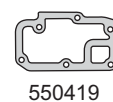

550419



550325



550427



550425

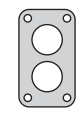

550525



550428



550331



550332



500435



550338



450041



550470-0.10



R550411P



R550811P



R550412P



R550413P

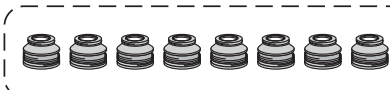

R550410P

**RENAULT**



Motor/Engine	Cm³	HP	Ø
847 (OHV) 8V	1397	63/68	76

Renault: R12TS, R5TX 1976/80

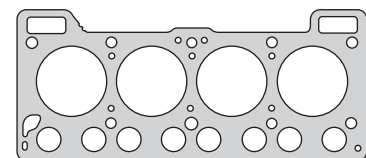

550505

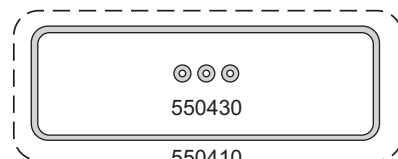

550430

550410

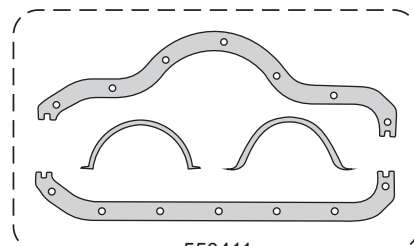

550411



550415/550416

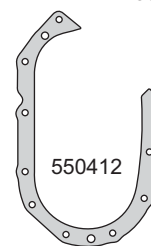

550412

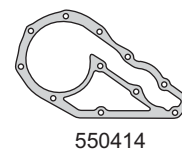

550414

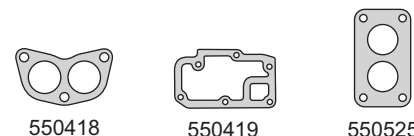

550418

550419

550525



550427

550529

550331



550338

550428

550435

450041

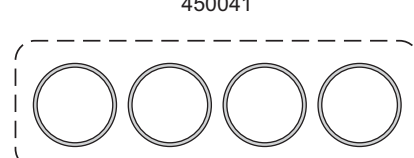

550570-0.10



R550411P



R550412P



R550413P



R550910V

Nº OE	Descripción/Description	Mat.	847	847	Ref.	
	Jgo. de juntas para motor				550500-R	
	Jgo. de juntas superior		●	●	550595	
7702023675	Jta. tapa cilindros Ø 77.0 ±1.40		NFT	1	1	550505
7702023675	Jta. tapa cilindros Ø 77.0 ±2.40		NFT			550506
7702023675	Jta. tapa cilindros Ø 77.0 ±1.20 NR <sup>2</sup>		NFT			550507
	Jgo. tornillos tapa cilindros (HAS17038)				B550400	
7702220551	Conj. junta tapa válvulas superior (4)		N	1	1	550410
1018413	Jgo. junta para cárter		CG		1	550411
7702057213	Tapa distribución		NH			550312
7702057213	Tapa distribución		CG		1	550412
7702020652	Tapa bomba de agua		NB	1	1	550414
7702057848	Múltiple admisión y escape		FCH		1	550415
7702057848	Múltiple admisión y escape		NFT	1		550416
7702024218	Salida de escape		FCH	1	1	550418
7702020651	Placa bomba de agua		NB	1	1	550419
	Jgo. juntas carburador CARTER C-5-2055-5		VS			550420
	Jgo. juntas carburador SOLEX 34 IES		VS			550520
7701013761	Jgo. juntas carburador WEBER 32 DIR 21		VS			550521
	Jgo. juntas carburador WEBER 34 ICH		VS			550422
	Jgo. juntas carburador SOLEX 34/7 EIES		VS			550522
7702023149	Base carburador 2B		NB	1	1	550525
0857726400	Toma y tapa bomba aceite		NB		1	550427
7702023292	Base bomba nafta		NB		2	550428
7702057985	Base carburador CARTER		NB		1	550529
7703071078	Arandela tapa válvulas A 7 x 17 x 1.5 F		NB	3	3	550430
7704000287	Tapa cámara agua trasera		NB	1	1	550331
7702020652	Tapa bomba de agua					550434
0607155200	Bomba aceite a block		NB		1	550435
0555497400	Junta tapa válvulas		CG			550436
7702053261	Tapa bomba nafta		NB			550437
6071557	Base distribuidor		NB		1	550338
7702020651	Placa bomba de agua		CB			550439
	Bomba pique		NB			550540
	Llenado aceite		CG	1	1	450041
	Jgo. juntas caja velocidades		CB			550350
	Jgo. juntas caja velocidades 5ta.		CB			550450
1018413	Jgo. junta para cárter		CGT			550460
7702023663	Jgo. suplemento camisa cilindros (0.08) AZ		CU			550570-0.08
7702023664	Jgo. suplemento camisa cilindros (0.10) RO (4)		CU		1	550570-0.10
7702023665	Jgo. suplemento camisa cilindros (0.12) VE		CU			550570-0.12
1018413	Junta para cárter		ACO			550482
	Arandela tapón cárter A 16 x 22 x 1A		AL			
	Kit de retenes completo					R550500
	Jgo. retén válvulas (8)		T			R550910T
	Jgo retén válvulas (8)		V	1		R550910V
	Retén bancada 70 x 90 x 10		P	1		R550411P
	Retén distribución 35 x 50 x 9		P	1		R550412P
	Retén árbol levas 30 x 42 x 8		P	1		R550413P

**RENAULT****taranto**

Motor/Engine	Cm <sup>3</sup>	HP	Ø
J5R	1995	80/102	88
829-J5R/6R/7R	1995	102/120	88
851-J7T (SOHC) 8V	2165	95/120	88

**Jeep:** Wrangler 1983/86  
**Renault:** Master 1981/93, R18, Fuego 1981/86  
 Trafic, R21/25 83/94, Espace 1984/97  
 R20 1977/84, Trafic 1989/...



Nº OE	Descripción/Description	Mat.	1	1	Ref.
	Jgo. de juntas para motor				550600-R
	Jgo. de juntas superior		●	●	550695
7700720788	Jta. tapa cilindros Ø 89.0 ± 1.40		NFT	1	550605
7700720788	Jta. tapa cilindros Ø 89.0 ± 2.40		NFT		550606
7700720788	Jta. tapa cilindros Ø 89.0 ± 1.20 <b>NR</b>		NFT		550607
	Jgo. tornillos tapa cilindros (HAS19038)				B550600
	Jgo. tornillos tapa cilindros (HAS19038)				B550600-1
7700614729	Conj. juntas tapa válvulas (4)		GS	1	550610
7702057744	Junta para cárter		CG	1	550611
7700655572	Eje intermedio distribución		NB	1	550613
	Bomba de agua		NB	1	550614
7700622286	Múltiple escape		NFT	1	550616
7700622284	Jgo. múltiple admisión (4)		NB	1	550617
7700679861	Salida de escape		FCH	1	550618
7700623392	Bomba de agua a block		NB	1	550619
7702073137	Jgo. juntas carburador WEBER 32/36 DARA		VS		550620
	Jgo. juntas carburador WEBER 32/32 DARA		VS		550621
	Jgo. juntas carburador SOLEX 34 TEIE		VS		550622
	Jgo. juntas carb. HOLLEY RX 7040A TRAFFIE		VS		550623
0608201900	Base carburador		NB	1	550625
	Base bomba aceite		NB	1	550627
7700622283	Base bomba nafta		NB	2	550628
0313.030	Arandela tapón cárter B18 x 24 x 2.3 CN		CN		450029
	Jgo. admisión inyección (4)		NB	1	550629
7703061078	Arandela tapa válvulas A 8 x 18 x 1.5		NB	3	550630
7702073139	Filtro aire		CG	1	550631
7704000276	Cámara agua tapa cilindros		NB	1	550632
7700629742	Anillo o'ring base distribución G 39 x 3		GS	1	550633
7700623393	Cuerpo bomba agua		NB	1	550634
	O'ring tapón block mando b/ac. 47.3 x 2		GS		550638
	Termostato		NB	1	550639
	Llenado de aceite		CG	1	450041
	Anillo termostato		GS	1	550641
	Jgo. juntas caja velocidades		VS		550650
	Jgo. cierre bancada (4)		GS	1	550658
7700591167	Junta para cárter		CGT		550660
	Jgo. suplemento camisa cilindros (4)		GS	1	550670
7700618961	Junta para cárter		ACO		550682
	Arandela tapón cárter A 18 x 24 x 1.5 A		AL	1	
	Kit de retenes completo				R550600
	Jgo. retén válvulas (8)		P	1	R550610P
	Retén bancada 90 x 110 x 13		P	1	R550611P
	Retén distribución 50 x 68 x 10		P	1	R550612P
	Retén árbol levas 35 x 47 x 7		P	1	R550613P
	Retén auxiliar 30 x 40 x 7		P	1	R550615P

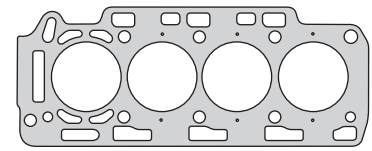

550605

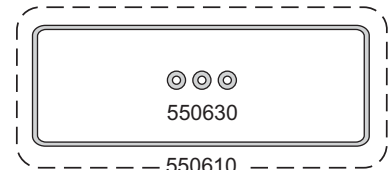

550630

550610

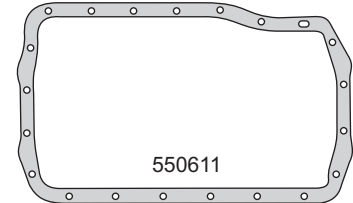

550611

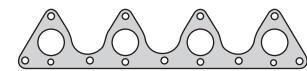

550616

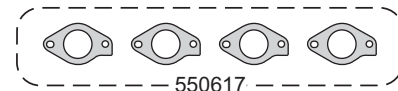

550617



550629



550614



550619



550634

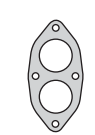

550618



550613



550625



550627



550628

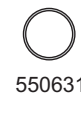

550631



550632



550633



550639



450041



550658



550641



550670

A 18 x 24 x 1.5 A



R550611P



R550612P



R550613P



R550615P

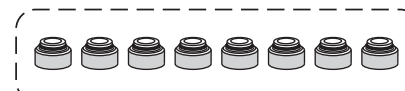

R550610P

**RENAULT**



Motor/Engine	Cm³	HP	Ø
C1J/C2J	1397	60/67	76
C1J/C2J Turbo (OHV) 8V	1397	104/110	76

Renault: R9 1981/89, R11 1983/89, R19, R21 1988/93, Super Cinco 1985/93

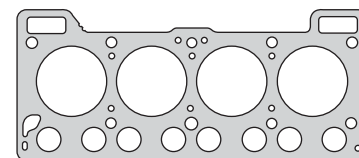

550705

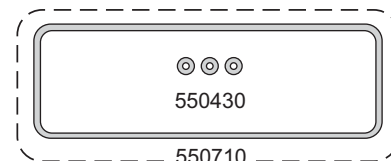

550430

550710

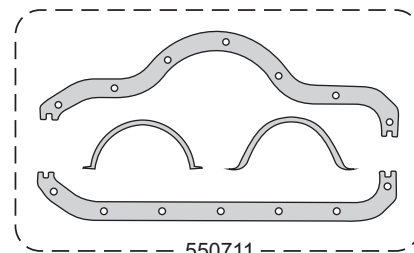

550711

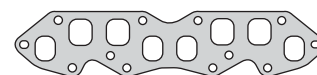

550715

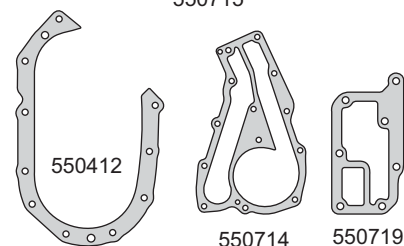

550412

550714

550719

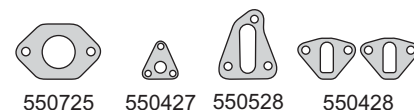

550725

550427

550528

550428



550331

550435

550738

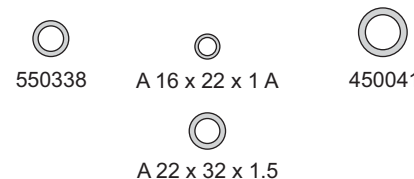

550338

A 16 x 22 x 1 A

450041

A 22 x 32 x 1.5



550671

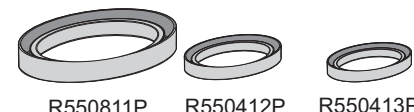

R550811P

R550412P

R550413P

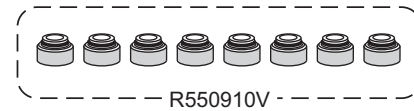

R550910V



R550910T

Nº OE	Descripción/Description	Mat.	1	2	Ref.
	Jgo. de juntas para motor				550700-R
	Jgo. de juntas superior		●		550795
7702080611	Jta. tapa cilindros Ø 77.0 ±1.40	NFT	1	1	550705
7702080611	Jta. tapa cilindros Ø 77.0 ±1.20 NR	NFT			550707
	Jgo. tornillos tapa cilindros (HAS17038)				B550400
7702220779	Conj. junta tapa válvulas (4)	N	1	1	550710
7702070195	Jgo. junta para cárter (4)	CG		1	550711
7702070195	Jgo. junta para cárter	NB			550811
7702057213	Tapa distribución	NB			550312
7702057213	Tapa distribución	CG		1	550412
7701349269	Bomba de agua	NB	1	1	550714
	Múltiple admisión y escape	FCH		1	550715
7700697874	Múltiple admisión y escape	NFT	1		550716
	Múltiple admisión y escape	NFT			550816
7702080617	Placa bomba de agua	NB	1	1	550719
	Jgo. juntas carburador WEBER 32 DTR 2	VS			550720
7701201752	Jgo. juntas carburador SOLEX 32 B	VS			550721
	Base carburador 1B	NB	1	1	550725
0857726400	Toma y tapa aceite	NB		1	550427
7702023292	Bomba nafta	NB		2	550428
	Bomba nafta	NB		1	550528
	Bomba nafta block				550728
	Bulbo temperatura A 22 x 32 x 1.5 F	NB		1	550929
7703061078	Arandela tapa válvulas A 7 x 17 x 1.5 F	NB	3	3	550430
7704000287	Tapa cámara agua trasera	NB	1	1	550331
0607155200	Cuerpo bomba aceite	NB		1	550435
7702053261	Tapa bomba nafta	NB			550437
6071557	Base distribuidor	NB		1	550338
	Base carburador 2B	NB	1	1	550738
	Llenado aceite	CG	1	1	450041
	Jgo. juntas caja velocidades	GS			550750
7702070195	Jgo. junta para cárter	CGT			550760
7701348178	Jgo. suplemento camisa cilindros (4)	GS		1	550671
7702070195	Junta para cárter	ACO			550782
	Arandela tapón cárter A 16 x 22 x 1A	AL			
	Kit de retenes completo				R550700
	Jgo. retén válvulas (8)	T			R550910T
	Jgo. retén válvulas (8)	V		1	R550910V
	Retén bancada 80 x 100 x 13	P		1	R550811P
	Retén distribución 35 x 50 x 9	P		1	R550412P
	Retén árbol levas 30 x 42 x 8	P		1	R550413P

**RENAULT**



Motor/Engine	Cm³	HP	Ø
847 (OHV) 8V	1397	48	76

Renault: R12, R18, Junior, Trafic 1982/...



Nº OE	Descripción/Description	Mat.	Ref.
	Jgo. de juntas para motor		550800-R
	Jgo. de juntas superior		550895
7702080611	Jta. tapa cilindros Ø 77.0 ± 1.40	NFT 1 1	550505
	Jta. tapa cilindros Ø 77.0 ± 2.40	NFT	550506
7702080611	Jta. tapa cilindros Ø 77.0 ± 1.20 <b>NR</b>	NFT	550507
	Jgo. tornillos tapa cilindros (HAS17038)		B550400
0555497400	Conj. junta tapa válvulas superior (4)	GS 1 1	550410
7702070195	Jgo. junta para cárter (4)	CG 1	550711
7702070195	Jgo. junta para cárter	NH	550811
7702057213	Tapa distribución	NH	550312
7702057213	Tapa distribución	CG 1	550412
	Tapa bomba de agua	NB 1 1	550314
7702020652	Tapa bomba de agua	NB 1 1	550414
7702057848	Múltiple admisión y escape	FCH 1	550415
7702057848	Múltiple admisión y escape	NFT 1	550416
7702024218	Salida de escape	FCH 1	550418
7702057996	Salida de escape 18 Junior	FCH 1 1	550818
7702020651	Placa bomba de agua	NB 1 1	550419
	Jgo. juntas carburador CARTER C5-2055-5	VS	550420
	Jgo. juntas carburador WEBER 30 ICF	VS	550820
7701013761	Jgo. juntas carburador WEBER 32 DIR 21	VS	550521
	carburador Solex Argelite	VS	550821
	Jgo. juntas carburador WEBER 34 ICH	VS	550422
	Jgo. juntas carburador SOLEX 34/7 EIES	VS	550522
7702023149	Base carburador 2B	NB 1 1	550525
	Base carburador WEBER TRAFIC	NB	550825
0857726400	Toma y tapa bomba ace	NB 1	550427
7702023292	Base bomba nafta	NB 2	550428
7702057895	Bomba nafta	NB 1	550528
	Base bomba nafta a block		550728
7702057985	Base carburador cárter	NB 1 1	550529
	Bulbo temperatura A 22 x 32 x 1.5 F	NB 1	550929
7703061078	Arandela tapa válvulas A 7 x 17 x 1.5 F	NB 3 3	550430
7704000287	Tapa cámara agua trasera	NB 1 1	550331
0857714400	Tapa cámara agua trasera	NB 1 1	550332
0607155200	Cuerpo bomba aceite	NB 1	550435
	Arandela tapón cárter A 16 x 22 x 1 C	CU	550835
	Tubo llenado	CG 1	450041
	Jgo. juntas caja velocidades	CB	550350
	Jgo. juntas caja velocidades 5ta.	CB	550450
	Jgo. juntas caja velocidades	VS	550650
7702070195	Jgo. junta para cárter	CGT	550760
7701348178	Jgo. suplemento camisas cilindros (4)	GS 1	550671
7702070195	Junta para cárter	ACO	550782
	Kit de retenes completo		R550700
	Jgo. retén válvulas (8)	T	R550910T
	Jgo. retén válvulas (8)	V 1	R550910V
	Retén bancada 80 x 100 x 13	P 1	R550811P
	Retén distribución 35 x 50 x 9	P 1	R550412P
	Retén árbol levas 30 x 42 x 8	P 1	R550413P

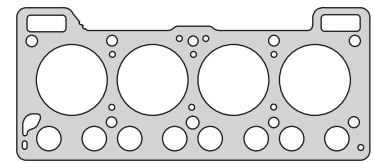

550505

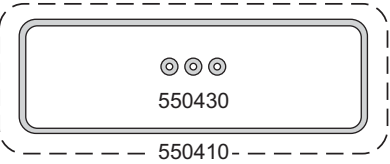

550430

550410-

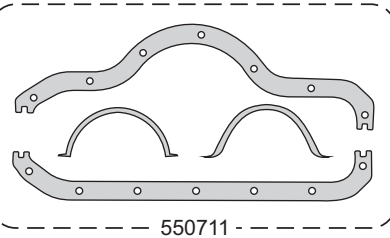

550711 -

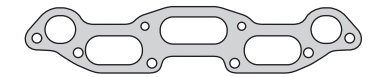

550415/550416

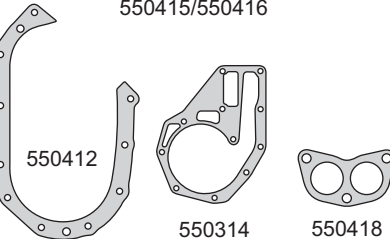

550412

550314

550418

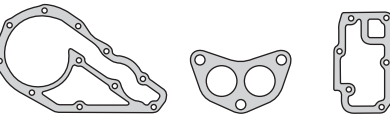

550414

550818

550419

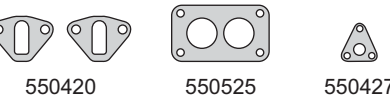

550420

550525

550427

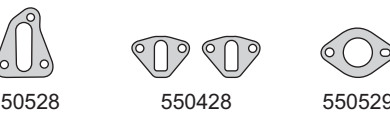

550528

550428

550529

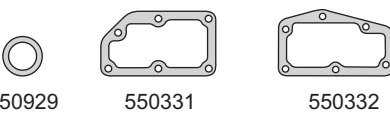

550929

550331

550332



550835

550435

450041

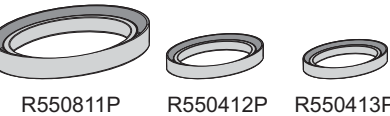

R550811P

R550412P

R550413P

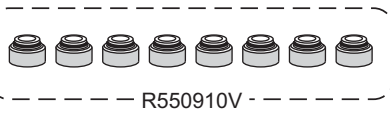

R550910V

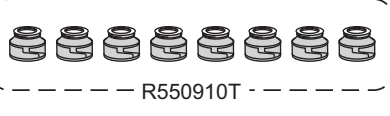

R550910T

**RENAULT**



Motor/Engine Cm³ HP Ø

Renault: R9, R11, R12, R18, R19 1988/...

**C1L - C2L**  
Carburador 1565 77



Nº OE	Descripción/Description	Mat.			Ref.
	Jgo. de juntas para motor				<b>550900-R</b>
	Jgo. de juntas superior		●		<b>550995</b>
	Jgo. de juntas superior				<b>550997</b>
	Jta. tapa cilindros Ø 78.0 ±1.40	NFT	1	1	<b>550905</b>
	Jta. tapa cilindros Ø 78.0 ±2.40	NFT			<b>550906</b>
	Jta. tapa cilindros Ø 78.0 ±1.20 <b>NR</b>	NFT			<b>550907</b>
	Jgo. tornillos tapa cilindros  (HAS17038)				<b>B550400</b>
7702220551	Conj. junta tapa válvulas (4)	GS	1	1	550710
7702206018	Jgo. junta para cárter (4)	CG		1	550911
7702057213	Tapa distribución	CG		1	550412
7701349269	Bomba de agua	NB	1	1	550714
770205848	Múltiple admisión y escape	FCH		1	550415
	Múltiple escape	FCH		1	550815
7702057848	Múltiple admisión y escape	NFT	1		550416
	Múltiple escape	NFT	1		550816
7702057929	Salida de escape	FCH	1	1	550818
7702080617	Placa bomba de agua	NB	1	1	550719
	Jgo. juntas carburador WEBER 32 DTR	VS			550920
	Jgo. carburador SOLEX 32 bis	VS			550921
0608201900	Base carburador	NB	2	2	550625
	Base carburador SOLEX BAS	NB			550725
	Base carburador WEBER				550925
7702057895	Base bomba nafta	NB		2	550528
	Bulbo temperatura A 22 x 32 x 1.5 F	NB		1	550929
7703061078	Arandela tapa válvulas A 7 x 17 x 1.5 F	NB	3	3	550430
	Tapón cárter A 16 x 22 x 1 C	CU		1	550930
7704000287	Tapa cámara agua trasera	NB	1	1	550331
0857714400	Tapa cámara agua	NB	1	1	550332
	Base bomba aceite	NB		1	550935
770079807	Unión caño escape	AC			550940
7702020130	Tapa carga aceite	CG	1	1	450041
7702206018	Jgo. junta para cárter	CGT			550960
7701348178	Jgo. suplemento camisa cilindros (4)	GS		1	550671
7702206018	Junta para cárter	ACO			550982
	Kit de retenes completo				R550900
	Jgo. retén válvulas (8)	T			R550910T
	Jgo. retén válvulas (8)	V		1	R550910V
	Retén bancada 80 x 100 x 13	P		1	R550811P
	Retén distribución 35 x 50 x 9	P		1	R550412P
	Retén árbol levas 30 x 42 x 8	P			R550413P

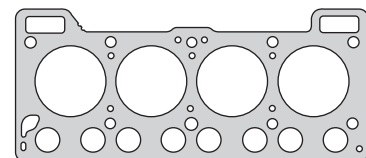

550905

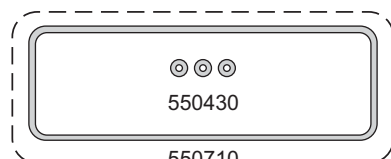

550430

550710

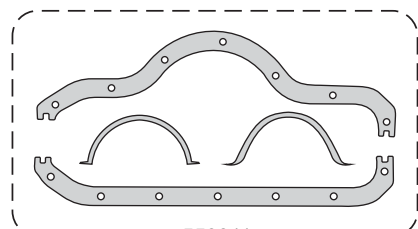

550911



550415/550416



550815/550816

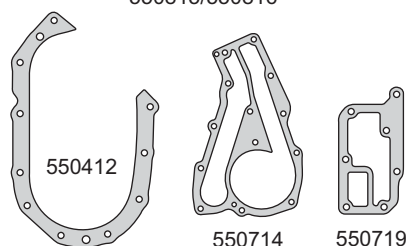

550412

550714

550719

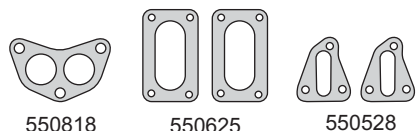

550818

550625

550528



550925

550929

550930

450041

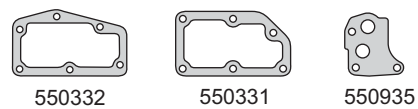

550332

550331

550935



550671

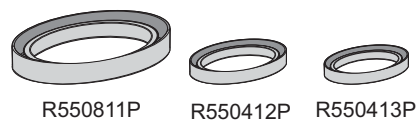

R550811P

R550412P

R550413P

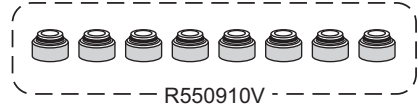

R550910V



R550910T

**RENAULT**



Motor/Engine	Cm³	HP	Ø
852/J8S 121 (SOHC) 8V	2068	65/86	86
	2068	80	86

**Jeep:** Jeep Wagoneer TD 1984/95  
Comanche TD 1986/88  
**Renault:** R18 1981/86, R21 1984/97  
Trafic 1981/97, Master 1981/97

DIESEL



Nº OE	Descripción/Description	Mat.	Ref.
	Jgo. de juntas para motor		560001-R
	Jgo. de juntas superior	●	560095-1M
	Jgo. de juntas superior		560095-2M
	Jgo. de juntas superior		560095-3M
7700711666	Junta tapa cilindros Ø 87.0 ± 1.70	NFT 1	560007-1M
7701035217	Junta tapa cilindros Ø 87.0 ± 1.60	NFT	560007-2M
7701035218	Junta tapa cilindros Ø 87.0 ± 1.80	NFT	560007-3M
	Jgo. tornillo (HAH10055/HAS19038/HAE18038)		B560000
7700662455	Junta tapa válvulas	NFT 1 1	560010
7702057744	Junta para cárter	CG 1	550611
7700655572	Eje intermedio distribución	NB 1	550613
7700735848	Bomba de agua	NB 1	560014
7700663686	Múltiple admisión y escape	NFT 1	560015
7700663686	Múltiple admisión y escape	NFT 1	560016
7702057929	Salida de escape	FCH 1 1	550618
7700684487	Base termostato	NB 1 1	560019
	Base bomba aceite	NB 1	550627
7700622283	Bomba combustible	NB 2	550628
	Arandela bulbos temperatura B 16 x 22 x 2.4 CN	CN	450029
7700733513	Termostato	NB 1 1	560029
7700735847	Salida bomba de agua	NB 1	560030
7700629742	O´ring sellador G 39 x 3	GS 1	550633
7703062013	Arandela tapón cárter A 18 x 23 x 1 C	CU 1	560034
7700663363	Arandela inyector A 14.5 x 21 x 2 C	CU 4 4	560035
	Arandela parallamas	AC 4 4	560036
7703065067	O´ring placa distribución G 45 x 2.5	GS 1	560037
7703065091	O´ring bomba aceite G 47.35 x 1.78	GS 1	560038
7703065090	O´ring termostato G 63.09 x 3.53	GS 1 1	560039
7700684487	Codo salida agua	NB 1 1	560041
	Jgo. juntas caja velocidades	VS	560050
7701030255	Jgo. cierre bancadas (4)	GS 1	550658
7702057744	Junta para cárter	CGT	550660
7700666025	Jgo. suplemento camisa cilindros inferior (4)	GS 1	560070
7700850660	Jgo. suplemento camisa cilindro (4)	GS 1	550670
	O´ring G 13.94 x 2.62	GS 1	
	Arandela A 16 x 22 x 1.5 A	AL 4	
	Kit de retenes completo		R550600
	Jgo. retén válvulas (8)	P 1	R550610P
	Retén bancada 90 x 110 x 13	P 1	R550611P
	Retén distribución 50 x 68 x 10	P 1	R550612P
	Retén árbol levas 35 x 47 x 7	P 1	R550613P
	Retén auxiliar 30 x 40 x 7	P 1	R550615P

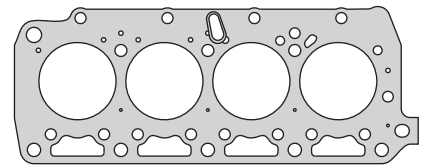

560007

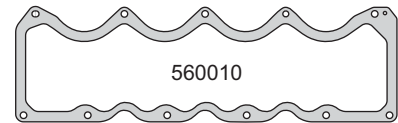

560010

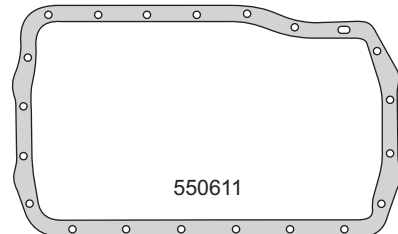

550611

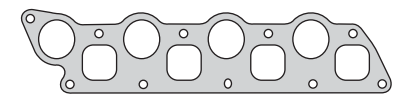

560015/560016



550613

560014

560618

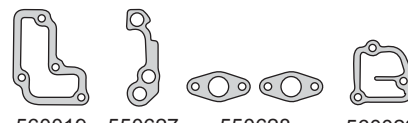

560019

550627

550628

560029



560030

G 63.09 x 3.53

560041

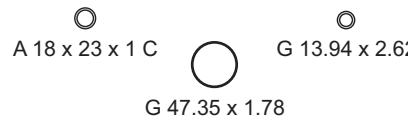

A 18 x 23 x 1 C

G 13.94 x 2.62

G 47.35 x 1.78

A 14.5 x 21 x 2 C

A 16 x 22 x 1.5 A

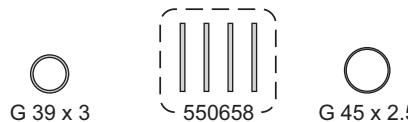

G 39 x 3

550658

G 45 x 2.5



560670



R550611P



R550612P



R550613P



R550615P

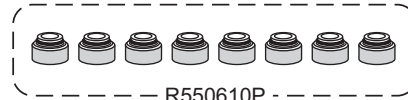

R550610P



**RENAULT**



Motor/Engine	Cm³	HP	Ø
F2N - F3N (SOHC) 8V	1721	75/92	81

Renault: R19 1989/95, R11 1986/89  
Clio 1990/93, R21, Trafic, Super Cinco 1986/94

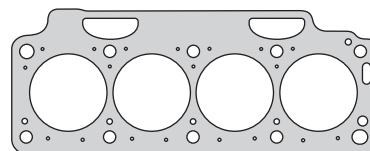

560107

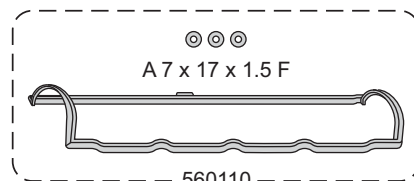

560110

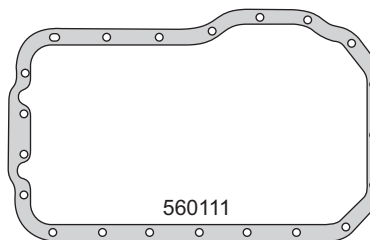

560111

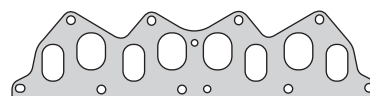

560115

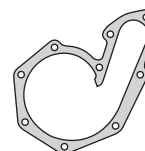

560114



560119



560131



550628



G 31.5 x 3.2



A 18 x 24 x 1.5 A



A 16 x 22 x 1.5 A



A 14 x 20 x 2 C



G 65 x 73 x 5



G 65 x 68 x 3.6



A 12 x 17 x 1 C



A 10 x 15 x 1.5 A



A 22 x 28 x 2 A

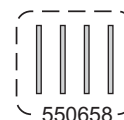

550658



R560111V



R550612P



R560113V



R560114P



R550615P



R560110V

Nº OE	Descripción/Description	Mat.	Ref.
	Jgo. de juntas para motor		560100-R
	Jgo. de juntas superior		560195
7700713860	Jta. tapa cilindros Ø 81.7 ± 1.20	NFT	1 1 560107
	Jgo. tornillos tapa cilin. (HAT55055/55100)		B560600
	Jgo. tornillos tapa cilin. (HAE14038)		B560600-1
7700743903	Conj. junta tapa válvulas (4)	N	1 1 560110
7700859751	Junta para cárter	NFT	1 560111
7700851213	Tapa bomba de agua	CB	1 560114
7700854867	Múltiple admisión y escape	FCH	1 1 560115
7700852434	Inferior árbol de levas	NB	1 1 560119
770062283	Bomba nafta	NB	2 550628
	Arandela tapa bujía B 18 x 24 x 2.3 CN	CN	450029
7700736647	O'ring G 31.5 x 3.2	GS	1 560129
	Arandela tapa bujía B 16 x 22 x 2.4 CN	CN	450229
7703061078	Arandela tapa válvulas A 7 x 17 x 1.5 F	NB	3 3 550430
7700718380	Anillo termostato	GS	1 1 560131
	Guarnición sintético G 65 x 68 x 3.6	GS	1 560132
	Guarnición sintético G 65 x 73 x 5	GS	1 560133
	Arandelas especial B 22 x 28 x 3 CN	CN	560134
	Arandelas especial B 10 x 15 x 2.4 CN	CN	560135
	Arandela especial A 14 x 20 x 2 C	CU	2 560136
	Arandela A 12 x 17 x 1 C	CU	1 560137
7701030255	Jgo. cierre bancada (4)	GS	1 550658
	Arandela A 10 x 15 x 1.5 A	AL	1
	Arandela A 16 x 22 x 1.5 A	AL	1
	Arandela A 18 x 24 x 1.5 A	AL	2
	Arandela A 22 x 28 x 2 A	AL	1
	Kit de retenes completo		R560100
	Jgo. retén válvulas (8)	V	1 R560110V
	Retén bancada 85 x 105 x 8	V	1 R560111V
	Retén distribución 50 x 68 x 10	P	1 R550612P
	Retén árbol levas 25 x 42 x 7	V	1 R560113V
	Retén auxiliar 22 x 45 x 7	P	1 R560114P
	Retén auxiliar 30 x 40 x 7	P	1 R550615P

**DACIA**



Motor/Engine	Cm³	HP	Ø
TXL (SOHC) 8V	1397	60	76

Dacia: TXL 1310/1410



Nº OE	Descripción/Description	Mat.	Ref.
	<b>Jgo. de juntas para motor</b>		<b>560200-R</b>
	Junta tapa cilindros Ø 77.0 $\pm$ 1.40	NFT 1	550505
	Junta tapa cilindros Ø 77.0 $\pm$ 2.40	NFT	550506
	Junta tapa cilindros Ø 77.0 $\pm$ 1.20 <b>NR</b>	NFT	550507
	<b>Jgo. tornillos tapa cilindros (HAS17038)</b>		<b>B550400</b>
	Conj. junta tapa válvulas (4)	N 1	550410
	Jgo. junta para cárter (4)	CG 1	560211
	Tapa distribuidor	NB 1	550312
	Jta. múltiple admisión y escape	FCH 1	550415
	Tapa bomba de agua	NB 1	560214
	Salida de escape	FCH 1	550418
	Placa bomba de agua	NB 1	560219
	Carburador - Brasov-32 irm	NB	560220
	Base carburador	NB 2	560225
	Toma y tapa bomba aceite	NB 1	550427
	Base bomba nafta	NB 2	550428
	Arandela tapa válvulas A 7 x 17 x 1.5 F	NB 3	550430
	Cámara agua	NB 1	550331
	Arandela tapón cárter A 18 x 23 x 1 C	CU 1	560235
	Base bomba aceite	NB 1	550435
	Llenado aceite	CG 1	450041
	Caja velocidades	VS	560250
	Jgo. suplemento camisa cilindros (4)	S 1	550671
	Kit de retenes completo		R550900
	Jgo. retén válvulas (8)	V 1	R550910V
	Retén bancada 80 x 100 x 13	P 1	R550811P
	Retén distribución 35 x 50 x 9	P 1	R550412P

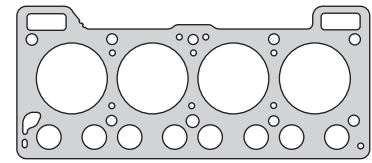

550505

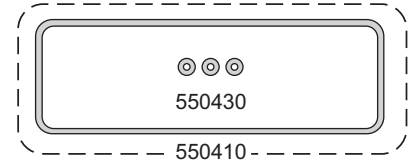

550430

550410

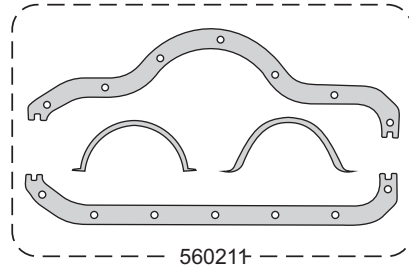

560211

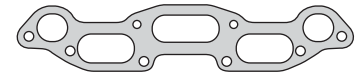

550415

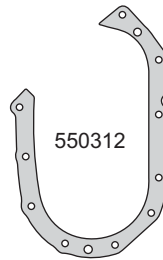

550312



560214



550418

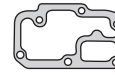

560219



550427

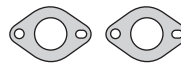

560225



550428



550435

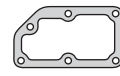

550331



450041



A 18 x 23 x 1 C



550671

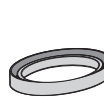

R550412P



R550811P



R550910V

**RENAULT**



Motor/Engine Cm³ HP Ø

839.01  
800.10  
(OHV) 8V

845

39

58

Renault: R5 1973/84



Nº OE	Descripción/Description	Mat.	Ref.
	Jgo. de juntas para motor		<b>560300-R</b>
	Junta tapa cilindros Ø 59.0 ± 1.40	NFT 1	<b>560305</b>
	Junta tapa cilindros Ø 59.0 ± 1.40	NFT	<b>560307</b>
	Junta tapa válvulas	CG 1	550010
	Jgo. junta para cárter (6)	CG 1	550011
	Tapa distribución	CB 1	560312
	Placa distribución	CB 1	560313
	Tapa bomba de agua	NB 1	560314
	Jgo. múltiple admisión y escape (2)	NFT 1	550016
	Placa bomba de agua	CB 1	560319
	Base carburador	NB 1	550025
	Bomba de aceite	NB 1	550027
	Bomba de nafta	NB 1	550028
	Base bomba nafta	NB 1	550428
	Entre múltiple	NFT 1	550034
	Caño agua	NB 1	550036
	Cámara de agua tapa cilindros	CB 1	550039
	Vaso nafta	CG 1	540041
	Jgo. suplemento camisa cilindros (0.90) (4)	CU	550070-0.90
6051846	Jgo. suplemento camisa cilindros (0.95) (4)	CU	550070-0.95
6051845	Jgo. suplemento camisa cilindros (1.00) (4)	CU	550070-1.00
6066250	Jgo. suplemento camisa cilindros (1.05) (4)	CU	550070-1.05
7109306	Jgo. suplemento camisa cilindros (1.10) (4)	CU	550070-1.10
	Jgo. suplemento camisa cilindros (0.10) (4)	CU	550070-0.10
	Jgo. suplemento camisa cilindros (0.20) (4)	CU 1	550070-0.20
	Jgo. suplemento camisa cilindros (0.30) (4)	CU	550070-0.30
	Jgo. suplemento camisa cilindros (0.50) (4)	CU	550070-0.50
	O´ring G 4.34 x 3.53	GS 8	
	Retén distribución 32 x 50 x 10	N 1	R550012N

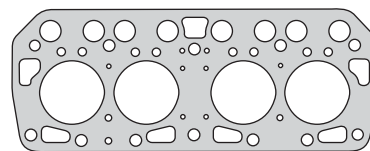

560305

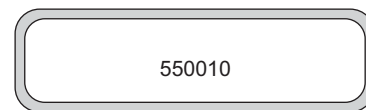

550010

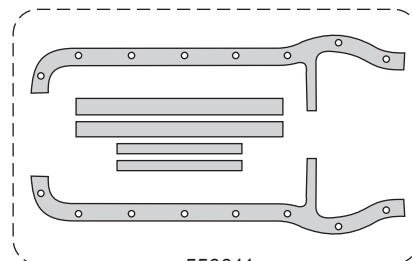

550011



550016

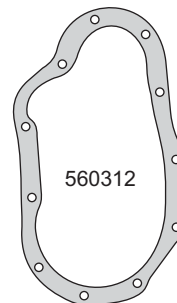

560312

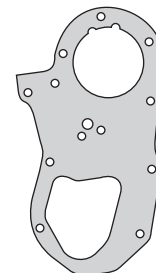

560313

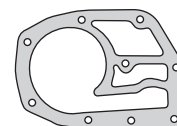

560314

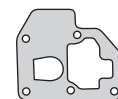

560319



550025



550027



550428



550028



550034



550036



550039



540041



G 4.34 x 3.53

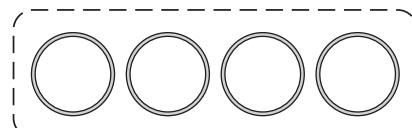

550070-0.20



R550012N

**RENAULT**



Motor/Engine	Cm³	HP	Ø
F3P Inyección (SOHC) 8V	1794	90/96	82.7

Renault: R19, Clio, Laguna 1991/98

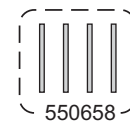
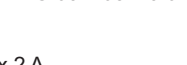
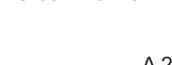
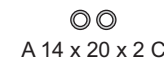
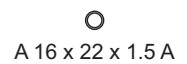
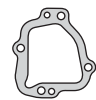
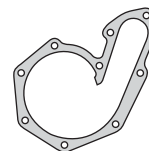
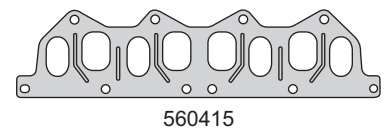
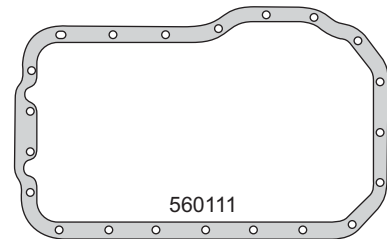
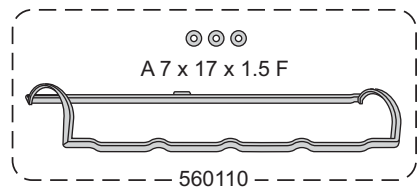
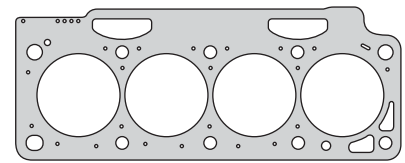

Nº OE	Descripción/Description	Mat.	1	2	Ref.
	Jgo. de juntas para motor				560400-R
	Jgo. de juntas superior				560495
7700859273	Jta. tapa cilindros Ø 83.5 ± 1.40 NR <sup>2</sup>	NFT	1	1	560407
	Jgo. tornillos tapa cilin. (HAT55055/55100)				B560600
	Jgo. tornillos tapa cilin. (HAE14038)				B560600-1
7700743903	Conj. junta tapa válvulas (4)	N	1	1	560110
7700859751	Junta para cárter	NFT	1	1	560111
7700854539	Múltiple admisión y escape	FCH	1	1	560415
07700851213	Tapa bomba de agua	CB	1	1	560114
7700852434	Árbol de levas	NB	1	1	560119
7700622283	Bomba nafta	NB		2	550628
	Arandela tapa bujía B 18 x 24 x 2.3 CN	CN			450029
770073667	O'ring G 31.5 x 3.2	GS		1	560129
	Arandela tapa bujía B 16 x 22 x 2.4 CN	CN			450229
	Arandela tapa válvulas A 7 x 17 x 1.5 F	NB	3	3	550430
7700718380	Anillo termostato	GS	1	1	560131
	Guarnición sintético G 65 x 68 x 3.6	GS		1	560132
	Guarnición sintético G 65 x 73 x 5	GS		1	560133
	Arandela especial B 22 x 28 x 3 CN	CN			560134
	Arandela especial B 10 x 15 x 2.4 CN	CN			560135
	Arandela especial A 14 x 20 x 2 C	CN		2	560136
	Arandela especial A 12 x 17 x 1 C	CU		1	560137
	Jgo. cierre bancada (4)	GS		1	550658
	Arandela A 10 x 15 x 1.5 A	AL		1	
	Arandela A 16 x 22 x 1.5 A	AL		1	
	Arandela A 18 x 24 x 1.5 A	AL		2	
	Arandela A 22 x 28 x 2 A	AL		4	
	Kit de retenes completo				R560400
	Jgo. retén válvulas (8)	V		1	R560110V
	Retén bancada 85 x 105 x 8	V		1	R560111V
	Retén distribución 50 x 68 x 10	P		1	R550612P
	Retén árbol levas 25 x 42 x 7	V		1	R560113V
	Retén auxiliar 22 x 45 x 7	P		1	R560114P

**RENAULT****taranto**

Motor/Engine

Cm³

HP

Ø

C3L Inyección

1597

74

76

Renault: R19, Clio, Express 1996/98

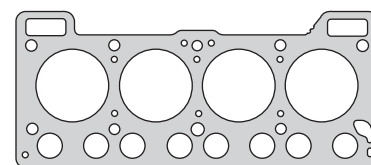

550905

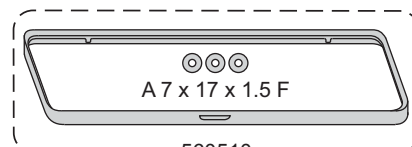

560510

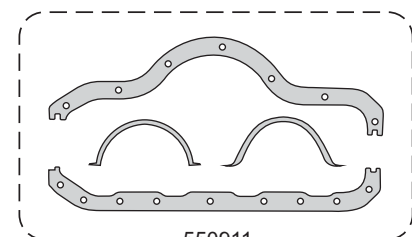

550911



550815

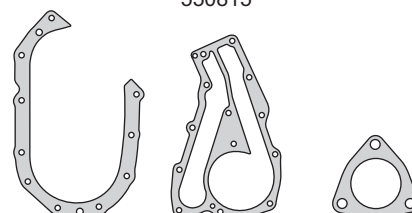

550412

550714

560517

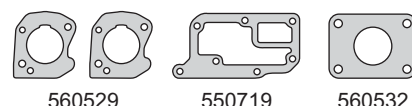

560529

550719

560532

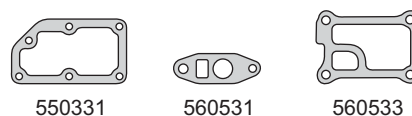

550331

560531

560533

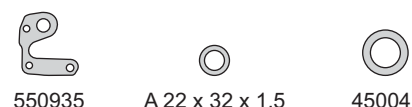

550935

A 22 x 32 x 1.5

450041

A 16 x 22 x 1C



550671

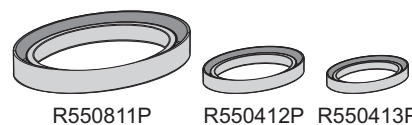

R550811P

R550412P

R550413P



R550910T



R550910V

Nº OE	Descripción/Description	Mat.	Ref.
7702217284	Jgo. de juntas para motor		560500-R
	Jgo. de juntas superior		560595
7702220799	Jta. tapa cilindros Ø 78.0 ±1.40	NFT 1 1	550905
	Jta. tapa cilindros Ø 78.0 ±2.40	NFT	550906
7702220799	Jta. tapa cilindros Ø 78.0 ±1.20 NR	NFT	550907
	Jgo. tornillos tapa cilindros (HAS17038)		B550400
7701036311	Conj. junta tapa válvulas (4)	P 1 1	560510
77012206018	Jgo. junta para cárter (4)	CG 1	550911
7702057213	Tapa distribución	CB 1	550412
770208065	Cuerpo y tapa bomba de agua	NB 1 1	550714
7702220795	Múltiple admisión y escape	FCH 1	550815
	Múltiple admisión y escape	NFT 1	550816
7700854668	Entre múltiple tubo primario	FCH 1 1	560517
7702080617	Bomba de agua a tapa cilindros	NB 1 1	550719
7702220616	Caja mariposa aislante	NB 2	560529
	Arandela bulbo temp. A 22 x 32 x 1.5	NB 1	550929
7702057732	Arandela tapa válvula A 7 x 17 x 1.5 F	NB 3 3	550430
	Arandela tapón cárter A 16 x 22 x 1C	CU 1	550930
	Junta placa bomba de aceite	NB 1 1	550331
7700854391	Sobre múltiple	NFT 1 1	560531
7700855273	Entre brida y múltiple	NB 1 1	560532
7700272725	Entre múltiple	NFT 1	560533
	Base bomba aceite	NB 1	550935
	Llenado de aceite	CG 1 1	450041
7701348178	Jgo. suplemento camisa cilindros (4)	GS 1	550671
	Kit de retenes completo		R550700
	Jgo. retén válvulas (8)	V 1	R550910V
	Jgo. retén válvulas (8)	T	R550910T
	Retén bancada 80 x 100 x 13	P 1	R550811P
	Retén distribución 35 x 50 x 9	P 1	R550412P
	Retén árbol levas 30 x 42 x 8	P 1	R550413P

**RENAULT****taranto**

Motor/Engine

Cm<sup>3</sup>

HP

Ø

**F8Q**  
(SOHC) 8V**1870****65****80****Renault:** R9, Express, Clio, Kangoo, Trafic  
Scenic, Megane

DIESEL



Nº OE	Descripción/Description	Mat.			Ref.
	Jgo. de juntas para motor				560601-R
	Jgo. de juntas superior		●		560695-1M
	Jgo. de juntas superior				560695-2M
	Jgo. de juntas superior				560695-3M
	Jgo. juntas superior sin JTC				560696
7701039398	Jta. tapa cilindros Ø 81.0 $\pm$ 1.60	NFT			560607-2M
7700867870	Jta. tapa cilindros Ø 81.0 $\pm$ 1.70	NFT	1		560607-1M
7701039399	Jta. tapa cilindros Ø 81.0 $\pm$ 1.80	NFT			560607-3M
	Jgo. tornillos tapa cilin. (HAT55055/55100)				B560600
	Jgo. tornillos tapa cilin. (HAE14038)				B560600-1
7700743903	Conj. junta tapa válvulas (4)	N	1	1	560110
7700859751	Junta cárter para cárter de chapa	NFT		1	560111
7700851213	Tapa bomba de agua	CB		1	560114
8200105746	Junta frente motor porta reten distribución	NB		1	560612
7700854867	Múltiple admisión y escape	NFT	1	1	560115
7700852434	Inferior árbol de levas	NB	1	1	560119
7701040923	Guarnición termostato	N		1	570319
770062283	Bomba alimentación	NH			550628
7703062014	Arandela tapa bujía B 18 x 24 x 2.3 CN	CN			450029
7700736647	O'ring G 31.5 x 3.2	GS		1	560129
7703062050	Arandela tapa bujía B 16 x 22 x 2.4 CN	CN			450229
7703061078	Arandela tapa válvulas A 7 x 17 x 1.5 F	NB	3	3	550430
7700718380	Anillo termostato	GS	1	1	560131
	Guarnición sintético G 65 x 68 x 3.6	GS		1	560132
	Guarnición sintético G 65 x 73 x 5	GS		1	560133
	Arandela especial B 22 x 28 x 3 CN	CN			560134
7703062013	Arandela especial B 10 x 15 x 2.4 CN	CN			560135
	Arandela para llamas	AC	4	4	560036
	Arandela A 14.5 x 21 x 2 C	CU	4	4	560136
	Arandela A 12 x 17 x 1 C	CU			560137
7700859220	Bomba vacío	NB	1	1	560638
7700851849	Bomba vacío	NB	1	1	560639
7701030255	Jgo. cierre bancada (4)	GS		1	550658
7700724836	O'ring bomba vacío G 74 x 3	GS		1	
	Arandela A 10 x 15 x 1.5 A	AL		1	
	Arandela A 16 x 22 x 1.5 A	AL		1	
	Arandela A 18 x 24 x 1.5 A	AL		2	
	Arandela A 22 x 28 x 2 A	AL		1	
	Kit de retenes completo				R560600
	Jgo. retén válvulas (8)	V		1	R560110V
	Retén bancada 85 x 105 x 8	V		1	R560111V
	Retén distribución 50 x 68 x 10	V		1	R550612V
	Retén árbol levas 25 x 42 x 7	V		1	R560113V
	Retén auxiliar 22 x 45 x 7	V			R560114V

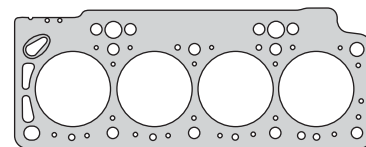

560607

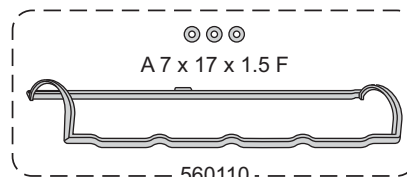

A7 x 17 x 1.5 F

560110

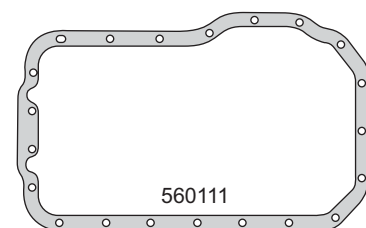

560111

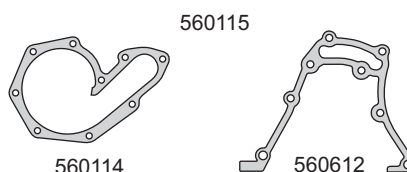
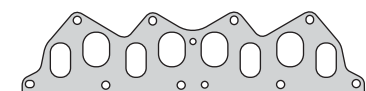

560115



560114

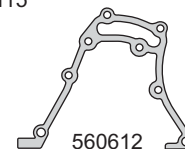

560612



560119



570319



550628



560638



560131



560639



G 74 x 3



A 14.5 x 21 x 2 C

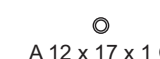

A 12 x 17 x 1 C



A 22 x 28 x 2 A



G 31.5 x 3.2

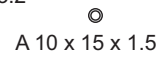

A 10 x 15 x 1.5 A



A 18 x 24 x 1.5 A



A 16 x 22 x 1.5 A



550658

G 65 x 68 x 3.6

G 65 x 73 x 5



R560111V



R550612V



R560113V



R560114V

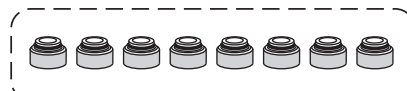

R560110V

**RENAULT**



Motor/Engine	Cm³	HP	Ø
F8Q (SOHC) 8V con cárter de aluminio	1870	65	80

Renault: R19, Express, Clio, Kangoo  
Trafic, Scenic, Megane

DIESEL



Nº OE	Descripción/Description	Mat.	Ref.
	Jgo. de juntas para motor		560701-R
	Jgo. de juntas superior		560695-1M
	Jgo. de juntas superior		560695-2M
	Jgo. de juntas superior		560695-3M
7701039398	Junta tapa cilindros Ø 81.0 ± 1.70	NFT 1	560607-1M
7700867870	Junta tapa cilindros Ø 81.0 ± 1.60	NFT	560607-2M
7701039399	Junta tapa cilindros Ø 81.0 ± 1.80	NFT	560607-3M
	Jgo. tornillos tapa cilin. (HAT55055/55100)		B560600
	Jgo. tornillos tapa cilin. (HAE14038)		B560600-1
7700743903	Conj. junta tapa válvulas (4)	N 1 1	560110
7700108057	Junta cárter para cárter de aluminio	N 1	560611
8200105746	Junta frente motor porta retén distribución	NB 1	560612
7700851213	Tapa bomba de agua	CB 1	560114
7700854867	Múltiple admisión y escape	FCH 1 1	560115
7700852434	Inferior árbol de levas	NB 1 1	560119
7701040923	Guarnición termostato	N 1	570319
770062283	Bomba alimentación	NB	550628
	Arandela tapa bujía B 18 x 24 x 2.3 CN	CN	450029
7700736647	O'ring G 31.5 x 3.2	GS 1	560129
	Arandela tapa bujía B 16 x 22 x 2.4 CN	CN	450229
7703061078	Arandela tapa válvulas A 7 x 17 x 1.5 F	NB 3 3	550430
7700718380	Anillo termostato	GS 1 1	560131
	Guarnición sintético G 65 x 68 x 3.6	GS 1	560132
	Guarnición sintético G 65 x 73 x 5	GS 1	560133
	Arandela especial B 22 x 28 x 3 CN	CN	560134
	Arandela especial B 10 x 15 x 2.4 CN	CN	560135
	Arandela para llamas	AC 4 4	560036
	Arandela A 14.5 x 21 x 2 C	CU 4 4	560136
7700859220	Arandela A 12 x 17 x 1 C	CU	560137
7700851849	Bomba vacío	NB 1 1	560638
7700724836	Bomba vacío	NB 1 1	560639
	Bomba depresora	GS 1	570345
	Guarnición bomba depresora	GS 1	570346
	Jgo. cierre bancada (4)	GS 1	550658
7701030255	O'ring bomba vacío G 74 x 3	GS 1	
	Arandela A 10 x 15 x 1.5 A	AL 1	
	Arandela A 16 x 22 x 1.5 A	AL 1	
	Arandela A 18 x 24 x 1.5 A	AL 2	
	Arandela A 22 x 28 x 2 A	AL 1	
	Kit de retenes completo		R560700
	Jgo. retén válvulas (8)	V 1	R560110V
	Retén bancada 85 x 105 x 8	V 1	R560111V
	Retén distribución 42 x 54 x 6	V 1	R570412V
	Retén árbol levas 25 x 42 x 7	V 1	R560113V
	Retén auxiliar 22 x 45 x 7	P	R560114P

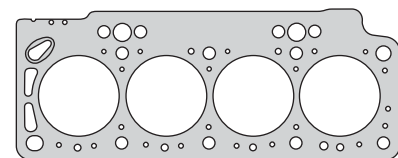

560607

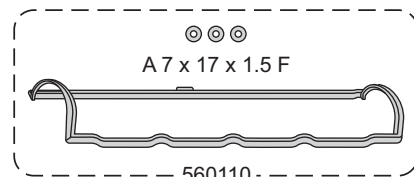

A 7 x 17 x 1.5 F

560110

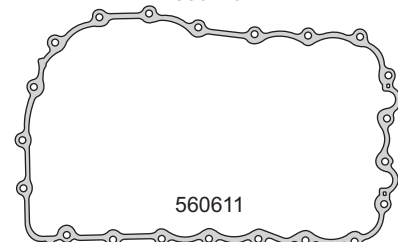

560611

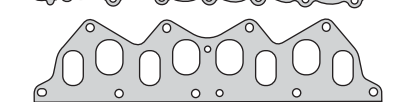

560115

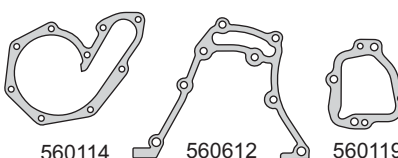

560114

560612

560119



570319

550628

570345

570346

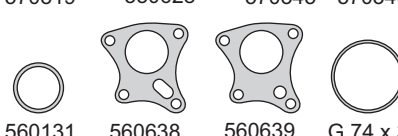

560131

560638

560639

G 74 x 3

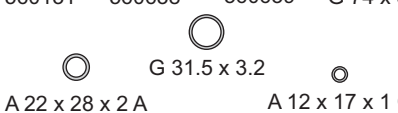

G 31.5 x 3.2

A 22 x 28 x 2 A

A 12 x 17 x 1 C

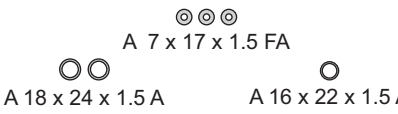

A 7 x 17 x 1.5 FA

A 18 x 24 x 1.5 A

A 16 x 22 x 1.5 A



560036

A 14.5 x 21 x 2 C

A 10 x 15 x 1.5 A

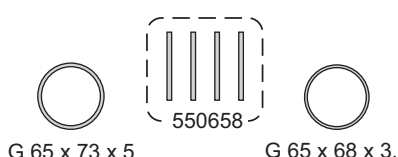

550658

G 65 x 73 x 5

G 65 x 68 x 3.6

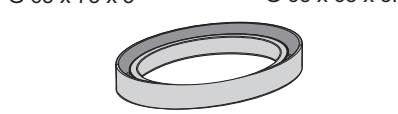

R560111V



R570412V

R560113V

R560114P

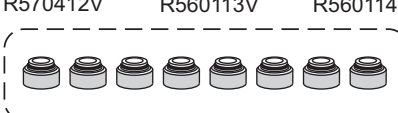

R560110V

**RENAULT**



Motor/Engine	Cm³	HP	Ø
E5F/E7F E6J/E7J Energy (SOHC) 8V	1171 1390	55/60 77/80	75.8 75.8

Renault: E5F/E7F Clio, R19 1990/98  
E6J/E7J Clio, R19, Express 1990/95  
Kangoo 2001/..., Megane 1995/97



Nº OE	Descripción/Description	Mat.	Ref.
	Jgo. de juntas para motor		560800-R
	Jgo. de juntas superior	●	560895
	Jta. tapa cilindros Ø 77.0 ±1.40  NR <sup>2</sup> HAE12038	NFT 1 1	560807
	Jgo. tornillos tapa cilindros  HAE12038		B560800
7700854640	Junta tapa válvulas	CB 1 1	560810
7700739392	Junta para cárter	N 1 1	560811
	Tapa bomba de agua	CB 1 1	560814
	Múltiple escape	NFT 1 1	560816
7700749824	Multiple admisión	NFT 1 1	560817
	Tapa bomba nafta	CB 1 1	560828
	Bomba nafta	CB 2 2	570029
7703062062	Arandela tapón cárter A 16 x 22 x 1 C	CU	550930
	Junta admisión	NB 1 1	560832
7700575468	Jgo. suplemento camisas cilindros (4)	GS 1 1	550671
	O'ring G 36.17 x 2.62	GS	1
	Arandela A 16 x 21 x 1.5 C	AL	1
	Kit de retenes completo		R560800
	Jgo. retén válvulas (8)	V 1 1	R560810V
	Retén bancada 80 x 100 x 8	V 1 1	R570011V
	Retén distribución 35 x 47 x 7	P 1 1	R550613P
	Retén árbol levas 30 x 42 x 7	P 1 1	R260113P

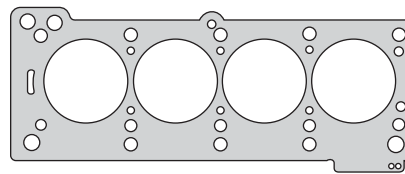

560807

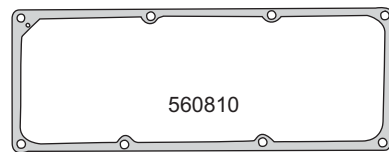

560810

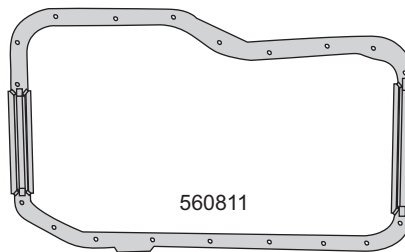

560811



560816



560817



560828



560814

560828



570029



G 36.17 x 2.62



A 16 x 21 x 1.5 C



550671



R570011V



R260113P



R550613P



R560810V



**RENAULT**



Motor/Engine Cm³ HP Ø

**C3G**  
(OHV) 8V 1239 55 74

Renault: Twingo, Clío, Express 1992/...



Nº OE	Descripción/Description	Mat.			Ref.
	Jgo. de juntas para motor		●	●	570000-R
	Jgo. de juntas superior		●		570095
7702080611	Jta. tapa cilindros Ø 77.0 ± 1.40	NFT	1	1	550705
	Jta. tapa cilindros Ø 77.0 ± 1.20  NR	NFT			550707
	Jgo. tornillos tapa cilindros (HAS17038)				B550400
7701036311	Conj. junta tapa válvulas (4)	P	1	1	560510
7702070195	Jgo. junta para cárter (4)	CG		1	550711
7702057213	Tapa distribución	CG		1	550412
770208065	Tapa bomba de agua	NB	1	1	550714
770220795	Múltiple admisión y escape	NFT		1	550815
	Múltiple admisión y escape	NFT		1	550816
7702080617	Bomba de agua a tapa de cilindros	NB	1	1	550719
	Bomba nafta block	NB		1	570028
	Base bomba nafta	CB		2	570029
	Arandela B 16 x 22 x 2.4 CN	CN			450229
	Arandela termostato A 22 x 33 x 1.5	NB			550929
	Brida	NB		1	570030
7702057732	Arandela tapa válvulas A 7 x 17 x 1.5 FA	NB	3	3	550430
7704000287	Tapa cámara de agua	NB	1	1	550331
0607155200	Bomba aceite a block	NB		1	550435
6071557	Base distribuidor	NB		1	550338
7701348178	Jgo. suplemento camisa cilindros (4)	GS		1	550671
	Jgo. suplemento camisa cilindros (4)	CU		1	550470-0.10
	Arandela A 8 x 14 x 1 C	CU		1	
	Arandela A 14 x 20 x 1.5 C	CU		1	
	Arandela A 16 x 22 x 1.5 A	AL		1	
	Kit de retenes completo				R570000
	Jgo. retén válvulas (8)	V		1	R550910V
	Retén distribución 35 x 50 x 9	P		1	R550412P
	Retén bancada 80 x 100 x 8	V		1	R570011V

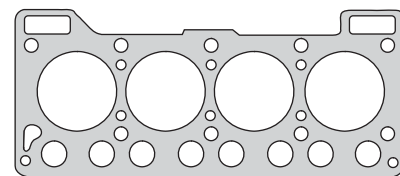

550705

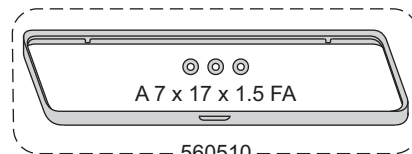

560510

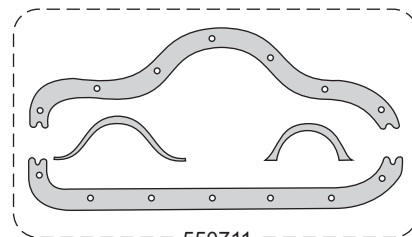

550711

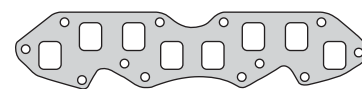

550815/550816

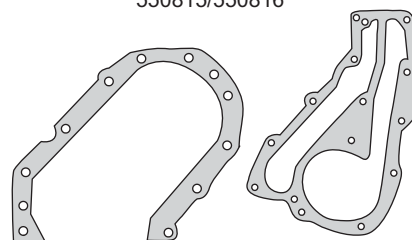

550412

550714

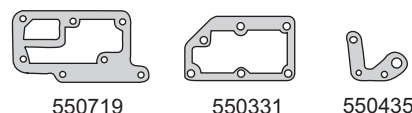

550719

550331

550435

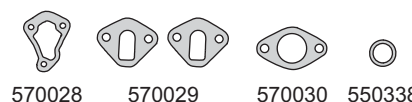

570028

570029

570030

550338

A 8 x 14 x 1 C

A 14 x 20 x 1.5 C

A 16 x 22 x 1.5 A



550470-0.10

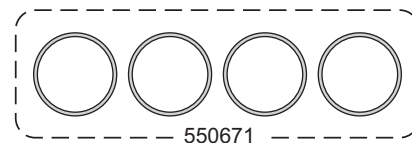

550671



R570011V



R550412P



R550910V

**RENAULT**



Motor/Engine	Cm <sup>3</sup>	HP	Ø
F7R 700/710/714	1998	150	82.7
F7P 700/704	1764	133/140	82
720/722 (DOHC) 16V			

**Renault:** Clio Williams, Spider Sport 1993/...  
Megane Coupe 1995/99  
Clio 1991/99, R19 1989/96



Nº OE	Descripción/Description	Mat.			Ref.
	Jgo. de juntas para motor				570100-R
	Jgo. de juntas superior		●	●	570195
7700850292	Jta. tapa cilindros Ø 84.0 $\pm$ 1.30  NR <sup>2</sup>	NFT	1	1	570107
	Jgo. tornillos tapa cilin.  (HAT55055/55100)				B570100
7701040740	Junta tapa válvulas superior	NB	1	1	570110
7701040741	Junta tapa válvulas inferior	NB	1	1	570136
7700859751	Junta para cárter	NFT		1	560111
7700851213	Bomba de agua	CB		1	560114
7700865249	Múltiple escape	NFT	1	1	570115
7700869886	Múltiple admisión	NB	1	1	570117
	Múltiple admisión	NFT			570117-1
7700852434	Inferior árbol de levas	NB	1	1	560119
7700718380	Guarnición termostato	GS		1	560131
	Arandela tapón cárter A 16 x 22 x 2 C	CU		1	
	Kit de retenes completo				R570100
7700736465	Jgo. retén válvulas (16)	V		1	R570110V
7703087190	Retén bancada 85 x 105 x 8	V		1	R560111V
7700719274	Retén distribución 50 x 68 x 10	P		1	R550612P
7703087192	Retén árbol de levas 25 x 42 x 7	V		2	R560113V

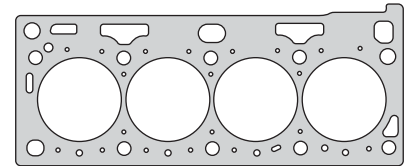

570107

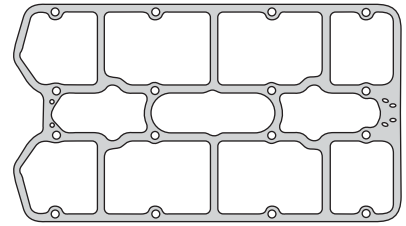

570110

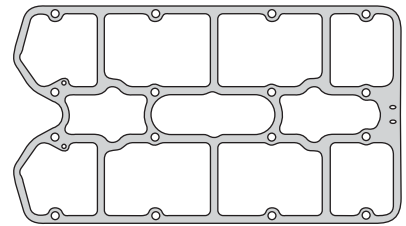

570136

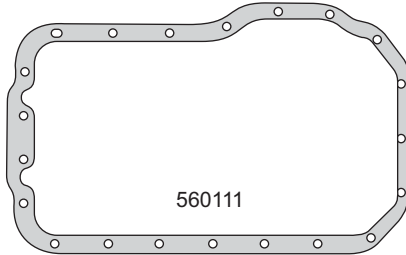

560111

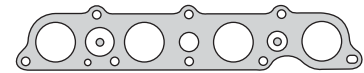

570115



570117

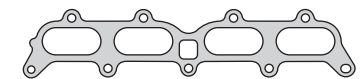

570117-1

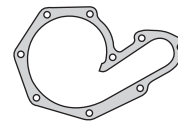

560114

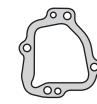

560119



560131



A 16 x 22 x 2 C



R560111V



R550612P

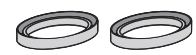

R560113V

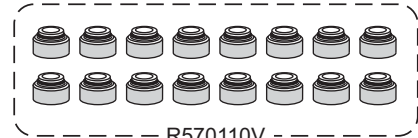

R570110V

**RENAULT**



Motor/Engine	Cm³	HP	Ø
K7M-744/745 (SOHC) 8V	1598	75/90	79.5

Renault: Megane Scenic RN, Clio 1998/...  
Clio II 1998/05  
Sandero 2007/..., Symbol



Nº OE	Descripción/Description	Mat.	Ref.
	Jgo. de juntas para motor		570200-R
	Jgo. de juntas superior		570295
	Jta. tapa cilindros Ø 80.0 ± 1.30	NFT 1	570205
	Jta. tapa cilindros Ø 80.0 ± 1.30 NR	NFT 1	570207
	Jgo. tornillos tapa cilindros (HAE12038)		B570200
	Jgo. tornillos tapa cilindros (HAE14038)		B570200-1
7700854640	Junta tapa válvulas	CB	560810
	Junta tapa válvulas	SLS 1 1	560831
7700273486	Junta para cárter	N	570211
	Bomba de agua	CB	560814
7700867360	Múltiple escape con deflector	AC	570215
7700867360	Múltiple escape	NFT 1 1	560816
7700865764	Múltiple admisión	NB 1 1	570217
7701471932	Jgo. múltiple admisión (4) - Clio II 1998/05	GS 1 1	571017
	Salida de escape	AC/AS	570218
7700851497	Tapa bomba nafta	CB 1 1	560828
7700272895	Tapa trasera árbol levas	NFT 1 1	570229
7700740028	O'ring llenado aceite G 40 x 5	GS 1 1	570241
7703062062	Arandela tapón cárter A 16 x 21 x 2 C	CU 1 1	
	Kit de retenes completo		R560800
7700736465	Jgo. retén válvulas (8)	V 1	R560810V
7700859692	Retén bancada 80 x 100 x 8	V 1	R570011V
7700854842	Retén distribución 35 x 47 x 7	P 1	R550613P
7700749395	Retén árbol levas 30 x 42 x 7	P 1	R260113P

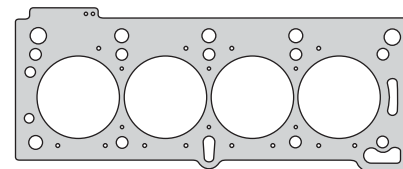

570207

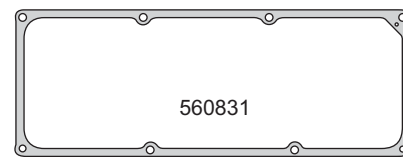

560831

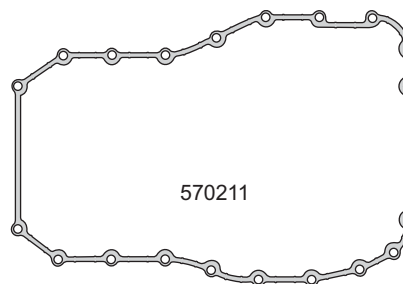

570211

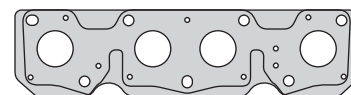

570215



560816



570217

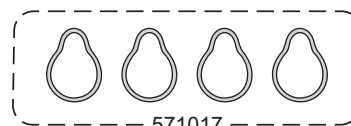

571017

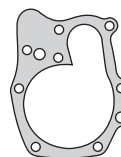

560814



560828



570218



570229



A 16 x 21 x 2 C



570241



R570011V



R550613P



R260113P



R560810V

**RENAULT**



Motor/Engine	Cm³	HP	Ø
F9Q Turbo Iny. Directa (SOHC) 8V	1870	80/100	80
<b>DIESEL</b>			

**Renault:** Megane DTI - RN - RT  
Laguna 716/730/734/750  
Scenic 736 - Space 722 1999/...  
Kangoo 2000/...  
Megane Coupe DTI 731 2000/...



Nº OE	Descripción/Description	Mat.	1	2	Ref.
	Jgo. de juntas para motor				570301-R
	Jgo. de juntas superior		●		570395-1M
	Jgo. de juntas superior				570395-2M
	Jgo. de juntas superior				570395-3M
	Jgo. juntas superior sin JTC				570396
7700667325	Junta tapa cilindros Ø 81.0 ± 1.50	NFT	1		570307-1M
7700105392	Junta tapa cilindros Ø 81.0 ± 1.40	NFT			570307-2M
7700105393	Junta tapa cilindros Ø 81.0 ± 1.60	NFT			570307-3M
	Jgo. tornillos tapa cilindros (HAE14038)				B570300
7700874515	Conj. junta tapa válvulas (4)	N	1	1	570310
7700108057	Junta cárter para cárter aluminio	N		1	560611
8200105746	Junta frente motor porta retén distribución	NB		1	560612
7700851213	Bomba de agua	CB		1	560114
7700874592	Múltiple admisión y escape	SLS	1	1	570315
7700852454	Inferior árbol levas	NB		1	560119
7701040923	Guarnición termostato	GS	1	1	570319
7701030255	Bomba alimentación	NB		2	550628
	Arandela B 18 x 24 x 2.3 CN	CN			450029
	Arandela tapa válvula	AC/GS	3	3	570330
	Termostato	GS	1	1	560131
	Guarnición sintético G 65 x 68 x 3.6	GS		1	560132
	Guarnición sintético G 65 x 73 x 5	GS		1	560233
	Arandela B 22 x 28 x 3 CN	CN			560134
	Arandela pico inyector	AC	4	4	560036
7700724836	Guarnición bomba vacío	NB		1	570338
7701046634	O'ring bomba vacío G 74 x 3	GS		1	560640
	Entrada a turbo	FCH			570343
	Salida a turbo	FCH			570344
7701045660	Jta. bomba depresora Magnetti/Marelli	GS		1	570345
7703061078	Jta. bomba depresora Pierburg	GS		1	570346
	Jgo. cierre bancada (4)	GS		1	550658
	Arandela A 10 x 15 x 1.5 A	AL		1	
	Arandela A 16 x 22 x 1.5 C	CU		1	
	Arandela A 14.5 x 21 x 2 C	CU		4	
	Arandela A 18 x 24 x 1.5 A	AL		1	
	Arandela A 22 x 28 x 2 A	AL		1	
	O'ring G 28.17 x 3.53	GS		1	
	Kit de retenes completo				R570300
	Jgo. retén válvulas (8)	V		1	R560810V
	Retén bancada 85 x 105 x 8	V		1	R560111V
	Retén distribución 42 x 54 x 6	V		1	R570412V
	Retén árbol levas 25 x 42 x 7	V		1	R560113V
	Retén auxiliar 30 x 40 x 7	P			R550615P

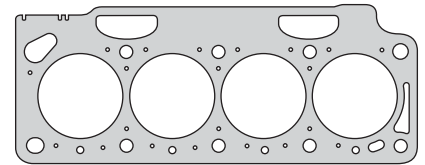

570307

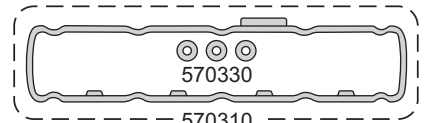

570330

570310

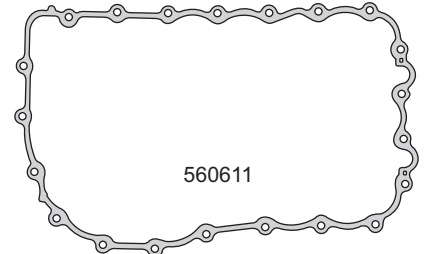

560611

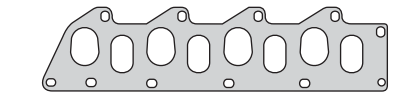

570315

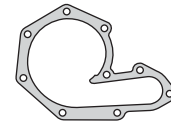

560114

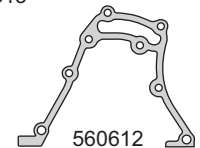

560612



560119



570319



550628



560131



570338



560036



570343



570344



570345



570346



550658



G 74 x 3



G 65 x 73 x 5



G 65 x 68 x 3.6



G 28.17 x 3.53



A 16 x 22 x 1.5 C



A 22 x 28 x 2 A

A 14.5 x 21 x 2 C



A 18 x 24 x 1.5 A



A 10 x 15 x 1.5 A



R560111V



R570412V



R560113V



R550615P



R560810V

**RENAULT**



Motor/Engine	Cm³	HP	Ø
F3R 722/796/729 (SOHC) 8V	1998	115	82.7

Renault: Megane RT, Scenic Laguna RT/RXE



Nº OE	Descripción/Description	Mat.	Ref.
	<b>Jgo. de juntas para motor</b>		<b>570400-R</b>
7700859273	Junta tapa cilindros Ø 83.5 ± 1.40	NFT	1 560407
	<b>Jgo. tornillos tapa cilindros (HAT55055/55100)</b>		<b>B560600</b>
7700719666	Conj. junta tapa válvulas (4)	N	1 560110
7700108057	Junta cárter para cárter aluminio	N	1 560611
7700851213	Tapa bomba de agua	CB	1 560114
7700854539	Múltiple admisión y escape	NFT	1 560415
	Salida de escape	NFT	1 570418
7700836096	Acople caño escape - Megane/Scenic	AC	1 581218
7700423572	Acople caño escape - Laguna	AC	570418-2
7700852434	Árbol de levas	NB	1 560119
7701040923	Guarnición termostato	GS	1 570319
7700622283	Bomba nafta	NB	2 550628
	Arandela B 18 x 24 x 2.3 CN	CN	450029
7700736647	O'ring G 31.5 x 3.2	GS	1 560129
	Arandela B 16 x 22 x 2.4 CN	CN	450229
7703061078	Arandela tapa válvulas A 7 x 17 x 1.5 F	NB	3 550430
7700718380	Anillo termostato	GS	1 560131
700736647	Guarnición sintética radiador aceite	GS	560132
7700709470	Guarnición sintética G 65 x 68 x 3.6	GS	1 560133
	Arandela especial B 22 x 28 x 3 C	CN	560134
	Arandela A 14.5 x 21 x 2 C	CU	2 560136
7701030255	Jgo. cierre bancada (4)	GS	1 550658
	Arandela A 12 x 16 x 1 C	CU	2
	Arandela A 16 x 22 x 1.5 A	AL	2
	Arandela A 18 x 24 x 1.5 A	AL	2
	Arandela A 22 x 28 x 2 A	AL	1
	O'ring G 65 x 73 x 5	GS	1
	Kit de retenes completo		R570400
	Jgo. retén válvulas (8)	V	1 R560110V
	Retén bancada 85 x 105 x 8	V	1 R560111V
	Retén distribución 42 x 54 x 6	V	1 R570412V
	Retén árbol levas delantero 25 x 42 x 7	V	1 R560113V
	Retén árbol levas trasero 22 x 45 x 7	V	1 R560114V
	Retén auxiliar 30 x 40 x 7	V	1 R550615V

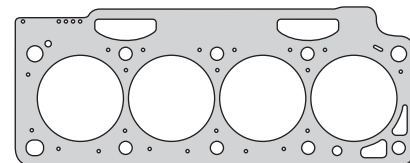

560407

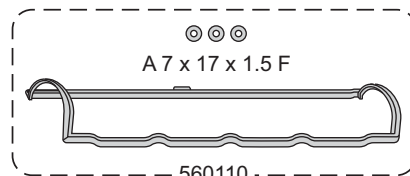

A 7 x 17 x 1.5 F

560110

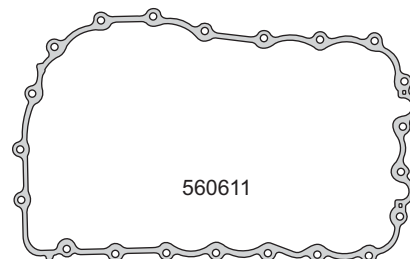

560611

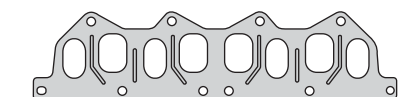

560415

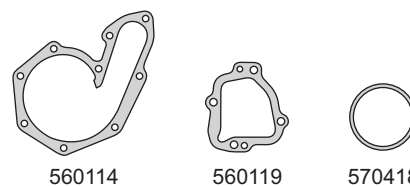

560114

560119

570418

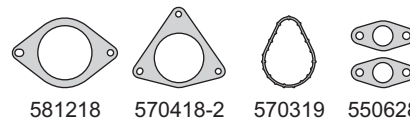

581218

570418-2

570319

550628



560131

G 31.5 x 3.2

560132



A 18 x 24 x 1.5 A

A 16 x 22 x 1.5 A

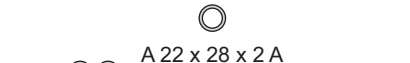

A 22 x 28 x 2 A



A 14.5 x 21 x 2 C

A 12 x 16 x 1 C

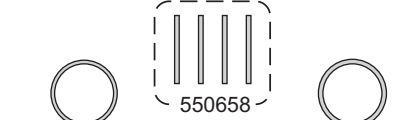

550658

G 65 x 68 x 3.6

G 65 x 73 x 5

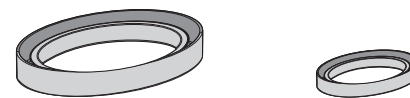

R560111V

R570412V

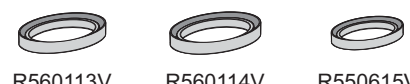

R560113V

R560114V

R550615V

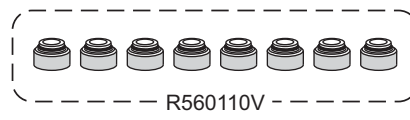

R560110V

**RENAULT**



Motor/Engine	Cm³	HP	Ø
D7F/D7D 700 701/710/730/734 (SOHC) 8V	1149	55/60	69

Renault: Twingo 1996/..., Clio 1995/...  
Kangoo 1997/...  
D7D - Twingo 2001/...



Nº OE	Descripción/Description	Mat.			Ref.
	Jgo. de juntas para motor				570500-R
	Jgo. de juntas superior	●	●		570595
8200034315	Jta. tapa cilindros Ø 70.0 ±1.40  NR	NFT	1	1	570507
	Jgo. tornillos tapa cilindros (HAE12038)				B570500
7701471213	Junta tapa válvulas - Hasta 09/2000	SLS	1	1	570510
7701049734	Junta tapa válvulas - Desde 09/2000	N	1	1	570536
7700866465	Junta para cárter	NB		1	570511
	Junta bomba de aceite	NB		1	581012
	Junta bancada	NB		1	581013
8200237224	Junta bomba de agua	SLS	1	1	581014
7700866689	Múltiple escape	AC	1	1	570515
7700204945	Jgo. múltiple admisión (2)	N	1	1	570517
	Junta bomba nafta block	NB		1	570028
	Junta	NB		1	570532
	Junta	NB		1	570535
	Junta chupador aceite	GS	1	1	581036
	Anillo G 45 x 49 x 5	GS	1	1	
	Arandela A 14 x 20 x 1.5 A	AL		1	
	Arandela A 16 x 22 x 1.5 C	CU		1	
	O´ring G 12.42 x 1.78	GS	1	1	
	O´ring G 13.94 x 2.62	GS	1	1	
	O´ring G 17.12 x 2.62	GS	1	1	
	O´ring G 18.77 x 1.78	GS	1	1	
	O´ring G 7.65 x 1.78	GS	1	1	
	Kit de retenes completo				R570500
7700862483	Jgo. retén válvulas (8)	V		1	R570510V
7700873534	Retén bancada 70 x 86 x 8	V		1	R570511V
7700874223	Retén distribución 32 x 44 x 6	V		1	R570512V
7700749395	Retén árbol de levas 30 x 42 x 7	P		1	R260113P

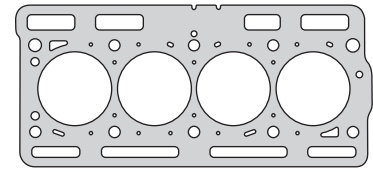

570507

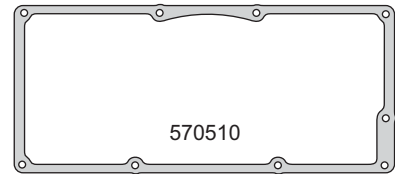

570510

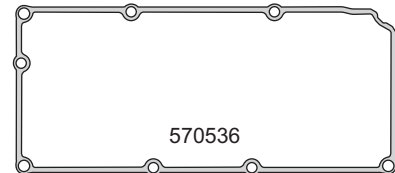

570536

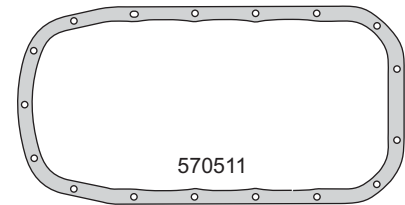

570511



570515

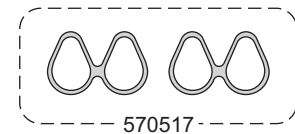

570517

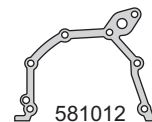

581012



570028



570532



581034



570535



581036

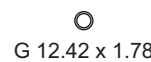

G 12.42 x 1.78



G 13.94 x 2.62



G 18.77 x 1.78



G 7.65 x 1.78



G 17.12 x 2.62



A 16 x 22 x 1.5 C



A 14 x 20 x 1.5 A



R570512V



R570511V



R260113P



R570510V

# RENAULT



Motor/Engine	Cm³	HP	Ø
B4184S	1731	115	83
N7Q	1948	138/140	83
B4204S/T	1948	140	83
B4204T (DOHC) 16V	1948	160	83

**Renault:** Laguna 700/704 1994/99  
Safrane 710/711 1996/99  
Space 1996/...

**Volvo:** S40/V40 B4184S 1995/...  
S40/V40 B4204S/4204T 1996/...

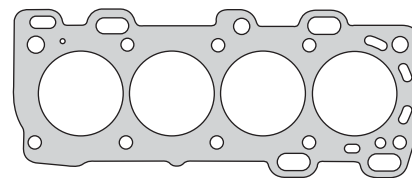

570607

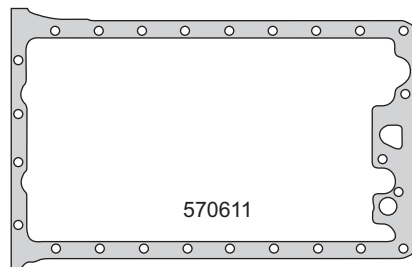

570611

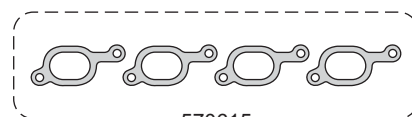

570615



570617

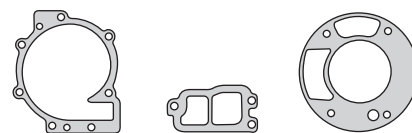

570614

570619

570627



550628

G 50.47 X 2.62

570629

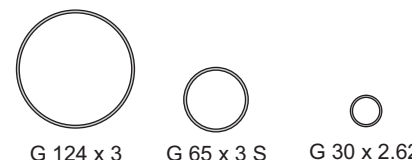

G 124 x 3

G 65 x 3 S

G 30 x 2.62



G50.52 x 1.78



A 19 x 24 x 1.5 A



G 32 x 3



G 20 x 2.5



R570611V



R570612V



R570613V



R570614P

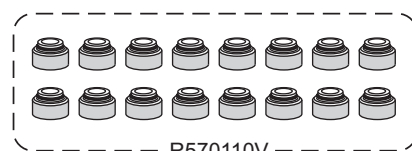

R570110V

Nº OE	Descripción/Description	Mat.	Ref.
	Jgo. de juntas para motor		570600-R
	Jgo. de juntas superior		570695
	Jta. tapa cilindros Ø 85.0 ± 1.70 NR <sup>2</sup>	NFT 1 1	570607
	Jgo. tornillos tapa cilindros (HAS14038)		B570600
	Junta para cárter	NB 1	570611
7431397532	Tapa bomba de agua	NB 1	570614
7439146313	Jgo. múltiple escape (4)	NFT 1 1	570615
7431366788	Múltiple admisión	NFT 1 1	570617
	Base termostato	NB 1 1	570619
7439135830	Tapa bomba aceite	NB 1 1	570627
7700622283	Retorno de agua	NB 1 1	550628
	Guarnición goma G 22 x 27 x 4 S	GS	570629
	Arandela tapón cárter A 19 x 24 x 1.5 A	AL	1
	Cierre protección bujías o ring G 50.52 x 1.78	GS 4 4	
	O'ring G 32 x 3	GS	1
	O'ring G 30 x 2.62	GS	1
	O'ring G 20 x 2.5	GS	1
	O'ring pre-filtro cárter G 50.47 x 2.62	GS	
	O'ring G 65 x 3	GS	
7430925096	O'ring bomba aceite G 124 x 3	GS	
	Kit de retenes completo		R570600
7700736465	Jgo. retén válvulas (16)	V 1	R570110V
7436842092	Retén bancada 98 x 110 x 7	V 1	R570611V
7436842273	Retén distribución 35 x 47 x 5.5	V 1	R570612V
7436842272	Retén árbol de levas 45 x 57 x 6.5	P 2	R570613P
7439443310	Retén árbol de levas trasero 30 x 47 x 6	P 2	R570614P

**RENAULT**



Motor/Engine	Cm³	HP	Ø
K4J 16V	1390	95/98	79.5
K4M 16V (DOHC) 16V	1598	110	79.5

**Renault:** K4J - Clio II 2001/..., Scenic 1999/...  
 Megane II 2003/...  
 K4M - Clio, Scenic, Megane, Symbol,  
 Laguna 1998/00, Logan 2007/..., Logan,  
 Fluence, Duster, Sandero Stepway,  
 Kangoo 2015/..., Duster 2016/...



Nº OE	Descripción/Description	Mat.	Ref.
	Jgo. de juntas para motor		570900-R
	Jgo. de juntas para motor		570900 MLS
	Jgo. de juntas superior	●	570995
	Jgo. de juntas superior (MLS)		570995 MLS
	Junta tapa cilindros Ø 80.5 ± 1.40	NFT 1	570905
	Junta tapa cilindros Ø 80.5 ± 1.40	NFT 1	570907
	Junta tapa cilindros Ø 80.5 ± 1.40	MLS	570908
	Jgo. tornillos tapa cilindros (HAE12038)		B570900
	Junta ventilación tapa válvula	NB 1 1	570910
	Junta para cárter	N 1	570911
8200659199	Bomba de agua	SLS 1	570914
	Múltiple escape	AC 1 1	570915
	Múltiple admisión	SLS 1 1	570917
	Base termostato	SLS 1 1	570919
	Base termostato	GS 1 1	570930
7700109420	Guarnición goma admisión	N 1 1	580030
7700109421	Múltiple entre colector	N 4 4	580032
	Jgo. entre múltiple admisión (5)	N 1 1	580035
	Tapón árbol de levas	GS 1 1	570938
	Tapón árbol de levas	GS 1 1	570939
	Suplemento junta tapa cilindros (0.50)	AC	57985-0.50
	Arandela A 16 x 24 x 1 C	CU 1	
	Kit de retenes completo		R570900
	Jgo. retén válvulas (16)	V 1	R570910V
	Retén bancada 80 x 100 x 8	V 1	R570011V
	Retén distribución 35 x 47 x 7	V 1	R550613V
	Retén árbol de levas 28 x 42 x 5	V 2	R570913V

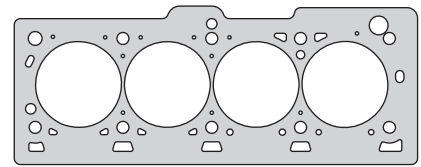

570907

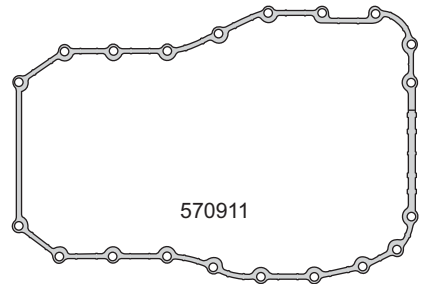

570911

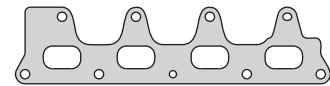

570915



570917

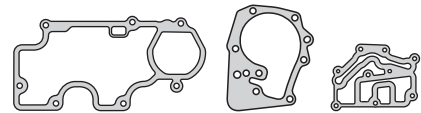

570910

570914

570919



570930

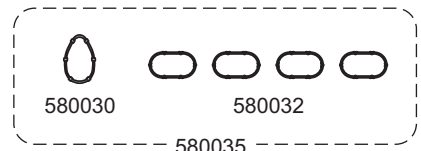

580030

580032

580035



570938



A 16 x 24 x 1 C



570939



R570011V



R550613V



R570913V

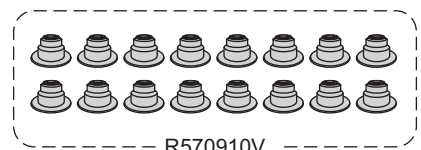

R570910V



**RENAULT**



Motor/Engine	Cm³	HP	Ø
K7J 714	1390	75/90	79.5
K7M 714	1598	75/84	79.5
K7M 800 (SOHC) 8V	1598	80/95	79.5

**Dacia:** Logan 2006/..., Sandero, Logan 2010/...  
**Renault:** Logan 2006/..., Sandero 2007/...

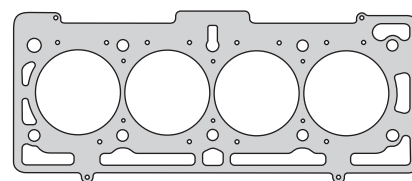

571008



560831

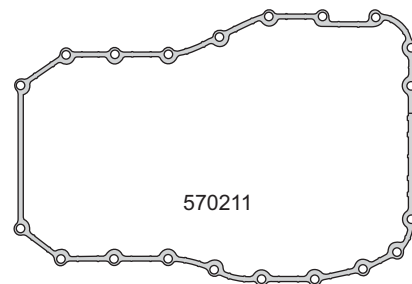

570211



571015

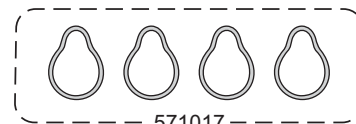

571017



570914



570218



571019



570930



A 16 x 21 x 2 C



R570011V



R260113P



R550613P



R560810V

Nº OE	Descripción/Description	Mat.	Ref.
	Jgo. de juntas para motor		● 571000-R MLS
7701475899	Jgo. de juntas superior (MLS)	●	571095 MLS
	Jgo. de juntas superior		571095
	Jta. tapa cilindros Ø 80.5 ± 1.20	NFT	571007
8200296969	Jta. tapa cilindros Ø 80.5 ± 0.42	MLS	1 1 571008
7700738987	Jgo. tornillos tapa cilindros (HAE12038)		B570200
7701471719	Junta tapa válvulas	SLS	1 1 560831
7700273486	Junta para cárter	GS	1 570211
8200659199	Junta bomba de agua	SLS	1 570914
8200191371	Múltiple escape	AC	1 1 571015
7701471932	Jgo. múltiple admisión (4)	GS	1 1 571017
	Salida de escape	AC/AS	1 570218
8200267272	Guarnición termostato	GS	1 571019
	Base termostato	GS	1 570930
7703620621	Arandela tapón cárter A 16 x 21 x 2 C	CU	1
	Kit de retenes completo		R560800
8200234651	Jgo. retén válvulas (8)	V	1 R560810V
7700859692	Retén bancada 80 x 100 x 8	V	1 R570011V
7700273776	Retén distribución 35 x 47 x 7	P	1 R550613P
7700101348	Retén árbol de levas 30 x 42 x 7	P	1 R260113P

**RENAULT**



Motor/Engine	Cm³	HP	Ø
H4M	1598	111/120	78
HR16DE (DOHC) 16V	1598	111/120	78

**Renault:** Capture, Kangoo 2016/...  
**Nissan:** Micra 2005/10, Tiida 2007/12  
 Versa 2016



Nº OE	Descripción/Description	Mat.	Ref.
	Jgo. de juntas para motor	●	571100-R-MLS
	Junta tapa cilindros Ø 80.5 $\times$ 1.20	NFT	571107
11044-1KT0B	Junta tapa cilindros Ø 80.5 $\times$ 0.60	MLS	1 571108
	Jgo. tornillos tapa cilindros		B571100
132701KT0A	Junta tapa válvulas	V	1 571110
	Junta cárter	NB	1 571111
	Junta frente distribución	CB	1 571112
	Bomba de agua	NB	1 571114
140361KT0A	Múltiple escape	AC	1 571115
140328698R	Jgo. múltiple admisión (5)	GS	1 571117
	Junta termostato	NB	1 571130
11062-1KT0A	Junta caballete de agua	SLS	1 571131
161757436R	Guarnición mariposa aceleración	GS	1 571132
	O´ring G 19.18 x 2.46	GS	1
	O´ring G 19.35 x 3.53	GS	1
	O´ring G 25.07 x 2.62	GS	1
	O´ring G 25.7 x 3.53	GS	1
	Kit de retenes completo		R571100
13207CJ40A	Jgo. retén válvulas (16)	V	1 R57110V
	Reten de bancada 84 x 117 x 7.5	V	1 R571111V
	Retén de distribución 40 x 52 x 7	V	1 R571112V

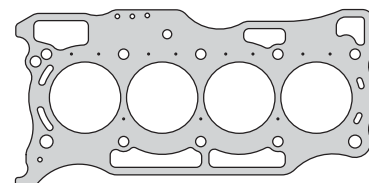

571108

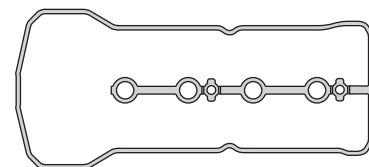

571110

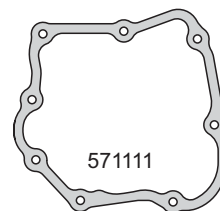

571111



571115

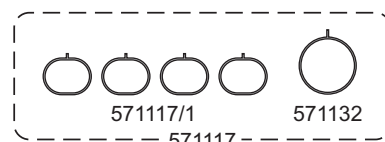

571117/1 571132  
571117

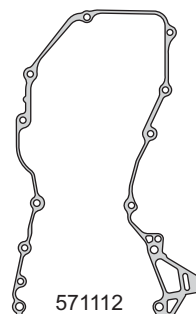

571112

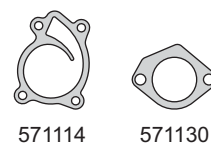

571114 571130

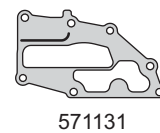

571131

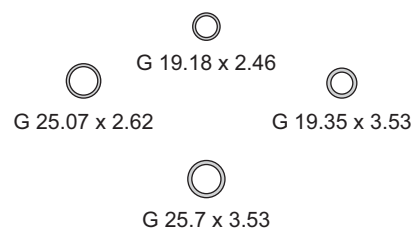

G 19.18 x 2.46  
G 19.35 x 3.53  
G 25.07 x 2.62  
G 25.7 x 3.53



R571111V



R571112V

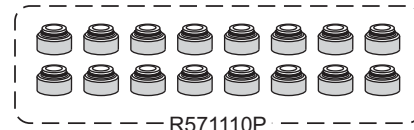

R571110P

**RENAULT**



Motor/Engine Cm³ HP Ø

**B4D**  
(DOHC) 12V **999** **66** **70**

Renault: Kwid 2017

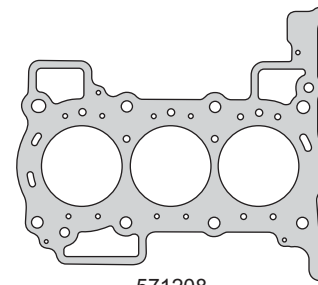

571208

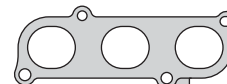

571215



571217

571232



571214



571218



571229



571231



571233

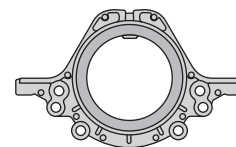

PR571211V



R571211V



R420613P

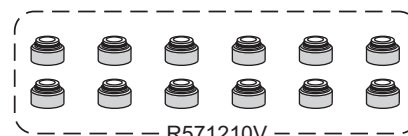

R571210V

N° OE	Descripción/Description	Mat.	Ref.
	Jgo. de juntas para motor		● 571200-R MLS
	Jgo. de juntas para motor		571200-R
	Jgo. de juntas superior		571295
	Junta tapa cilindros Ø 73.0 ± 1.20 NR	NFT 1	571207
110447527R	Junta tapa cilindros Ø 71.5 ± 0.60 NR	MLS 1	571208
110564511R	Jgo. de tornillos para tapa de cilindros		B571200
	Sellador líquido - caucho de silicona		TRN0085G
210148509R	Bomba de agua	GS 1	571214
140362111R	Múltiple de escape	AC 1 1	571215
8201704956	Jgo. múltiple admisión (4)	GS 1 1	571217
	Salida de escape	GFT 1	571218
213043724R	Guarnición cambiador de agua	GS 1 1	571229
150565634R	Junta tubo succión aceite	GS 1	571231
8201695844	Junta válvula mariposa	GS 1 1	571232
135654971R	Junta drenaje tapa distribución	GS 1 1	571233
	Kit de retenes completo		R571200
132074730R	Jgo. retén válvulas (12)	V 1	R571210V
122795908R	Retén bancada 69 x 89 x 8	V 1	R571211V
122974689R	Porta reten bancada	V	PR571211V
135106494R	Retén distribución 40 x 52 x 7	P 1	R420613P

**RENAULT**



Motor/Engine	Cm³	HP	Ø
K7M - Flex (SOHC) 8V	1598	90	79.5

Renault: Logan 2007/13, Sandero 2007/14  
Symbol 2009/12, Logan II 2014/19  
Sandero II 2015/19



Nº OE	Descripción/Description	Mat.	Ref.
	Jgo. de juntas para motor		● 571300-R MLS
	Jgo. de juntas para motor		571300-R
7701475899	Jgo. de juntas superior (MLS)	●	571395 MLS
	Jgo. de juntas superior		571395
	Jta. tapa cilindros Ø 80.5 ± 1.20	NFT	571307
	Jta. tapa cilindros Ø 80.5 ± 1.00	MLS	1 1 571308
7700738987	Jgo. tornillos tapa cilindros (HAE12038)		B571300
7701471719	Junta tapa válvulas	SLS	1 1 560831
7700273486	Junta para cárter	GS	1 570211
8200659199	Junta bomba de agua	SLS	1 570914
8200191371	Múltiple escape	AC	1 1 571015
7701471932	Jgo. múltiple admisión (4)	GS	1 1 571017
	Salida de escape	AC/AS	1 570218
8200267272	Guarnición termostato	GS	1 571019
	Base termostato	GS	1 570930
7703620621	Arandela tapón cárter A 16 x 21 x 2 C	CU	1
	Kit de retenes completo		R560800
8200234651	Jgo. retén válvulas (8)	V	1 R560810V
7700859692	Retén bancada 80 x 100 x 8	V	1 R570011V
7700273776	Retén distribución 35 x 47 x 7	P	1 R550613P
7700101348	Retén árbol de levas 30 x 42 x 7	P	1 R260113P

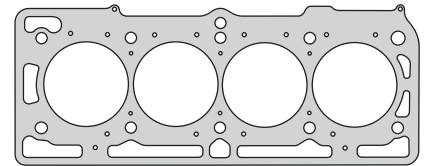

571308

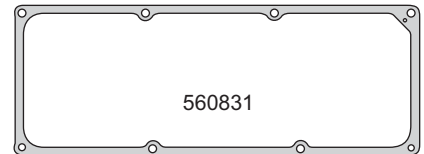

560831

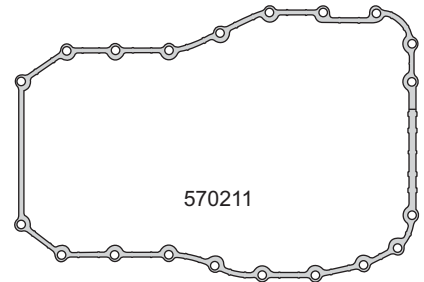

570211



571015

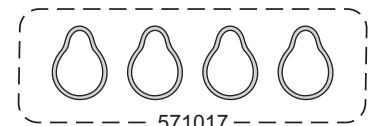

571017



570914



570218



571019



570930



A 16 x 21 x 2 C



R570011V



R260113P



R550613P



R560810V

**RENAULT**



Motor/Engine	Cm³	HP	Ø
B4D 409 (DOHC) 12V	999	82	71

Renault: Sandero II, Logan 2017/...

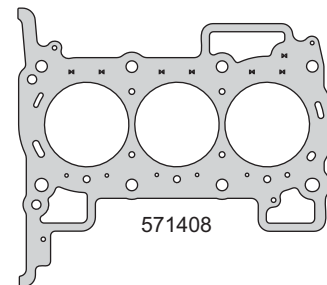

Nº OE	Descripción/Description	Mat.	Ref.
	Jgo. de juntas para motor		● 571400-R MLS
	Junta tapa cilindros Ø 73.0 $\pm$ 1.20	NFT	571407
110442970R	Junta tapa cilindros Ø 71.5 $\pm$ 0.60	MLS	1 571408
	Jgo. de tornillos para tapa de cilindros		B571200
	Sellador líquido - caucho de silicona		TRN0085G
210148509R	Junta bomba de agua	GS	1 571214
208134876R	Múltiple de escape	AC	1 571415
8201704956	Jgo. múltiple admisión (4)	GS	1 571217
110622559R	Guarnición termostato	GS	1 570319
213043724R	Guarnición cambiador de agua	GS	1 571229
8201695844	Junta válvula mariposa	GS	1 571232
150565634R	Junta tubo succión aceite	GS	1 571231
8201705104	Junta bomba de aceite	GS	1 571431
135654971R	Junta drenaje tapa distribución	GS	1 571233
110265505R	Arandela tapón cárter A 16 x 24 x 1.5 A	AL	1
135653299R	O´ring G 17.12 x 2.62	GS	1
8201705139	O´ring G 30 x 3	GS	1
	Kit de retenes completo		R571200
132074730R	Jgo. retén válvulas (12)	V	1 R571210V
122795908R	Retén bancada 69 x 89 x 8	V	1 R571211V
122974689R	Porta reten bancada	V	PR571211V
135106492R	Retén distribución 40 x 52 x 7	P	1 R420613P

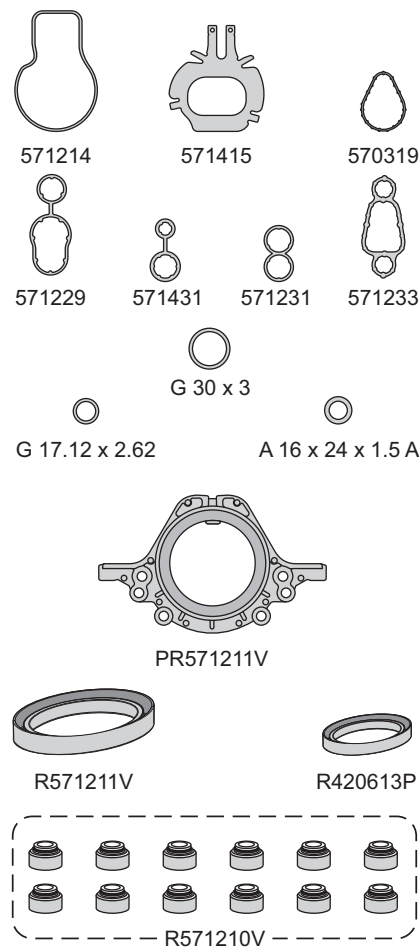

**RENAULT**



Motor/Engine	Cm³	HP	Ø
F4P	1783	120	82.7
F4R (DOHC) 16V	1998	140/169	82.7

**Renault:** Laguna 1998/..., Megane, Scenic  
Espace, Grand Espace, Laguna  
Master, Trafic 1999/...  
Laguna, Scenic, Megane, Kangoo  
Clio II Sport 2001/..., Duster 2011/...  
Captur, Duster 2015/2016/...



Nº OE	Descripción/Description	Mat.	Ref.
	Jgo. de juntas para motor		580000-R
	Jgo. de juntas superior	●	580095
	Jgo. de juntas superior (MLS)		580095 MLS
7700108254	Junta tapa cilindros Ø 83.7 ± 1.20 N.R. (6)	NFT 1 1	580007
7700104129	Junta tapa cilindros Ø 84.0 ± 0.60 N.R. (6)	MLS	580008
	Jgo. tornillos tapa cilindros (HAE14038)		B580000
7700108057	Junta para cárter	N	560611
7700851213	Tapa bomba de agua	CB	560114
7700105843	Múltiple escape	AC 1 1	580015
7700114234	Múltiple escape Clio II - Sport	AC 1 1	580016
7700109906	Múltiple admisión	SLS 1 1	580017
7700104129	Base capa termostato	SLS 1 1	570919
7700109420	Guarnición goma admisión	N 1 1	580030
7700114203	Entre múltiple admisión Clio II - Sport	SLS 1 1	580031
7700109421	Múltiple entre colector	N 4 4	580032
	Jgo. entre múltiple admisión (5)	N 1 1	580035
	Tapón árbol de levas	GS	570938
	Tapón árbol de levas	GS	570939
	Arandela A 10 x 15 x 1.5 A	AL	
	Arandela con inserto A 16 x 24 x 1.5 A	AL	
	O´ring G 28.17 x 3.53	GS 1 1	
	Kit de retenes completo		R580000
	Jgo. retén válvulas (16)	V	1 R570910V
770308224	Retén bancada 85 x 105 x 11	V	1 R560611V
7700103245	Retén distribución 42 x 54 x 6	V	1 R570412V
7436842272	Retén distribución 35 x 47 x 5.5 - F4R	V	1 R570612V
7700106879	Ret. árbol de levas 28 x 47 x 5.5 - F4P	V	2 R580013V

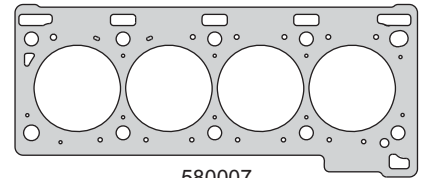

580007

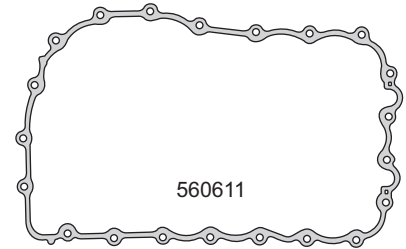

560611

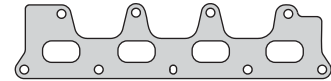

580015

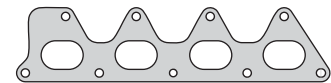

580016



580017



580031

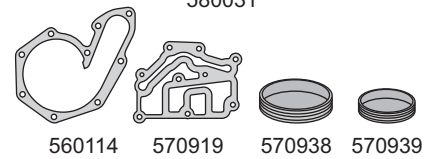

560114

570919

570938

570939

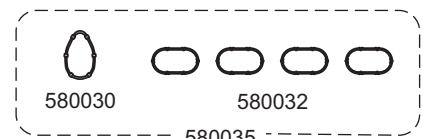

580030

580032

580035

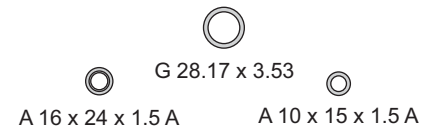

G 28.17 x 3.53

A 16 x 24 x 1.5 A

A 10 x 15 x 1.5 A

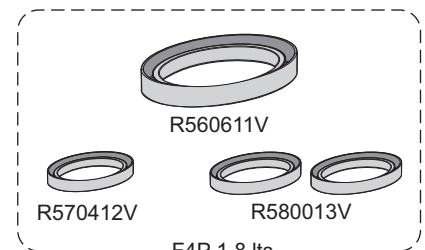

R560611V

R570412V

R580013V

F4P 1.8 lts.

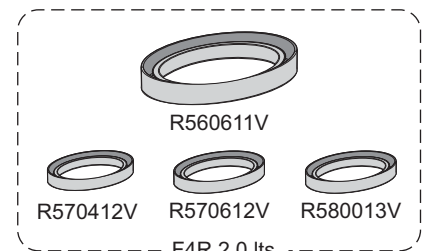

R560611V

R570412V

R570612V

R580013V

F4R 2.0 lts.

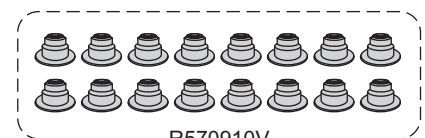

R570910V

**RENAULT**



Motor/Engine	Cm³	HP	Ø
F8Q (SOHC) 8V Iny. Indirecta	1870	65	80
<b>DIESEL</b>			

**Renault:** Clio II 630/632/662  
Kangoo 630/632/662 1998/...  
Rodeo Trafic 600/606 1998/...  
Express 644/648 1997/...  
Scenic 1999/..., Megane 1997/...

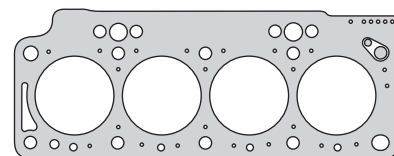

580107

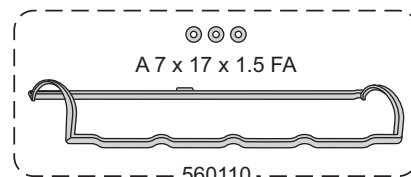

560110

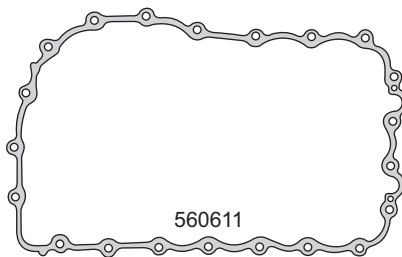

560611

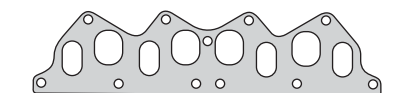

560115



560114

560612

560119

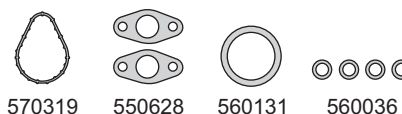

570319

550628

560131

560036

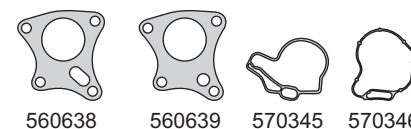

560638

560639

570345

570346



G 65 x 68 x 3.6

G 74 x 3

A22 x 28 x 2 A



A 18 x 24 x 1.5 A

A 14.5 x 21 x 2 C



A 10 x 15 x 1.5 A

A 16 x 22 x 1.5 A

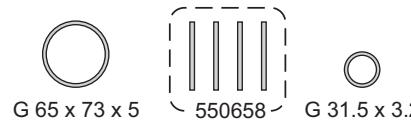

G 65 x 73 x 5

550658

G 31.5 x 3.2



R560111V



R570412V

R560113V

R560114P



R560110V

Nº OE	Descripción/Description	Mat.	Ref.
	Jgo. de juntas para motor		560701-R
	Jgo. de juntas superior		580195-1M
	Jgo. de juntas superior		580195-2M
	Jgo. de juntas superior		580195-3M
	Jgo. juntas superior sin JTC		580196
7700875717	Jta. tapa cilindros Ø 80.7 $\pm$ 1.50	NFT 1	580107-1M
7700108167	Jta. tapa cilindros Ø 80.7 $\pm$ 1.40	NFT	580107-2M
7700108170	Jta. tapa cilindros Ø 80.7 $\pm$ 1.60	NFT	580107-3M
	Jgo. tornillos tapa cilindros (HAE14038)		B570300
7700743903	Conj. junta tapa válvulas (4)	N 1 1	560110
7700108057	Junta cárter para cárter aluminio	N 1	560611
8200105746	Junta frente motor par retén distribución	NB 1	560612
7700851213	Tapa bomba de agua	CB 1	560114
7700854867	Múltiple admisión y escape	FCH 1 1	560115
7700852434	Inferior árbol de levas	NB 1 1	560119
	Guarnición termostato	GS 1	570319
770062283	Bomba alimentación	NB	550628
	Arandela tapa bujía B 18 x 24 x 2.3 CN	CN	450029
7700736647	O'ring G 31.5 x 3.2	GS 1	560129
7701040923	Arandela tapa bujía B 16 x 22 x 2.4 CN	CN	450229
7703061078	Arandela tapa válvulas A 7 x 17 x 1.5 FA	NB 3 3	550430
7700718380	Anillo termostato	GS 1 1	560131
	Guarnición sintético G 65 x 68 x 3.6	GS 1	560132
	Guarnición sintético G 65 x 73 x 5	GS 1	560133
	Arandelas especial B 22 x 28 x 3 CN	CN	560134
	Arandelas especial B 10 x 15 x 2.4 CN	CN	560135
	Arandela para llamas	AC 4 4	560036
	Arandela especial A 14.5 x 21 x 2 C	CU 4 4	560136
	Arandela A 12 x 17 x 1 C	CU	560137
7700859220	Bomba vacio	NB 1 1	560638
7700851849	Bomba vacio	NB 1 1	560639
7701046634	Bomba depresora Magnetti Marelli	GS 1	570345
7701045660	Bomba depresora Pierburg	GS 1	570346
7701030255	Jgo. cierre bancada (4)	GS 1	550658
7700724836	O'ring bomba vacío G 74 x 3	GS 1	
	Arandela A 10 x 15 x 1.5 A	AL 1	
	Arandela A 16 x 22 x 1.5 A	AL 1	
	Arandela A 18 x 24 x 1.5 A	AL 2	
	Arandela A 22 x 28 x 2 A	AL 1	
	Kit de retenes completo		R560700
	Jgo. retén válvulas (8)	V 1	R560110V
	Retén bancada 85 x 105 x 8	V 1	R560111V
	Retén distribución 42 x 54 x 6	V 1	R570412V
	Retén árbol levas 25 x 42 x 7	V 1	R560113V
	Retén auxiliar 22 x 45 x 7	P	R560114P

**RENAULT****taranto**

Motor/Engine

Cm<sup>3</sup>

HP

Ø

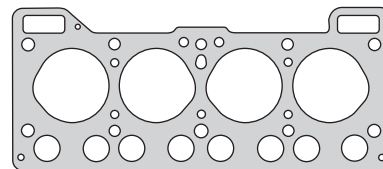
C1C 700/706  
C1E 688/752/756  
(OHV) 8V956  
110841  
45/4965  
70Renault: Express 1985/93, R9, R11 1981/89  
Super Cinco 1985/93

580207

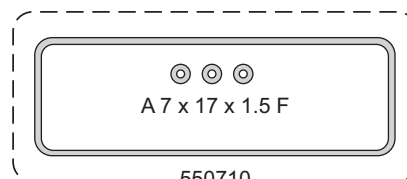

550710



550815

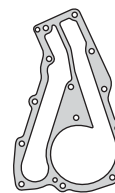

550714

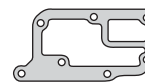

550719

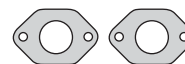

550725

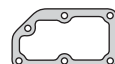

550331



550338



550737



06047



G 23.52 x 1.78

Nº OE	Descripción/Description	Mat.	Ref.
	Jgo. de juntas superior		580295
	Junta tapa cilindros Ø 72.0 ±1.30	NFT 1	580207
	Jgo. tornillos tapa cilindros (HAS17038)		B550400
	Conj. junta tapa válvulas (4)	N 1	550710
	Bomba de agua	NB 1	550714
	Múltiple escape	FCH 1	550815
	Bomba de agua a block	NB 1	550719
	Junta base carburador	NB 2	550725
	Arandela A 7 x 17 x 1.5 F	NB 3	550430
	Placa bomba de agua	NB 1	550331
	Placa bomba de agua	NB 1	550737
	Junta distribuidor	NB 1	550338
	Junta base carburador	NB 2	06047
	O´ring G 23.52 x 1.78	GS 1	



**RENAULT****taranto**

Motor/Engine

Cm³

HP

Ø

Renault: Clio 1991/97, R19 1989/96

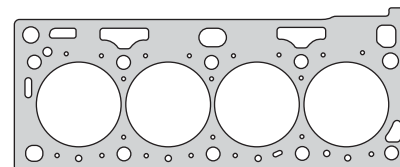
F7P 720/722  
F7P 700/704  
(DOHC) 16V1764  
1764135/140  
133/13782  
82

570107

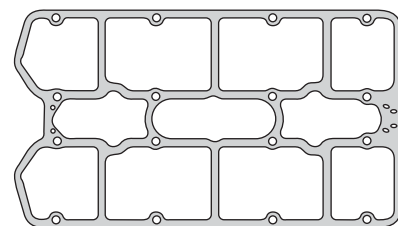

570110

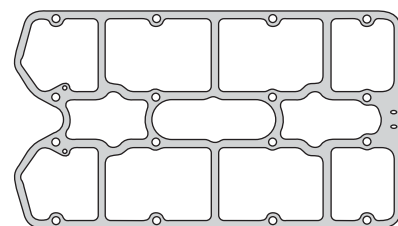

570136

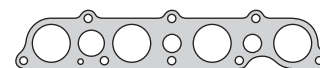

580415



580417



G 36 x 3



560131



A 8 x 11 x 1 C



R560113V

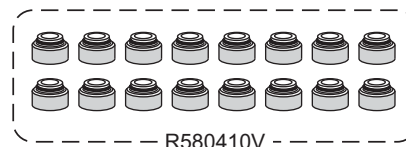

- R580410V -

Nº OE	Descripción/Description	Mat.	Ref.
	Jgo. de juntas superior		580495-R
	Junta tapa cilindros Ø 84.0 ± 1.30 <b>NR</b>	NFT	1 570107
	Jgo. tornillos tapa cilindros (HAT55055/55100)		B570100
	Junta tapa válvulas	NB	1 570110
	Termostato	NB	1 570136
	Múltiple escape	GS	1 560131
	Múltiple admisión	NFT	1 580415
	Múltiple admisión	NB	1 580417
	Arandela A 8 x 11 x 1 C	CU	2
	O'ring G 36 x 3	GS	1
	Kit de retenes completo		R580400
	Jgo. retén válvulas (16)	V	1 R580410V
	Retén árbol levas 25 x 42 x 7	V	2 R560113V

# RENAULT













Motor/Engine	Cm³	HP	Ø
810.02/05/09	1289	54/63	73
B130/B130S (OHV) 8V	1289	57	73

**Renault:** R12 1969/75, R12TS 1973/75  
R12, R15 1976/80, R5 1974/84  
Rodeo 1980/81, Estafette 1974/81

**Volvo:** 66 1973/76



Nº OE	Descripción/Description	Mat.	Ref.
	Jgo. de juntas superior		580595
	Junta tapa cilindros Ø 74.0 ± 1.30 	NFT 1	580507
	Jgo. tornillos tapa cilindros (HAS17038) 		B550400
	Conj. junta tapa válvulas (4) 	NB 1	550710
	Tapa bomba de agua 	NB 1	560214
	Bomba de agua 	NB 1	580514
	Múltiple escape 	NFT 1	550416
	Salida de escape 	FCH 1	550418
	Placa bomba de agua 	NB 1	560219
	Bomba de agua 	NB 1	580519
	Base carburador 	NB 2	550625
	Arandela A 7 x 17 x 1.5 FA	NB 3	550430
	Placa bomba de agua	NB 1	550331
	Placa bomba de agua	NB 1	550332
	Placa bomba de agua	NB 1	550737

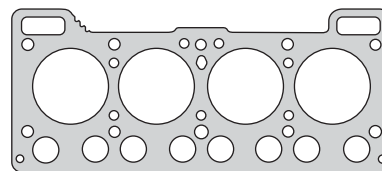

580507

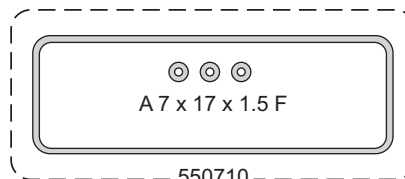

550710



550416



560214

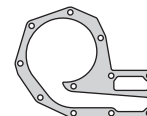

580514



550418

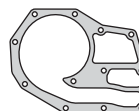

580519



560219

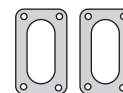

550625

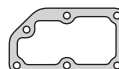

550331

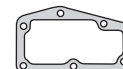

550332

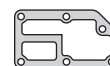

550737

**RENAULT****taranto**

Motor/Engine

Cm³

HP

Ø

C1J  
782/788/760/764  
(OHV) 8V

1289

57

76

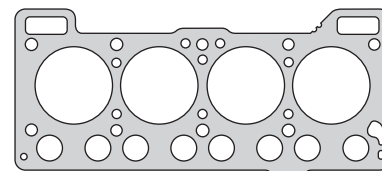
Renault: Super Cinco, R11, R9 Turbo  
1984/93

580607



550710



550815

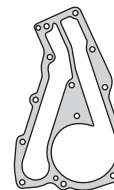

550714

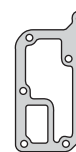

550719

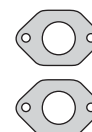

550725

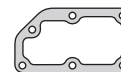

550331



550338

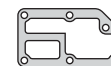

550737

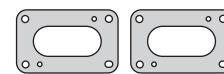

6047



G 23.52 x 1.78

Nº OE	Descripción/Description	Mat.	Ref.
	Jgo. de juntas superior		580695
	Junta tapa cilindros Ø 77.0 ± 1.95	NFT	1 580607
	Jgo. tornillos tapa cilindros (HAS17038)		B550400
	Conj. junta tapa válvulas (4)	NB	1 550710
	Bomba de agua	NB	1 550714
	Múltiple escape	FCH	1 550815
	Bomba de agua a block	NB	1 550719
	Junta base carburador	NB	2 550725
	Arandela A 7 x 17 x 1.5 F	NB	3 550430
	Placa bomba de agua	NB	1 550331
	Placa bomba de agua	NB	1 550737
	Junta distribuidor	NB	1 550338
	Junta distribuidor	NB	1 550738
	Junta base carburador	NB	2 6047
	O´ring G 23.52 x 1.78	GS	1

**RENAULT**



Motor/Engine	Cm³	HP	Ø
F8M 720/730/736/760 (SOHC) 8V Iny. Indirecta	1595	55	78
<b>DIESEL</b>			

Renault: Express 1987/96  
Super Cinco 1988/96  
R9, R11 1988/89



Nº OE	Descripción/Description	Mat.	Ref.
	Jgo. de juntas para motor		560601-R
7700867871	Junta tapa cilindros Ø 79.0 ±1.75	NFT	580707-1M
7701039396	Junta tapa cilindros Ø 79.0 ±1.65	NFT	580707-2M
7701039397	Junta tapa cilindros Ø 79.0 ±1.85	NFT	580707-3M
	Jgo. tornillos tapa cilindros (HAT55055/55100)		B560600
	Jgo. tornillos tapa cilindros (HAE14038)		B560600-1
7700743903	Conj. junta tapa válvulas (4)	N	560110
7700859751	Junta cárter para cárter de chapa	NFT	560111
8200105746	Frente motor para retén distribución	NB	560612
7700851213	Tapa bomba de agua	CB	560114
7700854867	Múltiple admisión y escape	FCH	560115
7700852434	Inferior árbol de levas	NB	560119
7701040923	Guarnición termostato	N	570319
	Arandela tapa bujía B 18 x 24 x 2.3 CN	CN	450029
7700736647	O'ring G 31.5 x 3.2	GS	560129
	Arandela tapa bujía B 16 x 22 x 2.4 CN	CN	450229
7703061078	Arandela tapa válvulas A 7 x 17 x 1.5 FA	NH	550430
7700718380	Anillo termostato	GS	560131
	Guarnición sintético G 65 x 68 x 3.6	GS	560132
	Guarnición sintético G 65 x 73 x 5	GS	560133
	Arandela para llamas	AC	560036
	Arandela A 14.5 x 21 x 2 C	CU	560136
7700859220	Bomba vacío	NB	560638
7700851849	Bomba vacío	NB	560639
	Arandela pico inyector	H	560641
7701030255	Jgo. cierre bancada (4)	GS	550658
	Arandela A 10 x 15 x 1.5 A	AL	
	Arandela A 22 x 28 x 2 A	AL	
	Arandela A 16 x 22 x 1.5 A	AL	
	Arandela A 18 x 24 x 1.5 A	AL	
7700724836	O'ring bomba vacío G 74 x 3	GS	
	Kit de retenes completo		R560600
	Jgo. retén válvulas (8)	V	R560110V
	Retén bancada 85 x 105 x 8	V	R560111V
	Retén distribución 50 x 68 x 10	V	R550612V
	Retén árbol levas 25 x 42 x 7	V	R560113V

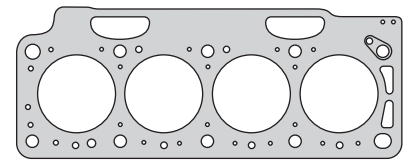

580707

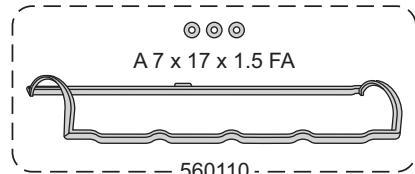

A 7 x 17 x 1.5 FA

560110

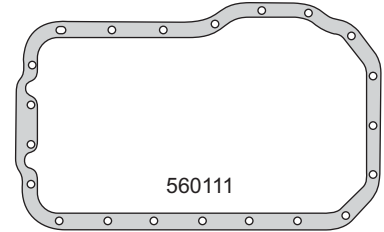

560111

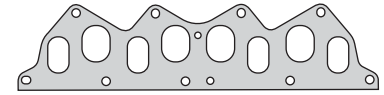

560115

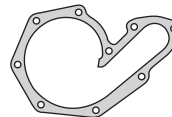

560114

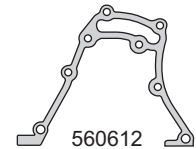

560612



560119



570319



560131



560036



560639



550658



560638



560641



G 65 x 68 x 3.6



G 31.5 x 3.2



G 65 x 73 x 5



G 74 x 3

A 18 x 24 x 1.5 A

A 16 x 22 X 1.5 A



A 14.5 x 21 x 2 C

A 10 x 15 x 1.5 A

A 22 x 28 x 2 A



R560111V



R550612V



R560113V



R560110V

# RENAULT



Motor/Engine	Cm³	HP	Ø
F8QT	1870	90	80
F8Q 740/741/768	1870	90/93	80
F8Q 784/786	1870	90/93	80
D19T - D4192T (SOHC) 8V	1870	90	80

**Mitsubishi:** Carisma TD 1997/...

**Renault:** R19DT 1991/96, Megane DT 1996/97, Scenic DT 1986/...

**Volvo:** 440TD, 460TD 1994/97, V40TD, S40TD 1996/99



DIESEL

Nº OE	Descripción/Description	Mat.	Ref.
	Jgo. de juntas para motor		580901-R
	Jgo. de juntas superior	●	580995-1M
	Jgo. de juntas superior		580995-2M
	Jgo. de juntas superior		580995-3M
	Junta tapa de cilin. Ø 80.7 $\pm$ 1.50	NFT 1	580107-1M
	Junta tapa de cilin. Ø 80.7 $\pm$ 1.40	NFT	580107-2M
	Junta tapa de cilin. Ø 80.7 $\pm$ 1.60	NFT	580107-3M
	Jgo. tornillos tapa cilindros (HAE14038)		B570300
7700743903	Conj. junta tapa válvulas (4)	N 1 1	560110
7700859751	Junta cárter para cárter de chapa	NFT 1	560111
7700851213	Tapa bomba de agua	CB 1	560114
8200105746	Junta frente motor porta reten distribución	NB 1	560612
7700854867	Múltiple admisión y escape	FCH 1 1	580915
7700852434	Inferior árbol de levas	NB 1 1	560119
7701040923	Guarnición termostato	N 1	570319
770062283	Bomba alimentación	NB	550628
	Arandela tapa bujía B 18 x 24 x 2.3 CN	CN 2	450029
7700736647	O'ring G 31.5 x 3.2	GS 1	560129
	Arandela tapa bujía B 16 x 22 x 2.4 CN	CN 2	450229
7703061078	Arandela tapa válvulas A 7 x 17 x 1.5 F	NH 3 3	550430
7700718380	Anillo termostato	GS 1 1	560131
	Guarnición sintético G 65 x 68 x 3.6	GS 1	560132
	Guarnición sintético G 65 x 73 x 5	GS 1	560133
	Arandela especial A 22 x 28 x 3 CN	CN 1	560134
	Arandela especial B 10 x 15 x 2.4 CN	CN 1	560135
	Arandela para llamas	AC 4 4	560036
	Arandela A 14.5 x 21.5 x 2 C	CU 4 4	560136
	Arandela A 12 x 17 x 1 C	CU	560137
7700859220	Bomba vacío	NB 1 1	560638
7700851849	Bomba vacío	NB 1 1	560639
7700724836	O'ring bomba vacío G 74 x 3	GS 1	
7701030255	Jgo. cierre bancada (4)	GS 1	550658
	Kit de retenes completo		R560600
	Jgo. retén válvulas (8)	V 1	R560110V
	Retén bancada 85 x 105 x 8	V 1	R560111V
	Retén distribución 50 x 68 x 10	V 1	R550612V
	Retén árbol levas 25 x 42 x 7	V 1	R560113V
	Retén auxiliar 22 x 45 x 7	P	R560114P

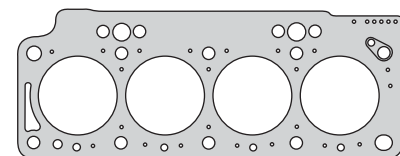

580107

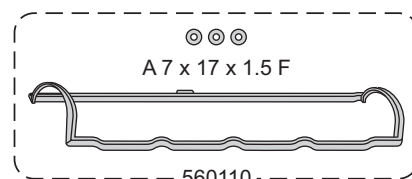

A 7 x 17 x 1.5 F

560110

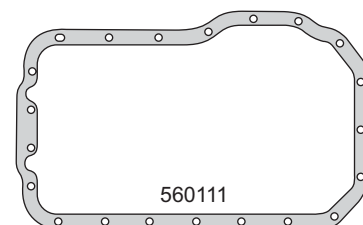

560111

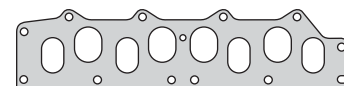

580915

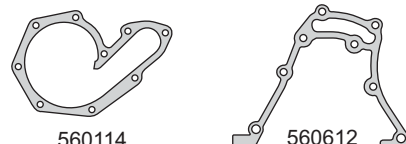

560114

560612



560119

570319

550628

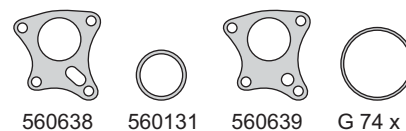

560638

560131

560639

G 74 x 3



A 14.5 x 21.5 x 2 C

A 12 x 17 x 1 C



G 31.5 x 3.2

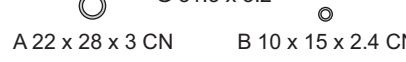

A 22 x 28 x 3 CN

B 10 x 15 x 2.4 CN



560036



B 18 x 24 x 2.3 CN

B 16 x 22 X 2.4 CN

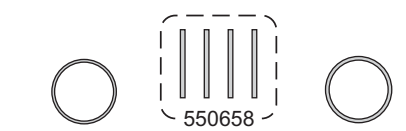

G 65 x 68 x 3.6

550658

G 65 x 73 x 5

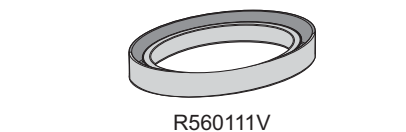

R560111V



R550612V

R560113V

R560114P



R560110V

**RENAULT**



Motor/Engine	Cm³	HP	Ø
D4D	999	68/70	69
D4D 700	1149	75	69
D4F 702/706/712			
D4F 714			
(DOHC) 16V			

**Renault:** Clio 2000/... - Kangoo 2003/...  
Clio II - Kangoo .../00 - Twingo  
Clio II - Kangoo 2001/...

**Peugeot:** 206 2000/...



Nº OE	Descripción/Description	Mat.	REF	REF	Ref.
7701473003	Jgo. de juntas para motor			●	581000-R MLS
	Jgo. de juntas para motor				581000-R
	Jgo. de juntas superior (MLS)			●	581095 MLS
	Jgo. de juntas superior				581095
	Jta. tapa cilindros Ø 70.0 $\pm$ 1.30	NFT			581005
	Jta. tapa cilindros Ø 70.0 $\pm$ 1.20	NFT			581007
	Jta. tapa cilindros Ø 70.0 $\pm$ 1.40	NFT			581007-1.40
8200086698	Jta. tapa cilindros Ø 70.0 $\pm$ 0.35	MLS	1	1	581008
	Jgo. tornillos tapa cilindros (HAE12038)				B581000
7701049888	Conj. junta tapa válvulas (5)	N	1	1	581010
8200303331/1	Junta para cárter	NB		1	581011
	Bomba de aceite	NB		1	581012
8200237224	Bomba de agua	SLS		1	581014
8200310867	Múltiple escape	AC	1	1	581015
7701475823	Jgo. múltiple admisión (4)	N	1	1	581017
7701049890	Tapa caja motorizada admisión	N	1	1	581031
	Salida de agua	GS		1	581034
7701473164	Jgo. anillo protección bujías (4)	P	1	1	581730
	Guarnición base filtro aceite bomba	N	1	1	581036
	Tapón árbol de levas	AC/N	1	1	581038
	Arandela tapón cárter A 16 x 22 x 1.5 C	CU		1	
	O´ring G 21.95 x 1.78	GS		1	
	Kit de retenes completo				R581000
	Jgo. retén válvulas - Hasta 2003 (16)	V		1	R581010V
	Jgo. retén válvulas - Desde 2004 (16)	V		1	R581710V
	Retén bancada 70 x 86 x 8	V		1	R570511V
	Retén distribución 32 x 44 x 6	V		1	R570512V
7701473495	Retén árbol de levas 28 x 47 x 5.5	V		1	R580013V

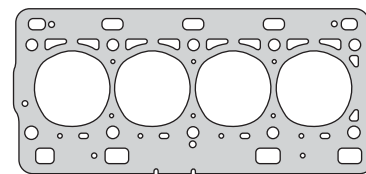

581008

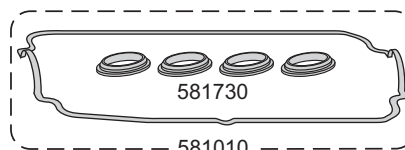

581730

581010

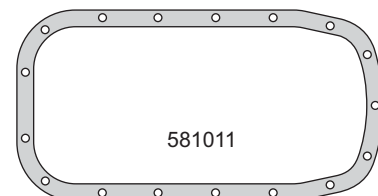

581011



581012



581014

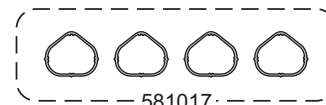

581017

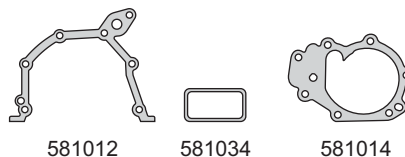

581012

581034

581014



581036



A 16 x 22 x 1.5 C



581038



G 21.95 x 1.78



R570511V



R570512V



R580013V

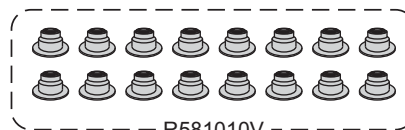

R581010V

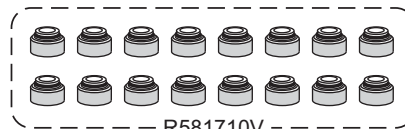

R581710V

**RENAULT**



Motor/Engine	Cm³	HP	Ø
K9K DCI (SOHC) 8V	1461	65/80	76

**Renault:** Clio II DCI 2001/... Series 700/702/704/710  
Kangoo DCI 2001/... Series 700/702  
Megane DCI 2002/... Series 722/728/729/704/710  
Symbol



DIESEL

Nº OE	Descripción/Description	Mat.	Ref.
	Jgo. de juntas para motor		581201-R
	Jgo. de juntas superior		581295-1M
	Jgo. de juntas superior		581295-2M
	Jgo. de juntas superior		581295-3M
	Jgo. de juntas superior (MLS)		581295 MLS
	Jgo. juntas superior sin JTC		581296
	Jta. tapa cilindros Ø 78.0 $\pm$ 1.20	NFT 1	581207-1M
	Jta. tapa cilindros Ø 78.0 $\pm$ 1.00	NFT	581207-2M
	Jta. tapa cilindros Ø 78.0 $\pm$ 1.40	NFT	581207-3M
8200071111	Jta. tapa cilindros Ø 77.5 $\pm$ 0.65	MLS	581208
7701473138	Jgo. tornillos tapa cilindros		B581200
8200117388	Junta tapa válvulas	N 1 1	581210
7700103687	Junta para cárter	N 1	570911
8800182129	Frente distribución	NB 1	581212
8200115278	Tapa bomba de agua	CB 1	581214
8200128551	Múltiple escape	AC 1 1	581215
	Anillo goma admisión G 31.3 x 35.6 x 3	GS 1	581217
	Salida de escape	AC 1 1	581218
	Descarga aceite turbo	NB 1	581236
7701047076	Anillo tapa llenado aceite G 45 x 49 x 5	GS 1	581237
8800073003	Bomba depresora	NB 1 1	581238
	Junta entrada turbo	NFT 1	581240
	Junta salida turbo catalizador	NFT 1	581241
	O´ring intermedio aceite G 59.92 x 3.53	GS 1 1	
	O´ring descarga G 17 x 2.6	S 1	
	O´ring tubo agua G 29.74 x 3.53	GS 1 1	
	O´ring entrada y salida tubo admisión G34.52 x 3.53	S 2	
	Anillo goma intermedio aceite G 64 x 69 x 5	GS 1	
	Arandela tapón cárter A 16 x 21 x 2 C	CU 1	
	Arandela pico inyector A 7.5 x 15 x 3 C	CU 4 4	
	O´ring G 18.72 x 2.62	GS 1	
	O´ring G 25.07 x 2.62	GS 1	
	O´ring G 36.17 x 2.62	GS 1 1	
	Kit de retenes completo		R581200
	Jgo. retén válvulas (8)	V 1	R581310V
7701473544	Retén bancada 80 x 100 x 8	V 1	R570011V
	Retén distribución 35 x 47 x 7	V 1	R550613V
	Retén árbol de levas 28 x 42 x 5	V 1	R570913V

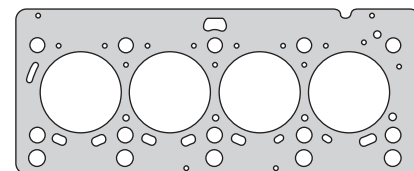

581207

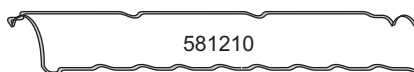

581210

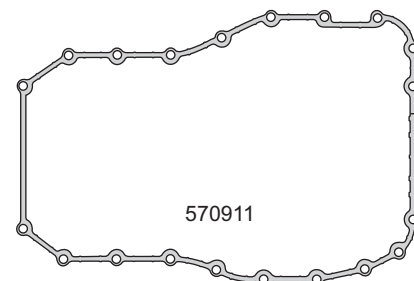

570911

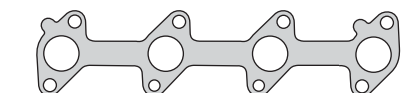

581215



581212

581217

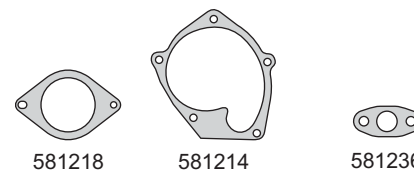

581218

581214

581236

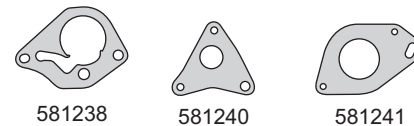

581238

581240

581241



G 18.72 x 2.62

G 25.07 x 2.62



G 29.74 x 3.53



G 17 x 2.6

G 36.17 x 2.62

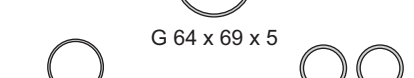

G 64 x 69 x 5



G 45 x 49 x 5

G 34.52 x 3.53

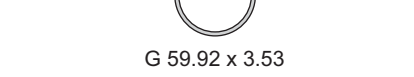

G 59.92 x 3.53



A 16 x 21 x 2 C

A 7.5 x 15 x 3 C



R550613V

R570011V

R570913V

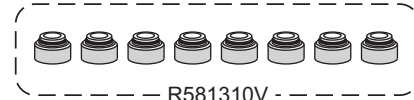

R581310V

**RENAULT**



Motor/Engine	Cm³	HP	Ø
K9K DCI (SOHC) 8V	1461	65/100	76

Renault: Megane II, Sandero DCI Serie 794  
Sandero Stepway DCI, Symbol DCI  
Logan 2006/...

DIESEL



Nº OE	Descripción/Description	Mat.	Ref.
	Jgo. de juntas para motor		581301-R
7701473371/1	Jgo. de juntas superior	●	581395-1M
	Jgo. de juntas superior		581395-2M
	Jgo. de juntas superior		581395-3M
	Jgo. de juntas superior (MLS)		581395 MLS
	Jta. tapa cilindros Ø 78.0 $\pm$ 1.20	NFT 1	581307-1M
	Jta. tapa cilindros Ø 78.0 $\pm$ 1.00	NFT	581307-2M
	Jta. tapa cilindros Ø 78.0 $\pm$ 1.40	NFT	581307-3M
8200351353	Jta. tapa cilindros Ø 77.5 $\pm$ 0.65	MLS	581308
7701473138	Jgo. tornillos tapa cilindros (HAE16038)		B581200
8200117388	Junta tapa válvulas	GS 1 1	581210
8200379654	Junta para cárter	GS/AC 1	581311
8800182129	Frente distribución	NB 1	581212
8200115278	Tapa bomba de agua	CB 1	581214
8200414346	Múltiple escape	AC 1 1	581315
	Anillo goma admisión G 31.3 x 35.6 x 3	GS 1 1	581217
	Salida de escape	AC 1 1	581218
	Descarga aceite turbo	NB 1 1	581236
8800073003	Bomba depresora	NB 1 1	581238
	Junta entrada turbo	NFT 1 1	581240
	Junta salida turbo catalizador	NFT 1 1	581241
	O´ring intermedio aceite G 59.92 x 3.53	GS 1	
	O´ring descarga G 17 x 2.6	S 1 1	
	O´ring tubo agua G 29.74 x 3.53	GS 1	
	O´ring entrada y salida tubo admisión G 34.4 x 3.2	S 2 2	
	O´ring entrada aceite a turbo G 16 x 3	GS	
	Anillo goma intermedio aceite G 64 x 69 x 5	GS 1 1	
7701047876	Anillo goma G 45 x 49 x 5	GS 1 1	
	Arandela tapón cárter A 16 x 21 x 2 C	CU 1	
	Arandela pico inyector A 7.5 x 15 x 3 C	CU 4 4	
7701473544	O´ring G 36.17 x 2.62	GS 1	
	O´ring G 18.72 x 2.62	GS 1	
	O´ring G 25.07 x 2.62	GS 1	
	Kit de retenes completo		R581200
	Jgo. retén válvulas (8)	V 1	R581310V
	Retén bancada 80 x 100 x 8	V 1	R570011V
	Retén distribución 35 x 47 x 7	V 1	R550613V
	Retén árbol de levas 28 x 42 x 5	V 1	R570913V

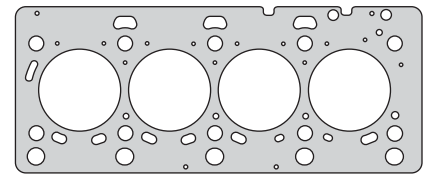

581308

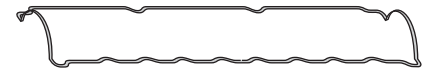

581210

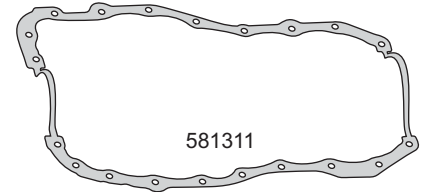

581311



581315



581212



581217

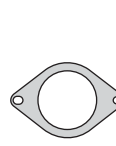

581218

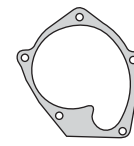

581214



581236



581238

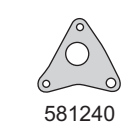

581240

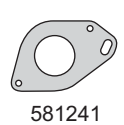

581241



G 17 x 2.6

G 29.74 x 3.53

G 36.17 x 2.62

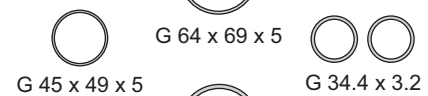

G 45 x 49 x 5

G 64 x 69 x 5

G 34.4 x 3.2



G 59.92 x 3.53



A 16 x 21 x 2 C



A 7.5 x 15 x 3 C

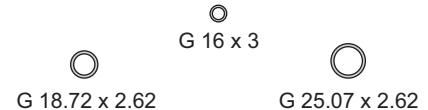

G 16 x 3

G 18.72 x 2.62

G 25.07 x 2.62

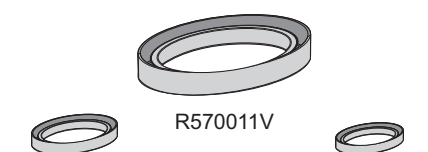

R570011V

R550613V

R570913V

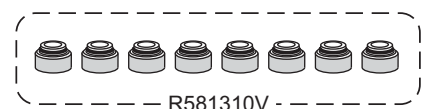

R581310V



**RENAULT**



Motor/Engine	Cm³	HP	Ø
G8T D/TD (SOHC) 12V	2188	85/115	87

**Renault:** Laguna D 706/790 1996/...  
Laguna TD 752/792/794 1996/...  
Laguna TD 760/740 1997/...

DIESEL



Nº OE	Descripción/Description	Mat.	Ref.
7701469669	Jgo. de juntas para motor		581400-R
	Jgo. de juntas superior		581495
7700872860E	Jta. tapa cilindros Ø 88.0 ± 1.80 NRT	NFT 1 1	581407
	Jgo. tornillos tapa cilin. (HAT55055/55100)		B581400
7700858850	Junta tapa válvulas	N 1 1	581410
7700857225	Junta para cárter	N 1 1	581411
	Múltiple escape	AC 1 1	581415
	Múltiple admisión	NB 1 1	581417
	Entre colectores admisión	NB 1 1	581431
	E.G.R.	AC 3 3	581432
	Tapa trasera tapa de cilindros	NH 1 1	581433
	Arandela parallamas	AC 4 4	560036
	O'ring G 50.52 x 1.78	GS 1	
	Arandela inyector A 16 x 21 x 1.50 C	CU 4 4	
	Kit de retenes completo		R581400
7700658325	Jgo. retén válvulas (12)	V 1	R581410V
7700859266	Retén bancada 93 x 108 x 7	V 1	R581411V
7700857118	Retén distribución 45 x 57 x 7	V 1	R581412V
7700857117	Retén árbol de levas 33 x 44 x 7	V 2	R581413V

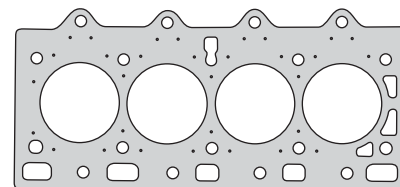

581407



581410

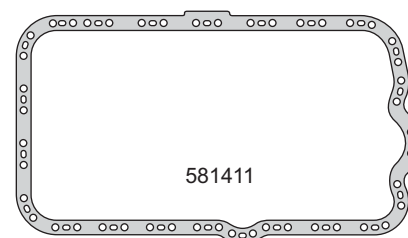

581411



581415



581417

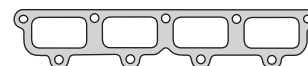

581431



581432

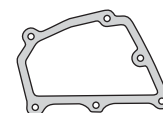

581433



560036



G 50.52 x 1.78



A 16 x 21 x 1.50 C



R581411V



R581412V



R581413V

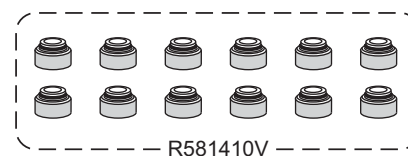

R581410V

**RENAULT**



Motor/Engine	Cm³	HP	Ø
D4F 728 D4F 708 (SOHC) 16V	1149	75	69

Renault: 728 - Clio II 2005/...  
708 - Twingo 2004/...



Nº OE	Descripción/Description	Mat.	Ref.
	Jgo. de juntas para motor		581700-R MLS
7701475822	Jgo. de juntas superior (MLS)	●	581795 MLS
	Jgo. de juntas superior (MLS)		581795
	Jta. tapa cilindros Ø 70.0 $\pm$ 1.30	NFT	581005
	Jta. tapa cilindros Ø 70.0 $\pm$ 1.20	NFT	581007
	Jta. tapa cilindros Ø 70.0 $\pm$ 1.40	NFT	581007-1.4
8200151984	Jta. tapa cilindros Ø 70.0 $\pm$ 0.35	MLS	1 1 581008
	Jgo. tornillos tapa cilindros (HAE12038)		B581000
7701059314	Conj. junta tapa válvulas (5)	GS	1 1 581710
8200303331/1	Junta para cárter	NB	1 581011
	Bomba de aceite	NB	1 581012
8200233224	Bomba de agua	SLS	1 581014
8200310867	Múltiple escape	AC	1 1 581015
7701475823	Jgo. múltiple admisión (4)	N	1 1 581017
7701473164	Jgo. anillo protección bujías (4)	P	1 1 581730
	Junta sobre tapa válvulas	N	1 1 581031
	Salida bomba de agua	GS	1 581034
7701049890	Tapa caja motorizada delantera	GS	1 1 581036
	Arandela tapón cárter A 16 x 22 x 1.5 C	CU	1
	O´ring G 18.77 x 1.78	GS	1
	O´ring G 21.95 x 1.78		
	Kit de retenes completo		R581700
8200171215	Jgo. retén válvulas (16)	V	1 R581710V
7701473493	Retén bancada 70 x 86 x 8	V	1 R570511V
7701473494	Retén distribución 32 x 44 x 6	V	1 R570512V
7701473495	Retén auxiliar 28 x 47 x 5.5	V	1 R580013V

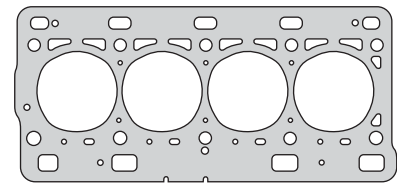

581008

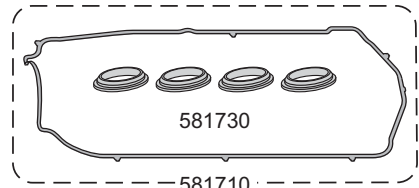

581730

581710

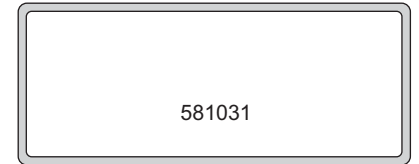

581031

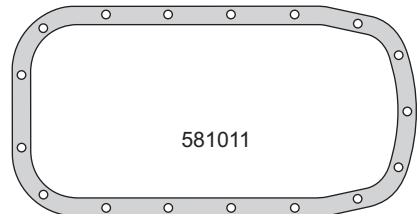

581011



581015

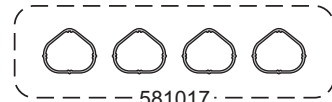

581017

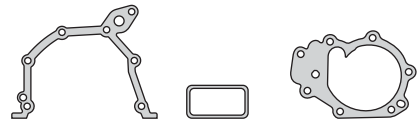

581012

581034

581014



581036

G 18.77 x 1.78

G 21.95 x 1.78



A 16 x 22 x 1.5 C



R570511V



R570512V



R580013V

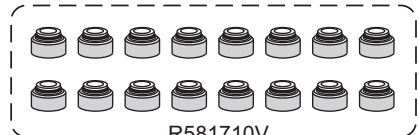

R581710V

# RENAULT



Motor/Engine	Cm³	HP	Ø
G9U-720/724/730	2463	115	88.8
G9U-750/754	2463	115	88.8
G9U-730	2484	90	88.8
G9U-720/724/750 (DOHC) 16V	2499	90	88.8

**Nissan:** Primastar, Interstar 2002/...  
**Renault:** Master 2001/..., Trafic 2003/...



DIESEL

Nº OE	Descripción/Description	Mat.	Ref.
	Jgo. de juntas para motor		581800-R MLS
7701477813	Jgo. de juntas superior (MLS)		581895 MLS
	Jta. tapa cilindros Ø 90.0 $\pm$ 1.30	NFT	581807
8200406743	Jta. tapa cilindros Ø 90.0 $\pm$ 1.20	MLS	581808
	Jgo. tornillos tapa cilindros (HAE18038)		B581800
7701472450	Conjunto junta tapa válvulas (9)	GS	581810
7700857225	Junta para cárter	GS	581411
8200265414	Tapa distribución	NB	581812
8200265416	Placa distribución	NB	581813
8200265416	Bomba de agua	SLS	581814
8200459643	Múltiple escape	AC	581815
7701472449	Jgo. guarnición admisión (8)	P	581817
7701040923	Guarnición termostato	GS	570319
7703065315	Guarnición goma	GS	581827
7701064298	Guarnición goma	GS	581829
	Arandela tapa de válvulas	GS	581830
7701048678	Guarnición metálica	P	581836
8200008387	Anillo con pestañas G 41 x 30	AC	581837
7700100987	Tapón ciego G 63.2 x 6	AC/N	581838
7703075328	Tapón ciego G 43 x 9	AC/N	581839
	Guarnición tapa válvulas	GS	581842
7701049483	O´ring G 68 x 2	N	581812
	O´ring G 50.52 x 1.78	P	581827
7701048962	O´ring G 45 x 3	GS	581814
7700864738	O´ring G 37.69 x 3.53	P	581812V
	O´ring G 32 x 4	N	581811V
7701049488	O´ring G 16 x 2	N	581812V
7701471140	O´ring G 6 x 2	S	R260113V
	O´ring G 15.54 x 2.62	N	581813V
	O´ring G 20.3 x 2.62	N	
	O´ring G 17.17 x 1.78	T	
	Arandela A 10 x 13 x 2.5 C	CU	
	Arandela pico inyector A 7 x 15 x 3 C	CU	
	Arandela tapón cárter A 16 x 22 x 1.5 A	AL	
	Kit de retenes completo		R581800
	Jgo. retén válvulas (16)	V	R581810V
7700859266	Retén bancada trasera 93 x 108 x 7	V	R581811V
7700103945	Retén distribución 60 x 75 x 7	V	R581812V
7700101348	Retén árbol de levas 30 x 42 x 7	V	R260113V
7700103946	Retén auxiliar distribución 70 x 85 x 7	V	R581813V

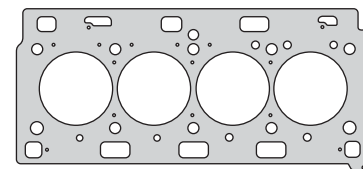

581808

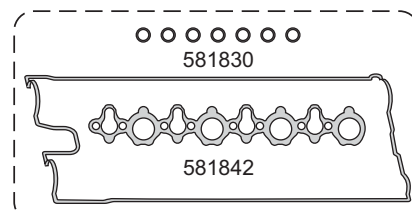

581830

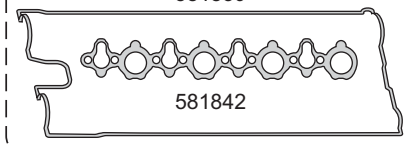

581842

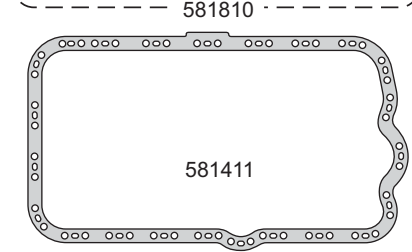

581810



581815



581817

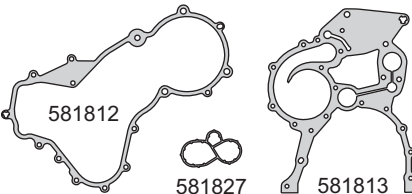

581812

581827

581813



581814

570319

581829



581838

581839

581837

581836

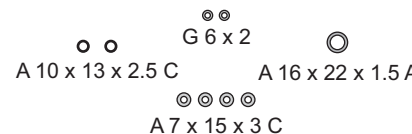

G 6 x 2

A 10 x 13 x 2.5 C

A 16 x 22 x 1.5 A

A 7 x 15 x 3 C



G 45 x 3

G 50.52 x 1.78

G 68 x 2



G 37.69 x 3.53

G 32 x 4

G 20.3 x 2.62



G 15.54 x 2.62

G 16 x 2

G 17.17 x 1.78



R581811V



R581812V

R260113V

R581813V



R581810V

**RENAULT**



Motor/Engine	Cm <sup>3</sup>	HP	Ø
2TR (DOHC) 16V	2488	170	89

Renault: Koleos 4x2/4x4



Nº OE	Descripción/Description	Mat.	Ref.
	<b>Jgo. de juntas para motor</b>		● 582100-R MLS
	Junta tapa cilindros Ø 90.0 $\pm$ 1.20	NFT	903507
11044-ET80A	Junta tapa cilindros Ø 89.5 $\pm$ 0.65	MLS	1 903508
11056AR202	Jgo. tornillos tapa cilindros (HAH10055/10100)		B903500
	Sellador líquido - caucho de silicona		TRN0085G
13270-JG30A	Junta tapa válvulas	GS	1 582110
	Múltiple escape	AC	1 582115
14035-JG35A	Múltiple admisión	SLS	1 582117
14035-JA05A	Múltiple admisión	GS	1 582117-1
14036-JA00A	Salida de escape	AC	1 582118
	Bomba de agua	SLS	1 903514
	Termostato	SLS	1 903519
	Base filtro aceite	SLS	1 582127
	Junta	SLS	1 903531
	Junta	SLS	1 903532
	O´ring G 7.52 x 3.53	S	4
16618-AX200	O´ring G 8 x 3	V	
	O´ring G 12.37 x 2.62	GS	1
	O´ring G 17.12 x 2.62	GS	2
	O´ring G 18 x 3	GS	1
	O´ring G 24.99 x 3.53	GS	1
	O´ring G 34.52 x 3.53	GS	1
	O´ring G 32 x 3	GS	1
	O´ring G 20.3 x 2.62	GS	1
	Kit de retenes completo		R582100
1320784A00	Jgo. retén válvulas (16)	P	1 R903510P
12279-AD200	Retén bancada 84 x 104 x 11	P	1 R902111P
13510-0Z400	Retén distribución 46 x 58 x 7	P	1 R902512P

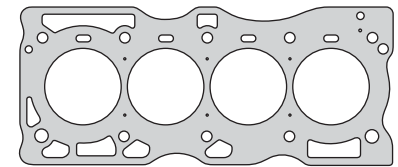

903508

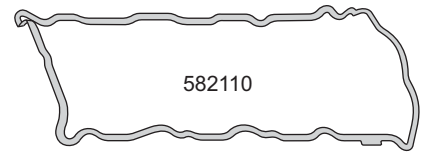

582110



582115



582117



582117-1



582118



903514



903519

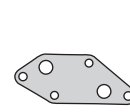

582127



903531

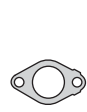

903532



G 7.52 x 3.53



G 12.37 x 2.62



17.12 x 2.62



G 8 x 3



G 24.99 x 3.53



G 20.3 x 2.62



G 34.52 x 3.53



G 18 x 3



G 32 x 3



R902111P



R902512P

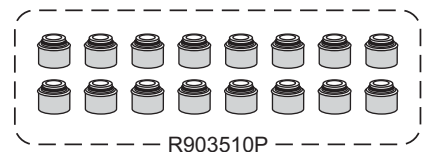

R903510P

**RENAULT**



Motor/Engine Cm³ HP Ø

M4R 714 (DOHC) 16V 1998 84

Renault: Fluence, Megane III 2011/...



Nº OE	Descripción/Description	Mat.			Ref.
	Jgo. de juntas para motor			●	582200-R MLS
	Jgo. de juntas superior		●		582295 MLS
	Jta. tapa cilindros Ø 85.0 ± 1.20	NFT			903407
10101-EN	Jta. tapa cilindros Ø 84.5 ± 0.48	MLS	1	1	903408
11056-EN200	Jgo. tornillos tapa cilin. (HAH10055/10100)				B903400
13270-ET000	Junta tapa válvulas	GS	1	1	903410
	Junta cárter inferior	NB		1	582211
21014-ET00A	Bomba de agua	SLS	1	1	903414
14036-ED800	Múltiple escape	MLS	1	1	903415
16121-16900	Múltiple admisión	SLS	1	1	582217
20695-8H310	Salida de escape	GFT			903418
20695-ED10A	Salida de escape a catalizador	GFT			903418-1
11062-ET00A	Salida agua base termostato	SLS		1	903419
20691-77A00	Salida de catalizador a silenciador	CHA			903428
16175-EL00A	Guarnición goma	GS	1	1	903430
13050-ET000	Guarnición termostato	GS		1	903432
21049-ET01A	Guarnición goma entrada agua	GS			903433
21049-6N220	Sello goma	GS			903434
15066-EN200	O´ring G 20.30 x 2.62	GS		1	
22131-ED000	O´ring G 16 x 2.5	GS			
	O´ring G 13.11 x 2.62	GS		1	
15066-4W000	O´ring G 9.19 x 2.62	GS		1	
16618-FU460	O´ring G 7.52 x 3.53	GS	8	8	
	Arandela A 20 x 26 x 1 A	AL		1	
	Arandela especial A 11.5 x 17.5 x 4 C	CU			
	Kit de retenes completo				R903400
13207-ET000	Jgo. retén válvulas (16)	P		1	R902110P
12279-ET000	Retén bancada trasera 84 x 117 x 8.5	V		1	R903411V
13510-6N200	Retén frente motor 46 x 58 x 7	P		1	R902512P

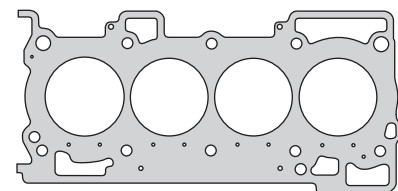

903408

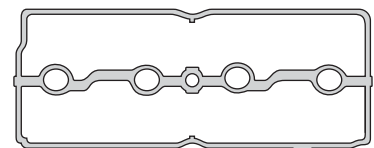

903410

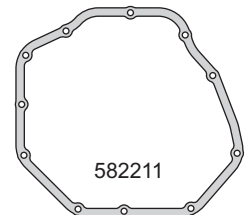

582211



903415



582217



903414

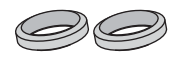

903418-1



903418



903428

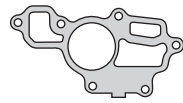

903419



903430



903433



903434



903432



G 20.30 x 2.62



A 20 x 26 x 1 A



A 11.5 x 17.5 x 4 C



G 7.52 x 3.53



G 9.19 x 2.62



G 13.11 x 2.62



G 16 x 2.5



R902512P



R903411V

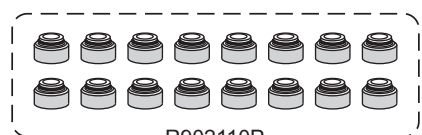

R902110P

**RENAULT**



Motor/Engine	Cm³	HP	Ø
M9R 700/740	1995	150	84
M9R 780/782/784	1995	114	84
M9R 786/88 (DOHC) 16V	1995	90	84

**Opel** Vivaro CDTI 2006/08 - 2008/...  
**Renault:** Espace IV 2006/..., Laguna II .../2005  
 Megane II 2006/10, Koleos

DIESEL



Nº OE	Descripción/Description	Mat.	Ref.
	Jgo. de juntas para motor		● 582300-R MLS
	Junta tapa cilindros Ø 85.0 $\pm$ 1.20	NFT	582307
	Junta tapa cilindros Ø 85.0 $\pm$ 0.80	MLS 1	582308
	Jgo. tornillos tapa cilindros (HAE18038)		B581800
	Sellador líquido - caucho de silicona		TRN0085G
	Conj. junta tapa válvulas (6)	GS 1	582310
	Bomba de agua G 64 x 3	GS 1	582314
	Múltiple escape	AC 1	582315
	Múltiple admisión	SLS 1	582317
	Salida de escape	AC 2	582318
	Junta termostato	GS 1	582319
	Junta bomba de aceite G 54 x 3	GS 1	582327
	Junta	SLS 1	582328
	Guarnición goma	GS 2	582330
	Guarnición goma	GS 2	582331
	Guarnición goma	GS 1	582332
	Junta	AC 1	582334
	Junta válvula EGR	AC 2	582335
	Arandela A 8.4 x 17 x 1.2 A	AL 4	
	O´ring G 3 x 1.60	GS 4	
	O´ring G 18 x 3	GS 1	
	Jgo. retén válvulas (16)	V 1	R582310V
	Porta retén bancada	T	PR582311T
	Porta retén distribución	T	PR582312T

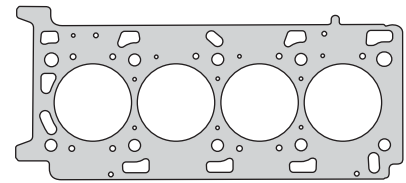

582308

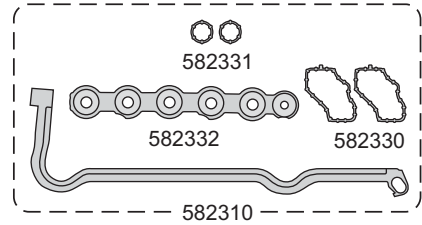

582331

582332

582330

582310



582315

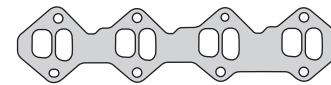

582317



582314



582318



582319



582327



582328



582334



G 18 x 3

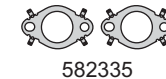

582335



G 3 x 1.60

●●●●●  
A 8.4 x 17 x 1.20 A

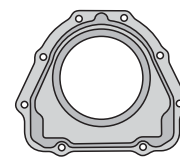

PR582311T



PR582312T

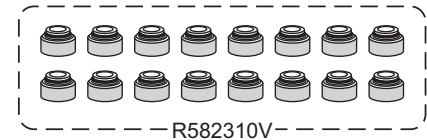

R582310V

**RENAULT**



Motor/Engine	Cm³	HP	Ø
M9T 670/676	2298	125	85
M9T 690/692	2298	125	85
M9T 680/698 (DOHC) 16V	2298	146	85

Renault: Master III DCI 2010/...

DIESEL

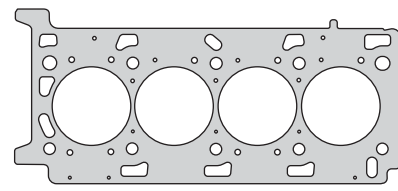

582408

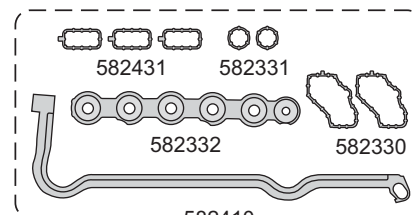

582410



582415

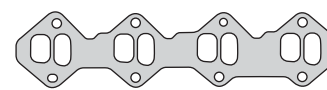

582317



582418

582419

582427

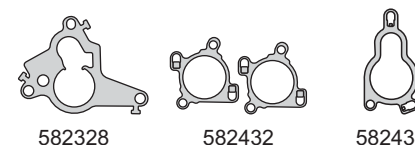

582328

582432

582434



582433

582441

582442



582445

G 62 x 3.20

582446

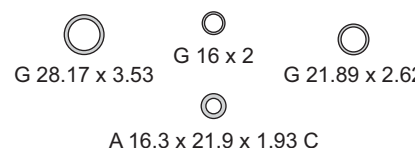

G 28.17 x 3.53

G 16 x 2

G 21.89 x 2.62

A 16.3 x 21.9 x 1.93 C



A 7 x 14 x 1 A

G 54 x 3

G 3 x 1.50

G 20 x 3

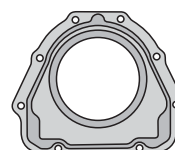

PR582311T



PR582312T

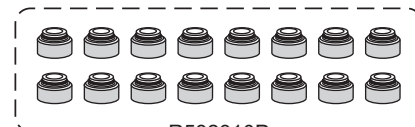

R582310P

Nº OE	Descripción/Description	Mat.	Ref.
	Jgo. de juntas para motor		● 582400-R MLS
	Junta tapa cilindros Ø 86.0 $\pm$ 1.20	NFT	582407
	Junta tapa cilindros Ø 86.0 $\pm$ 1.00	MLS	1 582408
	Jgo. tornillos tapa cilindros (HAE18038)		B581800
	Sellador líquido - caucho de silicona		TRN0085G
	Conj. junta tapa válvulas (9)	GS	1 582410
	Bomba de agua G 64 x 3	GS	1 582314
	Múltiple escape	AC	1 582415
	Múltiple admisión	SLS	1 582317
	Salida de escape	AC	1 582418
	Junta termostato	GS	1 582419
	Junta bomba de aceite	GS	1 582427
	Junta bomba vacío	SLS	1 582328
	Guarnición goma	GS	2 582330
	Guarnición goma	GS	2 582331
	Guarnición goma	GS	3 582431
	Guarnición goma	GS	1 582332
	Junta válvula EGR	AC	2 582432
	Junta válvula EGR	AC	2 582433
	Junta válvula EGR	AC	1 582434
	Junta refrigeración de turbo	SLS	1 582441
	Junta turbo	FCH	1 582442
	Colector escape a turbo	FCH	1 582445
	Junta turbo	FCH	1 582446
	Arandela A 7 x 14 x 1 A	AL	4
	Arandela espiralada A 16 x 22 x 2 C	CU	1
	O´ring G 3 x 1.50	GS	3
	O´ring G 16 x 2	GS	1
	O´ring G 20 x 3	GS	2
	O´ring G 21.89 x 2.62	GS	1
	O´ring G 28.17 x 3.53	GS	1
	O´ring G 54 x 3	GS	1
	O´ring G 62 x 3.20	GS	2
	Jgo. retén válvulas (16)	P	1 R582310P
	Porta retén bancada	T	PR582311T
	Porta retén distribución	T	1 PR582312T



## Junta Tapa de Cilindros Taranto.











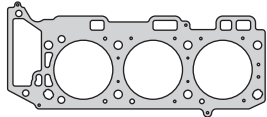
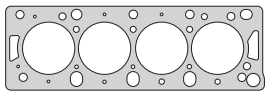

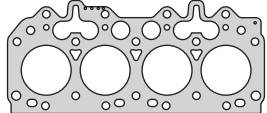

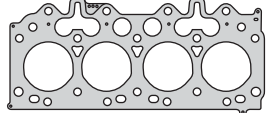

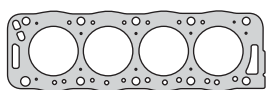

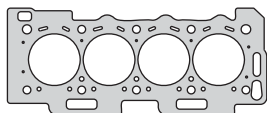
Las juntas están diseñadas para superar las exigencias de presión y temperatura que producen los motores de última generación.

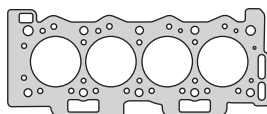
- Eliminación del retorque en juntas 07 y 08.
- Mayor resistencia mecánica y térmica.
- Compuestos sellantes especiales que aseguran la máxima estanqueidad.
- Superficie sellante antiadherente que no daña las partes metálicas del motor.
- Ahorro de mano de obra, evita trabajos adicionales.
- Utilización de materiales ecológicos.

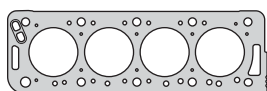

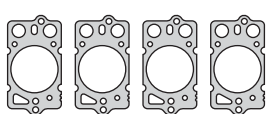

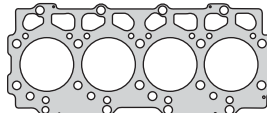





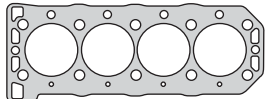

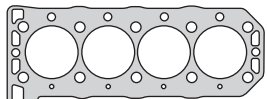

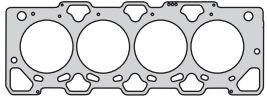

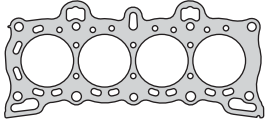

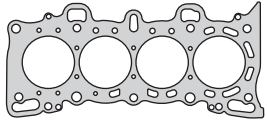

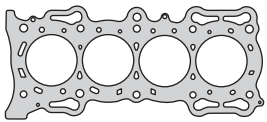

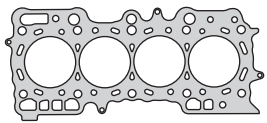

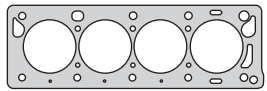
**MOTORES NAFTA Y DIESEL / PETROL AND DIESEL ENGINES**

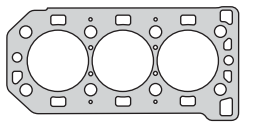
	<b>Código Code</b>	<b>Q</b>	$\neq$	<b>Kit Bulón Bolt Set</b>	<b>Aplicación Application</b>	<b>Motor Engine</b>	<b>Juego</b>
	323508	100.2	0.73		Discovery III 4x4 2004/09	<b>4009cc.</b> 406PN 212HP - 40VSER 214HP (SOHC) V6 12V Ø100.4	
	420607	86.0	1.50	<b>B420600</b>  HAS15038	Maestro D/TD 1986/95 Montego TD 1988/95 <b>DIESEL</b>	<b>1994cc.</b> Prima 65/80T 64/80HP Ø84.5	<b>420600-R</b>  pág. 380
	430007	92.0 92.0 92.0 92.0	1.40 1.50 1.60 1.70	<b>B430000</b> <b>B430000-1</b>  HAS19038	Range Rover TDI, Discovery TDI Defender TDI 1990/94 - 1994/98 <b>DIESEL</b>	<b>2495cc.</b> 200/300 TDI 112HP Ø90.5	<b>430001-R</b>  pág. 365
	430008	92.0 92.0 92.0	1.20 1.30 1.40	<b>B430000</b> <b>B430000-1</b>  HAS19038	Range Rover TDI, Discovery TDI Defender TDI 1990/94 - 1994/98 <b>DIESEL</b>	<b>2495cc.</b> 200/300 TDI 112HP Ø90.5	<b>430001-R</b>  pág. 365
	460307	84.0 84.0 84.0 84.0	1.50 1.60 1.70 1.80	<b>B460300</b>  HAT55055 HAT55100	218, 418 1991/96 <b>DIESEL</b>	<b>1905cc.</b> XUD9A 67HP Ø83 (SOHC) 8V	<b>460301-R</b> <b>460300-R-1M</b> <b>460300-R-2M</b> <b>460300-R-3M</b>  pág. 418
	470307 - 470308	78.0 78.0	1.80 1.60	<b>B470300</b>  HAE14038	115TD 1995/98 <b>DIESEL</b>	<b>1527cc.</b> TUD5 (VJZ) 58HP Ø77 (SOHC) 8V	<b>470300-R</b>  pág. 430
	470407 - 470408	76.0 76.0	1.80 1.60	<b>B470400</b>  HAE14038	114, Metro 1992/94	<b>1361cc.</b> TUD3 (K9A) 52HP Ø75 (SOHC) 8V	<b>470400-R</b>  pág. 431
	470707	82.0 82.0	1.65 1.80	<b>B470700</b>  HAT55055 HAT55100	218 TD, 418 TD 1991/96 Tourer TD 1996/... <b>DIESEL</b>	<b>1769cc.</b> XUD7T/TE 88HP Ø80 (SOHC) 8V	<b>460301-R</b> (470700)  pág. 434
	500507	98.0 98.0 98.0	1.55 1.80 1.60		Range Rover TD 1986/89 Range Rover TD 1989/92	<b>2393cc.</b> VM492HT 113HP Ø92 <b>2499cc.</b> HR924HR 121HP Ø92	<b>500401</b>  pág. 521
	520307 - 520308	98.0 98.0 98.0 98.0 98.0 98.0	1.40 1.50 1.60 1.42 1.52 1.62	<b>B520300</b>  HAN12055 HAN12100	825 TD 1996/99	<b>2499cc.</b> VM425TD 121HP Ø92	<b>520301-R</b>  pág. 522

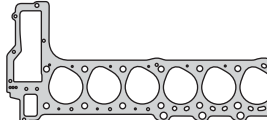
## MOTORES NAFTA Y DIESEL / PETROL AND DIESEL ENGINES

	Código Code	Q	$\approx$	Kit Bulón Bolt Set	Aplicación Application	Motor Engine	Juego
<b>860007 - 860008</b> 	860007 860008	83.0 82.5	1.80 0.41	B860000  HAE12038	Metro, 111 1990/94, 111 1995/98 Metro, 114/214 1990/94 - 1995/99	<b>1120cc.</b> 11K2A/D 60HP Ø75 <b>1396cc.</b> 14K2A/D 75HP Ø75 (SOHC) 8V	<b>860000-R</b>  pág. 517
<b>860007 - 860008</b> 	860007 860008	83.0 82.5	1.80 0.41	B860000  HAE12038	214/414 1995/99, 25, 45 1999/... 216/416 1996/99, 25, 45 1999/... 200 Vi 218 Coupe 1995/...	<b>1396cc.</b> 14K16 103HP Ø75 <b>1589cc.</b> K16 111HP Ø80 <b>1796cc.</b> 18K16 120/145HP Ø80 (DOHC) 16V	<b>860100-R</b>  pág. 518
<b>860207 - 860208</b> 	860207-1M 860207-2M 860207-3M 860208-1M 860208-2M 860208-3M	86.0 86.0 86.0 86.0 86.0 86.0	1.05 1.20 1.40 1.10 1.20 1.35	B860200  HAE14038	Freelander TCIE 1997/00, 620 1995/99 420TD, 220TD, 620TD 1995/99, 25TD 45TD 1999/... <b>DIESEL</b>	<b>1994cc.</b> 20T 8V 97HP 20T2N 105HP Ø84.5	<b>860201-R</b>  pág. 19
<b>860307</b> 	860307	76.5	1.30	B860300  HAS14038	216/416 1989/92	<b>1590cc.</b> D16A7 116HP Ø75 (SOHC) 16V	<b>860300-R</b>  pág. 20
<b>860407 - 860408</b> 	860407 860408	76.0 76.0	1.30 0.70	B860400  HAS14038	216/416 1992/94	<b>1590cc.</b> D16A6 16V 111HP Ø75	<b>860400-R</b>  pág. 21
<b>860808</b> 	860808	86.0	1.20		618 1996/99 620, 620 Si 1993/97	<b>1850cc.</b> F18A3 115HP Ø85 <b>1997cc.</b> F20Z1 131HP - F20Z2 115HP (SOHC) 16V Ø85	<b>860800-R</b>  pág. 25
<b>861008</b> 	861008	87.5	1.35		623 1993/97	<b>2259cc.</b> H23A3 158HP Ø87 (DOHC) 16V	<b>861000-R</b>  pág. 27
<b>890607</b> 	890607	88.6	1.70		820, 820i, 820Si 1986/90 Inyección Multipunto	<b>1994cc.</b> 20HD - M16 103/120HP Ø84.45 (DOHC) 16V	<b>890600-R</b>  pág. 519
<b>912008</b> 	912008	82.5	0.40		825 1996/...	<b>2497cc.</b> KV6 175HP Ø80 (DOHC) 24V	<b>912000-R MLS</b>  pág. 110
<b>981207</b> 	981207-2M 981207-3M	81.0 81.0	1.68 1.87	B980200  HAE16038	Range Rover Turbo 1994/02 <b>DIESEL</b>	<b>2498cc.</b> D256TM 136HP Ø80	<b>981201-R</b>  pág. 08

**ROVER****taranto**

Motor/Engine

Cm³

HP

Ø

11K2A/D  
14K2A/D  
(SOHC) 8V1120  
139660  
7575  
75Rover: Metro 111 1990/94, 111 1995/98  
Metro 111, 214 1990/94  
114, 214 1995/99

Nº OE	Descripción/Description	Mat.	Ref.
GUG701585	Jgo. de juntas para motor	●	860000-R
	Jta. tapa cilindros Ø 83.0 ± 1.80	NFT	860007
GUG702576	Jta. tapa cilindros Ø 82.5 ± 0.41	ACG	1 860008
WAN2293G	Jgo. tornillos tapa cilindros (HAE12038)		B860000
	Junta tapa de válvulas	GS	1 860010
GUG7030445G	Junta para cárter	GS	1 860011
GUG4002146	Múltiple admisión	NH	1 860017
LKE101640	Múltiple escape	NFT	1 860015
GUG705608	Salida de agua a tapa cilindros	NH	1 860019
	Entre inyector monopunto admisión	NH	1 860025
LVG100330	Respaldo bomba aceite	NB	1 860027
LVG100063	Varilla medida nivel aceite	NB	1 860039
LVH10010	Base filtro aceite a block	NB	1 860036
LKX100050	Tubo plástico 34 x 28 x 19	P	1 860040
	O´ring camisa cilindros G 76 x 1.5	V	8
	O´ring G 83 x 3.5	N	1
	O´ring G 33 x 3	N	1
	O´ring G 50 x 3	N	2
	O´ring G 42 x 3.5	N	1
	O´ring G 140 x 5	N	1
	O´ring G 4.7 x 1.70	GS	6
	Arandela A 13 x 19 x 1.5 C	CU	1
	Kit de retenes completo		R860000
	Jgo. retén válvulas (8)	V	1 R860010V
	Retén bancada 79 x 126 x 1.25	V	1 R860011V
	Retén distribución 27 x 39.5 x 7	V	1 R860012V
	Retén árbol de levas 30 x 40 x 7 (bidireccional)	V	2 R860013-2V

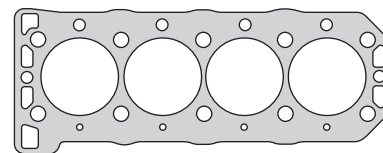

860008

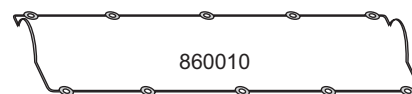

860010

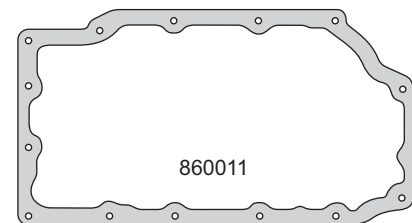

860011



860015



860017



860019



860025

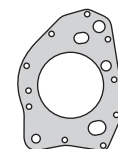

860027



860036



860039



860040



G 50 x 3



G 83 x 3.5



A 140 x 5



G 42 x 3.5

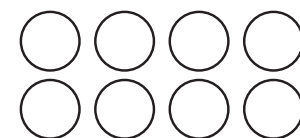

G 76 x 1.5



G 33 x 3



G 4.7 x 1.7

A 13 x 19 x 1.5 C



R860011V



R860012V



R860013-2V



R860010V

**ROVER**



Motor/Engine	Cm³	HP	Ø
14K16	1396	103	75
K16	1589	111	80
18K16 (DOHC) 16V	1796	120/145	80

Rover: 214, 414 1995/99, 25, 45 1999/...  
216, 416 1996/99, 200 Vi, 218 Coupe  
1995/...



Nº OE	Descripción/Description	Mat.	Ref.
<b>GUG701125</b>	Jgo. de juntas para motor		<b>860100-R</b>
	Junta tapa cilindros Ø 83.0 ± 1.80		<b>860007</b>
<b>GUG7025HG</b>	Junta tapa cilindros Ø 82.5 ± 0.41	<b>ACG</b>	<b>860008</b>
<b>WAN2293</b>	Jgo. tornillos tapa cilindros (HAE12038)		<b>B860000</b>
LVP100630	Junta tapa válvula	SLS	860110
GUG7030445G	Junta para cárter	GS	860111
GUG704430MG	Múltiple escape - Todos	NFT	860115
GUG704004ME	Múltiple admisión 1.4	NB	860117
GUG701074MG	Múltiple admisión inyección 1.8	NB	860117-1
LKJ101110LK	Junta admisión 1.4/1.6/1.8 1996/...	GS	860117-2
GUG705608GM	Junta termostato 1.4/1.6	NB	860119
LVG100330	Respaldo bomba aceite	NB	860027
GUG704817MG	Entre colectores admisión 1.4 hasta 1995	NB	860131
LZV1101	Junta bomba inyectora	NB	860132
L VH10010	Base filtro aceite a block	NB	860036
LVJ10006V	Varilla medición aceite	NB	860139
LQX100050	Tubo plástico-instalador retén bomba aceite	PLAST	860040
	O´ring G 32 x 3	GS	2
	O´ring G 82 x 3.5	GS	1
	O´ring G 17.17 x 1.78	GS	1
	O´ring G 75.92 x 1.78	GS	8
	Arandela A 13 x 19 x 2.5 C	CU	1
	Kit de retenes completo		R860100
LUB100350	Jgo. retén válvulas (16)	V	1 R860110V
LUF000050	Retén bancada 79 x 126 x 1.25	V	1 R860011V
LKX100040	Retén distribución 27 x 39.5 x 7	V	1 R860012V
LUC100290	Retén árbol levas del. giro derecho 30 x 40 x 7	V	2 R860013-1V
LUC100220	Retén árbol levas tras. giro izquierdo 30 x 40 x 7	V	2 R860013-2V

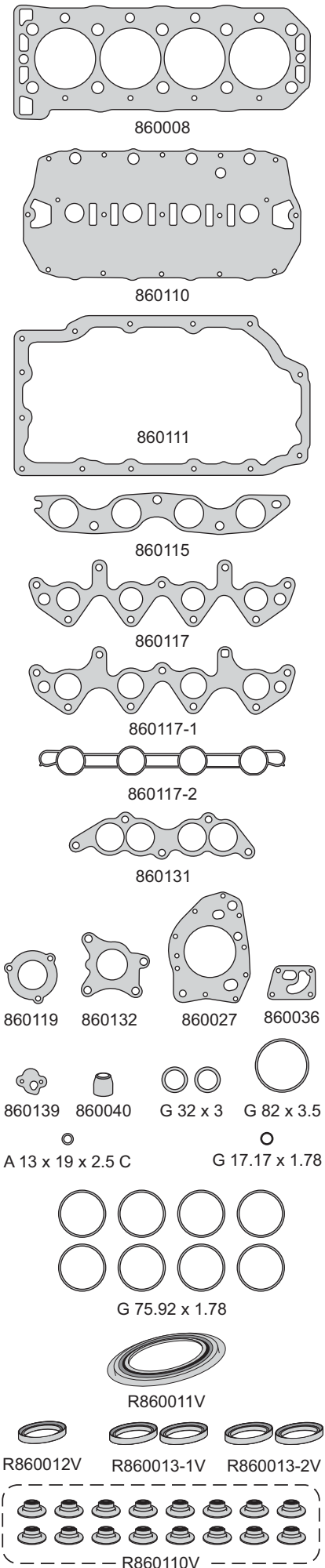

# ROVER



Motor/Engine	Cm³	HP	Ø
20HD-M16 (DOHC) 16V	1994	103/120	84.45

Rover: 820, 820i, 820Si  
Inyección Multipunto 1986/90



Nº OE	Descripción/Description	Mat.	Ref.
	Jgo. de juntas para motor		890600-R
	Junta tapa cilindros Ø 88.6 ± 1.70	NFT	1 890607
	Conjunto junta tapa válvulas (2)	NB	1 890610
	Junta para cárter	NB	1 890611
	Junta placa trasera motor	NB	1 890612
	Junta porta filtro bomba aceite delantero	NB	1 890613
	Múltiple escape	FCH	1 890615
	Múltiple admisión	NH	1 890617
	Junta base termostato	NB	1 890619
	Junta acople inyección	NB	1 890629
	Junta acople termostato	NB	1 890630
	Junta acople admisión	NB	1 890631
	O'ring G 8 x 3.5	GS	8
	O'ring G 6 x 4.8	GS	1
	O'ring G 18 x 2	GS	1
	O'ring G 20 x 2.4	GS	1
	Kit de retenes completo		R890600
	Jgo. retén válvulas (16)	P	1 R890610P
	Retén bancada 88.9 x 104.7 x 9.30	V	1 R890611V
	Retén distribución 35 x 45 x 7	V	1 R890612V
	Retén árbol de levas 40 x 52 x 7	V	4 R890613V

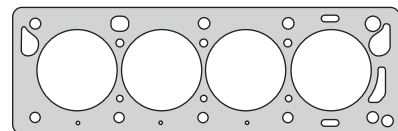

890607

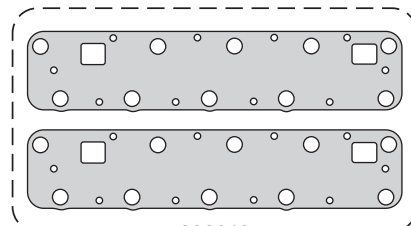

890610

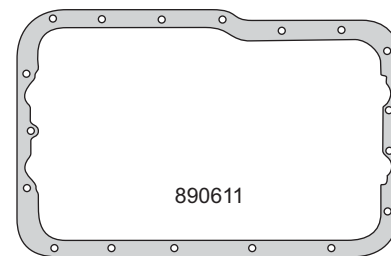

890611



890615



890617

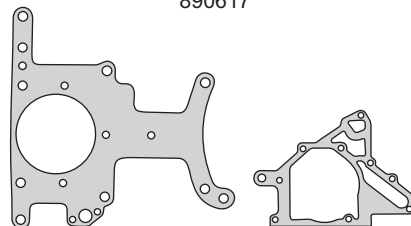

890612

890613

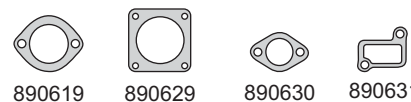

890619

890629

890630

890631



G 6 x 4.8

G 18 x 2

G 20 x 2.4



G 8 x 3.5



R890611V



R890612V



R890613V

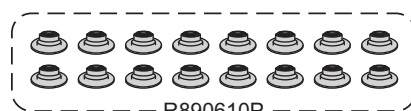

R890610P



# taranto

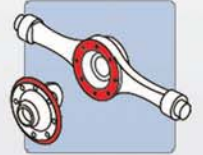

**HIGH  
TEMP  
350°C**

## Sellador Líquido a base de Caucho de Silicona

Aprobado para motores equipados con sensor de oxígeno.

- ▶ Sellador libre de solvente, adhesivo y cubritivo compuesto a base de caucho de silicona, ha sido especialmente creado para aplicaciones de gran fuerza de torsión.
- ▶ Excelente resistencia al aceite a los combustibles, aceites, lubricantes, anticongelantes y gases.
- ▶ Resiste golpes y vibraciones.
- ▶ Es siempre flexible y se mantiene a una temperatura de entre -62°C a +350°C intermitente.

No recomendado para sellar tapas de cilindros.



# VM BORGWARD



Motor/Engine	Cm³	HP	Ø
VM80A	1995	95	88
VM81A/492HT	2393	110/113	92
VM84A/08B/07B	2499	114/125	92
VM31B/32B-SCB	2499	125/115	92
VM66A/84A	2499	108/114	92
HR425CLI <small>DIESEL</small>	2499	118	92

**Alfa Romeo:** 75/90TD, 155/164TD 1984/...  
**Chrysler:** Voyager, Grand Voyager TD 92/94  
**Ford:** Scorpio, Granada TDI, Falcon  
**Rover:** Range Rover TD 1986/89, 1989/92  
**Toyota:** Land Cruiser 70/250 TD 1987/89 - 1990/93

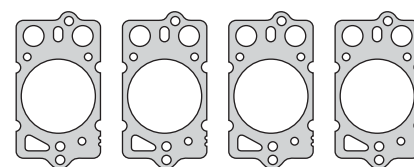

500507

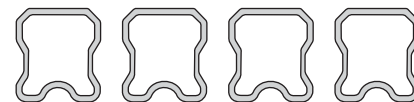

500410

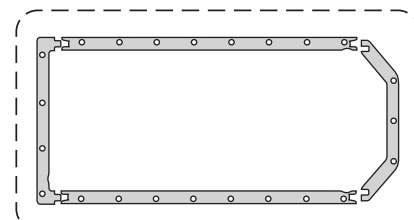

500411

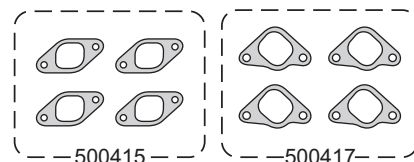

500415

500417

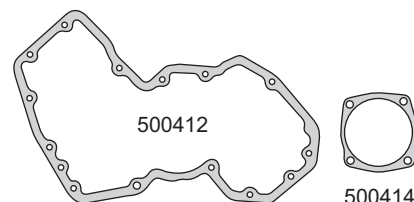

500412

500414



500418

500427

500428

500430



500434

500429

500433



500246

G 63.22 x 1.78

500540



G 31.34 x 3.53

G 26.57 x 3.53



G 34.52 x 3.53

G 66.4 x 1.78

G 158.42 x 2.62



500470-0.20



500473



R500411P

R500412P

Nº OE	Descripción/Description	Mat.	Ref.
	Jgo. de juntas para motor		500401
22030460B	Junta tapa cilindros Ø 98.0 ± 1.55	NFT 4	500507-SM
22032043A	Junta tapa cilindros Ø 98.0 ± 1.60	NFT 4	500507-2M
22030461B	Junta tapa cilindros Ø 98.0 ± 1.80	NFT 4	500507-1M
B2031007A	Junta tapa de válvulas	NH 4	500410
22030365A	Jgo. junta para cárter (4)	NB 1	500411
22030363A	Tapa distribución	NB 1	500412
20030371A	Bomba de agua	NB 1	500414
22030403A	Jgo. múltiple escape (4)	NFT 1	500415
22030350A	Jgo. múltiple admisión (4)	NB 1	500417
22022025A	Salida de escape	NFT 1	500418
22030448A	Salida de escape a turbo	CHA	500518
46320525A	O'ring bomba aceite G 66.34 x 2.62	GS 1	500427
B6321000A	O'ring bomba combustible G 39.34 x 2.62	GS 1	500428
22030338A	Entre tapa cilindros y tubo recolector agua	NB 4	500429
22030356A	Entrada aceite turbo	NB 1	500430
22030162A	Conexión cuentavueltas	NB 1	500433
46320069A	O'ring cigüeñal G 37.69 x 3.53	GS	500434
46320530A	O'ring bancada cigüeñal G 158.42 x 2.62	GS 1	500435
46320529A	O'ring tapa inspección bomba inyectora G 63.22 x 1.78	GS 1	500437
46320186A	O'ring chupador aceite cárter G 26.57 x 3.53	GS 1	500438
46320188A	O'ring tubo llenado aceite G 31.34 x 3.53	GS 2	500439
	O'ring G 34.52 x 3.53	GS 1	
46320529A	O'ring carcasa intermedia G 63.17 x 2.62	GS	500440
	Salida de escape turbo	NFT 1	500540
46320234A	O'ring depresor G 66.4 x 1.78	GS 1	500441
	Salida de escape a turbo ø 66 hasta 1987	AC	500543
22030389A	Acople bomba inyectora	NB 1	500246
	Salida de escape a turbo Ø 63 1987/....	AC	500546
22020138A	Jgo. suplemento camisa cilindro (0.15)	CU	500470-0.15
22020153A	Jgo. suplemento camisa cilindro (0.20) (4)	CU 1	500470-0.20
22020165A	Jgo. suplemento camisa cilindro (0.23)	CU	500470-0.23
46320531A	Jgo. o'ring camisa cilindro G 94.92 x 2.62 (3)	GS 4	500473
	Kit de retenes completo		R500400
	Retén bancada 90 x 120 x 12	P	R500411P
	Retén distribución 56 x 80 x 10	P	R500412P

VM



Motor/Engine	Cm³	HP	Ø
VM425TD	2499	114/121	92
VM41B	2499	115	92
SCC/SCD (OHV) 8V	2499	115/125	92

**Chrysler:** Dakota TD, Grand Voyager TD 1995/...  
**Ford:** Scorpio TDI SCC/SCD 1994/98  
**Jeep:** Cherokee, Grand Cherokee TD 1997/...  
**Opel:** Frontera A TD 1995/98  
**Rover:** 825 TD 1996/99



DIESEL

Nº OE	Descripción/Description	Mat.	Ref.
1.203.2114FI	Jgo. de juntas para motor		520301-R
22022080	Junta tapa cilindros Ø 98.0 ±1.40	NFT	520307-SM
22022082	Junta tapa cilindros Ø 98.0 ±1.50	NFT	520307-1M
22022081	Junta tapa cilindros Ø 98.0 ±1.60	NFT	520307-2M
4863781	Junta tapa cilindros Ø 98.0 ±1.42	MLS	520308-SM
4863782	Junta tapa cilindros Ø 98.0 ±1.52	MLS	520308-1M
4863783	Junta tapa cilindros Ø 98.0 ±1.62	MLS	520308-2M
21762062/69/70	Jgo. tornillos tapa cilindros (HAN12055/12100)		B520300
04863789AB	Conj. junta tapa válvulas (inyector inclinado) (5)	NB	520310
	Junta para cárter	NB	520311
	Frente motor	NB	520312
	Junta para cárter inferior	NH	520331
05003546AA	Jgo. múltiple escape (4) 52315-1	AC	520315
	Múltiple admisión y escape 1998/...	MLS	520315-2
05003546AA	Jgo. múltiple admisión (4) 50417-1	NB	500417
04720451	Base bomba de agua	NB	520319
04720196	Comando bomba inyectora	NB	400246
04720450	Cañería de agua	NB	500429
04778965	E.G.R (recirculación de gases escape)	NB	520330
04778971	Base termostato	NB	520332
	Base delantera a distr. a eje dirección hidráulica	NB	520333
04796007AB	Descarga turbo	NB	520334
04720203	Escape turbo	AC	520335
	Junta tapa válvulas (inyector recto)	NB	520336
	Termostato	GS	460237
05015027AA	Junta	AC	520337
05015028AA	Junta escape turbo	AC	270345
	Jgo. juntas turbo (4)	VS	520368
	Jgo. suplemento camisa cilindros (0.15) (4)	CU	500470-015
	Jgo. suplemento camisa cilindros (0.20) (4)	CU	500470-020
	Jgo. suplemento camisa cilindros (0.23) (4)	CU	500470-023
	O`ring camisa cilindros G 94.92 x 2.62 S	S	500473/1S
	O`ring camisa cilindros G 94.92 x 2.62 N	N	500473/1N
	O`ring G 63.22 x 1.78	GS	
	O`ring G 63 x 3	GS	
	O`ring G 158.42 x 2.62 (cigüeñal)	GS	
	O`ring G 88.57 x 2.62	GS	
	O`ring G 21.82 x 3.53	GS	
	O`ring G 17.12 x 2.62	GS	
	O`ring G 5.28 x 1.78	GS	
	O`ring G 94.97 x 1.78	GS	
	Arandela tapa válvulas A 8 x 14 x 1.5 C	CU	
	Arandela A 8 x 12 x 1 C	CU	
	Arandela A 10 x 14 x 1 C	CU	
	Arandela A 12 x 16 x 1.5 C	CU	
	Arandela A 14 x 18 x 1.5 C	CU	
	Kit de retenes completo		R520300
	Jgo. retén válvulas (8)	P	R520310P
0470283	Retén bancada 110 x 130 x 13	P	R310411P
05010856AA	Retén distribución 52 x 68 x 9.5	V	R520312V

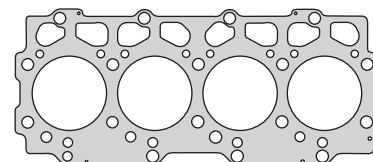

520308

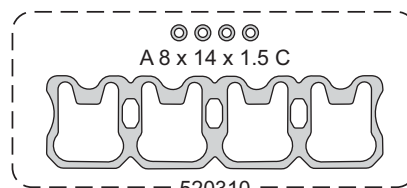

520310

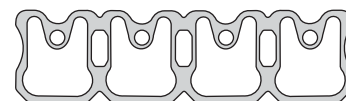

520336

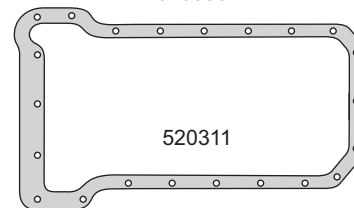

520311

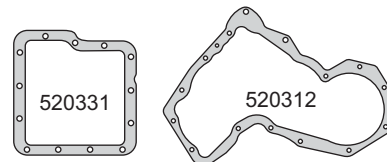

520331

520312



520315-2

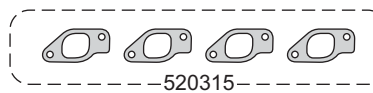

520315

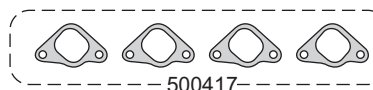

500417



520319

500429

520330



520332

520333

460237

400246

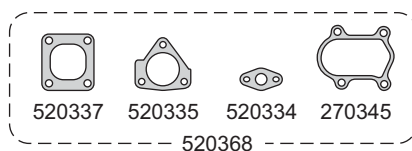

520337

520335

520334

270345

520368

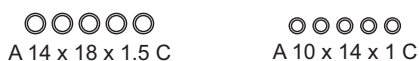

A 14 x 18 x 1.5 C

A 10 x 14 x 1 C

A 8 x 12 x 1 C

A 12 x 16 x 1.5 C



R310411P



R520312V



R520310P



VM



Motor/Engine	Cm³	HP	Ø
VM531TD	3100	142	92
DIESEL			

Chrysler: Jeep Cherokee, Grand Cherokee  
Dakota, Caravan 2001/...



Nº OE	Descripción/Description	Mat.	Ref.
05015077AA	Jgo. de juntas para motor		520401-R
	Junta tapa cilindros Ø 98.0 ± 1.40	NFT	520407-SM
	Junta tapa cilindros Ø 98.0 ± 1.50	NFT	520407-1M
	Junta tapa cilindros Ø 98.0 ± 1.60	NFT	520407-2M
60507777	Junta tapa cilindros Ø 98.0 ± 1.42	MLS	520408-SM
60507769	Junta tapa cilindros Ø 98.0 ± 1.52	MLS	520408-1M
60507768	Junta tapa cilindros Ø 98.0 ± 1.62	MLS	520408-2M
21762070/69/62	Jgo. tornillos tapa cilindros (HAN12055/12100)		B520400
04863789AB	Conj. junta tapa válvulas (6)	NB	520410
	Junta para cárter	NB	520411
	Frente motor	NB	520312
05003546AA	Jgo. múltiple escape (5) 520315/1	AC	520415
05003546AA	Jgo. múltiple admisión (5) 500417/1	NB	520417
04720451	Base bomba de agua	NB	520319
04720196	Comando bomba inyectora	NB	400246
04720450	Cañería de agua	NB	500429
04778965	E.G.R (recirculación de gases escape)	NB	520330
	Junta sobre cárter	NB	520431
	Junta sobre cárter inferior	NH	520331
04778971	Base termostato	NB	520332
	Base delantera a distribución a eje dirección hidráulica	NB	520333
04796007AB	Descarga turbo	NB	520334
04720203	Escape turbo	AC	520335
	Termostato	GS	460237
05015027AA	Junta	AC	520337
05015028AA	Junta	AC	270345
	Jgo. juntas turbo (4)	VS	520368
	Jgo. suplemento camisa cilindros (0.15) (5)		500470-0.15
	Jgo. suplemento camisa cilindros (0.20) (5)		500470-0.20
	Jgo. suplemento camisa cilindros (0.23) (5)		500470-0.23
	O`ring camisa cilindros G 94.92 x 2.62 S	N	500473/1N
	O`ring camisa cilindros G 94.92 x 2.62 N	S	500473/1S
	O`ring G 63.22 x 1.78	GS	520332
	O`ring G 158.42 x 2.62 (cigüeñal)	GS	520333
	O`ring G 88.57 x 2.62	GS	460237
	O`ring G 21.82 x 3.53	GS	400246
	O`ring G 18.72 x 2.62	GS	520337
	O`ring G 17.12 x 2.62	GS	520335
	O`ring G 5.28 x 1.78	GS	520334
	Arandela tapa válvulas A 8 x 14 x 1.5 C	CU	270345
	Arandela A 8 x 12 x 1 C	CU	520368
	Arandela A 10 x 14 x 1 C	CU	
	Arandela A 12 x 16 x 1.5 C	CU	
	Arandela A 14 x 18 x 1.5 C	CU	
	Arandela A 16 x 20 x 1.5 C	CU	
	Arandela A 17 x 22 x 1.5 C	CU	
	Arandela A 20 x 26 x 1.5 C	CU	
	O`ring G 94.92 x 2.62	GS	
	O`ring G 94.97 x 1.78	S	
	Kit de retenes completo		R520400
	Jgo. retén válvulas (10)	P	R520410P
04720283	Retén bancada 110 x 130 x 13	P	R310411P
05010856AA	Retén distribución 52 x 68 x 9.5	V	R520312V

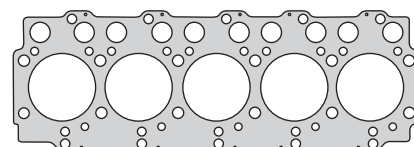

520408

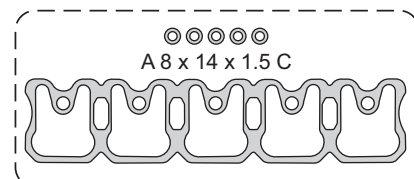

A 8 x 14 x 1.5 C

520410

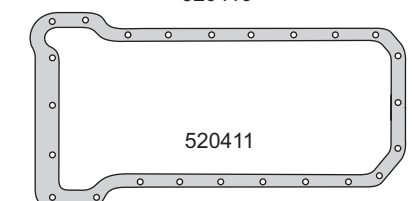

520411



520415

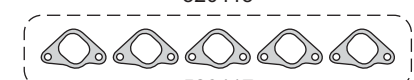

520417

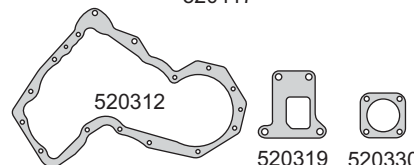

520312

520319 520330

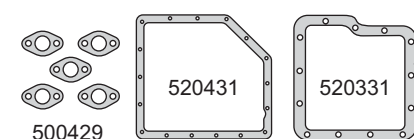

520431

520331



500429

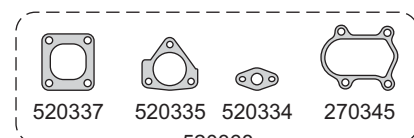

520337

520335

520334

270345

520368



G 158.42 x 2.62

G 63.22 x 1.78

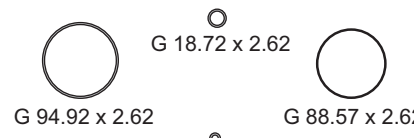

G 94.92 x 2.62

G 88.57 x 2.62

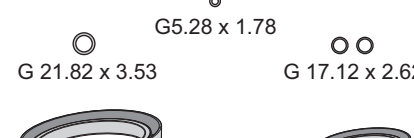

G 21.82 x 3.53

G 17.12 x 2.62

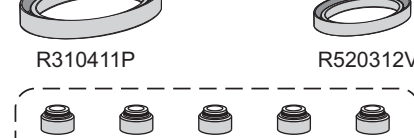

R310411P

R520312V

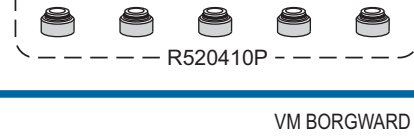

R520410P



# taranto



## VIFLON®



## Revolucionario diseño de labio en VIFLON® VF

Como resultado de la permanente búsqueda de mejores diseños y materiales para ofrecer al mercado productos más eficientes a costos razonables, Taranto ha desarrollado nuevos perfiles de labio con mejores características y costo más bajo que los retenes PTFE.

### VENTAJAS DE ESTE NUEVO DISEÑO Y COMPUESTO











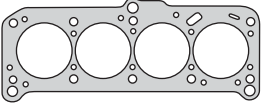

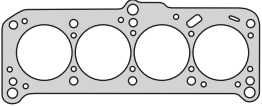

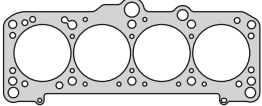



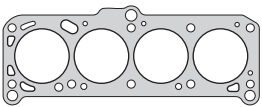

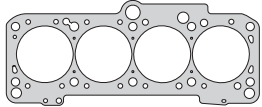

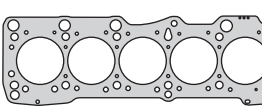
- ▶ Contacto más estrecho con el eje.
- ▶ Menor carga sobre el eje por su diseño sin resorte.
- ▶ Menor coeficiente de fricción respecto al compuesto fluoroelastómero FKM.
- ▶ Mejor flexibilidad del labio con una mejor adaptación a ejes usados.
- ▶ Menor costo respecto al PTFE.

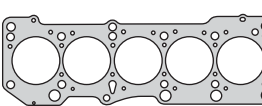

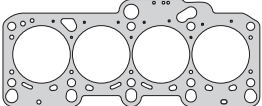
# AUDI / VOLKSWAGEN

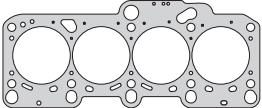
## JUNTA TAPA DE CILINDROS / HEAD GASKETS

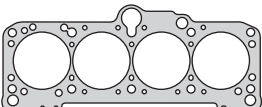
### MOTORES NAFTA Y DIESEL / PETROL AND DIESEL ENGINES

	Código Code	Q	≠	Kit Bulón Bolt Set	Aplicación Application	Motor Engine	Juego
<b>220405 - 220407</b> 	220405 220407	81.0 81.0	1.70 1.70	B220400  HAN12055 HAN12100	VW Passat, Dasher (USA) 1975/80, Caddy, Jetta, Scirocco, Golf, Gacel 1975/84 Audi 4000, 80, 4E, 100, Fox 1979/83, Coupe 1980/81- VW Golf, Rabbit, Passat, Scirocco, Jetta, Santana 1979/83, Caribe, Atlantic 1977/84	1457cc. EH/GH/JB/FT/FV/YP 75110HP 1588cc.FN/FP/FS/FT/FR/FV YH/YP/YT/YK/YW/YYS/YZ/YN VY/VZ/WP/EM/WV/WY/YN 75/110HP Ø79.5	220400-R  pág. 533
<b>220405 - 220407</b> 	220405 220407	81.0 81.0	1.70 1.70	B220400  HAN12055 HAN12100	VW Rabbit, Dasher (USA) 1980/84 Jetta 1981/84, Scirocco 1981/83, Quantum 1982/83, Caribe, Atlantic 1977/84 Audi 4000 1981/83	1714cc. EN 77/80HP Ø79.5  1715cc. WT 79HP Ø79.5	220400-R  pág. 533
<b>220605 - 220607</b> 	220605 220607	82.2 82.2	1.70 1.70	B220400  HAN12055 HAN12100	VW Gacel, Senda, Voyage, Gol, Santana, Passat, Apollo, Logus 1985/...	1781cc. AP 85/87HP Ø81 1595cc. AP 70HP Ø81 (SOHC) 8V  1800cc. L4 F.I 90HP Ø91	220600-R  pág. 534  231600-R  pág. 573
<b>220805</b> 	220805	79.0	1.70	B220400  HAN12055 HAN12100	VW Passat, Golf, Dasher (USA), Scirocco Rabbit 1974/82	1457cc. ZC/YJ/FL/FB/FD/FH/FK 65/85HP Ø76.5 (SOHC) 8V	220800-R  pág. 535
<b>221005 - 221007 - 221008</b> 	221005 221007 221008	83.5 83.5 83.5	1.60 1.60 1.50	B220400  HAN12055 HAN12100	VW Golf, Passat 1992/96, Polo 1999/... Golf Cabrio 1999/02 Desde Motor 031252	1984cc. ATU/AWF/AWG/ABA/AKR 115HP Ø82.5 (SOHC) 8V	221000-R  pág. 536
<b>221107</b> 	221107-1M 221107-2M 221107-3M	81.0 81.0 81.0	1.50 1.60 1.70	B221100  HAN12055 HAN12100	VW Transporter T4 1992/99 Transporter Syncro 1992/98, Eurovan Caravelle 1997/... <b>DIESEL</b>	2370cc. AAB/AJA 75/78HP Ø79.5 (SOHC) 10V	221101-R  pág. 537
<b>221507</b> 	221507-1M 221507-2M 221507-3M	81.0 81.0 81.0	1.50 1.60 1.70	B221100  HAN12055 HAN12100	VW Transporter T4 1998/... Transporter Syncro TDI 1998/... Transporter T4 TDI 1995/99 LT SDI 1996/... <b>DIESEL</b>	2459cc. AJT 88HP AGX 75HP ACV 102HP Ø81 (SOHC) 10V	221501-R  pág. 539
<b>221705 - 221707 - 221708</b> 	221705 221707 221708	82.0 82.0 82.5	1.50 1.50 1.40	B221700  HAR10168	Audi A3 Turbo 1996/..., A3/A3 Quattro 1998/..., A6 1997/... - VW New Beetle, Passat 1999/..., Golf, Sharan 1997/... Bora 2000/...	1781cc. AGU/ARZ/AJH/AVC/AWU 150HP ARG/APT 125HP AJP/AGU/AQA 125/150HP AJQ/APP 180HP Ø81	221700-R  pág. 541
<b>221707 - 221708</b> 	221707 221708	82.0 82.5	1.50 1.40	B221800  HAR10168	Audi A4/A4 1994/..., A6/A6 1995/... Cabrio 1997/..., A6 Quattro 1999/... VW Passat 1996/99 - 1999/..., Passat Turbo 1996/98	1781cc. AEB/AJL/ANB 150/180HP AFY/ADR 115/125HP Ø81 (DOHC) 20V	221800-R  pág. 542
<b>221907</b> 	221907	83.5	1.70	B221900  HAN12055 HAN12100	VW Golf, Passat 1992/96 Toledo 16V 1994/99, Ibiza Cordoba 1996/99 - Hasta Motor 031251	1985cc. ABF 150HP Ø82.5 (DOHC) 16V	221900-R  pág. 543

# AUDI / VOLKSWAGEN

## JUNTA TAPA DE CILINDROS / HEAD GASKETS



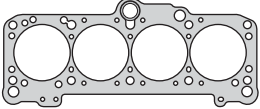
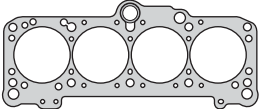
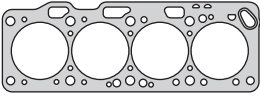
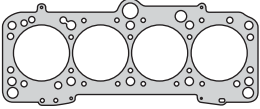
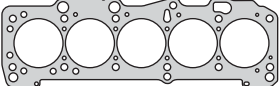
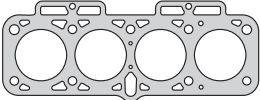
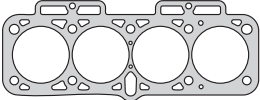
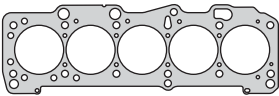
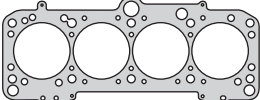
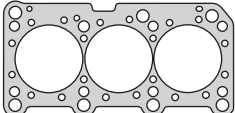







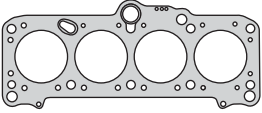

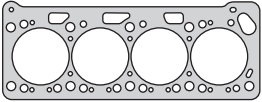

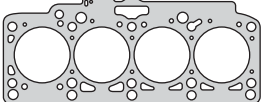

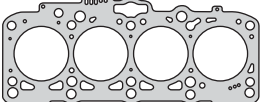

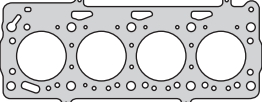

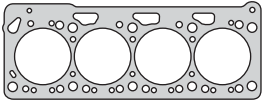
### MOTORES NAFTA Y DIESEL / PETROL AND DIESEL ENGINES

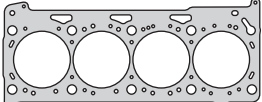
	Código Code	Q	≠	Kit Bulón Bolt Set	Aplicación Application	Motor Engine	Juego
	221907	83.5	1.70	<b>B220400</b> HAN12055 HAN12100	Audi 80 Quattro, 100 1993/95 80 1991/95, 100 1993/94  80 Quattro, Coupe 1990/93 100 1990/93	<b>1984cc.</b> ABK, ABT, AAE 90/101/115HP Ø82.5  <b>1984cc.</b> AAD, ABK, AAE 101/115HP Ø82.5	<b>222500-R</b> pág. 547  <b>222600-R</b> pág. 548
	221907	83.5	1.70	<b>B220400</b> HAN12055 HAN12100	VW Golf GTI, Vento, Passat Corrado 1991/94 Seat Toledo, Ibiza, Cordoba 1991/94	<b>1984cc.</b> 2E 115HP Ø82.5 (SOHC) 8V	<b>223900-R</b> pág. 556
	222007	76.0	1.60	<b>B220400</b> HAN12055 HAN12100	Golf, Jetta 1985/91, Polo 1985/92, 1990/94  Golf, Jetta, Polo 1985/92 - 1987/94  Golf, Vento 1991/94	<b>1043cc.</b> HZ/AAK/ACM 45/50HP Ø75 <b>1272cc.</b> UN/UN/2G/AAV 55/75HP Ø75 <b>1391cc.</b> ABD 60HP Ø75 (SOHC) 8V	<b>222000-R</b> pág. 544
	222108	83.5	1.65	<b>B221900</b> HAN12055 HAN12100	VW Golf, Passat, Passat Variant 1992/97	<b>1985cc.</b> ABF 150HP Ø82.5 (DOHC) 16V	<b>222100-R</b> pág. 545
	222207	83.0	1.70	<b>B222200</b> HAN12055 HAN12100	Audi 80/80 Quattro, Coupe 1983/86, 90/100 1984/88 VW Passat, Santana 1983/88 Audi 100/200, Coupe, 90/90 Quattro 1984/91 VW Passat, Quantum 1985/88	<b>1994cc.</b> JS, HP, SK, KP 113/115HP Ø81 (SOHC) 10V <b>2226cc.</b> KZ, KU, HY, KV 115/137/165HP Ø81 (SOHC) 10V	<b>222200-R</b> pág. 546
	222307	77.0	1.20		Seat Malaga 1985/93, Ronda 1983/86	<b>1193cc.</b> 021A1 - 021C1 62/71HP Ø75 (SOHC) 8V	
	222407	85.0	1.20		Seat Malaga 1985/93, Ronda 1984/...  Seat Ibiza Sportline 1991/93	<b>1461cc.</b> 021A2 85/90HP Ø83 <b>1675cc.</b> 021C3 98HP Ø83 (SOHC) 8V	
	222707	84.0	1.70	<b>B222200</b> HAN12055 HAN12100	Audi 100, 200 Avant, 100 Avant, Coupe Cabriolet 1985/...  Audi 80/90 1985/94, Cabrio, Coupe 1990/95, A6 1994/..., 80 Quattro 1991/94, 90 Quattro 1987/91	<b>2309cc.</b> NF 100/136HP Ø82.5  <b>2309cc.</b> AAR/NG 133HP Ø82.5 (SOHC) 10V	<b>222700-R</b> pág. 549  <b>222800-R</b> pág. 550
	222908	83.5	1.70	<b>B220400</b> HAN12055 HAN12100	VW Passat, Golf, Vento 1994/97 Sharan 1995/... Seat Toledo, Cordoba, Ibiza Alhambra 1994/99	<b>1984cc.</b> ADY/AGG/AEP 107/115HP Ø82.5	
	223007	83.5	1.80	<b>B223000</b> HAN12055 HAN12100	Audi 80 1991/1994, 80/80 Quattro, Cabriolet, 100/ 100 Quattro 1992/94, A4/A4 Quattro, A6/A6 Quattro 1994/... 100/100 Quattro, 80/80 Quattro, Coupe 1990/94, A4/A4 Quattro, A6/A6 Quattro 1994/..., Cabriolet 1991/94	<b>2598cc.</b> ACZ/ABC 144/150HP Ø82.5  <b>2771cc.</b> AAH/ABC/AEJ 163/174HP Ø82.5 (SOHC) V6 12V	<b>223000</b> pág. 551

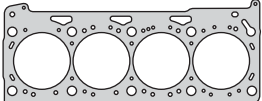
# AUDI / VOLKSWAGEN

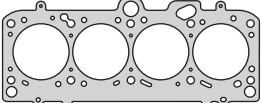
## JUNTA TAPA DE CILINDROS / HEAD GASKETS

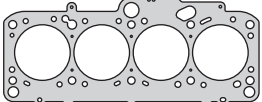
### MOTORES NAFTA Y DIESEL / PETROL AND DIESEL ENGINES

	Código Code	Q	≠	Kit Bulón Bolt Set	Aplicación Application	Motor Engine	Juego
	223207-1M 223207-2M 223207-3M	78.0 78.0 78.0	1.50 1.60 1.70	B230100  HAN12055 HAN12100	Audi 80D/80TD/90TD 1985/91 VW Caddy D, Jetta D/TD, Golf D/TD Santana D/TD, Passat D/TD TYP 2/80 Transporter, D/TD 1985/93 <b>DIESEL</b>	1588cc. CS/JX/JP/CY/JK/RA/SB/CR SV/1V/ME/JR 49/54/70/80HP Ø76.5 (SOHC) 8V	
	223307	77.5	1.60	B230300  HAN12055 HAN12100	VW Golf, Vento 1992/94	1588cc. ABU 75HP Ø76.5 (SOHC) 8V	223300-R  pág. 552
	223407-1M 223407-2M 223407-3M 223408-1M 223408-2M 223408-3M	81.0 81.0 81.0 80.5 80.5 80.5	1.50 1.60 1.70 1.63 1.68 1.78	B223400  HAN12055 HAN12100	Audi A3 TDI 1996/99 VW Bora, Golf SDI/TDI 1997/... <b>DIESEL</b>	1896cc. ALH/AHF/AGR/AGP 68/90/110HP Ø79.5 (SOHC) 8V	223401-R  pág. 553
	223507-1M 223507-2M 223507-3M 223508-1M 223508-2M 223508-3M	81.0 81.0 81.0 81.0 81.0 81.0	1.50 1.60 1.70 1.48 1.58 1.68	B223500  HAN12055 HAN12100	Audi A4 TDI 2000/... - 2004/... A6 TDI 2001/... VW Passat TDI 1999/... Sharan TDI 2000/... Transporter TDI 2003/... <b>DIESEL</b>	1896cc. AXB 105HP - AXC 85HP ATJ/AUY 115HP - AVF 130HP AWX 131HP - BKE 116HP (SOHC) 8V Ø79,5	223501-R  pág. 554
	223608	68.0	0.50	B231700  HAN12055 HAN12100	VW Polo 1996/..., Lupo 1998/... Seat Ibiza, Cordoba 1996/99	999cc. AER/ALL 50HP Ø67.1	
	223708	77.5	0.35	B230300  HAN12055 HAN12100	VW Polo 1994/... VW Golf, Vento 1995/98 Seat Ibiza, Cordoba 1996/... VW Vento, Polo 1994/..., Caddy 1997/... Skoda Octavia, Felicia, Pick Up 1996/...	1296cc. ADX 55HP Ø76.5 1391cc. AEX/APQ 55/60HP Ø76.5 1598cc. AEA/AEE 75HP Ø76.5	
	224005 224007 224007-1.4 224008	78.0 78.0 78.0 78.0	1.20 1.20 1.40 0.40	B224000  HAN12055 HAN12100	VW Fox 2005/..., Polo 2003/05 VW Polo, Caddy 1997/01, Gol 2001/... Lupo 04/09, Fox 2005/..., Suran 2006/...	1390cc. BKR/BLM 75/86HP Ø76,5 1598cc. BAH/ BLH/BJA/BPA 100HP	224000-R MLS 224000-R  pág. 557
	224005 224007 224007-1.4 224008	78.0 78.0 78.0 78.0	1.20 1.20 1.40 0.40	B224000  HAN12055 HAN12100	Gol Power, Kombi 2006/...	1390cc. EA111 (SOHC) 8V 83HP Ø76,5	232600-R MLS  pág. 575
	224107 224108	82.5 82.5	1.20 1.10	B224100  HAR10168	Audi A3 2000/... VW New Beetle, Bora, Golf 2000/... Seat Cordoba 2000/...	1595cc. AYD/AVU 100HP Ø81	
	224307 224308	82.5 82.5	1.30 1.20	B224100  HAR10168	VW Derby, Bora, Passat, Golf 1999/...	1595cc. APF/AKL/AEH 100HP Ø81 (SOHC) 8V	224300-R  pág. 559

# AUDI / VOLKSWAGEN

## JUNTA TAPA DE CILINDROS / HEAD GASKETS

### MOTORES NAFTA Y DIESEL / PETROL AND DIESEL ENGINES

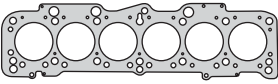
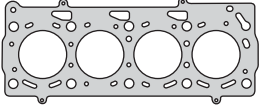
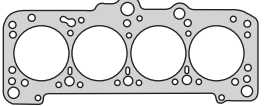
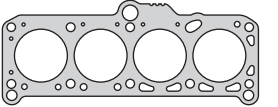
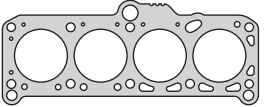
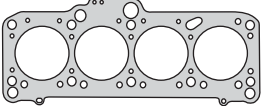
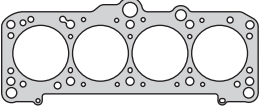
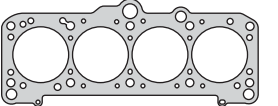
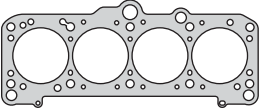
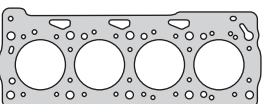
	Código Code	Q	≠	Kit Bulón Bolt Set	Aplicación Application	Motor Engine	Juego
	224408	77.5	1.40	<b>B224400</b> HAN12055 HAN12100	VW LT28/31/35/40/45/50/55TD 1992/95 LT TD 1991/95 Volvo 740/760/780/940/960 TD 1982/93 940/960TD 1993/96 - 240/244/245/940 740/760 1982/93 <b>DIESEL</b>	<b>2383cc.</b> ACT 70HP - ACL 95HP CP 75HP Ø76.5 (SOHC) 12V	
	224608	68.0	0.45	<b>B224600</b> HAN12055 HAN12100	Lupo 1999/05 - Lupo, Polo 1999/01 Seat Arosa, Cordoba, Ibiza 1999/02 Lupo 1999/... - 2000/05, Polo 1999/01 Caddy 1999/01 Seat Cordoba, Ibiza 1999/02 Arosa 1999/04, Inca 2000/03	<b>999cc.</b> ALD/ANV/AUC 50HP Ø67.1 <b>1390cc.</b> ANV/AKP 55HP AUD/AKK 60HP Ø76.5	
	230005 230007	83.5 83.5	1.70 1.70	<b>B220400</b> HAN12055 HAN12100	VW Carat, Quantum, Pointer, Gol, Golf Santana 1989/...  VW Santana 1998/...	<b>1984cc.</b> Audi 827 107/115HP Ø82.5 (SOHC) 8V  <b>1984cc.</b> AP 107/115HP Ø82.5 (SOHC) 8V	<b>230000-R</b> 🚗 pág. 560  <b>233000-R</b> 🚗 pág. 576
	230105-1M 230105-2M 230105-3M 230105-4M	78.0 78.0 78.0 78.0	1.45 1.55 1.65 1.75	<b>B230100</b> HAN12055 HAN12100	Audi 80 D/TD 1981/85 VW Senda, Saveiro, Caddy, Golf D/TD Passat, Kombi, Santana 1981/86	<b>1588cc.</b> CR/JK/JP/JR/JF/JX/CS/CY 49/54/70HP Ø76.5 (SOHC) 8V	<b>230101-R</b> 🚗 pág. 561
	230107-1M 230107-2M 230107-3M 230107-4M	78.0 78.0 78.0 78.0	1.40 1.50 1.60 1.70	<b>B230100</b> HAN12055 HAN12100	Audi 80 D/TD 1981/85 VW Senda, Saveiro, Caddy, Golf D/TD Passat, Kombi, Santana 1981/86	<b>1588cc.</b> CR/JK/JP/JR/JF/JX/CS/CY 49/54/70HP Ø76.5 (SOHC) 8V	<b>230101-R</b> 🚗 pág. 561
	230207-1M 230207-2M 230207-3M 230208-1M 230208-2M 230208-3M	80.5 80.5 80.5 81.0 81.0 81.0	1.50 1.60 1.70 1.50 1.55 1.60	<b>B230100</b> HAN12055 HAN12100	VW Passat TD 1994/96, Golf D/TD Vento D/TD 1995/98, Polo D Caddy 1995/...	<b>1896cc.</b> 1Y/AAZ/AEY 64/75HP Ø79.5 (SOHC) 8V	<b>230201-R</b> 🚗 pág. 562
	230305 230307 230308	82.2 82.2 82.5	1.70 1.70 1.60	<b>B220400</b> HAN12055 HAN12100	VW Transporter T4 1990/92  VW Transporter T4 1990/03  VW Vento 1992/97, Passat 1991/96	<b>1781cc.</b> PD 67HP Ø81 <b>1968cc.</b> AAC 84HP Ø81 (SOHC) 8V  <b>1781cc.</b> AAM/ABS/ADZ 75/90HP Ø81	<b>221400-R</b> 🚗 pág. 538  <b>221600-R</b> 🚗 pág. 540
	230305 230307 230308	82.2 82.2 82.5	1.70 1.70 1.60	<b>B230300</b> HAN12055 HAN12100	Audi 80 1993/95  VW Caddy, Polo 1995/97 VW Golf 1991/99, Vento 1992/97 Polo Classic, Passat 1991/96 Jetta 1994/96	<b>1595cc.</b> ADA/ABM 71/100HP Ø81 <b>1595cc.</b> 1F 75HP Ø81 <b>1781cc.</b> AAM/ABS/ADZ/ADD 75/90HP Ø81 (SOHC) 8V	<b>230300-R</b> <b>230300-R MLS</b> 🚗 pág. 563
	230305 230307 230308	82.2 82.2 82.5	1.70 1.70 1.60	<b>B221900</b> HAN12055 HAN12100	VW Golf 1989/91, Scirocco 1985/92 Jetta 1986/87, Passat, Corrado 1990/92	<b>1781cc.</b> KR 130HP Ø81 (DOHC) 16V	<b>223800-R</b> 🚗 pág. 555
	230505 230507 230508	70.0 70.0 68.0	1.20 1.20 0.42	<b>B230500</b> HAN12055 HAN12100	VW Gol 1000, Saveiro 1998/...	<b>999cc.</b> AT 69HP Ø67.08 (DOHC) 16V	<b>230500-R</b> 🚗 pág. 564

# AUDI / VOLKSWAGEN

## JUNTA TAPA DE CILINDROS / HEAD GASKETS

### MOTORES NAFTA Y DIESEL / PETROL AND DIESEL ENGINES

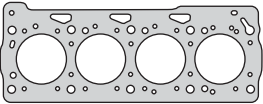
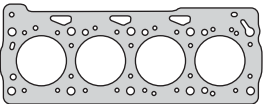
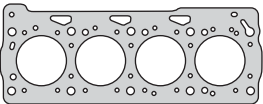
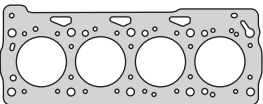
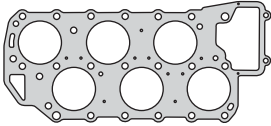
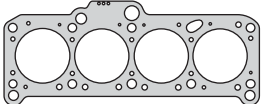
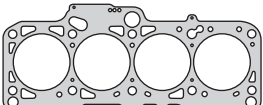
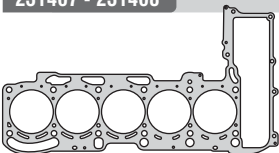
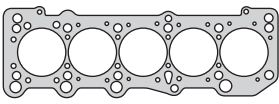
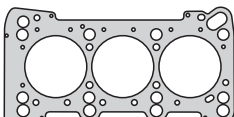
	Código Code	Q	$\neq$	Kit Bulón Bolt Set	Aplicación Application	Motor Engine	Juego
<b>230505 - 230507 - 230508</b> 	230505 230507 230508	70.0 70.0 68.0	1.20 1.20 0.42	<b>B230600</b> HAN12055 HAN12100	VW Gol 1000, Saveiro, Polo 1995/...	<b>999cc.</b> AER/ALL 50HP Ø67.1 (SOHC) 8V	<b>230600-R</b> 🚗 pág. 565
<b>230505 - 230507 - 230508</b> 	230505 230507 230508	70.0 70.0 68.0	1.20 1.20 0.42	<b>B230500</b> HAN12055 HAN12100	VW Fox 2003/...	<b>999cc.</b> AQZ/BJE (SOHC) 8V 71/72HP	<b>224200 MLS</b> 🚗 pág. 558
<b>230505 - 230507 - 230508</b> 	230505 230507 230508	70.0 70.0 68.0	1.20 1.20 0.42	<b>B230600</b> HAN12055 HAN12100	VW Gol Power 2002/...	<b>999cc.</b> AT (SOHC) 8V 50/69HP Ø67.1	<b>231200-R MLS</b> 🚗 pág. 569
<b>230505 - 230507 - 230508</b> 	230505 230507 230508	70.0 70.0 68.0	1.20 1.20 0.42	<b>B231300</b> HAN12055 HAN12100	VW Gol Power 2002/...	<b>999cc.</b> AT (DOHC) 69HP 16V Ø67.08	<b>231300-R MLS</b> 🚗 pág. 570
<b>230707</b> 	230707	83.0	1.60	<b>B230700</b> HAN12055 HAN12100	VW Passat VR6 1991/96, Golf VR6, Vento VR6 1992/97, Jetta 1993/... VW Passat VR6 1994/96 Golf VR6 1994/97	<b>2792cc.</b> AAA 174HP Ø81 <b>2862cc.</b> ABV 190HP Ø82 (DOHC) V6 12V	<b>230700-R</b> 🚗 pág. 566
<b>230907 - 230908</b> 	230907-1M 230907-2M 230907-3M 230908-1M 230908-2M 230908-3M	81.5 81.5 81.5 81.0 81.0 81.0	1.40 1.50 1.60 1.45 1.53 1.61	<b>B230100</b> HAN12055 HAN12100	Audi A4 D/TDI 1994/96-1997/00 A6 TDI 1994/96, CabrioTDI 1995/96 80TDI 1991/94 VW Golf SDI/TDI 1993/95-1999/... Vento SDI/TDI, Sharan TDI 1995/96 Passat TDI 1993/95-1995/... Polo TDI/SDI 1995/96, Caddy SDI 1995/...	<b>1896cc.</b> AHU/AVG/AEY/1Z/AFN/AHH 64/90/110HP Ø79.5 (SOHC) 8V	<b>230901-R</b> 🚗 pág. 567
<b>231105 - 231107 - 231108</b> 	231105 231107 231108	83.5 83.5 83.5	1.40 1.40 1.40	<b>B224100</b> HAR10168	VW Jetta 1998/02, Golf 1998/01 New Beetle, Bora 1998/..., Sharan 2000/... VW Polo BR 2002/...	<b>1984cc.</b> AZH/APK/AQY/ATM 115HP <b>1985cc.</b> BBX 116HP Ø82.5 (SOHC) 8V	<b>231100-R MLS</b> 🚗 pág. 568
<b>231407 - 231408</b> 	231407 231408	83.0 83.0	1.20 0.60	<b>B231400</b> HAR10168	VW Bora, Vento 2005/09	<b>2480cc.</b> L5 BGP/BGQ 148/168HP Ø82.5 (DOHC) 20V	<b>231400-R MLS</b> 🚗 pág. 571
<b>231507</b> 	231507	83.0	1.60	<b>B231500</b> HAN12055 HAN12100	VW Eurovan 2001/04	<b>2461cc.</b> AET/APL/AVT/L5 115HP Ø81 (SOHC) 10V	<b>231500-R</b> 🚗 pág. 572
<b>231908</b> 	231908-1M 231908-2M 231908-3M	79.0 79.0 79.0	0.95 1.00 1.05	<b>B231900</b> HAN12055 HAN12100	VW Passat TDI V6 24V 1998/03 <b>DIESEL</b>	<b>2496cc.</b> AFN/AKN 150HP Ø78.3 (DOHC) V6 24V	

# AUDI / VOLKSWAGEN

## JUNTA TAPA DE CILINDROS / HEAD GASKETS

### MOTORES NAFTA Y DIESEL / PETROL AND DIESEL ENGINES

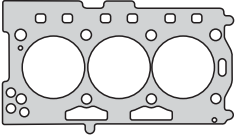
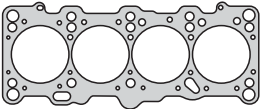
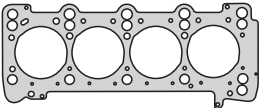
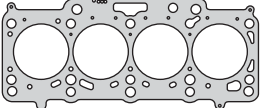
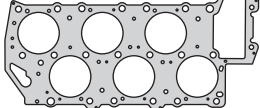
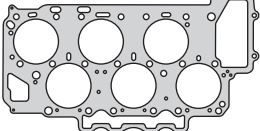
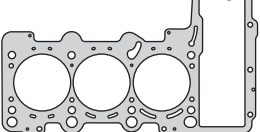
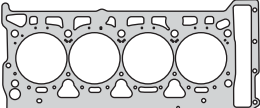
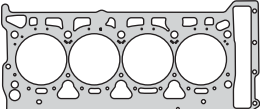
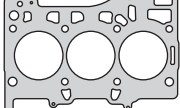
	Código Code	Q	≠	Kit Bulón Bolt Set	Aplicación Application	Motor Engine	Juego
	232008	77.0	0.64	<b>B232000</b> HAN12055 HAN12100	VW Polo 2002/07 - 2007/... Fox 2005/... , 2010/... Seat Ibiza 2007/8 Skoda Fabia 2001/04 - 2004/10	<b>1198cc.</b> AWY/BBM 54HP BMD 55HP CHFA/BBM 60HP Ø76.5 (SOHC) 6V	
	232207	85.5	1.80	<b>B232200</b> HAN12055 HAN12100	Audi A8 1995/98  Audi A8 1991/93, 100 1992/94 S6 1994/96	<b>3697cc.</b> AEW/AKJ 230HP Ø84,5 <b>4172cc.</b> ABH 280HP AEC 290HP ABZ 299HP Ø84,5 (DOHC) V8 32V	
	232308	79.0	1.10	<b>B232300</b> HAN12055 HAN12100	Audi A8 TDI 2000/02  Audi A8 TDI 2003/05  Audi A8 TDI 2005 - Q7 2007/09	<b>3328cc.</b> AKF 224HP Ø78.3 <b>3936cc.</b> 275HP Ø78.3 <b>4134cc.</b> BMC/BTR/BVN 320/326HP (DOHC) V8 32V	
	232407-1M 232407-2M 232407-3M 232408-1M 232408-2M 232408-3M	82.0 82.0 82.0 82.0 82.0 82.0	1.60 1.70 1.80 1.55 1.63 1.71	<b>B232400</b> HAN12055 HAN12100	VW Pick Up Amarok TDI 2010/... Inyección directa Common Rail Audi A3, A5 TDI, A4, Q5 Quattro TDI 2009/... Seat Ibiza, Leon, Alhambra TDI 2010/... <b>DIESEL</b>	<b>1968cc.</b> CDBA/CDCA 90/120HP Ø81 CJCB/CMEA/CAGA 136/143HP CBEA/CGLA/CGLB 163/170HP CFFA/CFHD 136/143HP (DOHC) 16V Ø81	<b>232401-R</b> pág. 574
	232507 232508	85.0 85.0	1.30 0.60		Audi A3 2005/... , TT 2006/... VW Touareg 2003/06, Golf 2005/... Eos 2006/... , Golf 2007/... New Beetle RSI 2000/01	<b>3189cc.</b> BUB 184/250HP Ø84 BAA/BMX/BRJ 220HP BUB/CBRA 250HP Ø84 AXJ 225HP Ø84 VR6 (DOHC) 24V	
	232708	89.5	0.90		Audi Q7 2006/...  VW Passat FSI 2005/...  VW Passat FSI, Eos, Phaeton, Touareg FSI 2005/...	<b>3597cc.</b> BHK 280HP Ø89 <b>3168cc.</b> AXZ 250HP Ø86 <b>3597cc.</b> BHK/BHL/BLV 280HP Ø89 VR6 (DOHC) V6 24V	
	232808	85.5	1.53		Audi A6/A8 FSI 2006/... Audi Q7/Q5 Quattro - A8 Quattro 2010/... A5 Cabriolet/Coupe 2011/... VW Touareg, Touareg TSI 2010/... Audi A4/A6/A8 2005/... A4/A6 Quattro 2006/...	<b>2773cc.</b> BDX/CCDA/CCEA <b>2995cc.</b> CJTC/CJTB/CMDA CTUC/CTVA 272/310/333HP CJTA/CGFA/CGEA 290/333HP <b>3123cc.</b> BKH/AUK/BPK/BKH 255HP Ø84.5 (DOHC) V6 24V	
	232907 232908	83.0 83.0	1.20 0.90	<b>B221700</b> HAR10168	Audi TT TFSI - A3 FSI 2007/... VW Passat TSI 2007/...  Audi TT TFSI 2006/... A3/A4/A5 2008/... Q5/A4 2009/... VW Golf, Eos, Tiguan, Passat, Scirocco, Jetta FSI 2007/...	<b>1798cc.</b> BYT/BZB/CDAA/BZB/CDAA 160/152HP Ø82.5 <b>1984cc.</b> CCTA/CDNB/CDNC/CAEB CBFA/CAEA/CFKA 180/211HP	
	232907 232908	83.0 83.0	1.20 0.90	<b>B221700</b> HAR10168	VW Passat TSI 2007/...  Audi A3/A4/A5/Q5 TFSI 2008/... A4/A5 Quattro 2010/... VW Golf, Tiguan, Eos, Passat FSI 2007/... Scirocco FSI 2008/...	<b>1798cc.</b> CDA/CDAB 152/160HP Ø82.5 <b>1984cc.</b> CDNB/CDNC/CAEB/CBFA CBFA/CCTA/CCZA/CCTB 180/211HP Ø82.5 (DOHC) 16V	<b>233200-R MLS</b> pág. 578
	233107 233108	76.0 75.5	1.20 0.50	<b>B233100</b> HAN12055 HAN12100	VW UP 2011/...	<b>999cc.</b> CHYA/CHYB 60/75HP Ø74,5 (DOHC) 12V	<b>233100-R MLS</b> pág. 577



# AUDI / VOLKSWAGEN

## JUNTA TAPA DE CILINDROS / HEAD GASKETS

### MOTORES NAFTA Y DIESEL / PETROL AND DIESEL ENGINES

	Código Code	Q	≠	Kit Bulón Bolt Set	Aplicación Application	Motor Engine	Juego
	233307 233308	78.0 77.5	1.20 0.60	B231700  HAN12055 HAN12100	Audi A3 FSI 2003/... VW Golf, Touran, Passat, Jetta FSI 2005/... Eos, Polo, Crosspolo 2006/...	1598cc. BAG/BLP/BLF/BTS/BLF 105/115HP Ø76.5 (DOHC) 16V	233300-R MLS pág. 579
	233307 233308	78.0 77.5	1.20 0.60	B231700  HAN12055 HAN12100	VW Golf TSI 2005/07, Jetta TSI, Tiguan TSI 2006/...	1390cc. BLG/BMY/BWK/CAVA 140/170HP Ø76.5 (DOHC) 16V	233900-R MLS pág. 582
	233407 233408	77.3 77.3	1.20 0.60	B233400	VW Suran, Suran Cross, Saveiro Novo Fox, Gol Rallye, Saveiro Cross 2015/...	1598cc. EA211 110HP Ø76.3 (DOHC) 16V	233400-R MLS pág. 580
	233507 233508	75.0 75.0	1.20 1.00	B233400	VW Golf TSI Generación VII	1395cc. 5G1 - BE1 150HP Ø74 (DOHC) 16 V	233500-R MLS pág. 581
	234007-1M 234007-2M 234007-3M 234008-1M 234008-2M 234008-3M	84.0 84.0 84.0 84.0 84.0 84.0	1.70 1.80 1.95 1.60 1.65 1.70		Amarok TDI 2017	2967cc. DDXA 163HP Ø83 (DOHC) V6 24V	234000-R MLS pág. 583
	300705 300707	78.0 78.0	1.40 1.40	B300700  HAS17038	VW Saveiro, Voyage, Logus 1989/...	1555cc. CHT/AE 73HP Ø77 (SOHC) 8V	300700-R pág. 248
	310705	73.0	1.40	B300700  HAS17038	VW Gol 1.0 1993/...	997cc. CHT/AE (SOHC) 8V Ø70.3	310700-R pág. 282
	330507 330507-1.7 330508	96.0 96.0 96.0	1.40 1.70 1.40	B330500  HAS17038	VW LT TDI 1997/... Electronico 2002/06...	2796cc. AGK/ATA 125/132HP BCQ 158HP Ø93	330500-R pág. 370
	330507 330507-1.7 330508	96.0 96.0 96.0	1.40 1.70 1.40	B330500  HAS17038	LT TDI Electrónico 2002/06	2796cc. BCQ (SOHC) 12V 158HP Ø93	331100-R MLS pág. 372
	923507	93.5	1.76		VW Taro 1989/94	2337cc. 4Y 94HP Ø91 (OHV) 8V	923500-R 352

**VOLKSWAGEN**



Motor/Engine	Cm³	HP	Ø
Air Cooler	1285	39/43	77

Volkswagen: Kombi, Escarabajo, Fusca  
1969/...



Nº OE	Descripción/Description	Mat.	Ref.
<b>1111980072</b>	<b>Jgo. de juntas para motor</b>		<b>220300-R</b>
113101841F	Junta tapa válvulas	CG 2	220310
111251261	Jgo. múltiple escape (4)	FCH 1	220315
311129707	Unión admisión B 32 x 38 x 2.4 CN	CN 2	220317
04019856910	Jgo. juntas carburador	VS	220320
N-13778-1	Base carburador	NB 1	220325
	Junta	NB 1	220325-1
111115111A	Cuerpo bomba aceite	NB 1	220327
	Tapa filtro aceite	NB 1	220327-1
113127313	Base bomba nafta	NB 1	220328
111115131B	Tapa filtro aceite	NB 1	220329-1
113101219	Respiradero motor	NB 2	220330
	Junta	NB 1	220330-1
113127311	Base bomba nafta inferior	NB 1	220331
029/15189/1	Bomba AC block	FCH 2	220431
	Junta base carburador	NB 4	150232
112115189	Cuerpo bomba aceite	NB 2	220332
113109345A	Tubo balancines G19 x 28 x 5.4	GS 16	220333
311117151A	Tubo radiador aceite	GS	220334
311129707B	Tubo admisión	NB 2	220335
113101125	O'ring G 10 x 4	GS 6	220336
N-13830-1	O'ring G 7.59 x 2.62	GS 4	220338
113251236	Tubo precalentador	NB	220341
	Tubo radiador AC	AC	220342
	Volante motor		220344
	Ventilador dinamo	AC 1	220345
040/129795/3	Separador carburador		220349
	Jgo. juntas caja velocidades	NB	220350
	Junta	NB 1	220371
	Junta	NB 1	220372
	Anillo B 14 x 20 x 2 CN	CN 1	
	Anillo B 18 x 22 x 2.4 CN	CN 1	
	Arandela A 6 x 10 x 0.8 C	H 6	
	Guarnición G 9 x 21 x 6	GS 4	
	O'ring G 21.82 x 3.53	GS 1	
	Anillo G 7 x 12.5 x 3	GS 8	
	Radiador aceite G 9 x 14 x 10	GS 4	
	O'ring volante G 54 x 3	GS 1	
	Jgo. juntas suplemento camisa (0.20) (4)	NB 1	220370-0.20
	Retén bancada 70 x 90 x 10	P 1	R220311P

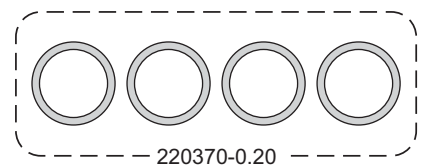
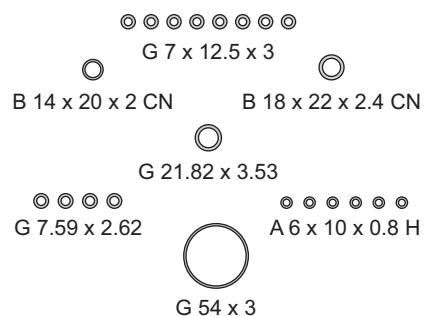
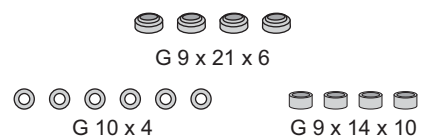
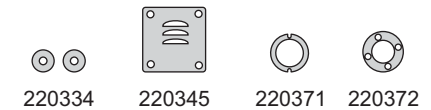
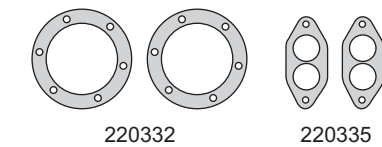
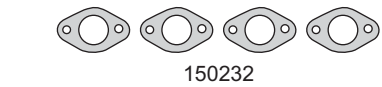
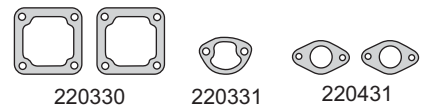
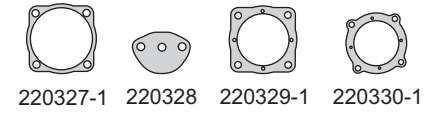
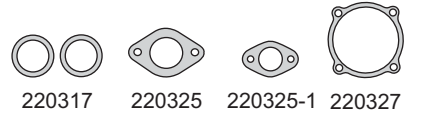
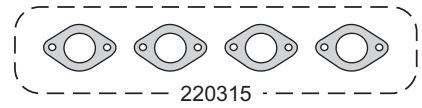
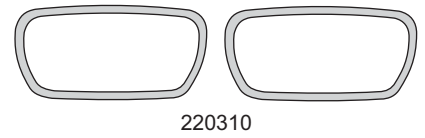

# VOLKSWAGEN



Motor/Engine	Cm³	HP	Ø
EH/GH/JB/FT/V/Y/P	1457	70/85/110	79.5
YH/Y/P/Y/T/Y/K/Y/W	1588	75/85/110	79.5
YS/Y/Z/Y/N/V/Y/V/Z	1588	75/85/110	79.5
FN/FP/FS/FT/FR/FV	1588	75/110	79.5
WP/EM/WV/WY/Y/N	1588	75/110	79.5
EN/WT	1714	77/80	79.5

**Audi:** 4000, 80, 4E, 100, Fox 1979/83  
Coupe 1980/81, 4000, 1981/83

**Volkswagen:** Caddy, Passat, Dasher (USA)  
Jetta, Scirocco, Golf, Santana  
Gacel, Caribe, Atlantic  
1975/84

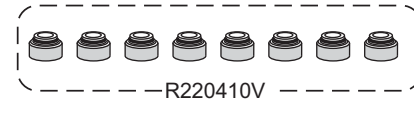
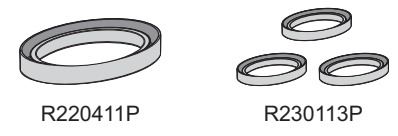
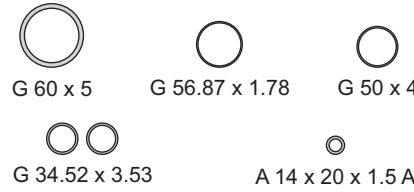
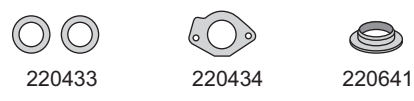
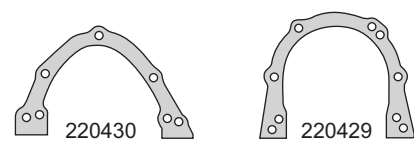
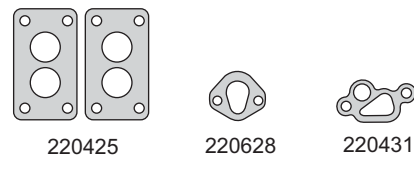
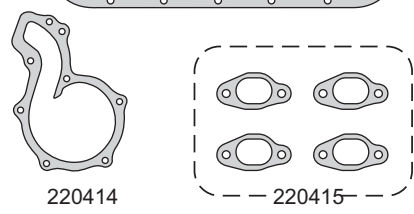
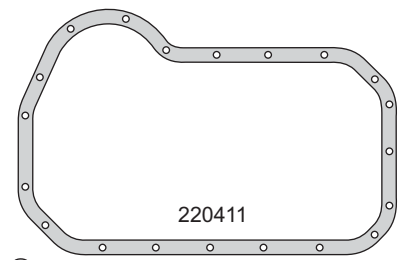
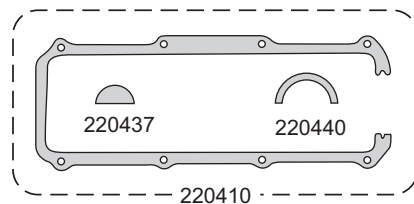
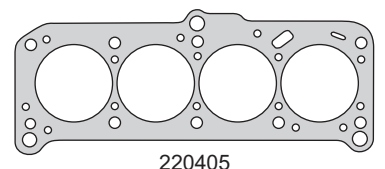

Nº OE	Descripción/Description	Mat.	Ref.
	Jgo. de juntas para motor		220400-R
	Jgo. de juntas superior		220495
049103383A	Jta. tapa cilindros Ø 81.0 ± 1.70	NFT 1 1	220405
049103383A	Jta. tapa cilindros Ø 81.0 ± 1.70	NFT	220407
	Jgo. tornillos tapa cilin. (HAN12055/12100)		B220400
056103483C	Conj. juntas tapa válvulas (3)	CG 1 1	220410
056103609A	Junta para cárter	CG 1	220411
056121041A	Bomba de agua	NB 1	220414
056129589A	Jgo. múltiple escape (4)	FCH 1 1	220415
056129717	Múltiple admisión	NB 1 1	220417
841253115B	Salida de escape	NFT 1 1	220418
056121139A	Entrada agua	NB 1 1	220419
	Jgo. juntas carburador WEBER	VS	220420
059129799D	Base carburador	NB 2 2	220425
056115441	Base filtro aceite	NB 1	220427
	Junta base bomba nafta	NB 1	220628
056103181	Bancada trasera	NB 1	220429
056103161	Bancada delantera	NB 1	220430
029/15189/1	Bomba AC block	NB 1	220431
0261297971	Base intermedia admisión		220432
056905261	Base distribuidor	CB 2	220433
026121149	Termostato	NB 1 1	220434
N/901814/01	O'ring base radiador aceite G 60 x 5	GS 1	220436
056103491	Media luna tapa cilindros	GS 1 1	220437
026/121/149	O'ring termostato G 50 x 4	GS 1	220438
059/127311/A	O'ring bomba nafta G 34.59 x 2.62	GS	220439
056103489A	Cuello tapa válvulas superior	S 1 1	220440
	Guarnición conducto admisión	N 1	220641
	O'ring porta retén distribución G 56.87 x 1.78	GS 1	220442
	Jgo. juntas caja velocidades 5ta.	CB	220450
	Jgo. juntas caja velocidades 4ta. 1ra. serie	VS	220451
	Jgo. juntas caja velocidades 4ta. 2da. serie	VS	220452
	O'ring G 34.52 x 3.53	GS 2 2	
029/103608/1	Arandela tapón cárter A 14 x 20 x 1.5 A	AL 1	
	Kit de retenes completo		R220400
026/109675	Jgo. retén válvulas (8)	V 1	R220410V
	Retén bancada 85 x 105 x 12	P 1	R220411P
026/103085/E	Retén distrib. y árbol levas 32 x 47 x 10	P 3	R230113P

VW-FORD



Motor/Engine

Cm<sup>3</sup>

HP

Ø



 AP  
 AP  
 (SOHC) 8V
1595  
178170  
85/8781  
81

Ford:

 Del Rey, Belina 1989/91  
 Escort, Scala, Pampa 1989/...  
 Verona, Royale, Versailles 1990/96

Volkswagen:

 Gacel, Senda, Voyage, Gol  
 Santana, Passat, Logus  
 Apollo 1984/...

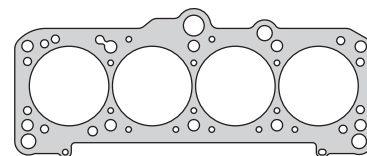

Nº OE	Descripción/Description	Mat.	Ref.
	Jgo. de juntas para motor		220600-R
	Jgo. de juntas superior		220695
	Jgo. de juntas superior		220697
026103383	Jta. tapa cilindros Ø 82.2 ± 1.70	NFT 1 1	220605
026103383	Jta. tapa cilindros Ø 82.2 ± 1.70	NFT	220607
	Jgo. tornillos tapa cilin. (HAN12055/12100)		B220400
056103483D	Conjunto tapa válvulas superior (3)	CG 1 1	220410
0491036091	Junta para cárter	NFT 1	220611
049121041B	Bomba de agua	NB 1	220614
056129589	Jgo. múltiple escape (4)	FCH 1 1	220415
	Múltiple admisión	NB 1 1	220417
02129717	Múltiple admisión	NB 1 1	220617
841253115B	Salida de escape	FCH 1 1	220418
	Salida de escape Gol GLZ	CHA	220618
056121139A	Entrada agua	NB 1 1	220419
	Jgo. juntas carburador SOLEX 2E7	VS	220620
026/198569	Jgo. juntas carburador BROSOL	VS	220621
	Jgo. jtas. inyección electrónica (Fic-Visteon-Eec IV)	VS	220424
	Jgo. jtas. inyección electrónica (Magnetti Marelli)	VS	220624
	Base carburador SOLEX 2 EJ	NB 2 2	220625
	Base carburador	NB 1	230025
056115441	Base filtro de aceite	NB 1	220427
059127311A	Base bomba nafta	NB 1	220628
056103181	Bancada trasera	NB 1	220429
	Base carburador BROSOL	NB 1 1	220629
056103161	Bancada delantera	NB 1	220430
029/115189/1	Bomba de aceite a block	NB 1	220431
	Base intermedia admisión		220432
056905261	Base distribuidor	CB 2	220433
056121149	Termostato	NB 1 1	220434
N/901814/01	O'ring base radiador aceite G 60 x 5	GS 1	220436
056103491	Media luna tapa cilindros	GS 1 1	220437
059/121119/	Termostato o'ring G 50 x 4	GS 1	220438
059/127311/A	O'ring bomba nafta G 34,59 x 2,62	GS	220439
056103489A	Cuello tapa válvulas superior	S 1 1	220440
	Unión caño de escape	H	220640
	Guarnición conducto admisión	N 1 1	220641
	O'ring porta retén distribución G 56.87 x 1.78	GS 1	220442
547253115A	Salida de escape Orion	NFT	220642
025/251509/	Catalizador gases	NFT	220644
	Jgo. juntas caja velocidades 5ta.	VS	220450
	Jgo. suplemento tapa de cilindros	AC	220685-0.50
	Jta. tapa cilindros competición (1.00)	NFT	220690-1.00
	Jta. tapa cilindros competición (1.20)	NFT	220690-1.20
	Jta. tapa cilindros competición (1.40)	NFT	220690-1.40
029/103608/1	Arandela tapón cárter A 14 x 20 x 1.5 A	AL 2 1	
	O'ring G 34.52 x 3.53	GS 2 2	
	Kit de retenes completo		R220400
026/109675//	Jgo. retén válvulas (8)	V 1	R220410V
048/10305/	Retén bancada 85 x 105 x 12	P 1	R220411P
026/103085/E	Retén distribución y árbol levas 32 x 47 x 10	P 3	R230113P

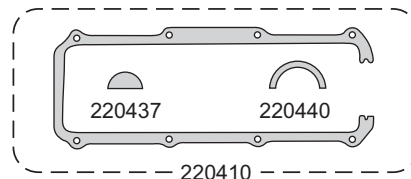

220605

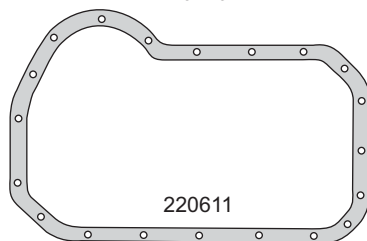

220410



220611

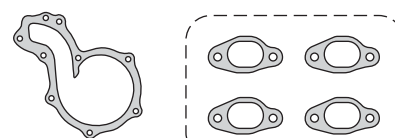

220614

220415



220417



220617

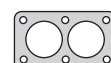

220418



220419



220618



230025



220625



220427



220628



220429



220430



220629



220431



220433



220434



220641



A 14 x 20 x 1.5 A

G 56.87 x 1.78



G 60 x 5



G 34.52 x 3.53



G 50 x 4



R220411P



R230113P



R220410V

# VOLKSWAGEN



Motor/Engine	Cm³	HP	Ø
ZC/YJ/FL/FB FD/FH/FK (SOHC) 8V	1457	65/85	76.5

**Volkswagen:** Passat, Golf, Dasher (USA)  
Scirocco, Rabbit  
Brasil 1974/82

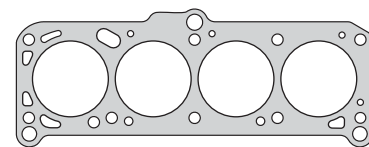

220805

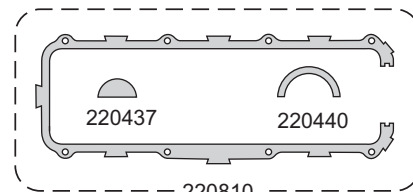

220810

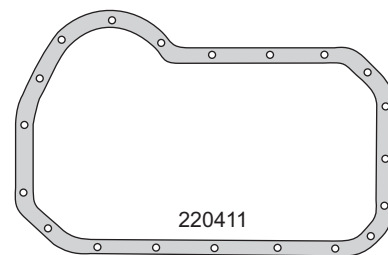

220411



220414

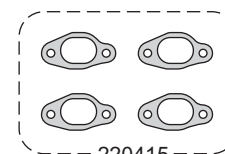

220415



220417



230118



220419



220427



220825



220628

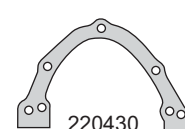

220430



220429



220433



A 14 x 18 x 1.5 A



220434



G 34.52 x 3.53



G 56.4 x 2



G 50 x 4



R220411P



R230113P



R220410V

Nº OE	Descripción/Description	Mat.	Ref.
	Jgo. de juntas para motor		220800
	Jgo. de juntas superior		220895
	Junta tapa cilindros Ø 79.0 ±1.70	NFT 1 1	220805
	Jgo. tornillos tapa cilin. (HAN12055/12100)		B220400
	Junta tapa válvulas (3)	CG 1 1	220810
056103609A	Junta para cárter	CG 1 1	220411
056121041A	Bomba de agua	NB 1 1	220414
056129589A	Jgo. múltiple escape (4)	FCH 1 1	220415
056129717	Múltiple admisión	NB 1 1	220417
056129717	Salida de escape	NFT 1 1	230118
056121139A	Entrada agua	NB 1 1	220419
	Base carburador	NB 1 1	220825
056115441	Base filtro aceite	NB 1 1	220427
059127311A	Base bomba nafta	NB 1 1	220628
056103161	Bancada trasera	NB 1 1	220429
056103181	Bancada delantera	NB 1 1	220430
056905261	Base distribuidor	CB 2 2	220433
056121149	Termostato	NB 1 1	220434
056103491	Medialuna tapa cilindros	GS 1 1	220437
026121119	O´ring termostato G 50 x 4	GS 1 1	220438
056103489A	Cuello tapa válvulas superior	GS 1 1	220440
	Arandela A 14 x 18 x 1.5 A	AL 1 1	
	O´ring G 34.52 x 3.53	GS 2 2	
	O´ring distribución G 56.4 x 2	GS 1 1	
	Kit de retenes completo		R220400
026/109675	Jgo. retén válvulas (8)	V 1 1	R220410V
	Retén bancada 85 x 105 x 12	P 1 1	R220411P
026/103085/E	Retén distrib. y árbol de levas 32 x 47 x 10	P 1 1	R230113P

# VOLKSWAGEN



Motor/Engine	Cm³	HP	Ø
ATU/AWF/AWG ABA/AKR/AGG (SOHC) 8V	1984	115	82.5

Volkswagen: Golf, Passat 1992/96  
Polo 1999/..., Golf Cabrio 1999/02  
Desde Motor 031252



Nº OE	Descripción/Description	Mat.	Ref.
	Jgo. de juntas para motor		221000-R
037198012L	Jgo. de juntas superior	●	221095
	Jgo. de juntas superior (MLS)		221095 MLS
	Junta tapa cilindros Ø 83.5 ± 1.60	NFT	221005
048103383B	Junta tapa cilindros Ø 83.5 ± 1.60 N.R.	NFT	221007
037103383N	Junta tapa cilindros Ø 83.5 ± 1.50 N.R.	MLS	221008
0291034831	Jgo. tornillos tapa cilin. (HAN12055/12100)		B220400
051103483E	Junta tapa válvulas superior (goma/metal)	ACP	1 1 230310
044103609D	Junta para cárter	NFT	1 220611
056103609A	Junta brida termostato	NB	1 1 230113
029129589B	Jgo. múltiple escape AGG (4)	FCH	1 1 230215
037253039D	Múltiple escape ATU/AKR	MLS	221015
037129717C	Múltiple admisión AWF/AWG/ATU	NFT	1 1 221017
048129717A	Múltiple admisión AKR/AGG/ATU	NFT	1 1 221417
028/115441/C	Base filtro de aceite	NB	1 230227
056103181	Bancada trasera	NB	1 220429
056103161	Bancada delantera	NB	1 220430
06A129717F	Entre colector admisión	NFT	221031
059121119	O´ring termostato G 50 x4	GS	2 220438
547253115A	Salida de escape	NFT	220642
N013849.2	Arandela tapón cárter A 14 x 20 x 1.5 A	AL	1
	O´ring G 28.17 x 3.53	GS	1
	O´ring G 34.59 x 2.62	GS	1
	O´ring G 36.09 x 3.53	GS	1 2
	O´ring G 56.87 x 1.78	GS	1
	Kit de retenes completo		R230300
027/109675	Jgo. retén válvulas (8)	V	1 R230210V
068/103171/F	Retén bancada 85 x 105 x 12	P	1 R220411P
068/103085E	Retén distrib. y árbol levas 32 x 47 x 10	P	3 R230113P

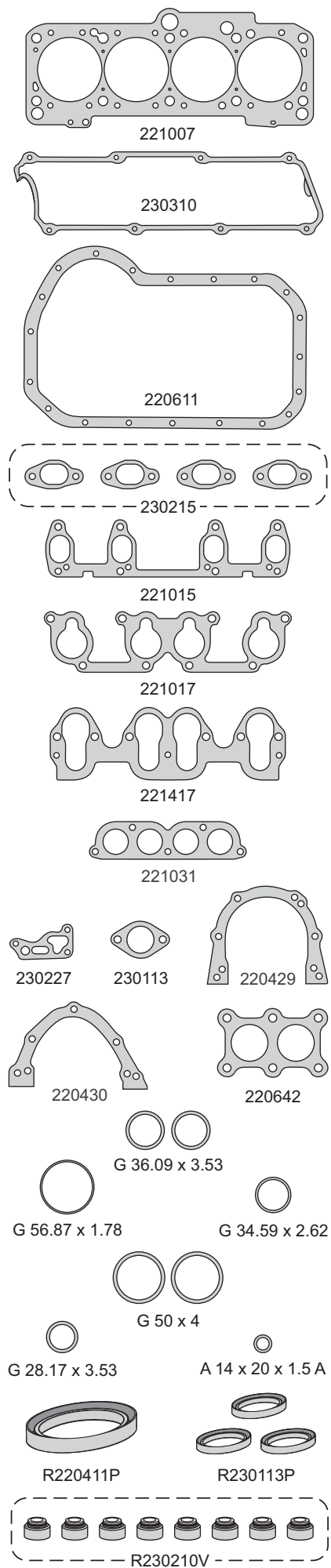

# VOLKSWAGEN



Motor/Engine	Cm³	HP	Ø
AAB/AJA (SOHC) 10V	2370	75/78	79.5
<b>DIESEL</b>			

**Volkswagen:** Transporter T4 1992/99  
Transporter Syncro 1992/98  
Eurovan, Caravelle 1997/...



Nº OE	Descripción/Description	Mat.	Ref.
	Jgo. de juntas para motor		221101-R
	Jgo. de juntas superior		221195
074103383M	Junta tapa cilindros Ø 81.0 ± 1.50	NFT	221107-1M
074103383N	Junta tapa cilindros Ø 81.0 ± 1.60	NFT	221107-2M
074103383P	Junta tapa cilindros Ø 81.0 ± 1.70	NFT	221107-3M
	Jgo. tornillos tapa cilin. (HAN12055/12100)		B221100
074103483B	Conj. junta tapa válvulas (9)	P	1 1 221110
074103609F	Junta para cárter	NFT	1 221111
	Frente motor - filtro aceite	NB	1 221112
	Junta brida termostato	NB	1 1 230113
	Frente motor - filtro aceite	SLS	1 221113
026129589A	Jgo. múltiple escape 230215/1 (5)	FCH	1 1 221115
074129717	Múltiple admisión	NFT	1 1 221117
	Arandela pico inyector A 6.5 x 13.7 x 1.25	AC	5 5 230922
	Acople bomba aceite	NB	1 221127
	Porta retén bancada trasero	NB	1 220429
	Chupador bomba aceite	NB	1 221129
	Anillo tapa válvulas inferior	GS	4 4 230230
	Guarnición goma	N	1 1 221130
	Anillo tapa válvulas superior	GS	4 4 230231
	Anillo sello goma G 58 x 2	GS	1 1
	O´ring G 45 x 3	GS	1 1
	O´ring G 23.47 x 2.62	GS	1 1
	O´ring G 26.64 x 2.62	GS	1
	O´ring G 64.77 x 2.62	GS	1
	O´ring G 59.92 x 3.53	GS	1
	O´ring G 98.02 x 3.53	GS	1
	O´ring G 28.24 x 2.62	GS	1
	O´ring G 21.89 x 2.62	GS	1
	O´ring G 36.17 x 2.62	GS	2
	O´ring G 34.52 x 3.53	GS	2
	Arandela B 28 x 34 x 3 CN	CN	2
	Arandela A 8 x 13 x 2.5 C	CU	5 5
	Kit de retenes completo		R221100
026109675	Jgo. retén válvulas (10)	V	1 R221110V
068103051P	Retén bancada 85 x 105 x 12	V	1 R220411V
069115147C	Retén árbol de levas 35 x 48 x 7	V	1 R240013V
068103085E	Retén árbol de levas 32 x 47 x 10	V	2 R230113V

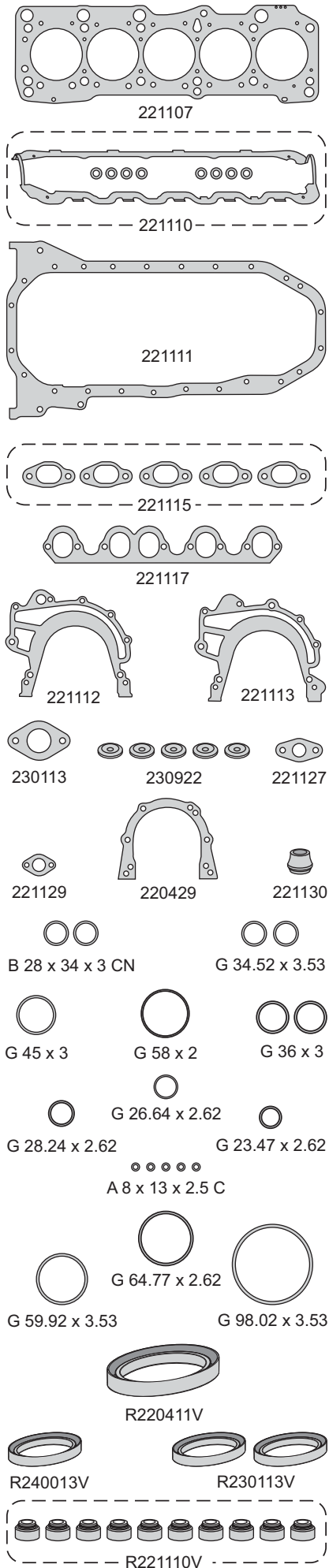

**VOLKSWAGEN**



Motor/Engine	Cm³	HP	Ø
PD ACC (SOHC) 16V	1781 1969	67 84	81 81

Volkswagen: Transporter T4 1990/03



Nº OE	Descripción/Description	Mat.	Ref.
	Jgo. de juntas para motor		221400-R
	Jgo. de juntas superior	●	221495
	Junta tapa cilindros Ø 82.2 ± 1.70	NFT	230305
026103383	Junta tapa cilindros Ø 82.2 ± 1.70	NFT 1	230307
050103383A	Junta tapa cilindros Ø 82.5 ± 1.60	MLS	230308
	Jgo. tornillos tapa cilin. (HAN12055/12100)		B220400
056103483C	Conj. tapa válvulas superior (3)	CG 1	220410
	Junta para cárter	NB 1	240611
049121041B	Bomba de agua	NB 2	220614
	Jgo. múltiple escape (4)	FCH 1	230215
	Múltiple admisión	NFT 1	220617E
	Múltiple admisión	NFT 1	221417
	Salida de escape	NFT 1	221418
056121139A	Entrada agua	NB 1	220419
028/115441/C	Base filtro aceite	NB 1	230227
	Junta base bomba nafta	NB 1	220628
056103181	Bancada trasera	NB 1	220429
056103161	Bancada delantera	NB 1	220430
029/15189/1	Bomba AC block	NB 1	220431
056103491	Media luna tapa cilindros	GS 1	220437
059/121/119	O ring termostato G 50 x 4	GS 1	220438
056103489A	Cuello tapa válvulas superior	GS 1	220440
	Guarnición conducto admisión	N 1	220641
547253115A	Salida de escape Orion	NFT 1	220642
	Salida de escape	NFT 1	220645
	Arandela tapón cárter A 14 x 20 x 1.5 A	AL 1	
	Arandela A 10 x 14 x 1 C	CU 1	
	O ring G 36.17 x 2.62	GS 1	
	O ring G 37 x 3	GS 2	
	Kit de retenes completo		R220400
026/109675//	Jgo. retén válvulas (8)	V 1	R220410V
	Retén bancada 85 x 105 x 12	P 1	R220411P
026/103085/E	Retén distribución y árbol levas 32 x 47 x 10	P 3	R230113P

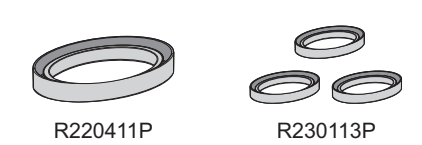
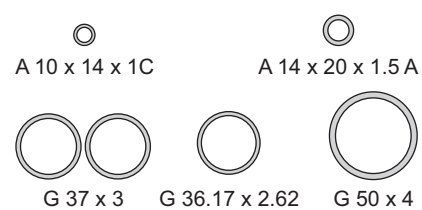
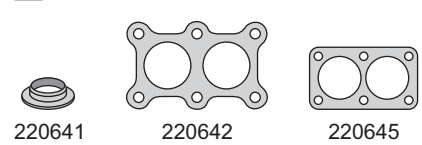
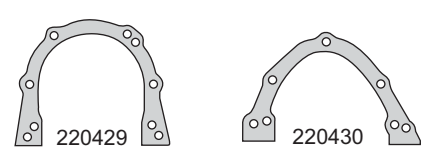
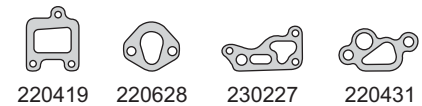
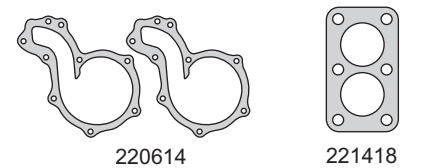
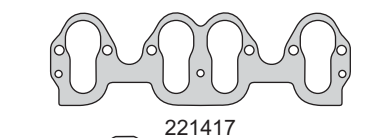
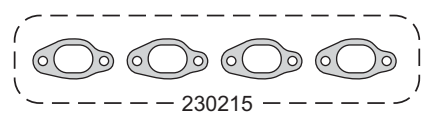
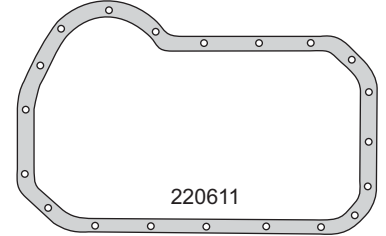
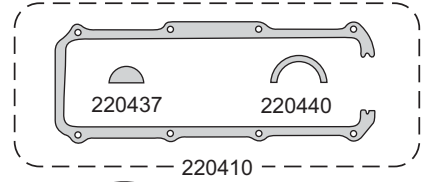
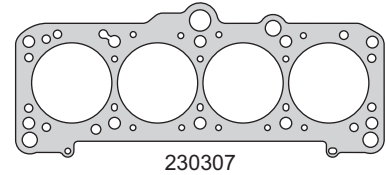



# VOLKSWAGEN



Motor/Engine	Cm³	HP	Ø
AJT	2459	88	81
AGX	2459	75	81
ACV (SOHC) 10V	2459	102	81

**Volkswagen:** Transporter T4 1998/...  
Transporter Syncro TDI 1998/...  
Transporter T4 TDI 1995/99  
LT SDI 1996/...

DIESEL



Nº OE	Descripción/Description	Mat.	Ref.
	Jgo. de juntas para motor		221501-R
074103383R	Junta tapa de cilindros Ø 82.0 ± 1.50	NFT	221507-1M
074103383S	Junta tapa de cilindros Ø 82.0 ± 1.60	NFT	221507-2M
074103383T	Junta tapa de cilindros Ø 82.0 ± 1.70	NFT	221507-3M
	Jgo. tornillos tapa cilindros (HAN12055/12100)		B221100
074103483B	Conj. junta tapa válvulas (9)	P	221110
074103609F	Junta para cárter	NFT	221111
	Junta frente motor - filtro aceite	NB	221112
	Junta brida termostato	NB	230113
	Junta frente motor - filtro aceite	SLS	221113
026129589A	Jgo. múltiple escape 23215/1 (5)	FCH	221115
079129717	Múltiple admisión	NFT	221117
	Arandela pico inyector A 6.5 x 13.7 x 1.25	AC	230922
	Acople bomba aceite	NB	221127
	Porta retén bancada trasero	NB	220429
	Chupador bomba aceite	NB	221129
	Anillo tapa válvulas inferior	GS	230230
	Guarnición goma	GS	221130
	Anillo tapa válvulas superior	GS	230231
	Anillo sello goma G 58.6 x 2	GS	
	O´ring G 45 x 3	GS	
	O´ring G 36 x 3	GS	
	O´ring G 23.47 x 2.62	GS	
	O´ring G 27 x 2	GS	
	O´ring G 65 x 3	GS	
	O´ring G 60 x 3.4	GS	
	O´ring G 97 x 4	GS	
	O´ring G 28.2 x 2.6	GS	
	Arandela B 26.4 x 32 x 2 CN	CN	
	Kit de retenes completo		R221100
026109675	Jgo. retén válvulas (10)	V	R221110V
068103051P	Retén bancada 85 x 105 x 12	V	R220411V
068103085E	Retén árbol de levas 32 x 47 x 10	V	R230113V
069115147C	Retén árbol de levas 35 x 48 x 7	V	R240013V

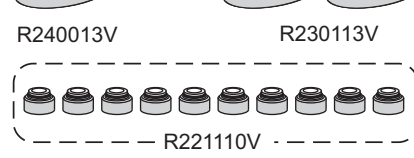
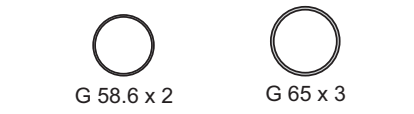
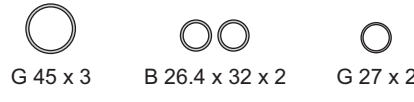
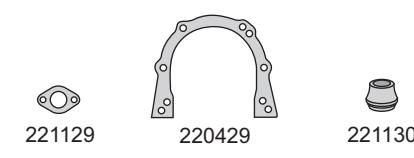
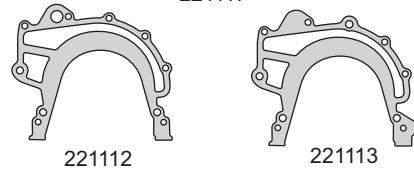
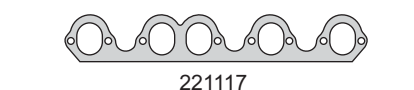
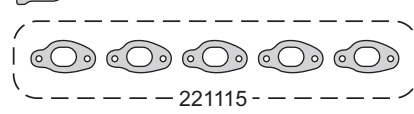
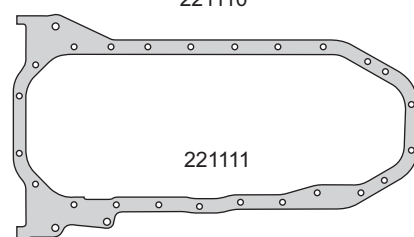
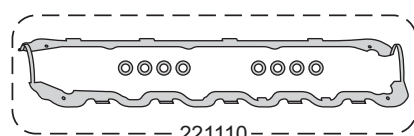
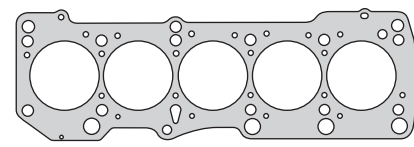

# VOLKSWAGEN



Motor/Engine	Cm³	HP	Ø
AAM/ABS/ADZ (SOHC) 8V	1781	75/90	81

Seat: Cordoba, Toledo, Ibiza 1994/97  
 Volkswagen: Vento 1992/97, Passat 1991/96



Nº OE	Descripción/Description	Mat.	Ref.
	Jgo. de juntas superior	●	221695-R
	Junta tapa cilindros Ø 82.2 ±1.70	NFT	230305
026103383	Junta tapa cilindros Ø 82.2 ±1.70	NFT	1 230307
050103383A	Junta tapa cilindros Ø 82.5 ±1.60	MLS	230308
	Jgo. tornillos tapa cilindros (HAN12055/12100)		B220400
0291034831	Junta tapa válvulas superior (goma/metal)	N	1 230310
	Múltiple escape	NFT	1 221615
	Múltiple admisión	NFT	1 220617E
059/121/119	O´ring termostato G 50 x 4	GS	220438
	Guarnición conducto admisión	N	1 220641
	O´ring G 36 x 3	GS	2
026/109675//	Jgo. retén válvulas (8)	V	1 R220410V
026/103085/E	Retén distribución y árbol levas 32 x 47 x 10	P	1 R230113P

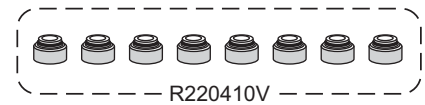
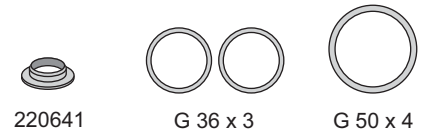
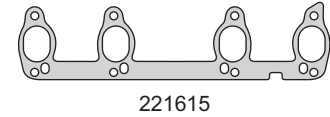
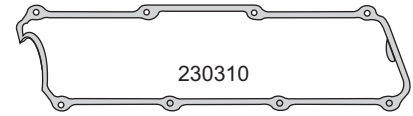
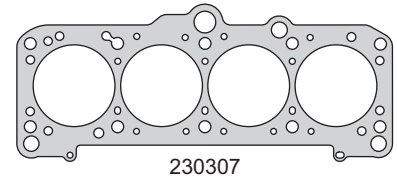

# VOLKSWAGEN



Motor/Engine	Cm³	HP	Ø
ARG/APT	1781	125	81
AJP/AGU/AQA	1781	125/150	81
ARZ/AWV/AWC	1781	150	81
AJH/AJQ/APP (DOHC) 20V	1781	150/180	81

**Audi:** A3, A3 Quattro 1998/...  
A6 1997/..., A3 Turbo 1996/...

**Seat:** Alhambra, Leon Turbo 1998/...

**Volkswagen:** Golf, Sharan 1997/..., Bora 2000/...  
New Beetle, Passat Turbo 1999/...

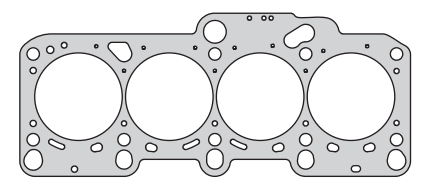

221707

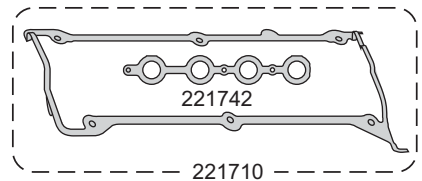

221742

221710

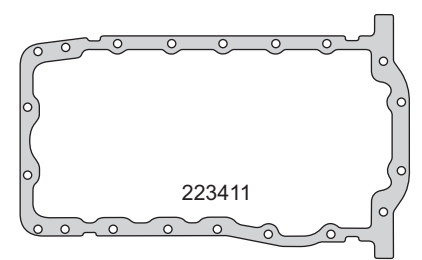

223411



221715



221717



221741



221718

230227

221829



220642

G 56.87 x 1.78

221744



B 28 x 34 x 3 CN

G 34.59 x 2.62

G 28.24 x 2.62

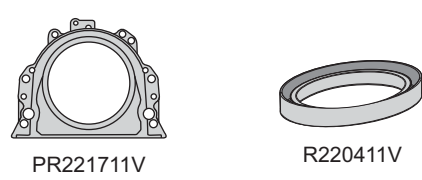

PR221711V

R220411V



R230113V

R240013P

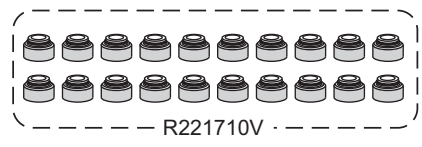

R221710V

Nº OE	Descripción/Description	Mat.	Ref.
	Jgo. de juntas para motor		221700-R
	Jgo. de juntas superior		221795
	Jgo. de juntas superior (MLS)		221795 MLS
	Junta tapa cilindros Ø 82.0 ± 1.50	NFT	221705
058103383K	Junta tapa cilindros Ø 82.0 ± 1.50	NFT	1 1 221707
058103383K	Junta tapa cilindros Ø 82.5 ± 1.40	MLS	221708
	Jgo. tornillos tapa cilindros (HAR10168)		B221700
	Sellador líquido - caucho de silicona		TRN0085G
06A103609C	Conjunto de juntas tapa válvulas (2)	ACP	1 1 221710
	Junta para cárter	NFT	1 223411
058129717B	Múltiple escape	AC	1 1 221715
	Múltiple admisión	NFT	1 1 221717
	Salida de escape ARZ/AGU	GFT	1 1 221718
	Junta base filtro aceite	NB	1 230227
06A133398I	Guarnición bomba aceite	GS	221829
	Jgo. múltiple admisión (4) AGN	N	1 221741
533253115D	Cabezal tapa de cilindros	ACP	1 1 221742
	Salida de escape AGN	NFT	1 220642
	Junta	AC	1 1 221744
	O´ring G 56.87 x 1.78	GS	1
	O´ring G 34.59 x 2.62	GS	1
	O´ring G 28.24 x 2.62	GS	1
036109675	Arandela B 28 x 34 x 3 CN	CN	1
	Kit retenes completo		R221700
0681030518	Jgo. retén válvulas (20)	V	1 R221710V
	Porta retén bancada	V	PR221711V
	Retén bancada 85 x 105 x 12	V	1 R220411V
068103085E	Retén árbol de levas 32 x 47 x 10	V	2 R230113V
	Retén árbol de levas 35 x 48 x 7	P	1 R240013P

**VOLKSWAGEN**



Motor/Engine	Cm³	HP	Ø
AFY/ADR AEB/AJL/ANB (DOHC) 20V	1781	115/125 150/180	81 81

**Audi:** A4, A4 Turbo 1994/...  
A6, A6 Turbo 1995/...  
Cabrio 1997/..., A6 Quattro 1999/...

**Volkswagen:** Passat 1996/99 - 1999/...  
Passat Turbo 1996/98



Nº OE	Descripción/Description	Mat.	Ref.
	Jgo. de juntas para motor		221800-R
	Jgo. de juntas superior		221895
058103383K	Junta tapa cilindros Ø 82.0 ± 1.50 N.R. (6)	NFT	1 221707
058103383K	Junta tapa cilindros Ø 82.5 ± 1.40 N.R. (6)	MLS	1 221708
	Jgo. tornillos tapa cilindros (HAR10168)		B221800
06A103609C	Conj. juntas tapa válvulas (2)	ACP	1 1 221710
058103609	Junta para cárter	NFT	1 221811
058253039G	Múltiple escape	AC	1 1 221715
058129717B	Múltiple admisión	NFT	1 1 221717
	Salida de escape	GFT	1 221718
	Junta base filtro aceite	NH	230227
	Junta bancada delantera	NB	1 220429
	Guarnición bomba aceite	GS	221829
	Junta bancada trasera	NB	1 220430
026121119	O´ring termostato G 50 x 4	GS	1 220438
	Cabezal tapa de cilindros	ACP	1 1 221742
	O´ring G 56.87 x 1.78	GS	1
	O´ring G 28.24 x 2.62	GS	1 1
	O´ring G 36 x 3	GS	1 2
	Arandela tapón cárter A 14 x 20 x 1.5 A	AL	1
036109675	Arandela B 28 x 34 x 3 CN	CN	1
	Kit de retenes completo		R221700
0681030518	Jgo. retén válvulas (20)	V	1 R221710V
	Porta retén bancada	V	PR221711V
	Retén bancada 85 x 105 x 12	V	1 R220411V
068103085E	Retén árbol de levas 32 x 47 x 10	V	2 R230113V
	Retén árbol de levas 35 x 48 x 7	P	1 R240013P

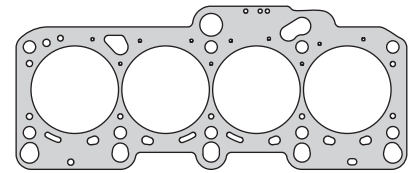

221707

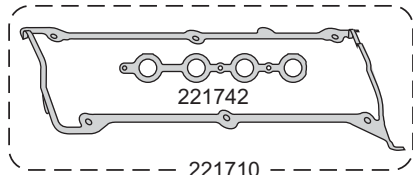

221742

221710

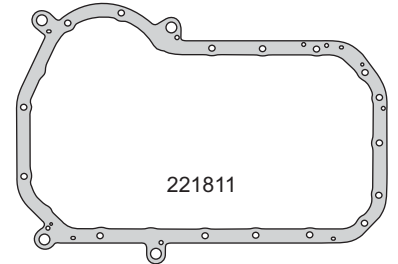

221811

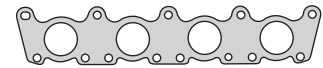

221715



221717



221718



230227



221829

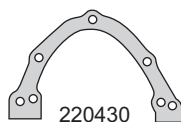

220430

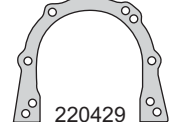

220429



B 28 x 34 x 3 CN



A 14 x 20 x 1.5 A



G 36 x 3



G 56.87 x 1.78



G 50 x 4



G 28.24 x 2.62

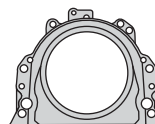

PR221711V



R220411V

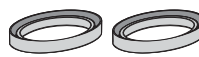

R230113V



R240013P



R221710V

# VOLKSWAGEN



Motor/Engine	Cm³	HP	Ø
ABF (DOHC) 16V	1985	150	82.5

**Seat:** Toledo 1994/99  
Ibiza, Cordoba 1996/99  
**Volkswagen:** Golf, Passat 1992/96  
**Hasta Motor 031251**



Nº OE	Descripción/Description	Mat.	Ref.
	Jgo. de juntas para motor		221900-R
	Jgo. de juntas superior	●	221995-R
	Jta. tapa cilindros Ø 83.5 ± 1.70	NFT	1 1 221907
	Jgo. tornillos tapa cilin. (HAN12055/12100)		B221900
	Conj. junta tapa válvulas (3)	P	1 1 221910
	Junta para cárter	ACP	1 230311
	Tapa bomba de agua	NB	1 220614
	Jgo. múltiple escape (4)	NFT	1 1 221915
	Múltiple admisión	NFT	1 1 221917
	Base filtro aceite	NB	1 230227
	Junta bancada trasera	NB	1 220429
	Junta bancada trasera	NB	1 220430
	Junta base termostato	NB	1 1 221930
	Junta	N	1 1 221931
	Junta cierre de tapa cilindros	S	2 2 220437
	Múltiple admisión	NFT	1 1 221938
	Salida de escape	NFT	1 220642
	Guarnición cabezal	GS	1 1 221942
	O'ring G 28.24 x 2.62	GS	1 1
	O'ring G 34.52 x 3.53	GS	2
	O'ring G 36.17 x 2.62	GS	1 1
	O'ring G 50 x 4	GS	1
	O'ring G 60 x 5	GS	1
	Arandela A 10 x 13 x 1 C	CU	1 1
	Arandela A 14 x 18 x 1.5 A	AL	1 1
	Arandela A 14 x 20 x 1 C	AL	1
	Kit de retenes completo		R221900
	Jgo. retén válvula (16)	V	1 1 R260610V
	Retén de bancada 85 x 105 x 12	V	1 R220411V
	Retén distrib. y árbol de levas 32 x 47 x 10	V	1 3 R230113V

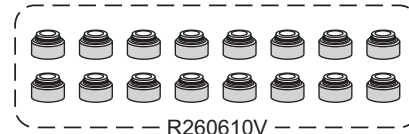
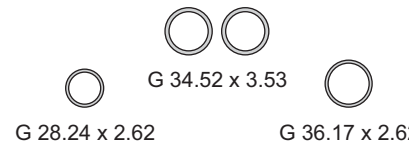
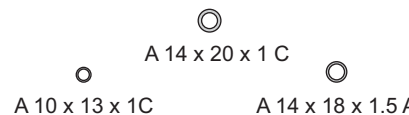
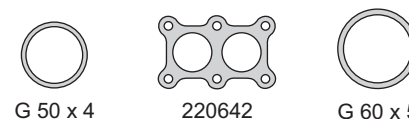
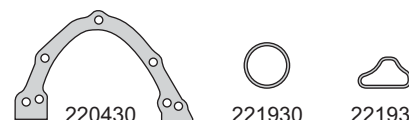
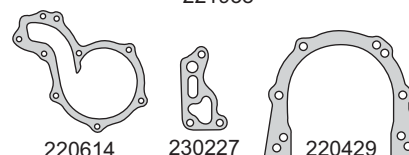
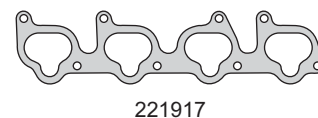
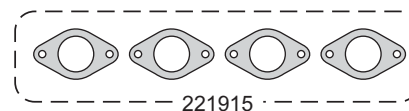
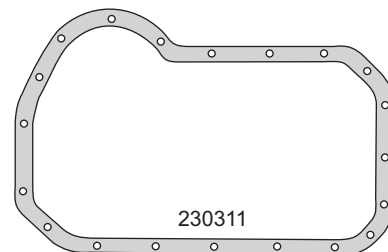
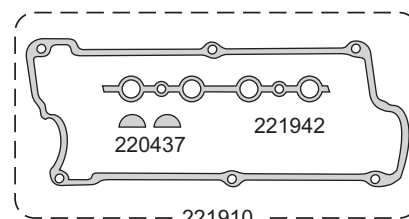
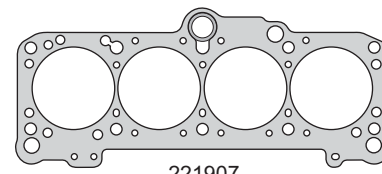

# VOLKSWAGEN



Motor/Engine	Cm³	HP	Ø
AAU	1043	45	75
HZ/AAK/ACM	1043	45/50	75
2G/AAV/UN/NU	1272	55/70	75
ABD (SOHC) 8V	1391	60	75

**Seat:** Ibiza 1993/94 - 1993/99  
**Volkswagen:** Golf, Jetta 1985/91, Polo 1985/94  
 Golf, Jetta, Polo 1985/92 - 1987/94  
 Golf, Vento 1991/94



Nº OE	Descripción/Description	Mat.	Ref.
	Jgo. de juntas para motor		222000-R
	Jgo. de juntas superior	●	222095
	Jta. tapa cilindros Ø 76.0 $\pm$ 1.60  NR²	NFT 1 1	222007
	Jgo. tornillos tapa cilin.  HAN12055/12100		B220400
	Junta tapa válvulas	GS 1 1	222010
	Junta para cárter	NH 1 1	222011
	Junta distribución	NB 1 1	222012
	Junta distribución	NB 1 1	222013
	Jgo. múltiple escape (2)	NFT 1 1	222015
	Múltiple admisión	SLS 1 1	222017
	Arandela goma	N 3 3	222029
	Junta bancada delantera	NB 1 1	220429
	Junta distribución	NB 1 1	222040
	Arandela A 14 x 20 x 1.5C	CU 1 1	
	O´ring G 60 x 4	GS 1 1	
	O´ring G 88.49 x 3.53	GS 1 1	
	O´ring G 29.82 x 2.62	GS 1 1	
	O´ring G 42.52 x 2.62	GS 1 1	
	O´ring G 42 x 4	GS 2 2	
	O´ring G 50 x 4	GS 1 1	
	Kit de retenes completo		R222000
	Jgo. retén válvulas (8)	V 1 1	R220410V
	Retén de bancada 85 x 105 x 12	V 1 1	R220411V
	Retén árbol de levas 32 x 47 x 10	V 2 2	R230113V

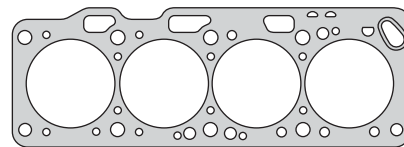

222007

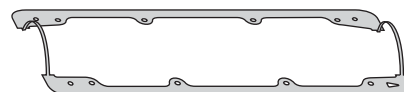

222010

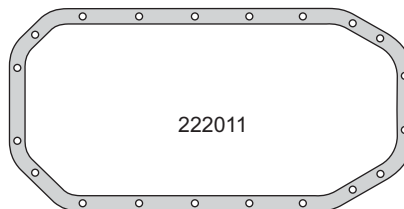

222011

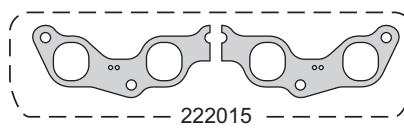

222015



202017

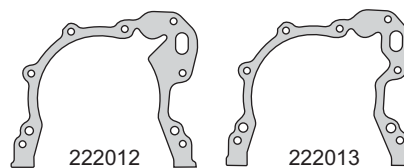

222012

222013



222029

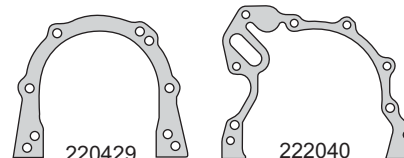

2220429

222040

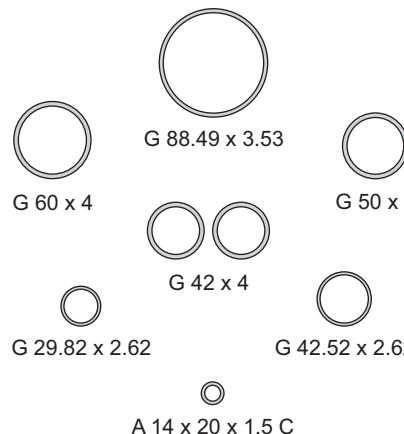

G 60 x 4

G 88.49 x 3.53

G 50 x 4

G 42 x 4

G 29.82 x 2.62

G 42.52 x 2.62

A 14 x 20 x 1.5 C



R220411V



R230113V



R220410V

# VOLKSWAGEN



Motor/Engine	Cm³	HP	Ø
ABF (DOHC) 16V	1985	150	82.5

Seat: Cordoba, Ibiza, Toledo 1993/99  
 Volkswagen: Golf, Passat, Passat Variant 1992/97



Nº OE	Descripción/Description	Mat.	Ref.
	Jgo. de juntas para motor		222100-R
037198012F	Jgo. de juntas superior	●	222195
0481033837	Jta. tapa cilindros Ø 83.5 $\pm$ 1.65  NR	MLS 1 1	222108
037129583B	Jgo. tornillos tapa cilin.  (HAN12055/12100)		B221900
0441036090	Junta para cárter	NFT	220611
03712958913	Jgo. múltiple escape (4)	NFT 1 1	221915
037129717E	Múltiple admisión	NFT 1 1	221917
0371297176	Múltiple admisión	NFT 1 1	221938
05332531150	Salida de escape	NFT 1 1	220642
013849150	Arandela tapón cárter A 14 x 20 x 1.5 C	CU 1	
	Arandela A 10 x 13 x 1 C	CU 1 1	
	Arandela B 28 x 34 x 3 CN	CN 1 1	
	O´ring G 28.24 x 2.62	GS 1 1	
	O´ring G 36.17 x 2.62	GS 1 1	
	O´ring G 42.52 x 2.62	GS 1 1	
059121119	O´ring bomba de agua G 50 x 4		1
	Kit de retenes completo		R221900
027109675	Jgo. retén válvulas (16)	V 1	R260610V
068103051P	Retén bancada 85 x 105 x 12	V 1	R220411V
068103085E	Retén distrib. y árbol levas 32 x 47 x 10	V 3	R230113V

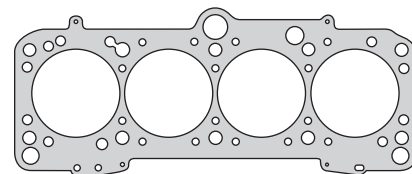

222108

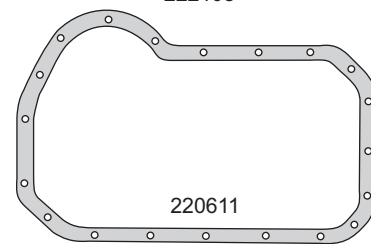

220611

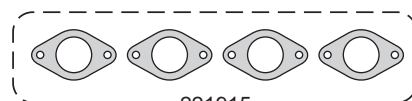

221915



221917



221938



220642



A 14 x 20 x 1.5 C



B 28 x 34 x 3 CN



A 10 x 13 x 1 C



G 42.52 x 2.62



G 28.24 x 2.62



G 36.17 x 2.62



G 50 x 4



R220411V



R230113V

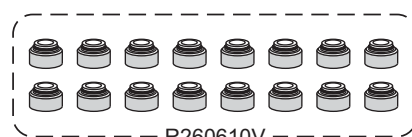

R260610V

# VOLKSWAGEN



Motor/Engine	Cm³	HP	Ø
JS/HP/SK/KP	1994	113/115	81
KZ/KU/HY/KV (SOHC) 10V	2226	115/137	81

**Audi:** 80, 80 Quattro, Coupe 1983/86  
90, 100 1984/88, 200, 100  
Coupe, 90, 90 Quattro 1984/91

**Volkswagen:** Passat, Santana 1983/88  
Passat, Quantum 1985/88



Nº OE	Descripción/Description	Mat.	Ref.
	Jgo. de juntas para motor		222200-R
	Jgo. de juntas superior	●	222295
	Jta. tapa cilindros Ø 83.0 $\pm$ 1.70  NR²	NFT 1 1	222207
	Jgo. tornillos tapa cilin.  (HAN12055/12100)		B222200
	Jgo. junta tapa válvulas (3)	CG 1 1	222210
	Junta para cárter	NFT 1 1	222211
	Junta distribución	NB 1 1	221112
	Junta brida termostato	NB 1 1	230113
	Jgo. múltiple escape 230215/1 (5)	FCH 1 1	221115
	Múltiple admisión	NFT 1 1	222217
	Base carburador	NB 1 1	222225
	Acople bomba aceite	NB 1 1	221127
056103181	Junta bancada trasero	NB 1 1	220429
	Chupador bomba aceite	NB 1 1	221129
	Junta brida	NB 1 1	221331
	Junta brida	NB 1 1	222231
	Junta base distribución	CB 1 1	220433
	Junta cierre tapa válvulas	GS 1 1	220437
	Junta tapa válvulas	GS 1 1	222238
	Junta cuello tapa válvulas	GS 1 1	220440
	Junta	NB 1 1	222240
	Junta	NFT 1 1	222241
	Arandela A 14 x 20 x 1.5 C	CU 1 1	
	Arandela A 18 x 22 x 1.5 A	AL 1 1	
	Arandela A 10 x 14 x 1 C	CU 1 1	
	Arandela A 14 x 18 x 1.5 C	CU 1 1	
	O´ring G 15.6 x 1.78	V 1 1	
	O´ring G 21.89 x 2.62	GS 1 1	
	O´ring G 50.39 x 3.53	GS 1 1	
	O´ring G 59.92 x 3.53	GS 1 1	
	O´ring G 98.02 x 3.53	GS 1 1	
	O´ring G 36.17 x 2.62	GS 1 1	
	Kit de retenes completo		R221100
	Jgo. retén válvulas (10)	V 1 1	R22110V
068103051P	Retén bancada 85 x 105 x 12	V 1 1	R220411V
069115147C	Retén distribución 35 x 48 x 7	V 1 1	R240013V
	Retén árbol de levas 32 x 47 x 10	V 2 2	R230113V

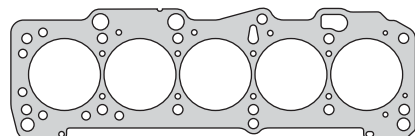

222207

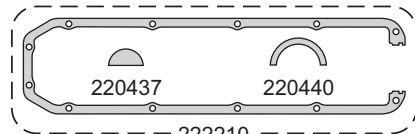

222210

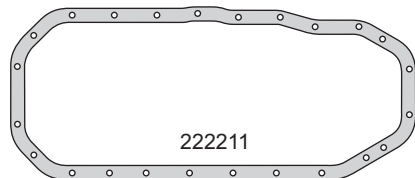

222211

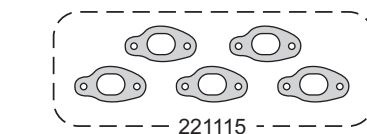

221115



222217

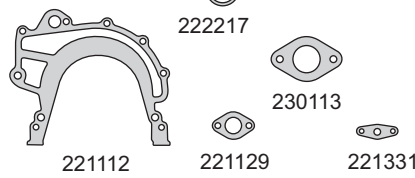

230113

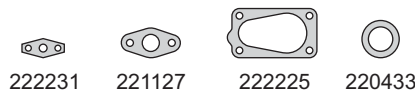

221112

221129

221331

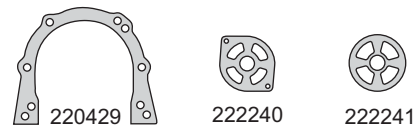

220429

222240

222241

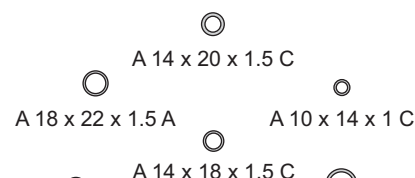

A 14 x 20 x 1.5 C

A 18 x 22 x 1.5 A

A 10 x 14 x 1 C

A 14 x 18 x 1.5 C

G 15.6 x 1.78

G 21.89 x 2.62

G 59.92 x 3.53

G 50.39 x 3.53

G 59.92 x 3.53

G 50.39 x 3.53



G 98.02 x 3.53



R220411V



R230113V

R240013V



R22110V



**VOLKSWAGEN****taranto**

Motor/Engine

Cm³

HP

Ø

ABK  
ABT  
AAE  
(SOHC) 8V

1984

115

82.5

1984

90

82.5

1984

101

82.5

**Audi:** 80 Quattro, 100 1993/95  
80 1991/95, 100 1993/94



Nº OE	Descripción/Description	Mat.	Ref.
	Jgo. de juntas superior		222595-R
	Junta tapa cilindros Ø 83.5 ± 1.70	NFT	1 221907
	Jgo. tornillos tapa cilindros (HAN12055/12100)		B220400
0291034831	Junta tapa válvulas	N	1 230310
	Múltiple escape	NFT	1 221615
	Múltiple admisión	NFT	1 220617E
	Múltiple admisión	NFT	1 221417
	O'ring G 38 x 3	V	1
	O'ring G 36 x 3	GS	2
	Arandela A 14 x 20 x 1.5 C	CU	1
026/109675//	Jgo. retén válvulas (8)	V	1 R220410V
026/103085/E	Retén de árbol de levas 32 x 47 x 10	V	1 R230113V

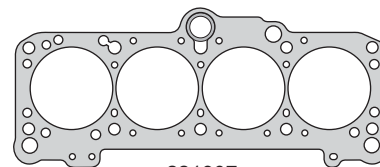

221907

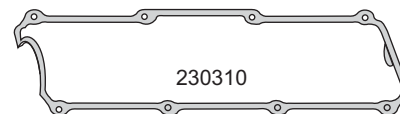

230310



221615



220617E



221417



G 38 x 3



G 36 x 3



A 14 x 20 x 1.5 C



R230113V



R220410V

# VOLKSWAGEN



Motor/Engine	Cm³	HP	Ø
AAE/AAD/ABK (SOHC) 8V	1984	101/115	82.5

**Audi:** 80 Quattro, Coupe 1990/93  
100 1990/93



Nº OE	Descripción/Description	Mat.	Ref.
	<b>Jgo. de juntas superior</b>		<b>222695-R</b>
	<b>Junta tapa cilindros Ø 83.5 ± 1.70</b>	<b>NFT 1</b>	<b>221907</b>
	<b>Jgo. tornillos tapa cilindros (HAN12055/12100)</b>		<b>B220400</b>
056103483C	Conj. junta tapa válvulas superior (3)	CG 1	220410
	Jgo. múltiple escape (4)	FCH 1	230215
	Múltiple admisión	NFT 1	220617E
	Múltiple admisión	NFT 1	221417
	Salida de escape	NFT 1	222618
056103491	Junta cierre de tapa cilindros	GS 1	220437
056103489A	Junta cuello tapa válvulas	GS 1	220440
	O´ring G 36 x 3	GS 2	
026/109675//	Jgo. retén válvulas (8)	V 1	R220410V
026/103085/E	Retén de árbol de levas 32 x 47 x 10	V 1	R230113V

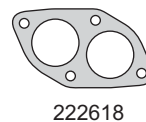
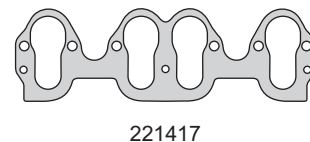
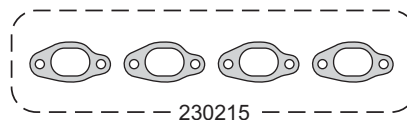
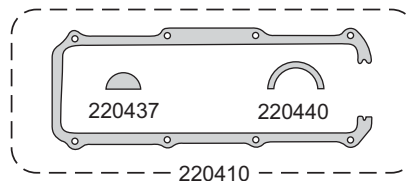
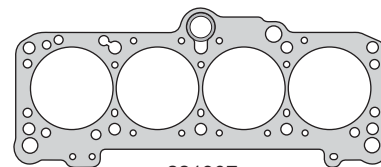

**VOLKSWAGEN****taranto**

Motor/Engine	Cm³	HP	Ø
NF (SOHC) 10V	2309	100/136	82.5

**Audi:** 100, 200 Avant, 100 Avant, Coupe  
Cabriolet, 80, 90

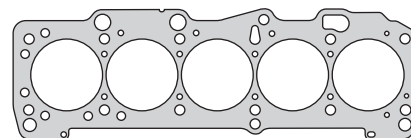

222707

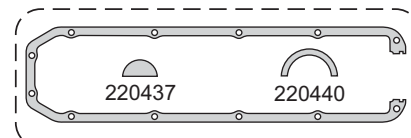

220437

220440

- 222210 -

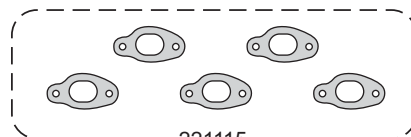

221115



222217



230113



222225



222231



220433



A 10 x 14 x 1 A



A 14 x 18 x 1.5 A



R230113V

Nº OE	Descripción/Description	Mat.	Ref.
	Jgo. de juntas superior		222795-R
	Junta tapa cilindros Ø 84.0 ± 1.70	NFT	1 222707
	Jgo. tornillos tapa cilindros (HAN12055/12100)		B222200
	Jgo. junta tapa válvulas (3)	CG	1 222210
056103609A	Junta brida termostato	NB	1 230113
028/129589/B/	Jgo. múltiple escape 230215/1 (5)	FCH	1 221115
	Múltiple admisión	NFT	1 222217
	Base carburador	NB	1 222225
	Junta brida	NB	1 222231
056905261	Junta base distribución	CB	1 220433
056103491	Junta cierre de tapa cilindros	S	1 220437
056103489A	Junta cuello tapa de válvulas	S	1 220440
	Arandela A 10 x 14 x 1 A	AL	1
	Arandela A 14 x 18 x 1.5 A	AL	4
026/103085/E	Retén árbol de levas 32 x 47 x 10	V	1 R230113V

# VOLKSWAGEN



Motor/Engine	Cm³	HP	Ø
AAR/NG (SOHC) 10V	2309	133	82.5

**Audi:** 80, 90 1985/94, Cabrio, Coupe 1990/95  
A6 1994/..., Coupe Quattro 1985/95  
80 Quattro 1991/94, 90 Quattro 1987/91



Nº OE	Descripción/Description	Mat.	Ref.
	<b>Jgo. de juntas superior</b>		<b>222895-R</b>
	<b>Junta tapa cilindros Ø 84.0 ±1.70</b>	<b>NFT 1</b>	<b>222707</b>
	<b>Jgo. tornillos tapa cilindros (HAN12055/12100)</b>		<b>B222200</b>
	Jgo. junta tapa válvulas (3)	CG 1	222210
056103609A	Junta brida termostato	NB 1	230113
028/129589/B/	Jgo. múltiple escape 230215/1 (5)	FCH 1	221115
	Múltiple admisión	NFT 1	222817
	Base carburador	NB 1	222225
	Junta brida	NB 1	222231
056905261	Junta base distribución	CB 1	220433
056103491	Junta cierre de tapa cilindros	GS 1	220437
	Múltiple admisión	NFT 1	222838
056103489A	Junta cuello tapa de válvulas	GS 1	220440
	Arandela A 10 x 14 x 1 A	AL 1	
	Arandela A 14 x 18 x 1.5 A	AL 4	
	Jgo. retén válvulas (10)	V 1	R221110V
026/103085/E	Retén árbol de levas 32 x 47 x 10	V 1	R230113V

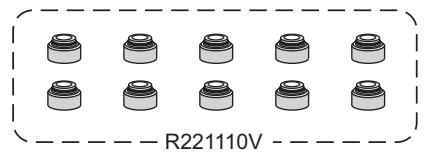
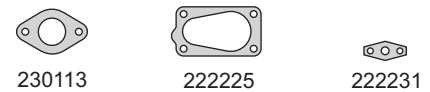
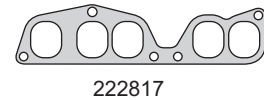
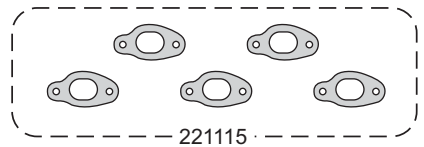
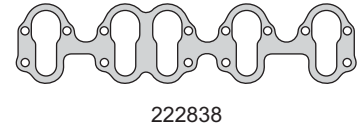
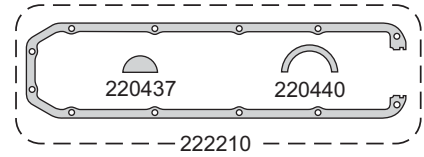
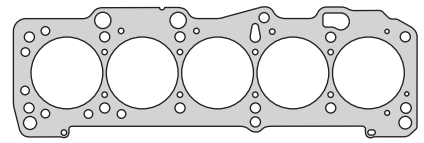





**VOLKSWAGEN****taranto**

Motor/Engine	Cm³	HP	Ø
ABC/ACZ	2598	144/150	82.5
AAH/ABC/AEJ (SOHC) V6 12V	2771	163/174	82.5

**Audi:** 80/80 Quattro, Cabriolet, 100/100 Quattro  
1991/94, A4, A4 Quattro, A6/A6 Quattro  
1994/..., 100/100 Quattro, 80/80 Quattro  
Coupe 1990/94



Nº OE	Descripción/Description	Mat.	Ref.
	Jgo. de juntas para motor	●	223000
	Jgo. junta tapa cil. Ø 83.5 $\pm$ 1.80 (2) 	NFT	1 223007
	Jgo. tornillos tapa cilindros (HAN12055/12100) 		B223000
	Jgo. múltiple escape (2) 	NFT	1 223015
	Jgo. múltiple admisión (2) 	NFT	1 223017
	Base carburador	NB	1 223025
	Entre colectores admisión 	NFT	1 223031

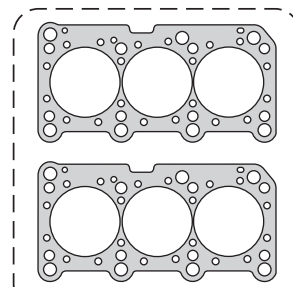

223007

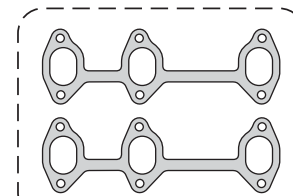

223015

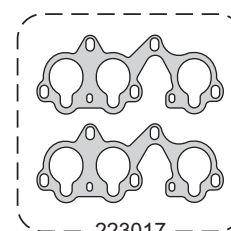

223017



223025

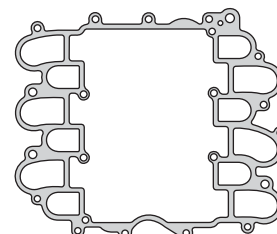

223031

# VOLKSWAGEN



Motor/Engine Cm³ HP Ø

ABU (SOHC) 8V 1598 75 76.5

Seat: Cordoba, Ibiza 1993/94  
Volkswagen: Golf, Vento 1992/94



Nº OE	Descripción/Description	Mat.	Ref.
	Jgo. de juntas superior		223395-R
	Junta tapa cilindros Ø 77.5 $\pm$ 1.60  NR	NFT 1	223307
	Jgo. tornillos tapa cilindros (HAN12055/12100)		B230300
	Junta tapa válvulas	GS 1	222010
032/253039/E	Múltiple escape	AC 1	230615
	Múltiple admisión	SLS 1	223317
	O´ring G 42.52 x 2.62	GS 1	
	O´ring G 42 x 4	GS 1	
	Jgo. retén válvulas (8)	V 1	R230210V
026/103085/E	Retén árbol de levas 32 x 47 x 10	V 1	R230113V

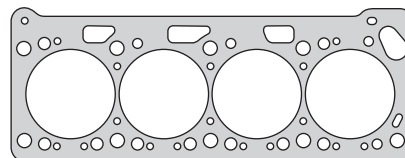

223307

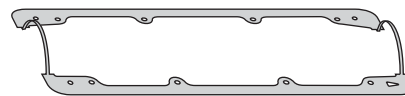

222010



230615



223317



G 42.52 x 2.62



G 42 x 4



R230113V



R230210V

# VOLKSWAGEN



Motor/Engine	Cm³	HP	Ø
ALH/AHF/AGR	1896	90/110	79.5
AGP/AHF (SOHC) 8V	1896	68/110	79.5

**Audi:** A3 TDI 1996/99  
**Skoda:** Octavia TDI 1996/...  
**Volkswagen:** Bora, Golf SDI/TDI 1997/...

DIESEL



Nº OE	Descripción/Description	Mat.	Ref.
	Jgo. de juntas para motor		223401-R
	Jgo. de juntas superior		223495
038103383G	Junta tapa cilindros Ø 81.0 $\pm$ 1.50	NFT	223407-1M
038103383F	Junta tapa cilindros Ø 81.0 $\pm$ 1.60	NFT	223407-2M
038103383L	Junta tapa cilindros Ø 81.0 $\pm$ 1.70	NFT	223407-3M
038103383AL	Junta tapa cilindros Ø 80.5 $\pm$ 1.63	MLS	223408-1M
038103383AM	Junta tapa cilindros Ø 80.5 $\pm$ 1.68	MLS	223408-2M
038103383AN	Junta tapa cilindros Ø 80.5 $\pm$ 1.78	MLS	223408-3M
	Jgo. tornillos tapa cilin. (HAN12055/12100)		B223400
	Sellador líquido - caucho de silicona		TRN0085G
	Junta para cárter	NFT	1 223411
037253039D	Jgo. múltiple escape (4)	FCH	1 1 230215
028129717D	Múltiple admisión	SLS	1 1 230217E
3A0253115	Salida de escape	AC	1 1 223418
038115441A	Soporte filtro de aceite	SLS	1 223429
	Guarnición salida aceite	N	1 1 221130
038/117070/	Junta inferior radiador	GS	3 3 223430
	Arandela tapa válvulas	NFT	3 3 223431
	Guarnición	GS	1 223432
	Junta brida	AC	1 223434
	Guarnición	GS	4 223435
046130/219A	Arandela pico inyector A 8 x 13 x 2.5 C	CU	4 4 230923
	Arandela A 14 x 20 x 1.5 C	CU	1
N/O28222/2	O´ring bomba aceite G 20 x 3.15	GS	1
	O´ring G 60 x 68 x 5.75	GS	1
038/121119/	O´ring bomba agua G 57 x 4	GS	1
N/900432/01	O´ring chupador block aceite G 10 x 2	GS	1
	Kit de retenes completo		R223400
027/106795	Jgo. retén válvulas (8)	V	1 R230210V
069115147C	Retén distribucion 35 x 48 x 7	V	1 R240013V
038103085E	Retén árbol de levas 32 x 47 x 10	V	1 R230113V

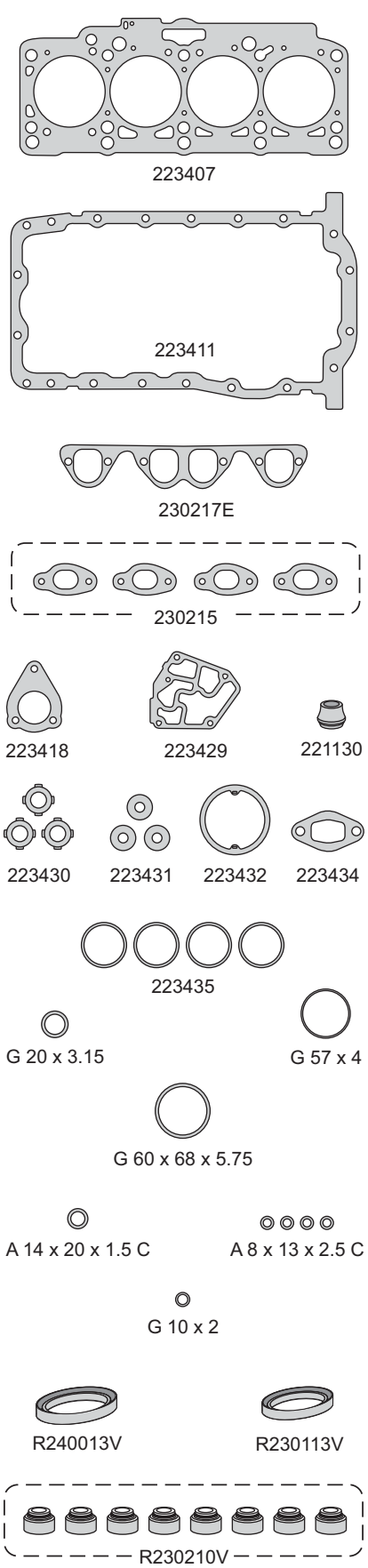

# VOLKSWAGEN



Motor/Engine	Cm³	HP	Ø
AXC	1896	85	79.5
ATJ/AUY/AXB	1896	105/115	79.5
BKE/AVF/AWX (SOHC) 8V	1896	116/130	79.5

DIESEL

**Audi:** A4 TDI 2000/2004/..., A6 TDI 2001/...  
**Ford:** Galaxy TDI 2000/...  
**Seat:** Alhambra TDI 2000/...  
**Volkswagen:** Passat TDI, Sharan TDI 1999/...  
 Transporter TDI 2003/...



Nº OE	Descripción/Description	Mat.	Ref.
	Jgo. de juntas para motor		223501-R
	Junta tapa cilindros Ø 81.0 $\pm$ 1.50	NFT	223507-1M
	Junta tapa cilindros Ø 81.0 $\pm$ 1.60	NFT	223507-2M
	Junta tapa cilindros Ø 81.0 $\pm$ 1.70	NFT	223507-3M
038103383BL	Junta tapa cilindros Ø 81.0 $\pm$ 1.48	MLS	223508-1M
038103383BM	Junta tapa cilindros Ø 81.0 $\pm$ 1.58	MLS	223508-2M
038103383BN	Junta tapa cilindros Ø 81.0 $\pm$ 1.68	MLS	223508-3M
	Jgo. tornillos tapa cilindros (HAN12055/12100)		B223500
	Sellador líquido - caucho de silicona		TRN0085G
038103483	Junta tapa válvulas	GS 1	223510
	Junta para cárter	NFT 1	223411
0372530591	Múltiple escape	AC 1	223515
028/129717/D	Múltiple admisión	NFT 1	230217
3A0253115	Salida de escape	AC 1	223418
038115441A	Junta soporte filtro aceite	SLS 1	223429
	Guarnición salida aceite	N 1	221130
	Base bomba aceite a block	NB 1	220431
	Junta brida	AC 1	223434
N/O28222/2	O´ring bomba aceite G 20.22 x 3.53	GS 1	
	O´ring G 36 x 3	GS 2	
N/900432/01	O´ring chupador block aceite G 10 x 2	GS 1	
	Kit de retenes completo		R223400
027/106795	Jgo. retén válvulas (8)	V 1	R230210V
06A103171A	Porta retén bancada trasero	T	PR230211V
038103085E	Retén distribución 35 x 48 x 7	V 1	R240013V
038103085E	Retén árbol de levas 32 x 47 x 10	V 1	R230113V

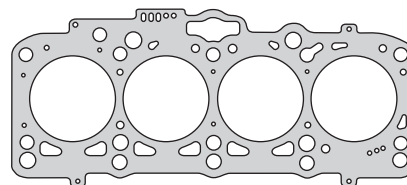

223508

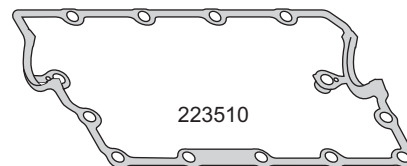

223510

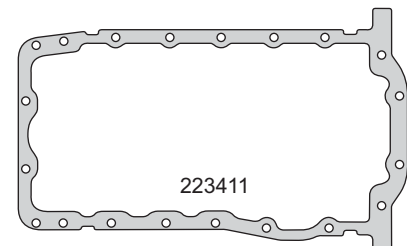

223411



223515



230217



223418



221130



220431

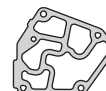

223429



223434



G 10 x 2



G 20.22 x 3.53



G 36 x 3

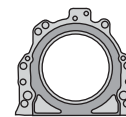

PR230211V



R240013V



R230113V

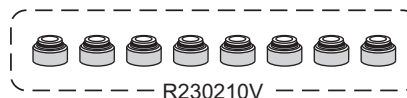

R230210V



# VOLKSWAGEN



Motor/Engine	Cm³	HP	Ø
ADL/KR/PL	1781	129/139	81
KR (DOHC) 16V	1781	130	81

**Seat:** Cordoba, Ibiza 1994/97  
Toledo GTI 1991/94

**Volkswagen:** Golf 1989/91, Scirocco 1985/92  
Jetta 1986/87, Passat, Corrado  
1990/92

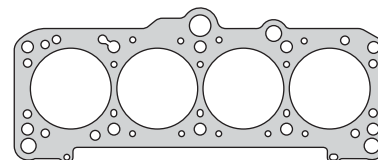

230307

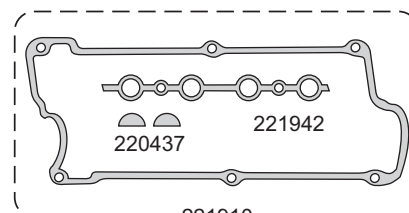

221910

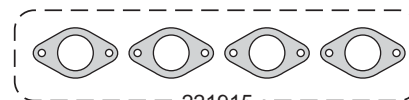

221915



221917



223817

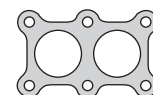

220642



221931



G 28.24 x 2.62



G 36.17 x 2.62



R230113V

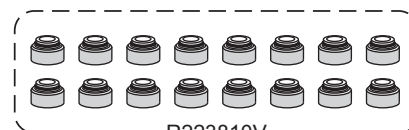

R223810V

Nº OE	Descripción/Description	Mat.	Ref.
	Jgo. de juntas superior		223895-R
	Junta tapa cilindros Ø 82.2 ± 1.70	NFT	230305
026103383	Junta tapa cilindros Ø 82.2 ± 1.70	NFT	1 230307
050103383A	Junta tapa cilindros Ø 82.5 ± 1.60	MLS	230308
	Jgo. tornillos tapa cilindros (HAN12055/12100)		B221900
	Jgo. junta tapa válvulas (3)	P	1 221910
	Jgo. múltiple escape (4)	NFT	1 221915
	Múltiple admisión	NFT	1 221917
	Múltiple admisión	NFT	1 223817
	Junta	N	1 221931
056103491	Junta cierre de tapa cilindros	GS	2 220437
547253115A	Salida de escape	NFT	1 220642
	Guarnición cabezal	GS	1 221942
	O'ring G 28.24 x 2.62	GS	1
	O'ring G 36.17 x 2.62	GS	1
	Jgo. retén válvulas (16)	V	1 R223810V
	Retén de árbol de levas 32 x 47 x 10	V	1 R230113V

**VOLKSWAGEN****taranto**

Motor/Engine

Cm<sup>3</sup>

HP

Ø

2E  
(SOHC) 8V

1984

115









82.5

Seat:

Toledo, Ibiza, Cordoba 1991/94

Volkswagen:

Golf GTI, Vento, Passat  
Corrado 1991/94

Nº OE	Descripción/Description	Mat.	Ref.
	Jgo. de juntas superior 	●	223995-R
	Junta tapa cilindros Ø 83.5 $\pm$ 1.70 	NFT 1	221907
	Jgo. tornillos tapa cilindros (HAN12055/12100) 		B220400
	Junta tapa válvulas 	N 1	230310
	Jgo. múltiple escape (4) 	FCH 1	230215
	Múltiple admisión 	NFT 1	221417
	Guarnición salida de aceite	N 1	221130
	O'ring G 36.17 x 2.62	V 2	
	Jgo. retén válvulas (8) 	V 1	R220410V
	Retén árbol de levas 32 x 47 x 10 	V 1	R230113V

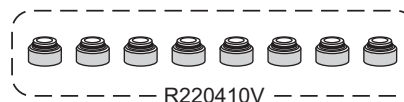
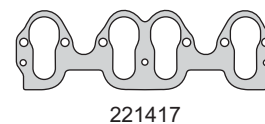
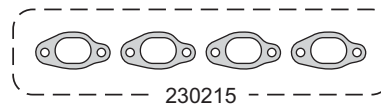
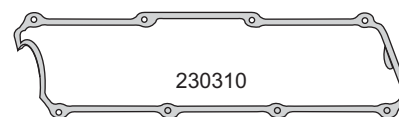
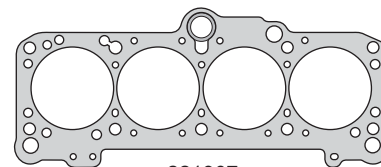

**VOLKSWAGEN****taranto**

Motor/Engine	Cm³	HP	Ø
BKR/BLM	1390	75	76.5
BAH/BJA/BLH	1598	100	76.5
BPA (SOHC) 8V	1598	100	76.5

**Seat:** Ibiza, Cordoba 2003/...

**Volkswagen:** Fox 2005/..., Polo 2003/05  
Polo, Caddy 1997/01, Gol 2001/...  
Lupo 2004/09, Fox 2005/...  
Fox Route, Suran 2006/...  
Voyage, Gol Trend

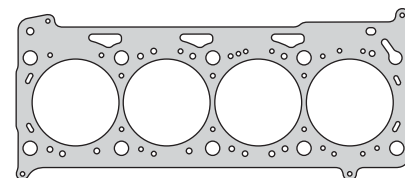

224008

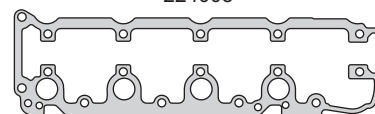

224010

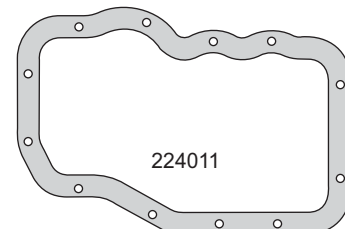

224011

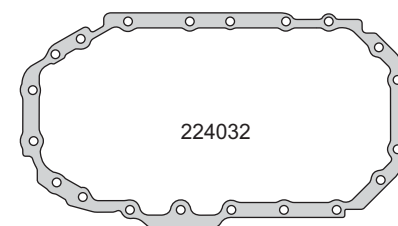

224032

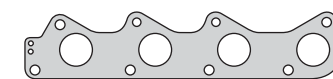

224015



230617

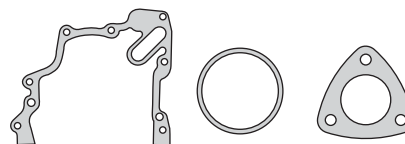

230512

230514

224218

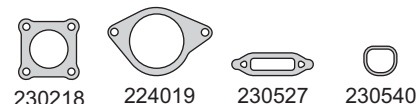

230218

224019

230527

230540

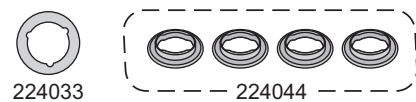

224033

224044



230541

G 28.17 x 3.53

G 7.52 x 3.53



G 47 x 4

G 60 x 4

G 64 x 69 x 5



G 32 x 4

G 36.09 x 3.53

G 30.8 x 3.7

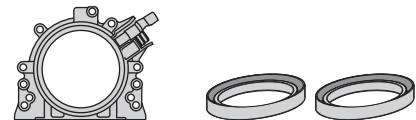

PR224011T

R230512V



R224010V

Nº OE	Descripción/Description	Mat.	Ref.
	Jgo. de juntas para motor		● 224000-R MLS
	Jgo. de juntas para motor		224000-R
	Jgo. de juntas superior (MLS)	●	224095 MLS
	Jgo. de juntas superior		224095
	Jgo. de juntas superior		224097
	Junta tapa cilindros Ø 78 $\pm$ 1.20	NFT	224005
	Junta tapa cilindros Ø 78 $\pm$ 1.20	NFT	224007
	Junta tapa cilindros Ø 78 $\pm$ 1.40	NFT	224007-1.4
032.103383.N	Junta tapa cilindros Ø 78 $\pm$ 0.40	MLS	1 1 224008
	Jgo. tornillos tapa cilin. (HAN12055/12100)		B224000
	Sellador líquido - caucho de silicona		TRN0085G
	Junta tapa válvula	NB	224010
032.103601.AA	Junta para cárter	NB	1 224011
032.103161.K	Junta distribución	SLS	1 230512
030.121043.C	O'ring bomba de agua G 66.5 x 3.5	GS	230514
030.253039.K	Múltiple escape	AC	1 1 224015
030.129717.F	Jgo. anillo admisión G 36.3 x 40.8 x 5.4 (4)	GS	1 1 230617
	Salida de escape	NFT	1 1 230218
	Salida de escape	FCH	1 1 224218
030.121005	Junta termostato	NB	1 1 224019
036.115111	Junta subida bomba aceite	SLS	1 230527
036.133073	Anillo mezcla a admisión G 64 x 69 x 5	GS	1 224031
	Junta para cárter	NB	1 224032
06A.103483.D	Guarnición llenado aceite	N	1 1 224033
036.103677	Guarnición sellado deflector	GS	230540
032.121665.A	Anillo caño bomba de agua	GS	1 230541
N.906175.01	O'ring asiento deflector G 60 x 4	GS	1 1 224035
032.121119.5	O'ring cierre termostato G 47 x 4	GS	1 2 224036
	O'ring salida termostato a block G 30.8 x 3.7	GS	1 224037
035.906149.A	O'ring pico inyector G 7.52 x 3.53	GS	8 8 224043
030.133026	Jgo. guarnición asiento inyector (4)	GS	1 1 224044
N.908560.01	Arandela tapón cárter A 14 x 20 x 1.5 A	AL	1
1H0.121687.A	O'ring llenado de agua G 28.17 x 3.53	GS	1
032.121666	O'ring caño unión bomba G 36.09 x 3.53	GS	1
N.907653.01	O'ring acople retorno radiador G 32 x 4	GS	2
	Kit de retenes completo		R224000
036.109675	Jgo. retén válvulas (8)	V	1 R224010V
030.103170	Porta retén bancada trasero	T	PR224011T
036.103085.E	Retén árbol de levas 32 x 42 x 7	V	1 R230512V
036.103085.G	Retén bomba de aceite 32 x 42 x 7	V	1 R230512V

# VOLKSWAGEN



Motor/Engine	Cm³	HP	Ø
AQZ/BJE (SOHC) 8V	999	71/72	67.1

Volkswagen: Fox 2003/...



Nº OE	Descripción/Description	Mat.	Ref.
	Jgo. de juntas para motor		224200 MLS
	Jgo. de juntas superior (MLS)	●	224295 MLS
	Jgo. de juntas superior		224295
	Junta tapa cilindros Ø 70.0 ±1.20	NFT	230505
	Junta tapa cilindros Ø 70.0 ±1.20	NFT	230507
032.103383.N	Junta tapa cilindros Ø 68.0 ±0.40	MLS	1 1 230508
032.103384.B	Jgo. tornillos tapa cilin. (HAN12055/12100)		B230500
	Junta tapa válvulas	NB	224010
032.103601.AA	Junta para cárter	NB	1 224011
032.103161.K	Junta distribución	SLS	1 230512
030.121043.C	O'ring bomba de agua G 66.27 x 3.53	GS	1 1 230514
030.253039.K	Múltiple escape	AC	1 1 224015
030.124717.F	Jgo. anillo admisión G 36.3 x 40.8 x 5.4 (4)	GS	1 1 230617
	Salida de escape	FCH	1 1 224218
030.121005	Junta termostato	NB	1 1 224019
036.115111	Junta subida bomba aceite	SLS	1 230527
036.133073	Anillo mezcla a admisión G 64 x 69 x 5	GS	1 224031
036.103677	Guarnición sellado deflector	GS	224032
06A.103483.D	Guarnición llenado aceite	GS	1 1 224033
0.32.121665.A	Anillo caño bomba de agua G 37.5 x 4	GS	224034
N.906175.01	O'ring asiento deflector G 60 x 4	GS	1 1 224035
032.121119.5	O'ring cierre termostato G 47 x 4	GS	2 224036
	O'ring salida termostato a block G 30.8 x 3.7	GS	1 224037
035.906149.A	O'ring pico inyector G 7.52 x 3.53	GS	8 8 224043
030.133026	Jgo. guarnición asiento inyector G 26.5 x 5.8 (4)	GS	224044
N.908560.01	Arandela tapón cárter A 14 x 20 x 1.5 A	AL	1
1H0.121687.A	O'ring llenado de agua G 28.17 x 3.53	GS	1
032.121666	O'ring caño unión bomba G 36.09 x 3.53	GS	1
N.907653.01	O'ring acople retorno radiador G 32 x 4	GS	2
	O'ring G 20.22 x 3.53	GS	2
	Kit de retenes completo		R224000
036.109675	Jgo. retén válvulas (8)	V	R224010V
030.103170	Porta retén bancada trasero	T	PR224011T
036.103085.E	Retén árbol de levas 32 x 42 x 7	V	R230512V
036.103085.G	Retén bomba de aceite 32 x 42 x 7	V	R230512V

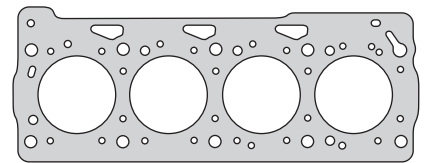

230508

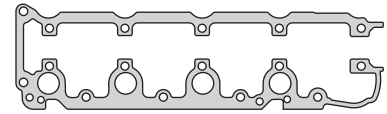

224010

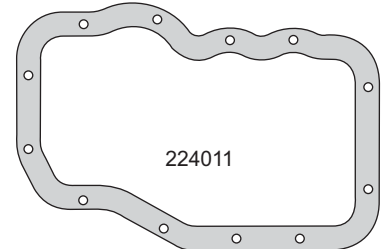

224011

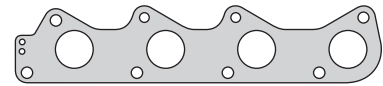

224015



230617

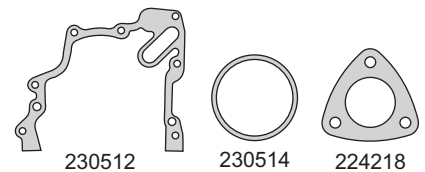

230512

230514

224218

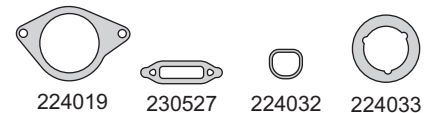

224019

230527

224032

224033

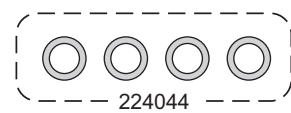

224044



A 14 x 20 x 1.5 A

G 20.22 x 3.53

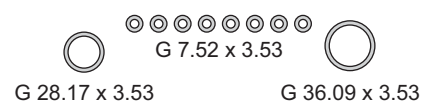

G 28.17 x 3.53

G 36.09 x 3.53



G 30.8 x 3.7

G 47 x 4

G 60 x 4



G 32 x 4

G 64 x 69 x 5

G 37.5 x 4

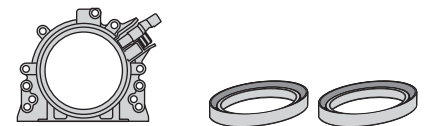

PR224011V

R230512V



R224010V

# VOLKSWAGEN



**Motor/Engine**  
AKL/AEH/APF (SOHC) 8V

**Cm³**  
1595

**HP**  
100

**Ø**  
81

**Seat:** Ibiza 2001/03 - Cordoba 2001/05  
**Volkswagen:** Derby, Bora, Passat, Golf, Polo 1999/...



Nº OE	Descripción/Description	Mat.	Ref.
	Jgo. de juntas para motor		224300-R
	Junta tapa cilindros Ø 82.5 ± 1.30	NFT	224307
0613103383	Junta tapa cilindros Ø 82.5 ± 1.20	MLS	1 224308
	Jgo. tornillos tapa cilindros (HAR10168)		B224100
051103483F	Junta tapa válvulas	GS	1 230310
	Junta tapa válvulas	GS	1 224310
058253039G	Junta para cárter	NFT	221711
037253039F	Múltiple escape	AC	1 231115
06A103398F	Jgo. múltiple admisión (4)	GS	1 224317
	Junta	SLS	1 224330
	Junta	GS	1 224331
	Guarnición	GS	1 223432
	Junta	GS	1 224332
	Junta	GS	1 224333
	Junta	GS	1 224334
	Salida de escape	NFT	1 220642
	Junta enfriador aceite	SLS	1 221743
	O´ring G 20.22 x 3.53	GS	1
	O´ring G 20.30 x 2.62	GS	1
	O´ring G 28.17 x 3.53	GS	1
	O´ring G 43 x 4	GS	1
054121119	O´ring bomba de agua G 50 x 4	GS	2
	O´ring G 7.52 x 3.53	GS	8
	Kit de retenes completo		R224300
027109675	Jgo. retén válvulas (8)	V	1 R230210V
0618103171B	Porta retén bancada	V	1 PR221711V
068103085E	Retén distribución 32 x 42 x 7	V	1 R230512V
054115147B	Retén árbol de levas 35 x 48 x 7	P	1 R240013P

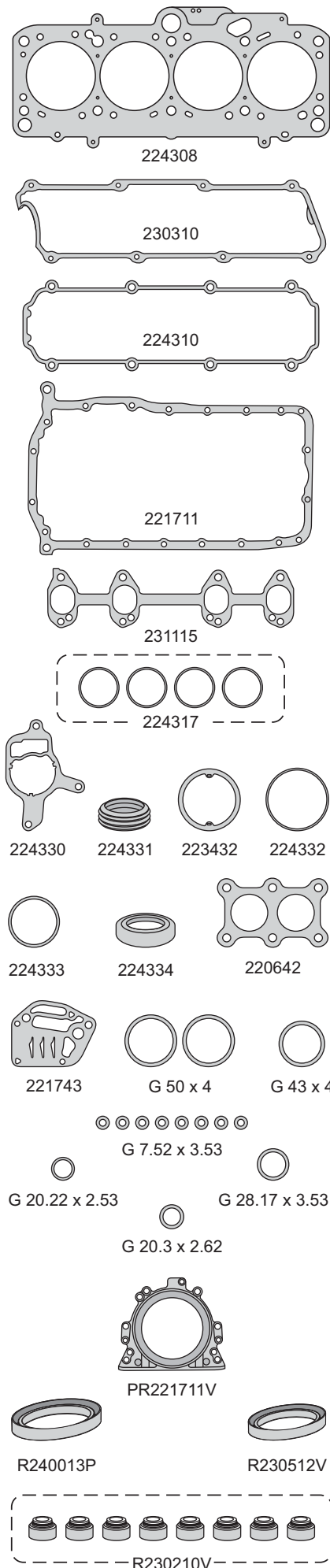

# VW - FORD



Motor/Engine	Cm³	HP	Ø
Audi 827 (SOHC) 8V	1984	107/115	82.5

**Ford:** Galaxy, Versailles, Verona  
Escort 1992/96

**Volkswagen:** Carat, Quantum, Pointer, Gol  
Golf, Santana 1989/...



Nº OE	Descripción/Description	Mat.	Ref.
	Jgo. de juntas para motor		230000-R
	Jgo. de juntas superior	●	230095
	Jgo. de juntas superior		230097
053103383	Jta. tapa cilindros Ø 83.5 ± 1.70	NFT 1 1	230005
053103383	Jta. tapa cilindros Ø 83.5 ± 1.70	NFT	230007
	Jgo. tornillos tapa cilin. (HAN12055/12100)		B220400
056103483D	Conj. juntas tapa válvulas (3)	CG 1 1	220410
0491036091	Junta para cárter	NFT 1 1	220611
049121041B	Bomba de agua	NB 1 1	220614
056129589	Jgo. múltiple escape (4)	FCH 1 1	230215
056129717	Múltiple admisión	NB 1 1	220417
026129717	Múltiple admisión	NB 1 1	220617
841253115B	Salida de escape	FCH 1 1	220418
056121139A	Entrada agua	NB 1 1	220419
026/198569/18	Jgo. juntas carburador BROSOL PIERBURG	VS	230020
	Jgo. juntas inyección electrónica monopunto	VS	230024
	Base carburador	NB 1 1	230025
	Tapa carburador	NB	230026
056115441	Base filtro aceite	NB	1 220427
059127311A	Base bomba nafta	NB	1 220628
056103181	Bancada trasera	NB	1 220429
056103161	Bancada delantera	NB	1 220430
	Bomba aceite a block	NB	1 220431
	Brida intermedia admisión		220432
056905261	Base distribuidor	CB	2 220433
056121149	Termostato	NB	1 220434
N/901814/01	O'ring base radiador aceite G 60 x 5	GS	1 220436
056103491	Media luna tapa cilindros	GS 1 1	220437
059/121119/	Termostato o'ring G 50 x 4	GS	1 220438
059/12734/1	O'ring bomba nafta G 34.59 x 2.62	GS	220439
	O'ring válvulas t/cil. a calefactor G 34.52 x 3.53	GS 2 2	220639
	Arandela acople v/escape	H	230040
056102489A	Cuello tapa válvulas superior	GS 1 1	220440
	Guarnición conducto admisión	GS 1 1	220641
	O'ring porta retén distribución G 56.87 x 1.78	GS	1 220442
	Jgo. juntas con caja velocidades Audi 827	VS	230050
	Jgo. juntas caja velocidades 5ta.	CB	220450
	Jgo. juntas con caja velocidades MQ	VS	230051
029/103608/1	Arandela tapón cárter A 14 x 20 x 1.5 A	AL	1
	Kit de retenes completo		R220400
026/109675//	Jgo. retén válvulas (8)	V 1	R220410V
048/10305/	Retén bancada 85 x 105 x 12	P 1	R220411P
026/103085/E	Retén distrib. y árbol de levas 32 x 47 x 10	P 3	R230113P

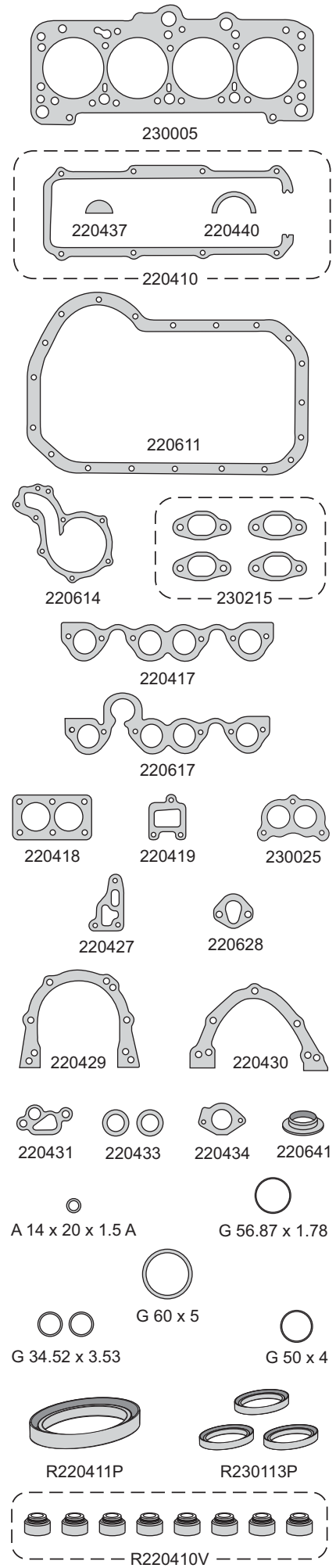

# VOLKSWAGEN



Motor/Engine	Cm³	HP	Ø
CR/JK/JP/JR/JF JX/CS/CY (SOHC) 8V	1588	49/54 70	76.5
<b>DIESEL</b>			

**Audi:** 80 D/TD 1981/85  
**Volkswagen:** Senda, Saveiro, Caddy, Golf D/TD  
 Passat, Kombi, Santana 1981/86



Nº OE	Descripción/Description	Mat.	Ref.
	Jgo. de juntas para motor		230101-R
	Jgo. de juntas superior	●	230195-1M
	Jgo. de juntas superior		230195-2M
	Jgo. de juntas superior		230195-3M
	Jgo. de juntas superior		230195-4M
	Jgo. juntas superior sin JTC		230196
	Junta tapa cilindros Ø 78.0 $\pm$ 1.45	NFT	230105-1M
	Junta tapa cilindros Ø 78.0 $\pm$ 1.55	NFT	230105-2M
	Junta tapa cilindros Ø 78.0 $\pm$ 1.65	NFT	230105-3M
	Junta tapa cilindros Ø 78.0 $\pm$ 1.75	NFT	230105-4M
068103383BC	Junta tapa cilindros Ø 78.0 $\pm$ 1.40	NFT	230107-1M
068103383BD	Junta tapa cilindros Ø 78.0 $\pm$ 1.50	NFT	230107-2M
068103383BE	Junta tapa cilindros Ø 78.0 $\pm$ 1.60	NFT	230107-3M
056103483C	Junta tapa cilindros Ø 78.0 $\pm$ 1.70	NFT	230107-4M
049/103385/A	Jgo. tornillos tapa cilin. (HAN12055/12100)		B230100
056103483C	Conj. juntas tapa válvulas (3)	CG	1 1 220410
049/103609/1	Junta para cárter	NFT	1 220611
056103609A	Brida termostato	NB	2 2 230113
	Bomba de agua	NB	1 220614
056129589A	Jgo. múltiple escape (4)	FCH	1 1 230215
056129717	Múltiple admisión	NB	1 1 220417
841253115B	Salida de escape	NFT	1 1 230118
056121139A	Entrada agua	NB	1 220419
046/1302/9A	Arandela pico inyector	AC	4 4 230922
056115441	Base filtro aceite	NB	1 220427
	Junta base bomba nafta	NB	1 220628
	Bomba alimentación	NB	230128
056103181	Bancada trasera	NB	1 220429
056103161	Bancada delantera	NB	1 220430
	Junta bomba aceite	NB	1 220431
056905261	Base distribuidor	CB	2 220433
N/013849/2/	Arandela tapón cárter B 14 x 18 x 2 CN	CN	150034
056121149	Termostato	NB	1 220434
N/901814/01/	O'ring base radiador aceite G 60 x 5	GS	1 220436
056103491	Media luna tapa cilindros	GS	1 1 220437
059/121119/	Termostato o'ring G 50 x 4	GS	1 220438
056103489A	Cuello tapa válvula superior	GS	1 1 220440
	O'ring porta retén distribución G 56.87 x 1.78	GS	1 220442
	Jgo. juntas caja velocidades 5ta.	CB	220450
	O'ring salida calefactor G 34.52 x 3.53	GS	2 2 220639
	Kit de retenes completo		R220400
026/109675//	Jgo. retén válvulas (8)	V	1 R220410V
048/103051/	Retén bancada 85 x 105 x 12	P	1 R220411P
026/103085/E	Retén distrib. y árbol levas 32 x 47 x 10	P	3 R230113P

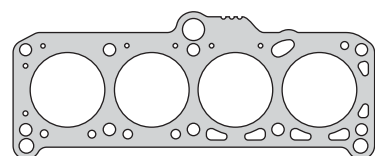

230107

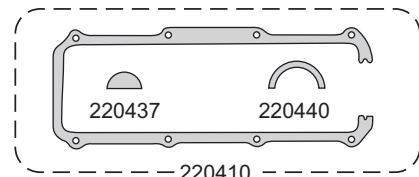

220410

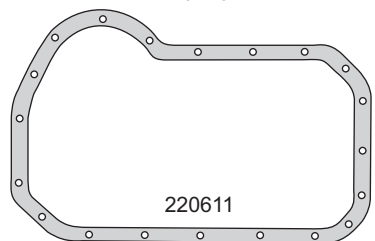

220611

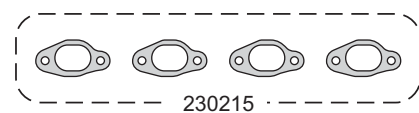

230215



220417



230922



230113



220614



230118



220419



220427



220628



220429

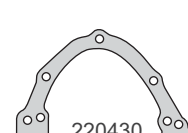

220430



220431



220433



220434



B 14 x 18 x 2 CN



G 56.87 x 1.78



G 60 x 5



G 34.52 x 3.53



G 50 x 4



R220411P



R230113P



R220410V

# VOLKSWAGEN



Motor/Engine	Cm³	HP	Ø
1Y/AAZ/AEY (SOHC) 8V	1896	64/75	79.5

**Seat:** Ibiza D/TD, Cordoba D/TD 1996/99  
Toledo 1997/99

**Volkswagen:** Passat TD 1994/96, Golf D/TD  
Vento D/TD 1995/98, Polo D  
Caddy 1995/...

DIESEL



Nº OE	Descripción/Description	Mat.	1	2	Ref.
	Jgo. de juntas para motor				230201-R
	Jgo. de juntas superior		●		230295-1M
	Jgo. de juntas superior				230295-2M
	Jgo. de juntas superior				230295-3M
	Jgo. juntas superior sin JTC				230296
	Jgo. de juntas superior (MLS)				230295-1M MLS
	Jgo. de juntas superior (MLS)				230295-2M MLS
	Jgo. de juntas superior (MLS)				230295-3M MLS
	Jta. tapa cilindros Ø 80.5 ± 1.50	NFT	1		230207-1M
	Jta. tapa cilindros Ø 80.5 ± 1.60	NFT			230207-2M
	Jta. tapa cilindros Ø 80.5 ± 1.70	NFT			230207-3M
028/103383/BH	Jta. tapa cilindros Ø 81.0 ± 1.50	MLS			230208-1M
028/103383/BJ	Jta. tapa cilindros Ø 81.0 ± 1.55	MLS			230208-2M
028/103383/BK	Jta. tapa cilindros Ø 81.0 ± 1.60	MLS			230208-3M
068/103384/A	Jgo. tornillos tapa cilin. (HAN12055/12100)				B230100
028/103483/H/	Conj. junta tapa válvulas (7)	N	1	1	230210
037/115220/B	Junta para cárter con rompeolas	ACP			230211
	Junta para cárter	NFT		1	220611
	Junta brida termostato	NB	2	2	230113
049121041B	Bomba de agua	NB		1	220614
028/129589/B/	Jgo. múltiple escape (4)	NFT	1	1	230215
028/129717/D	Múltiple admisión	NFT	1	1	230217
	Salida de escape	NFT	1	1	230218
046/103219/A	Arandela pico inyector	AC	4	4	230922
028/115441/C	Base filtro aceite	NB		1	230227
056121139A	Base filtro aceite	NB		1	220427
	Junta base bomba nafta	NB		1	220628
	Bomba alimentación	NB			230128
056103181	Bancada trasera	NB		1	220429
028/103533/	Anillo tapa válvulas	GS	3	3	230230
056103161	Bancada delantera	NB		1	220430
	Casquillo árbol levas	GS	3	3	230231
	Bomba de aceite block	NB		1	220431
	Junta base distribución	CB		1	220433
N/901814/01/	O'ring base radiador aceite G 60 x 5	GS		1	220436
059/127311/A	O'ring calefactor G 34.52 x 3.53	GS	2	2	220639
	O'ring porta retén distribución G 56.87 x 1.78	GS		1	220442
	Arandela A 7 x 13 x 1 C	CU		4	
	Arandela A 14 x 20 x 1 C	CU		2	
	O'ring G 50 x 4	GS		2	
	O'ring G 38 x 3	GS		1	
	O'ring G 31.5 x 3.2	GS		1	
	O'ring G 39 x 3	S		1	
	O'ring G 40.87 x 3.53	GS		1	
	O'ring G 20.22 x 3.53	GS		2	
N/013849/2	Arandela tapa cárter B14 x 18 x 2 CN	CN			
	Kit de retenes completo				R230200
027/109675	Jgo. retén válvulas (8) 8 mm.	P		1	R220410P
027/109675	Jgo. retén válvulas (8) 7 mm.	V		1	R230210V
	Porta retén bancada trasero	V			PR230211V
068/103171/F	Retén bancada 85 x 105 x 12	V		1	R220411V
	Retén distrib. y árbol levas 32 x 47 x 10	P		3	R230113P

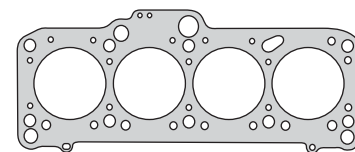

230207

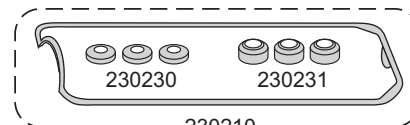

230210

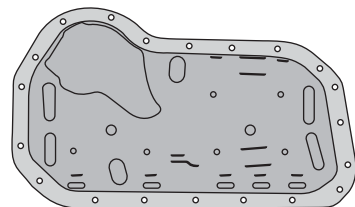

230211

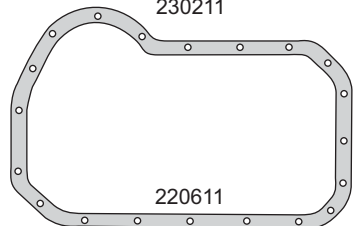

220611

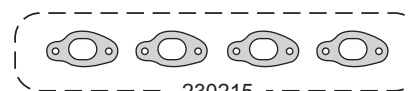

230215



230217



220614

230113



230218



230922



220427



230227



220628



220431



220433



G 38 x 3

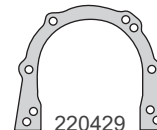

220429

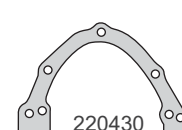

220430

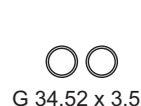

G 34.52 x 3.53



G 50 x 4



G 56.87 x 1.78

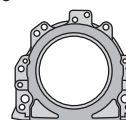

PR230211V



R220411V



R230113P



R220410P



R230210V



# VOLKSWAGEN



Motor/Engine	Cm³	HP	Ø
1F	1595	75	81
ADA/ABM	1595	71/100	81
AAM/ABS/ADZ	1781	75/90	81
ADD (SOHC) 8V	1781	75/90	81

**Audi:** 80 1993/96  
**Seat:** Ibiza, Cordoba, Toledo 1993/94  
**Volkswagen:** Caddy, Polo 1995/97  
 Golf, Vento, Polo Classic, Passat  
 Jetta 1991/99



Nº OE	Descripción/Description	Mat.	Ref.
	Jgo. de juntas para motor		230300-R
	Jgo. de juntas para motor		230300-R MLS
	Jgo. de juntas superior		230395
	Jgo. de juntas superior (MLS)		230395 MLS
	Junta tapa cilindros Ø 82.2 ± 1.70	NFT 1 1	230305
026103383	Junta tapa cilindros Ø 82.2 ± 1.70 NR	NFT	230307
050103383A	Junta tapa cilindros Ø 82.5 ± 1.60 NR	MLS	230308
	Jgo. tornillos tapa cilin. (HAN12055/12100)		B230300
0261034832	Junta tapa válvulas superior (goma/metal)	N 1 1	230310
044103609D	Junta para cárter (goma/metal)	ACP 1	230311
049121041B	Bomba de agua	NB 1	220614
	Bomba de agua (goma/metal)	AL/GS	230314
056129589	Jgo. múltiple escape (4)	FCH 1 1	230215
026129717	Múltiple admisión	NH	220617
	Múltiple admisión	NFT 1 1	230317
325/253137	Catalizador	CAC	230318
841253115B	Salida de escape	FCH	220418
547/253115/A	Salida caño de escape	FCH 1 1	220618
056121139A	Entrada agua	NB 1	220419
	Base filtro aceite	NB 1	230227
056115441	Base filtro aceite	NB 1	220427
059127311A	Base bomba nafta	NB 1	220628
056103181	Bancada trasera	NB 1	220429
056188161	Bancada delantera	NB 1	220430
	Base bomba de aceite a block	NB 1	220431
056905261	Base distribuidor	CB 2	220433
N/901814/01	O'ring base radiador aceite G 60 x 5	GS 1	220436
659/127311/A	O'ring salida t/cil. a calefactor G 34.52 x 3.53	GS 2 2	220639
	Guarnición conducto admisión	GS	220641
	O'ring porta retén distribución G 56.87 x 1.78	GS 1	220442
	Salida de escape		220642
	Catalizador gases	CNC 1 1	220644
059/121119/	O'ring termostato G 50 x 4	GS 1	
029/103608/1	Arandela cárter A 14 x 20 x 1 C	CU 1	
	Kit de retenes completo		R230300
	Jgo. retén válvulas Ø7 mm. (8)	V 1	R230210V
048/10305/	Retén bancada 85 x 105 x 12	P 1	R220411P
026/103085/E	Retén distrib. y árbol levas 32 x 47 x 10	P 3	R230113P

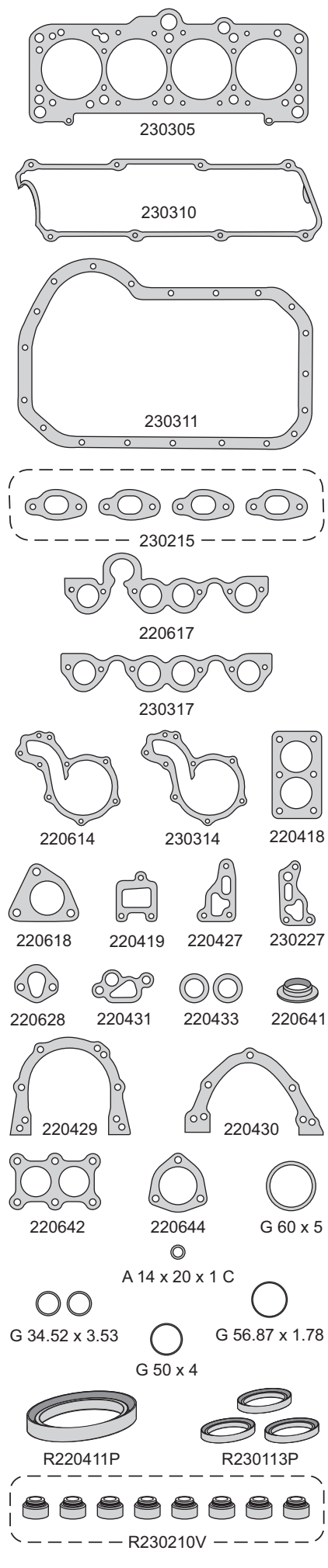

# VOLKSWAGEN



Motor/Engine	Cm³	HP	Ø
AT (DOHC) 16V	999	69	67.08

Volkswagen: Gol 1000, Saveiro 1998/...



Nº OE	Descripción/Description	Mat.	Ref.
	Jgo. de juntas para motor		230500-R
	Jgo. de juntas superior	●	230595
	Jgo. de juntas superior (MLS)		230595 MLS
	Junta tapa cilindros Ø 70.0 ± 1.20	NFT 1 1	230505
036/103383/M	Junta tapa cilindros Ø 70.0 ± 1.20	NFT	230507
036/103383/M	Junta tapa cilindros Ø 68.0 ± 0.42	MLS	230508
	Jgo. tornillos tapa cilin. (HAN12055/12100)		B230500
036/103483/G	Conj. juntas tapa válvulas (2)	N 1 1	230510
	Junta para cárter	CG 1	230511
032/103161/C	Tapa distribución	SLS 1	230512
036/253039/C	Múltiple escape	AC 1 1	230515
	Jgo. anillo admisión G 46 x 50 x 4.8 (4)	GS 1 1	230517
377/253/115/C	Salida de escape	FCH 1 1	230518
036/115111//	Brida bomba aceite	SLS 1	230527
026/103181/B	Bancada trasera	NB 1	220429
036/103677	Guarnición sellado deflector	GS 1	230540
032/121665/A	Anillo caño bomba de agua	GS 1	230541
036/103483/D	Cabezal tapa de cilindros	GS 1 1	230542
	Guarnición goma	GS 1	230543
	O´ring G 60 x 4	GS 1	
	O´ring G 48 x 4.3	GS 2	
	O´ring G 7.8 x 2.5	GS 1	
	O´ring G 22.2 x 4	GS 2	
	O´ring G 36.5 x 3.53	GS 1	
N/013849/2/	Arandela tapón cárter A 14 x 20 x 1.5 C	CU 1	
	Kit de retenes completo		R230500
036/109675//	Jgo. retén válvulas (16)	V 1	R230510V
	Retén bancada 85 x 105 x 12	V 1	R220411V
068/103171/F	Porta retén bancada trasero	V	PR230211V
	Ret. distribución 32 x 42 x 7 (desde 06/00)	V 1	R230512V
028/103085//	Ret. comando vál. 32x47x10 (hasta 06/00)	P 3	R230113P
096/103085/2	Ret. comando vál. 37x47x10 (desde 06/00)	V	R230513V

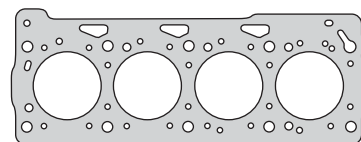

230505

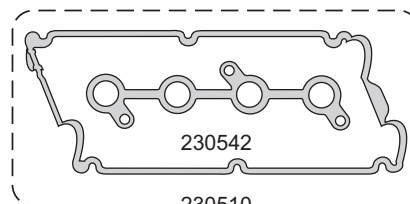

230542



230510

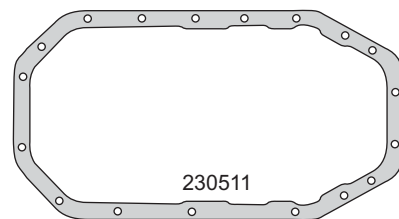

230511

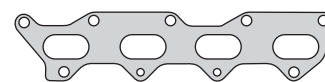

230515



230517

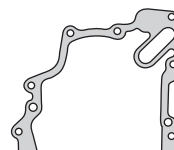

230512

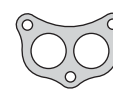

230518



230527



220429

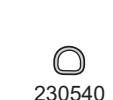

230540



230543



230541



G 36.09 x 3.53



G 7.8 x 2.5



G 60 x 4



G 48 x 4.3



G 22.2 x 4



A 14 x 20 x 1.5 C



R220411V

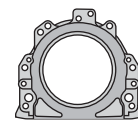

PR230211V



R230113P (hasta 06/00)

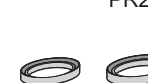

R230512V (desde 06/00)



R230513V (desde 06/00)

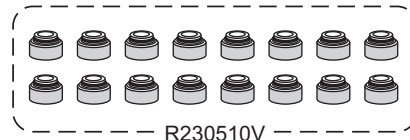

R230510V

# VOLKSWAGEN



Motor/Engine	Cm³	HP	Ø
AER/ALL (SOHC) 8V	999	50	67.1

Seat: Ibiza, Cordoba 1996/...  
 Volkswagen: Gol 1000, Saveiro, Polo 1995/...



Nº OE	Descripción/Description	Mat.	Ref.
	Jgo. de juntas para motor		230600-R
	Jgo. de juntas superior	●	230695
	Jgo. de juntas superior (MLS)		230695 MLS
	Junta tapa cilindros Ø 70.0 ± 1.20	NFT 1 1	230505
036/103383/M	Junta tapa cilindros Ø 70.0 ± 1.20	NFT	230507
036/103383/M	Junta tapa cilindros Ø 68.0 ± 0.40	MLS	230508
	Jgo. tornillos tapa cilin. (HAN12055/12100)		B230600
030/103483/K	Conj. junta tapa válvulas (4)	N 1 1	230610
	Junta para cárter	CG 1	230511
	Junta distribución	SLS 1	230512
032/103161/H	Junta distribución	SLS 1	230612
032/253039/E	Múltiple escape	AC 1 1	230615
	Jgo. anillo admisión G 36.3 x 40.8 x 5.4 (4)	GS 1 1	230617
	Salida de escape	FCH 1 1	230618
036/115111//	Brida bomba aceite	SLS 1	230527
026/103181/B	Bancada trasera	NB 1	220429
	Arandela tapa de válvulas	GS 3 3	223630
036/103677	Guarnición sellado deflector	GS 1	230540
032/121665/A	Anillo caño bomba de agua G 37.5 x 45 x 5	GS 1	230541
	Guarnición goma	GS 1	230543
N/013849/2/	Arandela tapón cárter A14 x 20 x 1.5 C	CU 1	
	O´ring G 60 x 4	GS 1	
	O´ring G 48 x 4.3	GS 2	
	O´ring G 7.8 x 2.5	S 1	
	O´ring G 22.2 x 4	GS 2	
	O´ring G 36.5 x 3.53	GS 1	
	O´ring G 67 x 75 x 4	GS 1	
	Kit de retenes completo		R230600
	Jgo. retén válvulas (8)	V 1	R230210V
068/103171/F	Retén bancada trasero	V 1	R220411V
026/103171/B	Porta retén bancada trasero 85 x 105 x 11	V	PR230211V
028/103085	Retén distrib. 32 x 42 x 7 (desde 06/00)	V 1	R230512V
028/103085	Ret. cdo. vál. 32 x 47 x 10 (hasta 06/00)	P 2	R230113P

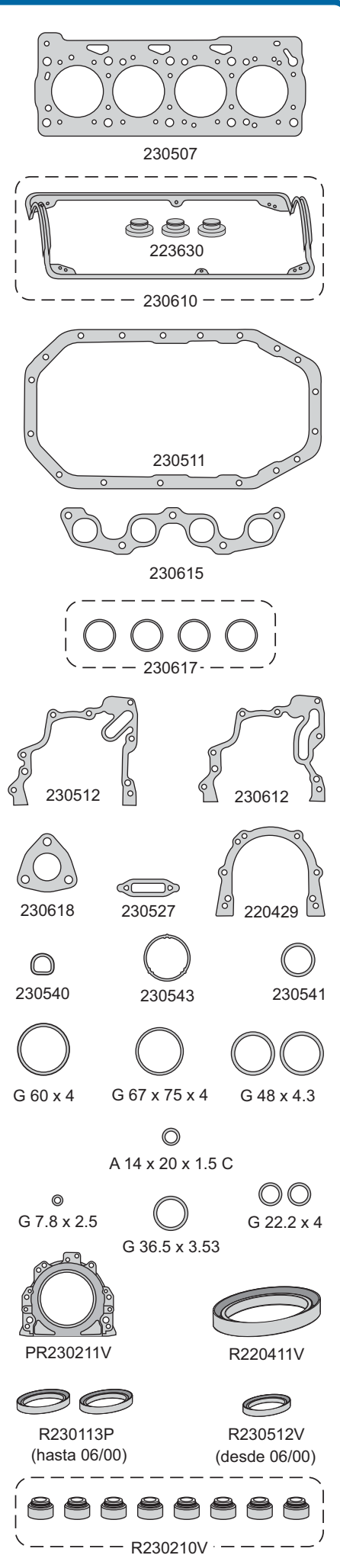

# VOLKSWAGEN



Motor/Engine	Cm³	HP	Ø
AAA/AMY	2792	163/174	81
MB104.900	2792	174	81
ABV (DOHC) V6 12V	2862	184	82

**Ford:** Galaxy 1995/02  
**Mercedes:** V280 1998/...  
**Volkswagen:** Passat VR6, Golf VR6 1991/97  
 Vento VR6 1992/97  
 Jetta 1993/...



Nº OE	Descripción/Description	Mat.	1	2	Ref.
	Jgo. de juntas para motor				230700-R
	Jgo. de juntas superior		●		230795
021/103383/L/	Jta. tapa cilindros Ø 83.0 $\pm$ 1.60  NR	NFT	1	1	230707
	Jgo. tornillos tapa cilin (HAN12055/12100)				B230700
021/103483/O	Junta tapa válvulas	GS	1	1	230710
021/103609/B	Junta para cárter	NB	1	1	230711
	Jgo. múltiple escape (2)	CHA	1	1	230715
021/133227/J/	Múltiple admisión	SLS	1	1	230717
021/121119/A	Junta base termostato	GS	1	1	230719
021/115446/A/	Junta goma filtro de aceite	GS	1	1	230720
021/133227/H/	Múltiple entre colectores admisión	SLS	1	1	230729
075/121113/D	O'ring termostato G 59.92 x 3.53	GS		1	
N903168/02	O'ring anillo sensor G 20.22 x 3.53	GS	4	4	
1HO/121687/A	O'ring G 28.17 x 3.53	GS		2	
	O'ring G 10 x 2	GS		1	
N/101392/01/	O'ring G 34.52 x 3.53	GS	4	4	
N/905315/01	O'ring G 36.17 x 2.62	GS		1	
N/901368/02/	O'ring G 60 x 5	GS		1	
038/117070/1	Anillo gomas 59 x 69 x 5	GS			
N/013849/2/	Arandela A 14 x 20 x 1.5 C	CU		1	
	Kit de retenes completo				R230700
027/109675/1	Jgo. retén válvulas (12)	P		1	R230710P
068/198171/1	Retén bancada 85 x 105 x 12	P		1	R220411P
054/115147/B/	Retén distribución 35 x 48 x 7	V		1	R240013V

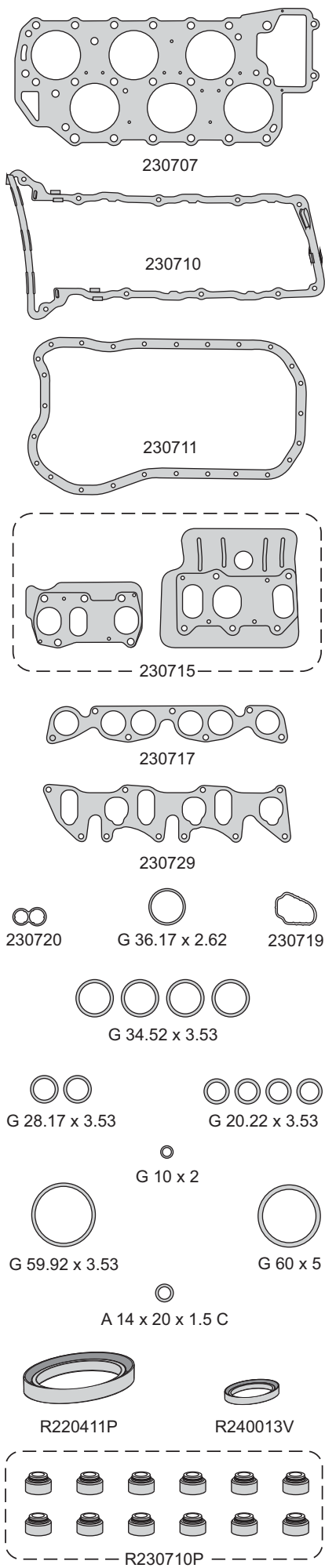

**VOLKSWAGEN****taranto**

Motor/Engine	Cm³	HP	Ø
1Z/AFF/AFN/AVG	1896	64/90	79.5
AHU/AEY/AHH	1896	90/110	79.5
AFF	1896	75	79.5
VW19N/P (SOHC) 8V	1896	90/100	79.5

**Audi:** A4, A6 D/TDI, Cabrio TDI 1994/...

**Ford:** Galaxy TDI 1995/..., 1997/...

**Seat:** Ibiza, Cordoba SDI/TDI 1996/...

**Volkswagen:** Golf, Vento SDI/TDI 1993/95  
Sharan, Passat TDI  
Caddy SDI 1993/96



DIESEL

Nº OE	Descripción/Description	Mat.	Ref.
	Jgo. de juntas para motor		230901-R
	Jgo. de juntas superior	●	230995-1M
	Jgo. de juntas superior		230995-2M
	Jgo. de juntas superior		230995-3M
	Jgo. juntas superior sin JTC		230996
028.103383.BL	Junta tapa cilindros Ø 81.0 $\pm$ 1.45	NFT 1	230907-1M
028.103383.BN	Junta tapa cilindros Ø 81.0 $\pm$ 1.53	NFT	230907-2M
028.103383.BN	Junta tapa cilindros Ø 81.0 $\pm$ 1.61	NFT	230907-3M
028.103383.BP	Junta tapa cilindros Ø 81.0 $\pm$ 1.45	MLS	230908-1M
028.103383.BQ	Junta tapa cilindros Ø 81.0 $\pm$ 1.53	MLS	230908-2M
028.103383.BR	Junta tapa cilindros Ø 81.0 $\pm$ 1.61	MLS	230908-3M
049/103385/3	Jgo. tornillos tapa cilin. (HAN12055/12100)		B230100
0.28.103.483.G	Conj. junta tapa válvulas (7)	N 1 1	230910
044.103.609D	Junta para cárter	ACP	1 230311
056103609A	Brida termostato	NB 2 2	230113
028/129.589/B	Jgo. múltiple escape (4)	FCH 1 1	230215
028.129.717.D	Múltiple admisión	NFT 1 1	230217
059/121119/1	Arandela pico inyector A 6.5 x 13.7 x 1.25	AC	230922
046130219A	Arandela pico inyector	AC	230923
056/115441/1	Base filtro aceite	NB	1 230227
026/103161/B/	Base filtro aceite	NB	1 220427
028/115441/C/	Base bomba combustible	NB	1 230128
056103181	Porta retén bancada trasera	NB	1 220429
028/103536/A	Anillos tapa válvulas superior	GS 3 3	230230
056103161	Bancada delantera	NB	1 220430
028/1035331	Guarnición válvulas inferior	GS 3 3	230231
029/15189/1	Junta bomba de aceite	NB	1 220431
056905261	Base distribuidor	CB	1 220433
	O´ring calefactor G 35.3 x 3	GS	220639
	O´ring G 56.87 x 1.78	GS	1 220442
	Arandela A 7 x 12.5 x 1 C	CU	4
	Arandela A 8 x 13 x 2.5 C	CU	4 4
	O´ring G 50 x 4	GS	1
	O´ring G 38 x 3	GS	1
	O´ring G 39 x 3	S	1
	O´ring G 30.8 x 3.7	GS	1
	O´ring G 20.22 x 3.53	GS	2
	O´ring G 34.52 x 3.53	GS	2 2
	Arand. tapón cárter A 14 x 20 x 1C	CU	2
	O´ring G 40.87 x 3.53	GS	1
	Kit de retenes completo		R220400
026/109675//	Jgo. retén válvulas (8)	V 1	R220410V
026/109675/	Retén bancada 85 x 105 x 12	V 1	R220411V
068/103051/P/	Porta retén bancada trasero	V	PR230211V
068/103085/E/	Ret. distrib. y árbol de levas 32 x 47 x 10	P 3	R230113P

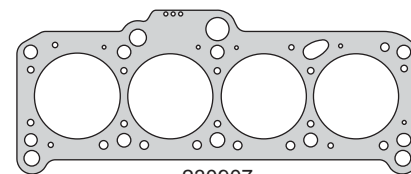

230907

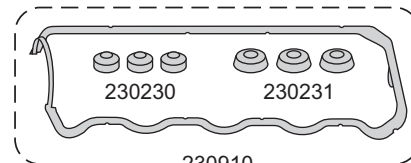

230910

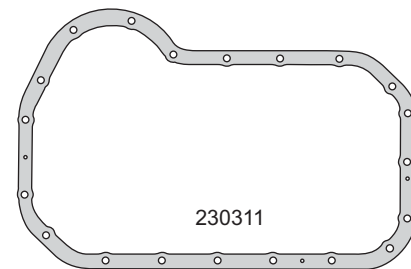

230311

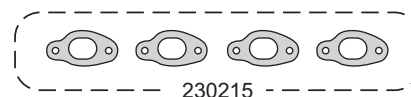

230215



230217



230113

230923

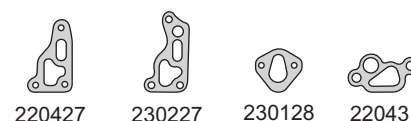

220427

230227

230128

220431

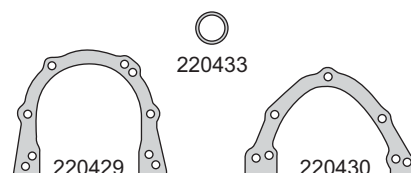

220429

220430

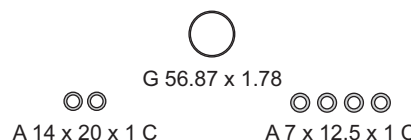

G 56.87 x 1.78

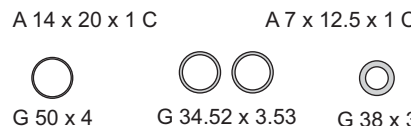

A 14 x 20 x 1 C

A 7 x 12.5 x 1 C



G 50 x 4

G 34.52 x 3.53

G 38 x 3



G 30.8 x 3.7

G 40.87 x 3.53

G 39 x 3

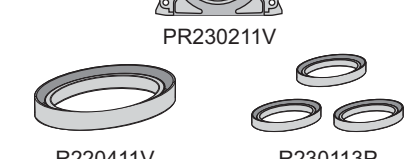

PR230211V

R220411V

R230113P



R220410V

# VOLKSWAGEN



Motor/Engine	Cm³	HP	Ø
AZH/APK/AQY	1984	115	82.5
ATM	1984	115	82.5
BBX (SOHC) 8V	1985	116	82.5

**Skoda:** Octavia 1999/04  
**Volkswagen:** Jetta 1998/02, Golf 1998/01  
 New Beetle, Bora 1998/...  
 Sharan 2000/...  
 Polo BR 2002/...



Nº OE	Descripción/Description	Mat.	Ref.
	Jgo. de juntas para motor		231100-R MLS
	Jgo. de juntas para motor		231100-R
06A1033831	Jgo. de juntas superior (MLS)	●	231195 MLS
	Jgo. de juntas superior		231195
	Jta. tapa cilindros Ø 83.5 ± 1.40	NFT	231105
	Jta. tapa cilindros Ø 83.5 ± 1.40	NFT	231107
06A103383-AN	Jta. tapa cilindros Ø 83.5 ± 1.40	MLS 1 1	231108
	Jgo. tornillos tapa cilindros (HAR10168)		B224100
	Sellador líquido - caucho de silicona		TRN0085G
06A103483	Junta tapa válvulas	GS 1 1	231110
0261034832	Junta tapa válvulas	GS 1	230310
058253039C	Junta para cárter	NFT 1	223411
037253039F	Múltiple escape	CHA 1 1	231115
037129717C	Múltiple admisión	NFT 1 1	221017
06A129717A	Jgo. múltiple entre colectores admisión (5)	GS 1 1	231117
	Salida de escape	AC 1	231118
056611441	Junta base filtro aceite	NB 1	230227
06A1333981	Guarnición bomba aceite	GS	221829
06A129717F	Junta entre colectores	NFT 1	231132
06A/1034830	Guarnición cierre llenado de aceite	GS 1 1	224033
028/129748	Junta mariposa aceleración	NH	231134
533253155	Salida de escape	NFT 1	220642
06A/121119	O´ring bomba de agua G 53 x 4	GS 1	
026/121119	O´ring termostato G 50 x 4	GS 1	
	O´ring G 47.22 x 3.53	GS 1	
	Kit de retenes completo		R231100
027109675	Jgo. retén válvulas (8)	P 1	R230210P
06A103171A	Porta retén trasero	V	PR231111V
038103085E	Retén distribución 32 x 47 x 10	P 1	R220412P
038103085A	Retén árbol de levas 35 x 48 x 7	P 1	R240013P

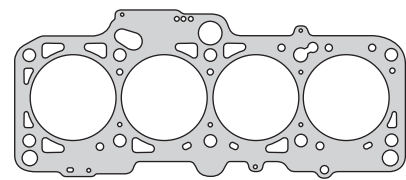

231108

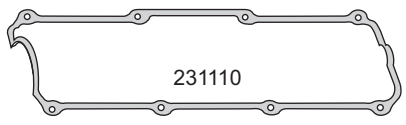

231110

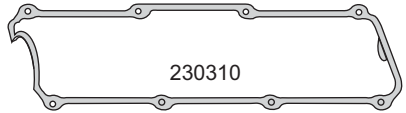

230310

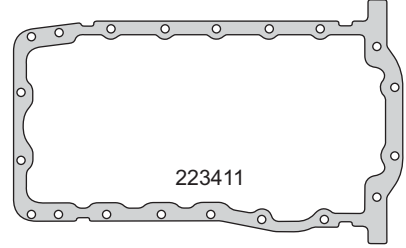

223411

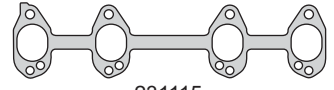

231115

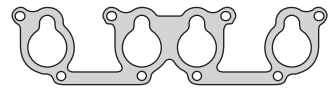

221017

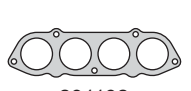

231132

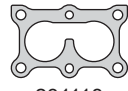

231118

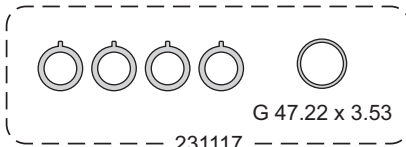

G 47.22 x 3.53

231117



230227



221829



224033



G 50 x 4

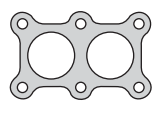

220642



G 53 x 4

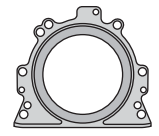

PR231111V

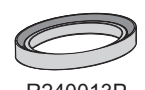

R240013P



R220412P

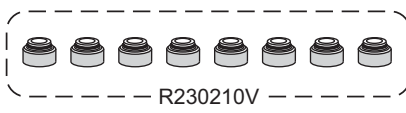

R230210V

# VOLKSWAGEN



Motor/Engine	Cm³	HP	Ø
AT (SOHC) 8V	999	50/69	67.1

Volkswagen: Gol Power 2002/...



Nº OE	Descripción/Description	Mat.	Ref.
	Jgo. de juntas para motor		● 231200-R MLS
	Jgo. de juntas superior (MLS)	●	231295 MLS
	Jta. tapa cilindros Ø 70.0 ± 1.20	NFT	230505
	Jta. tapa cilindros Ø 70.0 ± 1.20	NFT	230507
036/103383/M	Jta. tapa cilindros Ø 68.0 ± 0.42	MLS	1 1 230508
	Jgo. tornillos tapa cilin. (HAN12055/12100)		B230600
	Junta tapa de válvulas	NB	224010
	Junta para cárter	CG	1 230511
032/103161/C	Tapa distribución	SLS	1 230512
030.253039.K	Múltiple escape	AC	1 1 224015
	Jgo. anillo admisión G 36.3 x 40.8 x 5.4 (4)	GS	1 1 230617
	Salida de escape	FCH	1 1 224218
036/115111//	Brida bomba aceite	SLS	1 230527
026/103181/B	Bancada trasera	NB	1 220429
	Guarnicion goma	GS	3 223630
036/103677	Guarnición sellado deflector	GS	1 230540
032/121665/A	Anillo caño bomba de agua G 37.5 x 45 x 5	GS	1 230541
	Guarnición goma	GS	1 230543
N/013849/2/	Arandela tapón cárter A14 x 20 x 1.5 C	CU	
	O´ring G 60 x 4	GS	1
	O´ring G 48 x 4.3	GS	2
	O´ring G 7.8 x 2.5	GS	1
	O´ring G 22.2 x 4	GS	2
	O´ring G 36.5 x 3.53	GS	1
	O´ring G 43 x 4	GS	1
	O´ring G 20.22 x 3.53	GS	3
	Kit de retenes completo		R231200
	Jgo. retén válvulas (8)	V	1 R230210V
	Porta retén bancada trasero	T	PR231211T
028/103085	Retén distribución 32 x 42 x 7	V	1 R230512V
028/103085	Retén comando válvulas 32 x 42 x 7	V	1 R230512V

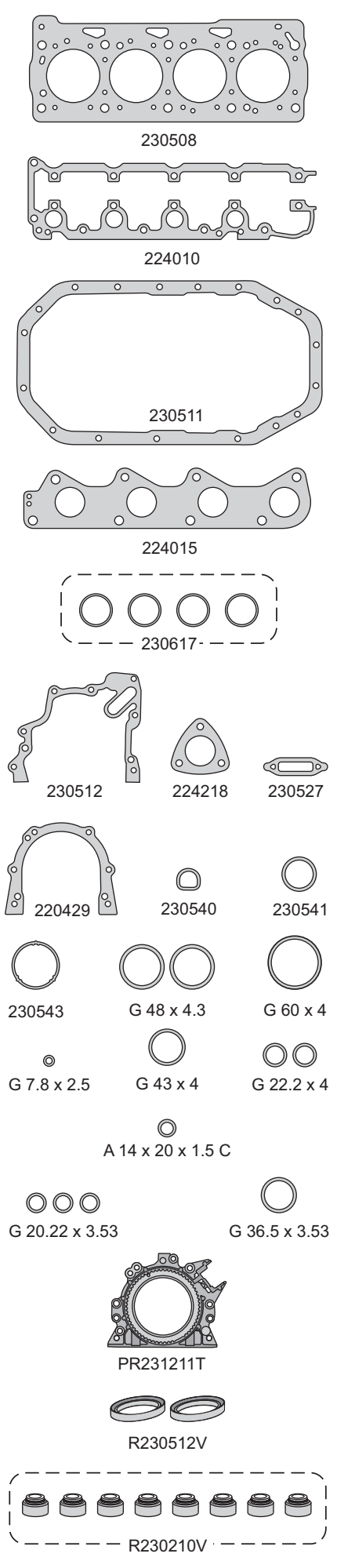

**VOLKSWAGEN**



Motor/Engine	Cm³	HP	Ø
AT (DOHC) 16V	999		67.08

Volkswagen: Gol Power 2002/...



Nº OE	Descripción/Description	Mat.	Ref.
	Jgo. de juntas para motor		● 231300-R MLS
	Jgo. de juntas superior (MLS)	●	231395 MLS
	Jta. tapa cilindros Ø 70.0 $\pm$ 1.20	NFT	230505
	Jta. tapa cilindros Ø 70.0 $\pm$ 1.20	NFT	230507
036/103383/M	Jta. tapa cilindros Ø 68.0 $\pm$ 0.42	MLS	1 1 230508
	Jgo. tornillos tapa cilin. (HAN12055/12100)		B231300
	Junta para cárter	CG	1 230511
032/103161/C	Tapa distribución	SLS	1 230512
036/253039/C	Múltiple escape	AC	1 1 230515
	Jgo. anillo admisión G 46 x 50 x 4.8 (4)	GS	1 1 230517
	Salida de escape	FCH	1 1 224218
036/115111//	Brida bomba aceite	SLS	1 230527
026/103181/B	Bancada trasera	NB	1 220429
	Guarnición goma	GS	2 2 223630
036/103677	Guarnición sellado deflector	GS	1 230540
032/121665/A	Anillo caño bomba de agua	GS	1 230541
	Guarnición goma	GS	1 230543
	O´ring G 60 x 4	GS	1
	O´ring G 48 x 4.3	GS	2
	O´ring G 7.8 x 2.5	GS	1
	O´ring G 22.2 x 4	GS	2
	O´ring G 36.5 x 3.53	GS	1
	O´ring G 43 x 4	GS	1
N/013849/2/	Arandela tapón cárter A 14 x 20 x 1.5 C	CU	1
	Kit de retenes completo		R231300
036/109675//	Jgo. retén válvulas (16)	V	1 R230510V
068/103171/F	Porta retén bancada trasero	T	PR231211T
	Retén distribución 32 x 42 x 7	V	1 R230512V
036/103085/A	Retén comando válvulas 27 x 42 x 8	V	1 R231313V

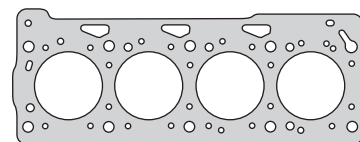

230508

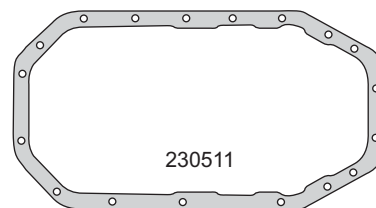

230511

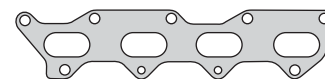

230515



230517

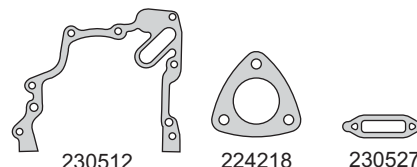

230512

224218

230527

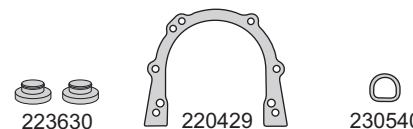

223630

220429

230540



230541

230543

G 43 x 4

G 60 x 4



G 48 x 4.3

G 36.5 x 3.53

G 22.2 x 4



A 14 x 20 x 1.5 C



G 7.8 x 2.5

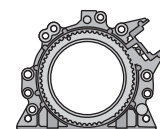

PR2301211T



R230512V



R231313V

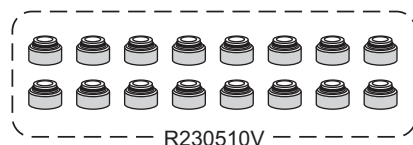

R230510V



**VOLKSWAGEN****taranto**

Motor/Engine

Cm³

HP

Ø

L5 BGP/BGQ  
(DOHC) 20V

2480

148/168

82.5

Volkswagen: Bora, Vento 2005/09

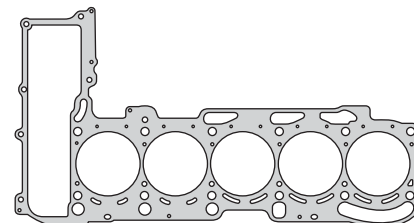

231408

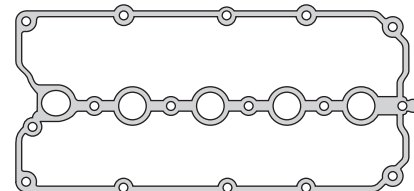

231410

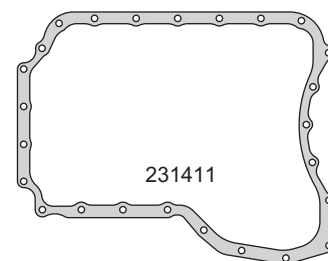

231411



231415



231417



231418

231430

231431



231433



231434



231435

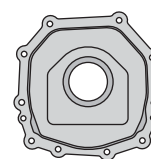

PR231411V



R220411V

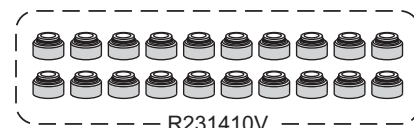

R231410V

Nº OE	Descripción/Description	Mat.		Ref.
	Jgo. de juntas para motor			231400-R MLS
	Jgo. de juntas superior (MLS)			231495 MLS
	Jta. tapa cilindros Ø 83.0 $\pm$ 1.20	NFT		231407
	Jta. tapa cilindros Ø 83.0 $\pm$ 0.60	MLS	1 1	231408
	Jgo. tornillos tapa cilindros (HAR10168)			B231400
	Junta tapa válvulas	GS	1 1	231410
	Junta para cárter	NB	1 1	231411
	Múltiple escape	AC	1 1	231415
	Jgo. múltiple admisión (5)	GS	1 1	231417
	Salida de escape	AC	1 1	231418
	Junta	GS	1 1	231430
	Junta	GS	1 1	231431
	Junta	GS	1 1	231432
	Junta	GS	1 1	231433
	Junta	GS	1 1	231434
	Junta	GS	1 1	231435
	Kit de retenes completo			R231400
	Jgo. retén válvulas (20)	V	1 1	R231410V
	Retén de bancada 85 x 105 x 12	V	1 1	R220411V
	Porta retén bancada	V		PR231411V

# VOLKSWAGEN



Motor/Engine	Cm³	HP	Ø
L5 AET/APL/AVT (SOHC) 10V	2461	115	81

Volkswagen: Eurovan 2001/04



Nº OE	Descripción/Description	Mat.	Ref.
	Jgo. de juntas para motor		231500-R
	Jgo. de juntas superior	●	231595
023103383B	Jta. tapa cilindros Ø 83.0 ± 1.60  NR²	NFT 1 1	231507
	Jgo. tornillos tapa cilin.  (HAN12055/12100)		B231500
	Junta tapa válvulas	P 1 1	221110
074.103.609H	Junta para cárter	NFT 1 1	221111
	Frente motor - filtro aceite	NB 1 1	221112
	Frente motor	NB 1 1	230113
	Frente motor - filtro aceite	SLS 1 1	221113
028.129.589B	Jgo. múltiple escape (5)	FCH 1 1	221115
	Arandela pico inyector	AC 5 5	230922
	Jta. acople bomba aceite	NB 1 1	221127
	Jta. chupador bomba aceite	NB 1 1	221129
	Jta. bancada delantera	NB 1 1	220429
	Guarnición salida aceite	N 1 1	221130
	Anillo tapa de válvulas	GS 4 4	230230
	Casquillo árbol de levas	GS 4 4	230231
934.129.717P	Múltiple admisión	NFT 1 1	222838
	Arandela A 8 x 13 x 2.5 C	CU 8 8	
	Arandela blindada B 28 x 34 x 3 CN	CN 2 2	
	O´ring G 23.47 x 2.62	GS 1 1	
	O´ring G 26.64 x 2.62	GS 1 1	
	O´ring G 28.24 x 2.62	GS 1 1	
	O´ring G 34.52 x 3.53	GS 2 2	
	O´ring G 45 x 3	GS 1 1	
	O´ring G 58 x 2	GS 1 1	
	O´ring G 59.92 x 3.53	GS 1 1	
	O´ring G 64.77 x 2.62	GS 1 1	
	O´ring G 98.02 x 3.53	GS 1 1	
	Kit de retenes completo		R221100
026.209.675	Jgo. retén válvulas (10)	P 1 1	R221100P
068.103.051P	Retén bancada 85 x 105 x 12	V 1 1	R220411V
069.115.147E	Retén árbol de levas 35 x 48 x 7	V 1 1	R240013V
068.103.085E	Retén árbol de levas 32 x 47 x 10	V 2 2	R230113V

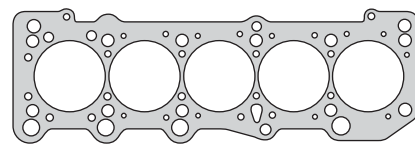

231507

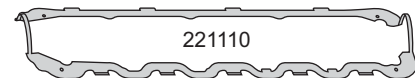

221110

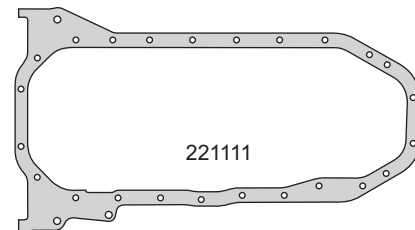

221111

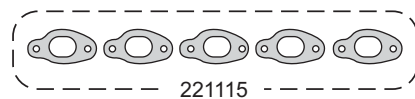

221115



222838

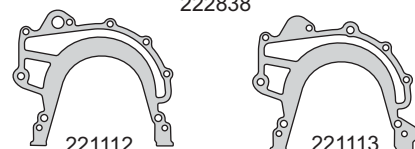

221112

221113



230113

230922

221127

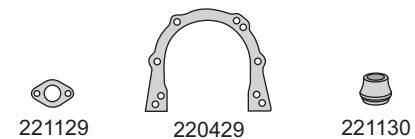

221129

220429

221130



230231

230230

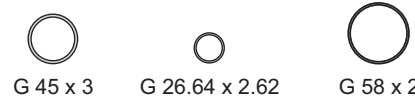

G 45 x 3

G 26.64 x 2.62

G 58 x 2

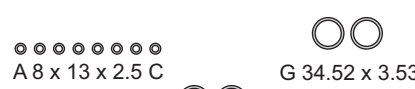

A 8 x 13 x 2.5 C

G 34.52 x 3.53

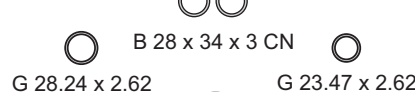

B 28 x 34 x 3 CN

G 28.24 x 2.62

G 23.47 x 2.62



G 98.02 x 3.53

G 59.92 x 3.53

G 64.77 x 2.62



R220411V



R240013V

R230113V



R221100P

**VOLKSWAGEN****taranto**

Motor/Engine	Cm³	HP	Ø
L4 F.I.	1800	90	81

**Volkswagen:** Golf, Jetta, Combi Panel 1992/99  
(Motores Fuel Injection con sello para válvula de 7 mm)

Nº OE	Descripción/Description	Mat.	Ref.
	<b>Jgo. de juntas para motor</b>		<b>231600-R</b>
026103383	Junta tapa cilindros Ø 82.2 ± 1.70	NFT	1 220605
026103383	Junta tapa cilindros Ø 82.2 ± 1.70	NFT	220607
	<b>Jgo. tornillos tapa cilindros (HAN12055/12100)</b>		<b>B220400</b>
056103483C	Conjunto juntas tapa válvulas (3)	CG	1 220410
0491036091	Junta para cárter	NFT	1 220611
056103609A	Brida termostato	NB	1 230113
049121041B	Bomba de agua	NB	1 220614
028/129589/B	Jgo. múltiple escape (4)	FCH	1 230215
056129717	Múltiple admisión	NB	1 220417
	Múltiple admisión	NFT	1 221417
	Salida de escape	NFT	1 230218
841253115B	Salida de escape	FCH	1 220418
056121139A	Entrada agua	NB	1 220419
056115441	Base filtro aceite	NB	1 220427
028/115441/C	Base filtro aceite	NB	1 230227
059127311A	Junta base bomba nafta	NB	2 220628
056103181	Bancada trasera	NB	1 220429
056103161	Bancada delantera	NB	1 220430
029/15189/1	Bomba aceite a block	NB	2 220431
056121149	Junta Termostato	NB	1 220434
056103491	Junta cierre tapa cilindros	GS	1 220437
056103489A	Cuello tapa válvulas superior	GS	1 220440
547253115A	Salida escape Orion	NFT	1 220642
	Arandela A 10 x 14 x 1 A	AL	1
	Arandela A 14 x 20 x 1.5 A	AL	1
	O´ring G 34.2 x 2.5	GS	1
	O´ring G 34.52 x 3.53	GS	1
	O´ring G 50 x 4	GS	2
	O´ring G 56.87 x 1.78	GS	1
	Kit de retenes completo		R231600
027/109675	Jgo. retén válvulas (8)	V	1 R230210V
	Retén bancada 85 x 105 x 12	P	1 R220411P
026/103085/E	Retén distribución y árbol levas 32 x 47 x 10	P	3 R230113P

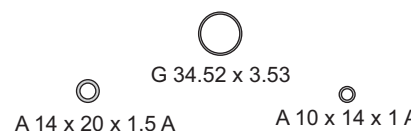
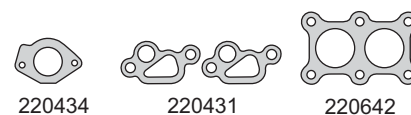
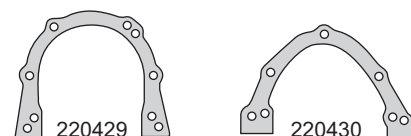
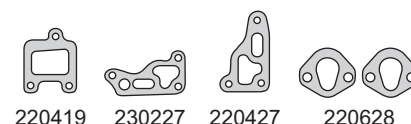
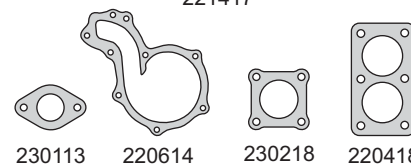
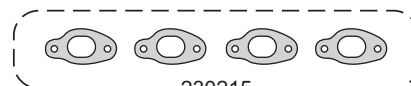
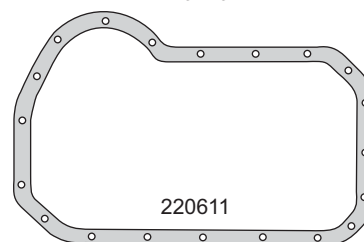
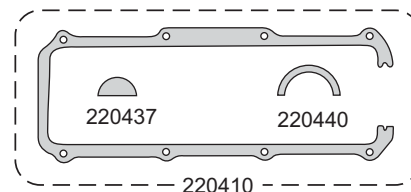
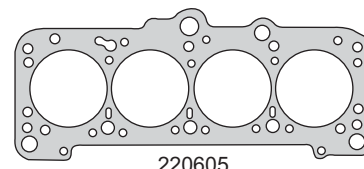

# VOLKSWAGEN



Motor/Engine	Cm³	HP	Ø
CDBA/CDCA	1968	140/180	81
CFFA/CJCB	1968	136	81
CFHD/CFHD	1968	143	81
CBEA/CGLA (DOHC) 16V	1968	163	81

**Audi:** A3, A4, A5, Q5 Quattro TDI 2009/...  
**Seat:** Ibiza, Leon, Alhambra TDI 2010/...  
**Volkswagen:** Pick Up Amarok TDI 2010/...  
 Common Rail



**DIESEL**

Nº OE	Descripción/Description	Mat.	Ref.
	Jgo. de juntas para motor		232401-R
	Jgo. de juntas superior		232495-1M
	Jgo. de juntas superior		232495-2M
	Jgo. de juntas superior		232495-3M
	Jgo. de juntas superior (MLS)		232495-1M MLS
	Jgo. de juntas superior (MLS)		232495-2M MLS
	Jgo. de juntas superior (MLS)		232495-3M MLS
	Jgo. juntas superior sin JTC		232496
	Jta. tapa cilindros Ø 82.0 $\pm$ 1.60	NFT 1	232407-1M
	Jta. tapa cilindros Ø 82.0 $\pm$ 1.70	NFT	232407-2M
03L103383	Jta. tapa cilindros Ø 82.0 $\pm$ 1.80	NFT	232407-3M
03L103383A	Jta. tapa cilindros Ø 82.0 $\pm$ 1.55	MLS	232408-1M
03L103383B	Jta. tapa cilindros Ø 82.0 $\pm$ 1.63	MLS	232408-2M
WHT002131	Jta. tapa cilindros Ø 82.0 $\pm$ 1.71	MLS	232408-3M
	Jgo. tornillos tapa cilin. (HAN12055/12100)		B232400
03L103483C	Conj. junta tapa válvulas (15)	GS 1 1	232410
	Junta para cárter	NB 1	232411
038121119	O´ring bomba de agua G 57 x 4	GS 1	232414
03L253039E	Múltiple escape - CDCA	AC 1 1	232415
03L253039G	Múltiple escape - CDCA	AC 1 1	232415-1
03L1297170	Guarnición admisión	GS 1 1	232417
2H0253115	Salida de escape	AC 1 1	232418
038121688B	Junta codo agua G 50.39 x 3.53	GS 1	232428
06B121119B	Junta codo agua a block	GS 1	232429
03L103070	Anillo cierre inyectores	GS 4 4	R232430P
	SopORTE filtro aceite	GS 1	232430
	Válvula EGR	AC 1	232431
	Válvula EGR	AC 3	232432
	Arandela doble raccord	CU 2	350032
	Arandela carga de aceite	GS 1	232433
	Guarnición refrigeración aceite	GS 1	232434
	Guarnición filtro de aceite	GS 1	232435
	Guarnición refrigeración aceite	GS 2	232437
	Guarnición filtro aceite	GS 1	232438
	Buje tapa válvulas	GS 2 2	232440
	Arandela tapa válvulas chica	GS 6 6	232441
	Arandela tapa válvulas grande	GS 2 2	232442
	Conducto aceite a turbo	SLS 1	232443
	Bomba depresora	SLS 1	232444
	Kit de gomas y arandelas (24)	VS 1	KG232401
	Arandela A 8 x 14 x 1 C	CU 4	
	Arandela A 12 x 17 x 1 C	CU 2	
	Arandela A 14 x 18 x 1.5 C	CU 2	
	O´ring G 2.9 x 1.78	GS 4	
	O´ring G 15.6 x 1.78	GS 5	
	O´ring G 18.64 x 3.53	GS 1	
	O´ring G 53.57 x 3.53	GS 1	
	O´ring G 59.92 x 3.53	GS 1	
	O´ring G 66.27 x 3.53	GS 1	
	O´ring G 136.12 x 3.53	GS 1	
	Kit de retenes completo		R232400
036109675A	Jgo. retén válvulas (16)	V 1	R230510V
03L103171	Porta retén bancada	T	PR232411T
038103085E	Retén bomba de aceite 35 x 48 x 7	V 1	R240013V
03L103085	Retén de árbol de levas 32 x 47 x 10	V 1	R230113V

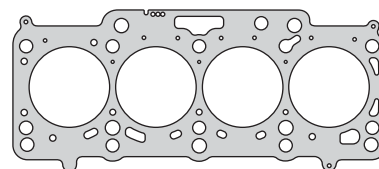

232408

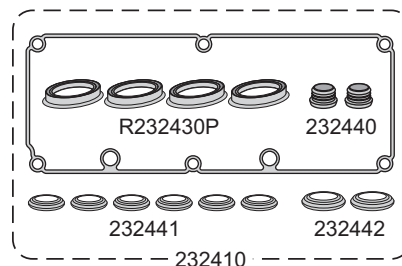

232410

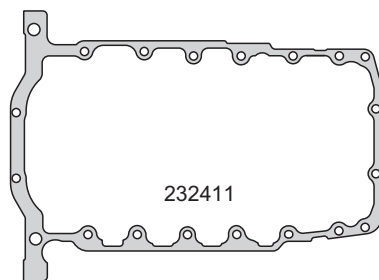

232411



232414



232415-1



232417

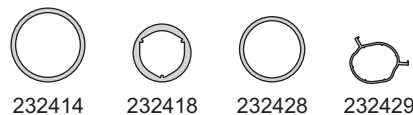

232414 232418 232428 232429

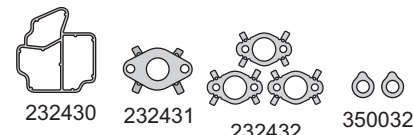

232430 232431 232432 350032

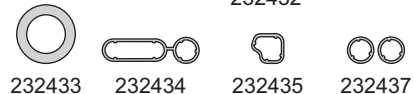

232433 232434 232435 232437



232438 232443 232444

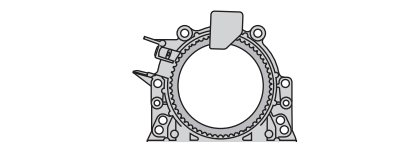

PR232411T

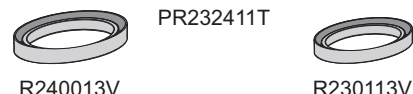

R240013V R230113V

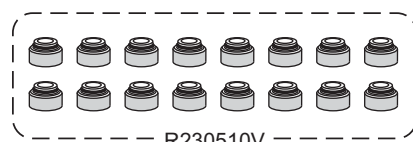

R230510V

# VOLKSWAGEN



Motor/Engine	Cm³	HP	Ø
EA111 (SOHC) 8V	1390	83	76.5

Volkswagen: Gol Power, Kombi 2006/...



Nº OE	Descripción/Description	Mat.	Ref.
	Jgo. de juntas para motor		232600-R MLS
	Jgo. de juntas superior (MLS)	●	232695 MLS
	Junta tapa cilindros Ø 78 $\pm$ 1.20	NFT	224005
	Junta tapa cilindros Ø 78 $\pm$ 1.20	NFT	224007
	Junta tapa cilindros Ø 78 $\pm$ 1.40	NFT	224007-1.4
032.103383.N	Junta tapa cilindros Ø 78 $\pm$ 0.40	MLS	1 1 224008
	Jgo. tornillos tapa cilin. (HAN12055/12100)		B224000
	Sellador líquido - caucho de silicona		TRN0085G
	Junta tapa válvulas	NB	224010
032.103601.AA	Junta para cárter	CG	1 230511
030.121043.C	Junta distribución	SLS	1 230512
	Múltiple escape	AC	1 1 224015
030.253039.K	Jgo. anillo admisión G 46 x 50 x 4.8 (4)	GS	230517
	Jgo. anillo admisión G 36.3 x 40.8 x 5.4 (4)	GS	1 1 230617
030.121005	Salida de escape	FCH	1 1 224218
026.103181.B	Junta subida bomba aceite	SLS	1 230527
036.115111	Bancada trasera	NB	1 220429
032.121665.A	Anillo mezcla a admisión G 64 x 69 x 5	GS	1 1 224031
N.906175.01	O'ring asiento deflector G 60 x 4	GS	1 224035
032.121119.5	O'ring cierre termostato G 47 x 4	GS	2 224036
032/121665/A	O'ring salida termostato a block G 30.8 x 3.7	GS	1 224037
035.906149.A	Anillo caño bomba de agua	GS	1 230541
N.908560.01	O'ring pico inyector G 7.52 x 3.53	GS	8 8 224043
	Jgo. guarnición inyector G 26.5 x 5.8	GS	1 224044
1H0.121687.A	Arandela tapón cárter A 14 x 20 x 1.5 A	AL	1
032.121666	O'ring llenado de agua G 28.17 x 3.53	GS	1
N.907653.01	O'ring caño unión bomba G 36.09 x 3.53	GS	1
	O'ring acople retorno radiador G 32 x 4	GS	2
	Arandela A 14 x 20 x 1.5 C	CU	1
036.109675	Kit de retenes completo		R224000
030.103170	Jgo. retén válvulas (8)	V	1 R224010V
036.103085.E	Porta retén bancada trasero	T	PR224011T
036.103085.G	Retén árbol de levas 32 x 42 x 7	V	1 R230512V
	Retén bomba de aceite 32 x 42 x 7	V	1 R230512V

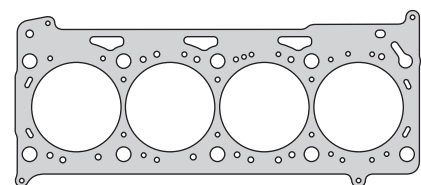

224008

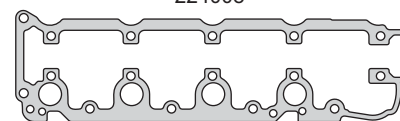

224010

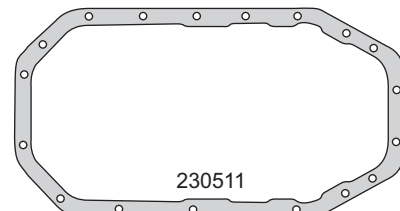

230511



224015



230517



230617

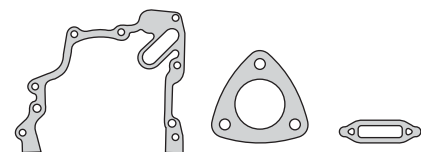

230512

224218

230527

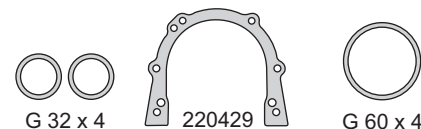

G 32 x 4

220429

G 60 x 4



224044



G 64 x 69 x 5

230541

G 36.09 x 3.53



G 30.8 x 3.7

G 47 x 4

G 28.17 x 3.53



G 7.52 x 3.53

A 14 x 20 x 1.5 A

A 14 x 20 x 1.5 C

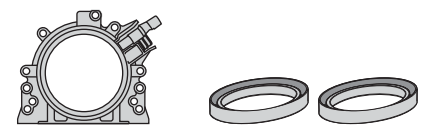

PR224011T

R230512V



R224010V

# VOLKSWAGEN



Motor/Engine Cm³ HP Ø

AP (SOHC) 8V 1984 107/115 82.5

Volkswagen: Santana 1998/...



Nº OE	Descripción/Description	Mat.	Ref.
	Jgo. de juntas para motor		233000-R
	Jgo. de juntas superior	●	233095
053103383	Jta. tapa cilindros Ø 83.5 ±1.70	NFT	230005
053103383	Jta. tapa cilindros Ø 83.5 ±1.70	NFT 1 1	230007
	Jgo. tornillos tapa cilin.  HAN12055/12100		B220400
0261034832	Junta tapa válvulas superior (goma/metal)	N 1 1	230310
044103609D	Junta para cárter (goma/metal)	ACP 1	230311
049121041B	Bomba de agua	NB 1 1	220614
056129589	Jgo. múltiple escape (4)	FCH 1 1	230215
	Múltiple admisión	NFT 1 1	230317
325/253137	Catalizador	CAC	230318
841253115B	Salida de escape	FCH 1 1	220418
547/253115/A	Salida caño de escape	FCH	220618
056121139A	Entrada agua	NB	220419
	Base filtro aceite	NB 1	230227
056115441	Base filtro aceite	NB 1	220427
056103181	Bancada trasera	NB 1	220429
056188161	Bancada delantera	NB 1	220430
056905261	Base distribuidor	CB 1	220433
659/127311/A	O'ring salida t/cil. a calefactor G 34.52 x 3.53	GS 2 2	220639
	O'ring porta retén distribución G 56.87 x 1.78	GS 1	220442
	Salida de escape	FCH 1	220642
	Catalizador gases	FCH 1	220644
059/121119/	O'ring termostato G 50 x 4	GS 2	
	O'ring G 36.17 x 2.62	GS 1	
029/103608/1	Arandela cárter A 14 x 20 x 1 C	CU 1	
	Arandela A 22 x 26 x 1 C	CU 1	
	Arandela A 10 x 14 x 1 C	CU 1	
	Kit de retenes completo		R230300
	Jgo. retén válvulas Ø7 mm. (8)	V 1	R230210V
048/10305/	Retén bancada 85 x 105 x 12	P 1	R220411P
026/103085/E	Retén distrib. y árbol levas 32 x 47 x 10	P 3	R230113P

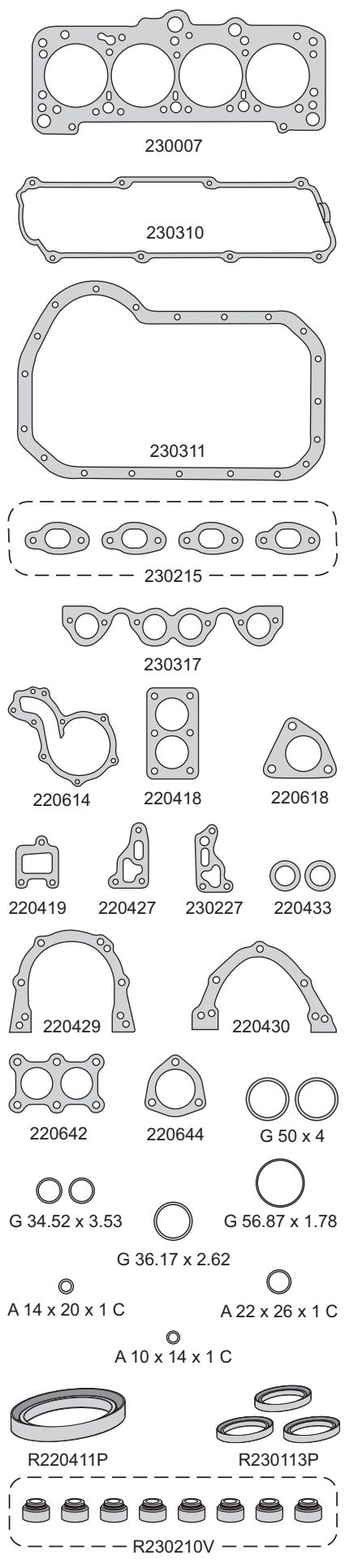

# VOLKSWAGEN



Motor/Engine	Cm³	HP	Ø
CHYA/CHYB (DOHC) 12V	999	60/75	74.5

**Seat:** Mii 2011/...  
**Skoda:** Citigo 2011/...  
**Volkswagen:** Up, Fox, Gol, Novo Golf 2014/...  
 Voyage 2017/..., T-Cross 2020/...  
 Novo Polo, Virtus 2018...



Nº OE	Descripción/Description	Mat.	Ref.
	Jgo. de juntas para motor		● 233100-R MLS
	Junta tapa cilindros Ø 76.0 ± 1.20	NFT	233107
04C103383N	Junta tapa cilindros Ø 75.5 ± 0.50	MLS	1 233108
WHT007089	Jgo. tornillos tapa cilindros (HAN12055/12100)		B233100
	Sellador líquido - caucho de silicona		TRN0085G
04C103483E	Junta tapa válvulas	SLS	1 233110
	Junta para cárter	NB	1 233111
04C103161E	Tapa distribución	SLS	1 233412
04C129717C	Jgo. múltiple admisión (5)	GS	1 233117
04C121119A	Bomba de agua	GS	1 233414
04E121119	Bomba de agua	GS	1 233114-1
1S0253115B	Colector de escape	AC	1 233415
04C121119C	Junta termostato	GS	233419
04C133073B	Junta TBI - G 52 x 56 x 5	GS	1 233130
	Guarnición admisión - G 22 x 26 x 6	GS	1 233131
	Junta sobre cárter	NB	1 233132
	Guarnición goma	GS	1
	O'ring G 7.52 x 3.53	GS	3
	O'ring G 8 x 3	GS	3
	Kit de retenes completo		R233100
04E109675/A	Jgo. retén válvulas (12)	V	1 R233110V
04C103170K	Porta retén bancada	T	PR233111T
04C103085B	Retén distribución 30 x 40 x 7	VF	1 R233112VF
04E103085AF	Retén árbol de levas 36 x 46 x 7	T	2 R233113T
04E103085	Retén bomba de agua 24 x 39 x 8	T	1 R233115T

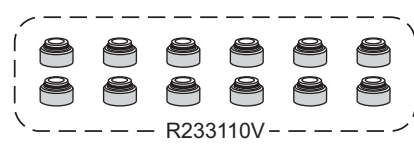
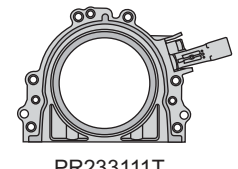
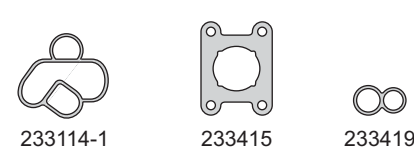
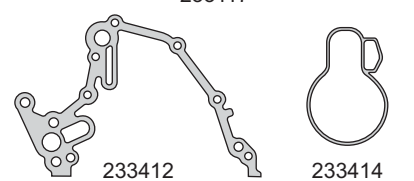
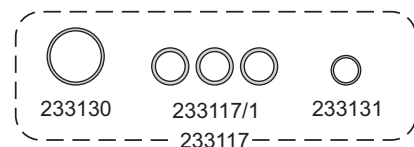
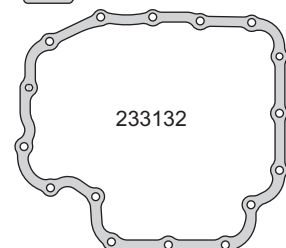
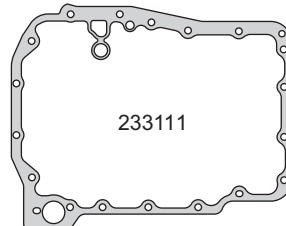
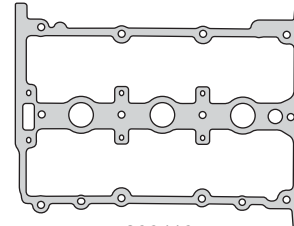
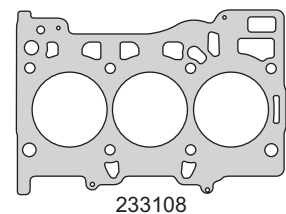

# VOLKSWAGEN



Motor/Engine	Cm³	HP	Ø
CDA4/CDAB	1798	152/160	82.5
CDNB/CDNC	1984	170/211	82.5
CAEB/CBFA			
CAEA/CCTA (DOHC) 16V			

**Audi:** A3/Q5 TFSI 2008/..., A4/A5 2010/...  
**Seat:** Altea, Leon, Toledo TSI 2009/10  
**Skoda:** Octavia, SuperB, Yeti 2009/...  
**Volkswagen:** Passat TSI, Golf FSI, Tiguan FSI  
 Eos FSI, Passat FSI 2007/...  
 Scirocco FSI 2008/...



Nº OE	Descripción/Description	Mat.	Ref.
	Jgo. de juntas para motor		233200-R MLS
	Jgo. de juntas superior		233295
	Jta. tapa cilindros Ø 83.0 $\pm$ 1.20	NFT 1	232907
	Jta. tapa cilindros Ø 83.0 $\pm$ 0.90	MLS 1	232908
	Jgo. tornillos tapa cilindros (HAR10168)		B221700
	Sellador líquido - caucho de silicona		TRN0085G
	Junta para cárter	NB 1	233211
06F253039F	Múltiple escape	AC 1	233215
06F129717D	Múltiple admisión	GS 1	233217
1K0253115AB	Salida de escape	AC 1	233218
06H1211190	Bomba de agua	GS 1	233219
06J117070C	Junta enfriador aceite	GS 1	233227
06H103517D	Junta separador de aceite	GS 1	233228
06H103121F	Bomba vacío	SLS 1	233229
06H103483C	Junta tapa árbol de levas	GS 1	233233
06J115441A	Sello soporte a block	GS 1	233234
	Guarnición goma	GS 1	233235
06H103484A	Junta válvula control de presión (PCU)	GS 1	233237
	Tapón	AC/GS 1	233238
	Kit de retenes completo		R233200
	Jgo. retén válvulas (16)	P 1	R233210P
06H103171A/F	Porta retén bancada	P 1	PR233211P
06H103085G	Retén distribución 45 x 60 x 8	P 1	R233212P

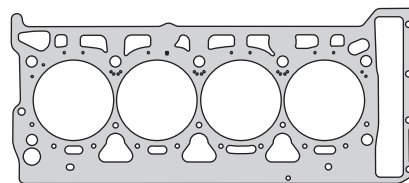

232908

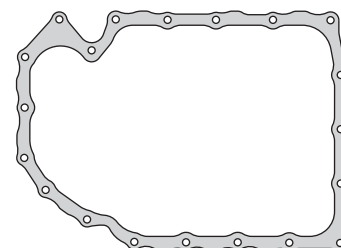

233211



233215



233217



233218



233219



233229



233227



233233



233228



233238



233235



233234



233237

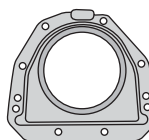

R233211P



R233212P



R233210P



# VOLKSWAGEN



Motor/Engine	Cm³	HP	Ø
BAG/BLP/BLF BTS (DOHC) 16V	1598	105/115	76.5

**Audi:** A3 FSI 2003/...  
**Skoda:** Octavia 2004/...  
**Volkswagen:** Golf FSI, Touran FSI, Passat FSI  
 Jetta FSI 2005/..., Eos FSI, Polo  
 Crosspolo 2006/...

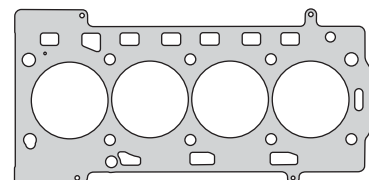

233308



233315



233317/1 233332  
233317

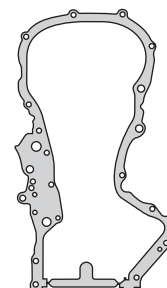

233312

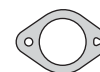

233318



233345

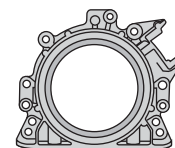

PR233311T



R233312P



R230113P

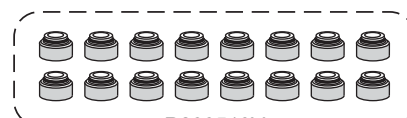

R230510V

Nº OE	Descripción/Description	Mat.	Ref.
	Jgo. de juntas para motor		● 233300-R MLS
	Junta tapa cilindros Ø 78.0 ± 1.20	NFT	233307
	Junta tapa cilindros Ø 77.5 ± 0.60	MLS 1	233308
	Jgo. tornillos tapa cilindros (HAN12055/12100)		B231700
	Sellador líquido - caucho de silicona		TRN0085G
	Tapa distribución	GS/AL 1	233312
	Múltiple escape	AC 1	233315
	Jgo. múltiple admisión (5)	GS 1	233317
	Salida de escape	AC 1	233318
	Salida de escape a turbo	AC 1	233345
	Guarnición admisión - G 65 x 69 x 5.4	GS 1	233332
	Kit de retenes completo		R233300
	Jgo. retén válvulas (16)	V 1	R230510V
	Porta retén bancada	T 1	PR233311T
	Retén distribución 35 x 48 x 10	P 1	R233312P
	Retén árbol de levas 32 x 47 x 10	P 2	R230113P

# VOLKSWAGEN



Motor/Engine	Cm³	HP	Ø
EA211 (DOHC) 16V	1598	110	76.3

**Volkswagen:** Suran, Suran Cross, Saveiro  
Novo Fox, Gol Rallye  
Saveiro Cross 2015/...



Nº OE	Descripción/Description	Mat.	Ref.
	Jgo. de juntas para motor		● 233400-R MLS
	Junta tapa cilindros Ø 77.3 ± 1.20	NFT	233407
04E103383BE	Junta tapa cilindros Ø 77.3 ± 0.60	MLS	1 233408
WHT007089	Jgo. de tornillos para tapa de cilindros		B233400
	Sellador líquido - caucho de silicona		TRN0085G
04E103483N	Junta tapa válvulas	SLS	1 233410
	Junta para cárter	NB	1 233411
04C103161E	Tapa distribución	SLS	1 233412
04C121119A	Bomba de agua	GS	233414
04E121119	Bomba de agua	GS	1 233114-1
1S0253115B	Colector de escape	AC	233515
04C129717D	Jgo. múltiple admisión G 45 x 50 x 5 (5)	GS	1 233417
03C133073D	Junta TBI	GS	1 233432
	Junta para cárter	NB	1 233431
	O´ring G 18.64 x 3.53	GS	4
	Kit de retenes completo		R233400
04E109675/A	Jgo. retén válvulas (16)	P	1 R233410P
04C103170K	Porta retén bancada	P	PR233111P
04C103085B	Retén distribución 30 x 40 x 7	VF	1 R233112VF
04E103085AF	Retén árbol de levas 36 x 46 x 7	T	2 R233113T
04E103085	Retén bomba de agua 24 x 39 x 8	P	1 R233115P

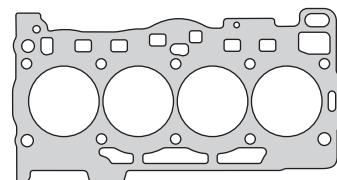

233408

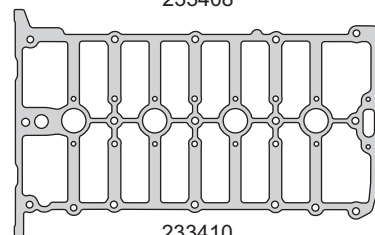

233410

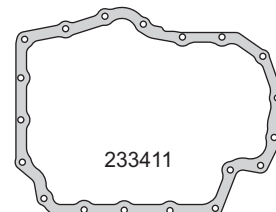

233411

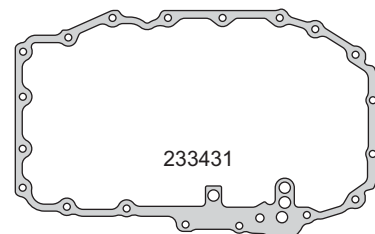

233431

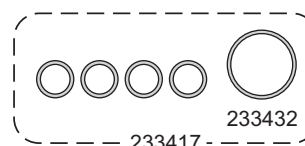

233417

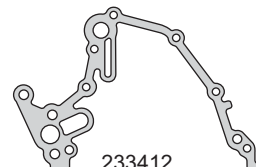

233412



233414



233114-1

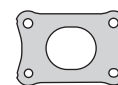

233515



G 18.64 x 3.53

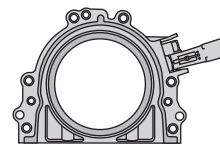

PR233111P



R233112VF



R233113T



R233115P

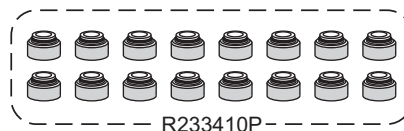

R233410P

# VOLKSWAGEN



Motor/Engine	Cm³	HP	Ø
5G1 - BE1 (DOHC) 16V	1395	150	74

Volkswagen: Golf TSI Generación VII



Nº OE	Descripción/Description	Mat.	Ref.
	Jgo. de juntas para motor		● 233500-R MLS
	Junta tapa cilindros Ø 75.0 ± 1.20	NFT	233507
04E103383BE	Junta tapa cilindros Ø 75.0 ± 1.00	MLS	1 233508
WHT007089	Jgo. tornillos tapa cilindros		B233400
	Sellador líquido - caucho de silicona		TRN0085G
04E103483N	Junta tapa válvulas	SLS	1 233410
032.103601.AA	Junta para cárter	NB	1 224011
04C103161E	Tapa distribución	SLS	1 233412
1S0253115B	Colector de escape	AC	1 233515
04C129717D	Jgo. múltiple admisión G 45 x 50 x 5 (4)	GS	1 233517
04C121119A	Bomba de agua	GS	1 233114
04E121119	Bomba de agua	GS	1 233114-1
	Junta para cárter	NB	1 224032
	O`ring G 10.69 x 3.53	GS	1
	O`ring G 44.04 x 3.53	GS	1
	Kit de retenes completo		R233500
04E109675/A	Jgo. retén válvulas (16)	V	1 R233510V
04C103170K	Porta retén bancada	P	PR233111P
04C103085B	Retén distribución 30 x 40 x 7	P	R233112P
04E103085AF	Retén árbol de levas 36 x 46 x 7	T	2 R233113T
04E103085	Retén bomba de agua 24 x 39 x 8	P	R233115P

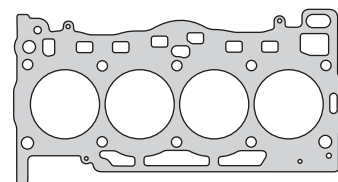

233508

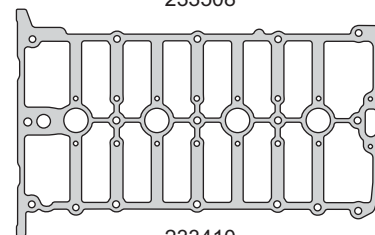

233410

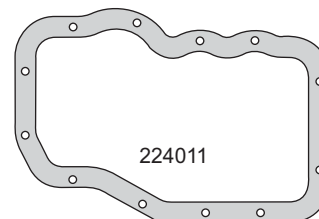

224011

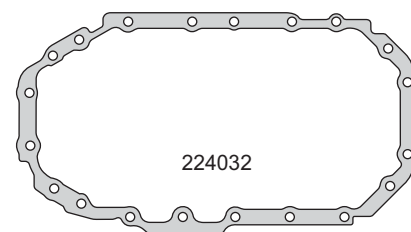

224032

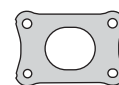

233515

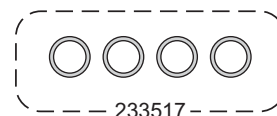

233517



233412



233114



233114-1

G 10.69 x 3.53



G 44.04 x 3.53

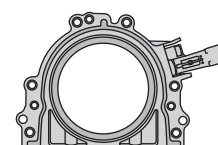

PR233111P



R233112P



R233113T



R233115P

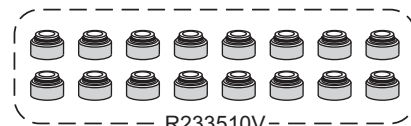

R233510V

# VOLKSWAGEN



Motor/Engine Cm³ HP Ø

**BLG/BMY/BWK  
CAVA  
(DOHC) 16V** 1390 140/170 76.5

Volkswagen: Golf TSI 2005/07  
Jetta TSI, Tiguan TSI 2006/...



Nº OE	Descripción/Description	Mat.	Ref.
	<b>Jgo. de juntas para motor</b>		● 233900-R MLS
	<b>Junta tapa cilindros Ø 78.0 ± 1.20</b>	NFT	233307
	<b>Junta tapa cilindros Ø 77.5 ± 0.60</b>	MLS 1	233308
	<b>Sellador líquido - caucho de silicona</b>		TRN0085G
	Tapa distribución	GS/AL 1	233312
	Múltiple escape	AC 1	233315
	Múltiple escape	AC 1	233915
	Jgo. múltiple admisión (5)	GS 1	233317
	Múltiple admisión	SLS 1	233917
	Junta tubo de escape	AC 1	233918
	Guarnición goma	GS 1	233927
	Guarnición goma	GS 4	233929
	Guarnición admisión - G 65 x 69 x 5.4	GS 1	233332
	Junta acople admisión	GS 1	233932
	O`ring G 45 x 3.2	GS 2	
	O`ring G 45 x 4	GS 1	
	O`ring G 52 x 4	GS 1	
	Kit de retenes completo		R233900
	Jgo. retén válvulas (16)	V 1	R231410V
	Porta retén bancada	T 1	PR233311T
	Retén distribución 35 x 48 x 10	T 1	R233312T
	Retén árbol de levas 32 x 47 x 10	P 2	R230113P

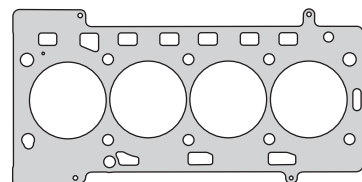

233308



233315



233915

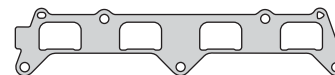

233917

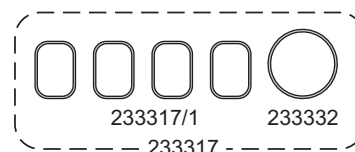

233317/1 233332

233317

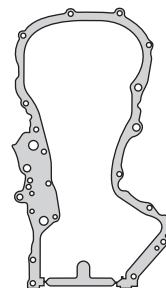

233312



233927



233932

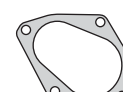

233918



G 45 x 4



233929



G 52 x 4



G 45 x 3.2

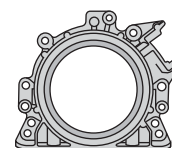

PR233311T



R233312T



R230113P



R231410V

# VOLKSWAGEN



Motor/Engine	Cm³	HP	Ø
DDXA (DOHC) V6 24V	2967	163	83.0

Volkswagen: Amarak TDI 2017

DIESEL



Nº OE	Descripción/Description	Mat.	Ref.
	Jgo. de juntas para motor		234001-R
	Jgo. junta tapa cilindros Ø 84.0 $\pm$ 1.70	NFT	234007-1M
	Jgo. junta tapa cilindros Ø 84.0 $\pm$ 1.80	NFT	234007-2M
	Jgo. junta tapa cilindros Ø 84.0 $\pm$ 1.95	NFT	234007-3M
059103148AJ	Jgo. junta tapa cilindros Ø 84.0 $\pm$ 1.60	MLS	234008-1M
059103148AK	Jgo. junta tapa cilindros Ø 84.0 $\pm$ 1.65	MLS	234008-2M
059103148AL	Jgo. junta tapa cilindros Ø 84.0 $\pm$ 1.70	MLS	234008-3M
	Sellador líquido - caucho de silicona		TRN0085G
059103483AH/4AJ	Conj. junta tapa de válvulas (8)	AC	234010
059103161AT	Junta frente motor	AC/GS	234012
059253039AF	Jgo. múltiple escape (2)	AC	234015
059129717S	Jgo- multiple admisión (12)	GS	234017
059129796J	Jgo- multiple admisión (6)	GS	234017-1
	Salida de escape	AC	234018
059121228	Guarnición termostato	GS	234019
059115446E	Guarnición filtro de aceite	GS	234027
059103147S	Junta entrada de aceite	SLS	234028
038103196C	Guarnición sensor nivel de aceite	GS	234029
059103085L	Guarnición junta tapa de válvulas	GS	234030
059131358G	Válvula EGR	AC	234031
059131599R	Conducto válvula EGR	AC	234032
059129069E	Guarnición válvula mariposa	GS	234034
059117070J	Enfriador aceite	AC/GS	234036
059131357P	Junta tubo recirculación gases	AC	234039
059253232C	Junta tubo de escape	AC	234040
059109091N	Junta trasera sello motor	SLS	234041
059103147T	Junta soporte compresor de gas	SLS	234042
059145215N	Guarnición tubo de aire	GS	234043
059145757AC	Junta salida aceite turbocompresor	SLS	234047
059115111A	Anillo bomba de aceite G 15,5 x 19.5 x 3.63	GS	
059145865C	Anillo G 63.7 x 68.3 x 4.45	GS	
059121688A	O´ring bomba de agua G 39 x 3	GS	
059121665	O´ring bomba de agua G 50.5 x 3.7	GS	
N90809102	O´ring G 15.5 x 1.90	GS	
034115427B	O´ring G 12 x 2	GS	
WHT001247	O´ring G 15.25 x 2.45	GS	
	Kit de retenes completo		R234000
06L109675C	Jgo. retén válvulas - escape (12)	V	R234010V
036109675A	Jgo. retén válvulas - admisión (12)	V	R234010-1V
059103051K	Retén bancada 85 x 105 x 8	V	R234011V
079103051d	Retén distrib. y árbol levas 32 x 47 x 10	V	R234012V

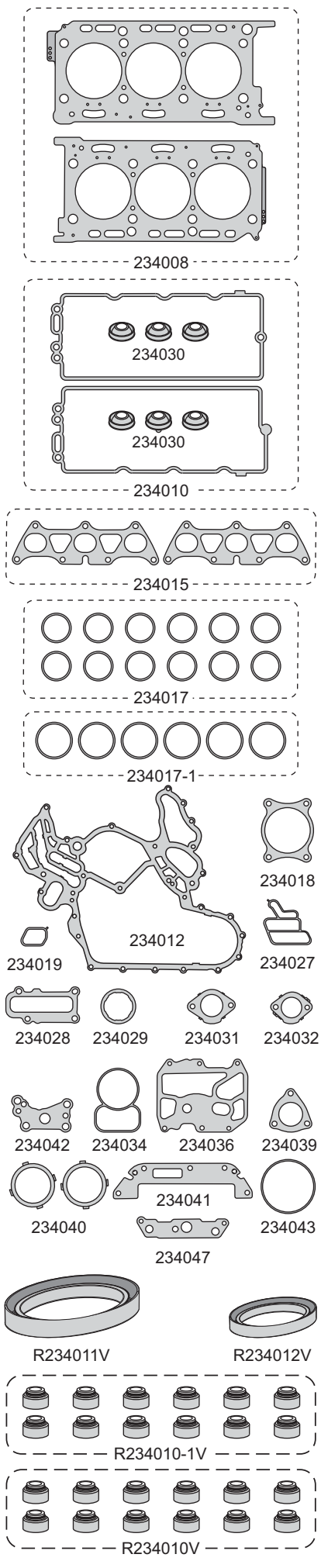

MOTORES NAFTA Y DIESEL / PETROL AND DIESEL ENGINES

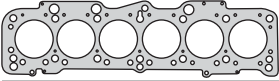
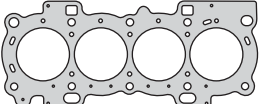
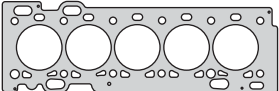
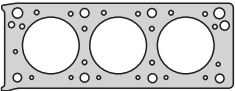
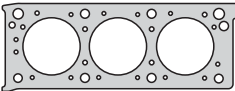
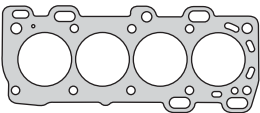
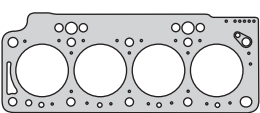
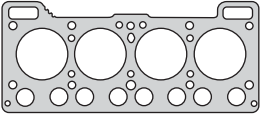
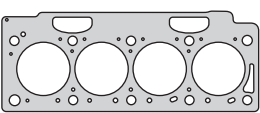
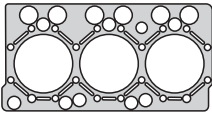
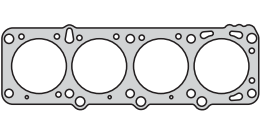
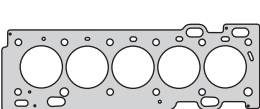
	Código Code	Q	≠	Kit Bulón Bolt Set	Aplicación Application	Motor Engine	Juego
	224408	77.5	1.40	B224000 HAN12055 HAN12100	740/760/780/940/960 TD 1982/93 940/960TD 1993/96 - 240/244/245/940 740/760 1982/93 DIESEL	2383cc. D24T 112/129HP D24TIC 122HP D24 82/85HP Ø76,5	
	321607 321608	81.0 80.5	1.20 0.35	B320900 HAT55055 HAT55100	C30, S40, V50 2005/...	1596cc. B4164S3 (DOHC) 16V 101HP Ø79	321600-R MLS pág. 302
	324707 324708	84.0 84.0	1.40 1.30		S40, V50, C70, C30, S80, V70 2004/08 - 2007/...	2522cc. B524T3 - B524T6 - B524T7 B524T8 (DOHC) 20V 200/220/230HP Ø83	324700-R MLS pág. 325
	452507	90.0	1.40	B452500	260, 262, 264, 365 1975/80	2664cc. B27E/B27F 114HP Ø88 (SOHC) 12V	
	452607	93.0	1.40	B452500	760 1982/85 - 260/262/264/265 1980/..., 780 1986/91, 940/960/1990/...	2849cc. B28E/B28F 155HP B28A 129HP (SOHC) 12V Ø91	
	570607	85.0	1.70	B570600 HAE14038	S40/V40 1995/... S40/V40 1996/...	1731cc. B4184S 115HP Ø83 1948cc. B4204S - B4204T 140/160HP (DOHC) 16V Ø83	570600-R pág. 489
	580107-1M 580107-2M 580107-3M	80.7 80.7 80.7	1.50 1.40 1.60	B570300 HAE14038	440TD, 460TD 1994/97, V40TD S40TD 1996/99 DIESEL	1870cc. D19T - D4192T (SOHC) 8V 90HP Ø80	580901-R pág. 503
	580507	74.0	1.30	B550400 HAS17038	66 1973/...	1289cc. B130/B130S (OHV) 8V 57HP Ø73	580500 pág. 500
	581608	81.0	1.35	B570300 HAE14038	S40, V40 TD 2001/... DIESEL	1870cc. D4192T3 - D4192T4 102/115HP (SOHC) 8V Ø80	
	880908	119.0	1.20		Volvo B7, FL7 1985/..., FL7, FS7 1991/... B7R 1998/... DIESEL	6725cc. TD71 230/245HP TD73E/ES 230/260HP D7A/B/C 260/285HP D7C (SOHC) 12V Ø104.8	
	890007	95.0	1.40	B890000 HAS14038	240/242, 244 GLS, 245GLS 1977/77, 340 GLS, 360 GLT, 360 GLS 1980/84 240/242/244/245/260 1975/...	1986cc. B19A/B19E 90/117HP Ø89 2127cc. B21E/B21F/B21FT 136HP Ø92	
	890108	84.0	1.30	B890000 HAS14038	S80 I 2003/06, S60 I 2003/10 S40 II T5, V50 T5 2004/7 S60 I 2003/10, S60 II 2011/2015 S80 II 2006/11, V50 T5, C30 T5, S40 II T5 2007/12	2521cc. B5254 T2/T 210/220HP B5254 T4/T5 253/300HP B5254 T6/T7 200/230HP (DOHC) 20V Ø83	890100-R MLS pág. 585



**WILLYS**



Motor/Engine	Cm³	HP	Ø
CJ2A-CJ3A DJ3A	2199	52	79.38

Willys: Jeep, CPW Universal  
Rastrojero - 4 - 63  
2WD, 4WD 1940/74



Nº OE	Descripción/Description	Mat.	Ref.
	Jgo. de juntas para motor	●	540900-R
	Jgo. de juntas para motor		540900
989	Junta tapa cilindros Ø 80.5 ± 1.90	FCH	1 540905
630305	Junta tapa válvulas	CG	1 540910
639980	Junta para cárter	CG	1 540911
630365	Tapa distribución	CG	1 540912
630359	Placa distribución	NB	1 540913
637053	Cuerpo bomba de agua	NB	1 540914
634812	Múltiple admisión y escape	NFT	1 540916
	Entre múltiples	NFT	1 540917
634814	Salida de escape	NFT	1 540918
637016	Salida caño agua	NB	1 540919
630890	Base carburador	NB	1 540925
	Base bomba aceite	NB	1 540927
	Base bomba nafta	NB	1 540928
115656	Vaso bomba nafta	CG	1 540929
637790	Cierre bancada	CB	540930
639650	Entrada caño agua	NB	1 540931
637237	Jgo. empaquetadura cigüeñal (2)	SNA	1 540958
	Retén distribución 44.45 x 61.95 x 9.52	N	1 R540912N

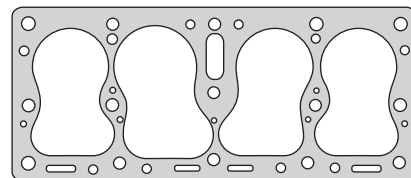

540905



540910

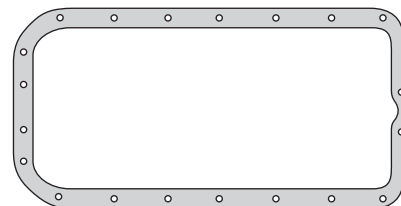

540911



540912

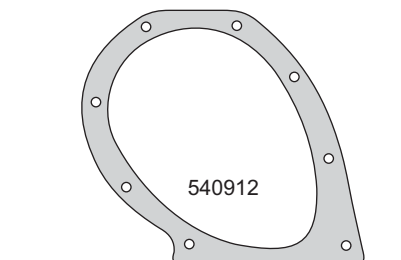

540916

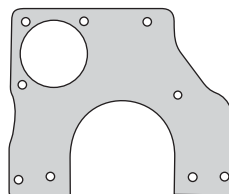

540913



540914

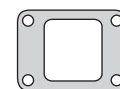

540917



540918



540919



540925



540927



540928

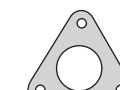

540931



540929



540930

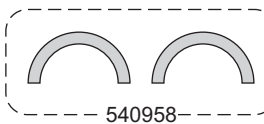

540958



R540912N





### Sellador Líquido (caucho de silicona)

- ▶ Creado para aplicaciones de gran fuerza de torsión.
- ▶ Resistencia al aceite a los combustibles, aceites, lubricantes, anticongelantes y gases.
- ▶ Resiste golpes y vibraciones.
- ▶ No recomendado para sellar tapas de cilindros.

### Kit de llaves especiales HAK12-38 / HAK639512-111

- ▶ El Kit HAK 2-38 contiene todos los tipos y medidas de herramientas necesarios para el trabajo sobre vehículos de última generación. Los Tubos con Punta de Alta Resistencia son fabricados en acero Cromo Vanadio con doble cromado y moleteado para mejorar el agarre. Encastre de 12.7mm. Con espacio para bola de retención.
- ▶ El Kit HAK639512-111 contiene 111 Tubos y llaves SmarDriv encastre de 1/4", 3/8" y 1/2". Forjados en acero especial, niquelados y cromados anticorrosión.



### Torquímetro - Goniómetro

- ▶ HTORQ-110 / HTORQ-210 / HTORQ-350  
Instrumento de medición de torque.  
Escala de apriete simple para facilitar el uso.
- ▶ HGONIOMETRO / HGONIOMETRO-M  
Diseñado especialmente para facilitar el apriete angular de los tornillos de tapa de cilindro.



### Sistemas de Embrague

- ▶ Suavidad de acople en arranques y cambios de velocidades.
- ▶ Transmisión de fuerza garantizada. Mayor confort.
- ▶ Óptima resistencia térmica. El mejor cambio.



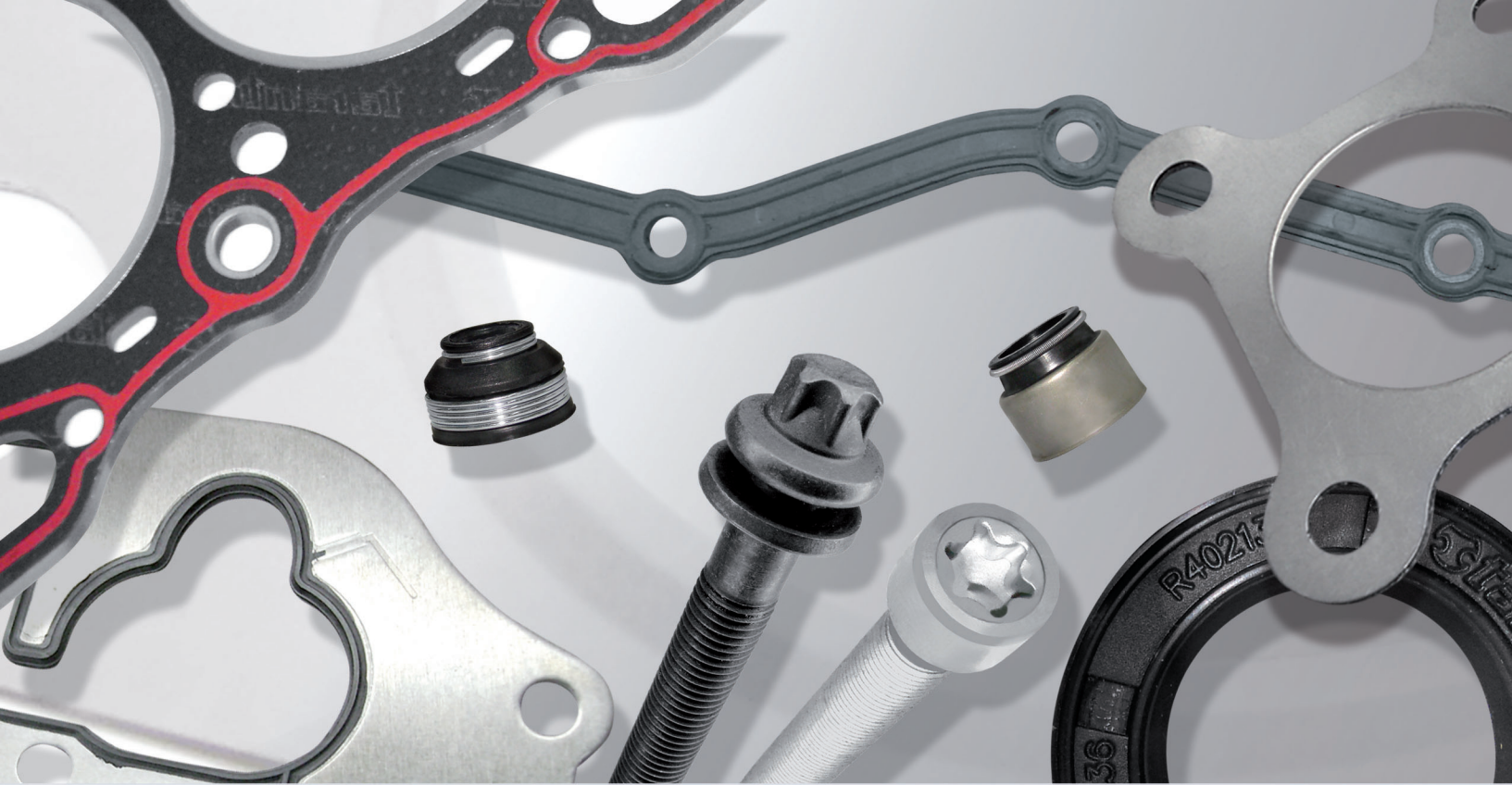

Rua Jair Afonso Inácio 820 (CEP 05136-040)  
Jd. Santo Elias  
SÃO PAULO - BRASIL  
Tel: (55-11) 3901-9090  
Fax: (55-11) 3903-6888  
e-mail: taranto@taranto.com.br



Mario Bravo 641 (B1868BMM)  
Avellaneda  
BUENOS AIRES - ARGENTINA  
Tel: (54-11) 4135-9000  
Fax: (54-11) 4135-9001  
e-mail: gaskets@taranto.com.ar



TARANTO MEXICANA, SA de CV  
Privada Santa Ana 36 Mz C, Bodega C  
Parque Industrial Lerma  
52000 Lerma Edo.Mex.  
Tel: (52-728) 28-54-145  
email: juntas@taranto.com.mx

[www.taranto.com.ar](http://www.taranto.com.ar)

