



taranto



LINEA PESADA **2023**



Nuestros Productos

Junta Tapa de Culata

- ▶ Eliminación del retorque en juntas terminación 07 y 08.
- ▶ Mayor resistencia mecánica y térmica.
- ▶ Compuestos sellantes especiales que aseguran la máxima estanqueidad.
- ▶ Utilización de materiales ecológicos.



Juego de Juntas para Motor



- ▶ Juego completo de reparación de motor con retenes.
- ▶ Empleo de materiales específicos a los distintos usos (Líquidos refrigerantes, aceites lubricantes, etc.)
- ▶ Compuestos sellantes que aseguran la máxima estanqueidad en los motores.
- ▶ Uso de materiales ecológicos.

Retenes



- ▶ Excelente sellabilidad.
- ▶ Óptimo desempeño funcional en distintos medios.
- ▶ Óptima resistencia al desgaste.
- ▶ Facilidad de montaje.
- ▶ Larga vida útil.

Tornillos de Culata

- ▶ Indispensable para el buen funcionamiento del motor.
- ▶ Diseñados para resistir altas sollicitaciones.
- ▶ Resisten las altas temperaturas.



INDICE - LINEA PESADA

INDEX - HEAVY LINE

En este Catalogo usted puede encontrar todos los artículos para las aplicaciones en las líneas vehicular, pesada y asiáticas. Para facilitar su búsqueda Taranto le ofrece dos metodologías distintas de búsqueda:

In this Catalog you can find all the articles for the applications in light lines, heavy duty lines and asiatic models. To facilitate your search Taranto offers two different methodologies:

1 | INDICE ORDENADO POR REFERENCIA TARANTO

Index ordered by Taranto references.

> SIMBOLOS - Symbols



Catálogo Vehicular
Automotive Catalog



Catálogo Línea Asiática
Asiatic Catalog



Catálogo Línea Pesada
Heavy Duty Catalog

TABLA DE REFERENCIAS / REFERENCE TABLE

Ref.	Pág.	Ref.	Pág.	Ref.	Pág.	Ref.	Pág.	Ref.	Pág.	Ref.	Pág.	Ref.	Pág.
TARANTO	PESADO	TARANTO	PESADO	TARANTO	PESADO	TARANTO	PESADO	TARANTO	PESADO	TARANTO	PESADO	TARANTO	PESADO
200400	11	350600	132	410500	223	700200	51	800000	61	870800	28	924400	251
200600	12	350800	134	410600	224	700300	52	800100	63	870900	29	924500	252
210000	05	350900	135	410700	225	700400	53	800200	64	871000	30	925300	253
210100	06	351000	137	410800	226	700500	54	800300	65	880000	255	926500	254
210200	07	352000	138	410900	227	700600	55	800500	67	880100	257	962800	149
210300	08	352200	139	420000	228	700700	56	800600	69	880200	259	963100	150
210400	15	360000	141	420100	229	700800	57	800800	71	880300	261	964100	151
210500	16	360100	142	420200	230	700900	58	800900	72	880400	263	964200	152
210600	17	360200	143	420400	231	710100	59	801000	74	880500	265	964300	153
210700	18	360300	144	420600	232	710200	60	810000	235	880600	267	964700	154
210800	09	360400	145	422000	233	750000	79	810100	236	880700	269	965100	155
220700	47	360800	147	423000	01	750100	80	810200	238	880800	271	965200	156
280100	13	400000	201	423100	02	750200	81	810300	240	901900	181	965300	157
281100	14	400100	202	423200	03	760000	95	810400	242	902000	182	965400	158
310400	167	400200	203	440000	179	760100	97	810500	244	904900	183	965500	159
310500	169	400300	204	440100	180	760200	98	810600	245	905900	184	965600	160
311100	75	400400	205	650000	31	760300	99	810700	246	906700	185	965700	161
320400	171	400500	206	650100	32	760400	100	810800	247	906800	186	965900	162
320800	172	400600	207	650200	33	760500	101	850000	87	907000	187	966000	163
330000	76	400700	208	650300	34	760600	102	850100	88	907100	188	966100	164
330100	77	400800	209	650400	35	760700	103	850200	89	907200	189	966200	165
330200	78	400900	210	650500	36	760800	104	850300	90	907300	190	966300	166
330400	173	401000	211	650600	37	760900	105	850400	91	907400	191	971200	117
330700	174	401100	212	650700	38	770000	107	850500	92	907800	192	974100	118
330800	176	401500	213	650800	39	770100	108	850600	93	907900	193	974200	119
331200	177	401600	214	650900	40	770200	109	850700	94	908200	194	974300	120
331300	178	401700	216	651000	41	770300	110	870000	19	908300	195	974400	121
350000	125	410000	218	660000	43	770400	111	870100	21	908400	196	974500	122
350100	126	410100	219	660100	44	770500	112	870200	23	908500	197	974600	123
350200	127	410200	220	660200	45	770600	113	870500	25	908600	198	995100	83
350300	128	410300	221	700000	49	770700	114	870600	26	908700	199	995200	84
350400	130	410400	222	700100	50	770800	115	870700	27	910900	249	995300	85

2 | INDICE ORDENADOS POR CM³

Index ordered by cm³.

AGCO/SISU

Ref.	Modelo/Model	CM³	Motor/Engine	
423000	Case-IH CS 68/75, Challenger, A65/A75/305/355/365/405/455/465/555/565/600/700 SISU 320D/320DS, 836640356	DIESEL 3300cc.	320D/DS 33/69HP Ø108	01
423100	MF4292/4297, Challenger, A950/A990 (4x2, 4x4), BM100/BM110 (4x2, 4x4)	DIESEL 4400cc.	420DS Agco Sisu Power 106/129HP Ø108	02
423200	MF Case-IH CS/CVX 120/130/150, CVX 1135/1145/1155/1170/1190, Valtra 8000	DIESEL 6600cc.	620D/DS 147/189HP Ø108	03

AGRALE

330800	Camión TX 1600 1983/...	DIESEL 2942cc.	D229-3 (SOHC) 6V 72HP Ø102	176
870800	AM100-E, AM150-E, AM200-E 2013/...	DIESEL 2776cc.	ISF2.8 (SOHC) 16V 150/156HP Ø94	28
330400	7000/7500/8500	DIESEL 4300cc.	4.10 X10 90HP - 4.10T 133HP - 4.10TCA 167HP Ø103	173
331200	8500/9200 Commom Rail	DIESEL 4800cc.	4.12TCE (OHV) 8V 150/180HP Ø105	177

INDICE - LINEA PESADA

INDEX - HEAVY LINE

BEDFORD

Ref.	Modelo/Model		Cm³	Motor/Engine	
210800	C14 - J17/J27/J37 1962/64	DIESEL	3285cc.	200D 62HP Ø98.3	09
210000	J6 1961/71	DIESEL	4927cc.	300D 97HP Ø98.3	05
210200	C50 Turbo 1971/79	DIESEL	4927cc.	300DX 97HP Ø98.3	07
210300	J6 1956/61	DIESEL	4927cc.	300D 97HP Ø98.3	08
210100	350H, C60, 714 1971/79	DIESEL	5755cc.	350D - CD600 137HP Ø106.36	06

CATERPILLAR

960550	Caterpillar	DIESEL		3054 - 4 Cilindros	I-26
960551	Caterpillar	DIESEL		3056 - 6 Cilindros	I-26
960548	Caterpillar Motoniveladora	DIESEL	6969cc.	3304 - 4 Cilindros Ø120.65	I-26
960549	Caterpillar Motoniveladora	DIESEL	10453cc.	3306 - 6 Cilindros Ø120.65	I-26

CHEVROLET

210800	C14 - J17/J27/J37 1962/64	DIESEL	3285cc.	200D 62HP Ø98.3	09
200400	Apache C10 3.9/16, Camión 4400 1957/..., Bel Air, Impala 1953/62		3851cc.	235 130HP Ø90.48	11
401000	GM D20	DIESEL	3860cc.	Q20B4 (OHV) 8V 70HP Ø98.4	211
410600	GM D10/20/40 Aspirado Turbo	DIESEL	3860cc.	Q20B4.236 (OHV) 8V 70HP Ø98.4	224
200600	Camión 3 3/4 6500 1954/62, C10, C 14, C60 BR 1969/...		4277cc.	261 142HP Ø95.25	12
210000	J6 1961/71	DIESEL	4927cc.	300D 97HP Ø98.3	05
210200	C50 Turbo 1971/79	DIESEL	4927cc.	300DX 97HP Ø98.3	07
210300	J6 1956/61	DIESEL	4927cc.	300D 97HP Ø98.3	08
280100	283/302/307/327 Carburador, 327/350 No Corvette, Pick Up y Medianos 283/307/327 Camiones 1967/...		5735cc.	GM C350 V8 Ø101.6	13
281100	Truck 1996/01, Vortec Vin R		5735cc.	C350 V8 Ø101.6	14
210100	350H, C60, 714 1971/79	DIESEL	5755cc.	350D - CD600 137HP Ø106.36	06
410900	Brasil D60 - D70	DIESEL	5840cc.	6-357 Veh. 120HP - Agri 91HP - Ind.108HP Ø104.14	227

CIMARRON

210500	1986/...	DIESEL	3283cc.	3300D 89HP Ø98.42	16
210400	1976/85	DIESEL	3285cc.	3300D 88HP Ø98.3	15
210600	1979/85	DIESEL	3840cc.	3800D 99HP Ø106.4	17
210700	1986/...	DIESEL	3840cc.	3800D 99HP Ø106.4	18

CUMMINS

870800	ISF Series, Camiones, Pick-Up	DIESEL	2776cc.	ISF2.8 (SOHC) 16V 150/156HP Ø94	28
870900	ISF Series, Camiones, Ómnibus, Pick-Up	DIESEL	3759cc.	ISF3.8 (OHV) 16V 148HP Ø102	29
870000	Serie B	DIESEL	3900cc.	4B - 4BT - 4BTA 100/130HP Ø102	19
870500	Bus, Agrale, Euro III/IV, Electrónico 2003/...	DIESEL	3920cc.	ISBe (OHV) 16V 150/170HP Ø102	25
800800	ISB 2004/...	DIESEL	5883cc.	ISBe 6 275HP Ø102	71
870100	Serie B	DIESEL	5900cc.	6B - 6BT - 6BTA (SOHC) 12V 180/205HP Ø102	21
870600	Serie C 1832/2632	DIESEL	8270cc.	ISCe6 24V 315HP Ø114	26
870200	Serie C - Bus, Camión, Agrícola	DIESEL	8300cc.	6C - 6CT - CTA (SOHC) 12V 254/294HP Ø114	23
870307	Serie C - Bus	DIESEL	8300cc.	6C - 6CT - CTA 254/294HP Ø114	I-28
873208	Camiones	DIESEL	14016cc.	NT855 (OHV) 24V 340HP Ø140	I-29
870700	ISX Series	DIESEL	14951cc.	ISX (DOHC) 24V 380/540HP Ø137	27
871000	ISX Series - 400, 425, 450, 460, 470, 475	DIESEL	14951cc.	ISX (DOHC) 24V 405/475HP Ø137	30
871308	Tractor, Excavadora, Tractor 7950, 7980	DIESEL	18942cc.	QSK19 (OHV) 24V 6 cilindros 532HP Ø159	I-29

DAF

420600	Va 200, VS 200 1986/...	DIESEL	1994cc.	TN44 Ø 84,4	232
873208	95 XF 530 1997/... - FT95.500 V 1994/98	DIESEL	14016cc.	VF390M 530HP - F373M 507HP (OHV) 24V Ø140	I-29

DEUTZ

650000	Tractor A40	DIESEL	2660cc.	F2L 514 (SOHC) 4V 56HP Ø110	31
650200	Tractor 69/75 A 46, 74/78 A65 1969/75	DIESEL	2908cc.	A - F2L 1114 46HP - 2114 50HP Ø115	33
660000	Tractor 1978/81	DIESEL	3064cc.	B-F3L 913 Ø102	43

INDICE - LINEA PESADA

INDEX - HEAVY LINE

DEUTZ

Ref.	Modelo/Model		Cm³	Motor/Engine	
650200	Tractor 69/75 A 46, 74/78 A65 1969/75	DIESEL	3167cc.	A - F2L 2114 Ø120	33
650300	Tractor A55 1959/69	DIESEL	3990cc.	F3L 514 50HP Ø110	34
660100	Tractor, Agrale 4-913, Turbo 4-913 1978/...	DIESEL	4086cc.	F4L 913 (OHV) 8V 87HP Ø102	44
650600	Tractor A65 1969/78	DIESEL	4363cc.	A-F3L 1114 115HP	37
650600	Tractor A65 1969/78	DIESEL	4750cc.	A-F3L 2114 120HP	37
660200	Tractor 1978/...	DIESEL	5106cc.	B-F5L 913 Ø102	45
650400	Tractor 470 1959/69	DIESEL	5320cc.	F4L 514 (OHV) 8V 65HP Ø110	35
650700	Tractor A85 1969/78	DIESEL	5817cc.	A-F4L 1114 Ø115	38
650100	DD1000, DD9000 Camión, Tractor 1978/81	DIESEL	6128cc.	F6L 913 (OHV) 12V 130HP Ø102	32
650700	Tractor A85 1969/78	DIESEL	6333cc.	A-F4L 2114 Ø120	38
650500	Tractor A110 1959/69	DIESEL	7980cc.	F6L 514 (OHV) 12V Ø110	36
650800	Tractor, Bus, A130, A144 1969/78 Turbo	DIESEL	8725cc.	A-F6L 1114 (OHV) 12V Ø115	39
650800	Tractor, Bus, A130, A144 1969/78 Turbo	DIESEL	9500cc.	B-F6L 2114 (OHV) 12V Ø120	39
650900	200 D16, 200 D19, 200 D2M, 200 RS, 210 EV 120, Tractor 5020 1969/77	DIESEL	11309cc.	F8L - 413 V8 16V Ø120	40
651000	Estacionarios 0302 6472, AY 0148-00, 0301 7177 UY 0147-00 Vehicular Omnibus, Camiónes, 0302 6545 AY 0148-00, 0301 7177 UY 0147-00	DIESEL	11309cc.	F8L - 413F V8 16V Ø125	41

DODGE

400000	D100/D200 1987/...	DIESEL	3336cc.	4.203-P4-192Z (OHV) 8V 71HP Ø91.49	201
220700	Continental 3 3/8 - 3 7/16, D100/200/400/500 1951/64	DIESEL	3956cc.	241 95HP Ø85.73	47
220700	Continental 3 3/8 - 3 7/16, D100/200/400/500 1951/64	DIESEL	4106cc.	251 100HP Ø87.31	47
400100	DP 400/500 1964/...	DIESEL	5004cc.	6.305 Cadenero (SOHC) 12V 100HP Ø91.44	202
440100	Camión 1978/...	DIESEL	5100cc.	D225-6 102HP Ø95	180
400200	DP 600/800 1968/...	DIESEL	5798cc.	6.354-2 (OHV) 12V 140HP Ø98.47	203
400400	D600/800 1976/...	DIESEL	5798cc.	6.354-4 Turbo (OHV) 12V 172HP Ø98.42	205
400900	DP 600/800	DIESEL	5798cc.	6.354-1 (OHV) 12V 135HP Ø98.43	210
410900	P700D/ P900	DIESEL	5840cc.	6-357 Veh 120HP - Agrícola 91HP - Ind. 108HP Ø104.14	227
870100	Truck 359 1989/93, Ram 2007/...	DIESEL	5883cc.	6B (SOHC) 12V 330HP Ø102	21

DYNAPAC

330800	Cilindro Vibratorio CHF 44 1983/...	DIESEL	2942cc.	D229-3 (SOHC) 6V 72HP Ø102	176
--------	-------------------------------------	--------	---------	----------------------------	-----

FIAT PESADO - IVECO

710200	Tractor 1955/...	DIESEL	665cc.	Motorino 55/60/788R Ø75	60
700600	Motor Arranque, Tractor 1955/74	DIESEL	1135cc.	U25 - 211R - CD Ø85	55
700900	Tractor U25 1957/62, Tractor 211R 1962/65	DIESEL	2270cc.	615 40HP Ø85	58
710305	Tractor 411R/411T, 431R 1959/85	DIESEL	2592cc.	480-540T 100HP	I-31
440000	Tractor	DIESEL	2977cc.	D225-4 68HP Ø95	179
700300	850E	DIESEL	3421cc.	650 - 700 Ø110	52
700800	Tractor Someca, CN3 1961/70	DIESEL	3421cc.	CN3 Ø110	57
710405	Tractor 400 E.V.U, 500, Super 600E, 480 1969/80	DIESEL	3455cc.	640-670-680 100HP	I-31
700400	Tractor Camiónes	DIESEL	3456cc.	DA - 50 - 40 Ø100	53
710505	Tractor Someca, Leoncino 1950/...	DIESEL	3663cc.	780/780DT Ø103	I-31
800407	Tractor 780/880 1976/...	DIESEL	3666cc.	8045.04 Ø103	I-32
700800	Tractor, Camiónes 780/780DT/765C/766/855	DIESEL	3705cc.	CN4 Ø110	57
310400	Tractor 400 E.V.U, 500, Super 600E, 480 1969/80	DIESEL	3922cc.	D229-4 (SOHC) 8V 96HP Ø102	167
700000	Escavadora FB80	DIESEL	4156cc.	M45 - 450 - 55 Super Son Ø105	49
700300	Tractor Someca 1965/74		4397cc.	CO3 Ø108	52
440100	Someca M45/M50, Super Som 55/46A, Tigrotto 1969/...		5100cc.	D225-6 102HP Ø95	180
700500	Tractor AD7B, 980E, S90		5401cc.	700E - 800E - CO3 - 640 - 740 90/106HP Ø115	54
800300	Camión 150 N Turbo AU130, Eurocargo 150 E23/E20		5861cc.	8060.25 177HP - 8060.45/45S 207HP (OHV) 12V Ø104	65
800600	75/80/85/95/100/120/130/150/170 E15 Turbo 1991/..., 80/85/100/120 130/135/150/170 E18 Turbo 1991/..., 80/90/100/E21, 135/150/170/180/E23		5861cc.	8060.25 143/177HP - 8060.45/S Eurocargo 207/277HP (OHV) 12V Ø104	69

INDICE - LINEA PESADA

INDEX - HEAVY LINE

FIAT PESADO - IVECO

Ref.	Modelo/Model		Cm³	Motor/Engine	
800800	Eurocargo 80 E18/E21, 90 E18/E21 Tector, Commonrail Turbo Intercooler EDC 130 E18, 120 E24/E28, 150 E18 2004/...	DIESEL	5880cc.	170E22 - F4AE0681D 24V TDI- EDC 180/210HP (OHV) 24V Ø102	71
310500	Tractor, CO3 1971/80	DIESEL	5883cc.	D229-6 145HP Turbo 160HP Ø102	169
700700	Tractor S90, FE105, FA120, FE105B	DIESEL	6546cc.	60 RL Ø122	56
700100	Tractor 1962/69	DIESEL	6872cc.	780 - R - AE Ø125	50
700200	Tractor - CP3 1972/80	DIESEL	7412cc.	840 - 900 - 1100 - CP3 - 900E 165HP Ø110	51
710100	Camión 1964/83	DIESEL	7412cc.	673N - CP - 840 - 900 Ø110	59
800100	Camión 203	DIESEL	10676cc.	682 N2 MK3 Ø125	63
800900	Cursor 8 Eurotech E24/E31/E35, Eurotrakker E24/E27/E31/E35/T27/T31/T33 T35/T36, Stralis S27/S30/S31/S33/S35/S36, Cavallino, Euromover E24 2007/...	DIESEL	8000cc.	F2BE0681 - F2BE3681 E4 (SOHC) 24V Turbo Intercooler 310HP Ø115	72
801108	Eurotech Cursor 10 190/260/440 E40 2001/..., Stralis 2002/...	DIESEL	10308cc.	F3AE Turbo Intercooler (SOHC) 24V 400/450HP Ø125	I-32
800200	Camión Bus 341A, 221, 221H, 619 NP 1965/66, 693 N/N1 - T/T1 1965/68	DIESEL	12883cc.	221- 8210.01 240HP Ø135	64
801000	Euro Stard Cursor 13 260E48, 440E46/48, Stralis 260/440S44, 190/260 440S48/260/440S50/54/56, Eurotrakker Cursor 13 190/260/340/380E38 E44-400/410/440/720E38/E44	DIESEL	13000cc.	F3BE3681A Turbo Intercooler 380/420HP Ø135	74
800000	Camión 619N1, 697N TB, Bus 391, 691, 319N, Bus 221A 1970/...	DIESEL	13798cc.	8210.02 260HP (OHV) 12V Ø137	61
800500	Euro Trakker, Euro Star, Euro Tech 1989/..., 180E42, 190E31/E42/E36, 380E31 240E42/E36, 260E37/E42/E36, 400E31/E37/E42, 410E37/E42, 440E37/E42, 1991/...	DIESEL	13798cc.	8210.42L LE2 370HP - 8210.42K KE2 420HP 8210.22.800 310HP (SOHC) 12V Ø137	67

FORD PESADO

870800	F350, F4000 2014/...	DIESEL	2776cc.	ISF2.8 (SOHC) 16V 150HP Ø94	28
330000	Tractor - Maquinaria Agriola 4600/4110/4140/4190/4200/4400/4410 1965/74 4610/4610H/4610SU 1981/90	DIESEL	3294cc.	BSD 332 - 333/H 81HP Ø111.8	76
400000	F100 1970/...	DIESEL	3336cc.	4.203-P4-192Z (OHV) 8V 71HP Ø91.49	201
410000	F100	DIESEL	3336cc.	4.203 Potenciado (OHV) 8V 71HP Ø91.44	218
870000	F4000 2000/..., Cargo 915, Euro II	DIESEL	3900cc.	4B - 4BT - 4BTA 100/130HP Ø102	19
310400	F4000 1992/93, F2000 1980/..., FB4000 1985/...	DIESEL	3922cc.	D229-4 (SOHC) 8V 96HP Ø102	167
320400	Camión F4000 1986/...	DIESEL	4156cc.	D226-4 (OHV) 8V 82HP Ø105	171
330100	5610/5030/5110/5610/5900/6600/6700/7000/7100/7200	DIESEL	4196cc.	BSD 442 - 256 72HP Ø111.8	77
330400	Euro I/II/III	DIESEL	4300cc.	4.10 X10 90HP - 4.10T 133HP - 4.10TCA 167HP Ø103	173
330100	6410/6610/6710/7600/7700	DIESEL	4385cc.	BSD 444 80HP Ø111.8	77
330100	6810/7410/7610/7710	DIESEL	4392cc.	BSD 444T 82HP Ø111.8	77
330100	F2000/F4000, FB4000, Tractor 6600/6610	DIESEL	4393cc.	268 82/87HP Ø111.8	77
400100	F350/600	DIESEL	5004cc.	6.305 Cadenero (SOHC) 12V 100HP Ø91.44	202
400300	F350/600 1974/...	DIESEL	5004cc.	6PF - 305 102HP Ø91.44	204
410100	F600	DIESEL	5004cc.	6PF - 305 Potenciado 100HP Ø91.49	219
400200	F600/700	DIESEL	5798cc.	6.354-2 (OHV) 12V 140HP Ø98.47	203
400400	F7000 Camiónes - Ford pesados y semi-pesados	DIESEL	5798cc.	6.354-4 Turbo (OHV) 12V 172HP Ø98.42	205
400900	F600/700	DIESEL	5798cc.	6.354-1 (OHV) 12V 135HP Ø98.43	210
410900	F600/F750/F1100/F6000/F7500/F11000	DIESEL	5840cc.	6-357 Veh. 120HP - Agrícola 91HP - Ind. 108HP Ø104.14	227
420000	F400/F600/F7000/F11000/F12000/F13000	DIESEL	5840cc.	6-358 Veh. 133HP - Agrícola 118HP - Ind. 127HP Ø104.14	228
310500	F14000/F4000 1994/96, Cargo, F12000/F14000 1985/...	DIESEL	5883cc.	D229-6 145HP Turbo 160HP Ø102	169
311100	Camión 1964/78	DIESEL	5900cc.	351 V8	75
870100	F14000 Turbo, F4000 1999/..., 1416 Euro I, Dodge Truck 359 1989/93	DIESEL	5900cc.	6B - 6BT - 6BTA (SOHC) 12V 180/205HP Ø102	21
650100	F7000 1978/81	DIESEL	6128cc.	F6L 913 130HP Ø102	32
311100	Camión 1964/78	DIESEL	6400cc.	391 V8	75
330700	F14000 1995/98, Euro I/II	DIESEL	6450cc.	6.10 X10 139HP - 6.10T 201HP - 6.10TCA 250HP Ø103	174
330200	7810/7910/8210/8530 1988/..., 8630/8750/8830 1992/...,	DIESEL	6572cc.	Fase I-II Cargo 6.6/7.8 Simples/Turbo 110HP Ø111.8	78
870600	2632-E/2932-E/4432-E/4532-E/5032-E - CARGO 2003/...	DIESEL	8270cc.	ISCe6 24V 315HP Ø114	26
870200	Cargo 1722/1730/2625 1998/..., F14000 1999/...	DIESEL	8300cc.	6C - 6CT - CTA (SOHC) 12V 254/294HP Ø114	23
870307	Cargo 1722 - 1730 - 2625 1998/... - F14000 1999/...	DIESEL	8300cc.	6C - 6CT - CTA 254/294HP Ø114	I-34

INDICE - LINEA PESADA

INDEX - HEAVY LINE

FOTON

Ref.	Modelo/Model		Cm³	Motor/Engine	
870800	Aumark 2000/3000/4000/5000/6000/7000 2012/...	DIESEL	2776cc.	ISF2.8 (SOHC) 16V 126HP Ø94	28

HANOMAG

750100	Tractor, D28LA/D28 1950/55	DIESEL	2800cc.	R25 - L28 - R35 - R40 - R435 Brillant Ø90	80
750200	Brillant, Tractor, D28C 1965/71	DIESEL	2800cc.	R40 25e - R57 - R46 Ø90	81
750000	Tractor, D57 1963/...	DIESEL	5702cc.	R45/55/60/75 Ø110	79

HYUNDAI

995100	Mighty, County - Turbo Intercooler	DIESEL	3298cc.	D4AL (SOHC) 8V 120HP Ø100	83
995200	Mighty, County - Aspirado	DIESEL	3568cc.	D4AF 8V 96HP Ø104	84
995300	Mighty, County - Turbo Intercooler	DIESEL	3907cc.	D4DA (SOHC) 8V 155HP Ø104	85

JOHN DEERE

850000	1030/1035/1520/1530/204/302 1973/...	DIESEL	2696cc.	3164D Ø102	87
850100	Tractor Equipos Viales 2120/2030/2035/2270/2280/2340, JD310/401/440/450/480 1974/...2130/2135/1640/1840/2140/JD4400/540B/550/555 1980/...	DIESEL	3590cc.	4219 D 81HP Ø102	88
850100	Tractor Equipos Viales 2120/2030/2035/2270/2280/2340 - JD310/401/440/450/480 1974/...2130/2135/1640/1840/2140/JD4400/540B/550/555 1980/...	DIESEL	3918cc.	4239 D/T 81HP Ø102	88
850100	450/480 1974/...2130/2135/1640/1840/2140/JD4400/540B/550/555 1980/...	DIESEL	3918cc.	4239 D/T 81HP Ø102	88
850700	Motores Agrícolas e Industriales	DIESEL	4500cc.	4540TJ31 107HP - 4045DJ31 74HP Ø106	94
850300	3420, J10, 4420, 570, Tractor Motoniveladora 1972/...	DIESEL	4976cc.	303 85HP Ø98.04	90
850300	3420, J10, 4420, 570, Tractor Motoniveladora 1972/...	DIESEL	5393cc.	329 87HP Ø102	90
850200	Tractor Motoniveladora 6329D, 3120/3130/3135/2840/630/730/JD303/444/540/570/482/6359D, 3140/3040/3640/4040/960/975/2940/3050/3350/3650	DIESEL	5395cc.	6.329D 87HP Ø102	89
850600	6505/6605/6615/7500, Power Tech, MUM, Power Tech, Gen Set	DIESEL	5395cc.	6068TJ31/32 - 6068TJ61 - 6068HJ63 150/178HP Ø106	93
850200	Tractor Motoniveladora 6329D, 3120/3130/3135/2840/630/730/JD303/444/540/570/482/6359D, 3140/3040/3640/4040/960/975/2940/3050/3350/3650	DIESEL	5877cc.	6.359D 87HP Ø106.5	89
850400	3350/3550/6500/6600/7500, Cosechadora 1075 1991/...	DIESEL	5879cc.	6359D 110/125HP Ø106.5	91
850500	730, Tractor 375 1960/74	DIESEL	6156cc.	Ø155.58	92

KOMATSU

760100	Tractor, Autoelevador	DIESEL	2800cc.	4D94-E 8V 40HP Ø93	97
760200	Tractor, Autoelevador	DIESEL	2800cc.	4D94-E 8V 40HP Ø94	98
760000	Tractor, Autoelevador	DIESEL	2940cc.	4D94 8V 39HP Ø104	95
760300	Tractor, Autoelevador	DIESEL	2940cc.	4D94 8V 39HP Ø104	99
760400	Tractor, Autoelevador	DIESEL	3260cc.	4D95L 8V 54/65HP Ø96	100
760500	Tractor, Autoelevador	DIESEL	3260cc.	4D95 8V 54HP Ø96	101
760600	Tractor, Autoelevador	DIESEL	4330cc.	4D105-5 63/66HP Ø112	102
760700	Tractor, Autoelevador	DIESEL	4330cc.	4D105-3 63HP Ø111	103
760800	Tractor, Excavadora	DIESEL	4890cc.	6D95 71HP Ø97	104
760900	Tractor, Autoelevador	DIESEL	4890cc.	6D95 71HP Ø94	105

KUBOTA

770000	Maquinaria Agrícola D722	DIESEL	719cc.	3D66 6V 20HP Ø86	107
770200	Maquinaria Agrícola D722	DIESEL	719cc.	3D66 6V 20HP Ø77	109
770100	Maquinaria Agrícola D905	DIESEL	898cc.	3D72 6V Ø72	108
770400	Maquinaria Agrícola V1205	DIESEL	1200cc.	4D72 8V Ø72.5	111
770300	Maquinaria Agrícola D1402	DIESEL	1395cc.	3D85 6V 35HP Ø77	110
770500	Maquinaria Agrícola V1502	DIESEL	1498cc.	4D76 8V 46HP Ø77	112
770600	Maquinaria Agrícola V2203	DIESEL	2197cc.	4D87 8V 46HP Ø88	113
770700	Maquinaria Agrícola V2203	DIESEL	2197cc.	4D87 8V 46HP Ø88	114
770800	Maquinaria Agrícola V3300	DIESEL	3318cc.	4D98T 12V Ø98	115

LEYLAND

420600	Sherpa 185/200/215/220/230/240/250/255 1986/94	DIESEL	1994cc.	Prima 65 64HP Ø84.45	232
--------	--	--------	---------	----------------------	-----

MAHINDRA

930007	Tractor 255DI - 265DI - Pick Up	DIESEL	1300cc.	25HP Ø89.99	I-38
--------	---------------------------------	--------	---------	-------------	------

INDICE - LINEA PESADA

INDEX - HEAVY LINE

MAHINDRA

Ref.	Modelo/Model		Cm³	Motor/Engine	
930007	Tractor 255DI - 265DI - Pick Up	DIESEL	1800cc.	25HP Ø89.9	I-38
930007	Tractor 255DI - 265DI - Pick Up	DIESEL	2500cc.	25HP Ø89.9	I-38

MAZDA

971200	Pick Up, Camión T3000 1985/..., Autoelevador Yale 1984/...	DIESEL	2977cc.	HA/WEF 8V 86HP Ø95	117
974100	T3000 1981/84	DIESEL	2977cc.	HA 8V 86HP Ø95	118
974200	Pick Up E3000 1978/81	DIESEL	2977cc.	HA 8V 86HP Ø95	119
974300	Pick Up T3500 1984/...	DIESEL	3455cc.	SL (OHV) 8V Ø103	120
974400	Pick Up T3500 1984/...	DIESEL	3455cc.	SL-T (OHV) 8V Ø103	121
974500	Pick Up T4000	DIESEL	4021cc.	TF (OHV) 8V Ø105.5	122
974600	Pick Up T4500	DIESEL	4553cc.	TM (OHV) 8V Ø109	123

MAXION

410600	GM D10, F350, VW6.80, Case 550	DIESEL	3860cc.	Prima 65 64HP 4.236 lny. Directa 70HP Ø98.4	224
401100	MF290/292/610/620	DIESEL	4100cc.	P4000-4000T 72/86HP Ø100	212

MERCEDES BENZ

360100	240D/TD 1973/..., 207/307/407/507/510D, L406/407DG, 0309D 1977/..., 240GD 1976/87, MB100/200/300/400/180D/150/170	DIESEL	2404cc.	OM 616.912/934/960/916/940/961/963 65/72HP (SOHC) 8V Ø91	142
350100	MB L608 D/Unimog 1966/...	DIESEL	3786cc.	OM 314 (OHV) 8V 85HP Ø97	126
350800	711D/811D/609D/614D/709D/809D, OM364 Aspirado 1987/...	DIESEL	3971cc.	OM 364 (OHV) 8V 90/115HP Ø97.5	134
351000	Vario 614/814/815/810	DIESEL	4250cc.	OM 904 LA/LA IMO Elect. (OHV) 12V 75/125HP Ø102	137
351000	Atego 712/714/715/717/812/814/815/817/917/1017/1214/1215/1217/1317/1517	DIESEL	4250cc.	OM 904 LA/LA IMO Elect. (OHV) 12V 75/125HP Ø102	137
350000	MB 3500, L3250/L3500 1949/52	DIESEL	4580cc.	L911 OM311/312 98HP Ø90	125
353008	Unimag U 2002/..., Atego 2 2004/..., Accelo, Atron 2012/...	DIESEL	4801cc.	OM924 218/156/185HP (OHV) 12V Ø106	I-40
350200	MB 1112/1114/0140/L1112/L1514 1957/...	DIESEL	5100cc.	OM 321 (SOHC) 12V 108HP Ø95	127
350300	MB 1114, 0140 1972/..., OM 352 Turbinado 1981/..., OM 352 Aspirado 1981/...	DIESEL	5675cc.	OM 352 (OHV) 12V 100HP Ø97	128
350400	MB 1517 Turbo 0170, L911, L1518 1978/...	DIESEL	5675cc.	OM 352A (OHV) 12V 130HP Ø97	130
360200	Turbinado Aspirado 1981/...	DIESEL	5675cc.	OM352 - OM352A (OHV) 12V Ø97	143
352200	MB 1518 desde 1991/... - Motor Híbrido. (Con junta tapa lateral de goma)	DIESEL	5765cc.	OM 352 - OM 352A Turbo (OHV) 12V 130HP Ø97	139
350900	OH1215/1315/1316/1319/1320/1420/1615, Aspirado Turbo 1620, OHL1621/OS1318, L1915/1314/1318/1365/2018/3611R/2214/2217	DIESEL	5957cc.	OM 366 138HP - OM 366A/LA 170HP Euro Ecolog. Ø97.5 OM906 LA 18V Electrónico - OM906.911/919/920/921	135
352000	Atego I 925/1225/1228/1325/1328/1525/1528/1823/1828/2523/2528 1998/...	DIESEL	6370cc.	922/923 - 231/245/279HP (OHV) 18V Ø102	138
353108	Atego 2007/..., Axor 2004/..., Conecto 2001/..., Tourino 2003/..., Integro 2006/...	DIESEL	7201cc.	OM926.991 256/279/286HP (OHV) 18V Ø106	I-40
350600	MB 1521/1526 1985/87	DIESEL	9650cc.	OM 355-5 84HP (OHV) 20V Ø128	132
360000	1630/1632/1633, MB485.980, MB489.960/961, MB475.907/950, MB954/976/979/982/984/986/989/991/994/997/998	DIESEL	9973cc.	OM449A/LA - HLA 5 cilindros 180/200HP (OHV) 10V Ø128	141
360400	0371, Bus 1926 1985/...	DIESEL	11580cc.	OM 355-6 230HP Ø128	145
360300	O372/O400/L1395/1939/1941 1973/...	DIESEL	11967cc.	OM 447-6 (OHV) 12V 250/300HP Ø128	144
360800	OM457LA/LAIII/HLA/HLA III, OM457.933/938/940/944/949, OM458.960/970/980/938CAM, O400BUS Camión LS1938, Axor 2035/40/44	DIESEL	11967cc.	OM457 Electrónico - 252 - 456PS 24V 355/380HP (OHV) 24V Ø128	147
361208	Citaro, Travego, Conecto, Axor, Turismo 1998/...	DIESEL	11967cc.	OM457 - OM458 (OHC)	I-40
361308	Actros MP4 2011/...	DIESEL	12809cc.	OM471.900 422HP (DOHC) 24V Ø132	I-41

MITSUBISHI

962800	Tractor, Autoelevador	DIESEL	1415cc.	K4E 8V 33HP Ø77	149
963100	Tractor, Autoelevador	DIESEL	1500cc.	S4L (OHV) 8V 16/37HP Ø78	150
964100	Tractor, Autoelevador	DIESEL	2000cc.	4G63 8V 85	151
964300	Tractor, Canter	DIESEL	2080cc.	4DQ7 8V Ø89	153
964200	Tractor, Canter	DIESEL	2084cc.	4DQ5 8V 40HP Ø86	152
964700	Tractor, Autoelevador	DIESEL	2477cc.	S4E 8V Ø95	154
965100	Canter Serie FB3 1985/93	DIESEL	2659cc.	4DR51 (SOHC) 8V 80HP Ø92	155
965100	Truck 2.8 Serie FB308 1985/89	DIESEL	2800cc.	4DR51 (SOHC) 8V Ø92	155
965200	Tractor, Autoelevador	DIESEL	2960cc.	S4E2 8V Ø100	156

INDICE - LINEA PESADA

INDEX - HEAVY LINE

MITSUBISHI

Ref.	Modelo/Model		Cm³	Motor/Engine	
965300	Tractor, Autoelevador	DIESEL	3331cc.	S4S 8V	157
965400	Tractor, Autoelevador	DIESEL	3900cc.	S6E 12V	158
965500	Tractor	DIESEL	4249cc.	S4K Ø102	159
965600	Canter 1992/96	DIESEL	4948cc.	6D31T 12V 145HP Ø100	160
965700	Tractor, Autoelevador	DIESEL	4996cc.	S6S 12V	161
966100	Tractor, Autoelevador	DIESEL	6380cc.	S6KT Ø102	164
965900	6000 Bus, 6000 Truck 1984/92 (FK115/FK215/FK415/FK425/FK515)	DIESEL	6557cc.	6D14T 12V Ø110	162
966000	6900 Bus (MK116F/MM116H/516H) 1982/88, Truck (FK116/215/216/316) 1984/92	DIESEL	6919cc.	6D15 (OHV) 12V 131HP Ø118	163
966200	Bus, Truck (FK416/FK516) 1988/...	DIESEL	7545cc.	6D16A Ø118	165
966300	Camión FP418/FV418/FS428, Bus FB418 T850 1988/...	DIESEL	11149cc.	6D22T (OHV) 12V 260/310HP Ø93	166

MWM

331007	D-226-2	DIESEL	2078cc.	D-226-2 40HP Ø105	I-43
320800	Tractor 65ID, Valmet 62ID 1970/76	DIESEL	2550cc.	D225-3 50HP Ø95	172
330800	Camión TX 1600, Autoelevador, E300, Tractor 68 1983/...	DIESEL	2942cc.	D229-3 (SOHC) 6V 72HP Ø102	176
440000	850E	DIESEL	2977cc.	D225-4 68HP Ø95	179
440000	Tractor 85ID 1970/76	DIESEL	3400cc.	D225-4 68HP Ø95	179
310400	F100/F1000 1993/96, F4000 1992/93, F2000 1980/..., FB80, FB4000 1985/...	DIESEL	3922cc.	D229-4 96HP (SOHC) 8V Ø102	167
320400	Tractor 86-ID, Camión F4000 1986/..., Tractor 85 1986/...	DIESEL	4156cc.	D226-4 (OHV) 8V 82HP Ø105	171
330400	7000/7500/8500 - Euro I/II/III - 7100/8120/8140/8150/13150	DIESEL	4300cc.	4.10 X10 90HP - 4.10T 133HP - 4.10TCA 167HP Ø103	173
331200	Agrale 8500/9200, Constellation 13.180E/15.180E	DIESEL	4800cc.	4.12TCE Commom Rail (OHV) 8V 150/180HP Ø105	177
440100	Camión 1978/... - Tractor AD7B, 980E, S90 - Tractor Valmet 110 ID	DIESEL	5100cc.	D225-6 102HP Ø95	180
310500	F14000/F4000 1994/96, Cargo, F12000/F14000 1985/... Tractor S90, FE105/B	DIESEL	5883cc.	D229-6 145HP Turbo 160HP Ø102	169
330700	13180/15180/16210 - F14000 1995/98, Euro I/II	DIESEL	6450cc.	6.10 X10 139HP - 6.10T 201HP - 6.10TCA 250HP Ø103	174
331300	26.260E/31.260E/17.260EOT/17.210EOD, VM210/260/310	DIESEL	7118cc.	6.12 TCE (OHV) 12V 210/260/310HP Common Rail Ø105	178

NISSAN

901900	Tractor		1500cc.	H15 8V Ø76	181
902000	Tractor, Autoelevador	DIESEL	1500cc.	SD15 6V Ø83	182
902000	Tractor, Autoelevador	DIESEL	1600cc.	SD16 6V Ø83	182
904900	Autoelevador 1983/...		1982cc.	H20-II (DOHC) 8V 92HP Ø87.2	183
905900	Tractor, Autoelevador		2472cc.	H25 (DOHC) 8V 62HP Ø92	184
906700	Tractor 1992/..., Condor 1992/94	DIESEL	2953cc.	BD30 (SOHC) 8V 86HP Ø96	185
906800	Trade 1993/96, Cabstar 1998/01	DIESEL	3000cc.	BD30-Ti (OHV) 8V 86HP Ø96	186
907000	Truck 1980/..., Patrol 1982/89	DIESEL	3246cc.	SD33 (OHV) 12V 95/100HP Ø83	187
907100	Truck 1986/..., Patrol 1983/...	DIESEL	3246cc.	SD33T (OHV) 12V 115HP Ø83	188
907200	Atlas 1984/86, Truck 1984/...	DIESEL	3298cc.	FD33 8V 99HP Ø108	189
907300	Atlas 1983/86, Civilian 1984/88, Truck 1984/...	DIESEL	3298cc.	FD33T 8V 118HP Ø108	190
907308	Truck 3500, Atlas 1986/91	DIESEL	3460cc.	FD35T Ø102,5	
907800	Atlas, Condor 1993/...		4214cc.	FD42 8V 123HP Ø109	192
907800	Atlas, Condor 1993/...		4617cc.	FD46 8V 133HP Ø109	192
907900	Atlas, Condor 1995/...		4617cc.	FD46 (DOHC) 8V 113HP Ø109	193
907400	Camión 5700 1978/...	DIESEL	5654cc.	ED6 (SOHC) 12V Ø109	191
908200	Camión 5700 1980/...	DIESEL	5654cc.	FD6 (SOHC) 12V 170HP Ø108	194
908300	Camión 5700 1975/83	DIESEL	5654cc.	FD6T (SOHC) 12V 175HP Ø108	195
908400	Camión, Bus 1977/...	DIESEL	6842cc.	ND6 (SOHC) 12V 133HP Ø110	196
908500	Camión, Bus 1992/95	DIESEL	9160cc.	NF6T 12V 300HP Ø120	197
908600	Camión, Bus 1969/...	DIESEL	10308cc.	PD6 (SOHC) 12V 200/300HP Ø125	198
908700	Camión, Bus 1970/...	DIESEL	10308cc.	PD6T (SOHC) 12V 260/300HP Ø127	199

PERKINS - MASSEY FERGUSON

420600	4.20 Marino D/TD 1986/..	DIESEL	1994cc.	Prima 65/80T 58/80HP Ø84.5	232
420400	MF50/50X/55X/135/200/235/250, MF 135/515	DIESEL	2360cc.	3.152 (OHV) 6V 42HP Ø89	231

INDICE - LINEA PESADA

INDEX - HEAVY LINE

PERKINS - MASSEY FERGUSON

Ref.	Modelo/Model		Cm³	Motor/Engine	
400500	Tractor Viñatero	DIESEL	2362cc.	P3 - 152 42HP Ø91.44	206
422000	MF133/135/148/230/235/240/254/353, Industrial MF40, Agrícola/Marino	DIESEL	2500cc.	D3.152-D3.152/2/4 - G3.152 (OHV) 8V 100HP Ø91.4	233
410200	MF50 Tractor, MF50X/55X, MF135/200/235/250	DIESEL	2502cc.	P3 - 152 42HP Ø91.44	220
420400	MF50/50X/55X/135/200/235/250, MF 135/515	DIESEL	2502cc.	3.152 (OHV) 6V 42HP Ø91.44	231
423000	Case-IH CS 68/75 - Challenger	DIESEL	3300cc.	320D/DS 33/69HP Ø108	01
410500	Tractor MF65X, MF40B/65/155/158/165/260/155/164C, CBC1000	DIESEL	3330cc.	D4.203/AD4.203 Iny. Directa 71HP Ø91.4	223
410800	Pick Up, Camiónes livianos	DIESEL	3330cc.	T 4.33 Turbo Iny. Directa 91/95HP Ø91.46	226
400000	D100/D200 1987/... - F100, Falcon 1970/...	DIESEL	3336cc.	4.203-P4-192Z (OHV) 8V 71HP Ø91.49	201
400700	Tractor M165, 265	DIESEL	3336cc.	MF165 - 265 71HP Ø91.49	208
410000	F100	DIESEL	3336cc.	4.203 Potenciado (OHV) 8V 71HP Ø91.44	218
410300	Potenciado	DIESEL	3336cc.	MF265 Potenciado 71HP Ø91.44	221
420100	Tractor 8 BR	DIESEL	3336cc.	4.203 - 8 BR Iny. Indirecta 71HP Ø91.49	229
401000	Vehicular GM D20	DIESEL	3860cc.	Q20B4 (OHV) 8V Iny. Directa 70HP Ø98.4	211
410600	GM D10, F350, VW6.80, Case 550, GM D10/20/40 Aspirado Turbo	DIESEL	3860cc.	4.236 (OHV) 8V Iny. Directa 70HP Ø98.4	224
420200	Case 580H	DIESEL	3860cc.	4.236 (OHV) 8V Iny. Directa 70HP Ø98.4	230
401500	Phaser 90, Phaser 110T, Phaser 120 Ti, T4.40, C4.40, MF6130/6140/6150	DIESEL	3993cc.	1004.4/T/TW (OHV) 8V 86/91HP Ø100	213
410600	MF220, F290, Tractor MF85X	DIESEL	4070cc.	4.248 (OHV) 8V 70HP Ø101	224
410700	Agrícola, Case 580H, MF85, MF270/275/285, MF220/220A, Hyster H110	DIESEL	4070cc.	A4 - 248 75HP Ø100	225
420200	Case 580H	DIESEL	4070cc.	4.248 (OHV) 8V Iny. Directa 100HP Ø100	230
401100	MF290/292/610/620	DIESEL	4100cc.	P4000-4000T 72/86HP Ø100	212
320400	Tractor 85 1986/...	DIESEL	4156cc.	D226-4 (OHV) 8V 82HP Ø105	171
423100	MF4292, MF4297	DIESEL	4400cc.	420DS Agco Sisu Power 110/117HP - 120/129HP Ø108	02
400100	DP 400/500 1964/... - F350/600	DIESEL	5004cc.	6.305 Cadenero (SOHC) 12V 100HP Ø91.44	202
400300	F100/F350/600 1974/...	DIESEL	5004cc.	6PF - 305 102HP Ø91.44	204
400600	Tractor - PF	DIESEL	5004cc.	6PF - MF1175 100HP Ø91.44	207
410100	F600	DIESEL	5004cc.	6PF - 305 Potenciado 100HP Ø91.49	219
400200	DP 600/800 1968/... - F600/700	DIESEL	5798cc.	6.354-2 (OHV) 12V 140HP Ø98.47	203
400400	D600/800 1976/... - F7000 Camiónes - Ford pesados y semi-pesados	DIESEL	5798cc.	6.354-4 (OHV) 12V Turbo 172HP Ø98.42	205
400800	Tractor 1095/1098/1195/1215	DIESEL	5798cc.	(OHV) 12V 140HP Ø98.3	209
400900	DP 600/800 - F600/700	DIESEL	5798cc.	6.354-1 (OHV) 12V 135HP Ø98.43	210
401700	1095/1098/1195/1215 1970/..., Tractores, Estancieros, Grúas, Rodantes	DIESEL	5798cc.	6.354-2 Turbo (OHV) 12V Ø98.47	216
410400	Tractor MF1215/1218	DIESEL	5798cc.	T6.354-4 (OHV) 12V 172HP Ø98.63	222
410900	MF3366	DIESEL	5840cc.	6-357 Veh. 120HP - Agrícola 91HP - Ind. 108HP Ø104.14	227
420000	MF 400C	DIESEL	5840cc.	6-358 Veh. 133HP - Agrícola 118HP - Ind. 127HP Ø104.14	228
401600	Phaser 125, MF396/399/630/640/3085/6160/6170 - Phaser 160Ti, MF660/3114 3125/3625/3635/3655/6189/6190/8110/8120/8130 - Phaser 180Ti, MF399 1994/...	DIESEL	5985cc.	1006.6/C/T/TW (OHV) 12V 131/152HP Ø100	214
423200	Case-IH CS 68/75 - Challenger	DIESEL	6600cc.	620D/DS 147/189HP Ø108	03
420508	D170 - P 200/260/270/320 - MF RX 100T		8850cc.	510 -540 V8 Ø108 170/183HP	I-47

SCANIA

810600	P94, R94 1996/...	DIESEL	8974cc.	DSC9, DSi9 (OHV) 12V 220/310HP Ø115	245
810300	P94-R94 1996/...	DIESEL	9000cc.	DSC9 (OHV) 12V 220/310HP Ø115	240
810500	Series P/G/R/T - SerieK, G340, R340, P340, R380, P3802004/...	DIESEL	10600cc.	DC11.08 340HP (OHV) 24V Ø127	244
810400	Serie4 Camión, 114C/114L 1994/04, 114G2001/08	DIESEL	10641cc.	DC 11.07 (OHV) 24V 329HP Ø127	242
810700	Serie4 Camión, Tractor, 114C/L 1999/04, 114G2001/08, BusK114 1997/07	DIESEL	10641cc.	DC 11.07 (OHV) 24V 329HP Ø127	246
810000	Camión, Omnibus L75/76, L/LB/LBS110/L111/LB111/LS111/LT111 LBS111/LBT111 1974/...	DIESEL	11020cc.	D11 - DS11 (OHV) 12V 280/333HP Ø127	235
810100	LB110/LBS110/L111/LS111/LT111/LBS111/LBT111/G112/L112/R112/T112 P113/P113HK/R113/R113HK/T113/K113CBL/K113GLP/K113TLB/K113TLP	DIESEL	11020cc.	D11 - DS11 - DSC11 (OHV) 12V 272/354HP Ø127	236
810400	Serie4-Tractor, Camiones, Bus 124C 400/420, 124L 400, 124G 420, Bus K124 T124C/L 400/420 1996/08, 124L 420 2001/08, T124G 400/420, BusK420 2010/...	DIESEL	11700cc.	DC12.01/03 400HP - DC12.09 - DSC12.05/06 420HP (OHV) 24V Ø127	242

INDICE - LINEA PESADA

INDEX - HEAVY LINE

SCANIA

Ref.	Modelo/Model		Cm³	Motor/Engine	
810700	Serie4 Camión, 114G, 114L 2005/08	DIESEL	11705cc.	DC 12.07 (OHV) 24V 379HP Ø127	246
810400	Serie4-Tractor, Camiones, Bus 124C 440/470, 124L 440/470 1999/08 124G 400/420, T124L 470 1996/08, 124G 440/470 1999/04	DIESEL	11716cc.	DT12.08 441HP - DT12.02 469HP (OHV) 24V Ø127	242
810500	G340/380/420, R340, P340/380, R380 2004/..., Bus Irizar Century 420, Bus K340/420 2006/..., Bus K380, Omni Express 380, P420, G420 2008/...	DIESEL	11700cc.	DC12.10 340HP - DC12.13 380HP - DC12.06/12 420HP (OHV) 24V Ø127	244
810500	P380/420, R380/420/470/480, G420 2004/..., G470 2005/..., Bus K380 G470 2010/..., G480, R480	DIESEL	11716cc.	DC12.17/18 379HP, DC12.14/15 420HP, DT12.18 440HP DT12.03/06 470HP, DT12.17 480HP (OHV) 24V Ø127	244
810800	Serie4 Camión, P124, R124, T124 1996/01-124C, T124C, T124G 1995/08	DIESEL	11716cc.	DSC 12.01/02 (OHV) 24V 360/420HP Ø127	247
810200	R142-T142-R143-T143-R144-T144	DIESEL	14190cc.	D14 - DS14 - DSC14 (OHV) V8 16V 400/500HP Ø127	238

SHANGAI

910900	Tractor	DIESEL		495A Tracción Simple - 485A 18 Tracción Doble	249
--------	---------	--------	--	---	-----

TOYOTA

924400	Autoelevador 1995/00	DIESEL	1998cc.	1DZ II (OHV) 8V 54HP Ø86	251
924500	Autoelevador 1998/05	DIESEL	1998cc.	1DZ (OHV) 8V 52HP Ø86	252
925300	Tractor 6F, Autoelevador	DIESEL	2953cc.	1Z 5FD/F 59HP Ø96	253
926500	Tractor 1988/...	DIESEL	4430cc.	11Z Ø96	254

VALMET

320800	Tractor 65ID, Valmet 62ID 1970/76	DIESEL	2550cc.	D225-3 50HP Ø95	172
330800	Camión TX 1600, Autoelevador, E300, Tractor 68, Cilin. Vibratorio CHF 44 1983/...	DIESEL	2942cc.	D229-3 (SOHC) 6V 72HP Ø102	176
440000	850E	DIESEL	2977cc.	D225-4 68HP Ø95	179
440000	Tractor 85ID 1970/76	DIESEL	3400cc.	D225-4 68HP Ø95	179
320400	Tractor 86-ID, Camión F4000 1986/..., Tractor 85 1986/...	DIESEL	4156cc.	D226-4 (OHV) 8V 82HP Ø105	171
440100	Camión 1978/... - Tractor AD7B, 980E, S90 - Tractor Valmet 110 ID	DIESEL	5100cc.	D225-6 102HP Ø95	180

VALTRA

423000	A65/A75, 305/355/365/405/455/465/555/565/600/700, SISU 320D, 320DS	DIESEL	3300cc.	320D/DS 33/69HP Ø108	01
423100	A950/A990/BM100/BM110 (4x2, 4x4)	DIESEL	4400cc.	420DS Agco Sisu Power 106/116/129HP Ø108	02
423200	8000	DIESEL	6600cc.	620D/DS 147/189HP Ø108	03

VOLARE

870800	Cinco 2016/...	DIESEL	2776cc.	ISF2.8 (SOHC) 16V 150HP Ø94	28
--------	----------------	--------	---------	-----------------------------	----

VOLKSWAGEN

870800	Delivery 4-150, 6-150	DIESEL	2776cc.	ISF2.8 (SOHC) 16V 150HP Ø94	28
330400	7100/8120/8140/8150/13150	DIESEL	4300cc.	4.10 X10 90HP - 4.10T 133HP - 4.10TCA 167HP Ø103	173
331200	Constellation 13.180E/15.180E	DIESEL	4800cc.	4.12TCE (OHV) 8V Common Rail 150/180HP Ø105	177
330700	13180/15180/16210	DIESEL	6450cc.	6.10 X10 139HP - 6.10T 201HP - 6.10TCA 250HP Ø103	174
331300	26.260E/31.260E/17.260EOT/17.210EOD	DIESEL	7118cc.	6.12 TCE 210/260/310HP (OHV) 12V Common Rail Ø105	178
870600	17300/17310/18310/19320/26320/17250E, Bus 17260EOT/18320EOT 2003/...	DIESEL	8270cc.	ISCe6 24V 315HP Ø114	26

VOLVO

880908	Metrobus 7700 1998/..., FL7 FL 7/230/245/260 1985/99, FL7 FL 7/285/290 1993/99, FM7 FM 7/250/290 1998/01, FS7 FS 718/230 1994/96	DIESEL	6725cc.	TD71F/FA/FAQ/FC/FQ/FD/FQ/FS/FSQ/G/E/FSO TD73E/ES - D7A/B/C 230/260/285HP 12V Ø104.8	I-50
331300	VM210/260/310	DIESEL	7118cc.	6.12 TCE 210/260/310HP (OHV) 12V Common Rail Ø105	178
880000	B58, B10M 1987/...	DIESEL	9600cc.	THD 101 KC (OHV) 12V 273/310HP Ø120.6	255
880100	B58 1980/85	DIESEL	9600cc.	THD 100D (OHV) 12V 230/260HP Ø120.6	257
880200	N10 1980/85	DIESEL	9600cc.	TD 100A (OHV) 12V 230/260HP Ø120.6	259
880300	N10 1985/89	DIESEL	9600cc.	TD 100G/101G/101F (OHV) 12V 273/300HP Ø120.6	261
880500	NL10 1998/	DIESEL	9600cc.	EDC Ø120.6	265
880600	NL10 1989/97	DIESEL	9600cc.	TD 102F/102FS (OHV) 12V 234/317HP Ø120.6	267
880208	N12 1980/89	DIESEL	11950cc.	TD 121G/120GA 295/360HP - 121F 328/385HP Ø130.2	I-50
880400	N12 1980/89	DIESEL	11950cc.	TD 121G/120GA 295/360HP - 121F 328/385HP Ø130.2	263
880700	NL12 1997/...	DIESEL	11950cc.	EDC Ø120.6	269
880800	NL12 1989/96	DIESEL	11950cc.	TD 122FS (OHV) 12V 396HP Ø130.2	271

FORMACION DE CODIGOS

CODE FORMATION

ANTIGUA EXPRESIÓN DE CÓDIGO TARANTO

ANTIGUA EXPRESIÓN DE CÓDIGO TARANTO

FORMADO POR CINCO DÍGITOS

2	2	4	0	0
LINEA	MOD.	TIPO DE JUNTA		

FORMADA POR SEIS DÍGITOS

2	2	0	4	0	0
LINEA	MODELO	TIPO DE JUNTA			

NUEVA REFERENCIA



DOS PRIMEROS DÍGITOS

--	--

INDICA EL RUBRO O LINEA AL CUAL PERTENECE EL ARTÍCULO

ARTICULOS DE FABRICACION

14 AUTO UNIÓN	57 RENAULT
15 CITROËN	58 RENAULT
20 CHEVROLET - OPEL	62 DETROIT
21 CHEVROLET - BEDFORD	63 CATERPILLAR
CIMARRON - DI TELLA	65 DEUTZ
22 DODGE - CHRYSLER - VW	66 DEUTZ
23 VW - FORD	70 FIAT TRACTORES
24 CHEVROLET - GM	71 FIAT TRACTOR - CAMIÓN
25 FIAT	75 HANOMAG
26 FIAT	76 KOMATSU
27 FIAT	77 KUBOTA
28 CHEVROLET - GM	80 FIAT CAMIONES / IVECO
29 CHEVROLET - GM	81 SCANIA
30 FORD - VW	85 JOHN DEERE
31 FORD - MWM	86 HONDA - ROVER
32 FORD - MWM	87 CUMMINS
33 FORD - MWM	90 ASIA MOTORS - KIA
34 FORD	NISSAN - TOYOTA
35 MERCEDES BENZ	91 KIA - MITSUBISHI
36 MERCEDES BENZ	SUZUKI - TOYOTA
37 MERCEDES BENZ	SHANGAI
38 SMART-MERCEDES	92 TATA - NISSAN
40 PERKINS / MF. / PF	TOYOTA - MITSUBISHI
41 PERKINS / MF.	93 ISUZU - MAHINDRA
42 PERKINS / MF.	TOYOTA
AGCO / SISU	94 DAEWOO - DAIHATSU
43 MAXION	95 DAIHATSU - BMW
44 MWM	MITSUBISHI - TOYOTA
45 PEUGEOT - INDENOR	SUBARU - DATSUN
46 PEUGEOT	96 MITSUBISHI
47 PEUGEOT	97 TOYOTA - MAZDA - LADA
50 RASTROJERO - INDENOR	98 BMW
VM - BORGWARD	99 HYUNDAI - CHERY
51 CHRYSLER	
52 CHRYSLER	
54 IKA - RENAULT - WILLYS	
55 RENAULT	
56 RENAULT - DACIA	

TERCER Y CUARTO DÍGITO

--	--

ESPECIFICA E INDICA EL TIPO DE MODELO AL QUE PERTENECE

ARTICULOS DE FABRICACION

EJEMPLOS

CITROËN	PERKINS
00 2CV 14HP	00 4-203
01 2CV 18HP	01 6-305
02 3CV	02 6-354 F2
04 AMI 8	03 6PF-305
	04 6-354 F4
	05 P3-152
	06 PF-MF
	07 MF M165-265
	08 MF 1095-1098
	09 6-354 F1
	10 GM D20 3.9
FIAT	PEUGEOT
00 1100	00 404
01 600	01 504 1.6
02 1500	02 504 1.8
03 1600	03 504 2.0
04 128 1100cc.	04 504 XD2
05 128 1300cc.	05 505
06 128 1500cc.	06 505 I
07 125	07 505 XD3
08 133	09 403
09 REGATTA 100S	15 205 1.0
11 DUCATO 2.8	16 106 1.4
20 BRAVO/A TD	17 106 1.2
21 BRAVO/A JTD	18 104 1.2
FORD	RASTROJERO
00 FALCON 7B	00 42 HP
01 FALCON SP	01 52 HP
02 V8 FASE 1	02 INDENOR 4,88
03 TAUNUS 2.0	03 INDENOR 6 CIL
04 TAUNUS 2.3	04 VM/BORGWARD
05 V8 FASE 2	
06 SIERRA 1.6	
08 A/AA	
09 FALCON 4B	
14 ESCORT 1.6	
20 TRANSIT 2.5	
21 FIESTA 1.4	

QUINTO Y SEXTO DÍGITO

--	--

DETERMINA EL TIPO DE JUNTA

ARTICULOS DE FABRICACION

00 JGO. JUNTA MOTOR
01 JGO. MOTOR SIN TAPA CILINDROS
05 JTA. TAPA CILINDRO
06 JTA. TAPA CILINDRO SUPERMEDIDA
07 JTA. TAPA CILINDRO
08 JTA. TAPA CILINDRO
10 JTA. TAPA DE VÁLVULAS
11 JTA. CÁRTER
12 JTA. DISTRIBUCIÓN
13 JTA. CONTRATAPA DISTRIBUCIÓN
14 JTA. BOMBA DE AGUA
15 JTA. MÚLTIPLE ESCAPE
16 JTA. MÚLTIPLE ESCAPE
17 JTA. MÚLTIPLE ADMISIÓN
18 JTA. SALIDA DE ESCAPE
19 JTA. PLACA DE AGUA
20 JGO. JUNTA CARBURADOR
21 JGO. JUNTA CARBURADOR
22 JGO. JUNTA CARBURADOR
23 JGO. JUNTA CARBURADOR
24 JGO. JUNTA CARBURADOR
25 JTA. BASE CARBURADOR
26 JTA. TAPA CARBURADOR
27 JTA. BOMBA ACEITE A BLOCK
28 JTA. BOMBA DE NAFTA
29 ARANDELA TAPÓN CÁRTER
30 ARANDELA TAPA DE VÁLVULAS
36 JTA. TAPA VÁLVULAS LATERAL
50 JGO. CAJA DE VELOCIDADES
57 JUNTA PALIER
58 JGO. BANCADA CIGÜEÑAL
59 JTA. DIFERENCIAL
60 JTA CÁRTER CGT
70 JGO. SUPLEMENTO CAMISAS
85 SUPLEMENTO DE TAPA
95 JGO. DE JUNTAS SUPERIOR
97 JGO. DE JUNTAS SUPERIOR JTC 07
96 JGO. SUPERIOR SIN JTC

FORMACIÓN DE CÓDIGOS DE RETENES

SEGUNDO Y TERCER DÍGITO

INDICA LA MARCA O LINEA DEL ARTÍCULO

PRIMER DÍGITO

R

INDICA LINEA DE RETENES

PR

INDICA LINEA DE PORTA RETENES

14 AUTO UNION	35 MERC. BENZ
15 CITROEN	36 MERC. BENZ
20 CHEVROLET	40 PERKINS - MF
21 CHEVROLET	41 PERKINS - MF
22 DODGE - VW	42 PERKINS
23 VW - FORD	45 PEUGEOT
24 CHEVROLET	INDENOR
25 FIAT	46 PEUGEOT
26 FIAT	50 RASTROJERO
27 FIAT	INDENOR
28 CHEVROLET	54 IKA - RENAULT
30 FORD - VW	JEEP WILLYS
31 FORD - MWM	55 RENAULT
32 FORD	58 RENAULT

CUARTO Y QUINTO DÍGITO

INDICA EL TIPO DE MOTOR

EJEMPLOS

CITROËN	FIAT
00 2CV 14HP	05 128 1300cc.
01 2CV 18HP	06 128 1500cc.
02 3CV	07 125
04 AMI 8	08 133
	09 REGATTA 100S
	11 DUCATO 2.8
	20 BRAVO/A TD
	21 BRAVO/A JTD
FIAT	
00 1100	
01 600	
02 1500	
03 1600	
04 128 1100cc.	

SEXTO Y SÉPTIMO DÍGITO

INDICA TIPO DE RETÉN SEGÚN SU APLICACIÓN

00 KIT DE RETENES	56 RUEDA TRAS. INT.
10 GUÍAS DE VÁLVULAS	57 DE PIÑÓN
11 BANCADA	58 RUEDA DEL. EXT.
12 DISTRIBUCIÓN	59 RUEDA DEL. INT.
13 ÁRBOL DE LEVAS	60 SEMI-EJE
15 RET. ADICIONAL	
47 VELOCÍMETRO	
48 SELECTOR CAJA DE VELOCIDAD	
49 EJE CAMBIO	
50 SALIDA DA CAJA	
51 DE DIRECTA	
52 SALIDA DE PALIER	
55 RUEDA TRAS. EXT.	

OCTAVO DÍGITO

INDICA MATERIAL

N - NITRIL
CAUCHO NITRILICO
S - SILICONA
CAUCHO DE SILICONA
P - POLIACRÍLICO
CAUCHO DE POLIACRÍLICO
V - VITÓN
CAUCHO FLUORADO
VF - VIFLON
T - TEFLÓN
POLITETRA FLUOR ETILENO

SIMBOLOS - MATERIALES

SYMBOLS - MATERIALS

SIMBOLOS - SYMBOLS

Descripción de Producto Product description	Simbolos Symbols	Descripción de Producto Product description	Simbolos Symbols	Descripción de Producto Product description	Simbolos Symbols
Jgo. de juntas para motor con retenes Full set gaskets with oil seals		Jgo. tornillos para tapa de cilindros Cylinder head bolts		Suplemento camisa cilindro Camma cylinder gaskets	
Jgo. de juntas para motor sin retenes Head set gaskets without seals		Herramientas especiales para motor Set of special automotive tools		Kit retenes completo Oil Seals (Set)	
Jgo. juntas p/motor sin tapa con retenes Full set gaskets without head with oil seals		Junta tapa de válvulas Valve gaskets		Jgo. retén válvulas Valve seal set	
Jgo. juntas p/motor sin tapa sin retenes Full set gaskets without head without oil seals		Junta para cárter Rear main bearing seals gaskets		Retén bancada Rear crankshft seal	
Jgo. de juntas superior con retenes Head set gaskets with oil seals		Junta tapa distribución Timing cover gaskets		Retén distribución Front crankshft seal	
Jgo. de juntas superior sin retenes Head set gaskets without seals		Junta bomba de agua Water pump and water exit gaskets		Retén árbol de levas Camshaft seal	
Junta tapa cilindro Cylinder head gaskets		Junta múltiple admisión y escape Intake and exhaust manifolds gaskets		Porta retén bancada Rear crankshft seal	
Junta tapa cilindro - No retorqueable Cylinder head gaskets - Non retorqueable		Junta múltiple admisión Intake manifolds gaskets		Porta retén distribución Front crankshft seal	
Junta tapa cilindro izquierda Left Cylinder head gaskets		Junta múltiple escape Exhaust manifolds gaskets		Espesor Thickness	
Junta tapa cilindro derecha Right Cylinder head gaskets		Junta salida escape Exhaust pipe seals gaskets			

ABREVIATURAS MATERIALES - ABBREVIATION OF MATERIALS

	Descripcion Description		Descripcion Description		Descripcion Description
AC	Acero Inoxidable Stainless Steel	CEL	Celulosa Cellulose	NH	Libre Amianto Comprimido Compressed Asbestos Free
ACO	Acero Cobreado - Libre Amianto - Acero Cobreado Steel Copper - Asbestos Free - Steel Copper	F	Fibra Fiber	MLS	Multilamina Sterling Multisheet Sterling
AL	Aluminio Aluminium	FCH	Ferroflex con respaldo de chapa Ferreflex with tin shoulder	P	Poliacrilico - Retenes con casco de acero Polyacrylic - Oil Seals with steel cap
BAK	Bakelita - Nonasbesto/Bakelita Bakelite - Nonasbesto/Bakelite	FIE	Fieltro Felt	PB	Plomo Lead
CB	Base Celulosa Cellulose Base	GFT	Grafito con alma metálica Graphite with metallic core	PLAST	Plástico Plastic
CG	Corcho y Goma Cork and Rubber	GS	Goma sintética - Nitrilo Synthetic Rubber - Nitrile	S	Silicona - Retenes con casco de acero Silicone - Oil Seals with steel cap
CGT	Corcho y Goma con Tela Cork and Rubber with Cloth	H	Hojalata Tin Plate	SLS	Sterling - Polystrat Sterling - Polystrat
CHA	Chapa/Hojalata sin material blando Tin Plate without soft material	L	Latón - Bronce Brass	SNA	Soga libre de amianto Rope asbestos free
CN	Arandelas blindadas (Cobre - Libre Amianto) Armored washers (Copper - Asbestos Free)	N	Retenes de nitrilo con casco de acero Nitrile oil seals with steel cap	T	Teflón Teflon
CNC	Cobre - Libre Amianto - Cobre Copper - Asbestos Free - Copper	NB	Libre Amianto (Beater) Asbestos Free (Beater)	V	Vitón - Retenes con casco de acero Viton - Oil Seals with steel cap
CU	Cobre Copper	NFT	Ferreflex Base Libre Amianto Ferreflex Base Asbestos Free	VS	Varios Miscellaneous

Los números originales también indicados en este catálogo tienen relación únicamente en sentido de informar y verificar. Sírvase usar en sus pedidos, facturas recibos solamente los códigos TARANTO.

Os números originais indicados neste catálogo servem somente para informação e verificação. Utilizar nos pedidos, faturas e recibos somente os códigos TARANTO.

Original part numbers also indicated in this catalog are intended only to inform and verify. Please, indicate only TARANTO reference numbers in your order forms, invoices and shipping notes.

ARANDELAS - ANILLOS - O´RINGS

WASHERS - RINGS - O´RINGS

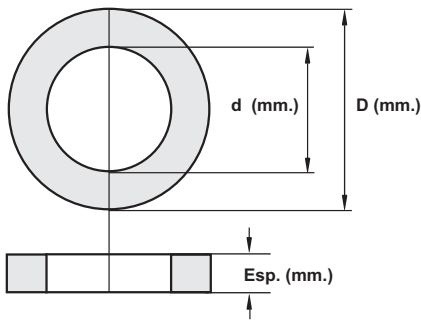

d	Diámetro interior d (mm)	Diámetro interno d (mm)	Inner diameter d (mm)
D	Diámetro exterior D (mm)	Diámetro externo D (mm)	Outer diameter D (mm)
Esp.	Espesor Esp.(mm)	Espessura Esp.(mm)	Thickness Esp.(mm)

FORMACIÓN DE CÓDIGOS DE ARANDELAS

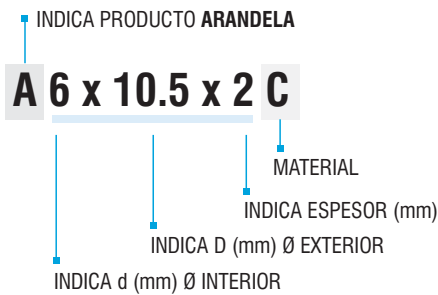

MATERIALES			
AL	ALUMINIO	ALUMÍNIO	ALUMINUM
NH	LIBRE AMIANTO COMPRIMIDO	SEM AMIANTO COMPRIMIDO	ASBESTOS FREE COMPRESSED
C	COBRE	COBRE	COPPER
F	FIBRA	FIBRA	FIBEIRON
H	FERRO	HIERRO	FELT
F	FELTRO	FIELTRO	NYLON
N	NYLON	NYLON	

ARANDELAS POR DIÁMETRO INTERIOR

				MATERIAL											MATERIAL											MATERIAL													
d (mm)	D (mm)	Esp		AL	NH	C	F	H	L	d (mm)	D (mm)	Esp		AL	NH	C	F	H	L	d (mm)	D (mm)	Esp		AL	NH	C	F	H	L	d (mm)	D (mm)	Esp		AL	NH	C	F	H	L
4	7	1								7	17	1.5									10	13	1								12	17	1.5						
4	8	1								7	17	1									10	14	1.25								12	17	2						
5	8	1								8.3	11.6	1									10	14	1.5								12	18	1.5						
6.5	12	0.5								8.5	11.5	1									10	14	1								12	18	1						
6.8	13.5	1								8.5	12	1									10	15	1.5								12	18	2						
6	10.5	2								8	10	1									10	15	1								12	18	3						
6	10	1.5								8	11	1									10	16	0.5								13	16	0.5						
6	10	1								8	12	1									10	16	1								13	16	2						
6	10	2								8	12	1									10	16	2.5								13	17	1						
6	11	2								8	13	1									10	18	1								13	17	2						
6	8	0.5								8	13	2.5									10	18	2								13	18	1.5						
6	8	1								8	14	0.5									10	19	2								13	19	1						
6	9	0.5								8	14	1.5									10	20	1.5								13	20	1						
6	9	1								8	14	1									10	20	1								13	20	2						
6.5	10	1								8	18	1.5									10	20	2								13	21	1.5						
6.5	12	1								8	20	1.5									10	21	2								13	24	3						
7.5	15	2								9.4	18	1									11	15	1								14.5	21	2						
7	8.9	1.9								9.5	12	1.5									11	16	1								14	17.2	2						
7	10	1								9.5	12	1									11	17	1.25								14	18	1.25						
7	11	1								9.5	14.5	1									11	18	1.5								14	18	1.5						
7	12.5	1								9.5	20	1									11	18	2								14	18	1						
7	12.5	2								9.5	20	2									12.7	16	1								14	18	1.25						
7	13	1.5								9.7	13	1									12.8	22.8	2								14	19	1.5						
7	13	1								9	11	0.8									12	14	0.5								14	20	1.25						
7	13	4								9	13	0.5									12	15	1.5								14	20	1.5						
7	14	1								9	13	1									12	15.2	1								14	20	1						
7	15	1								9	13	1									12	16	1.5								14	20	2						
7	15	1.5								9	14	1									12	16	1								14	21	1.5						
7	15	2								9	17	1.5									12	17	1								14	22	1.5						

ARANDELAS - ANILLOS - O´RINGS

WASHERS - RINGS - O´RINGS

MATERIAL								MATERIAL								MATERIAL								MATERIAL											
d (mm)	D (mm)	Esp	AL	NH	C	F	H	L	d (mm)	D (mm)	Esp	AL	NH	C	F	H	L	d (mm)	D (mm)	Esp	AL	NH	C	F	H	L	d (mm)	D (mm)	Esp	AL	NH	C	F	H	L
14	22	2			●				16	24	1			●				20	26	0.5			●				24	38	1.25	●					
14	24	1.5	●						16	24	1.5	●						20	26	1.5			●				25	29.5	1			●			
14	24	2			●				17	21	0.5			●				20	26	1	●		●				25	29	2			●			
14.7	21	2			●				17	21	1.25			●				20	26	2				●			26	31	2			●			
15.5	17	1.5			●				17	21	1.5			●				20	28	1	●		●				26	32	1.25	●					
15	18	1	●						17	22	1.25	●						21	30	2	●		●				26	32	2	●					
15	19	1.5	●						17	22	1.5			●				22.5	29	2	●		●				26	34	2	●					
15	20	1			●				17	22	1	●			●			22	26	1.5			●				27	32	1.5			●			
15	21	1.5	●						18	22	1.5	●		●				22	27	1	●		●				28	34	1.5	●					
15	21	1.5			●				18	22	2			●				22	27	1.25	●		●				28	36	0.5	●					
15	21	2	●		●				18	23	1.25	●		●				22	27	1.5			●				28	38	1.5			●			
16	19	1.5			●				18	23	1	●		●				22	27	1			●				30	36	2	●		●			
16	20	1	●			●			18	23	2			●				22	28	1.25	●		●				31	36	1.5	●					
16	20	1.5			●				18	24	1			●				22	28	1.5			●				32	36	0.5			●			
16	21	1.25	●						18	24	1.5			●				22	29	1.5	●		●				32	36	1			●			
16	21	1.5			●				19	24	1.5	●						22	29	3	●		●				35	41	2			●			
16	21	1	●						19	26	1.5			●				22	32	1.5			●				36	42	1.5	●					
16	21	2			●				19	27	2	●						24	29	2			●				40	47	1			●			
16	22	1.5	●		●				19.5	27	1	●						24	30	1.5	●		●				40	60	1.5			●			
16	22	1			●	●			20.5	5.5	1	●						24	32	1.5	●		●				45	52	2	●					
16	22	2			●				20	24	1.5	●		●				24	32	2	●		●												

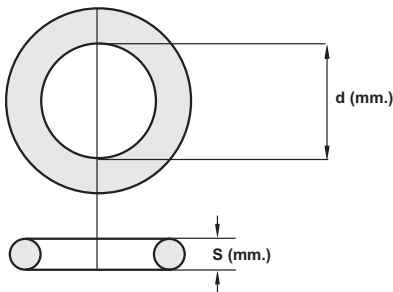

d Diámetro interior d (mm)
S Sección S (mm)

Diâmetro interno d (mm)
 Seção S (mm)

Inner diameter d (mm)
 Section S (mm)

FORMACIÓN DE CÓDIGOS DE ARANDELAS

INDICA PRODUCTO O´RING

G 18.77 x 1.78 S MATERIAL

INDICA S (mm) SECCION

INDICA d (mm) Ø INTERIOR

MATERIALES

N	NITRILICO	NITRILICA	NITRILE
S	SILICONA	SILICONE	SILICONE
V	VITÓN	FLUOR ELASTOMERO	FLUORELASTOMERS

O´RING - SERIE STANDARD

1.78
S (mm)

MATERIAL				MATERIAL				MATERIAL				MATERIAL				MATERIAL				MATERIAL			
d (mm)	N	S	V	d (mm)	N	S	V	d (mm)	N	S	V	d (mm)	N	S	V	d (mm)	N	S	V	d (mm)	N	S	V
1.42	●			4.47	●			12.42	●			23.52	●			50.52	●			66.4	●		
1.78	●			5.28	●			15.6	●		●	28.3	●			53.7	●			69.57	●		
2.57	●			6.07	●			17.17	●			34.65	●			56.87	●		●	101.32	●		
2.9	●			7.65	●			18.77	●	●		44.17	●			60.05	●						
3.68	●			9.25				21.95	●			47.35	●			63.22	●						

2.62
S (mm)

7.59	●			13.11	●			17.12	●			23.47	●			30	●			37.77	●		
9.19	●			13.94	●			18.72	●			26.64	●			31.42	●			39.34	●		
9.5	●			15.54	●			20.30	●			28.24	●			32.99	●			40.94	●		
12.37	●			17.12	●	●		21.89	●			29.82	●			36.17	●		●	34.59	●		

ARANDELAS - ANILLOS - O´RINGS

WASHERS - RINGS - O´RINGS

O´RING - SERIE STANDARD

	MATERIAL				MATERIAL				MATERIAL				MATERIAL				MATERIAL							
	d (mm)	N	S	V	d (mm)	N	S	V	d (mm)	N	S	V	d (mm)	N	S	V	d (mm)	N	S	V				
2.62 S (mm)	44.12	●			53.64	●			58.42	●			66.34	●			72.69	●			90	●		
	48.9	●			55.25	●			61.60	●			67.95	●			82.22	●			126.67	●		
	52.07	●			56.82	●			64.77	●			69.52	●			88.57	●			158.42	●		
3.53 S (mm)	4.34	●			21.82	●			31.34	●			40.87	●			50.39	●			98.02	●		
	12.29	●			23.39	●			32.92	●			44.04	●			63.09	●			107.54	●		
	13.87	●			26.57	●			36.09	●			45.36	●			66.27	●			110.72	●		
	18.64	●			27.5	●			37.69	●			47.22	●	●		72.62	●			129.77	●		
5.33	37.47	●			46.99	●	●		88.27	●			94.62	●										
	40.64	●			62.87	●			91.44	●			253.37	●										

O´RING - SERIE NO STANDARD

		MAT.				MAT.				MAT.				MAT.				MAT.									
d (mm)	S (mm)	N	S	d (mm)	S (mm)	N	S	d (mm)	S (mm)	N	S	d (mm)	S (mm)	N	S	d (mm)	S (mm)	N	S	d (mm)	S (mm)	N	S				
2.7	1.2	●		12	3		●	20	4	●		30.5	3.5	●		42	4	●		58	2	●		85	3	●	
4	1	●		12.5	1.5	●		21	1.5	●		31.55	3.72		●	42.2	3	●		60	4	●		85.5	3.35	●	
4	1.5	●		13.1	1.3	●		21	3	●		31.5	3.2	●		43	4		●	60	5	●		90	3	●	
4.47	1.42	●		13.5	3	●		22.1	3.6	●		32	3	●		44	2	●		61.8	3	●		91	1.8	●	
4.5	1	●		14	2	●		22.2	3.5	●		33.5	4.2	●		44	3	●		62	3.5	●		94	3	●	
5.98	1.99	●		14	2.5		●	22.5	2.5	●		34	3	●	●	45	2.5	●		63	3	●		101	4	●	
6	2	●		14	3	●	●	22.5	3	●		34.2	2.5	●		45	3	●		63.5	3		●	102.5	94.5	●	
6.07	1.63	●		16	2	●		23	3	●		35	3.5	●		45	4	●		64	3	●		110	3	●	
7	4.5	●		16	2.5	●		25	4	●		35	4		●	46	3	●		65	2.35		●	110	4.5	●	
7.3	2.4	●		16	4		●	26.2	3	●		36	3	●		46.2	1.9	●		70	3	●		112	4	●	
8	1.5	●		16.5	3		●	28	2	●		36.5	3.2	●		46.3	3	●		74	3	●		114.5	5	●	
8	2.4	●		17	2.2	●		28	4		●	37	3	●		47	4	●		74	3.35	●		115	2		●
9	2	●		17.5	6	●		28.12	3.5	●		37.47	3	●		47.3	2	●		75	3	●		119	3	●	
9.7	4	●		18	3	●		28.2	2.5	●		38	3	●		48	4	●		76	2.5	●		122	5	●	
10	2.5	●		19.18	2.46	●		28.2	5	●		39	3	●	●	50	4	●		79	1.8	●	●	152	6	●	
10	2.5		●	19.25	2.9	●		29.2	3	●		40	3	●		53.5	3	●		79.5	3		●	168	3.5	●	
11	2.5		●	20	2	●		30	3.5	●		40	5	●		55	2	●		80	3	●		212.15	3	●	
12	2.5	●		20	2.5	●		30.2	3	●		42	3	●		56.4	2	●		82	3.5	●		320	8	●	

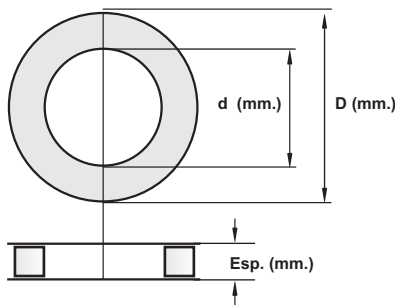

d	Diámetro interior d (mm)	Diámetro interno d (mm)	Inner diameter d (mm)
D	Diámetro exterior D (mm)	Diámetro externo D (mm)	Outer diameter D (mm)
S	Sección S (mm)	Corte S (mm)	Section S (mm)

ANILLOS

d (mm)	S (mm)	D (mm)	Mat.	d (mm)	S (mm)	D (mm)	Mat.	d (mm)	S (mm)	D (mm)	Mat.	d (mm)	S (mm)	D (mm)	Mat.	d (mm)	S (mm)	D (mm)	Mat.	d (mm)	S (mm)	D (mm)	Mat.
6	3	3	N	10	6	1	N	15	11	3	N	33	22	8	N	46	34	2	N	73	65	5	N
8	4	1	N	15	6	1	N	14,5	11,5	4	N	30	24	3,9	N	46,5	38,5	4	N	82	73	9,7	N
13,8	5	7,8	N	13,8	6,4	8	N	30	15,5	12	N	21	35	13	N	56,5	66,5	6	N	91	82,2	4,7	N
9	5	9,5	N	7,2	11	6	N	24	17	9	N	47,5	41,5	7	N	57	42	3	N	104,2	95	3	N



taranto

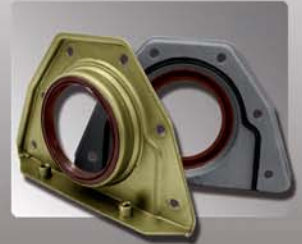

Retenes Taranto. Un sello de garantía

El permanente desafío que presenta la evolución de los motores de combustión actuales para asegurar el sellado de sus componentes requiere del desarrollo y aplicación de tecnología moderna y eficiente en la fabricación de los retenes. La constante actividad de nuestro Departamento de Ingeniería, aplicada al desarrollo e investigación de nuevos materiales y componentes para lograr la mejor performance de nuestros productos, acompañada de la realización de ensayos de vida y exigentes pruebas específicas que garantizan el perfecto desempeño en los distintos medios funcionales y la utilización de modernas técnicas de diseño aplicada a la construcción de nuevos labios y perfiles hidrodinámicos, permite ofrecer al mercado productos que superan las necesidades de estanqueidad del motor.



1 - NUEVOS PERFILES

Facilita el montaje y asegura el agarre.

2 - POSICION PREFERENCIAL DEL LABIO

Permite trabajar el labio en posiciones no utilizadas del eje.

3 - MODERNOS DISEÑOS

Permite trabajar el labio en una parte del eje no utilizable hasta el momento.







RETENES - MATERIALES

OIL SEALS - MATERIALS

MATERIALES MATERIAIS - MATERIALS	ASTM D1418	ISO 1629	TARANTO	TEMPERATURA Temperature
SILICONA Material para aplicaciones de baja y alta temperatura, muy usado en motores de elevada exigencia y en transmisiones automáticas. No recomendada para aceites EP (Extrema Presión). SILICONE Material para aplicação em baixas e altas temperaturas, muito usado em motores de elevada exigência. Não é recomendada para óleos EP (Extrema Pressão). SILICONE Material for low and high temperature applications, highly recommended for engines and automatic transmission. It should not be used for EP oils (Extreme Pressure).	VMQ	MVQ	S	-50° Ca + 180°C
NITRÍLO Es el material más comúnmente utilizado en sellado para aplicaciones generales. Buena resistencia a la abrasión y a la acción de aceites y grasas minerales. NITRILICA É o material mais comumente utilizado em vedação para aplicações gerais. Tem boa resistência ao atrito e a ação de óleos e graxas minerais. NITRILE It is the most commonly used sealing material for general applications. Good resistance to abrasion and to mineral oils and greases.	NBR	NBR	N	-35° Ca + 110°C
POLIACRÍLICO Recomendado para aplicaciones en motor y especialmente en transmisión con aceites EP. Deformación permanente más elevada. POLIACRÍLICO Recomendado para aplicações em motores e especialmente em transmissões com óleo EP. Deformação permanente mais elevada. ACRYLIC (POLYACRYLATE) Highly recommended for engines and especially in transmission with EP oils. Higher permanent set.	ACM	ACM	P	-30° Ca + 150°C
FLUORELASTOMERO Compuesto para altas exigencias con mejor resistencia a altas temperaturas y ataques químicos. Ofrece duración en servicio muy superior, pero a costo más elevado. FLUORELASTOMERO Composto para altas exigências com melhor resistência a altas temperaturas e ataques químicos. Oferece duração em serviço muito superior, porém a um custo mais elevado. FLUORELASTOMERS Compound for high demands with better resistance to high temperatures and chemical aggressions. It grants a better duration in service but at higher costs.	FKM	FKM	V	-30° Ca + 200°C
POLITETRAFLUORETILENO Usos de elevada temperatura, gran ataque químico y severas condiciones de fricción. POLITETRAFLUORETILENO Utilizado em ambientes com altas temperaturas e elevado ataque químico, e em condições severas de atrito. POLYTETRAFLUORETHYLENE High temperature uses, great chemical attack and severe friction conditions.	PTFE	PTFE	T	-80° Ca + 250°C
FLUORELASTOMERO / POLITETRAFLUORETILEO Compuesto especial desarrollado por Taranto (Viflón®) para altas exigencias de temperatura, ataque químico e importantes condiciones de fricción. Es la elección ideal entre el tipo V y el tipo T. FLUOROELASTOMER / POLITETRAFLUORETILENO Composto especial desenvolvido pela Taranto (Viflón®) para os requisitos de alta temperatura, gravura e importantes condições por atrito. É a escolha ideal entre o tipo V e T-type FLUOROELASTOMER / POLYTETRAFLUOROETHYLENE Special compound developed by Taranto (Viflón®) or high temperature requirements, chemical attack and important conditions of friction. Is the ideal choice between the V type and T-type	FKM PTFE	FKM PTFE	VF	-30° Ca + 200°C

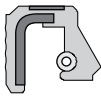
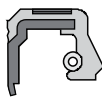
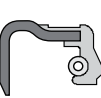
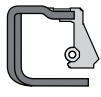
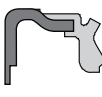
DESCRIPCIÓN - TIPO DE RETENES RADIALES

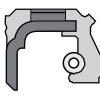
DESCRIÇÃO - TIPO DE RETENES RADIALES | TYPES OIL SEAL - DESCRIPTION

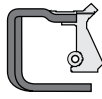
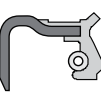
GA	Goma armada Exterior borracha Rubber case	G1A	Exterior goma metal Exterior metal borracha Outer rubber metal	G1	Exterior metal Exterior metlico Outer metal			
G2	Blindado Blindado Armoured	RI	Roscado izquierdo Rosca esquerda Left threaded	RD	Roscado derecho Rosca direita Right threaded			
SR	Sin resorte Sem mola Without sprint	LG	Labio guardapolvo Lábio guarda-pó Dust lip	HD	Hélice derecha Hélice direita Right helix			
HI	Hélice izquierda Hélice esquerda Left helix	ESP	Especial Especial Special	BI	Bidireccional Bidireccional Bi-directional			

RETENES RADIALES

OIL SEALS

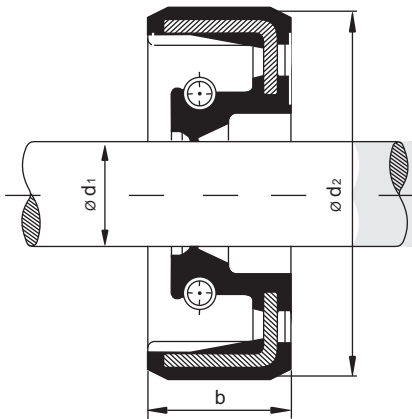

- Diámetro de Eje (d1)
- Altura (b)
- Alojamiento (d2)

- Diâmetro do eixo (d1)
- Altura (b)
- Alojamento (d2)

- Shaft diameter (d1)
- Height housing (b)
- Housing Bore (d2)

RETENES POR Ø DE EJE - RETENTORES POR DIÂMETRO DO EIXO - DIAMETER HOLDERS OIL SEAL

REF	DE [mm]	DA [mm]	H [mm]	TIPO Type	MATERIAL						
					N	S	P	V	T	VF	
R300347	7.90	16.00	6	GA	●						
R550614	8.10	14.30	4.2	U'RING				●			
R550447	8.40	16.00	6.5	GA	●						
R460215	9.50	16.00	4	GALGSR	●						
R550515	12.70	25.40	6.5	GAHI			●				
R223543	13.00	21.90	5/6.5	ESP-GADUO						●	
R240048	13.00	26.00	7	GALG	●						
R550051	13.00	26.00	9	GALG	●						
R250148	14.00	24.00	7	ESP	●						
R550451	15.00	26.00	7	GALG	●						
R300748	15.50	28.00	6/15	ESP	●						
R300048	15.70	23.81	4.76	GASR	●						
R550648	16.00	22.80	4.8	GA	●						
R250448	16.00	24.60	9/20	ESP	●						
R450348	17.00	23.00	7	ESP	●						
R300749	17.00	28.00	7/10	GALGHD	●						
R550450	17.00	28.00	7/13	GAHD	●						
R280215	17.50	32.00	6	GALGHD	●		●	●			
R220649	20.00	35.00	7/10.5	GAHD			●				
R240949	21.00	32.00	7.5	G1LGHD	●						
R300751	21.50	40.00	7	GAHD			●				
R250652	22.00	35.00	8	GALG	●						
R250451	22.00	40.00	7/8.5	G2LGHD	●						
R560114	22.00	45.00	7	GALGHI			●	●			
R220349	22.10	40.00	12/17	GALGHD	●						
R400213	22.22	34.92	6.35	GA	●						
R400215	22.22	35.70	9.52	ESP-RD	●						
R260251	22.80	40.00	7/8.5	G2LGHD			●				
R250457	23.00	37.00	13.5	ESP			●				
R550550	24.00	36.00	8/12	GAHD	●						
R250156	25.00	35.00	7	GA	●						
R280415	25.00	40.00	8	GALG-BI	●						
R560113	25.00	42.00	7	GALGHD			●	●			

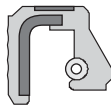

GA



GALG



G1A



G1ALG



G1



G1LG



G2



G2LG



G1SRLG





GALGR/D

c/f Con Feltro
Con feltrol/With Felt

REF	DE [mm]	DA [mm]	H [mm]	TIPO Type	MATERIAL						
					N	S	P	V	T	VF	
R240415	26.00	42.00	8	G1ALGHD			●	●			
R550660	26.00	42.00	8/17	EGALG	●						
R350315	26.00	45.00	10	G1	●						
R902115	26.00	49.00	9.5/11	ESP			●				
R270515	27.00	37.00	7	G1ALGHD				●			
R860012	27.00	39.50	7	GALGHD			●				
R231313	27.00	42.00	8	G1ALGHD				●			
R470813	27.00	47.00	7	GALGHD					●		
R550951	27.95	56.00	10	GALGHD			●				
R570351	27.95	70.00	10	GALGHD			●				
R320013	28.00	38.00	7	GALGHD			●	●			
R300351	28.00	40.00	8	GALGHD	●						
R570913	28.00	42.00	5	GALGHD				●			
R222313	28.00	42.00	7	GALGHI					●		
R450557	28.00	45.00	8	GAHD			●				
R580013	28.00	47.00	5.5	GALGHD					●		
R250151	28.00	47.00	8	GAHD	●						
R510012	28.50	41.25	6	GALGHD			●				
R300051	28.58	41.20	6.2	G1HD	●						
R250660-1	29.80	50.00	10/13.5	G1ALGHD			●				
R250660	29.80	52.00	10/13.5	G1ALGHI			●				
R200849	29.90	45.00	7	G1HD			●				
R460760	29.90	47.00	11.3	GALGRD c/f			●				
R550615	30.00	40.00	7	GAHD	●		●	●			
R860013	30.00	40.00	7	GA-B		●	●				
R260113	30.00	42.00	7	GALGHD			●	●			
R550413	30.00	42.00	8	GAHI	●		●				
R150012	30.00	42.04	8	GALGHD	●						
R260112	30.00	43.00	8	G1ALGHD			●	●			
R900913	30.00	44.00	7	GALGHD			●				
R270614	30.00	44.00	8	GALGHI					●		
R240713	30.00	45.00	8	GALGHD	●		●				
R250255	30.00	45.00	8	GA	●						

RETENES RADIALES OIL SEALS

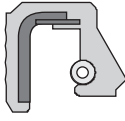
RETENES POR Ø DE EJE - RETENTORES POR DIÂMETRO DO EIXO - DIAMETER HOLDERS OIL SEAL

REF 	DE [mm]	DA [mm]	H [mm]	TIPO Type	MATERIAL							REF 	DE [mm]	DA [mm]	H [mm]	TIPO Type	MATERIAL								
					N	S	P	V	T	VF							N	S	P	V	T	VF			
R242512	54.00	82.00	11.45	-				•				R330312	66.67	85.70	10	GALGRD									
R270612	55.00	68.00	8	GALGHD								R320012	66.67	89.30	10	GALGRD			•	•					
R241515	55.00	70.00	8	GALGHI								R330212	66.70	88.80	11/12.5	G1ALGHD			•						
R270115	55.00	70.00	10	GALGHD								R350957	68.00	85.00	10	GALGHD			•						
R300759	55.00	70.00	6/10	ESP	•							R360057	68.00	85.00	10	GALG	•								
R700612	55.00	72.00	10	GALGHD	•							R581813	70.00	85.00	7	GALGRD								•	
R810151	55.00	75.00	9	G1LGHD								R260011	70.00	85.00	8	G1ALGHI			•						
R510512	55.00	81.00	15.8	G1LGHD				•	•			R570511	70.00	86.00	8	GALGHI								•	
PR231411	55.00	-	-	PORTA								R971511	70.00	88.00	11	-								•	
R150211	55.95	69.1	10	GAHI	•							R220311	70.00	90.00	10	GAHI								•	
R500412	56.00	80.00	10	GAHD								R270112	70.00	90.00	10	GALGHD								•	•
R430012	57.00	71.00	9	GALGRD								R550411	70.00	90.00	10	GALGHI	•							•	
R950511	57.00	77.00	10	GALGHI		•	•					R800012	70.00	90.00	15	G1LGHD								•	
R850012	57.15	76.20	9.5	GALGHD	•			•				PR270112	70.00	-	-	PORTA								•	
R850512	57.15	76.20	9.5	GALGHD								R800812	70.00	100.00	12.5/16	-									•
R220013	57.15	80.98	11.5	GALGRD								R950311	72.00	96.00	9	GALGRI								•	
R420112	57.30	76.20	12.7	GALGHD	•							R270511	74.00	88.00	8	G1ALGRI								•	
R430015	57.50	74.00	8	GASRLG	•							R260111	74.00	90.00	10	G1ALGRI								•	•
R950011	58.00	74.00	9.5	GALGHI								PR270511	74.00	-	-	PORTA								•	
R310458	58.95	76.00	9	G1SRLG	•							PR270711	74.00	-	-	PORTA								•	
R550655	60.00	70.00	9.1	ESP	•							PR271911	74.00	-	-	PORTA									•
R500211-1	60.00	75.00	5	EXPAN		•						R870212	75.00	93.00	9/10	G1ALGRD								•	•
R581812	60.00	75.00	7	GALGRD								R350858	75.00	95.00	13	GALG	•								
R990011	60.00	75.00	8	GALGHI								R350612	75.00	100.00	12	G1LGHDI								•	
R950711	60.00	78.00	10	GALGHI								R970011	75.00	100.00	13	GALGRI							•	•	
R940011	60.00	80.00	8	GALGHI								R700212	75.00	100.00	17	GALGHD	•								
R330012	60.30	82.50	11	G1HD								R200811	75.90	95.00	11.3	GALGH								•	
R400012	60.32	79.36	9.5	GALGHD	•							R241911	76.00	92.00	10	GALGRI								•	
R320111	60.45	76.18	10	GALGHI								R220111	76.20	95.22	9.32	GARI	•							•	
R260950	63.00	69.50	11	ESP								R510411	76.20	95.25	9.5	GALGHD								•	
R870012	63.50	79.50	9	G1ALGRD								R271511	78.00	100.00	9	GALGSRRI								•	•
R200011	64.00	78.00	12	2 PARTES								R460511	78.00	100.00	10	G1ALGHI								•	
R200011-1	64.00	78.00	12	2 PARTES								R310412	78.00	100.00	13	GALGHD								•	•
R200011-2	64.00	78.00	12	EXPAN								R351012	78.00	104.00	11	GASRRD c/f								•	
R450411-1	64.00	80.00	5	EXPAN								R926611	78.00	105.0	7.5	-								•	
R250111	64.00	80.00	8	G1ALGHI	•	•	•	•				R860011	79.00	126.00	1.25	ESPHI								•	
R250811	64.00	80.00	8	G1ALGHD	•							PR320011	79.00	-	16	PORTA								•	
R700112	64.00	85.00	12	GAHD	•							PR291011	79.00	-	-	PORTA								•	
R470012	64.00	88.00	6	GALGHD								R330311	79.30	99.00	9.8	GALGHI								•	
PR260911	64.00	81.50	8	PORTA								R340111	79.30	93.00	9	-								•	
R922313	65.00	79.00	7	-								PR340111	79.30	-	-	PORTA								•	•
R650112	65.00	85.00	13	G1ALGHD								R300611	79.38	95.25	11.11	GAHI								•	•
R350212	65.00	90.00	15	G1LGHD	•							R520811	80.00	96.00	9	GALGRI								•	

c/f Con Fieltro
Con feltro/With Felt

RETENES RADIALES

OIL SEALS

RETENES POR Ø DE EJE - RETENORES POR DIÂMETRO DO EIXO - DIAMETER HOLDERS OIL SEAL

REF		DE [mm]	DA [mm]	H [mm]	TIPO Type	MATERIAL					
						N	S	P	V	T	VF
R350255		110.00	140.00	13	G2LG	●					
R650212		110.00	140.00	16	GALGHD		●				
R200311		112.50	130.00	11	G1ALGRI			●			
R360811		113.00	140.00	12	GALGRI				●		
R800311		114.00	135.00	13	G1ALGRI					●	
PR270111		114.00	-	-	PORTA					●	
PR291611		115.00			PORTA					●	
R351011		115.00	140.00	13	G1ASRR1 c/f			●			
R650111		115.00	140.00	16	G1ALGHI			●			
R210011		118.00	143.00	13	GARI	●					
R360011		120.00	140.00	13	G1ALGRI				●		
R350455		120.00	145.00	15	G2LG	●					
R850011		120.65	146.07	12.7	GALGRI c/pista			●			
R330011		122.20	140.80	12	GALGHI				●		
R350955		125.00	150.00	15	G2LG-BI	●					
R870011		130.00	150.00	12/13	GALGRI				●		●
R800811		130.00	155.00	12.5/16						●	
R330411		130.00	160.00	12	G1ALGRI					●	
R810111		130.00	160.00	15	GALGRI					●	
R400211		133.35	158.75	11/13	GALGRI			●	●		
R800511		140.00	165.00	13	G1ALGRI			●			
R650411		150.00	172.00	18.3	GAHI			●			
R800055		180.00	200.00	12	G1ALG	●					
R510511					2 MITADES			●			

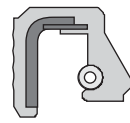

GA



GALG



G1A

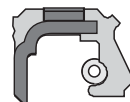

G1ALG

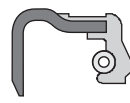

G1

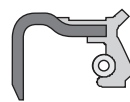

G1LG



G2

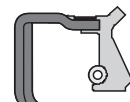

G1ALGH

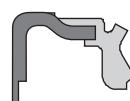

G1SRLG



GALGRI/D

c/f Con Feltro
Con feltro/With Felt

REF		DE [mm]	DA [mm]	H [mm]	TIPO Type	MATERIAL					
						N	S	P	V	T	VF
R310256		38.10	63.55	12.7	GA	●					
R220455		40.00	52.00	7.5	GALG	●					
R240455		40.00	52.00	8.5	E-GALG	●					
R320055		40.00	55.00	6.5	G1SRLG	●					
R300358		40.00	55.00	8	GALG	●					
R310760		40.00	55.00	9	G1LG-BI	●					
R460760-1		40.00	58.00	10	GALG-BI c/f			●			
R220359		40.10	52.00	9	ESP-GALG	●					
R250455		42.00	56.00	7	GA	●					
R220158		44.45	53.97	4.57	GA	●					
R220355		44.50	62.00	11	GALG-BI	●					
R250258		45.00	59.00	10	G1	●					
R450158		45.00	60.00	10	GA	●					
R450055		45.00	62.00	12	GA	●					
R220358		45.00	65.00	8	GALG	●					
R310658		46.00	65.50	7/8.5	G1LG-BI	●					
R550459		46.43	69.78	12.3	GALG	●					
R310252		47.70	73.10	12.7	ESP	●					
R220356		48.00	72.00	7/8.5	GALG	●					
R550555		48.70	58.00	8.5	ESP	●					
R460255		48.90	63.00	10/12.8	GALG			●			
R300258-1		49.22	63.62	7.26	ESP	●					
R300455		50.00	65.00	9	ESP-G1	●					
R300258		50.80	66.60	6.5	G1SRLG	●					
R550458		50.80	69.85	9.53	GA	●					
R450055-1		52.00	75.00	12	GA	●					
R450355		53.00	79.00	10	ESP	●					
R300759		55.00	70.00	6/10	ESP	●					
R310458		58.95	76.00	9	G1SRLG	●					
R550655		60.00	70.00	9.1	ESP	●					
R350858		75.00	95.00	13	GALG	●					
R351155		95.00	115.00	13	GALG-BI	●					
R350258		95.00	130.00	13	G2LG	●					
R350458		100.00	120.00	13	G2LG	●					
R350958		100.00	125.00	12	G1A-BI	●					
R350255		110.00	140.00	13	G2LG	●					
R350455		120.00	145.00	15	G2LG	●					
R350955		125.00	150.00	15	G2LG-BI	●					
R800055		180.00	200.00	12	G1ALG	●					

RETENES DE TRANSMIÇÃO - TRANSMISSÃO - TRANSMISSION

R300347		7.90	16.00	6	GA	●					
R550447		8.40	16.00	6.5	GA	●					
R240048		13.00	26.00	7	GALG	●					

RETENES RADIALES - RUEDA / TRANSMISION

OIL SEAL - WHEEL OIL SEALS / TRANSMISSION

RETENES POR Ø DE EJE - RETENORES POR DIÂMETRO DO EIXO - DIAMETER HOLDERS OIL SEAL

REF	DE [mm]	DA [mm]	H [mm]	TIPO Type	MATERIAL					
					N	S	P	V	T	VF
R550051	13.00	26.00	9	GALG	●					
R250148	14.00	24.00	7	ESP	●					
R550451	15.00	26.00	7	GALG	●					
R300748	15.50	28.00	6/15	ESP	●					
R300048	15.70	23.81	4.76	GA SR	●					
R550648	16.00	22.80	4.8	GA	●					
R250448	16.00	24.60	9/20	ESP	●					
R450348	17.00	23.00	7	ESP	●					
R300749	17.00	28.00	7/10	GALGHD	●					
R550450	17.00	28.00	7/13	GAHD	●					
R220649	20.00	35.00	7/10.5	GAHD		●				
R240949	21.00	32.00	7.5	G1LGHD	●					
R300751	21.50	40.00	7	GAHD		●				
R250451	22.00	40.00	7/8.5	G2LGHD	●					
R200349	22.10	40.00	12/17	GALGHD	●					
R260251	22.80	40.00	7/8.5	G2LGHD		●				
R250457	23.00	37.00	13.5	ESP		●				
R550550	24.00	36.00	8/12	GAHD	●					
R550951	27.95	56.00	10	GALGHD		●				
R570351	27.95	70.00	10	GALGHD		●				
R250151	28.00	47.00	8	GAHD	●					
R300351	28.00	40.00	8	GALGHD	●					
R450557	28.00	45.00	8	GAHD		●				
R300051	28.58	41.20	6.2	G1HD	●					
R200849	29.90	45.00	7	G1HD		●				
R200051	31.68	44.45	6.35	G1HD	●					
R250050	32.00	56.00	10	GALGHI	●					
R450351	32.00	50.00	10	GAHD		●				
R220150	34.92	56.00	10.7	GALGRI	●					
R300350	35.00	49.70	12.7	G1LGRI	●					
R250257	36.00	68.00	10/13	GAHD	●					
R300050	38.10	60.30	12.5/19	ESP-RI	●	●				
R300057	39.68	80.29	7/16	ESP-RD	●					
R450350	40.00	58.00	10	GAHI	●	●				
R250757	46.00	78.00	10	G1LGHD	●					
R260950	63.00	69.50	11	ESP		●				
R350957	68.00	85.00	10	GALGHD			●			
R360057	68.00	85.00	16	GALG	●					

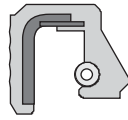

GA



GALG

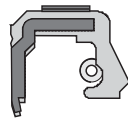

G1A



G1ALG

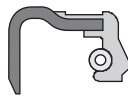

G1

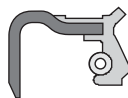

G1LG

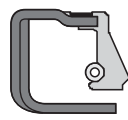

G2

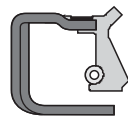

G2LG

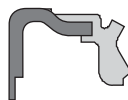

G1SRLG

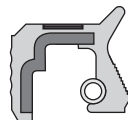

GALGRI/D

c/f Con Fieltro
Con feltro/With Felt

EL MISMO RETEN FABRICADO EN DISTINTOS CAUCHOS

Aconsejamos el uso prioritario de los materiales recomendados en las aplicaciones y referencias originales de nuestro catálogo.

Con el propósito de ofrecer un mejor servicio atendiendo las preferencias de diferentes mercados y clientes, algunos retenes de nuestro catálogo se fabrican también en materiales alternativos.

Si el material recomendado no se ajusta a sus necesidades, le sugerimos que consulten la lista de retenes TARANTO, clasificados por dimensiones, para verificar si la misma pieza puede ser suministrada en otro caucho.

O MESMO RETENTOR FABRICADO EM DIFERENTES MATERIAIS

Recomendamos o uso prioritário dos compostos indicados nas aplicações e referências originais do nosso catálogo.

Com o intuito de oferecer melhor serviço atendendo as preferências de diferentes mercados e clientes, alguns retentores de nosso catálogo são fabricados em materiais alternativos.

Se o material recomendado não se ajusta a suas necessidades sugerimos que consultem a lista de retentores TARANTO, classificados por dimensão para verificar se a mesma peça pode ser fornecida em outra borracha.

THE SAME OIL SEAL MANUFACTURED IN VARIOUS RUBBERS

It is suggested, as a priority, the use of the materials recommended in the applications and original references (OEM) of our catalogue.

However in order to offer a better service and to assist the preferences of different markets and customers some oil seals of our catalogue are also manufactured with alternative materials.

If the recommended material does not meet your requirements, you should consult TARANTO oil seal list classified by dimensions, to confirm if the same piece can be supplied in another rubber.

DISEÑO

La constante mejora de nuestros retenes produjo cambios en el diseño tales como:

- Ⓐ **Modificación de diseño externo:**
Facilita el montaje y asegura el agarre.
- Ⓑ **Labios desplazados:**
Permiten trabajar el labio en una parte del eje no utilizada hasta el momento.
- Ⓒ **Diseño de labio:**
Se potenció el uso de la rosca como sello hidrodinámico.

PROJETO

A constante melhora de nossos retentores produziu mudanças de projeto como:

- Ⓐ **Modificação de desenho externo:**
Facilita a montagem e assegura o alojamento.
- Ⓑ **Lábios deslocados:**
Permite que o lábio trabalhe em uma parte do eixo ainda não utilizada.
- Ⓒ **Desenho do lábio:**
Aumentou a utilização da rosca como vedação hidrodinâmica.

DESING

The steady improvement of our oil seals produced changes in desing such as:

- Ⓐ **Changes in external design:**
Making assembly easier and ensuring housing.
- Ⓑ **Displaced Lips:**
Allowing the lip to work in a part of shaft not used so far.
- Ⓒ **Lip Design:**
The use of thread as hydrodynamic seal was potentialized.

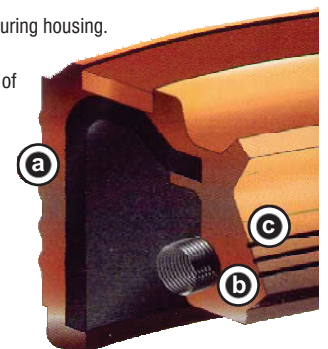



taranto



Junta Tapa de Cilindros Taranto.

Las juntas están diseñadas para superar las exigencias de presión y temperatura que producen los motores de última generación.

- ▶ Eliminación del retorque en juntas 07 y 08.
- ▶ Mayor resistencia mecánica y térmica.
- ▶ Compuestos sellantes especiales que aseguran la máxima estanqueidad.
- ▶ Superficie sellante antiadherente que no daña las partes metálicas del motor.
- ▶ Ahorro de mano de obra, evita trabajos adicionales.
- ▶ Utilización de materiales ecológicos.



JUNTA TAPA DE CILINDROS

CYLINDER HEAD GASKETS

AGCO / SISU

	Código Code	Q	≠	Kit Bulón Bolt Set	Aplicación Application	Motor Engine	Juego
423107 - 423108 	423107 423108	121.0 121.0	1.30 1.10		Massey Ferguson MF4292, MF4297, Challenger - Valtra A950/A990 (4x2, 4x4), BM100/BM110 (4x2, 4x4) DIESEL	4400cc. 420D/DS Agco Sisu Power 106/129HP Ø108	423101-R pág. 02
423207 - 423208 	423207 423208	121.0 121.0	1.30 1.10		MF Case-IH CS - Valtra A65/A75/305/355 365/405/455/465 - (3 cilindros) CS/CVX120/130/150 - CVX1135/1145 1155/1170 - Optima 440F Challenger 565/600/700 - Valtra 8000 - (6 cilindros) DIESEL	3300cc. 320D/DS 33/69HP Ø108 6600cc. 620D/DS 147/189HP Ø108	423001-R pág. 01 423201-R pág. 03

AGRALE

310407 	310407	110.0	1.45	B330800 HAS17038	Camión TX 1600 1983/... DIESEL	2942cc. D229-3 72HP Ø102	330800-R pág. 176
330407 	330407	113.4	1.45		7000 - 7500 - 8500 DIESEL	4300cc. 4.10 X10 90HP - 4.10T/TCA 133/167HP Ø103	330400-R pág. 173
331208 	331208	113.5	1.30		8500 - 9200 DIESEL	4800cc. 4.12TCE Commom Rail 150/180HP Ø105	331200-R MLS pág. 177
870808 	870808	95.0	1.00		AM100-E, AM150-E, AM200-E 2013/... DIESEL	2776cc. ISF2.8 (SOHC) 16V 150/156HP Ø94	870800-R MLS pág. 28



BEDFORD

210005 	210005	101.0	1.85		J6 1961/71 DIESEL	4927cc. 300D 97HP Ø98.3	210000-R pág. 05
210105 	210105	110.0	1.90		350H - C60 - 714 1971/79 DIESEL	5755cc. 350D - CD600 137HP Ø106.36	210100-R pág. 06
210205 	210205	101.0	1.90		C50 Turbo 1971/79 DIESEL	4927cc. 300DX 97HP Ø98.3	210200-R pág. 07
210305 	210305	101.5	1.70		J6 1956/61 DIESEL	4927cc. 300D 97HP Ø98.3	210300-R pág. 08

JUNTA TAPA DE CILINDROS

CYLINDER HEAD GASKETS

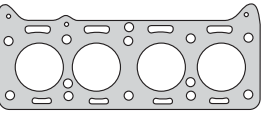
BEDFORD

	Código Code	Q	≠	Kit Bulón Bolt Set	Aplicación Application	Motor Engine	Juego
	210805	101.5	1.70		C14 - J17 - J27 - J37 1962/64 DIESEL	3285cc. 200D 62HP Ø98.3	210800-R  pág. 09

CATERPILLAR

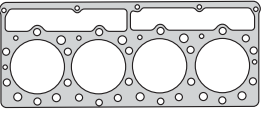
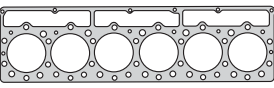
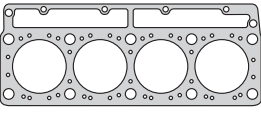
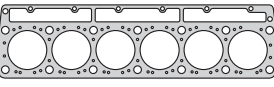
	960548	133.0			Caterpillar Motoniveladora DIESEL	6969cc. 3304 Ø120.65 - 4 cilindros	
	960549	133.0			Caterpillar Motoniveladora DIESEL	10453cc. 3306 Ø120.65 - 6 cilindros	
	960550	109.0			Caterpillar DIESEL	3054 - 4 cilindros	
	960551	109.0			Caterpillar DIESEL	3056 - 6 cilindros	

CHEVROLET

	200405	95.0	1.70		Apache C10 3.9/16, Camión 4400 1957/..., Bel Air, Impala 1953/62	3851cc. 235 130HP Ø90.48	200400-R  pág. 11
	200605	98.5	1.70		Camión 3 3/4 6500 1954/62, C10, C 14, C60 BR 1969/...	4270cc. 261 142HP Ø95.25	200600-R  pág. 12
	210005	101.0	1.85		J6 1961/71 DIESEL	4927cc. 300D 97HP Ø98.3	210000-R  pág. 05
	210105	110.0	1.90		350H, C60, 714 1971/79 DIESEL	5755cc. 350D - CD600 137HP Ø106.36	210100-R  pág. 06
	210205	101.0	1.90		C50 Turbo 1971/79 DIESEL	4927cc. 300DX 97HP Ø98.3	210200-R  pág. 07

JUNTA TAPA DE CILINDROS

CYLINDER HEAD GASKETS

CHEVROLET

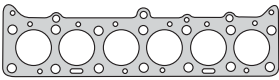
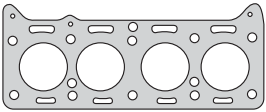
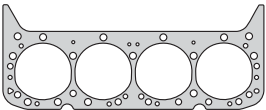
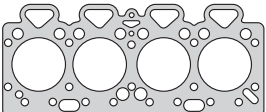
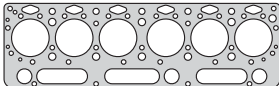
	Código Code	Q	≠	Kit Bulón Bolt Set	Aplicación Application	Motor Engine	Juego
	210305	101.5	1.70		J6 1956/61 DIESEL	4927cc. 300D 97HP Ø98.3	210300-R pág. 08
	210805	101.5	1.70		C14 - J17/J27/J37 1962/64 DIESEL	3285cc. 200D 62HP Ø98.3	210800-R pág. 09
	280105	105.0	1.20		283/302/307/327 Carburador, 327, 350 No Corvette, 350, Pick Up y Medianos, 283/307/327 Camiónes 1967/... Truck 1996/01, Vortec Vin R	5735cc. C350 V8 Ø101.6 5735cc. C350 V8 Ø101.6	280100-R pág. 13 281100-RMX pág. 14
	410605 410607	104.0 104.0	1.70 1.70		D10/20/40 Aspirado Turbo D20 DIESEL	3860cc. Q20B4.236 Iny. Directa 70HP Ø98.4 3860cc. Q20B4 Iny. Directa 70HP Ø98.4	410600-R pág. 224 401000-R pág. 211
	410907	107.0	1.50		D60 - D70 DIESEL	5840cc. 6-357 Vehicular 120HP Agrícola 91HP Industrial 108HP Ø104.14	410900-R pág. 227

CIMARRON

	210405	101.0	1.40		1976/85 DIESEL	3285cc. 3300D 88HP Ø98.3	210400-R pág. 15
	210505	101.0	1.40		1986/... DIESEL	3283cc. 3300D 89HP Ø98.42	210500-R pág. 16
	210605	109.5	1.40		1979/85 DIESEL	3840cc. 3800D 99HP Ø106.4	210600-R pág. 17
	210705	109.5	1.40		1986/... DIESEL	3840cc. 3800D 99HP Ø106.4	210700-R pág. 18



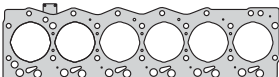







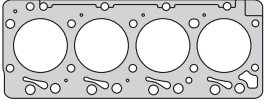

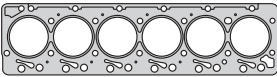

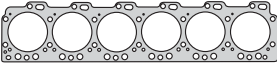

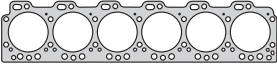
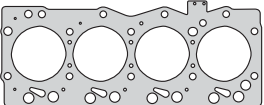

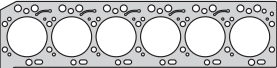
CUMMINS

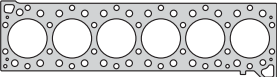
	800808	105.0	1.20		Serie ISB 2004/... DIESEL	5883cc. ISBe 6 275HP Ø102 (OHV) 24V	800800-R pág. 71
---	--------	-------	------	--	------------------------------	--	---------------------

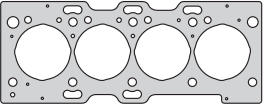
JUNTA TAPA DE CILINDROS

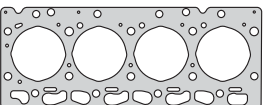
CYLINDER HEAD GASKETS

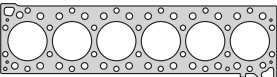
CUMMINS

	Código Code	Q	≠	Kit Bulón Bolt Set	Aplicación Application	Motor Engine	Juego
870007 	870007 870007-1.85	106.0 106.0	1.60 1.85	B870000	Serie B - F4000 2000/... Cargo 915 - Euro II DIESEL	3900cc. 4B 100HP - 4BT/BTA 130HP Ø102	870000-R  pág. 19
870107 	870107 870107-1.85	106.0 106.0	1.60 1.85	B870100	Serie B - F14000 - Turbo - F4000 1999/... 1416 Euro I - Dodge Truck 359 1989/93 Ram 2007/... DIESEL	5883cc. 6B 330HP Ø102 5900cc. 6B 180HP - 6BT/BTA 205HP Ø102 (SOHC) 12V	870100-R  pág. 21
870207 	870207	120.0	1.50	B870200	Serie C - Bus - Camión - Agrícola Cargo 1722/1730/2625 1998/... F14000 1999/... DIESEL	8300cc. 6C 254HP - 6CT/CTA 294HP Ø114 (SOHC) 12V	870200-R  pág. 23
870307 	870307	120.0	1.50	B870200	Serie C - Bus - Cargo 1722 - 1730 2625 1998/... - F14000 DIESEL	8300cc. 6C 254HP - 6CT/CTA 294HP Ø114	
870508 	870508	105.0	1.10	B870500	Serie ISBe - Bus, Agrale, Euro III/IV, Electrónico 2003/... F100 2006/..., Common Rail DIESEL	3920cc. ISBe 150/170HP Ø102 (OHV) 16V	870500-R  pág. 25
870607 	870607	123.5	1.80	B870200	Serie C 1832/2632 Cargo 2003/... Bus 17260EOT/18320EOT 2003/...	8270cc. ISCe6 24V 315HP Ø114	870600-R  pág. 26
870707 	870707	146.5	2.20		ISX Series 1997/10 DIESEL	14951cc. ISX/QSX 380/540HP Ø137	870700-R  pág. 27
870808 	870808	95.0	0.95		ISF Series, Camiones, Pick-Up DIESEL	2776cc. ISF2.8 (SOHC) 16V 150/156HP Ø94	870800-R MLS  pág. 28
870908 	870908	103.0	1.20		ISF Series, Camiones, Ómnibus, Pick-Up DIESEL	3759cc. ISF3.8 (OHV) 16V 148HP Ø102	870900-R MLS  pág. 29
871007 	871007	147.0	2.20		ISX Series 400/425/450/460/470/475 Para motores con recirculación de gases de escape DIESEL	14951cc. ISX 405/475 Ø137 (DOHC) 24V	871000-R  pág. 30

JUNTA TAPA DE CILINDROS

CYLINDER HEAD GASKETS

CUMMINS

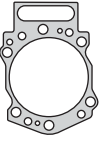
	Código Code	Q	≠	Kit Bulón Bolt Set	Aplicación Application	Motor Engine	Juego
	871308	179.0	2.00		Tractor, Excavadora Tractor 7950, 7980 DIESEL	18942cc. QSK19 (OHV) 24V 6 cilindros 532HP Ø159	
	873208	157.0	2.00		Camiones DIESEL	14016cc. NT855 (OHV) 24V 340HP Ø140	

DAF

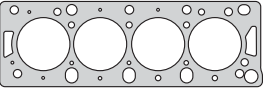
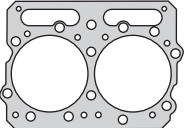
	420607	86.0	1.50	B420600	Va 200, VS 200 1986/... DIESEL	1994cc. TN44 Ø 84,4	420600-R pág. 232
	873208	157.0	2.00		FT95.500 V 1994/98 95 XF 530 1997/... DIESEL	14016cc. F373M 507HP Ø140 VF390M 530HP Ø140 (OHV) 24V	

DODGE

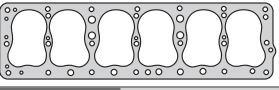
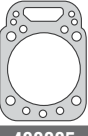
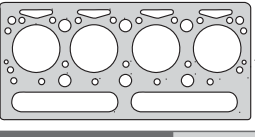
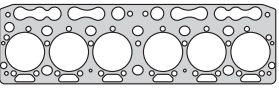
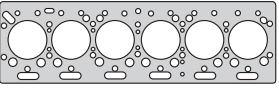
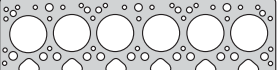
	220705	88.0	1.40		Continental 3 3/8 - 3 7/16, D100/200/400/500 1951/64	3956cc. 241 95HP Ø85.73 4106cc. 251 100HP Ø87.31	220700 pág. 47
	320807	110.0	1.20		Camión 1978/... DIESEL	5100cc. D225-6 102HP Ø95	440100-R pág. 180
	400005 400007 400008	92.5 92.5 92.5	1.40 1.40 1.15	B400000 HAS19038	D100 - D200 1987/... DIESEL	3336cc. 4.203-P4-192Z 71HP Ø91.49	400000-R pág. 201
	400107 400108	93.0 93.0	1.40 1.15		DP 400/500 1964/... DIESEL	5004cc. 6.305 Cadenero 100HP Ø91.44	400100-R pág. 202
	400207 400208	104.0 104.0	1.50 1.30	B400200 HAS19038	DP 600/800 1968/... DIESEL	5798cc. 6.354-2 140HP Ø98.47	400200-R pág. 203
	400407 400408	104.0 104.0	1.50 1.45	B400200 HAS19038	D600 - D800 1976/... DIESEL	5798cc. 6.354-4 Turbo 172HP Ø98.42	400400-R pág. 205

JUNTA TAPA DE CILINDROS

CYLINDER HEAD GASKETS

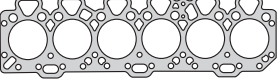
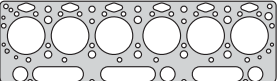
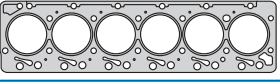
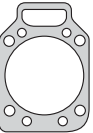
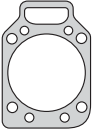
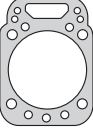
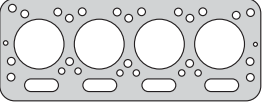
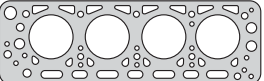
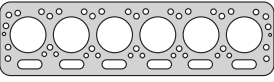
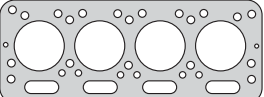
DODGE							
	Código Code	Q	≠	Kit Bulón Bolt Set	Aplicación Application	Motor Engine	Juego
	400907	104.0	1.45	B400200 HAS19038	DP 600 - DP 800 DIESEL	5798cc. 6.354-1 135HP Ø98.43	400900-R pág. 210
	410907	107.0	1.50		P700D - P900 DIESEL	5840cc. 6-357 Agrícola 91HP Industrial 108HP Ø104.14	410900-R pág. 227
	870107 870107-1.85	106.0 106.0	1.60 1.85	B870100	Truck 359 1989/93 - Ram 2007/... DIESEL	5883cc. 6B 330HP Ø102 (SOHC) 12V	870100-R pág. 21
DYNAPAC							
	310407	110.0	1.45	B330800 HAS17038	Cilindro Vibratorio CHF 44 1983/... DIESEL	2942cc. D229-3 72HP Ø102	330800-R pág. 176
FIAT PESADO - IVECO							
	310407	110.0	1.45	B310400 B310500 HAS17038	Escavadora FB80 (4 cilindros) Tractor S90 - FE105 - FA120 - FE105B (6 cilindros) DIESEL	3922cc. D229-4 96HP Ø102 5883cc. D229-6 145/160HP Ø102	310400-R pág. 167 310500-R pág. 169
	320807	110.0	1.20		850E (4 cilindros) Tractor AD7B - 980E - S90 (6 cilindros) DIESEL	2977cc. D225-4 3400cc. D225-4 68HP Ø95 5100cc. D225-6 102HP Ø95	440000-R pág. 179 440100-R pág. 180
	700007 700008	109.0 109.0	1.80 1.80		Tractor Someca 1965/74 DIESEL	4156cc. M45 - 450 - 55 Super Son Ø105	700000 pág. 49
	700108	126.5	1.80		Tractor 1962/69 DIESEL	6872cc. 780 - R - AE Ø125	700100 pág. 50
	700207 700208	114.5 114.0	2.00 1.86		Tractor - CP3 1972/80 Camión 1964/83 DIESEL	7412cc. 840/900/1100 - CP3 - 900E 165HP Ø110 7412cc. 673N - CP 840 - 900 Ø110	700200 pág. 51 710100 pág. 59
	700308	112.5	1.80		Tractor Someca - CN3 1961/70 Someca M45/M50 - Super Som 55/46A Tigrotto 1969/... DIESEL	3421cc. 650 - 700 Ø110 4397cc. CO3 Ø108	700300 pág. 52

JUNTA TAPA DE CILINDROS

CYLINDER HEAD GASKETS

FIAT PESADO - IVECO

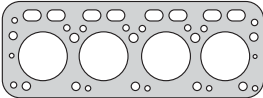
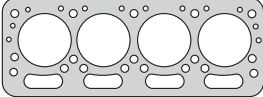
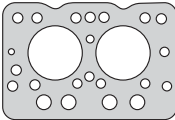
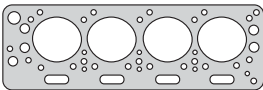
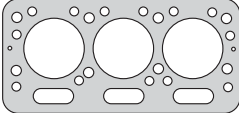
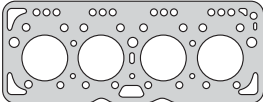
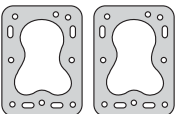
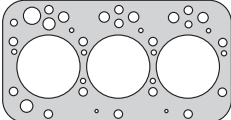
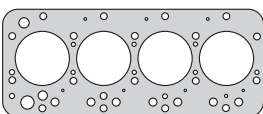
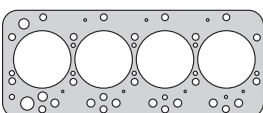
	Código Code	Q	≠	Kit Bulón Bolt Set	Aplicación Application	Motor Engine	Juego
700408 	700408	104.0	1.80		Tractor Someca - Leoncino 1950/... DIESEL	3456cc. DA - 50 - 40 Ø100	700400 pág. 53
700507 - 700508 	700507 700508	118.0 118.0	2.00 1.86		Tractor - CO3 1971/80 DIESEL	5401cc. 700E - 800E - CO3 - 640 740 90/106HP Ø115	700500 pág. 54
700605 	700605	87.0	1.40		Tractor U25 1957/62 Tractor 211R 1962/65 DIESEL	1135cc. U25 - 211R - CD Ø8	700600 pág. 55
700708 	700708	126.0	1.80		Tractor 1955/... DIESEL	6546cc. 60 RL Ø122	700700 pág. 56
700807 - 700808 	700807 700808	114.0 114.0	2.00 1.86		Tractor 400 E.V.U - 500 Super 600E - 480 1969/80 DIESEL	3421cc. CN3 Ø110 3705cc. CN4 Ø110	700800 pág. 57
700908 	700908	86.0	1.65		Tractor 411R - 411T - 431R 1959/85 DIESEL	2270cc. 615 40HP Ø85	700900 pág. 58
710205 	710205	79.0	1.40		Motor Arranque - Tractor 1955/74 DIESEL	665cc. Motorino 55/60/788R Ø75	710200 pág. 60
710305 	710305	120.5	1.40		Tractor DIESEL	2592cc. 480-540T 100HP	
710405 	710405	102.0	1.70		Tractor - Camiones DIESEL	3455cc. 640-670-680 100HP	
710505 	710505	106.0	1.40		Tractor , Camiones 780 - 780 DT - 765C - 766 - 855 DIESEL	3663cc. 780/780DT Ø103	

JUNTA TAPA DE CILINDROS

CYLINDER HEAD GASKETS

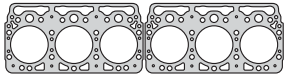
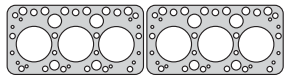
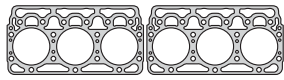
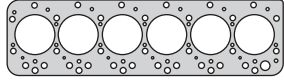
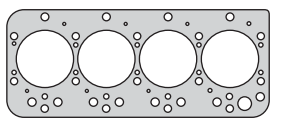
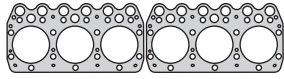
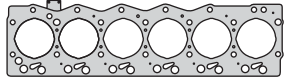
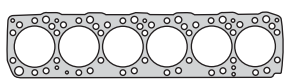
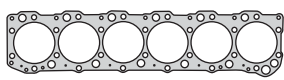
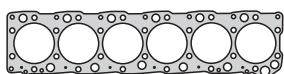

FIAT PESADO - IVECO

	Código Code	Q	≠	Kit Bulón Bolt Set	Aplicación Application	Motor Engine	Juego
800007 - 800008	800007 800008 800008-CU	144.0 139.0 139.0	1.40 1.25 1.25	B800000	Camión 619N1 - 697N TB - Bus 391 691 - 319N - Bus 221A 1970/... DIESEL	13798cc. 8210.02 260HP Ø137 (OHV) 12V	800000-R 800001 📄 pág. 61
							
800105	800105	127.0	1.40		Camión 203 DIESEL	10676cc. 682 N2 MK3 Ø125	800100 📄 pág. 63
							
800207	800207	137.0	1.40	B800000	Camión Bus 341A - 221 - 221H - 619NP 1965/66 - 693 N/N1/T/T1 1965/68 DIESEL	12883cc. 221- 8210.01 240HP Ø135	800200-R 📄 pág. 64
							
800307	800307	105.3	1.70		Camión 150 N Turbo AU130 Eurocargo 150 E23 - 150 E20 75/80/85/95/100/120/130/150/170 E15 80/85/100/120/130/135/150/170 E18 80/90/100/E21 - 135/150/170/180/E23 DIESEL	5861cc. 8060.25/45/45S 177/207HP 5861cc. 8060.25 143/177HP 8060.45/S 207/277HP Ø104 (OHV) 12V	800300-R 📄 pág. 65 800600-R 📄 pág. 69
							
800407	800407	105.0	1.70		150 Turbo Eurocargo DIESEL	3666cc. 8040.04 Ø103	
							
800508	800508	139.0	1.25	B800500	Euro Trakker - Euro Star - Euro Tech 89/... 180E42 - 190E31/E42 - 240E42/E36 260E37/E42/E36 - 400E31/E37/E42 410E37/E42 - 440E37/E42 - 720E31 380E31 1991/... DIESEL	13798cc. 8210.42L LE2 370HP 8210.42K KE2 420HP 8210.22.800 310HP Ø137 (SOHC) 12V	800500-R 📄 pág. 67
							
800808	800808	105.0	1.20	B800800	Eurocargo 80 E18 - 80 E21 - 90 E18 90 E21 Tector - Common Rail Turbo Intercooler EDC 130 E18 120 E24 - 120 E28 - 150 E18 2004/... DIESEL	5880cc. 170E22 - F4AE0681D 24V TDI- EDC 180/210HP Ø102 (OHV) 24V	800800-R 📄 pág. 71
							
800908	800908	127.5	1.50	B800900	Cursor 8 Eurotech (E24/31/35), Eurotrakker (E24/27/31/35-T27/31/33/35) Stralis (S27/30/31/33/35/36) Euromover E24 - Cavallino 2007/... DIESEL	8000cc. F2BE0681/F2BE3681 E4 Turbo Interc. 310HP Ø115 (SOHC) 24V	800900-R 📄 pág. 72
							
801008	801008	151.0	1.44		Euro Stard Cursor 13 260E48 440E46/48 - Stralis 260/440S44 190/260/440/S48/260/440S50/54/56 Eurotrakker Cursor 13 190/260/340 380E38 - E44-400/410/440/720E38/E44 DIESEL	13000cc. F3BE3681A Turbo Intercooler 380/420HP Ø135	801000-R 📄 pág. 74
							
801108	801108	141.0	2.00		Eurotech Cursor 10 190/260/440 E40 2001/..., Stralis 2002/... DIESEL	10308cc. F3AE Turbo Intercooler (SOHC) 24V 400/450HP Ø125	
							

JUNTA TAPA DE CILINDROS

CYLINDER HEAD GASKETS

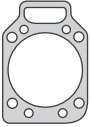
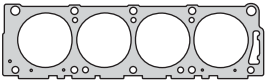
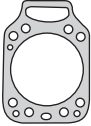
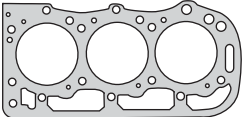
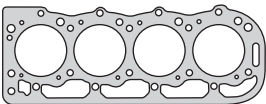

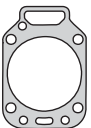
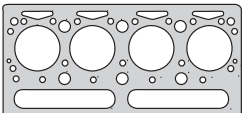
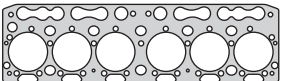
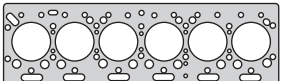

FORD PESADO

	Código Code	Q	≠	Kit Bulón Bolt Set	Aplicación Application	Motor Engine	Juego
	310407	110.0	1.45	B310400 B310500 HAS17038	F4000 1992/93 - F2000 1980/... FB4000 1985/... - F1000 1994/96 F14000 - F4000 1994/96 - Cargo F12000 - F140000 1985/... DIESEL	3922cc. D229-4 96HP Ø102 5883cc. D229-6 145/160HP Ø102	310400-R pág. 167 310500-R pág. 169
	311105	109.0	1.20		Camión 1964/78	5900cc. 351 V8 6400cc. 391 V8	311100-RMX pág. 75
	320407	107.0	1.20		Camión F4000 1986/... DIESEL	4156cc. D226-4 82HP Ø105	320400-R pág. 171
	330007	114.5	1.50		Tractor 4600/4110/4140/4190/4200 4400/4410 1965/74 4610/4610H/4610SU 1981/90 DIESEL	3294cc. BSD 332 - 333/H 81HP Ø111.8	330000 pág. 76
	330107	114.5	1.50		5610/5030/5110/5610/5900/6600 6700/7000/7100/7200 6410/6610/6710/7600/7700 6810/7410/7610/7710 F2000/F4000, FB4000, Tractor 6600/6610 DIESEL	4196cc. BSD 442 - 256 72HP 4385cc. BSD 444 80HP 4392cc. BSD 444T 82HP 4393cc. 268 82/87HP Ø111.8	330100 pág. 77
	330207	114.5	1.50		7810/7910/8210/8530 1988/... 8630/8750/8830 1992/... Fase I-II - Cargo 6.6/7.8 Simples/Turbo DIESEL	6572cc. Fase I-II Cargo 6.6/7.8 Simples/Turbo 110HP Ø111.8	330200-R pág. 78
	330407	113.4	1.45		Euro I/II/III F14000 1995/98 - Euro I/II DIESEL	4300cc. 4.10 X10 90HP 4.10T/TCA 133/167HP Ø103 6450cc. 6.10 X10 139HP - 6.10T/TCA 201/250HP Ø103	330400-R pág. 173 330700-R pág. 174
	400005 400007 400008	92.5 92.5 92.5	1.40 1.40 1.15	B400000 HAS19038	F100 - Falcon 1970/... DIESEL	3336cc. 4.203-P4-192Z 71HP Ø91.49	400000-R pág. 201 410000-R pág. 218
	400107 400108	93.0 93.0	1.40 1.15		F350/600 DIESEL	5004cc. 6.305 Cadenero 100HP Ø91.44	400100-R pág. 202
	400207 400208	104.0 104.0	1.50 1.30	B400200 HAS19038	F600/700 DIESEL	5798cc. 6.354-2 140HP Ø98.47	400200-R pág. 203

JUNTA TAPA DE CILINDROS

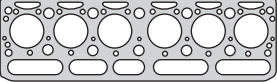
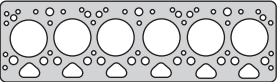
CYLINDER HEAD GASKETS

FORD PESADO

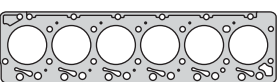
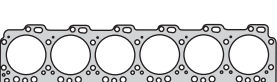
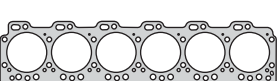
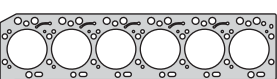
	Código Code	Q	≠	Kit Bulón Bolt Set	Aplicación Application	Motor Engine	Juego
400307 - 400308 	400307 400308	92.5 92.5	1.40 1.25	B400300 HAS19038	F100 - F350 - F600 1974/... F600 DIESEL	5004cc. 6PF- 305 102HP Ø91.44 5004cc. 6PF- 305 Potenciado 100HP Ø91.49	400300-R pág. 204 410100-R pág. 219
400407 - 400408 	400407 400408	104.0 104.0	1.50 1.45	B400200 HAS19038	F7000 Camiones Pesados y Semipesados DIESEL	5798cc. 6.354-4 Turbo 172HP Ø98.42	400400-R pág. 205
400907 	400907	104.0	1.45	B400200 HAS19038	F600/700 DIESEL	5798cc. 6.354-1 135HP Ø98.43	400900-R pág. 210
410907 	410907	107.0	1.50		F600/750/1100 - F6000 - F7500/11000 DIESEL	5840cc. 6-357 Agrícola 91HP Industrial 108HP Ø104.14	410900-R pág. 227
420007 	420007	109.0	1.50		F400/600/7000/11000/12000/13000 DIESEL	5840cc. 6-358 Agrícola 118HP Industrial 127HP Ø104.14	420000-R pág. 228
870007 	870007 870007-1.85	106.0 106.0	1.60 1.85	B870000	F4000 2000/... - Cargo 915 - Euro II DIESEL	3900cc. 4B 100HP - 4BT/BTA 130HP Ø102	870000-R pág. 19
870107 	870107 870107-1.85	106.0 106.0	1.60 1.85	B870100	F14000 - Turbo - F4000 1999/... 1416 Euro 1989/93 DIESEL	5900cc. 6B 180HP 6BT/BTA 205HP Ø102 (SOHC) 12V	870100-R pág. 21
870207 	870207	120.0	1.50	B870200	Cargo 1722/1730/2625 1998/... F14000 1999/... DIESEL	8300cc. 6C 254HP 6CT/CTA 294HP Ø114 (SOHC) 12V	870200-R pág. 23
870307 	870307	120.0	1.50	B870200	Cargo 1722 - 1730 - 2625 1998/... F14000 DIESEL	8300cc. 6C 254HP 6CT/CTA 294HP Ø114	
870607 	870607	123.5	1.80	B870200	Ford 2632E/2932E/4432E/4532E/5032E DIESEL	8270cc. ISCe 6 24V - Serie C 1832/2632 315HP Ø114	870600-R pág. 26

JUNTA TAPA DE CILINDROS

CYLINDER HEAD GASKETS

FORD PESADO

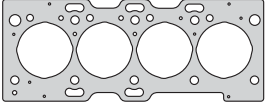
	Código Code	Q	≠	Kit Bulón Bolt Set	Aplicación Application	Motor Engine	Juego
	870808	95.0	1.00		F350, F4000 2014/... DIESEL	2776cc. ISF2.8 (SOHC) 16V 150HP Ø94	870800-R MLS pág. 28

FOTON

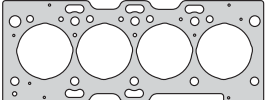
	870808	95.0	1.00		Aumark 2000/3000/4000/5000/6000/7000 2012/... DIESEL	2776cc. ISF2.8 (SOHC) 16V 150/156HP Ø94	870800-R MLS pág. 28
---	--------	------	------	--	--	---	-------------------------

HANOMAG

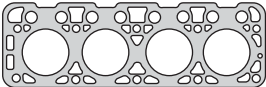
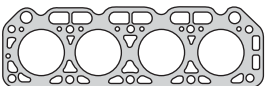
	750009 750009-0.8 750009-0.6	117.5 117.5	0.80 0.60		Tractor - D57 1963/... DIESEL	5702cc. R45/55/60/75 Ø110	750000 pág. 79
	750109	96.0	1.00		Tractor - D28LA - D28 1950/55 DIESEL	2800cc. R25/L28 - R35/R40 R435 Brillant Ø90	750100 pág. 80
	750209	96.0	1.00		Brillant - Tractor - D28C 1965/71 DIESEL	2800cc. R40 25e - R57 - R46 Ø90	750200 pág. 81

HYUNDAI

	905108	102.5	1.45		Mighty, County - Turbo Intercooler DIESEL	3298cc. D4AL 120HP Ø100 (SOHC) 8V	995100-R MLS pág. 83
	905208	105.5	1.45		Mighty, County - Aspirado DIESEL	3568cc. D4AF 8V 96HP Ø104	995200-R MLS pág. 84
	905308	105.0	1.50		Mighty, County - Turbo Intercooler DIESEL	3907cc. D4DA 155HP Ø104 (SOHC) 8V	995300-R MLS pág. 85



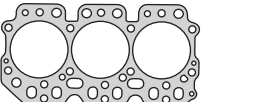







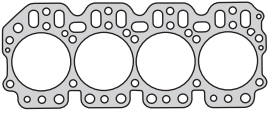

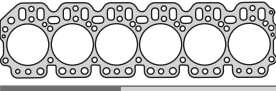
JOHN DEERE

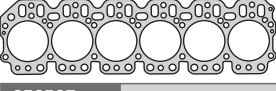
	850007	119.0	1.40		1030 - 1035 - 1520 - 1530 - 204 JD302 1973/... DIESEL	2696cc. 3164D Ø102	850000-R 850001 pág. 87
---	--------	-------	------	--	---	-----------------------	-------------------------------

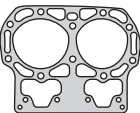

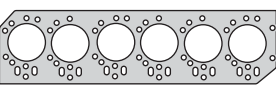

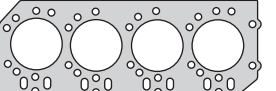
JUNTA TAPA DE CILINDROS

CYLINDER HEAD GASKETS

JOHN DEERE

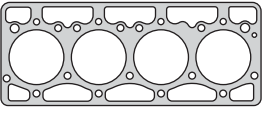
	Código Code	Q	≠	Kit Bulón Bolt Set	Aplicación Application	Motor Engine	Juego
	850107	119.0	1.40		Tractor Equipos Viales 2120/2030/2035 2270/2280/2340 - JD310/401/440 JD450/480 1974/... - 2130/2135/1640 1840/2140/JD4400 - 540B/550/555 1980/... DIESEL	3590cc. 4219 D 81HP Ø102 3918cc. 4239 D/T 81HP Ø102	850100-R 850101-R  pág. 88
	850207	119.0	1.40		Tractor Motoniveladora 6329D 3120/3130/3135/2840/630 JD303/444/540/570/482 - 3140/3040 3640/4040/960/975/2940/3050/3350 3350 - 3550 - 6500 - 6600 - 7500 Cosechadora 1075 1991/... DIESEL	5395cc. 6.329D 87HP Ø102 5877cc. 6.359D 87HP Ø106.5 5879cc. 6.359D 110/125HP Ø106.5	850200-R 850201-R  pág. 89 850400-R 850401  pág. 91
	850307	115.0	1.40		3420 - J10 - 4420 - 570 Tractor Motoniveladora 1972/... DIESEL	4976cc. 303 85HP Ø98.04 5393cc. 329 87HP Ø102	850300-R  pág. 90
	850507	159.5	1.60		730 - Tractor 375 1960/74 DIESEL	6156cc. Ø155.58	850500  pág. 92
	850607	120.0	1.40		6505/6605/6615/7500 - Power Tech MUM - Power Tech - Gen Set DIESEL	5395cc. 6068TJ31/J32/J61 6068HJ63 150/178HP Ø106	850601-R 850601  pág. 93
	850707	120.0	1.40		Motores Agrícolas e Industriales DIESEL	4500cc. 4540TJ31 107HP 4045DJ31 74HP Ø10	850701-R 850701  pág. 94

KOMATSU

	760007	105.0	1.70		Tractor, Autoelevador DIESEL	2940cc. 4D94 8V 39HP Ø104	760000-R  pág. 95 760300-R  pág. 99
	760107 760108	95.0 94.0	1.60 0.40		Tractor, Autoelevador DIESEL	2800cc. 4D94-E 8V 40HP Ø93	760100-R MLS  pág. 97
	760207	95.5	1.65		Tractor, Autoelevador DIESEL	2800cc. 4D94-E 8V 40HP Ø94 (760200-R) pág. 96	760200-R  pág. 98
	760407	97.0	1.45		Tractor, Autoelevador DIESEL	3260cc. 4D95L 8V 54/65HP Ø96	760400-R  pág. 100

JUNTA TAPA DE CILINDROS

CYLINDER HEAD GASKETS

KOMATSU

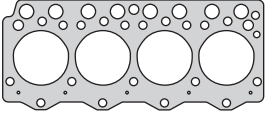
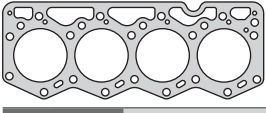
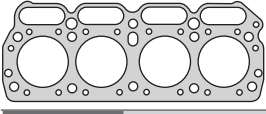
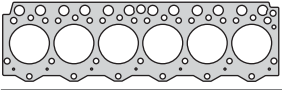
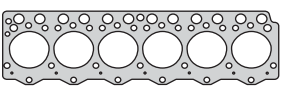



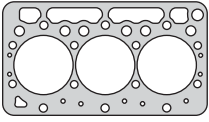
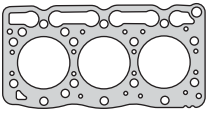
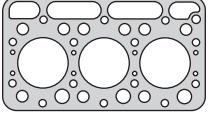
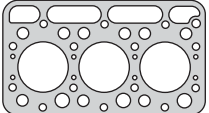
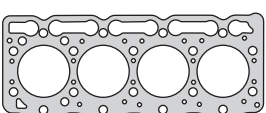
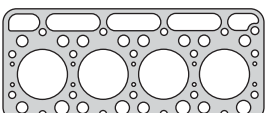

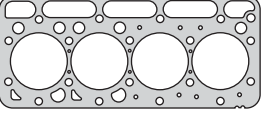

	Código Code	Q	≠	Kit Bulón Bolt Set	Aplicación Application	Motor Engine	Juego
	760508	97.0	1.40		Tractor, Autoelevador DIESEL	3260cc. 4D95 8V 54HP Ø96	760500-R MLS pág. 101
	760607	113.0	1.70		Tractor, Autoelevador DIESEL	4330cc. 4D105-5 63/66HP Ø112	760600-R pág. 102
	760707	112.0	1.75		Tractor, Autoelevador DIESEL	4330cc. 4D105-3 63HP Ø111	760700-R pág. 103
	760807	96.8	1.70		Tractor, Excavadora DIESEL	4890cc. 6D95 71HP Ø97	760800-R pág. 104
	760908	96.8	1.40		Tractor, Autoelevador DIESEL	4890cc. 6D95 71HP Ø94	760900-R MLS pág. 105

KUBOTA

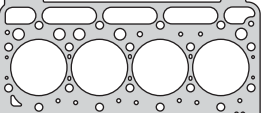
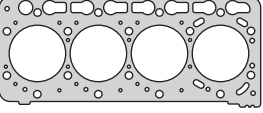
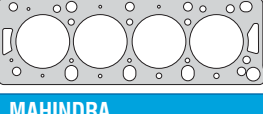
	770007	68.8	1.70		Maquinaria Agrícola D722 DIESEL	719cc. 3D66 6V 20HP Ø86	770000-R pág. 107
	770107	73.0	1.70		Maquinaria Agrícola D905 DIESEL	898cc. 3D72 6V Ø72	770100-R pág. 108
	770207	78.0	1.70		Maquinaria Agrícola D722 DIESEL	719cc. 3D66 6V 20HP Ø77	770200-R pág. 109
	770307	88.0	1.70		Maquinaria Agrícola D1402 DIESEL	1395cc. 3D85 6V 35HP Ø77	770300-R pág. 110
	770407	73.0	1.70		Maquinaria Agrícola V1205 DIESEL	1200cc. 4D72 8V Ø72.5	770400-R pág. 111
	770507	78.0	1.75		Maquinaria Agrícola V1502 DIESEL	1498cc. 4D76 8V 46HP Ø77	770500-R pág. 112

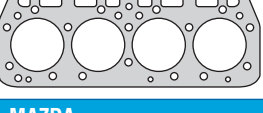
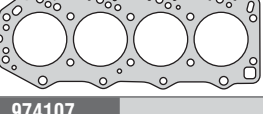
JUNTA TAPA DE CILINDROS

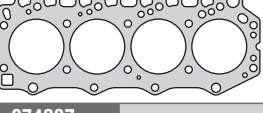
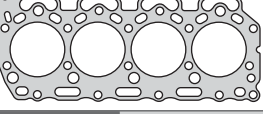
CYLINDER HEAD GASKETS

KUBOTA							
	Código Code	Q	≠	Kit Bulón Bolt Set	Aplicación Application	Motor Engine	Juego
	770607	88.9	1.70		Maquinaria Agrícola V2203 DIESEL	2197cc. 4D87 8V 46HP Ø88	770600-R  pág. 113
	770708	88.0	1.25		Maquinaria Agrícola V2203 DIESEL	2197cc. 4D87 8V 46HP Ø88	770700-R MLS  pág. 114
	760808	99.5	0.85		Maquinaria Agrícola V3300 DIESEL	3318cc. 4D98T 12V Ø98	770800-R MLS  pág. 115
LEYLAND							
	420607	86.0	1.50	B420600	Sherpa 185/200/215/220/230/240/250 255 1986/94 DIESEL	1994cc. Prima 65 64HP Ø84.45	420600-R  pág. 232
MAHINDRA							
	930007	90.5	1.30		Tractor 255DI - 265DI - Pick Up DIESEL	1300cc. 25HP Ø89.9 1800cc. 25HP Ø89.9 2500cc. 25HP Ø89.9	
MAZDA							
	971207	99.5	1.78	B971200	Pick Up, Camión T3000 1985/... Autoelevador Yale 1984/... DIESEL	2977cc. HA/WEF 8V 86HP Ø95	971200-R  pág. 117
	974107	99.5	1.70	B971200	Truck T3000 1981/84 DIESEL	2977cc. HA 8V 86HP Ø95	974100-R  pág. 118
	974207	99.5	1.55		Truck E3000 1978/81 DIESEL	2977cc. HA 8V 86HP Ø95	974200-R  pág. 119
	974307	104.0	1.75		Truck T3500 1984/... DIESEL	3455cc. SL Ø103 (OHV) 8V	974300-R  pág. 120

JUNTA TAPA DE CILINDROS

CYLINDER HEAD GASKETS

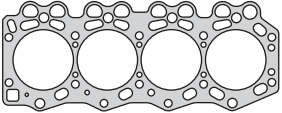

MAZDA

	Código Code	Q	≠	Kit Bulón Bolt Set	Aplicación Application	Motor Engine	Juego
	974408	104.0	1.45		Truck T3500 1984/... DIESEL	3455cc. SL-T Ø103 (OHV) 8V	974400-R MLS pág. 121
	974508	109.8	1.30		Truck T4000 DIESEL	4021cc. TF Ø105.5 (OHV) 8V	974500-R MLS pág. 122
	974608	113.0	1.30		Truck T4500 DIESEL	4553cc. TM Ø109 (OHV) 8V	974600-R MLS pág. 123

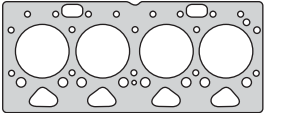
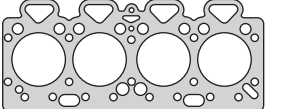
MAXION

	280307	105.0	1.80		MF290/292/610/620 DIESEL	4100cc. P4000-400T 72/86HP Ø100	401100-R pág. 212
	410605 410607	104.0 104.0	1.70 1.70		GM D10, F350, VW6.80, Case 550 DIESEL	3860cc. 4.236 Iny. Directa 70HP Ø98.4	410600-R pág. 224

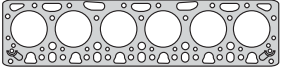
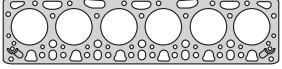
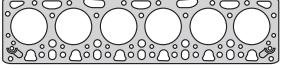
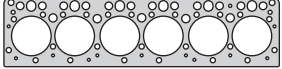









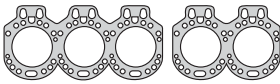



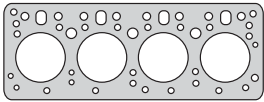



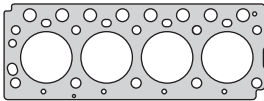

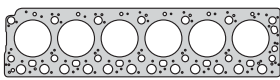
MERCEDES BENZ

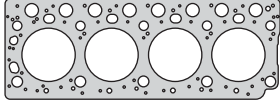
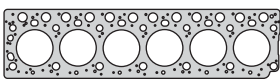
	350005	93.0	1.40	B350300	MB 3500 - L3250 - L3500 1949/52 DIESEL	4580cc. L911 OM311/312 98HP Ø90	350000-R pág. 125
	350205	96.0	1.40	B350300 HAD19038	MB 1112 - 1114 - 0140 - L1112 - L1514 1957/... DIESEL	5100cc. OM 321 108HP Ø95 (SOHC) 12V	350200-R pág. 127
	350305	98.5	1.40	B350300 HAD19038	MB 1114 - 0140 1972/... OM 352 Turbinado - Aspirado 1981/... DIESEL	5675cc. OM 352 100HP Ø97 (OHV) 12V	350300-R 350301-R pág. 128
	350405 350407	98.5 98.5	1.40 1.30	B350300 HAD19038	MB 1517 Turbo 0170 L911 - L1518 1978/... MB OH1215/1315/1316/1319/1320/1420 Aspirado Turbo 1620/OHL1621 OS1318 - L1915/1314/1318/1365 2018/3611R/2214/2217 DIESEL	5675cc. OM 352A 130HP Ø97 5957cc. OM 366/A/LA 138/170HP Ø97.5 (OHV) 12V	350400-R pág. 130 350900-R pág. 135
	350405 350407	98.5 98.5	1.40 1.30	B350300 HAD19038	MB 1518 desde 1991/... Motor Híbrido. (Con junta tapa lateral de goma) MB Turbinado Aspirado 1981/... DIESEL	5675cc. OM 352/OM352A Turbo 130HP Ø97 5675cc. OM352/OM352A 131/156HP (OHV) 12V Ø97	352200-R pág. 139 360200 pág. 143

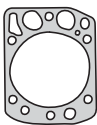
JUNTA TAPA DE CILINDROS

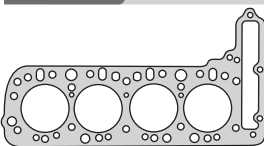
CYLINDER HEAD GASKETS

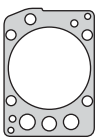
MERCEDES BENZ

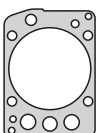
	Código Code	Q	≠	Kit Bulón Bolt Set	Aplicación Application	Motor Engine	Juego
	350607-1	130.0	1.30	B350600	MB 1521/1526 1985/87	9650cc. OM 355-5 20V 84HP Ø128 11580cc. OM 355-6 230HP Ø128 (OHV) 24V	350600-R  pág. 132 360400-R  pág. 145
	350607-2	130.0	1.30	 HAD19038	5 cilindros		
	350607-3	130.0	1.30	HAD19038	MB 0371 - Bus 1926 1985/... 6 cilindros DIESEL		
	350805	99.0	1.40	B350100	MB L608 D/Unimog 1966/...	3786cc. OM 314 85HP Ø97 3971cc. OM 364 90/115HP Ø97.5 (OHV) 8V	350100-R  pág. 126 350800-R  pág. 134
	350805-100	100.00	1.40	 HAD19038	MB 711D - 811D - 609D - 614D - 709D		
	350807	99.0	1.40	HAD19038	809D - OM364 Aspirado 1987/... DIESEL		
	351007	104.0	1.30	B351000	MB Vario 614/814/815/810	4250cc. OM 904 LA - OM 904 LA IMO Electronico 75/125HP Ø102 (OHV) 12V	351000-R  pág. 137
	351008	103.5	1.20	 HAD19038	Atego 712/714/715/717/812/814/815 817/917/1017/1214/1215/1217/1317/1517 DIESEL		
	352008	103.5	1.30	B352000	MB Atego I 925/1225/1228/1325/1328 1525/1528/1823/1828/2523/2528/2628 1998/... DIESEL	6370cc. OM906 LA 18V Electrónico OM906.911/919/920/921/922 923 231/245/279HP Ø102 (OHV) 18V	352000-R  pág. 138
	353008	107.5	1.20	B351000	Unimag U 2002/..., Atego 2 2004/..., Accelo, Atron 2012/... DIESEL	4801cc. OM924.916/920/922/923 924/930 218HP OM924.935/990/999 156HP OM924.989/995 185HP (OHV) 12V Ø106	
	353107	106.5	1.20	B352000	Conecto 2001/..., Tourino 2003/..., Integro 2006/... Atego 2 2017/..., Axor 2 2004/... - 2011/... DIESEL	7201cc. OM926.991/941 256/279HP OM 926.939/994 286HP OM926.926/930/932 305HP OM926.999 310HP OM 926.913/917/919/921/937 945/990 18V 326HP Ø106	
	353108	106.5	1.20	 HAD19038			
	360008	143.5	1.30	B360000	MB 1630 - 1632 - 1633 - MB485.980 MB489.960/961-MB475.907/950 MB954/976/979/982/984/986/989/991 994/997/998 - 5 cilindros O372 - O400 - L1395/1939/1941 1973/... 6 cilindros DIESEL	9973cc. OM449A/LA - HLA 5 10V 180/200HP Ø128 - DIESEL 11967cc. OM 447-6 250/300HP Ø128 (OHV) 12V	360000-R  pág. 141 360300-R  pág. 144
	360107	92.0	1.70	B360100	240D/TD 1973/... - 207/307/407/507/510D L406/407DG - 0309D 1977/... 240GD 1976/87 - MB100/200/300/400 180D/150/170 DIESEL	2404cc. OM 616.912/934/960 65HP OM 616.916/940/961/963 72HP Ø91 (SOHC) 8V	360100-R  pág. 142
	360808	143.0	0.45	B360800	OM457LA/LAIII/HLA/HLA III OM457.933/938/940/944/949 OM458.960/970/980/938CAM O400BUS Camión LS1938 - LK/LS/L2638 Axor 2035/40/44/2540/44/2640/44 3340/44 4140/44 DIESEL	11967cc. OM457 Electrónico 252 - 456PS 24V 355/380HP Ø128 (OHV) 24V	360800-R  pág. 147
	361208	143.0		B361200	Citaro, Travego, Conecto, Axor, Turismo 1998/... DIESEL	11967cc. OM457 - OM458	











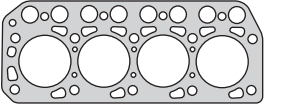

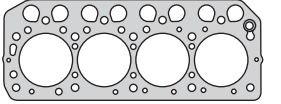

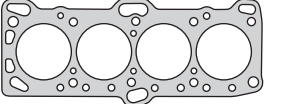

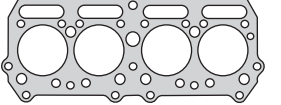

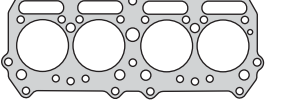
JUNTA TAPA DE CILINDROS

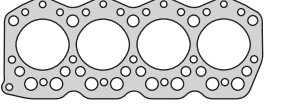
CYLINDER HEAD GASKETS

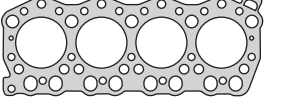
MERCEDES BENZ

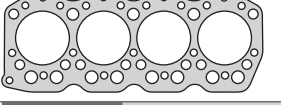
	Código Code	Q	≠	Kit Bulón Bolt Set	Aplicación Application	Motor Engine	Juego
	361308			B361300	Actros MP4 2011/... DIESEL	12809cc. OM471.900 422HP Ø132 (DOHC) 24V	

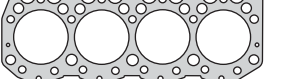









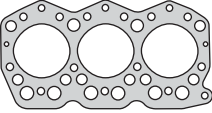

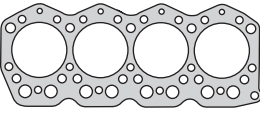

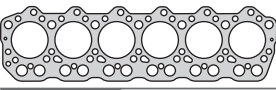

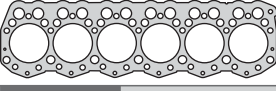

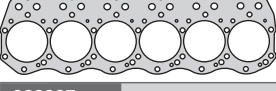

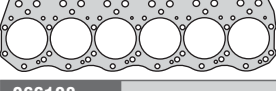

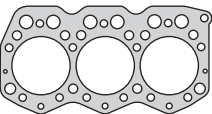
MITSUBISHI

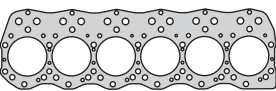
	962807	78.0	1.60		Tractor, Autoelevador DIESEL	1415cc. K4E 8V 33HP Ø77	962800-R  pág. 149
	963107	80.5	1.65		Tractor, Autoelevador DIESEL	1500cc. S4L16/37HP Ø78 (OHV) 8V	963100-R  pág. 150
	964107	87.0	1.70		Tractor, Autoelevador DIESEL	2000cc. 4G63 8V 85	964100-R  pág. 151
	964207	87.0	1.70		Tractor, Canter DIESEL	2084cc. 4DQ5 8V 40HP Ø86	964200-R  pág. 152
	964307	90.0	1.65		Tractor, Canter DIESEL	2080cc. 4DQ7 8V Ø89	964300-R  pág. 153
	964707	96.0	1.70		Tractor, Autoelevador DIESEL	2477cc. S4E 8V Ø95	964700-R  pág. 154
	965108	93.5	1.30		Canter Serie FB3 1985/93 Truck 2.8 Serie FB308 1985/89 DIESEL	2659cc. 4DR51 80HP Ø92 2800cc. 4DR51 Ø92 (SOHC) 8V	965100-R  pág. 155
	965207	101.0	1.75		Tractor, Autoelevador DIESEL	2960cc. S4E2 8V Ø100	965200-R  pág. 156
	965308	95.5	1.00		Tractor, Autoelevador DIESEL	3331cc. S4S 8V	965300-R MLS  pág. 157

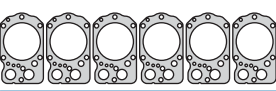
JUNTA TAPA DE CILINDROS

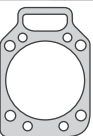
CYLINDER HEAD GASKETS











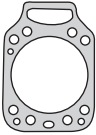

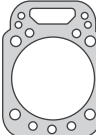



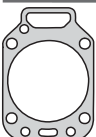

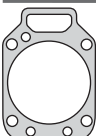
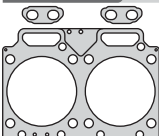

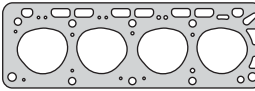
MITSUBISHI

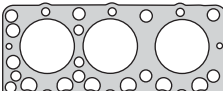
	Código Code	Q	≠	Kit Bulón Bolt Set	Aplicación Application	Motor Engine	Juego
	965407	96.0	1.70		Tractor, Autoelevador DIESEL	3900cc. S6E 12V	965400-R  pág. 158
	965507	103.5	1.70		Tractor DIESEL	4249cc. S4K Ø102	965500-R  pág. 159
	965608	101.5	1.50		Canter 1992/96 DIESEL	4948cc. 6D31T 12V 145HP Ø100	965600-R  pág. 160
	965708	95.5	1.00		Tractor, Autoelevador DIESEL	4996cc. S6S 12V	965700-R MLS  pág. 161
	965907	123.5	2.20		6000 Bus, 6000 Truck 1984/92 (FK115/FK215/FK415/FK425/FK515) DIESEL	6557cc. 6D14T 12V Ø110	965900-R  pág. 162
	966007	126.0	2.30		6900 Bus (MK116F/MM116H/MM516H) 1982/88, 6900 Truck (FK116/FK215/FK216/FK316) 1984/92 DIESEL	6919cc. 6D15 131HP Ø118 (OHV) 12V	966000-R  pág. 163
	966108	103.0	1.30		Tractor, Autoelevador DIESEL	6380cc. S6KT Ø102	966100-R MLS  pág. 164
	966207	119.0	2.10		Bus, Truck (FK416/FK516) 1988/... DIESEL	7545cc. 6D16A Ø118	966200-R  pág. 165
	966308	95.5	2.10		Camión FP418/FV418/FS428 Bus FB418 T850 1988/... DIESEL	11149cc. 6D22T 12V 260/310HP Ø93	966300-R MLS  pág. 166
MWM							
	310407	110.0	1.45	B310400 B310500 B330800  HAS17038	F1000/F4000 1992/96 - F2000 1980/... FB4000 - Escavadora - Cargo F14000/F12000 - Tractor S90 FE105 - FA120 - FE105B - Autoelevador Camión TX 1600 - CHF 44 - E300 1983/... DIESEL	3922cc. D229-4 8V 96HP Ø102 5883cc. D229-6 12V 145/160HP Ø102 2942cc. D229-3 6V 72HP Ø102	310400-R  pág. 167 310500-R  pág. 169 330800-R  pág. 176

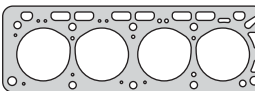
JUNTA TAPA DE CILINDROS

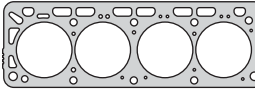









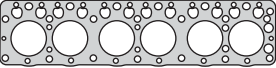

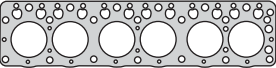

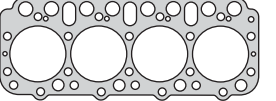

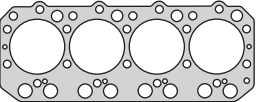
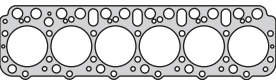
CYLINDER HEAD GASKETS

MWM

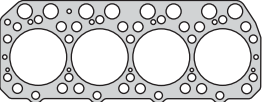
	Código Code	Q	≠	Kit Bulón Bolt Set	Aplicación Application	Motor Engine	Juego
	320407	107.0	1.20		Valmet Tractor 86-ID Camión F4000 1986/... MF Tractor 85 1986/... DIESEL	4156cc. D226-4 82HP Ø105 (OHV) 8V	320400-R  pág. 171
	320807	110.0	1.20		Valmet Tractor 65ID - 62ID 1970/76 Fiat 850E - Valmet Tractor 85ID 1970/76 Dodge Camión 1978/... - Fiat AD7B Fiat 980E/S90 - Valmet Tractor 110ID DIESEL	2550cc. D225-3 50HP Ø95 2977/3400cc. D225-4 68HP Ø95 5100cc. D225-6 102HP Ø95	320800-R  pág. 172 440000  pág. 179 440100-R  pág. 180
	330407	113.4	1.45		Agrale 7000/7500/8500 - Euro I/II/III VW 7100/8120/8140/8150/13150 F14000 1995/98 - Euro I/II VW 13180/15180/16210 DIESEL	4300cc. 4.10 X10/T/TCA 90/167HP 6450cc. 6.10 X10/T/TCA 139/250HP Ø103	330400-R  pág. 173 330700-R  pág. 174
	331008	113.2	1.45		D-226-2 (2 cilindros) DIESEL	2078cc. D-226-2 40HP Ø105	
	331208	113.5	1.30		VW Constellation 13.180E/15.180E Agrale 8500/9200 (4 cilindros) VM210/260/310 - VW26.260E/31.260E VW17.260EOT/17.210EOD (6 cilindros) DIESEL	4800cc. 4.12TCE 8V 150/180HP Ø105 7118cc. 6.12 TCE 210/310HP Ø105 (OHV) 12V	331200-R MLS  pág. 177 331300-R MLS  pág. 178
NISSAN							
	901907	77.5	1.70		Tractor	1500cc. H15 8V Ø76	901900-R  pág. 181
	902007	85.5	1.70		Tractor, Autoelevador DIESEL	1500cc. SD15 6V Ø83 1600cc. SD16 6V Ø83	902000-R  pág. 182
	904907	89.5	1.70		Autoelevador 1983/... DIESEL	1982cc. H20-II 92HP Ø87.2 (DOHC) 8V	904900-R  pág. 183
	905907	94.0	1.70		Tractor, Autoelevador DIESEL	2472cc. H25 (DOHC) 8V 62HP Ø92	905900-R  pág. 184
	906708	97.0	1.25		Tractor 1992/..., Condor 1992/94 Trade 1993/96, Cabstar 1998/01 DIESEL	3000cc. BD30 8V 86HP Ø96 3000cc. BD30-Ti 8V 86HP Ø96	906700-R MLS  pág. 185 906800-R MLS  pág. 186

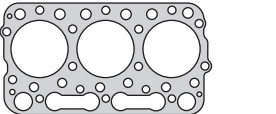
JUNTA TAPA DE CILINDROS

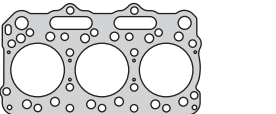
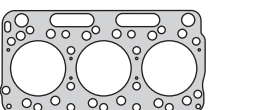
CYLINDER HEAD GASKETS

NISSAN							
	Código Code	Q	≠	Kit Bulón Bolt Set	Aplicación Application	Motor Engine	Juego
	907007	85.5	1.30		Truck 1980/..., Patrol 1982/89 DIESEL	3246cc. SD33 95/100HP Ø83 (OHV) 12V	907000-R  pág. 187
	907108	86.0	1.40		Truck 1986/..., Patrol 1983/... DIESEL	3246cc. SD33T 115HP Ø83 (OHV) 12V	907100-R MLS  pág. 188
	907208	110.0	1.60		Atlas 1984/86, Truck 1984/... Atlas 1983/86, Civilian 1984/88, Truck 1984/... DIESEL	3298cc. FD33 8V 99HP Ø108 3298cc. FD33T 8V 118HP Ø108	907200-R  pág. 189 907300-R  pág. 190
	907308	110.0	1.60		Truck 3500, Atlas 1986/91 DIESEL	3460cc. FD35T Ø102,5	
	907408	110.5	1.60		Camión 5700 1978/... Camión 5700 1980/... Camión 5700 1975/83 DIESEL	5654cc. ED6 (SOHC) 12V Ø109 5654cc. FD6 12V 170HP Ø108 5654cc. FD6T 12V 175HP Ø108	907400-R  pág. 191 908200-R  pág. 194 908300-R  pág. 195
	907808	110.5	1.50		Atlas, Condor 1993/... Atlas, Condor 1995/... DIESEL	4214cc. FD42 8V 123HP Ø109 4617cc. FD46 8V 133HP Ø109 4617cc. FD46 (DOHC) 8V 113HP Ø109	907800-R MLS  pág. 192 907900-R MLS  pág. 193
	908408	113.5	1.95		Camión, Bus 1977/... DIESEL	6842cc. ND6 133HP Ø110 (SOHC) 12V	908400-R  pág. 196
	908508	122.5	1.60		Camión, Bus 1992/95 DIESEL	9160cc. NF6T 12V 300HP Ø120	908500-R MLS  pág. 197
	908608	128.5	1.95		Camión, Bus 1969/... DIESEL	10308cc. PD6 200/300HP Ø125 (SOHC) 12V	908600-R  pág. 198
	908707	129.0	1.60		Camión, Bus 1970/... DIESEL	10308cc. PD6T 260/300HP Ø127 (SOHC) 12V	908700-R  pág. 199

JUNTA TAPA DE CILINDROS

CYLINDER HEAD GASKETS

PERKINS - MASSEY FERGUSON

	Código Code	Q	≠	Kit Bulón Bolt Set	Aplicación Application	Motor Engine	Juego
	280307	105.0	1.80	B280300	MF290/292/610/620 DIESEL	4100cc. P4000-4000T 72/86HP Ø100	401100-R pág. 212
	320407	107.0	1.20		MF Tractor 85 1986/... DIESEL	4156cc. D226-4 82HP Ø105	320400-R pág. 171
	400005 400007 400008	92.5 92.5 92.5	1.40 1.40 1.15	B400000 HAS19038	D100 - D200 1987/... F100 - Falcón 1970/... MF Tractor M165 - 265 F100 DIESEL	3336cc. 4.203-P4-192Z 71HP Ø91.49 3336cc. MF165 - 265 71HP Ø91.49 3336cc. 4.203 Potenciado 71HP Ø91.44	400000-R pág. 201 400700-R pág. 208 410000-R pág. 218
	400005 400007 400008	92.5 92.5 92.5	1.40 1.40 1.15	B400000 HAS19038	MF Potenciado Tractor 8 BR DIESEL	3336cc. MF265 71HP Ø91.44 3336cc. 4.203 - 8 BR Iny. Indirecta 71HP Ø91.49	410300-R pág. 221 420100-R pág. 229
	400107 400108	93.0 93.0	1.40 1.15		DP 400/500 1964/... - F350/600 DIESEL	5004cc. 6.305 Cadenero 100HP Ø91.44 (SOHC) 12V	400100-R pág. 202
	400207 400208	104.0 104.0	1.50 1.30	B400200 HAS19038	DP 600/800 1968/... - F600/700 MF Tractor 1095 - 1098 - 1195 - 1215 MF 1095/1098/1215 1970/... - Grúas Tractores - Estancieros - Rodantes DIESEL	5798cc. 6.354-2 12V 140HP Ø98.47 5798cc. 6.354-2 12V 140HP Ø98.3 5798cc. 6.354-2 12V Turbo Ø98.47	400200-R pág. 203 400800-R pág. 209 401700-R pág. 216
	400307 400308	92.5 92.5	1.40 1.25	B400300 HAS19038	F100 - F350 - F600 1974/... MF Tractor - PF F600 DIESEL	5004cc. 6PF-305 102HP Ø91.44 - 5004cc. 6PF- MF1175 100HP Ø91.44 5004cc. 6PF-305 Pot. 100HP Ø91.49	400300-R pág. 204 400600-R pág. 207 410100-R pág. 219
	400407 400408	104.0 104.0	1.50 1.45	B400200 HAS19038	D600/800 1976/... - F7000 Camiones Pes. y Semipesados MF Tractor 1215 - 1218 DIESEL	5798cc. 6.354-4 Turbo 172HP Ø98.42 5798cc. T6.354-4 172HP Ø98.63	400400-R pág. 205 410400-R pág. 222
	400507 400508	93.0 93.0	1.45 1.45	B400000 HAS19038	Tractor Viñatero MF50 Tractor - MF50X/55X MF135/200/235/250 DIESEL	2362cc. P3 - 152 42HP Ø91.44 2502cc. P3 - 152 42HP Ø91.44	400500-R pág. 206 410200-R pág. 220
	400507 400508	93.0 93.0	1.45 1.45	B400000 HAS19038	MF50/50X/55X/135/200/235/250 MF 135/515 DIESEL	2360cc. 3.152 42HP Ø89 2502cc. 3.152 42HP Ø91.44 (OHV) 6V	420400-R pág. 231

JUNTA TAPA DE CILINDROS

CYLINDER HEAD GASKETS

PERKINS - MASSEY FERGUSON

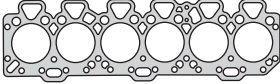
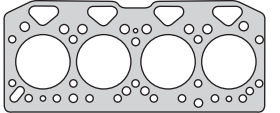
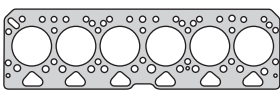
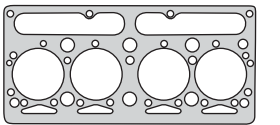
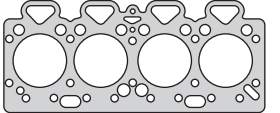
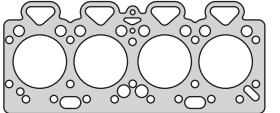
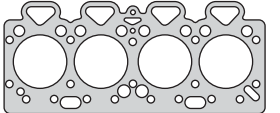
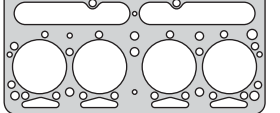
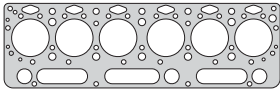
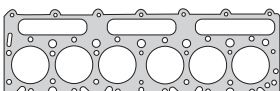
	Código Code	Q	≠	Kit Bulón Bolt Set	Aplicación Application	Motor Engine	Juego
	400907	104.0	1.45	B400200 HAS19038	DP 600/800 - F600/700 DIESEL	5798cc. 6.354-1 135HP Ø98.43 (OHV) 12V	400900-R pág. 210
	401507	105.0	1.50	B401500	Phaser 90 - 4.40 - 110T - T4.40 Phaser 120 Ti - C4.40 MF6130/6140/6150 DIESEL	3990cc. 1004.4/T/TW 86/91HP Ø100 (OHV) 8V	401500-R pág. 213
	401607	105.0	1.50		Phaser 125, MF396/399/630/3085/6160 6170, Phaser 160Ti/180Ti MF660/3114/3125/3625/3635/3655 6189/6190/8110/8120/8130 DIESEL	5985cc. 1006.6/C/T/TW 131/152HP Ø100 (OHV) 12V	401600-R pág. 214
	410505 410507 410508	93.0 93.0 93.0	1.40 1.40 1.50		MF Tractor MF65X, MF40B/65/155/158 165/260/155 MF164C - CBC1000 DIESEL	3330cc. D4.203/AD4.203 Iny. Directa 71HP Ø91.4	410500-R pág. 223
	410605 410607	104.0 104.0	1.70 1.70		GM D20 MF Agrícola - Case 580H MF85 - MF270/275 MF285/290/220/220A - Hyster H110 DIESEL	3860cc. Q20B4 Iny. Dir. 70HP Ø98.4 4070cc. A4 - 248 75HP Ø100	401000-R pág. 211 410700-R pág. 225
	410605 410607	104.0 104.0	1.70 1.70		MF220 - F290 - Tractor MF85X GM D10 - F350 - VW 6.80 - Case 550 DIESEL	3860cc. Q20B4.23670HP Ø98.4 4070cc. 4.248 70HP Ø101 Iny. Directa	410600-R pág. 224
	410605 410607	104.0 104.0	1.70 1.70		Case 580H DIESEL	3860cc. 4.236 70HP Ø98.4 4070cc. 4.248 100HP Ø100 Iny. Directa	420200-R pág. 230
	410807 410808	93.0 93.0	1.40 1.25		Pick Up - Camiones livianos DIESEL	3330cc. T 4.33 Turbo 91/95HP Ø91.46	410800-R pág. 226
	410907	107.0	1.50		GM Brasil D60/D70 - Dodge P700D/P900 F600/750/1100 - MF3366 - F6000 F7500/11000 DIESEL	5840cc. 6-357 Agrícola 91HP Industrial 108HP Ø104.14	410900-R pág. 227
	420007	109.0	1.50		F400/600/7000/11000/12000/13000 MF 400C DIESEL	5840cc. 6-358 Agrícola 118HP Industrial 127HP Ø104.14	420000-R pág. 228

JUNTA TAPA DE CILINDROS

CYLINDER HEAD GASKETS

PERKINS - MASSEY FERGUSON

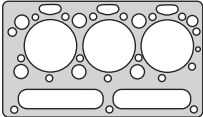
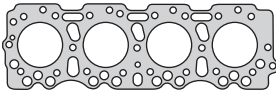
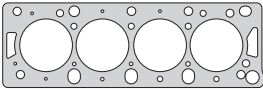
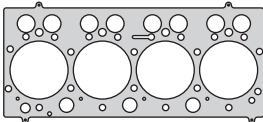
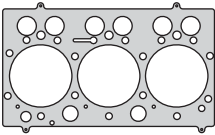
	Código Code	Q	≠	Kit Bulón Bolt Set	Aplicación Application	Motor Engine	Juego
	420205	93.0	1.40		MF133/135/230/235/240/254/353 Industrial MF40 - Agrícola DIESEL	2500cc. D3.152-D3.152/2 G3.152-D3.152/4 Iny. Dir. 100HP Ø91.40 (OHV) 8V	422000-R pág. 233
	420508	112.0	1.20		D170 - P 200/260/270/320 - MF RX 100T	8850cc. 510 -540 V8 170/183HP Ø108	
	420607	86.0	1.50	B420600	Rover - Maestro D/TD - Perkins Marino 4.20 D/TD Leyland Sherpa 185/200/215/220 230/240/255 1986/94 Daf Ka 200/VS 200 1986/... DIESEL	1994cc. Prima 65/80T Leyland Prima 65 Daf TN 44 64/80HP Ø84.45	420600-R pág. 232
	423107 423108	121.0 121.0	1.30 1.10		MF4292, MF4297, Challenger DIESEL	4400cc. 420DS Agco Sisu Power 106/116/110/117/120/129HP Ø108	423101-R pág. 02
	423207 423208	121.0 121.0	1.30 1.10		MF Case-IH CS 68/75 Challenge (3 cilindros) MF Case-IH CS/CVX120/130/150 CVX1135/1145/1155/1170/1190 Optima 440F Challenger - MT560B/570B 590B/MF7140 - (6 cilindros) DIESEL	3300cc. 320D/DS 33/69HP Ø108 6600cc. 620D/DS 147/189HP Ø108	423001-R pág. 01 423201-R pág. 03

SCANIA

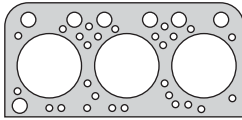
	810007 810008	144.0 144.0	1.40 1.80		Camión - Omnibus L75/76/L/LB/LBS110 L/LB/LS/LT/LBS/LBT111 DIESEL	11020cc. D11 - DS11 280/333HP Ø127 (OHV) 12V	810000-R pág. 235
	810108	147.0	1.25		LB/LBS110 - L/LS/LT/LBS/LBT111 G/L/R/T112 - P/R113 - P113HK R113HK - T113 - K113CBL - K113GLP K113TLB - K113TLP 1975/... DIESEL	11020cc. D11/DS11/DSC11/DN11 DTC11 272/354HP Ø127 (OHV) 12V	810100-R 810101-R pág. 236
	810208	147.0	0.60		R142, T142, R143, T143 R144, T144 DIESEL	14190cc. D14 - DS14 - DSC14 400/460/500/530HP Ø127 (OHV) V6 16V	810200-R pág. 238
	810308	134.0	1.25		P94, R94 1996/... P94, R94 1996/... DIESEL	9000cc. DSC9 220/310HP Ø115 8974cc. DSC9, DSI9 220/310HP Ø115 (OHV) 12V	810300 pág. 240 810600 pág. 245
	810408	133.0	1.00		Serie 4 - Tractor, Camiones, Bus Series P/G/R/T - Serie K DIESEL	10640cc. DC11.01/02/03/04 11716cc. DC12.01/03/05/06/09 DT12.02/08 (OHV) 24V Ø127 10640cc. DC11.08 11716cc. DC12.06/10/12/13/14 DC12.15/17/18 - DT12.03/6	810400-R MLS pág. 242 810500-R MLS pág. 244

JUNTA TAPA DE CILINDROS

CYLINDER HEAD GASKETS

SCANIA							
	Código Code	Q	≠	Kit Bulón Bolt Set	Aplicación Application	Motor Engine	Juego
	810708	133.0	1.00		Serie 4 Camión, 114C/114L 1994/04 114G 2001/08, 114L/114G 2005/08 Serie 4 Camión P124, R124, T124 96/01 124C, T124C, T124G 1995/08	10640cc. DC11.07 329HP 11700cc. DC12.0 379HP (OHV) 24V Ø127 11716cc. DSC 12.01/02 24V Ø127	810700 pág. 246 810800-R MLS pág. 247
SHANGAI							
	910905	101.0	1.40		Tractor DIESEL	495A Tracción Simple 485A18 Tracción Doble	910900 pág. 249
TOYOTA							
	924408	87.5	0.85		Autoelevador 1995/00 DIESEL	1998cc. 1DZ II 54HP Ø86 (OHV) 8V	924400-R MLS pág. 251
	924508	87.0	1.40		Autoelevador 1998/05 DIESEL	1998cc. 1DZ 52HP Ø86 (OHV) 8V	924500-R MLS pág. 252
	925307	97.5	1.70		Tractor 6F, Autoelevador DIESEL	2953cc. 1Z 5FD/F 59HP Ø96	925300-R pág. 253
	926507	97.5	1.70		Tractor 1988/... DIESEL	4430cc. 11Z Ø96	926500-R pág. 254
VALMET							
	310407	110.0	1.45	B330800 HAS17038	Autoelevador - E300 - Tractor 68 1983/... DIESEL	2942cc. D229-3 72HP Ø102	330800-R pág. 176
	320407	107.0	1.20		Tractor 86-ID DIESEL	4156cc. D226-4 82HP Ø105	320400-R pág. 171
	320807	110.0	1.20		Tractor 65ID - 62ID 1970/76 Tractor 85ID 1970/76 Tractor 110ID DIESEL	2550cc. D225-3 50HP Ø95 2977/3400cc. D225-4 68HP Ø95 5100cc. D225-6 102HP Ø95	320800-R pág. 172 440000 pág. 179 440100-R pág. 180

JUNTA TAPA DE CILINDROS

CYLINDER HEAD GASKETS

VALTRA

	Código Code	Q	≠	Kit Bulón Bolt Set	Aplicación Application	Motor Engine	Juego
423107 - 423108 	423107 423108	121.0 121.0	1.30 1.10		A950 (4x2, 4x4), A990 (4x2, 4x4) BM100 (4x2, 4x4), BM110 (4x2, 4x4) DIESEL	4400cc. 420D/DS Agco Sisu Power 106/116HP Ø108	423101-R 📄 pág. 02
423207 - 423208 	423207 423208	121.0 121.0	1.30 1.10		A65, A75, 305, 355, 365, 405, 455, 465, 555, 565, 600, 700 SISU 320D, 320DS, 836640356 DIESEL	3300cc. 320D/DS 33/69HP Ø108 6600cc. 620D/DS 147/189HP Ø108	4230001-R 📄 pág. 01 4232001-R 📄 pág. 03

VOLARE

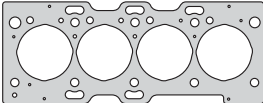
870808 	870808	95.0	1.00		Cinco 2016/... DIESEL	2776cc. ISF2.8 (SOHC) 16V 150/156HP Ø94	870800-R MLS 📄 pág. 28
--	--------	------	------	--	---------------------------------	--	----------------------------------

VOLKSWAGEN

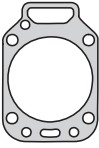
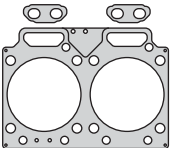
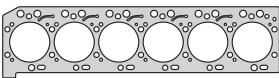
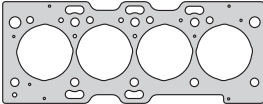
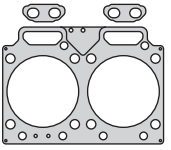
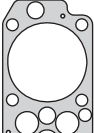
330407 	330407	113.4	1.45		7100/8120/8140/8150/13150 13180/15180/16210 DIESEL	4300cc. 4.10 X10 90HP - 4.10T 133HP 4.10TCA 167HP Ø103 6450cc. 6.10 X10 139HP - 6.10T 201HP 6.10TCA 250HP Ø103	330400-R 📄 pág. 173 330700-R 📄 pág. 174
331208 	331208	113.5	1.30		Constellation 13.180E/15.180E 26.260E/31.260E/17.260EOT/17.210EOD DIESEL	4800cc. 4.12TCE Commom Rail 150/180HP Ø105 7118cc. 6.12 TCE 210/260/310HP Common Rail Ø105	331200-R MLS 📄 pág. 177 331300-R MLS 📄 pág. 178
870607 	870607	123.5	1.80	B870200	17220/17300/17310/18310/19320 26320/17250E/19320E/24250E Bus 17260EOT/18320EOT 2003/... DIESEL	8270cc. ISCe6 24V 315HP Ø114	870600-R 📄 pág. 26
870808 	870808	95.0	1.00		Delivery 4-150, 6-150 DIESEL	2776cc. ISF2.8 (SOHC) 16V 150HP Ø94	870800-R 📄 pág. 28
331208 	331208	113.5	1.30		VM210/260/310 - (6 cilindros) DIESEL	7118cc. 6.12 TCE 210/260/310HP Common Rail Ø105	331300-R MLS 📄 pág. 178
880008 	880008	136.5	1.40		B58, B10M 1987/... N10 1985/89 DIESEL	9600cc. THD 101KC 273/310HP Ø120.6 9600cc. TD 100G/101G/101F Ø120.6 (OHV) 12V	880000-R 📄 pág. 255 880300-R 📄 pág. 261

JUNTA TAPA DE CILINDROS



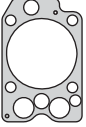
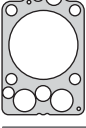
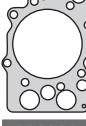
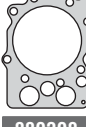
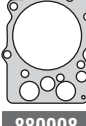
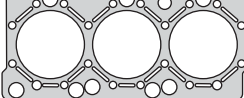

CYLINDER HEAD GASKETS

VOLVO

	Código Code	Q	≠	Kit Bulón Bolt Set	Aplicación Application	Motor Engine	Juego
	880008	136.5	1.40		NL10 1998/... NL10 1989/97 DIESEL	9600cc. EDC Ø120.6 - DIESEL 9600cc. TD 102F/102FS 234/317HP Ø120.6	880500-R pág. 265 880600-R pág. 267
	880108	130.0	1.40		B58 1980/85 N10 1980/85 DIESEL	9600cc. THD 100D 230/260HP Ø120.6 9600cc. TD 100A 230/260HP Ø120.6 (OHV) 12V	880100-R pág. 257 880200-R pág. 259
	880208	140.0	1.40		N12 1980/89 DIESEL	11950cc. TD 121G/120GA 295/360HP 121F 328/385HP Ø130.2 (OHV) 12V	
	880308	147.5	1.40	B800400 HAS21038	NL12 1980/89 DIESEL	11950cc. TD 121G/120GA/121F Ø130.2 (OHV) 12V	880400-R pág. 263
	880308	147.5	1.40	B800400 HAS21038	NL12 1997/... NL12 1989/96	11950cc. EDC Ø120.6 11950cc. TD 122FS 396HP Ø130.2	880700-R pág. 269 880800-R pág. 271
	880908	119.0	1.40		Metrobus 7700 1998/..., FL7 FL 7/230 245/260 1985/99, FL7 FL 7/285/290 1993/99, FM7 FM 7/250/290 1998/01, FS7 FS 718/230 1994/96 DIESEL	6725cc. TD71F/FA/FAQ/FC/FCQ/FD FQ/FS/FSQ/G/E/FSO 230/245HP TD73E/ES 230/260HP D7A/B 260/285HP D7C 275HP Ø104.8	

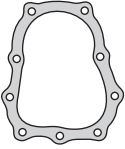
MOTORES ESTACIONARIOS - STANDSTILL ENGINE

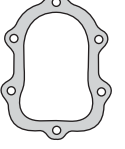
MOTORES GASOLINA - GASOLINE ENGINES

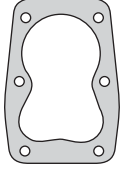
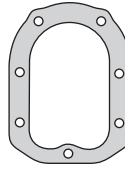
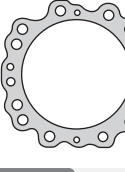
	Motor LA 85 9HP Ø de Boca 84 OE		Motor LA 60 Ø de Boca 95 OE		Motor 14HP Ø de Boca 96 OE
960566 LOMBARDINI JTC	960567 LOMBARDINI JTC	960568 ORIPON JTC			
	Motor 124/1-130T 25HP Ø de Boca 60 OE		Motor 240V 3HP 4.5HP Ø de Boca 70 OE		Motor 8HP 401/1 16HP Ø de Boca 85 OE
960569 VILLA JTC	960570 VILLA JTC	960571 VILLA JTC			
	Motor LA 85 9HP Ø de Boca 258.5 OE				
960574 WUAKESHA JTC					

MOTORES DIESEL - DIESEL ENGINES

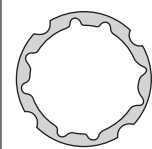
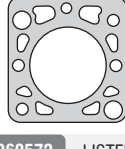
	Motor 23A Ø de Boca 180 OE
960557 DIAR JTC	
	Motor 5HP - 6HP Ø de Boca 118 OE
960572 LISTER JTC	



taranto



HAB12075

BARRA DE EXTENSION CON LUZ LED

Práctica barra de extensión con encastre de 1/2 x 75mm. Para trabajar en lugares oscuros. Superbrillante y potente luz led con baterías alojadas en el interior de la barra.



KIT HAK12-38 Taranto.

Práctico Juego de llaves especiales para motor.

- ▶ Contiene todos los tipos y medidas de herramientas necesarios para el trabajo sobre vehículos de última generación.
- ▶ Posee tubos y tubos con punta de alta resistencia son fabricados en acero cromo vanadio con doble cromado y moleteados para mejorar el agarre.
- ▶ Encastre de 12.7 mm. Con espacio para bola de retención.



HERRAMIENTAS ESPECIALES PARA MOTOR

SET OF SPECIAL AUTOMOTIVE TOOLS

KIT HAK12-38



FORMACION DEL CODIGO DE ARTICULO

H	A	T	5	5	0	5	5
LINEA		TIPO	MEDIDA		LARGO HERRAMIENTA		

LINEA

HA: Herramienta de ajuste

TIPOS DE LLAVE

D: Tubo Estriado
S: Tubo Hexagonal
B: Barra de Extensión

E: Tubo Torx Hembra
N: Tubo con Punta Estriado
R: Tubo con Punta Ribe
T: Tubo con Punta Torx

KIT HAK 12-38 - 38 PIEZAS ENCASTRE DE 12.7mm (1 2")

CANT.	CONTENIDO	TUBOS HEXAGONALES	CODIGO	DESCRIPCION	D (mm)	L (mm)
9	TUBOS HEXAGONALES 12,13,14,15,17,19,21,24,27mm		HAS12038	HEXAGONAL 12mm	22	38
5	TUBOS ESTRIADOS 10,12,14,17,19mm		HAS13038	HEXAGONAL 13mm	22	38
6	TUBOS TORX HEMBRA E10,E12,E14,E16,E18,E20		HAS14038	HEXAGONAL 14mm	22	38
5	TUBOS CON PUNTA TORX T55X55,T55X100,T60X55,T60X100,T70X100mm		HAS15038	HEXAGONAL 15mm	22	38
5	TUBOS C/ PUNTA ESTRIADA M9X100,M10X55,M10X100,M12X55,M12X100mm		HAS17038	HEXAGONAL 17mm	24	38
3	TUBOS CON PUNTA RIBE R10X168,R12X63,R14X63mm.		HAS19038	HEXAGONAL 19mm	26	38
5	TUBOS CON PUNTA HEXAGONAL H8X55,H8X90,H8X120,H10X55,H10X140mm.		HAS21038	HEXAGONAL 21mm	28	38
			HAS24038	HEXAGONAL 24mm	32	38
			HAS27038	HEXAGONAL 27mm	36	42

TUBOS ESTRIADOS	CODIGO	DESCRIPCION	D (mm)	L (mm)
	HAD10038	ESTRIADO 10mm	22	38
	HAD12038	ESTRIADO 12mm	22	38
	HAD14038	ESTRIADO 14mm	22	38
	HAD17038	ESTRIADO 17mm	24	38
	HAD19038	ESTRIADO 19mm	26	38

TUBOS TORX	CODIGO	DESCRIPCION	D (mm)	L (mm)
	HAE10038	TORX Hembra E10	23	38
	HAE12038	TORX Hembra E12	23	38
	HAE14038	TORX Hembra E14	23	38
	HAE16038	TORX Hembra E16	23	38
	HAE18038	TORX Hembra E18	23	38
	HAE20038	TORX Hembra E20	24	38

TUBOS CON PUNTA TORX	CODIGO	DESCRIPCION	D (mm)	L (mm)
	HAT55055	Punta TORX T55 x 55mm	24	55
	HAT55100	Punta TORX T55 x 100mm	24	100
	HAT60055	Punta TORX T60 x 55mm	24	55
	HAT60100	Punta TORX T60 x 100mm	24	100
	HAT70100	Punta TORX T70 x 100mm	24	100

TUBOS CON PUNTA ESTRIADA	CODIGO	DESCRIPCION	D (mm)	L (mm)
	HAN09100	Punta EST. M9 x 100mm	24	100
	HAN10055	Punta EST. M10 x 55mm	24	55
	HAN10100	Punta EST. M10 x 100mm	24	100
	HAN12055	Punta EST. M9 x 100mm	24	55
	HAN12100	Punta EST. M12 x 55mm	24	100

TUBOS CON PUNTA RIBE	CODIGO	DESCRIPCION	D (mm)	L (mm)
	HAR10168	Punta RIBE R10 x 168mm	24	168
	HAR12063	Punta RIBE R12 x 63mm	24	63
	HAR14063	Punta RIBE R14 x 63mm	24	63

TUBOS CON PUNTA HEXAGONAL	CODIGO	DESCRIPCION	D (mm)	L (mm)
	HAH08055	Punta HEX. H8 x 55mm	24	55
	HAH08090	Punta HEX. H8 x 90mm	24	90
	HAH08120	Punta HEX. H8 x 120mm	24	120
	HAH10055	Punta HEX. H10 x 55mm	24	55
	HAH10140	Punta HEX. H10 x 140mm	24	140

BARRA DE EXTENSION CON LUZ LED - ENCASTRE 12.7mm (1 2")

BARRA CON LUZ	CODIGO	DESCRIPCION	D (mm)	L (mm)
	HAB12075	Barra de extensión 1/2" x 75 mm - con luz led	12.7	75

Práctica barra de extensión con encastrado de 1 2" x 75mm. Para trabajar en lugares oscuros!

Super brillante y potente luz LED con baterías alojadas en el interior de la barra.

3 baterías de repuesto incluidas en el kit.

AGCO/SISU



Motor/Engine	Cm³	HP	Ø
320D/DS Agco Sisu Power	3300	33/69	108
DIESEL			

M. Ferguson: Case-IH CS 68/75 - Challenger
Valtra: A65/A75/305/355/365/405/455
 465/555/565/600/700



Nº OE	Descripción/Description	Mat.	Ref.
	Jgo. de juntas para motor	●	423001-R
	Junta tapa cilindros Ø 121.0 ± 1.30	NFT	423207
	Junta tapa cilindros Ø 121.0 ± 1.10	MLS	423208
	Junta tapa válvulas	CG	1 423210
	Junta para cárter	CG	1 423011
	Tapa distribución	NB	1 423112
	Placa distribución	NB	1 423113
	Bomba de agua	NB	1 423214
	Múltiple admisión	NB	1 423217
	Salida de escape	NFT	1 423218
	Junta bomba combustible	NB	1 423228
	Bomba de agua a block	NB	1 423231
	Junta	NB	1 423234
	Junta	NB	1 423235
	Junta	AC	1 423242
	Junta	NB	423143
	Junta	NB	1 423144
	Junta	NB	1 423244
	Junta	NB	1 423145
	Junta	NB	1 423245
	Junta base bomba inyectora	NB	1 423146
	Junta	NB	1 423246
	Junta	NB	1 423247
	Junta	NB	1 423248
	Junta	CG	1 423148
	Junta	NB	1 423149
	Junta	NB	1 423262
	Junta	NB	1 423263
	Arandela A 18 x 22 x 1.5 C	CU	5
	Arandela A 24 x 29 x 2 C	CU	1
	Arandela A 10 x 20 x 2 C	CU	3
	Arandela A 10 x 14 x 1 C	CU	4
	Arandela A 13 x 17 x 1.5 C	CU	1
	Arandela A 14 x 18 x 1.5 C	CU	1
	O'ring G 48 x 3	GS	1
	O'ring G 29 x 3	GS	1
	O'ring G 10 x 21 x 8	GS	2
	O'ring G 19.7 x 27.7 x 6.8	GS	3
614500002	Retén bancada 110 x 140 x 12	VF	1 R423111VF
836673387	Retén distribución 58 x 80 x 12	VF	1 R423112VF

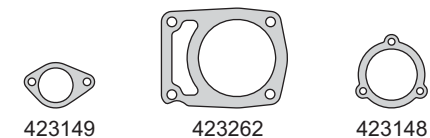
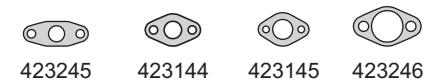
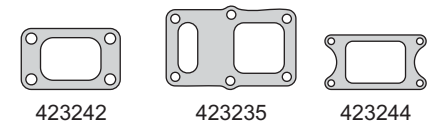
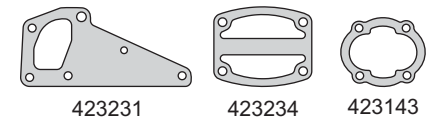
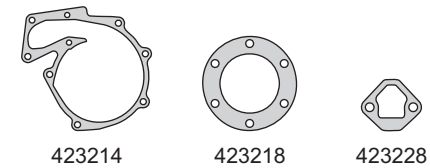
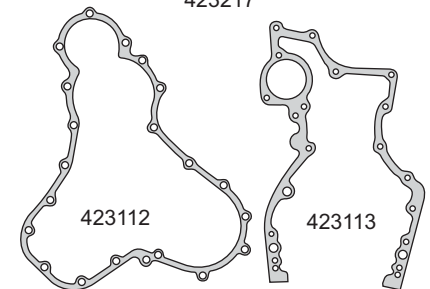
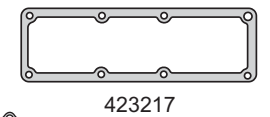
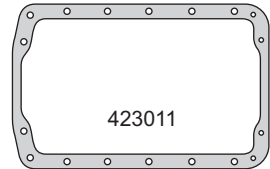
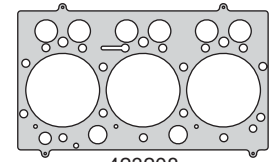

AGCO/SISU



Motor/Engine	Cm³	HP	Ø
420D/DS Agco Sisu Power	4400	106/129	108

M. Ferguson: MF4292, MF4297 - Challenger
Valtra: A950/A990 (4x2, 4x4)
 BM100/BM110 (4x2, 4x4)



DIESEL

Nº OE	Descripción/Description	Mat.	Ref.
	Jgo. de juntas para motor	●	423101-R
	Junta tapa cilindros Ø 121.0 \pm 1.30	NFT	423107
	Junta tapa cilindros Ø 121.0 \pm 1.10	MLS	423108
	Junta tapa válvulas	CG	1 423110
	Junta para cárter	CG	1 423111
	Tapa distribución	NB	1 423112
	Placa distribución	NB	1 423113
	Múltiple admisión	NB	1 423117
	Bomba de agua	NB	1 423114
	Salida de escape	NFT	1 423118
	Bomba de agua a block	NB	1 423131
	Junta	NB	423143
	Junta	NB	1 423149
	Base bomba inyectora	NB	1 423146
	Junta	NB	3 423144
	Junta	NB	1 423145
	Junta	CG	1 423148
	Junta	NB	1 423165
836647502	Sello camisa cilindros G 113.89 x 3.53	GS	6
	Anillo G 20 x 27.5 x 7	GS	
	Anillo G 9.5 x 21.2 x 8	GS	
	O´ring G 15.5 x 2.6	GS	1
	O´ring G 24 x 5	GS	1
	O´ring G 35 x 4	GS	1
	O´ring G 110.72 x 3.53	GS	4
	Arandela A 18 x 22 x 1.5 C	CU	8
	Arandela A 10 x 20 x 2 C	CU	4
	Arandela A 14 x 18 x 1.5 C	CU	1
	Arandela A 10.3 x 13.3 x 1 C	CU	
	Arandela A 12.5 x 17 x 1.5 C	CU	2
	Arandela A 7 x 11 x 1.5 C	CU	1
	Arandela A 8.5 x 11 x 1 C	CU	1
	Arandela A 6.5 x 10 x 1 C	CU	10
614500002	Retén bancada 110 x 140 x 12	VF	1 R423111VF
836673387	Retén distribución 58 x 80 x 12	VF	1 R423112VF

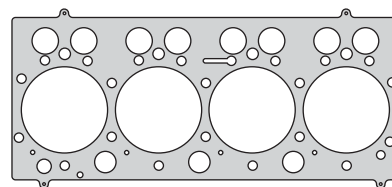

423108



423110

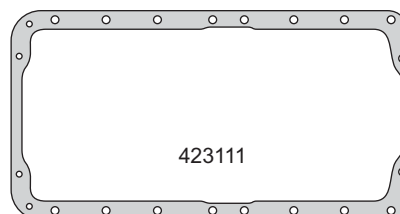

423111

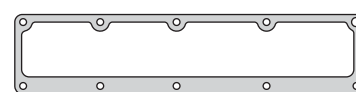

423117

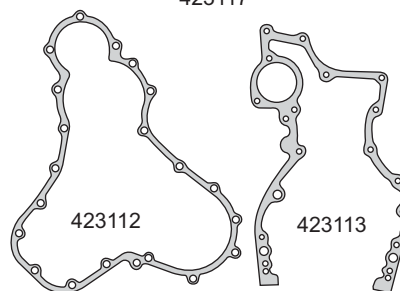

423112

423113

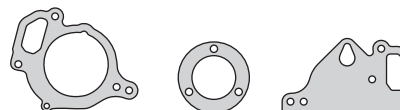

423114

423118

423131

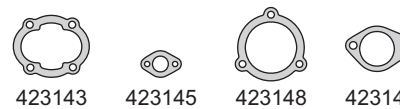

423143

423145

423148

423149



423146

423144

423165

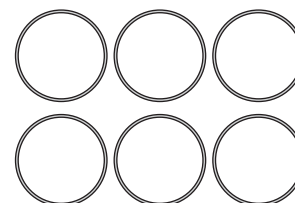

G 113.89 x 3.53



G 110.72 x 3.53



R423111VF



R423112VF

AGCO/SISU



Motor/Engine	Cm³	HP	Ø
620D/DS Agco Sisu Power	6600	147/189	108
DIESEL			

M. Ferguson: Case-IH CS/CVX120/130/150
CVX1135/1145/1155/1170/1190
Optima 440F Challenger
MT560B/570B/590B/MF7140

Valtra: 8000



Nº OE	Descripción/Description	Mat.	Ref.
	Jgo. de juntas para motor	●	423201-R
	Junta tapa cilindros Ø 121.0 ± 1.30	NFT	423207
	Junta tapa cilindros Ø 121.0 ± 1.10	MLS	423208
	Junta tapa válvulas	CG 2	423210
	Junta para cárter	CG 1	423211
	Tapa distribución	NB 1	423112
	Placa distribución	NB 1	423113
	Bomba de agua	NB 1	423214
	Múltiple admisión	NB 2	423217
	Salida de escape	NFT 1	423218
	Junta bomba combustible	NB 1	423228
	Bomba de agua a block	NB 1	423231
	Junta	NB 1	423234
	Junta	NB 1	423235
	Junta	AC 1	423242
	Junta	NB	423143
	Junta	NB 1	423144
	Junta	NB 1	423244
	Junta	NB 1	423245
	Junta base bomba inyectora	NB 1	423146
	Junta	NB 1	423246
	Junta	NB 1	423247
	Junta	NB 2	423248
	Junta	CG 1	423148
	Junta	NB 1	423149
	Junta	NB 1	423262
	Junta	NB 1	423263
	Arandela A 18 x 22 x 1.5 C	CU 10	
	Arandela A 24 x 29 x 2 C	CU 1	
	Arandela A 10 x 20 x 2 C	CU 6	
	Arandela A 10 x 14 x 1 C	CU 8	
	Arandela A 13 x 17 x 1.5 C	CU 3	
	Arandela A 14 x 18 x 1.5 C	CU 1	
	O'ring G 48 x 4	GS 1	
	O'ring G 29 x 3	GS 1	
	O'ring G 10 x 21 x 8	GS	
	O'ring G 19.7 x 27.7 x 6.8	GS	
614500002	Retén bancada 110 x 140 x 12	VF 1	R423111VF
836673387	Retén distribución 58 x 80 x 12	VF 1	R423112VF

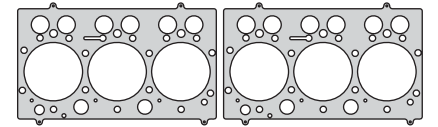

423208

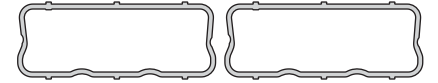

423210

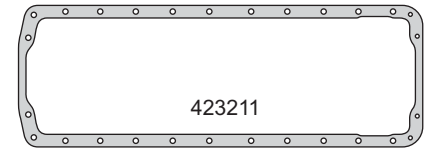

423211

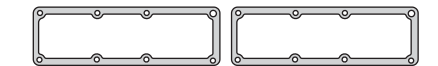

423217

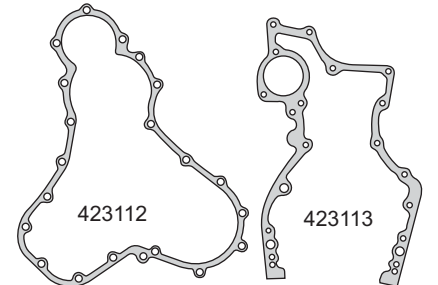

423112

423113

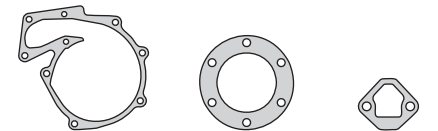

423214

423218

423228

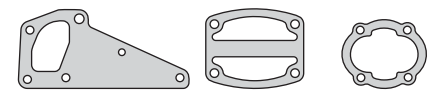

423231

423234

423143

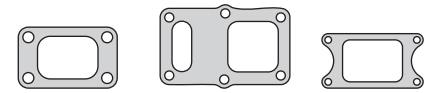

423242

423235

423244

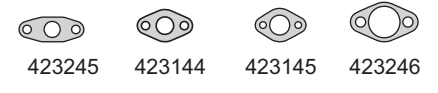

423245

423144

423145

423246

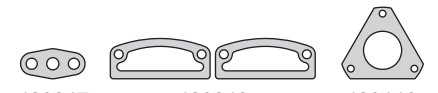

423247

423248

423146



423149

423262

423148



423263



R423111VF

R423112VF



taranto



Paso a Paso



Lubricar las roscas y debajo de la cabeza del tornillo

Seguir la especificación Taranto incluida en cada caja de tornillos, generalmente el ajuste inicial se da con torquimetro.

Realizar el apriete final según lo especificado en la ficha de ajuste. Para la generalidad de los motores modernos el apriete es angular.

RECUERDE... Siempre que se realiza un cambio de Junta y se aprieta la Tapa de Cilindros con un ajuste angular, se deben cambiar los tornillos de fijación, para asegurar así un correcto funcionamiento de la pieza.

Tornillos de Tapa de Cilindros Taranto.

Las consecuencias de NO cambiar los Tornillos de Tapa de Cilindros son más costosas que reemplazarlos. No lo dude!!!

- ▶ Indispensable para el buen funcionamiento del motor.
- ▶ Diseñados para resistir el estiramiento.
- ▶ Resisten altas temperaturas y presiones, característica de los motores modernos de alta performance.



BEDFORD



Motor/Engine	Cm³	HP	Ø
300D	4927	97	98.3

Chevrolet: J6 1961/71



DIESEL

Nº OE	Descripción/Description	Mat.	Ref.
	Jgo. de juntas para motor		● 210000-R
6397318	Junta tapa cilindros Ø 101.0 ± 1.85	FCH	1 210005
7137894	Junta tapa válvulas superior	CG	1 210010
7075064	Junta para cárter	CG	1 210011
6322449	Tapa distribución	CG	1 210012
6322652	Placa distribución	NB	1 210013
7126032	Bomba de agua	NB	1 210014
9309	Jgo. múltiple escape (4)	NFT	1 210016
7135808	Múltiple admisión	NB	1 210017
7115805	Salida de escape	FCH	1 210018
7126030	Bomba de agua a block	NB	1 210019
7143019	Bomba aceite a block	NB	1 210027
6303254	Tapa termostato	NB	1 210032
7075136	Codo agua	CB	1 210033
1530250	Tapa filtro aceite	CG	1 210035
7133433	Tapa válvula lateral	CG	1 210036
6337135	Tapa trasera bomba vacío	NB	1 210037
6353757	Placa bomba vacío	NB	1 210038
6353753	Extremo mando bomba vacío	NB	1 210039
7140434	Placa tapa superior bomba	NB	1 210040
7140429	Cuerpo válvula entrada	NB	1 210041
6322449	Tapa distribución	CGT	210045
	Comando bomba combustible	NB	1 400146
	Jgo. juntas depresor (5)	VS	1 210047
7137885	Buje placa distribución	GS	2 210048
	Jgo. juntas caja velocidades FAE 5ta.	VS	210150
	Jgo. juntas caja velocidades VAUXHALL	VS	210350
	Jgo. juntas retén bancada cigüeñal (2)	SNA	210058
	Núcleo diferencial EATON 162	NB	350368
	Tapa diferencial EATON 162 A y B	CG	350369
	Jgo. suplemento camisa cilindros (0.07) (6)	CU	1 210170-0.07
	Jgo. suplemento camisa cilindros (0.10) (6)	CU	210170-0.10
	Arandela tapón cárter A 18 x 23 x 1,5 C	CU	
	Kit de retenes completo		R210000
	Jgo. retén válvulas (12)	P	1 R300010P
	Retén bancada 118 x 143 x 13	N	1 R210011N
	Retén distribuidor 49.2 x 65.09 x 12.70	N	1 R210012N

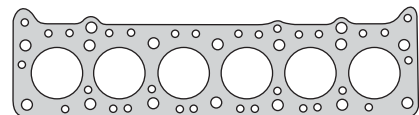

210005



210010

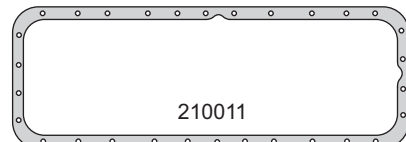

210011

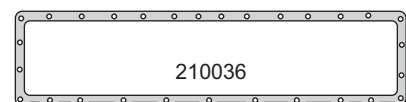

210012

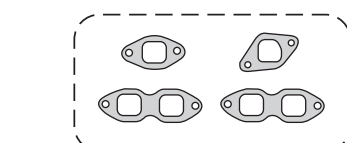

210013



210014

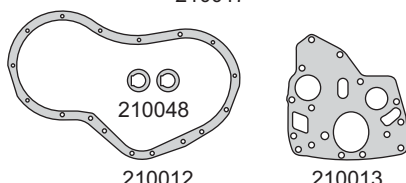

210016



210017

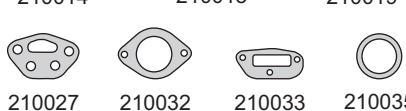

210018

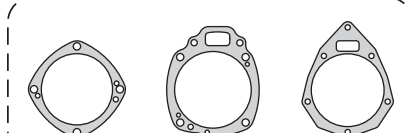

210019

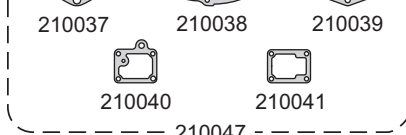

210027

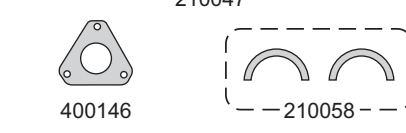

210032



210033

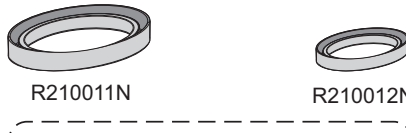

210035

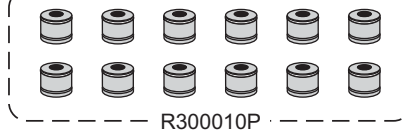

210037



210038

210039

210040

210041

210047

400146

210058

210070-0.07

R210011N

R210012N

R300010P

BEDFORD



Motor/Engine	Cm³	HP	Ø
350D - CD600	5755	137	106.4

Chevrolet: 350H, C60, 714 1971/79

DIESEL



Nº OE	Descripción/Description	Mat.	Ref.
	Jgo. de juntas para motor		210100-R
6397318	Junta tapa cilindros Ø 110.0 ±1.90	FCH 1	210105
7137894	Junta tapa válvulas	CG 1	210010
7075064	Junta para cárter	CG 1	210011
6322449	Tapa distribución	CG 1	210012
6322652	Placa distribución	NH 1	210013
7126032	Bomba de agua	NH 1	210014
9309	Jgo. múltiple escape (4)	NFT 1	210016
7135808	Múltiple admisión	NH 1	210017
7115805	Salida de escape	FCH 1	210018
7126030	Bomba de agua a block	NH 1	210019
7143049	Bomba aceite a block	NH 1	210027
6303254	Tapa termostato	NH 1	210032
7075136	Codo agua	CB 1	210033
1530250	Tapa filtro aceite	CG 1	210035
7133433	Tapa válvula lateral	CG 1	210036
6337135	Tapa trasera bomba vacío	NH 1	210037
6353757	Placa bomba vacío	NH 1	210038
6353753	Extremo mando bomba vacío	NH 1	210039
7140434	Placa tapa superior bomba	NH 1	210040
7140429	Cuerpo válvula entrada	NH 1	210041
6322449	Tapa distribución	CGT	210045
	Comando bomba combustible	NB 1	400146
	Jgo. juntas depresor (5)	VS 1	210047
	O´ring paso aceite tapa cilindros G 18.64 x 3.53	GS 2	210147
7137885	Buje placa distribución	GS 2	210048
	O´ring paso aceite tapa cilindros G 13.87 x 3.53	GS 1	210148
	Jgo. juntas caja velocidades FAE 5ta.	VS	210150
	Jgo. juntas retén bancada cigüeñal (2)	SNA	210058
	Núcleo diferencial EATON 162	NB	350368
	Tapa diferencial EATON 162 A y B	CG	350369
	Jgo. suplemento camisa cilindros (0.07) (6)	CU 1	210170-0.07
	Jgo. suplemento camisa cilindros (0.10) (6)	CU	210170-0.10
	Arandela tapón cárter A 18 x 23 x 1.5 C	CU	
	Kit de retenes completo		R210000
	Jgo. retén válvulas (12)	P 1	R300010P
	Retén bancada 118 x 143 x 13	N 1	R210011N
	Retén distribución 49.2 x 65.09 x 12.7	N 1	R210012N

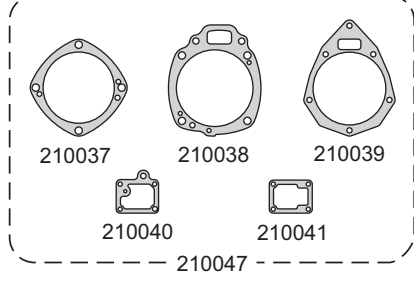
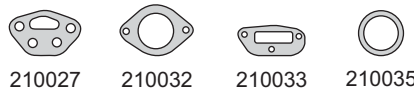
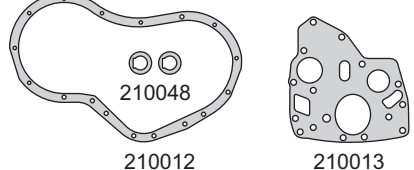
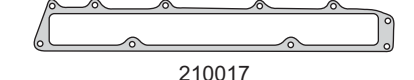
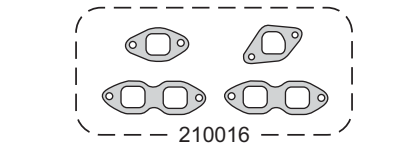
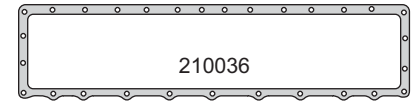
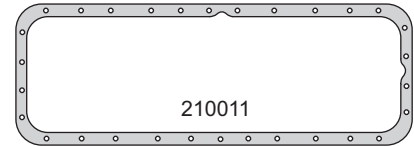
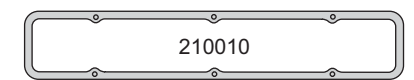
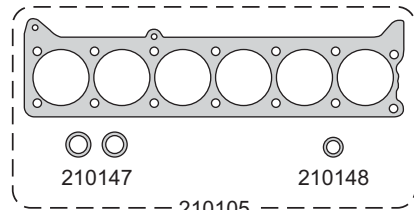

BEDFORD



Motor/Engine **300DX** **4927** **97** **98.3**

Chevrolet: C50 Turbo 1971/79

DIESEL



Nº OE	Descripción/Description	Mat.	Ref.
	Jgo. de juntas para motor		210200-R
2637405	Junta tapa cilindros Ø 101.0 ± 1.90	FCH 1	210205
7137894	Junta tapa válvulas	CG 1	210010
7075064	Junta para cárter	CG 1	210011
6322449	Tapa distribución	CG 1	210012
6322652	Placa distribución	NB 1	210013
7126032	Bomba de agua	NB 1	210014
9309	Jgo. múltiple escape (4)	NFT 1	210016
7135808	Múltiple admisión	NB 1	210017
7115805	Salida de escape	FCH 1	210018
7126030	Bomba de agua a block	NB 1	210019
7143049	Bomba aceite a block	NB 1	210027
6303254	Tapa termostato	NB 1	210032
7075136	Codo agua	CB 1	210033
1530250	Tapa filtro aceite	CG 1	210035
7133433	Tapa válvula lateral	CG 1	210036
6337135	Tapa trasera bomba vacío	NB 1	210037
6353757	Placa bomba vacío	NB 1	210038
6353753	Extremo mando bomba vacío	NB 1	210039
7140434	Placa tapa superior bomba	NB 1	210040
7140429	Cuerpo válvula entrada	NB 1	210041
6322449	Tapa distribución	CGT	210045
	Comando bomba combustible	NB 1	400146
	Jgo. juntas depresor (5)	VS 1	210047
	O´ring paso aceite tapa cilindros G 18.64 x 3.53	GS 2	210147
7137885	Buje placa distribución	GS 2	210048
	O´ring paso aceite tapa cilindros G 13.87 x 3.53	GS 1	210148
	Jgo. juntas caja velocidades FAE 5ta.	VS	210150
	Jgo. juntas retén bancada cigüeñal (2)	SNA	210058
	Núcleo diferencial EATON 162	NB	350368
	Tapa diferencial EATON 162 A y B	CG	350369
	Jgo. suplemento camisa cilindros (0.07) (6)	CU 1	210170-0.07
	Jgo. suplemento camisa cilindros (0.10) (6)	CU	210170-0.10
	Arandela tapón cárter A 18 x 23 x 1.5 C	CU	
	Kit de retenes completo		R210000
	Jgo. retén válvulas (12)	P 1	R300010P
	Retén bancada 118 x 143 x 13	N 1	R210011N
	Retén distribuidor 49.2 x 65.09 x 12.7	N 1	R210012N

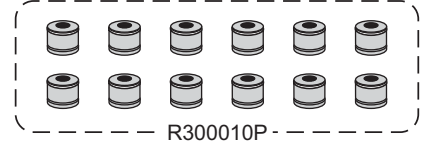
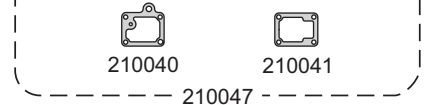
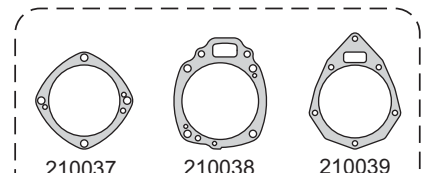
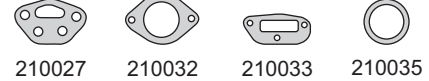
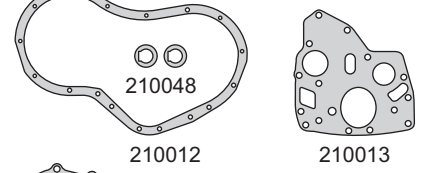
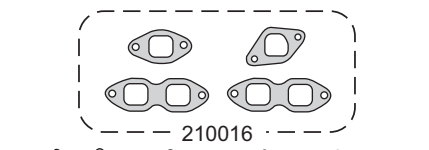
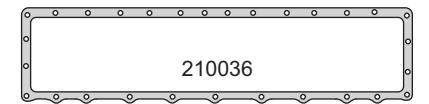
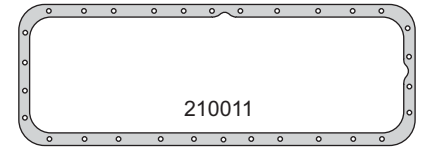
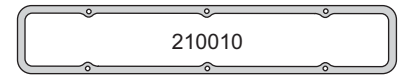
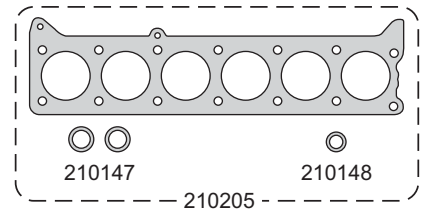

BEDFORD



Motor/Engine	Cm³	HP	Ø
300D	4927	97	98.3

Chevrolet: J6 1956/61



DIESEL

Nº OE	Descripción/Description	Mat.	Ref.
	Jgo. de juntas para motor		210300-R
	Junta tapa cilindros Ø 101.5 ± 1.70		FCH 1 210305
7137894	Junta tapa válvulas superior		CG 1 210010
7075064	Junta para cárter		CG 1 210011
6322449	Tapa distribución		CG 1 210012
6322652	Placa distribución		NB 1 210013
7126032	Tapa bomba de agua		NB 1 210014
9309	Jgo. múltiple escape (4)		NFT 1 210016
7135808	Múltiple admisión		NB 1 210017
7115805	Salida de escape		FCH 1 210018
7126030	Bomba de agua a block		NB 1 210019
7143019	Bomba aceite		NB 1 210027
6303254	Termostato tapa		NB 1 210032
7075136	Codo agua		CB 1 210033
1530250	Tapa filtro aceite		CG 1 210035
7133433	Tapa válvula lateral		CG 1 210036
6337135	Tapa trasera bomba vacío		NB 1 210037
6353757	Placa bomba vacío		NB 1 210038
6353753	Extensión mando bomba vacío		NB 1 210039
7140434	Placa tapa superior bomba		NB 1 210040
7140429	Cuerpo válvula entrada		NB 1 210041
6322449	Tapa distribución		CGT 210045
	Comando bomba combustible		NB 1 400146
	Jgo. juntas depresor (5)		VS 1 210047
7137885	Buje paso aceite distribución		GS 2 210048
	Jgo. juntas caja velocidades FAE 5ta		VS 210150
	Jgo. juntas caja velocidades VAUXHALL		VS 210350
	Jgo. empaquetadura cigüeñal (2)		SNA 210058
	Núcleo diferencial EATON 162		NB 350368
	Tapa diferencial EATON 162 A y B		CG 350369
	Jgo. suplemento camisa cilindros (0.07) (6)		CU 1 210170-0.07
	Jgo. suplemento camisa cilindros (0.10) (6)		CU 210170-0.10
	Arandela tapón cárter A 18 x 23 x 1.5 C		CU
	Kit de retenes completo		R210000
	Jgo. retén válvulas (12)		P 1 R300010P
	Retén bancada 118 x 143 x 13		N 1 R210011N
	Retén distribución 49.20 x 65.09 x 12.70		N 1 R210012N

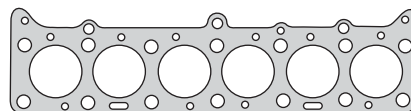

210305



210010

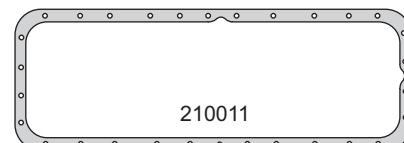

210011

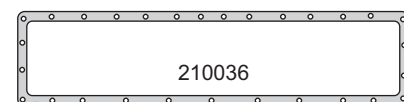

210036

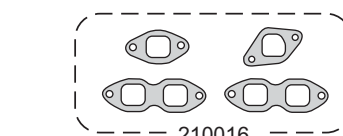

210016

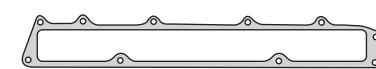

210017

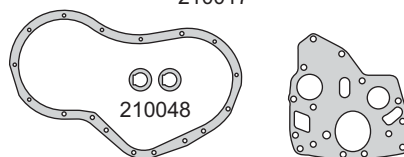

210048

210012

210013



210014



210018

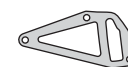

210019



210027



210032



210033



210035

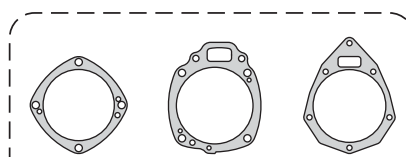

210037

210038

210039



210040



210041

210047



400146



210058



210070-0.07



R210011N



R210012N

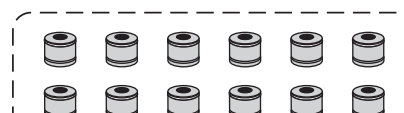

R300010P

BEDFORD



Motor/Engine	Cm³	HP	Ø
200D	3285	62	98.3

Chevrolet: C14, J17, J27, J37
1962/64



DIESEL

Nº OE	Descripción/Description	Mat.	Ref.
	Jgo. de juntas para motor		● 210800-R
6362799	Junta tapa cilindros Ø 101.5 ± 1.70	NFT	1 210805
7141212	Junta tapa válvulas superior	CG	1 210410
7135374	Junta para cárter	CG	1 210411
6322449	Tapa distribución	CG	1 210012
6322652	Placa distribución	NB	1 210013
7126032	Bomba de agua	NB	1 210014
	Jgo. múltiple escape (4)	NFT	1 210016
7135809	Múltiple admisión	NB	1 210817
5748788	Salida de escape	NFT	1 200018
3701777	Junta termostato	CB	1 200019
7126030	Bomba agua a block	NB	1 210019
	Codo agua	CB	1 210033
7135794	Tapa válvula lateral	CG	1 210436
6322449	Tapa distribución	CGT	210045
7137885	Buje placa distribución	GS	2 210048
	Jgo. empaquetadura cigüeñal (2)	SNA	210058
	Jgo. suplemento camisa cilindros 0.07 (4)	CU	1 210170-0.07
	Jgo. suplemento camisa cilindros 0.10 (4)	CU	210170-0.10
	Arandela tapón cárter A 18 x 27 x 1.5 C	CU	
	Kit de retenes completo		R210400
	Jgo. retén válvulas (8)	P	1 R210010P
	Retén bancada 118 x 143 x 13	N	1 R210011N
	Retén distribución 49.20 x 65.09 x 12.70	N	1 R210012N

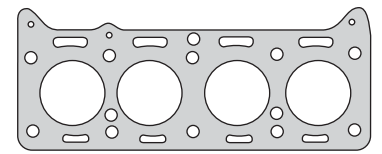

210805

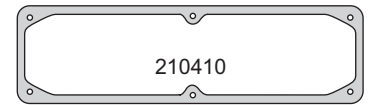

210410

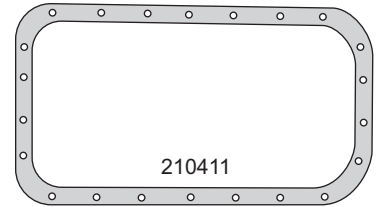

210411

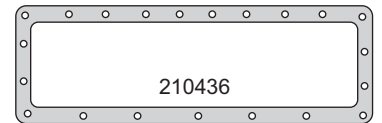

210436



210817

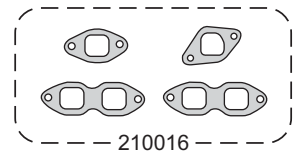

210016

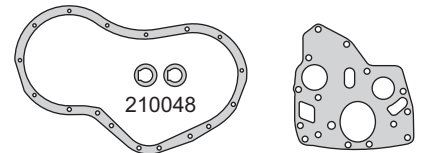

210012

210013



210014



200018



200019

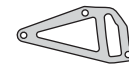

210019



210033



210070-0.07



210058



R210011N



R210012N



R210010P



taranto

Para garantizar un trabajo óptimo, utilice el Kit de Herramientas Especiales HAK12-38, con su completa línea de puntas en todas la versiones aplicables para cada modelo de cabeza de ajuste.



KIT HAK12-38

Tubos Hexagonales

6 PT Socket



Tubos Torx

Torx Socket



Tubos Estriados

12 PT Socket



Tubos con Punta Torx

Torx Socket Bit



Tubos con Punta Ribe

Ribe Socket Bit



Tubos con Punta Estriada

Torx Spline Socket Bit



Tubos con Punta Hexagonal

Hex. Socket Bit



Goniometro - Torquimetro Taranto.

Diseñado especialmente para facilitar el apriete de los tornillos de tapa de cilindros.

- ▶ HTORQ-110 - Herramienta Torquimetro 19-110NM
- ▶ HTORQ-210 - Herramienta Torquimetro 40-210NM
- ▶ HTORQ-350 - Herramienta Torquimetro 60-350NM
- ▶ HGONIOMETRO - Herramienta de Ajuste Angular - Goniometro
- ▶ HGONIOMETRO-M - Herramienta de Ajuste Angular - Goniometro Magnético



CHEVROLET



Motor/Engine	Cm³	HP	Ø
235	3851	130	90.48

Chevrolet: Apache C10 3.9/16
Camión 4400 1957/...
Bel Air, Impala 1953/62



Nº OE	Descripción/Description	Mat.	Ref.
7364640	Jgo. de juntas para motor		200400-R
3703179	Junta tapa cilindros Ø 95.0 ± 1.70	NFT	1 200405
3708648	Junta tapa válvulas superior	CG	1 200410
3714551	Jgo. junta para cárter (4)	CG	1 200411
838206	Tapa distribución	CG	1 200912
3835412	Placa distribución	NB	1 200413
3836162	Cuerpo bomba de agua	NB	1 200414
3694871	Jgo. múltiple admisión y escape (3)	NFT	1 200416
838290	Entre múltiples	NFT	1 200917
3696990	Salida de escape	FCH	200018
	Salida de escape	FCH	1 300018
	Jgo. juntas carburador	VS	200420
	Base carburador	NB	1 200425
601348	Base carburador	NB	1 200925
839166	Tapa bomba aceite	NB	1 200927
838263	Base bomba nafta	CB	1 200928
838297	Termostato	CB	1 200929
838341	Salida agua	CB	1 200930
839173	Asiento válvula distribución aceite	NB	1 200931
839174	Tapa distribución aceite	NB	1 200932
838210	Arandelas bujias	CG	6 200933
1523096	Vaso filtro nafta	CG	1 200934
3701542	Tapa válvulas lateral	CG	1 200436
	Jgo. empaquetadura cigüeñal (2)	SNA	1 200658
3714551	Jgo. juntas para cárter	CGT	200460
	Arandela tapón cárter A 13 x 20 x 2 A	AL	
	Kit de retenes completo		R200400
	Jgo. retén válvulas (12)	N	1 R200610N
	Retén distribución 44.47 x 61.19 x 9.57	P	1 R200012P

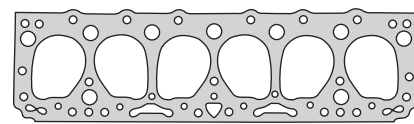

200405

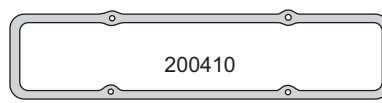

200410

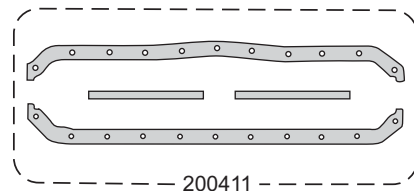

200411

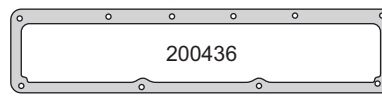

200413

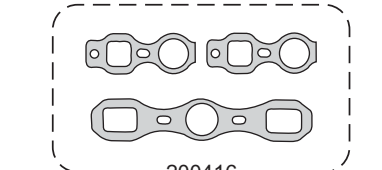

200414

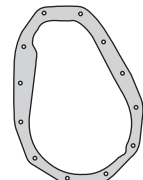

200416

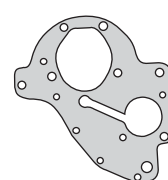

200413



200436



200420

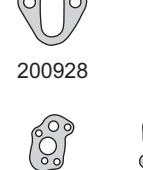

200425

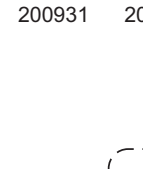

200927



200928

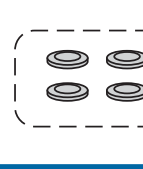

200929



200930



200931

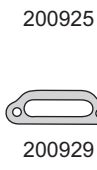

200932



200933

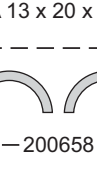

200934



300018



200917

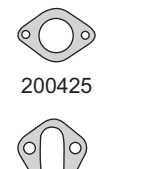

200414

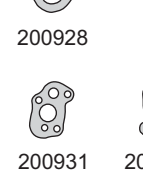

200425



200925

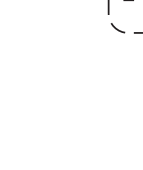

200927

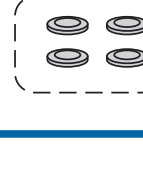

200928



200929

200930

A 13 x 20 x 2 A

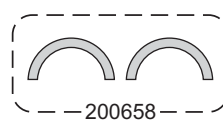

200658



R200012P

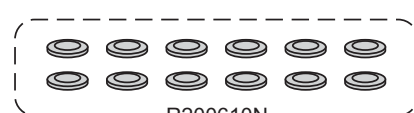

R200610N

CHEVROLET



Motor/Engine	Cm³	HP	Ø
261	4277	142	95.25

Chevrolet: Camión 3 3/4 6500 1954/62
C10, C14, C60 BR 1969/...



Nº OE	Descripción/Description	Mat.	Ref.
	Jgo. de juntas para motor		200600-R
3750625	Junta tapa cilindros Ø 98.5 ± 1.70	NFT	1 200605
3708646	Junta tapa válvulas superior	CG	1 200410
3714551	Jgo. junta para cárter (4)	CG	1 200411
838206	Tapa distribución	CG	1 200912
3835412	Placa distribución	NB	1 200413
3836162	Cuerpo bomba de agua	NB	1 200414
3694871	Jgo. múltiple admisión y escape (3)	NFT	1 200416
838290	Entre múltiples	NFT	1 200917
3696990	Salida de escape	FCH	1 200018
	Base carburador	NB	1 200425
601348	Junta base carburador	NB	1 200925
839166	Tapa bomba aceite	NB	1 200927
838263	Bomba nafta	CB	1 200928
838297	Termostato	CB	1 200929
838341	Salida agua	CB	1 200930
839173	Asiento válvula distribución aceite	NB	1 200931
839174	Tapa distribución aceite	NB	1 200932
838210	Arandelas bujías	CG	6 200933
1523096	Vaso filtro nafta	CG	1 200934
3701542	Tapa válvulas lateral	CG	1 200436
	Jgo. empaquetadura cigüeñal (2)	SNA	1 200658
	Arandela tapón cárter A 13 x 20 x 2 A	AL	
	Kit de retenes completo		R200400
	Jgo. retén válvulas (12)	N	1 R200610N
	Retén distribución 44.47 x 61.19 x 9.57	P	1 R200012P

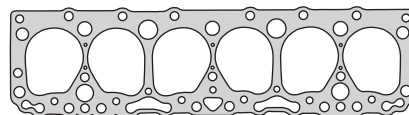

200605



200410

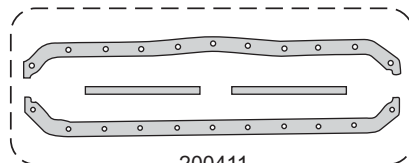

200411

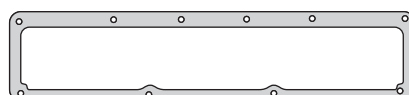

200436

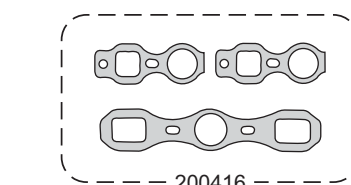

200416

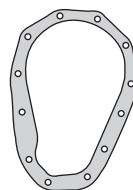

200912



200018

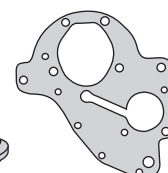

200413

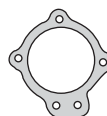

200414



200917



200425



200925



200927



200928



200929



200930



200931



200932



200933



200934



200658



R200012P

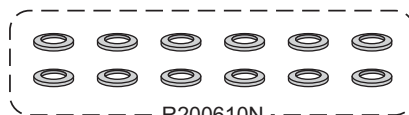

R200610N

CHEVROLET



Motor/Engine **Cm³** **HP** **Ø**

GM C350 V8 **5735** **101.6**

Chevrolet: 283, 302, 307, 327 Carburador
327, 350 No Corvette
350, Pick Up y Medianos
283, 307, 327 Camiones 1967/...



Nº OE	Descripción/Description	Mat.	Ref.
	Jgo. de juntas para motor		280100-R
	Jgo. junta tapa cilindros Ø 105.0 ± 1.20 (2)	NFT	1 280105
	Junta tapa válvulas	CG	2 280110
	Jgo. junta para cárter (7)	CG	1 280111-1
	Tapa distribución	CB	1 280112
	Jgo. múltiple escape (2)	NFT	1 280116
	Jgo. múltiple admisión (4)	NFT	1 280117
	Salida de escape	FCH	2 200018
	Salida de escape	NFT	280118
	Codo termostato	CB	280119
	Tapa bomba aceite	CB	280127
	Base bomba nafta	CB	1 200028
	Acople bomba aceite	CB	1 200029
	Base termostato	CB	280131
	Tapa inspección	CB	1 280132
	Puntera cierre admisión Chevrolet C-350	N	1 280133
	Puntera cierre admisión Chevrolet C-350	N	1 280134
	Sello metálico admisión	AC	280135
	Acople escape	NFT	280136
	Subida aceite	NFT	280137
	Bajada aceite	NFT	280138
	Arandela A 33 x 46	CB	1 280143
	Arandela A 67 x 80	CB	280142
	Junta	CB	1 280144
	Junta	CB	1 280145
	Junta	CB	1 280146
	Arandela A 129 x 140	CB	280139
	Arandela A 106 x 116	CB	280140
	Arandela A 78 x 90	CB	280141
	Arandela tapón cárter A 12.8 x 22.8 x 2	PLAST	
	Kit de retenes completo		R280100
	Jgo. retén válvulas (16)	P	1 R280110P
	Retén bancada (2 mitades)	S	1 R200011-1S
	Retén distribución 44.47 x 61.19 x 9.57	P	1 R200012P

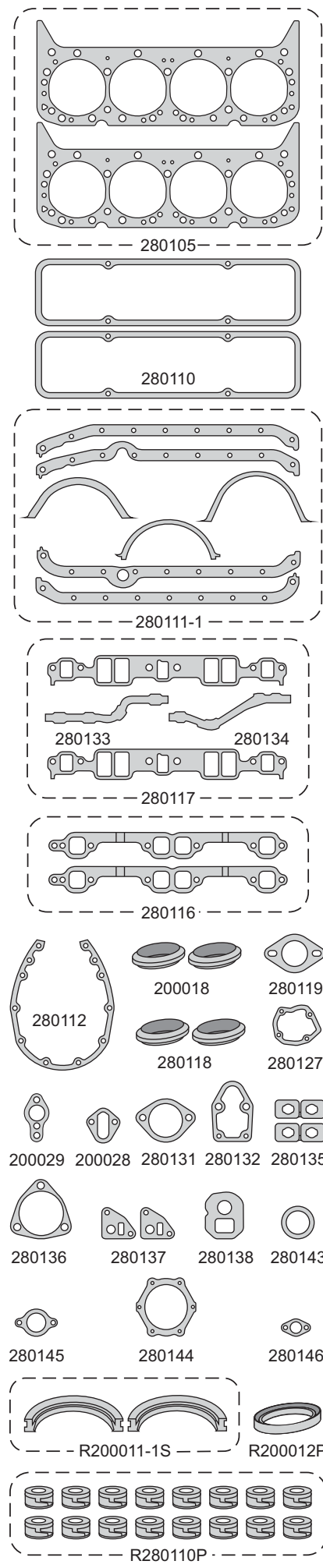

CHEVROLET



Motor/Engine **Cm³** **HP** **Ø**

C350 V8 **5735** **101.6**

Chevrolet: Trucks 1996/01, Vortec Vin R



Nº OE	Descripción/Description	Mat.	Ref.
	Jgo. de juntas para motor		281100-RMX
	Jgo. de juntas superior	●	281195
	Jgo. junta tapa cilin. Ø 105.0 ± 1.20 (2)	NFT 2 2	280105
	Junta tapa de válvulas	GS 2 2	281110
	Junta para cárter	GS 1	280111
	Jgo. múltiple escape (3)	AC 2 2	281116-1
	Jgo. múltiple admisión (4)	VS 1 1	281117
	Acople bomba aceite	CB 2	200029
	Junta base distribuidor	NB 1	200329
	Guarnición unión admisión	CG 1	242730
	Guarnición unión admisión	CG 1	242731
	Junta porta retén	CB 1	280834
	Guarnición	GS 1 1	281136
	Guarnición	GS 1 1	281137
	Guarnición	GS 1 1	281138
	Guarnición	GS 1 1	281139
	O´ring G 18.72 x 2.62	GS 2	
	O´ring G 66.27 x 3.53	GS 1	
	O´ring G 85.32 x 3.53	GS 1	
	Kit de retenes completo		R281100
	Jgo. retén válvulas (16)	P 1	R281110P
	Retén bancada 95 x 115 x 12.5	S 1	R242111S
	Retén distribución 44.47 x 61.19 x 9.57	P 1	R200012P

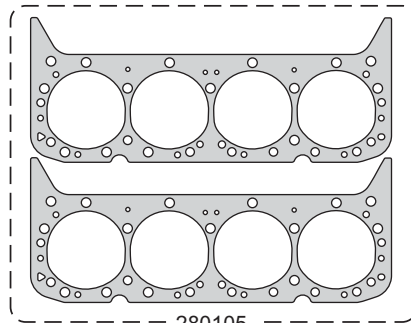

280105

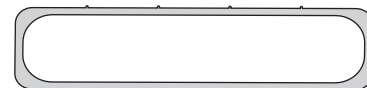

281110



280111

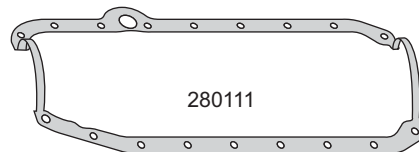

281116-1

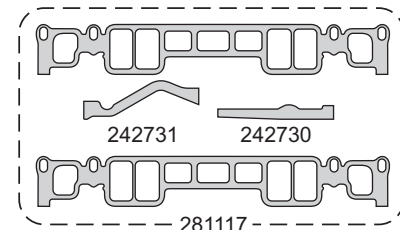
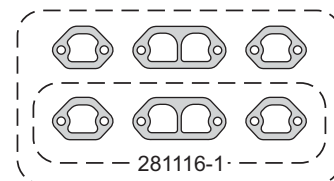

242731

242730

281117

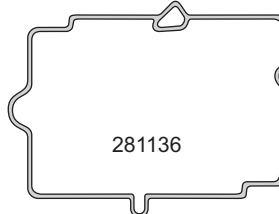

281136



200029



200329



280834



281137



281138



G 18.72 x 2.62



281139



G 66.27 x 3.53



G 85.32 x 3.53



R242111S



R200012P

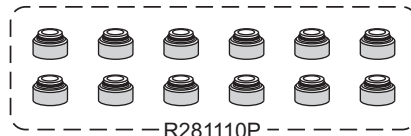

R281110P

CIMARRON



Motor/Engine	Cm³	HP	Ø
3300D	3285	88	98.3

Cimarron: 1976/85

DIESEL



Nº OE	Descripción/Description	Mat.	Ref.
	Jgo. de juntas para motor		210400-R
	Junta tapa cilindros Ø 101.0 ± 1.40	NFT	1 210405
20601	Junta tapa válvulas superior	CG	1 210410
10607	Junta para cárter	CG	1 210411
30602	Tapa distribución	CG	1 210012
30603	Placa distribución	NB	1 210413
20606	Bomba de agua	NB	1 210014
20602	Jgo. múltiple escape (2)	NFT	1 210416
10611/12	Jgo. múltiple admisión (3)	CB	1 210417
	Jgo. múltiple admisión (3)	CB	210517
3701777	Junta termostato	CB	1 200019
20605	Bomba agua a block	NB	1 210019
10605	Filtro aceite	NB	1 210427
10606	Bomba combustible	NB	1 210428
	Salida de escape	FCH	1 300230
20607	Caja termostato	CB	1 210033
10613	Tapa lateral	CG	1 210436
6337135	Tapa trasera bomba vacío	NB	1 210037
6353757	Placa bomba vacío	NB	1 210038
50601	Mando bomba inyectora	NB	1 210039
7140434	Placa tapa superior bomba	NB	1 210040
7140429	Cuerpo válvula entrada	NB	1 210041
50603	Comando bomba combustible	NB	1 400146
	Jgo. juntas depresor (5)	VS	1 210047
10620	Tubo venteo	NB	1 210447
7137885	Buje pasa aceite distribución	GS	2 210048
20608	Salida agua	CB	210448
50602	Soporte bomba inyectora	NB	2 210449
	Arandela tapón cárter A 18 x 23 x 1.5 C	CU	
	Kit de retenes completo		R210400
	Jgo. retén válvulas (8)	P	1 R210010P
	Retén bancada 118 x 143 x 13	N	1 R210011N
	Retén distribución 49.20 x 65.09 x 12.70	N	1 R210012N

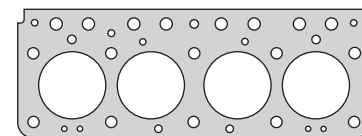

210405

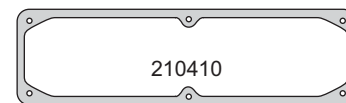

210410

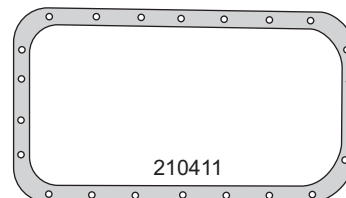

210411

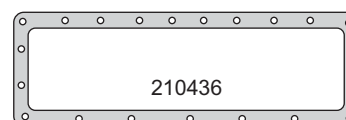

210436

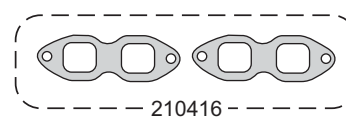

210416

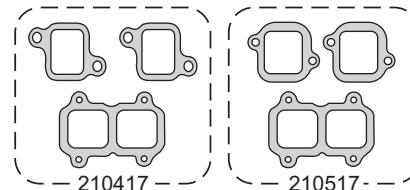

210417

210517

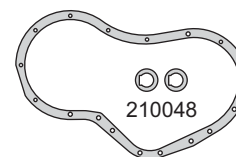

210048

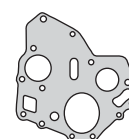

210413



210012

210014

200019

210019

210427

210428

210033

400146

210447

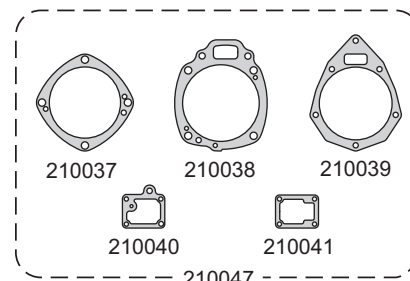

210037

210038

210039

210040

210041

210047

210448

210449

300230



R210011N



R210012N



R210010P

CIMARRON



Motor/Engine	Cm³	HP	Ø
3300D	3283	89	98.42

Cimarron: 1986/...

DIESEL



Nº OE	Descripción/Description	Mat.	Ref.
	Jgo. de juntas para motor		210500-R
	Junta tapa cilindros Ø 101.0 ±1.40		NFT 1 210505
20601	Junta tapa válvulas superior		CG 1 210410
20664	Junta para cárter		NB 1 210511
30602	Tapa distribución		CG 1 210012
30603	Placa distribución		NB 1 210413
20606	Bomba de agua		NB 1 210014
20602	Jgo. múltiple escape (2)		NFT 1 210416
10611/12	Jgo. múltiple admisión (3)		CB 1 210417
	Jgo. múltiple admisión (3)		CB 210517
3701777	Junta termostato		CB 1 200019
20605	Bomba agua a block		NB 1 210019
10605	Filtro aceite		NB 1 210427
10606	Bomba combustible		NB 1 210428
	Salida de escape		FCH 1 300230
20607	Caja termostato		CB 1 210033
10610	Tapa lateral		NB 1 210536
6337135	Tapa trasera bomba vacío		NB 1 210037
6353757	Placa bomba vacío		NB 1 210038
50601	Mando bomba inyectora		NB 1 210039
7140434	Placa tapa superior bomba		NB 1 210040
7140429	Cuerpo válvula entrada		NB 1 210041
50603	Comando bomba combustible		NB 1 400146
	Jgo. juntas depresor (5)		VS 1 210047
10620	Tubo venteo		NB 1 210447
7137885	Buje placa distribución		GS 2 210048
20608	Salida agua		CB 1 210448
50602	Soporte bomba inyectora		NB 2 210449
	Arandela tapón cárter A 18 x 23 x 1.5 C		CU
	Kit de retenes completo		R210400
	Jgo. retén válvulas (8)		P 1 R210010P
	Retén bancada 118 x 143 x 13		N 1 R210011N
	Retén distribución 49.20 x 65.09 x 12.70		N 1 R210012N

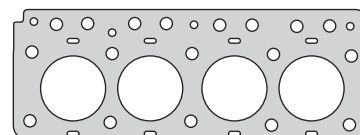

210505

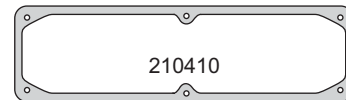

210410

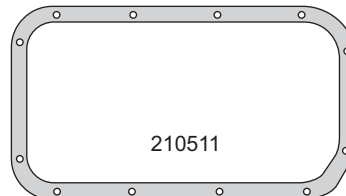

210511

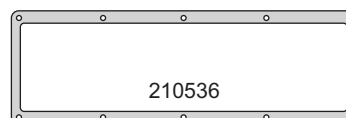

210536

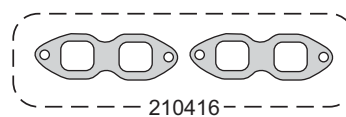

210416

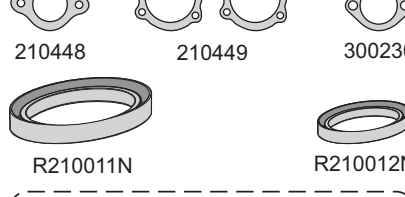
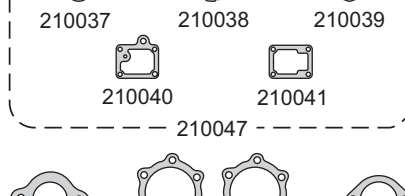
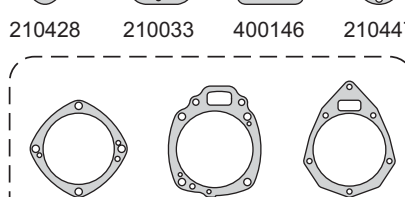
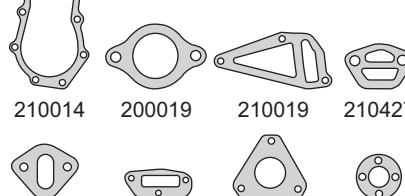
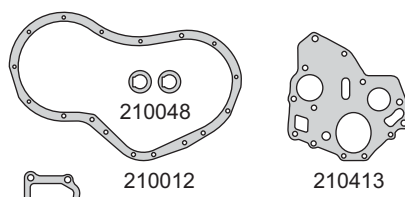
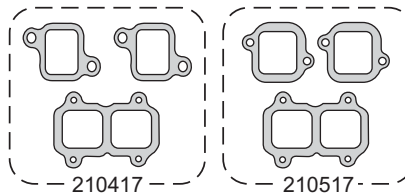

CIMARRON



Motor/Engine	Cm³	HP	Ø
3800D	3840	99	106.4

Cimarron: 1979/85



DIESEL

Nº OE	Descripción/Description	Mat.	Ref.
	Jgo. de juntas para motor		210600-R
	Junta tapa cilindros Ø 109.5 ± 1.40	NFT	1 210605
20601	Junta tapa válvulas superior	CG	1 210410
10607	Junta para cárter	CG	1 210411
30602	Tapa distribución	CG	1 210012
30603	Placa distribución	NB	1 210413
20606	Bomba de agua	NB	1 210014
20602	Jgo. múltiple escape (2)	NFT	1 210416
10611/12	Jgo. múltiple admisión (3)	CB	1 210417
	Jgo. múltiple admisión (3)	CB	210517
3701777	Junta termostato	CB	1 200019
20605	Bomba agua a block	NB	1 210019
10605	Filtro aceite	NB	1 210427
10606	Bomba combustible	NB	1 210428
	Salida de escape	FCH	1 300230
20607	Caja termostato	CB	1 210033
10613	Tapa lateral	CG	1 210436
6337135	Tapa trasera bomba vacío	NB	1 210037
6353757	Placa bomba vacío	NB	1 210038
50601	Mando bomba inyectora	NB	1 210039
7140434	Placa tapa superior bomba	NB	1 210040
7140429	Cuerpo válvula entrada	NB	1 210041
50603	Comando bomba combustible	NB	1 400146
	Jgo. juntas depresor (5)	VS	1 210047
10620	Tubo venteo	NB	1 210447
7137885	Buje placa distribución	GS	2 210048
20608	Salida agua	CB	210448
50602	Soporte bomba inyectora	NB	2 210449
	Arandela tapón cárter A 18 x 23 x 1.5 C	CU	
	Kit de retenes completo		R210400
	Jgo. retén válvulas (8)	P	1 R210010P
	Retén bancada 118 x 143 x 13	N	1 R210011N
	Retén distribución 49.20 x 65.09 x 12.70	N	1 R210012N

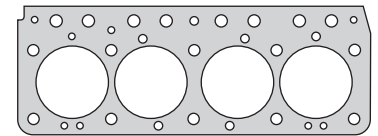

210605

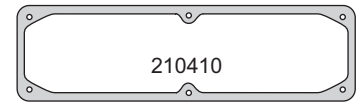

210410

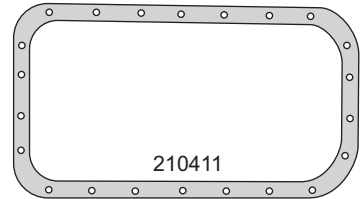

210411

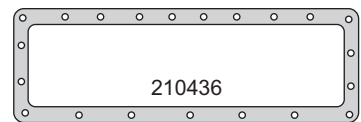

210436

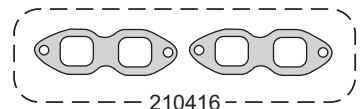

210416

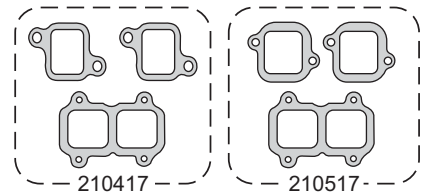

210417

210517

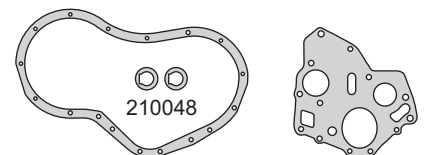

210048

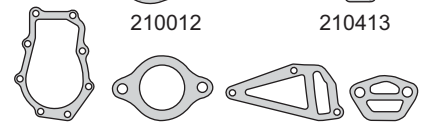

210012

210413

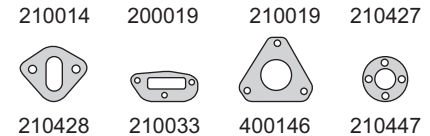

210014

200019

210019

210427

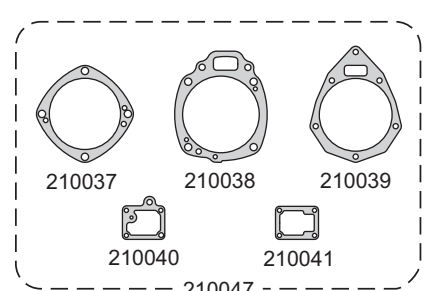

210428

210033

400146

210447

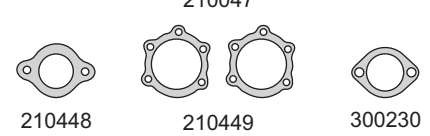

210037

210038

210039



210448

210449

300230

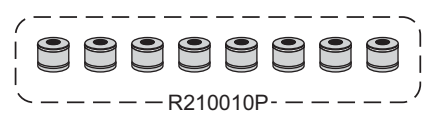

R210011N

R210012N



R210010P

CIMARRON



Motor/Engine	Cm³	HP	Ø
3800D	3840	99	106.4

Cimarron: 1986/...

DIESEL



Nº OE	Descripción/Description	Mat.	Ref.
	Jgo. de juntas para motor		210700-R
	Junta tapa cilindros Ø 109.5 ± 1.40		NFT 1 210705
20601	Junta tapa válvulas superior		CG 1 210410
20664	Junta para cárter		NB 1 210511
30602	Tapa distribución		CG 1 210012
30603	Placa distribución		NB 1 210413
20606	Bomba de agua		NB 1 210014
20602	Jgo. múltiple escape (2)		NFT 1 210416
10611/12	Jgo. múltiple admisión (3)		CB 1 210417
	Jgo. múltiple admisión (3)		CB 1 210517
3701777	Junta termostato		CB 1 200019
20605	Bomba de agua a block		NB 1 210019
10605	Filtro aceite		NB 1 210427
10606	Bomba combustible		NB 1 210428
	Salida de escape		FCH 1 300230
20607	Caja termostato		CB 1 210033
10610	Tapa lateral		NB 1 210536
6337135	Tapa trasera bomba vacío		NB 1 210037
6353757	Placa bomba vacío		NB 1 210038
50601	Mando bomba inyectora		NB 1 210039
7140434	Placa tapa superior bomba		NB 1 210040
7140429	Cuerpo válvula entrada		NB 1 210041
50603	Comando bomba combustible		NB 1 400146
	Jgo. juntas depresor (5)		VS 1 210047
10620	Tubo venteo		NB 1 210447
7137885	Buje placa distribución		GS 2 210048
20608	Salida agua		CB 1 210448
50602	Soporte bomba inyectora		NB 2 210449
	Arandela tapón cárter A 18 x 23 x 1.5 C		CU 1
	Kit de retenes completo		R210400
	Jgo. retén válvulas (8)		P 1 R210010P
	Retén bancada 118 x 143 x 13		N 1 R210011N
	Retén distribución 49.20 x 65.09 x 12.70		N 1 R210012N

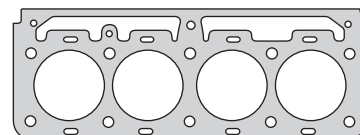

210705

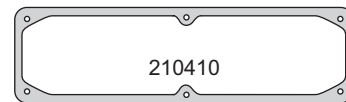

210410

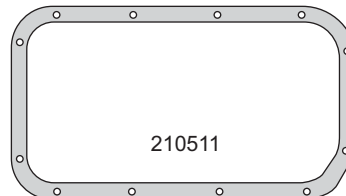

210511

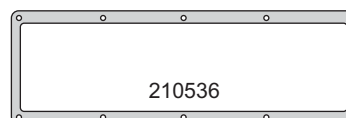

210536

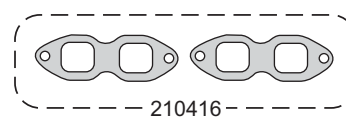

210416

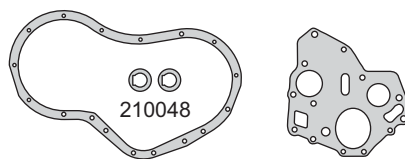
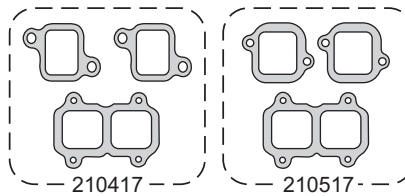

210048

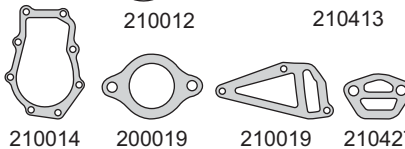

210012

210413

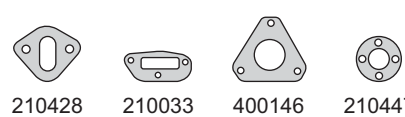

210014

200019

210019

210427

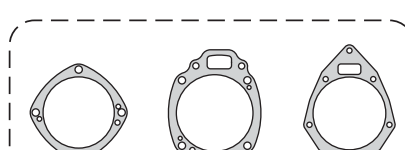

210428

210033

400146

210447

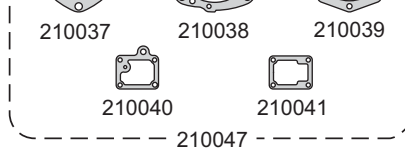

210037

210038

210039

210040

210041

210047

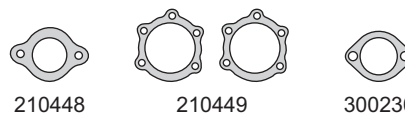

210448

210449

300230



R210011N

R210012N

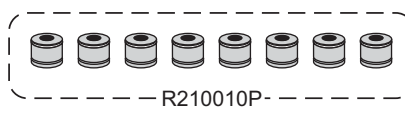

R210010P

CUMMINS**taranto**

Motor/Engine	Cm³	HP	Ø
4B	3900	100	102
4BT/BTA	3900	130	102

Cummins: Serie B
Ford: F100 1998/..., F4000 2000/...
 Cargo 915, Euro II



DIESEL

Nº OE	Descripción/Description	Mat.	Ref.
	Jgo. de juntas para motor		870000-R
	Jgo. de juntas superior		870095
BF6T/6051/AB	Jta. tapa cilindros Ø 106.0 \geq 1.60	NFT	1 1 870007
	Jta. tapa cilindros Ø 106.0 \geq 1.85		870007-1.85
	Jgo. tornillos tapa cilindros (HAS17038)		B870000
BF6T/6584/AA	Conj. junta tapa válvulas (2)	GS	4 4 870010
BF8T/6L680/AA	Junta para cárter	NB	1 1 870011
BF5X/6020/B	Tapa distribución con bomba rotativa	NFT	1 1 870012
BF5X/6020/C	Placa distribución con bomba lineal	NB	1 1 870013
3927154/00	Múltiple escape	AC	4 4 870015
BF8T/9441/AA	Múltiple admisión	NB	1 1 870017
	Salida de escape	AC	1 1 870018
BF9T/9W352/A	Base bomba alimentación	NB	1 1 870028
BF5X/9L937/AA	Separador admisión	NB	2 2 870029
BF8T/8255/A	Guarnición termostato	GS	1 1 870030
	Anular G 30 x 46 x 3	GS	1 1 510535
	Guarnición G 68 x 72 x 1.7	GS	1 1 870032
	Arandela doble raccord Ø6	CU	4 4 870034
BF8T/6L621/A	Placa enfriador aceite intermedia	NFT	1 1 870035
BF8T/6C519/A	Lateral botadores	CG	1 1 870036
3918493	Porta retén bancada trasero	NB	1 1 870037
	Placa enfriador aceite intermedia	NFT	1 1 870038
BF6X/6838/A	Placa enfriador aceite a block	NB	1 1 870039
	Boquilla plást. cortas surtidor aceite bancada	P	4 4 870041
3925 235/A	Placa cobre volante	CG	1 1 870042
BF8T/6659/AA	Succión aceite	NB	1 1 870043
BF5X/9585/A	Base bomba inyectora	NB	1 1 870044
2RL/145617	Junta compresor	NFT	1 1 870045
3916042	Junta bomba inyectora distribución	NFT	1 1 870046
BF8T/6A25/A	Inspección trasera distribución	NB	1 1 870047
	Brida entrada servo		870048
	Boquillas plást. largas surtidor aceite bancada	P	4 4 870049
	Sello con inserto metálico G 65 x 73 x 3	GS	1 1 870051
	Jgo. juntas caja de velocidades	VS	1 1 870050
	Guarnición tapa válvulas G 10 x 18 x 10	GS	4 4 870052
TRA/145453	Colector a escape turbo	AC	1 1 870063
BF0T/6N652/AA	Salida aceite a turbo	NH	1 1 870064
	Buje con ala A 7 x 15 x 9 C	CU	1 1 870065
	Junta inspección	NB	1 1 870068
	Arandela especial con inserto A 8 x 18 x 0.5 C	CU	1 6
	Arandela A 22 x 27 x 1.5 C	CU	1 1
	Arandela A 22 x 27 x 1.5 A	AL	1 4
	Arandela A 10 x 16 x 1.5 C	CU	4 6
	Arandela A 7 x 15 x 2.5 C	CU	2 6
	Arandela A 7 x 15 x 1.5 C	CU	4 4
	Arandela A 18 x 24 x 1.5 C	CU	1 1
	Arandela A 25 x 29 x 2 C	CU	1 1
	Arandela especial con inserto A 8 x 13 x 1C	CU	2 2
	O-ring G 9.25 x 1.78	GS	6 6
	O-ring G 15.6 x 1.78	GS	1 1
	Anillo G 158 x 166 x 7 guarda polvo retén trasero	GS	1 1
	Anillo G 88 x 99 x 5	GS	1 1
	Anillo G 73 x 84 x 9	GS	1 1

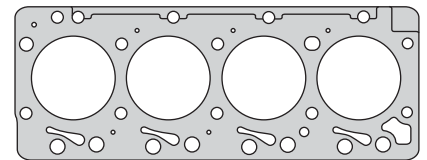

870007

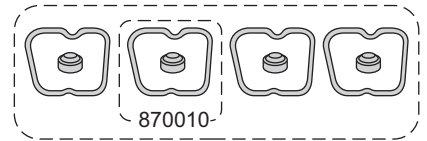

870010

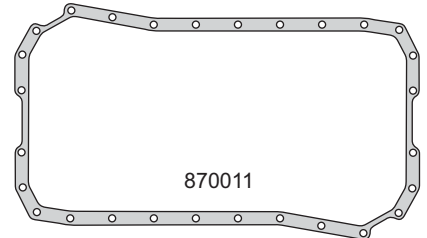

870011



870036



870015

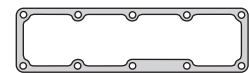

870017

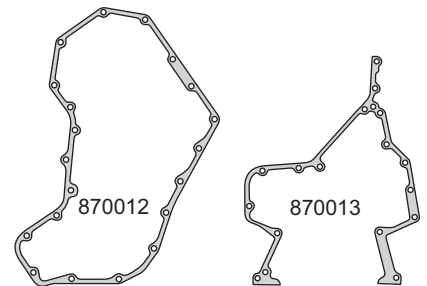

870012

870013

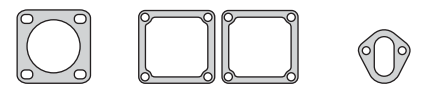

870018

870029

870028

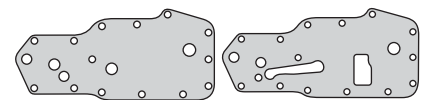

870035

870038

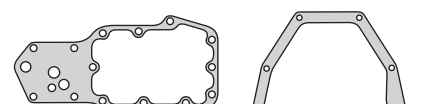

870039

870037



870034

870041

870049

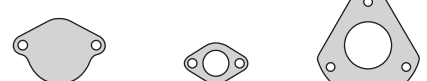

870042

870043

870044

CUMMINS



Motor/Engine	Cm³	HP	Ø
4B	3900	100	102
4BT/BTA	3900	130	102

Cummins: Serie B
Ford: F100 1998/..., F4000 2000/...
 Cargo 915, Euro II



DIESEL

Nº OE	Descripción/Description	Mat.	1	Ref.
	Anillo G 50 x 62 x 5	GS	1	
	Anillo G 41 x 47 x 2.5	GS	1	
	Anillo G 30 x 34 x 2	GS	1	
	Anillo G 25 x 29 x 1.5	GS	1	
	Kit de retenes completo			R870000
BF8T/6377/AA	Jgo. retén válvulas (8)	P	1	R870010P
BF8T/6378/AA	Retén bancada 130 x 150 x 12/13	VF	1	R870011VF
BF5X/6571/AA	Retén distribución 63.5 x 79.5 x 9	VF	1	R870012VF

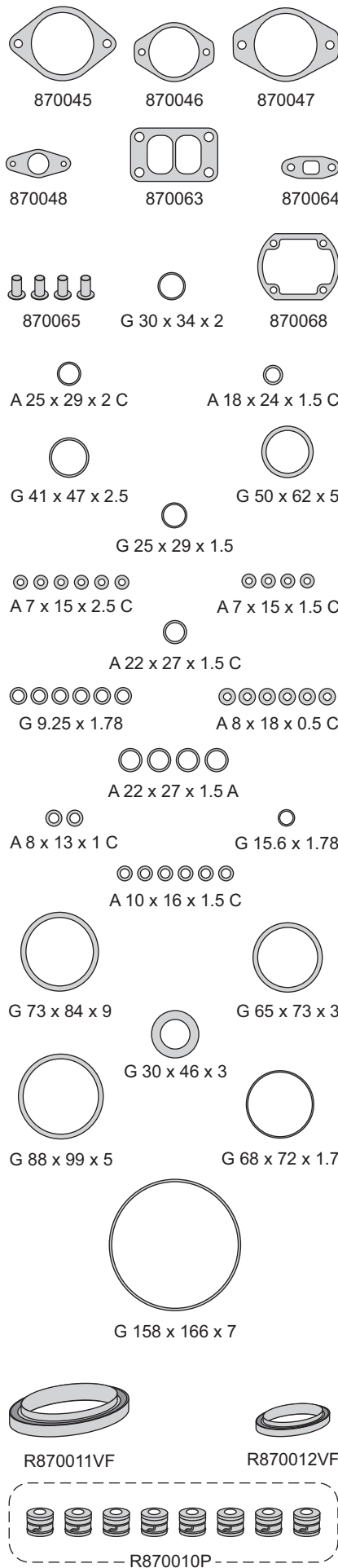

CUMMINS**taranto**

Motor/Engine	Cm³	HP	Ø
6B	5883	330	102
6B	5900	180	102
6BT/BTA (SOHC) 12V	5900	205	102

Cummins: Serie B
Dodge: Truck 359 1989/93, Ram 2007/...
Ford: F14000 Turbo, F4000 1999/...
 1416 Euro I 1989/93



DIESEL

Nº OE	Descripción/Description	Mat.	Ref.
	Jgo. de juntas para motor		870100-R
	Jgo. de juntas superior		870195
BF5X/6051/AA	Jta. tapa cilindros Ø 106.0 \pm 1.60	NFT	1 1 870107
	Jta. tapa cilindros Ø 106.0 \pm 1.85		870107-1.85
	Jgo. tornillos tapa cilindros (HAS17038)	GS	6 6 B870100
BF6T/6584/AA	Conj. junta tapa válvulas (2)	NB	1 1 870010
BF0T/6710/AA	Junta para cárter	NFT	1 1 870111
BF5X/6020/B	Tapa distribución con bomba rotativa	NFT	1 1 870012
	Tapa distribución con bomba lineal	NB	1 1 870112
BF5X/6020/C	Placa distribución	AC	6 6 870013
3927154/00	Múltiple escape	NB	1 1 870015
TRA/129717	Múltiple admisión	AC	1 1 870117
	Salida de escape	NB	1 1 870018
BF9T/9W352/A	Bomba combustible	NB	2 2 870028
BF5X/9L937/AA	Separador admisión	GS	870029
BF8T/8255/A	Guarnición termostato	GS	1 1 870030
	Anular G 30 x 46 x 3	GS	1 510535
	Guarnición G 68 x 72 x 1.7	CU	6 6 870032
	Arandela especial A 10 x 16 x 1.5 C	CU	6 6 870133
	Arandela doble raccord Ø6	NFT	1 870034
BF8T/6L621/A	Tapa enfriador aceite	CG	1 870035
13928832/00	Tapa lateral botadores	NB	1 870136
	Porta retén bancada trasero	NFT	1 870037
	Placa enfriador aceite intermedio	NB	1 870038
BF6X/6838/A	Placa enfriador aceite	PLAST	6 870039
	Boquilla plástica surtidor aceite bancada	CG	1 870041
3925 235/A	Placa tapa cubrevolante	NB	1 870042
BF8T/6659/AA	Succión aceite	NB	1 870043
BF5X/9585/A	Base bomba inyectora	NFT	1 870044
2RL/145617	Junta compresor	NFT	1 870045
3916042	Junta bomba inyectora a distribución	NB	1 870046
BF8T/6A025/A	Bomba inyectora a distribución	PLAST	6 6 870047
	Boquillas plásticas largas surtidor aceite bancada	GS	6 6 870049
	Guarnición tapa válvulas G 10 x 18 x 10	AC	1 1 870052
TRA/145453	Colector a escape turbo	NB	1 870063
BF0T/6N652/AA	Salida aceite a turbo	NB	870064
	Junta inspección	AL	4 870068
	Arandela A 22 x 27 x 1.5 A	CU	1
	Arandela A 22 x 27 x 1.5 C	CU	1
	Arandela A 18 x 24 x 1.5 C	CU	1
	Arandela A 25 x 29 x 2 C	CU	6 6
	Arandela A 7 x 15 x 2.5 C	CU	4
	Arandela A 7 x 15 x 1.5 C	CU	2
	Arandela A 8 x 13 x 1 C	CU	6
	Arandela A 8 x 18 x 0.5 C	GS	6
	O´ring G 9.25 x 1.78	GS	1
	O´ring G 15.6 x 1.78	GS	1
	Anillo G 158 x 166 x 7 guarda polvo retén trasero	GS	1
	Anillo G 88 x 99 x 5	GS	1
	Anillo G 73 x 84 x 9	GS	1
	Anillo G 50 x 62 x 5	GS	1
	Anillo G 41 x 47.5 x 2.5	GS	1
	Anillo G 30 x 34 x 2	GS	1

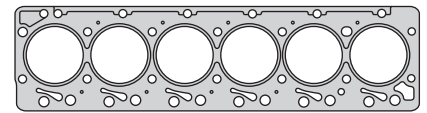

870107

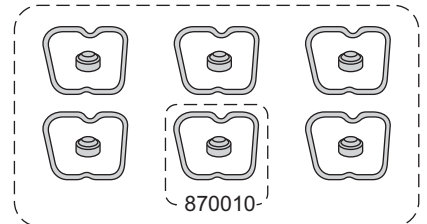

870010

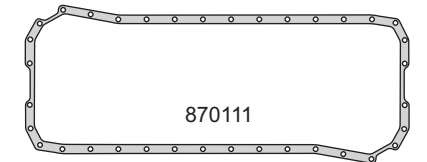

870111



870136

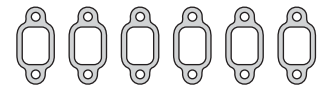

870015

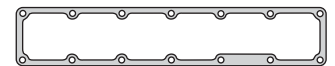

870117

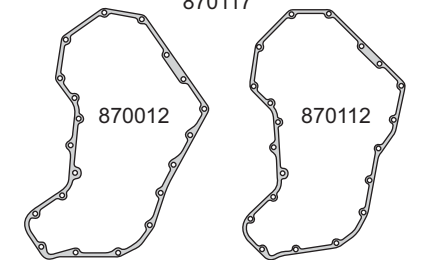

870012

870112

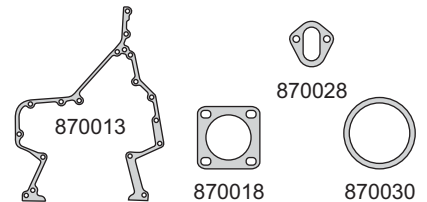

870013

870028

870018

870030

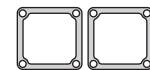

870029



870034

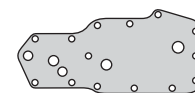

870035

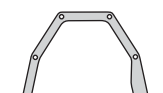

870037

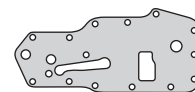

870038

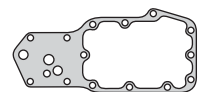

870039



870041



870043

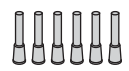

870049



870042



870045

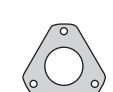

870044

CUMMINS



Motor/Engine	Cm³	HP	Ø
6B	5883	330	102
6B	5900	180	102
6BT/BTA (SOHC) 12V	5900	205	102

Cummins: Serie B
Dodge: Truck 359 1989/93, Ram 2007/...
Ford: F14000 Turbo, F4000 1999/...
 1416 Euro I 1989/93



DIESEL

Nº OE	Descripción/Description	Mat.	Ref.
	Anillo G 25 x 29 x 1.5	GS	
	Kit de retenes completo		R870100
BF5X/6571/AA	Jgo. retén válvulas (12)	P	1 R870110P
BF8T/6377/AA	Retén bancada 130 x 150 x 12/13	VF	1 R870011VF
BF8T/6378/AA	Retén distribución 63.5 x 79.5 x 9	VF	1 R870012VF

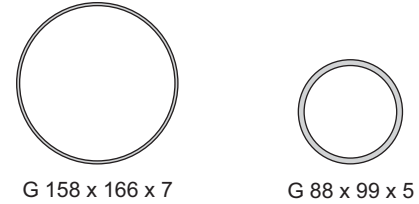
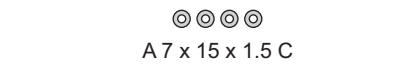
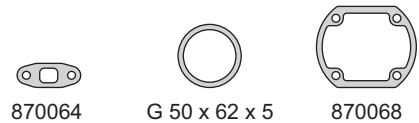
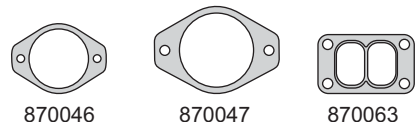

CUMMINS



Motor/Engine	Cm³	HP	Ø
6C	8300	254	114
6CT/CTA (SOHC) 12V	8300	294	114

Cummins: Serie C - Bus, Camión, Agrícola
Ford: Cargo 1722, 1730, 2625 1998/...
 F14000 1999/...



DIESEL

Nº OE	Descripción/Description	Mat.	Ref.
	Jgo. de juntas para motor		870200-R
	Jgo. de juntas superior		870295
3935585-3938267	Jta. tapa cilindros Ø120.0 ± 1.50	NFT 1 1	870207
	Jgo. tornillos tapa cilindros		B870200
3905449	Junta tapa válvulas	GS 1 1	870210
3914017	Junta para cárter	NB 1 1	870211
3917779	Tapa distribución	NFT 1 1	870212
3914304	Placa distribución	NFT 1 1	870213
3932063	Jgo. múltiple escape (18)	AC 1 1	870215
3921440	Múltiple admisión	NB 1 1	870217
3914210	Termostato	NB 1 1	870219
3911941	Turbo	NB 1 1	870220
	Turbo intermedia	NB 1 1	870221
	Turbo salida de escape	AC 1 1	870222
3823921	Turbo entrada aceite	NB 1 1	870223
3906886	Capuchón protector inyector	P 6 6	870225
3902466	Arandela goma G 14 x 19 x 2.5	GS 1 1	870226
3914708	Chapa fijadora prisionero múltiple escape	AC 12 12	870227
3935172	Arandela con inserto goma	AC/GS	870228
3935171	Arandela con inserto goma	AC/GS 4 4	870229
3914311	Múltiple admisión	NB 1 1	870231
3937706	Llenado aceite	GS	870232
3914301	Porta retén trasero	NB	870233
	Arandela doble raccord Ø6	CU 8 8	870034
3918174	Enfriador aceite a block	NFT	870234
3918332	Placa separador enfriador aceite	NFT	870235
3914308	Placa separador enfriador aceite	NFT	870236
3916042	Bomba hidráulica	NB	870237
3918340	Bomba hidráulica		870238
3914303	Inspección distribución	NFT	870239
3914302	Bomba succión aceite	NFT	870240
3919003	Boquilla plástica enfriador pistón	PLAST 12	870241
3905928	Boquilla plástica enfriador larga	PLAST 12	870242
3917780	Tapa distribución - versión nueva - Junta acople admisión	NFT 1 1 NB 1 1	870243 870244
BF8T/6A25/A	Inspección trasera	NB	870047
	Junta inspección	NB	870068
3912473	Anillo goma G 158 x 166 x 7	GS	870245
3906659	Arandela inyector A 7 x 15 x 1.5 C	CU 6 6	870246
3910824	O´ring G 9.25 x 1.78	GS 6 6	870247
3909397	O´ring G 17.17 x 1.78	GS 1 1	870248
145530	O´ring G 23.47 x 2.62	GS 2 2	870249
3903546	O´ring G 69.57 x 1.78	GS 1 1	870250
3902089	O´ring G 98.02 x 3.53	GS	870251
3901798	Anillo goma G 77.2 x 83 x 3	GS	870252
3915772	O´ring G 12.29 x 3.53	GS	870253
3914095	Anillo goma G 30 x 34 x 2	GS	870254
	O´ring G 61.60 x 2.62	GS	870255
	O´ring G 15.6 x 1.78	GS	870256
	O´ring G 12.37 x 2.62	GS	870257
3902425	Arandela A 25 x 29 x 2 C	CU	870258
	Arandela A 22 x 27 x 1.5 A	AL 3 3	870259
3920773	Arandela A 18 x 24 x 1.5 C	CU	870260

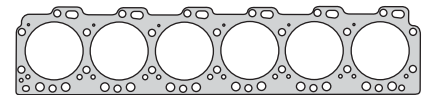

870207

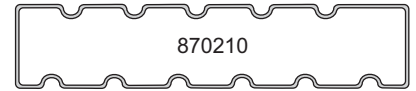

870210

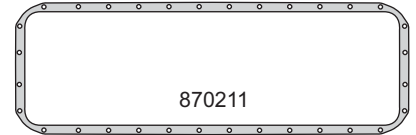

870211

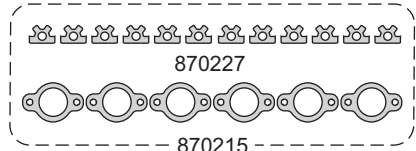

870212

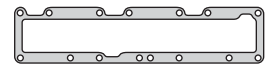

870215

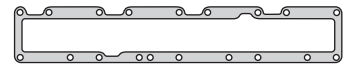

870217

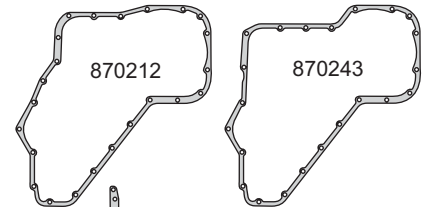

870212

870243

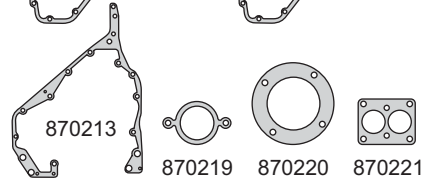

870213

870219

870220

870221



870222

870225

870223



870226

870228

870229

870232

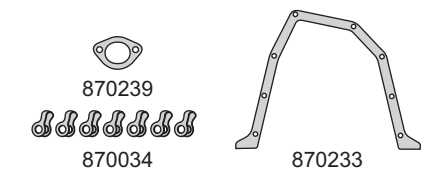

870239

870034

870233

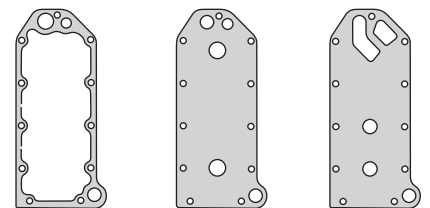

870234

870235

870236

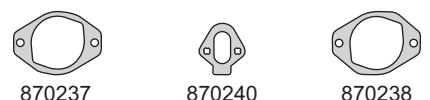

870237

870240

870238



870241

870242

CUMMINS



Motor/Engine



Cm³

HP

Ø

Cummins: Serie C - Bus, Camión, Agrícola
Ford: Cargo 1722, 1730, 2625 1998/... F14000 1999/...

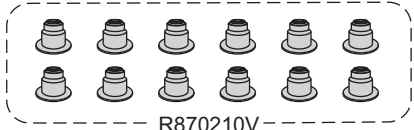
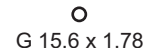
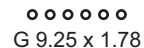
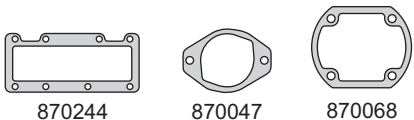

Table with columns: Nº OE, Descripción/Description, Mat., and Ref. It lists various engine parts like gaskets and valves with their respective materials and reference numbers.

CUMMINS



Motor/Engine	Cm³	HP	Ø
ISBe (OHV) 16V	3920	150/170	102

Cummins: Bus, Agrale, Euro III/IV
Electrónico 2003/...

Ford: F100 2006/..., Common Rail



DIESEL

Nº OE	Descripción/Description	Mat.	Ref.
	Jgo. de juntas para motor		● 870500-R
2830707	Junta tapa cilindros Ø 105.0 ± 1.10	NFT	1 870508
	Jgo. tornillos tapa cilindros		B870500
4899228	Junta tapa válvulas superior	GS	1 870510
	Junta tapa válvulas inferior	GS	870536
4897877	Junta para cárter	NH	1 870511
2830444	Jgo. múltiple escape (4)	GFT	1 870516
	Guarnición cierre tapa válvulas	GS	4 870533
4896409	Junta enfriador aceite placa	NFT	1 800835
	Junta placa separador aceite	NFT	1 870539
4842146	Guarnición llenado aceite	GS	1 800839
4898301	Junta chupador aceite	NB	1 800841
4891288	Junta entrada aceite a turbo	NB	1 800840
3942454	Guarnición termostato	GS	870543
3932475	Junta escape turbo	AC	1 500546
	Kit radiador aceite (2)	NFT	1 870545
4893741	Arandela pico inyector A 7.5 x 15 x 3 C	CU	4 870546
	Junta	NFT	1 870547
	Arandela A 7.5 x 15 x 2 C	CU	4
	Arandela A 16 x 24 x 1.5 A	AL	2
	Arandela A 12 x 20 x 1.5 A	AL	
3906252	Guarnición G 105 x 111 x 3.65	GS	1
	O´ring G 7.59 x 2.62	GS	12
	O´ring G 9.19 x 2.62	GS	1
	O´ring G 9 x 2	GS	1
	O´ring G 9.25 x 1.78	GS	2
4890929	O´ring G 10.77 x 2.62	GS	2
	O´ring G 11 x 3	GS	4
	O´ring G 13.94 x 2.62	GS	1
	O´ring G 15.54 x 2.62	GS	2
	O´ring G 15.6 x 1.78	GS	1
	O´ring G 17.12 x 2.62	GS	2
	O´ring G 17.17 x 1.78	GS	1
	O´ring G 18.72 x 2.62	GS	1
	O´ring G 19.18 x 2.46	GS	1
4898439	O´ring G 20.3 x 2.62	GS	1
4890926	O´ring G 21 x 3	GS	4
	O´ring G 23.39 x 3.53	GS	1
	O´ring G 23.47 x 2.62	GS	2
	O´ring G 25.07 x 2.62	GS	1
	O´ring G 44.12 x 2.62	GS	1
	O´ring G 50.39 x 3.53	GS	1
	O´ring G 60.05 x 1.78	GS	1
	O´ring G 82.22 x 2.62	GS	1
	Anillo G 50 x 62 x 5	GS	1
	Anillo G 88 x 99 x 5	GS	1
	Kit de retenes completo		R870500
3945438/1	Jgo. retén válvulas (16)	V	1 R870510V
4890833	Retén bancada 130 x 155 x 12,5/16	T	1 R800811T
4890832	Retén distribución 70 x 100 x 12,5/16	T	1 R800812T

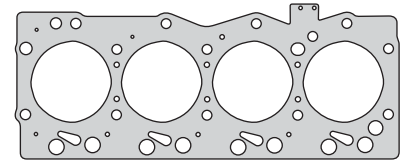

870508

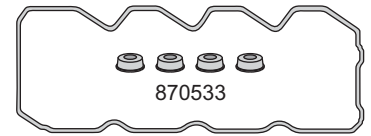

870533

870510



870536

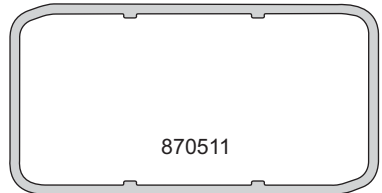

870511

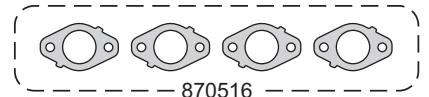

870516

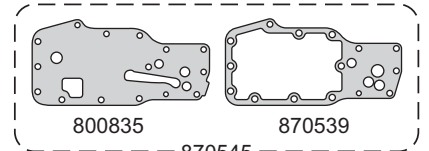

800835

870539

870545

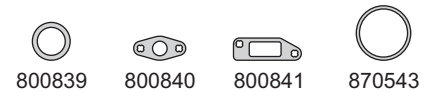

800839

800840

800841

870543

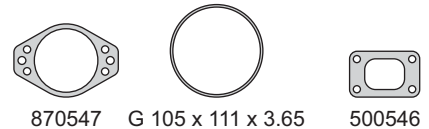

870547

G 105 x 111 x 3.65

500546

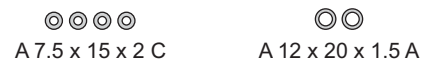

A 7.5 x 15 x 2 C

A 12 x 20 x 1.5 A

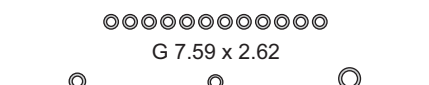

G 7.59 x 2.62

G 9.19 x 2.62

G 9 x 2

G 13.94 x 2.62

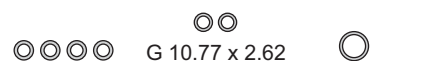

G 10.77 x 2.62

G 20.3 x 2.62

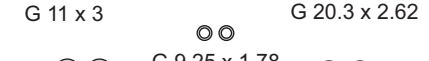

G 11 x 3

G 23.39 x 3.53

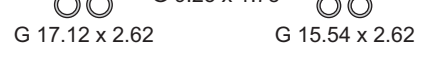

G 17.12 x 2.62

G 15.54 x 2.62



G 18.72 x 2.62

G 21 x 3

G 19.18 x 2.46

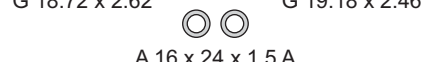

A 16 x 24 x 1.5 A



R800811T

R800812T

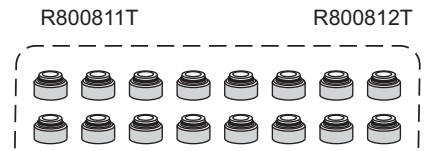

R870510V

CUMMINS



Motor/Engine	Cm³	HP	Ø
ISCe 6 24V	8270	315	114

Cummins: Serie C 1832/2632 2003/...
 Ford: 2632E/2932E/4432E/4532E/5032E
 VW: 17220/17300/17310/18310/19320/26320
 17250E/19320E/24250E
 Bus 17260EOT/18320EOT



DIESEL

Nº OE	Descripción/Description	Mat.	Ref.
	Jgo. de juntas para motor		870600-R
	Jgo. de juntas superior	●	870695
	Junta tapa cilindros Ø 123.5 ± 1.80	NFT 1 1	870607
	Jgo. tornillos tapa cilindros		B870200
3914017	Junta tapa válvulas	GS 1 1	870610
3944293	Junta para cárter	NB 1	870211
	Placa distribución	NFT 1	870613
	Jgo. múltiple escape (6)	AC 1 1	870615
	Múltiple de admisión	NB 1	870617
	Salida de escape	FCH	870618
3911941	Junta termostato	NB 1	870619
3992092	Turbo	NB 1 1	870220
4928538	Base filtro	NB 1	870622
	Bomba combustible	NFT 1	870628
	Junta acople	NB 1	870629
3937706	Junta admisión	NB 1	870631
3914301	Llenado aceite	GS 1 1	870232
	Porta retén trasero	NB 1	870233
3918174	Junta tapa válvulas	GS 1 1	870633
4902952	Enfriador aceite a block	NFT 1	870234
3918332	Bomba combustible	NB 1	870634
	Placa separador enfriador aceite	NFT 1	870235
3940245	Junta aceite turbo	NB	870635
3914303	Junta	NFT 1	870638
	Inspección distribución	NFT 1	870239
	Junta	NFT 1	870639
	Junta bomba succión de aceite	NB 1	870640
3906659	Junta turbo	AC 1 1	870063
3920773	Arandela inyector A 7 x 15 x 1.5 C	CU 6 6	
	Arandela A 18 x 24 x 1.5 C	CU 2	
	Arandela A 11 x 18 x 1.5 A	AL 23	
	Arandela A 14 x 20 x 1.5 A	AL 7	
	Arandela A 12 x 18 x 1.5 A	AL 15	
	O´ring G 21 x 3	GS 6	
	O´ring G 10.77 x 2.62	GS 6	
	O´ring G 28.24 x 2.62	GS 1	
4010519	O´ring G 11 x 2.5 S	S 3	
	O´ring G 11 x 2.5	GS 4	
	O´ring G 9 x 2.5	GS 4	
3910824	O´ring G 18.72 x 2.62	GS 4	
	O´ring G 9.25 x 1.78	GS 1	
	O´ring G 12.42 x 1.78	GS 1	
3073966	O´ring G 16 x 2	GS 1	
	O´ring G 47 x 4	GS 2	
	O´ring G 59.99 x 2.62	GS 1	
4010643	O´ring G 82.22 x 2.62	GS 1	
3201562	O´ring G 16 x 2.5	GS 1	
	O´ring G 22.5 x 3	GS 1	
	O´ring G 20.35 x 1.78	GS 1	
3902089	O´ring G 21.82 x 3.53	GS 1	
	O´ring G 98.02 x 3.53	GS 6	
	O´ring G 107.54 x 3.53	GS 6	
	Kit de retenes completo		R870600
3909410	Jgo. retén válvulas (24)	V 1	R870610V
3908139	Retén bancada 130 x 150 x 12/13	VF 1	R870011VF
	Retén distribución 75 x 93 x 9/10	V 1	R870212V

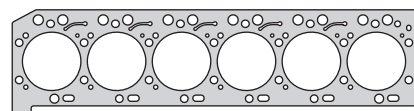

870607



870610



870633

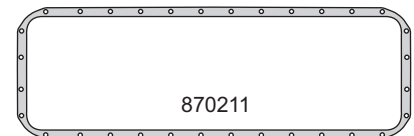

870211



870615

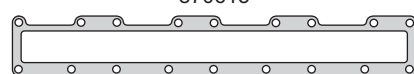

870617

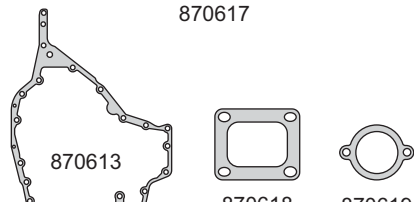

870613



870618



870619

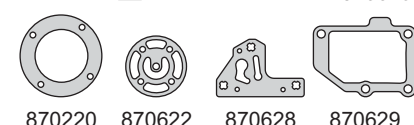

870220

870622

870628

870629

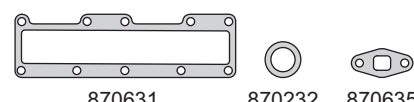

870631



870232



870635

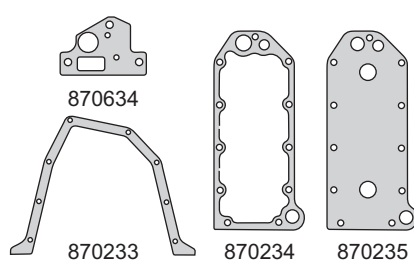

870634

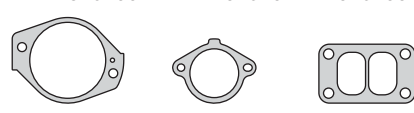

870233



870234



870235



870638



870639



870063

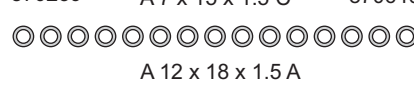

870239

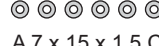

A 7 x 15 x 1.5 C



870640



R870011VF



R870212V

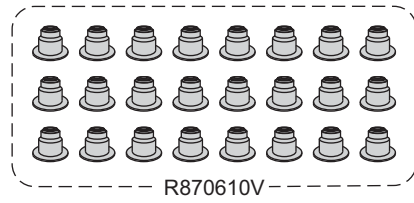

R870610V

CUMMINS



Motor/Engine	Cm³	HP	Ø
ISX/QSX (DOHC) 24V	14951	380/540	137

Cummins: ISX Series 1997/10

DIESEL



Nº OE	Descripción/Description	Mat.	Ref.
	Jgo. de juntas para motor		870700
	Junta tapa cilindros Ø 146.5 ± 2.20	NFT 1	870707
	Junta tapa válvulas	AC/GS 1	870710
	Junta para cárter	AC/GS 1	870711
	Junta tapa distribución	AC/GS 1	870712
	Guarnición tapa distribución	GS 1	870713
	Guarnición tapa distribución	GS 1	870713-1
	Termostato	AC/GS 1	870719
	Conexión entrada de agua	AC/GS 1	870730
	Carcasa de termostato	AC/GS 1	870732
	Junta carcasa volante	AC/GS 1	870733
	Base toma fuerza compresor aire	AC/GS 1	870734
	Enfriador aceite a block	AC/GS 1	870735
	Sello árbol de levas	GS 1	870738
	Sello árbol de levas	GS 1	870739
	Junta aislación de módulo control eléctrico	PLAST 1	870740
	Guarnición goma	GS 1	870741
	Junta montaje turbo	SLS 1	870742
	Junta entrada de aire	AC/GS 1	870743
	Tapón reparación canal de aceite	AC/GS 4	870744
	Aro sello tubo retroceso aceite	AC/GS 1	870745
	Junta carcasa bomba combustible	AC/GS 1	870746
	Guarnición capuchones	PLAST 2	870747
	Anillo G 11.5 x 17.5 x 9	GS 2	
	Anillo G 74 x 81 x 3	GS 1	
	Anillo G 90 x 96 x 3	GS 1	
	O´ring G 11 x 1.80	GS 2	
	O´ring G 11.5 x 2.25	GS 1	
	O´ring G 23.5 x 3	GS 1	
	O´ring G 28.5 x 2.6	GS 1	
	O´ring G 29 x 3.40	GS 1	
	O´ring G 32 x 1.80	GS 6	
	O´ring G 33 x 2	GS 6	
	O´ring G 35 x 2.40	GS 6	
	O´ring G 36 x 1.77	GS 6	
	O´ring G 44 x 5.15	GS 1	
	O´ring G 63 x 3.53	GS 1	
	O´ring G 66.5 x 3.40	GS 1	
	O´ring G 130 x 3.75	GS 1	

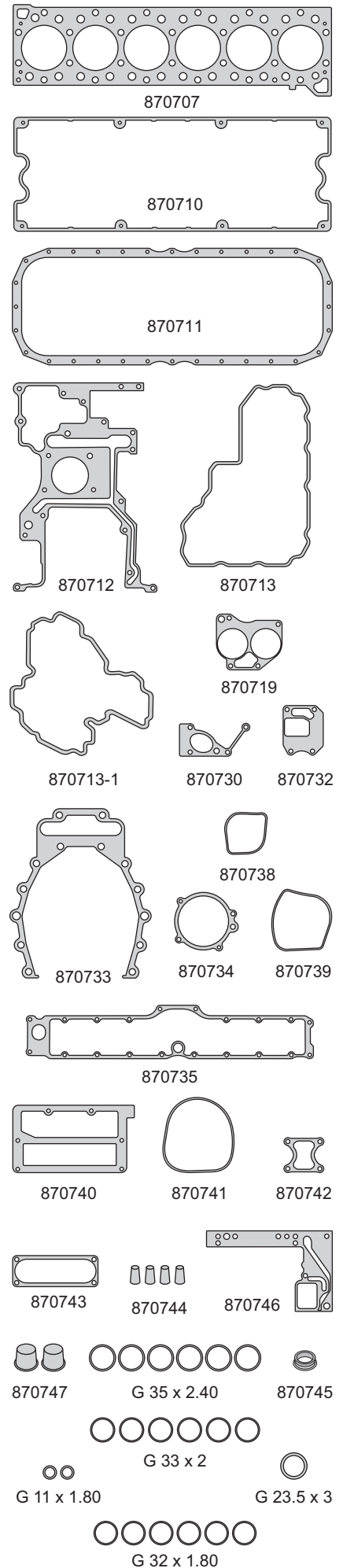

CUMMINS



Motor/Engine	Cm³	HP	Ø
ISF (SOHC) 16V	2776	150/156	94
DIESEL			

Cummins: ISF Series
Ford: F350, F4000 2014/...
Foton: Aumark 2012/...
VW: Delivery 4-150, 6-150
Volare: Cinco 2016/...



Nº OE	Descripción/Description	Mat.	Ref.
-	Jgo. de juntas para motor		870800-R MLS
4352430	Jgo. de juntas superior	●	870895
5257187	Jta. tapa cilindros Ø 95.0 ± 1.00	MLS 1	1 870808
	Junta tapa válvulas	GS 1	1 870810
5254612	Junta sello cárter de aceite	GS 1	1 870811
4980644	Junta sello cárter de aceite	GS 1	1 870811-1
5262686	Junta placa distribución	SLS 1	1 870812
5261421	Múltiple de escape	AC 1	1 870815
4983654	Múltiple de admisión	NB 1	1 870817
5255538	Junta salida de escape	AC 1	1 870818
	Junta salida de escape	AC 1	1 870818-1
5566796	Guarnición termostato	GS 1	1 870819
5262903	Junta enfriador de aceite	GS 1	1 870827
5255313	Guarnición cierre inyección	P 4	4 870830
5255312	Junta tapa válvulas	GS 1	1 870833
5263530	Sello cubierta transmisión cadena	GS 1	1 870837
5264426	Placa bomba vacio	SLS 1	1 870838
5269879	Junta sello bomba de agua 43 x 54 x 5	GS 1	1 870839
	Junta tubo salida de escape	AC 1	1 870840
5267993	Junta sensor velocidad	H 1	1 870841
3819900	Junta turbocompresor	NB 1	1 870842
5264477	Junta sello porta bancada	GS 1	1 870843
	Junta sello tapón tubo	GS 4	4 870844
	Arandela A 12.5 x 15.9 x 1.50 C	CU 4	4
	Arandela A 13.5 x 22.4 x 1.25	AC/GS	4
3035177	Arandela bba. combustible A 15.4 x 27.5 x 2.45 A	AL 1	1
	Arandela A 22 x 26.8 x 1.50 C	CU 1	1
4944374	O´ring indicador aceite G 5 x 1.80	GS 2	2
	O´ring G 7.9 x 1.40	GS 2	2
5259563	O´ring cuerpo bomba aceite G 8 x 1.56	GS 1	1
4903482	O´ring G 9 x 2	GS 1	1
3684088	O´ring G 9.5 x 2.36	GS 3	3
4954487	O´ring G 11 x 2.60	GS 1	1
	O´ring G 11 x 2.63	GS 3	3
4010519	O´ring termostato G 11.5 x 2.32	GS 1	1
	O´ring G 13 x 2	GS 3	3
5259924	O´ring cuerpo bomba aceite G 14 x 2	GS 2	2
4992560	O´ring turbocompresor G 15.75 x 2.58	GS 4	4
	O´ring G 17.5 x 2.60	GS 1	1
	O´ring tapón de válvula reguladora presión G 20 x 2	GS 1	1
	O´ring G 22 x 2.63	GS 1	1
	O´ring G 22 x 3.53	GS 1	1
4995185	O´ring cubierta cárter G 23.5 x 2.53	GS 1	1
	O´ring G 25 x 2.75	GS 1	1
	O´ring G 44 x 2.75	GS 1	1
5257072	O´ring entrada bomba de agua G 54.5 x 2.90	GS 1	1
3943913	O´ring G 65 x 2.56	GS 1	1
	O´ring G 108 x 3.5	GS 1	1
	Kit de retenes completo		R870800
4976170	Jgo. retén guía de válvulas (16)	V 1	1 R870810V
4352243	Retén de bancada 110 x 125 x 13	T 1	1 R870811T
5265266	Retén bomba de aceite 65 x 50 x 8/10	T 1	1 R870813T

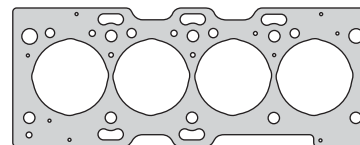

870808

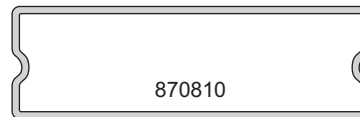

870810



870830

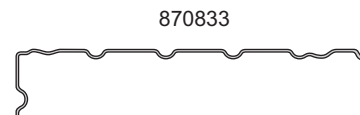

870833

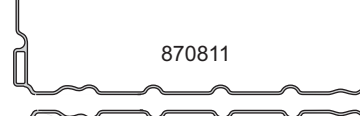

870811

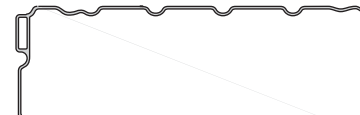

870811-1

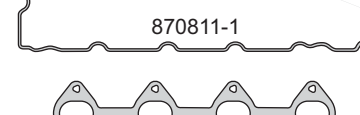

870815

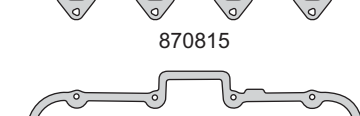

870817



870818

870818-1

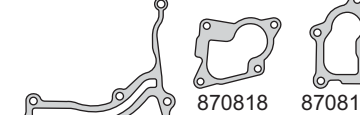

870812

870827

870819



870837

870838

870839

870843

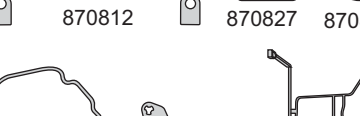

870840

870842

870841

870844



R870811T

R870813T

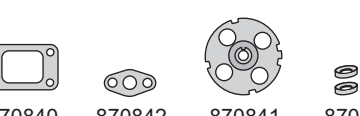

R870810V

CUMMINS



Motor/Engine	Cm³	HP	Ø
ISF (OHV) 16V	3759	148	102

Cummins: ISF Series
Camiones, Ómnibus, Pick-Up



DIESEL

Nº OE	Descripción/Description	Mat.	Ref.
-	Jgo. de juntas para motor	●	870900-R MLS
-	Jgo. de juntas superior	●	870995
4943051	Junta tapa cilin. Ø 103.0 ± 1.20	MLS	1 1 870908
4946239	Junta tapa válvulas	GS	1 1 870910
	Junta sello cárter de aceite	GS	1 1 870911
4980605	Junta placa distribución	SLS	1 1 870912
3955339	Jgo. múltiple de escape (4)	GFT	1 1 870915
4983020	Múltiple de admisión	SLS	1 1 870917
5255538	Junta salida de escape	AC	1 1 870818
	Junta salida de escape	AC	1 1 870818-1
3954829	Guarnición termostato	GS	1 1 870919
	Junta enfriador de aceite	GS	1 1 870827
	Guarnición goma	GS	1 1 870927
5317268	Guarnición cierre inyección	P	4 4 870930
4990276	Junta de la carcasa del enfriador de aceite	SLS	1 1 870935
5266066	Junta tapa transmisión bomba de aceite	NB	1 1 870937
	Junta tubo salida de escape	AC	1 1 870840
3819900	Junta turbocompresor	NB	1 1 870842
	Junta conexión escape	AC	1 1 870945
5253501	Anillo rectangular G 106 x 113 x 3.5	GS	1 1
	Anillo G 23 x 28 x 2.75	GS	2
	Anillo G 15 x 29 x 3	GS	2
	Arandela A 12 x 16 x 1.5 C	CU	4
	Arandela A 22 x 26 x 1.5 C	CU	1
	Arandela especial A 16 x 22 x 2.5/3.25 A	AC/GS	1
	Arandela especial A 12 x 18 x 2.5/3.25 A	AC/GS	1
	Arandela especial A 11.5 x 19.2 x 1.25/1.65 A	AC/GS	1 1
	Arandela especial A 13.5 x 22.2 x 1.25/1.65 A	AC/GS	1 1
	O`ring G 6 x 1.9	GS	1
	O`ring G 8 x 2	GS	3
	O`ring G 9.19 x 2.62	GS	1
4994237	O`ring G 10 x 1.9	GS	1 1
	O`ring G 10 x 2.4	GS	1 1
	O`ring G 10.77 x 2.62	GS	1
	O`ring G 12 x 1.90	GS	1
	O`ring G 14,5 x 2	GS	1 1
	O`ring G 17.12 x 2.62	GS	1
	O`ring G 18.64 x 3.53	GS	1 1
	O`ring G 20.22 x 3.53	GS	1
	O`ring G 23 x 3.10	GS	2
145536	O`ring G 32.99 x 2.62	GS	1 1
	O`ring G 48 x 3	GS	1 1
	O`ring G 53 x 3	GS	1
	O`ring G 75.92 x 1.78	GS	1 1
	O`ring G 82 x 1.8	GS	1
	Kit de retenes completo		R870900
4991571	Jgo. retén guía de válvulas (16)	V	1 1 R870910V
3968563	Reten bancada 130 x 150 x 14	T	1 R870911T
4890832	Reten distribución 70 x 100 x 12.5/16	T	1 R870912T
4938765	Reten bomba de aceite 24 x 40 x 7	V	1 1 R870913V

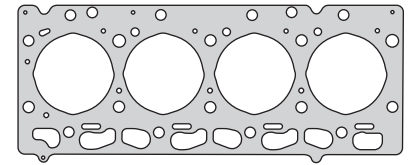

870908

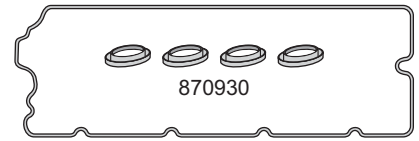

870930

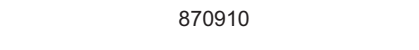

870910

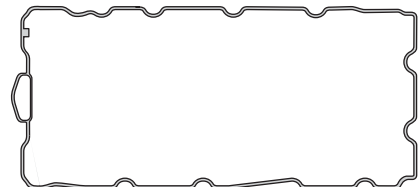

870911

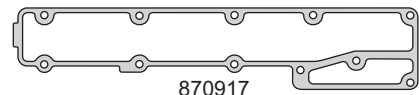

870917

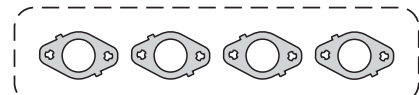

870915

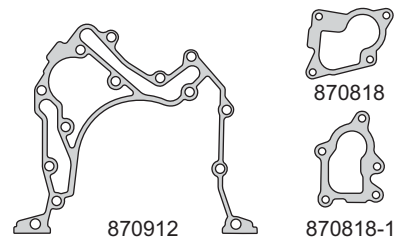

870912

870818

870818-1

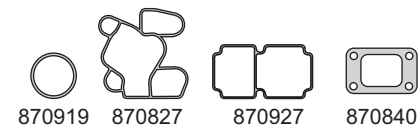

870919

870827

870927

870840

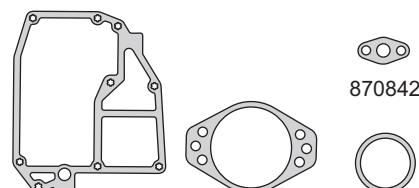

870935

870937

870945



G 12 x 1.9

G 23 x 3.1

G 14.5 x 2



G 53 x 3

G 75.92 x 1.78

G 82 x 1.8

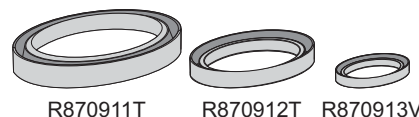

R870911T

R870912T

R870913V

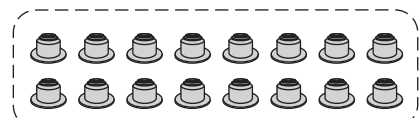

R870910V

CUMMINS



Motor/Engine **Cm³** **HP** **Ø**

ISX
(DOHC) 24V **14951** **405/475** **137**

Cummins: ISX Series
400, 425, 450, 460, 470, 475
Para motores con recirculación de gases de escape



DIESEL

Nº OE	Descripción/Description	Mat.	Ref.
	Jgo. de juntas para motor		871000-R
	Jgo. de juntas superior	●	871095
	Junta tapa cilin. Ø 147.0 ± 2.20	NFT	1 1 871007
	Junta para cárter	AC/GS	1 1 870711
	Junta tapa distribución	AC/GS	1 1 870712
	Guarnición sello distribución delantero	GS	1 1 871012
	Jgo. múltiple escape (5)	SLS	1 1 871015
	Junta termostato	AC/GS	1 1 871019
	Conexión entrada de agua	AC/GS	1 870730
	Junta válvula EGR	AC	2 2 871031
	Junta válvula EGR	AC	1 1 871032
	Carcasa de termostato	AC/GS	1 1 870732
	Junta carcasa volante	AC/GS	1 870733
	Base toma fuerza compresor aire	AC/GS	1 870734
	Enfriador aceite a block	AC/GS	1 870735
	Sello árbol de levas	GS	1 1 870738
	Sello árbol de levas	GS	1 1 870739
	Junta aislación de módulo control eléctrico	PLAST	1 1 871040
	Junta drenaje turbo	GFT	1 1 871041
	Junta montaje turbo	SLS	1 1 871042
	Junta entrada de aire	AC/GS	1 1 870743
	Tapón reparación canal de aceite	GS	4 4 870744
	Aro sello tubo retroceso aceite	AC/GS	1 1 870745
	Junta carcasa bomba combustible	AC/GS	1 1 870746
	Tubo conector	GS	1 2 871048
	Arandela especial A 13.7 x 22 x 1.5/2.5 A	AC/GS	2 6
	Arandela especial A 11.5 x 19 x 1.5/2.4 A	AC/GS	6 1
	Anillo G 12 x 17.5 x 9	GS	2
	Anillo G 76 x 82 x 2.6	GS	1 1
	Anillo G 94 x 102 x 2.6	GS	1 1
	O´ring G 7.52 x 3.53	GS	2
	O´ring G 11 x 2	GS	1
	O´ring G 10.82 x 1.78	GS	2
	O´ring G 12 x 1.90	GS	1 1
	O´ring G 16 x 1.90	GS	1 1
	O´ring G 24 x 3.1	GS	1
	O´ring G 24.99 x 3.53	GS	1
	O´ring G 25.07 x 2.62	GS	2 2
	O´ring G 29.74 x 3.53	GS	1
	O´ring G 30 x 3.20	GS	1
	O´ring G 31.47 x 1.78	GS	6 6
	O´ring G 28.17 x 3.53	GS	2
	O´ring G 34.59 x 2.62	GS	7 7
	O´ring G 34.65 x 1.78	GS	6 6
	O´ring G 33 x 1.78	GS	6 6
	O´ring G 43.82 x 5.33	GS	1
	O´ring G 63 x 3.1	GS	1
	O´ring G 66 x 3.1	GS	1
	O´ring G 82.22 x 2.62	GS	1 1
	O´ring G 94.92 x 2.62	GS	1 1
	O´ring G 132.94 x 3.53	GS	1 1
	O´ring G 164.69 x 3.53	GS	1 1
	Ret. bancada c/espaciador 165x197x16/21	T	1 R871011T
	Retén distribución 142.5 x 171/204 x 20	T	1 R871012T

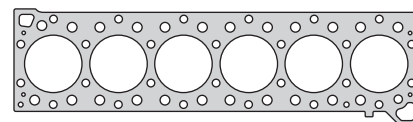

871007

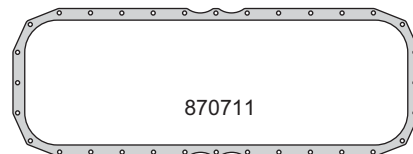

870711

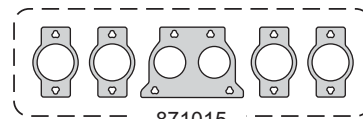

871015

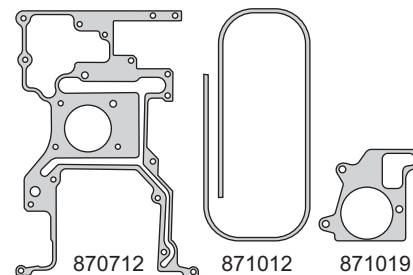

870712

871012

871019

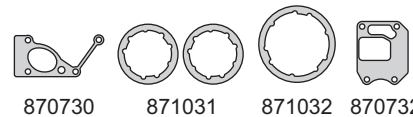

870730

871031

871032

870732

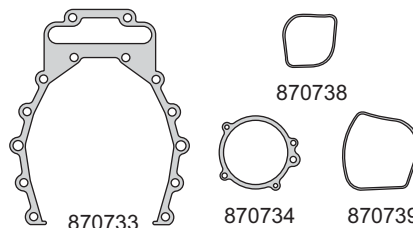

870733

870734

870738

870739

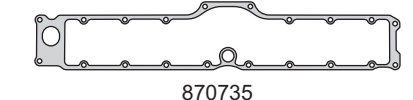

870735

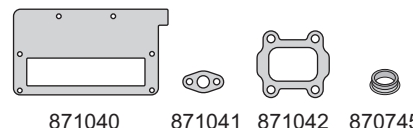

871040

871041

871042

870745



870743

870744

870746

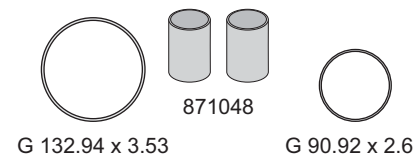

871048

G 132.94 x 3.53

G 90.92 x 2.62



G 82.22 x 2.62

G 65 x 3

G 43.82 x 5.33

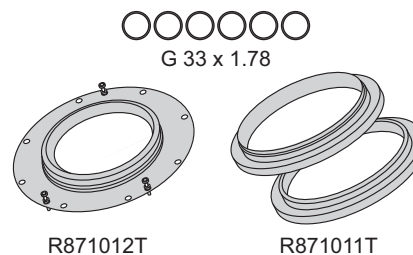

G 33 x 1.78

R871012T

R871011T

DEUTZ



Motor/Engine	Cm³	HP	Ø
F 2L 514 (SOHC) 4V	2660	56	110
DIESEL			

Deutz: Tractor A40



Nº OE	Descripción/Description	Mat.	1	2	Ref.
	Jgo. de juntas para motor		●	●	650000
	Jgo. jtas. reparación cabeza cilindros		●		650095
0858	Junta tapa válvulas	CG	1	2	650010
1540	Junta para cárter	CB		2	650011
8094023	Tapa distribución	CB		1	650012
8094022	Tapa trasera distribución	CB		1	650013
2215	Múltiple escape	FCH	2	4	650015
8094036	Filtro aceite	NB		1	650027
13358	Acople filtro combustible	NB		1	650028
809403709	Base bomba inyectora	CB		1	650029
8094031	Anillo deflector	CB		1	650030
8094032	Deflector	CB		1	650031
13359	Bomba alimentadora	NB		1	650032
D1520	Filtro mecánico	NB		1	650033
8094044	Tapa embutida	NB		1	650034
D1521	Arandela (4 agujeros)	NB		1	650035
D1522	Arandela (5 agujeros)	NB		1	650037
8094049	Bomba aceite	NB		3	650038
8094046	Tapa turbina	NB		1	650039
8094043	Caja reguladora	CB		3	650040
	Filtro aceite	CG		2	650041
D1529	Junta para cárter inferior	CB		1	650042
D1528	Brida	NB		1	650043
100021500	Descarga aceite tubo	GS	1	2	650044
1119	Retén guía válvulas G 16 x 4	GS	6	12	650045
1165994	Aro sello tubo retorno aceite G 12 x 3	GS	1	2	650046
8094115	Aro sello entrada radiador aceite G 25 x 4	GS		1	650047
	Aro sello radiador aceite G 28 x 4	GS		1	650048
8094116	Aro sello G 35 x 4	GS		1	650049
	Bomba vacío (todos)	NH			650055
0834	Intermedia tapa cilindros	NB	2	4	650062
0835	Intermedia tapa cilindros	CHA	1	2	650063
8094108	Aro sello o'ring G 10 x 2.5	GS	1	2	650064
	Arandela A 9 x 13 x 1 A	AL		13	650065
	Arandela A 31 x 36 x 1.5 A	AL		1	650066
	Arandela A 14 x 18 x 1 A	AL		26	650067
	Arandela A 10 x 14 x 1 A	AL		9	650068
	Arandela A 6 x 10 x 1 A	AL		8	650069
0407	Suplemento camisa cilindros 0.2 mm.	AC	1	2	650070-0.20
0407	Suplemento camisa cilindros 0.3 mm.	AC	1	2	650070-0.30
0406	Sello camisa cilindro o'ring G 110 x 4.5	GS	1	2	650072
	Arandela A 10 x 20 x 1.5 A	AL		11	650086
	Arandela A 18 x 23 x 1 A	AL		5	650087
D1523	Brida	CB		2	650088
	Retén bancada 150 x 172 x 18.3	P			R650411P

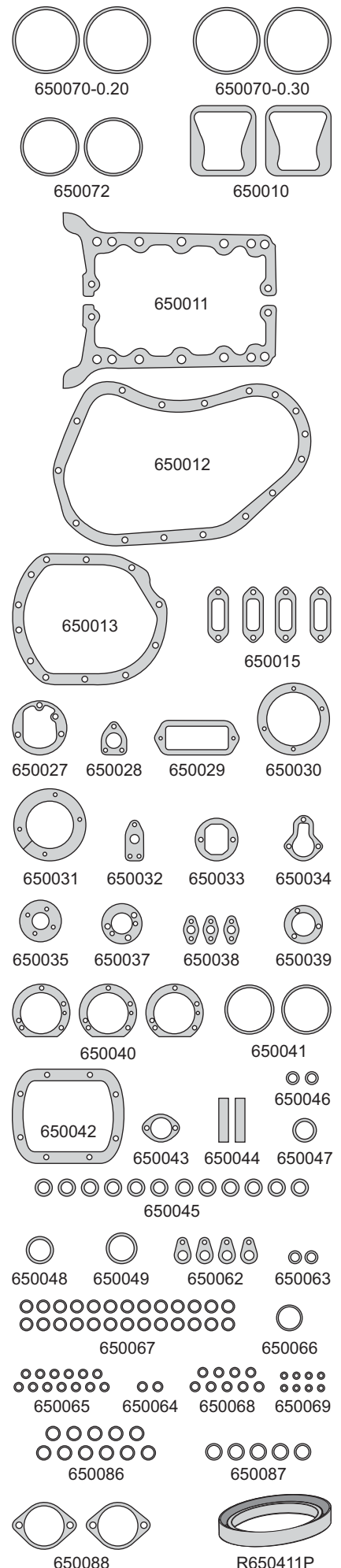

DEUTZ



Motor/Engine	Cm³	HP	Ø
F 6L 913 (OHV) 12V	6128	130	102
DIESEL			

Deutz: DD1000, DD9000 Camión
Tractor 1978/81
Ford: F7000 1978/81



Nº OE	Descripción/Description	Mat.	Ref.
	Jgo. de juntas para motor		650100-R
	Jgo. juntas reparación cabeza cilindro	●	650195
	Jgo. tornillos tapa cilindros (HAS17038)		B650100
	Jgo. tornillos tapa cilindros (HAS17038)		B650100-1
3371692	Junta tapa válvulas	NB 1	650110
3018117	Junta para cárter	CB 1	650111
3362505	Tapa distribución	CB 1	650112
3371689	Múltiple escape	FCH 1	650115
2230704	Múltiple admisión	NB 1	650117
2231127	Lateral tubo sobrealimentación salida escape	NFT 1	650118
13358	Acople filtro combustible	NB 1	650028
3362983	Soporte filtro aceite	NB 2	650129
1216307	Arandela fijación tapa válvulas	PLAST 1	650130
	Base sobrealimentador	NFT 1	650131
2134209	Tubo retorno aceite al turbo	NB 1	650132
2137840	Tapa y codo múltiple admisión	NB 2	650133
3362337	Tapa trasera cigüeñal	CB 1	650134
1231000	Tapa boca llenado aceite	CG 1	650135
	Arandela A 22 x 27 x 1.5 A	AL 1	650535
1166053	Tapa boca llenado aceite	CG 1	650137
1118764	Arandela tapón cabeza cil. A 26 x 32 x 2 A	AL 2	650138
1166103	Arandela base bomba inyectora G 74 x 3	GS 1	650139
3372164	Bomba inyectora A 10 x 21 x 2 C	CU 6	650140
1167425	Radiador aceite	GS 1	650141
1166002	Arandela tubo presión aceite G 14 x 3	GS 1	650142
1118836	Tapa ref. aceite A 45.5 x 52 x 2	GS	650143
	Arandela A 17 x 22 x 1 A	AL 2	650243
1118675	Tapa block A 12 x 16 x 1.5 A	AL 8	650144
D076031200	Arandela term. sobrepres. A 8 x 12 x 1 C	CU 14	650145
	Arandela A 10 x 14 x 1 A	AL 1	650146
2232527	Retén guía válvulas	GS 2	650147/1
2232527	Retén guía válvulas	GS 2	650147/2
	Bomba hidráulica motor	CB 1	650148
	Junta tapa válvulas	GS	650149
	Arandela A 10 x 16 x 1 A	AL 1	650068
2230216	Anillo intermedia cilindros	AC 1	650170
2137256	Suplemento camisa cilindros 0.2 mm.	AC 1	650170-0.20
2232693	Suplemento camisa cilindros 0.3 mm.	AC 1	650170-0.30
	Suplemento camisa cilindros 0.5 mm.	AC	650170-0.50
	Suplemento camisa cilindros 1.10 mm.	AC	650170-1.10
	Suplemento camisa cilindros 1.25 mm.	AC	650170-1.25
	Arandela A 18 x 23 x 1 A	AL 1	650087
	Jgo. retén válvulas (12)	P 1	R650110P
	Retén bancada 115 x 140 x 16	P 1	R650111P
	Retén distribución 65 x 85 x 13	P 1	R650112P



650170



650170-0.20



650170-0.30



650110

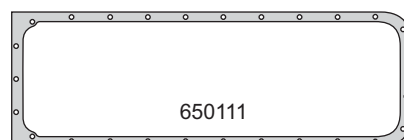

650111

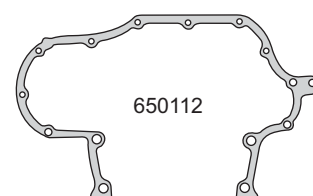

650112

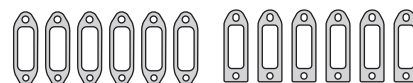

650115

650117



650118

650028

650129

650130



650132

650131

650133

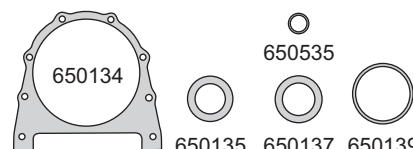

650134

650535

650135

650137

650139



650138



650140

650141

650142

650243



650144

650147/1

650143

650148



650147/2



650145

650146

650068

650087



R650111P



R650112P

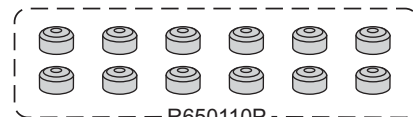

R650110P

DEUTZ



Motor/Engine	Cm³	HP	Ø
AF 2L 1114	2908	46	115
AF 2L 2114	2908	50	115
AF 2L 2114	3167		120

Deutz: Tractor 69/75 A46, 74/78 A65
1969/75

DIESEL



Nº OE	Descripción/Description	Mat.	Ref.
	Jgo. de juntas para motor		650200
	Jgo. jtas. reparación cabeza cilindros		650295
0858	Junta tapa válvulas	CG 1 2	650010
1540	Junta para cárter	CB 2	650011
8094023	Tapa distribución	CB 1	650012
8094022	Tapa trasera distribución	CB 1	650013
2215	Múltiple escape	FCH 2 4	650015
13358	Acople filtro combustible	NB 1	650028
809403709	Base bomba inyectora	CB 1	650029
8094031	Anillo deflector	CB 1	650030
8094032	Deflector	CB 1	650031
13359	Bomba alimentadora	NB 1	650032
D1520	Filtro mecánico	NB 1	650033
8094044	Tapa embutida	NB 1	650034
D1521	Arandela (4 agujeros)	NB 1	650035
D1522	Arandela (5 agujeros)	NB 1	650037
8094049	Bomba aceite	NB 3	650038
8094046	Tapa turbina	NB 1	650039
	Arandela A 14 x 20 x 1.5 A	AL 26	650539
8094043	Caja reguladora	CB 2	650040
	Arandela A 9 x 13 x 1 A	AL 15	650241
D1529	Junta para cárter inferior	CB 1	650042
	Arandela A 6 x 9 x 1 A	AL 2	650242
	Arandela A 17 x 22 x 1 A	AL 9	650243
100021500	Descarga aceite 1114	GS 1 2	650044
3017883	Descarga aceite 2114	GS 4	650244
1119	Retén guía válvulas G 16 x 4	GS 6 12	650045
1165994	Aro sello tubo retorno aceite G 12 x 3	GS 1 2	650046
100172700	Intermedia tapa cilindros (corta)	CHA 1 2	650262
0835	Intermedia tapa cilindros	CHA 1 2	650063
100172800	Intermedia tapa cilindros (larga)	CHA 1 2	650263
8094108	Aro sello G 10 x 2.5	GS 1 2	650064
	Arandela A 31 x 36 x 1.5 A	AL 1	650066
	Arandela A 10 x 14 x 1 A	AL 9	650068
	Arandela A 6 x 10 x 1 A	AL 4	650069
0407	Suplemento camisa cilindros 0.2 mm.	AC 1 2	650070-0.20
0407	Suplemento camisa cilindros 0.3 mm.	AC 1 2	650070-0.30
810292702	Sello camisa cilindros G 115 x 2	GS 1 2	650272
	Arandela A 18 x 23 x 1 A	AL 9	650087
D1523	Brida	CB 2	650088
	Retén bancada 150 x 172 x 18.30	P	R650411P
	Retén distribución 110 x 140 x 16	S	R650212S

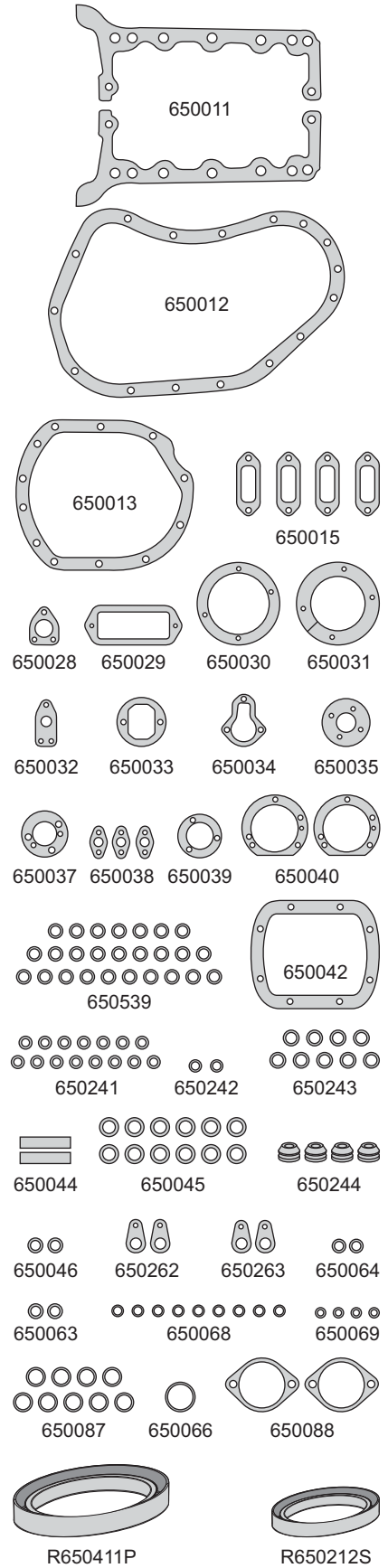
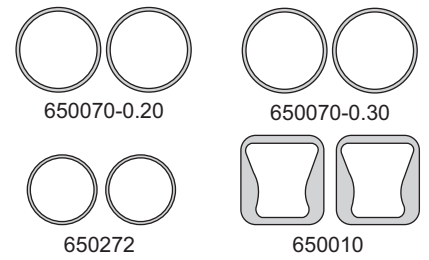

DEUTZ



Motor/Engine	Cm³	HP	Ø
F 3L 514 (OHV) 6V	3990	50	110

Deutz: Tractor A55 1959/69

DIESEL



Nº OE	Descripción/Description	Mat.	Ref.
	Jgo. de juntas para motor		650300
	Jgo. jtas. reparación cabeza cilindros		650395
0858	Junta tapa válvulas	CG 1 3	650010
8094027	Junta para cárter	CB 2	650311
8094023	Tapa distribución	CB 1	650012
8094022	Tapa trasera distribución	CB 1	650013
2215	Múltiple escape	FCH 2 6	650015
	Salida de escape	NFT 1	650318
8094036	Filtro aceite	NB 1	650027
13358	Acople filtro combustible	NB 1	650028
8094037	Base bomba inyectora	CB 1	650329
8094031	Anillo deflector	CB 1	650030
8094032	Deflector	CB 1	650031
13359	Bomba alimentadora	NB 1	650032
D1520	Filtro mecánico	NB 1	650033
8094044	Tapa embutida	NB 1	650034
D1521	Arandela (4 agujeros)	NB 1	650035
8094030	Junta tapa válvulas lateral	CB 1	650336
D1522	Arandela (5 agujeros)	NB 1	650037
8094049	Bomba aceite	NB 3	650038
8094046	Tapa turbina	NB 1	650039
8094043	Caja reguladora	CB 3	650040
	Filtro aceite	CG 2	650041
D1528	Brida	NB 1	650043
100021500	Descarga aceite	GS 3	650044
3017883	Descargo aceite	GS 2	650244
1119	Retén guía válvulas G 16 x 4	GS 6 18	650045
1165994	Aro sello tubo retorno aceite G 12 x 3	GS 1 3	650046
8094115	Aro sello entrada radiador aceite G 25 x 4	GS 1	650047
	Aro sello radiador aceite G 28 x 4	GS 1	650048
8094116	Aro sello G 35 x 4	GS 1	650049
	Bancada 150 x 170 x 10	SNA 1	650358
0834	Intermedia tapa cilindros	NB 6	650062
100172700	Intermedia tapa cilindros (corta)	CHA 1	650262
0835	Intermedia tapa cilindros	CHA 1 3	650063
100172800	Intermedia tapa cilindros (larga)	CHA 1	650263
8094108	Aro sello G 10 x 2.5	GS 1 3	650064
	Arandela A 9 x 13 x 1 A	AL 13	650065
	Arandela A 31 x 36 x 1.5 A	AL 1	650066
	Arandela A 14 x 18 x 1 A	AL 26	650067
	Arandela A 6 x 10 x 1 A	AL 8	650069
0407	Suplemento camisa cilindros 0.2 mm.	AC 1 3	650070-0.20
0407	Suplemento camisa cilindros 0.3 mm.	AC 1 3	650070-0.30
810292702	Sello camisa cilindros G 110 x 4.5	GS	650072
	Sello camisa cilindros G 115 x 2	GS 1 3	650272
	Arandela A 10 x 20 x 1.5 A	AL 1	650086
D1523	Arandela A 18 x 23 x 1 A	AL 5	650087
	Brida	CB 2	650088
	Retén bancada 150 x 172 x 18.30	P	R650411P
	Retén distribución 110 x 140 x 16	S	R650212S

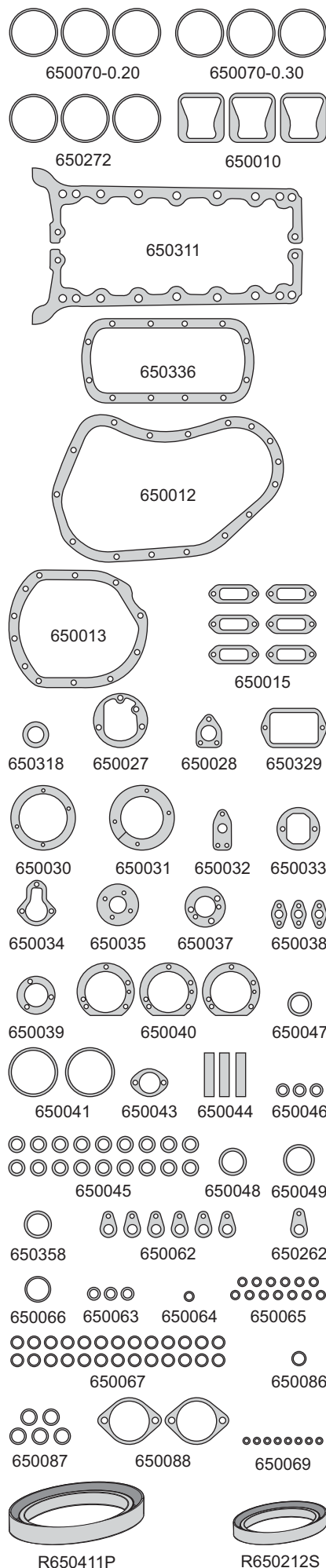

DEUTZ



Motor/Engine	Cm³	HP	Ø
F 4L 514 (OHV) 8V	5320	65	110

Deutz: Tractor 470 1959/69



DIESEL

Nº OE	Descripción/Description	Mat.	Ref.
	Jgo. de juntas para motor		650400
	Jgo. jtas. reparación cabeza cilindros		650095
0858	Junta tapa válvulas	CG 1 4	650010
1529	Junta para cárter	GS 1	650411
8094007	Junta tapa distribución delantera	CB 1	650412
8094008	Tapa trasera distribución	CB 1	650413
2215	Múltiple escape	FCH 2 8	650015
	Salida de escape	NFT 1	650318
1042404	Filtro aceite	NB 2	650427
13358	Acople filtro combustible	NB 1	650028
22DIN71511	Filtro aceite	NB 1	650429
8094014	Tapa leva	NB 1	650430
3469892	Soporte filtro aceite	NB 1	650532
D1521	Arandela (4 agujeros)	NB 1	650035
8094049	Bomba aceite	NB 3	650038
8094046	Tapa turbina	NB 1	650039
	Filtro aceite	CG 2	650041
100021500	Descarga aceite	GS 1 4	650044
1119	Retén guía válvulas G 16 x 4	GS 6 24	650045
1165994	Aro sello tubo retorno aceite G 12 x 3	GS 1 4	650046
8094115	Aro sello entrada radiador aceite G 25 x 4	GS 1	650047
	Aro sello radiador aceite G 28 x 4	GS 1	650048
8094116	Aro sello G 35 x 4	GS 1	650049
	Bancada 150 x 170 x 10	SNA 1	650358
0834	Intermedia tapa cilindros	NB 2 8	650062
0835	Intermedia tapa cilindros	CHA 1 4	650063
8094108	Aro sello G 10 x 2.5	GS 1 4	650064
	Arandela A 9 x 13 x 1 A	AL 13	650065
	Arandela A 31 x 36 x 1.5 A	AL 1	650066
	Arandela A 14 x 18 x 1 A	AL 26	650067
	Arandela A 10 x 14 x 1 A	AL 9	650068
	Arandela A 6 x 10 x 1 A	AL 8	650069
0407	Suplemento camisa cilindros 0.2 mm.	AC 1 4	650070-0.20
0407	Suplemento camisa cilindros 0.3 mm.	AC 1 4	650070-0.30
0406	Sello camisa cilindros G 110 x 4.5	GS 1 4	650072
	Arandela A 10 x 20 x 1.5 A	AL 11	650086
	Arandela A 18 x 23 x 1 A	AL 5	650087
	Retén bancada 150 x 172 x 18.30	P	R650411P

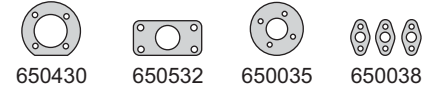
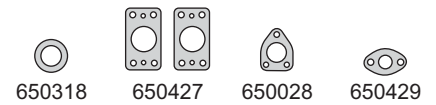
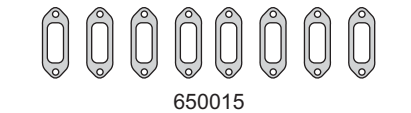
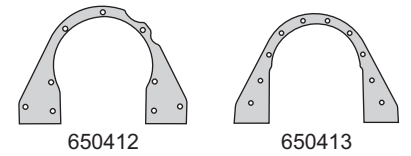
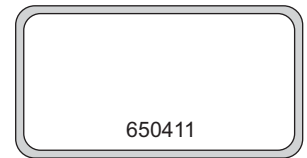
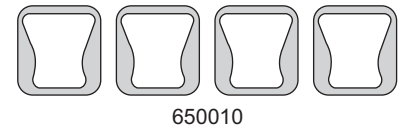
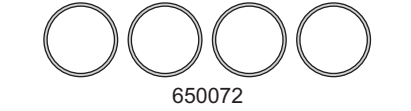

DEUTZ



Motor/Engine **F 6L 514**
(OHV) 12V

Cm³ **7980**

HP

Ø **110**

Deutz: Tractor A110 1959/69



DIESEL

Nº OE	Descripción/Description	Mat.	1	2	Ref.
	Jgo. de juntas para motor				650500
	Jgo. jtas. reparación cabeza cilindros		●	●	650095
0858	Junta tapa válvulas	CG	1	6	650010
10611070	Junta para cárter	GS	1	1	650511
8094007	Tapa distribución delantera	CB	1	1	650412
8094008	Tapa trasera distribución	CB	1	1	650413
2215	Múltiple escape	FCH	2	12	650015
	Salida de escape	NFT	1	1	650318
1042404	Filtro aceite	NB	2	2	650427
13358	Acople filtro combustible	NB	1	1	650028
22DIN71511	Filtro aceite	NB	1	1	650429
1061106	Tapa distribución	CG	1	1	650529
8094031	Anillo deflector	CB	1	1	650030
	Base filtro	CB	1	1	650531
3469892	SopORTE filtro aceite	NB	1	1	650532
	Filtro aceite	CB	1	1	650533
26DIN71511	Caño radiador aceite	NB	1	1	650534
	Arandela A 22 x 27 x 1.5 A	AL	3	3	650535
	Arandela A 26 x 32 x 2 A	AL	1	1	650537
	Arandela A 36 x 42 x 1.5 A	AL	2	2	650538
	Arandela A 14 x 20 x 1.5 A	AL	24	24	650539
	Aro sello G 320 x 8 turbina	GS	1	1	650540
	Filtro aceite	CG	2	2	650041
100021500	Descarga aceite	GS	1	6	650044
1119	Retén guía válvulas G 16 x 4	GS	6	36	650045
1165994	Aro sello tubería retorno aceite G 12 x 3	GS	1	6	650046
8094115	Aro sello entrada radiador aceite G 25 x 4	GS	1	1	650047
	Aro sello radiador aceite G 28 x 4	GS	1	1	650048
8094116	Aro sello G 35 x 4	GS	1	1	650049
	Bancada cigüeñal 120 x 140 x 10	SNA	1	1	650558
	Bancada cigüeñal del. 70 x 90 x 10	SNA	1	1	650858
0834	Intermedia tapa cilindros	NB	2	12	650062
0835	Intermedia tapa cilindros	CHA	1	6	650063
8094108	Aro sello G 10 x 2.5	GS	1	6	650064
	Arandela A 9 x 13 x 1 A	AL	20	20	650065
	Arandela A 31 x 36 x 1.5 A	AL	1	1	650066
	Arandela A 10 x 14 x 1 A	AL	10	10	650068
	Arandela A 6 x 10 x 1 A	AL	6	6	650069
0407	Suplemento camisa cilindros 0.2 mm.	AC	1	6	650070-0.20
0407	Suplemento camisa cilindros 0.3 mm.	AC	1	6	650070-0.30
0406	Sello camisa cilindros G 110 x 4.5	GS	1	6	650072
	Arandela A 18 x 23 x 1 A	AL	6	6	650087
	Retén bancada 150 x 172 x 18.30	P			R650411P

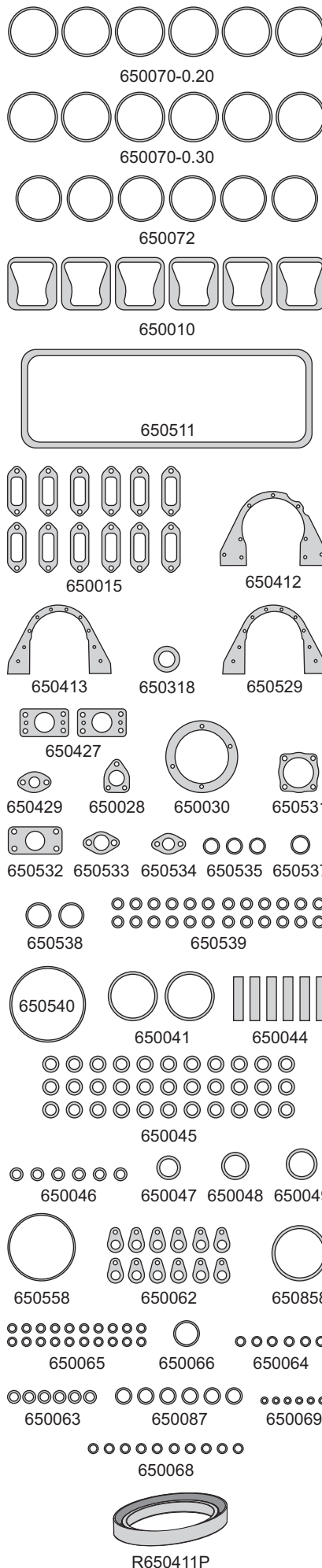

DEUTZ



Motor/Engine	Cm³	HP	Ø
AF 3L 1114	4363		115
AF 3L 2114	4750		120

Deutz: Tractor A65 1969/78



DIESEL

Nº OE	Descripción/Description	Mat.			Ref.
	Jgo. de juntas para motor				650600
	Jgo. jtas. reparación cabeza cil. 1114				650295
	Jgo. jtas. reparación cabeza cil. 2114				650395
0858	Junta tapa válvulas	CG	1	3	650010
8094027	Junta para cárter	CB		2	650311
8094023	Tapa distribución	CB		1	650012
8094022	Tapa trasera distribución	CB		1	650013
2215	Múltiple escape	FCH	2	6	650015
	Salida de escape	NFT		1	650318
13358	Acople filtro combustible	NB		1	650028
809403709	Base bomba inyectora	CB		1	650029
8094037	Base bomba inyectora	CB		1	650329
8094031	Anillo deflector	CB		1	650030
8094032	Deflector	CB		1	650031
13359	Bomba alimentadora	NB		1	650032
D1520	Filtro mecánico	NB		1	650033
8094044	Tapa embutida	NB		1	650034
D1521	Arandela 4 agujeros	NB		1	650035
8094030	Junta tapa válvulas lateral	CB		1	650336
8094049	Bomba aceite	NB		3	650038
8094046	Tapa turbina	NB		1	650039
	Arandela A 14 x 20 x 1.5 A	AL		28	650539
8094043	Caja reguladora	CB		2	650040
	Arandela A 8 x 13 x 1 A	AL		19	650241
	Arandela A 17 x 22 x 1 A	AL		11	650243
100021500	Descarga aceite 1114	GS	1	3	650044
3017883	Descarga aceite 2114	GS		6	650244
1119	Retén guía válvulas G 16 x 4	GS	6	18	650045
1165994	Aro sello tubo retorno aceite G 12 x 3	GS	1	3	650046
	Bancada cigüeñal 150 x 170 x 10	SNA		1	650358
100172700	Intermedia tapa cilindros (corta)	CHA	1	3	650262
0835	Intermedia tapa cilindros	CHA	1	3	650063
100172800	Intermedia tapa cilindros (larga)	CHA	1	3	650263
8094108	Aro sello G 10 x 2.5	GS	1	3	650064
	Arandela A 31 x 36 x 1.5 A	AL		1	650066
	Arandela A 10 x 14 x 1 A	AL		9	650068
	Arandela A 6 x 10 x 1 A	AL		3	650069
0407	Suplemento camisa cilindros 0.2 mm.	AC	1	3	650070-0.20
0407	Suplemento camisa cilindros 0.3 mm.	AC	1	3	650070-0.30
810292702	Sello camisa cilindros G 115 x 2	GS	1	3	650272
	Arandela A 18 x 23 x 1 A	AL		9	650087
	Retén bancada 150 x 172 x 18.30	P			R650411P
	Retén distribución 110 x 140 x 16	S			R650212S

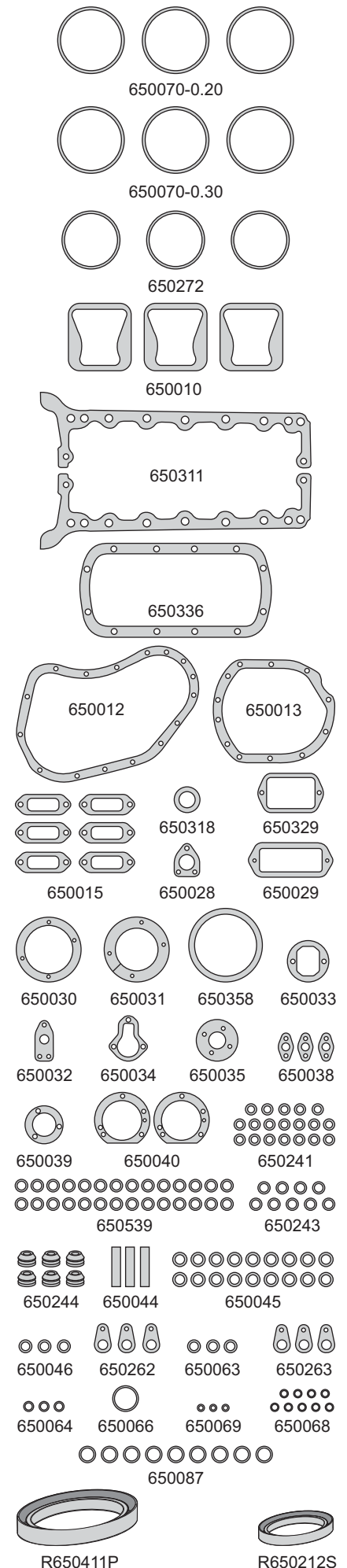

DEUTZ



Motor/Engine	Cm³	HP	Ø
AF 4L 1114	5817		115
AF 4L 2114	6333		120

Deutz: Tractor A85 1969/78



DIESEL

Nº OE	Descripción/Description	Mat.	1	2	Ref.
	Jgo. de juntas para motor				650700
	Jgo. jtas. reparación cabeza cil. 1114		●		650295
	Jgo. jtas. reparación cabeza cil. 2114				650395
0858	Junta tapa válvulas	CG	1	4	650010
1529	Junta para cárter	GS		1	650411
8094007	Tapa delantera distribución	CB		1	650412
8094008	Tapa trasera distribución	CB		1	650413
2215	Múltiple escape	FCH	2	8	650015
	Salida de escape	NFT		1	650318
1042404	Filtro aceite	NB		2	650427
13358	Acople filtro combustible	NB		1	650028
22DIN71511	Filtro aceite	NB		2	650429
8094014	Tapa leva	NB		1	650430
3469892	Soporte filtro aceite	NB		1	650532
26DIN71511	Caño radiador aceite	NB		2	650534
	Arandela A 22 x 27 x 1.5 A	AL		1	650535
	Arandela A 26 x 32 x 2 A	AL		1	650537
8094049	Bomba aceite	NB		2	650038
	Arandela A 36 x 42 x 1.5 A	AL		2	650538
	Arandela A 14 x 20 x 1.5 A	AL		20	650539
	Aro sello G 320 x 8	GS		1	650540
	Arandela A 8 x 13 x 1 A	AL		16	650241
	Arandela A 6 x 9 x 1 A	AL		2	650242
100021500	Descarga aceite 1114	GS	1	4	650044
3017883	Descarga aceite 2114	GS		8	650244
1119	Retén guía válvulas G 16 x 4	GS	6	24	650045
1165994	Aro sello tub. retorno aceite G 12 x 3	GS	1	4	650046
8094115	Aro sello entrada radiador aceite G 25 x 4	GS		4	650047
	Aro sello radiador aceite G 28 x 4	GS		1	650048
8094116	Aro sello G 35 x 4	GS		1	650049
	Bancada cigüeñal 150 x 170 x 10	SNA		1	650358
100172700	Intermedia tapa cilindros (corta)	CHA	1	4	650262
0835	Intermedia tapa cilindros	CHA	1	4	650063
100172800	Intermedia tapa cilindros (larga)	CHA	1	4	650263
8094108	Aro sello G 10 x 2.5	GS	1	4	650064
	Arandela A 31 x 36 x 1.5 A	AL		1	650066
	Arandela A 10 x 14 x 1 A	AL		10	650068
	Arandela A 6 x 10 x 1 A	AL		1	650069
0407	Suplemento camisa cilindros 0.2 mm.	AC	1	4	650070-0.20
0407	Suplemento camisa cilindros 0.3 mm.	AC	1	4	650070-0.30
810292702	Sello camisa cilindros G 115 x 2	GS	1	4	650272
	Arandela A 18 x 23 x 1 A	AL		13	650087
	Retén bancada 150 x 172 x 18.30	P			R650411P
	Retén distribución 110 x 140 x 16	S			R650212S

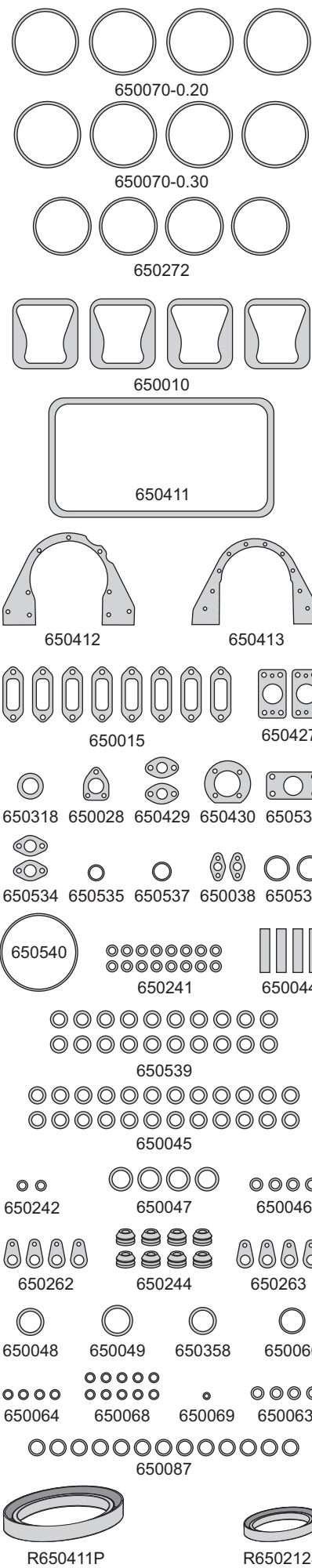

DEUTZ



Motor/Engine	Cm³	HP	Ø
AF 6L 1114	8725		115
BF 6L 2114 (OHV) 12V	9500		120

Deutz: Tractor A130, A144 1969/78
Bus Turbo



DIESEL

Nº OE	Descripción/Description	Mat.	Ref.
	Jgo. de juntas para motor		650800
	Jgo. jtas. reparación cabeza cil. 1114		650295
	Jgo. jtas. reparación cabeza cil. 2114		650395
0858	Junta tapa válvulas	CG 1 6	650010
10611070	Junta para cárter	GS 1	650511
8094007	Tapa distribución delantera	CB 1	650412
8094008	Tapa trasera distribución	CB 1	650413
2215	Múltiple escape	FCH 2 12	650015
	Salida de escape	NFT 1	650318
1042404	Filtro aceite	NB 2	650427
13358	Acople filtro combustible	NB 1	650028
22DIN71511	Filtro aceite	NB 1	650429
1061106	Tapa distribución	CG 1	650529
8094014	Tapa leva	NB 1	650430
3469892	Soporte filtro aceite	NB 1	650532
	Filtro aceite	CB 1	650533
26DIN71511	Caño radiador aceite	NB 1	650534
	Arandela A 22 x 27 x 1 A	AL 1	650535
	Arandela A 26 x 32 x 2 A	AL 1	650537
	Arandela A 36 x 42 x 1.5 A	AL 2	650538
	Arandela A 14 x 20 x 1.5 A	AL 20	650539
	Aro sello G 320 x 8	GS 1	650540
	Filtro aceite	CG 2	650041
	Arandela A 8 x 13 x 1 A	AL 20	650241
	Arandela A 6 x 9 x 1 A	AL 4	650242
100021500	Descarga aceite 1114	GS 1 6	650044
3017883	Descarga aceite 2114	GS 12	650244
1119	Retén guía válvulas G 16 x 4	GS 6 36	650045
1165994	Aro sello tubo retorno aceite G 12 x 3	GS 1 6	650046
8094115	Aro sello entrada radiador aceite G 25 x 4	GS 4	650047
8094116	Aro sello G 35 x 4	GS 1	650049
	Bancada cigüeñal 120 x 140 x 10	SNA 1	650558
	Bancada cigüeñal delantera 70 x 90 x 10	SNA 1	650858
100172700	Intermedia tapa cilindros (corta)	CHA 1 6	650262
0835	Intermedia tapa cilindros	CHA 1 6	650063
100172800	Intermedia tapa cilindros (larga)	CHA 1 6	650263
8094108	Aro sello G 10 x 2.5	GS 1 6	650064
	Arandela A 31 x 36 x 1.5 A	AL 1	650066
	Arandela A 10 x 14 x 1 A	AL 15	650068
	Arandela A 6 x 10 x 1 A	AL 1	650069
0407	Suplemento camisa cilindros 0.2 mm.	AC 1 6	650070-0.20
0407	Suplemento camisa cilindros 0.3 mm.	AC 1 6	650070-0.30
810292702	Sello camisa cilindros G 115 x 2	GS 1 6	650272
	Arandela A 18 x 23 x 1 A	AL 12	650087
	Retén bancada 150 x 172 x 18.30	P	R650411P
	Retén distribución 110 x 140 x 16	S	R650212S

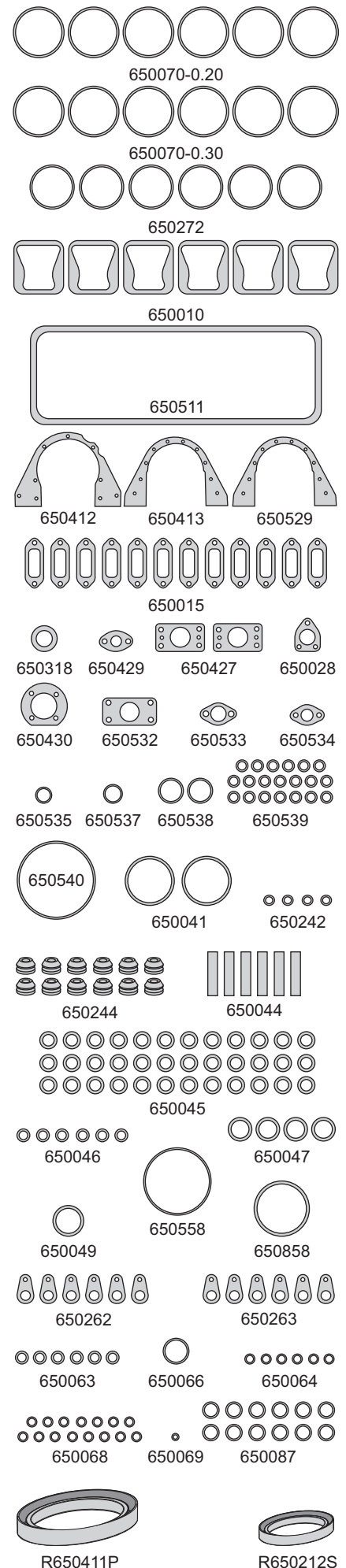

DEUTZ



Motor/Engine	Cm³	HP	Ø
F 8L 413 V8 16V	11309		120
DIESEL			

Deutz: 200 D16, 200 D19, 200 D2M
200 RS, 210 EV 120, Tractor 5020
1969/77



Nº OE	Descripción/Description	Mat.	Ref.
	Jgo. de juntas para motor		650900-R
2402812	Junta tapa válvulas	CG 8	650910
2403211	Junta para cárter	NB 1	650911
3361393	Tapa delantera distribución	CB 1	650912
3361324	Tapa trasera distribución	CB 1	650913
3362170	Múltiple escape	AC 8	650915
2407259	Múltiple admisión	AC 8	650917
13358	Acople filtro combustible	NB 1	650028
2192080	Tapa trasera árbol levas	CB 1	650929
1216307	Arandela fijación tapa válvulas	PLAST 8	650130
3371139	Boca ventilación cárter	CB 1	650931
1171077	Aro sello porta balancines	GS 16	650932
2144131	Tapón tubo protector balancines	GS 16	650933
1169597	Aro sello cañería retorno bomba inyectora	GS 1	650934
	Arandela A 22 x 27 x 1.5 A	AL 1	650535
2403940	Retén guía válvulas	GS 16	650935
	Arandela A 26.5 x 31.5 x 2 A	AL 1	650537
3361627	Caño botadores	16	650937
	Arandela A 36 x 42 x 1.5 A	AL 9	650538
3361630	Descarga aceite a block	GS 8	650938
3361629	Descarga aceite a block	GS 8	650939
3361272	Caño botadores	16	650940
	Arandela A 8 x 13 x 1 A	AL 2	650241
1170540	Aro sello porta tobera bomba inyectora	10	650941
3361699	Base radiador aceite	GS 1	650942
3361698	Base filtro aceite	GS 1	650943
2407947	Aro sello tapa turbo ventilador	GS 1	650944
	Arandela A 16 x 20 x 1 A	AL 1	650945
	Arandela A 9 x 13 x 1 A	AL 16	650065
	Arandela A 31 x 36 x 1.5 A	AL 1	650066
	Arandela A 14 x 18 x 1 A	AL 18	650067
	Arandela A 10 x 14 x 1 A	AL 19	650068
2403141	Suplemento camisa cilindro 0.2 mm.	AC 8	650970-0.20
2403142	Suplemento camisa cilindro 0.3 mm.	AC 8	650970-0.30
2402639	Aro sello camisa cilindros	GS 8	650972
	Arandela A 18 x 23 x 1 A	AL 2	650087
	Retén bancada 150 x 172 x 18.30	P 1	R650411P
	Retén distribución 100 x 120 x 15	P 1	R650912P

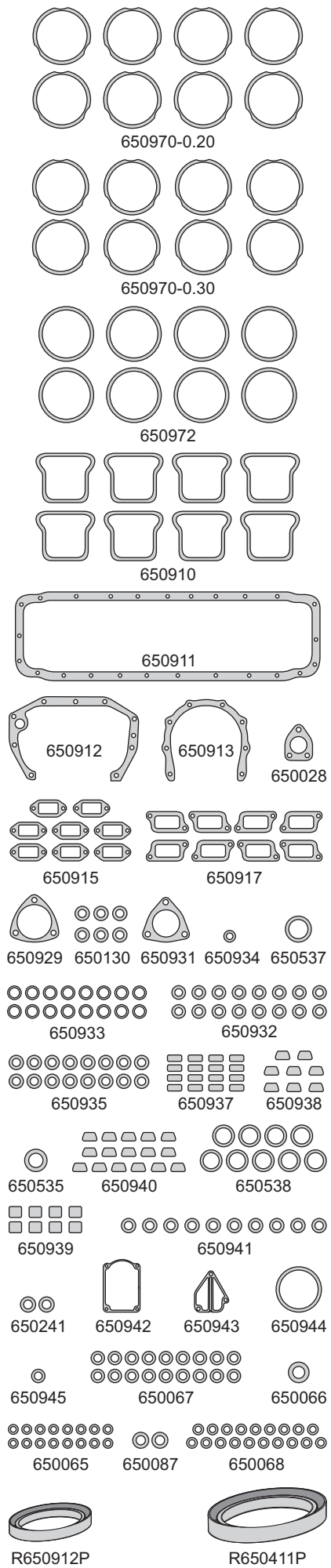

DEUTZ

Motor/Engine

Cm³

HP

Ø

F 8L 413 F
V8 16V

11309

205

125

Deutz: Estacionarios 0302 6472 AY 0148-00
0301 7177 UY 0147-00
Vehicular Omnibus - Camiones
0302 6545 AY 0148-00
0301 7177 UY 0147-00



DIESEL

Nº OE	Descripción/Description	Mat.	Ref.
2911536	Jgo. de juntas para motor		651000-R
	Jgo. reparación cabeza cilindros		651095
2406592	Jgo. tornillos tapa cilindros		B650900
2144838	Junta tapa válvulas	CG 1 8	651010
2131577	Junta para cárter	NB 1	650911
3361393	Junta frente motor	NB 1	650912
3361324	Junta porta retén trasero	NB 1	650913
41419791	Múltiple escape	AC 1 8	651015
4141486	Múltiple admisión	AC 1 8	650917
3029697	Salida de escape	NFT 2	650318
2410725	Junta carcasa bomba de aceite	NB 1	650927
3018849	Junta bomba de alimentación	NB 1	650028
2192080	Junta trasera árbol de levas	CB 1	650929
2141519	Anillo fijación tapa de válvulas A 8 x 15.5	PLAST 1 8	650130
3371139	Junta boca base llenado de aceite	CB 1	650931
2144877	Junta caja balancines	NB 1 8	651036
2423671	Anillo hermetización	PLAST 1 8	651037
1120804	Junta tubería de aceite	NB 1	651038
1216293	Junta tapa llenado de aceite G 60 x 38 x 2	GS 1	450041
3361699	Junta base radiador aceite	GS 1	650942
2417871-1	Junta base filtro aceite	GS 1	651043
3370133	Rodillo amortiguador turbo ventilador	GS 4	650964
3361338	Anillo tubo balancín G 16 x 20 x 12	GS 1	650965
1120804	Junta cañería aceite	CB 1	651066
1163871	O´ring camisa cilindros G 140 x 3	GS 1 8	651070
4183249	Jgo. suplemento camisa cilindros (0.50) (8)	AC 1 1	651070-0.50
4183250	Jgo. suplemento camisa cilindros (0.70) (8)	AC 1 1	651070-0.70
4183251	Jgo. suplemento camisa cilindros (1.00) (8)	AC 1 1	651070-1.00
1171939	O´ring G 18 x 4	GS 4 32	
	O´ring G 20 x 4	GS 1 8	
1171077	O´ring G 10 x 4	GS 2 16	
1165996	O´ring G 12 x 3	GS 1	
1174733	O´ring G 8 x 3	GS 1 8	
1166075	O´ring G 45 x 4.5	GS 1	
1165975	O´ring G 5 x 2	GS 1	
1166045	O´ring G 30 x 4	GS 1	
1167374	O´ring G 25 x 2	GS 4	
1166089	O´ring G 60 x 4	GS 1	
1161249	O´ring G 170 x 6	GS 1	
1167379	O´ring G 40 x 3	GS 1	
1164294	O´ring G 120 x 4	GS 1	
1161019	O´ring G 25 x 4	GS 2	
2403867	Arandela pico inyector A 10 x 21 x 2 C	CU 1 8	
1107101	Arandela A 8 x 11.5 x 1 C	CU 4 32	
1118654	Arandela A 8 x 14 x 1.5 C	CU 15	
1118784	Arandela A 30 x 36 x 1.5 C	CU 3	
2403108	Arandela A 14.5 x 18 x 1.25 C	CU 18	
1118664	Arandela A 10 x 14 x 1.25 C	CU 20	
1118693	Arandela A 14 x 20 x 1.25 C	CU 6	
1118718	Arandela A 18 x 24 x 1.25 C	CU 1	
3370359	Arandela A 6 x 12 x 1 C	CU 20	
1107095	Arandela A 7 x 14 x 1 C	CU 4	
2133325	Arandela A 22 x 27 x 1.5 A	AL 3	

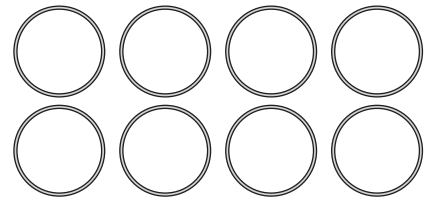

651070

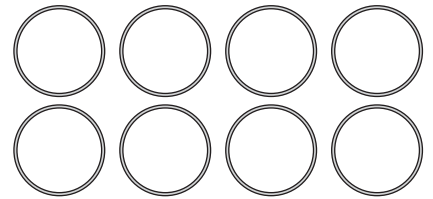

651070-0.50

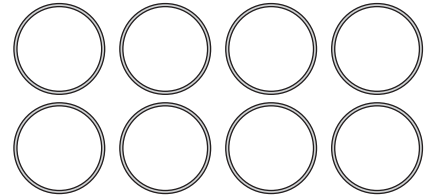

651070-0.70

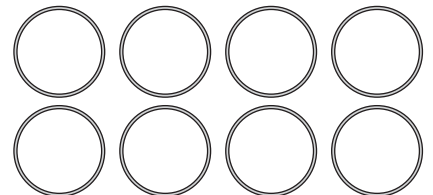

651070-1.00

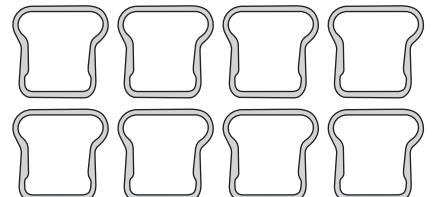

651010

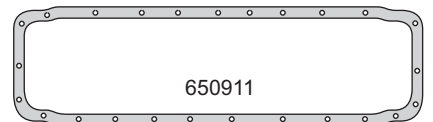

650911

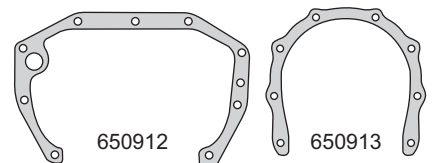

650912

650913

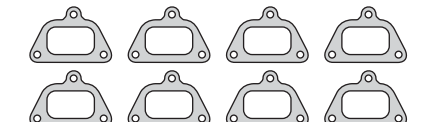

651015

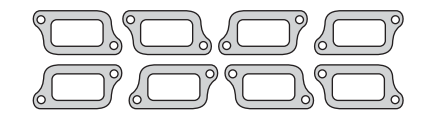

650917

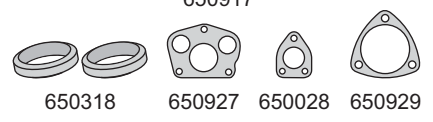

650318

650927

650028

650929



650130

650931

651037

DEUTZ



Motor/Engine	Cm³	HP	Ø
F 8L 413 F V8 16V	11309		125

Deutz: Estacionarios 0302 6472 AY 0148-00
 0301 7177 UY 0147-00
 Vehicular Omnibus - Camiones
 0302 6545 AY 0148-00
 0301 7177 UY 0147-00



DIESEL

Nº OE	Descripción/Description	Mat.		Ref.
1118641	Arandela A 6 x 10 x 1 C	CU	5	
1107101	Arandela A 8.5 x 14 x 1.25 C	CU	32	
1118727	Arandela A 20 x 24 x 1.5 C	CU	2	
24211820	Retén bancada trasero 105 x 130 x 15	P	1	R651011P
24211819	Retén distribución 100 x 120 x 15	P	1	R650912P
11164594	Retén turbo ventilador 25 x 62 x 10	P	1	R650923P

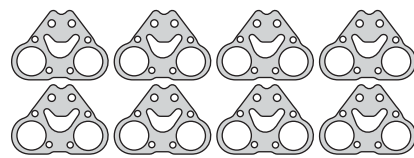

651036

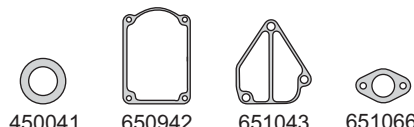

450041 650942 651043 651066



G 18 x 4



G 20 x 4



G 10 x 4

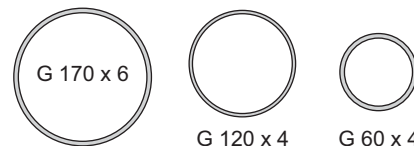

G 170 x 6

G 120 x 4

G 60 x 4

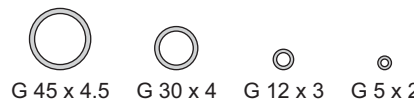

G 45 x 4.5 G 30 x 4 G 12 x 3 G 5 x 2



G 8 x 3



G 25 x 4 G 25 x 2 G 40 x 3



A 14.5 x 18 x 1.25 C

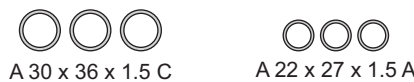

A 30 x 36 x 1.5 C

A 22 x 27 x 1.5 A



A 10 x 21 x 2 C



A 6 x 12 x 1 C

A 8 x 14 x 1.5 C

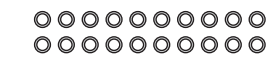

A 10 x 14 x 1.25 C



A 18 x 24 x 1.25 C

A 14 x 20 x 1.25 C



A 8.5 x 14 x 1.25 C



A 7 x 14 x 1 C

A 6 x 10 x 1 C

A 20 x 24 x 1.5 C



A 8 x 11.5 x 1 C



R651011P

R650912P

R650923P

DEUTZ



Motor/Engine	Cm³	HP	Ø
BF 3L 913	3064		102
DIESEL			

Deutz: Tractor 1978/81



Nº OE	Descripción/Description	Mat.	Ref.
	Jgo. de juntas para motor		660000-R
3371642	Junta tapa válvulas	NB 3	650110
	Junta para cárter	NB 1	660011
3362503	Tapa distribución	CB 1	650112
3371689	Múltiple escape	FCH 3	650115
2230704	Múltiple admisión	NB 3	650117
2231127	Lateral tubo sobrealimentador	NFT 1	650118
3362983	Soporte filtro aceite	NB 2	650129
13358	Acople filtro combustible	NB 1	650028
1216307	Arandela fijación tapa válvulas	PLAST 3	650130
	Base sobrealimentador turbo	NFT 1	650131
2134209	Tubo retorno aceite turbo	NB 1	650132
2137840	Tapa y codo múltiple admisión	NB 2	650133
3362337	Tapa trasera cigüeñal	CB 1	650134
	Arandela A 22 x 27 x 1.5 A	AL 1	650535
1231000	Tapa llenado aceite	CG 1	650135
1166053	Tapa llenado aceite	CG 1	650137
1118764	Arandela tapón cabeza cilindros A 26 x 32 x 2 A	AL 6	650138
1166103	O'ring base bomba inyectora G 74 x 3.35	GS 1	650139
3372164	Arandela bomba inyectora A 10 x 21 x 2 C	CU 3	650140
1167425	Radiador aceite G 14 x 20 x 10	GS 1	650141
1166002	O'ring tubo presión aceite G 14 x 3	GS 1	650142
	Arandela A 10 x 14 x 1 A	AL 1	650068
	Arandela A 17 x 22 x 1 A	AL 2	650243
1118675	Arandela tapa block A 12 x 16 x 1.5 A	AL 8	650144
D076031200	Arand. termostato sobre presión A 8 x 12 x 1 C	CU 6	650145
	Arandela A 10 x 16 x 1 A	AL 1	650146
2232527	Retén guía válvulas	GS 12	650147
	Arandela A 18 x 23 x 1 A	AL 1	650087
2230216	Anillo intermedio	AC 3	650170
2137256	Suplemento camisa cilindros 0.2 mm.	AC 3	650170-0.20
2232693	Suplemento camisa cilindros 0.3 mm.	AC 3	650170-0.30
	Suplemento camisa cilindros 0.50 mm.	AC	650170-0.50
	Suplemento camisa cilindros 1.10 mm.	AC	650170-1.10
	Suplemento camisa cilindros 1.25 mm.	AC	650170-1.25
	Bomba hidráulica motor	CB 1	650148
	Junta tapa válvulas	GS	650149
	Jgo. retén válvulas (6)	P 1	R660010P
	Retén bancada 115 x 140 x 16	P 1	R650111P
	Retén distribución 65 x 85 x 13	P 1	R650112P

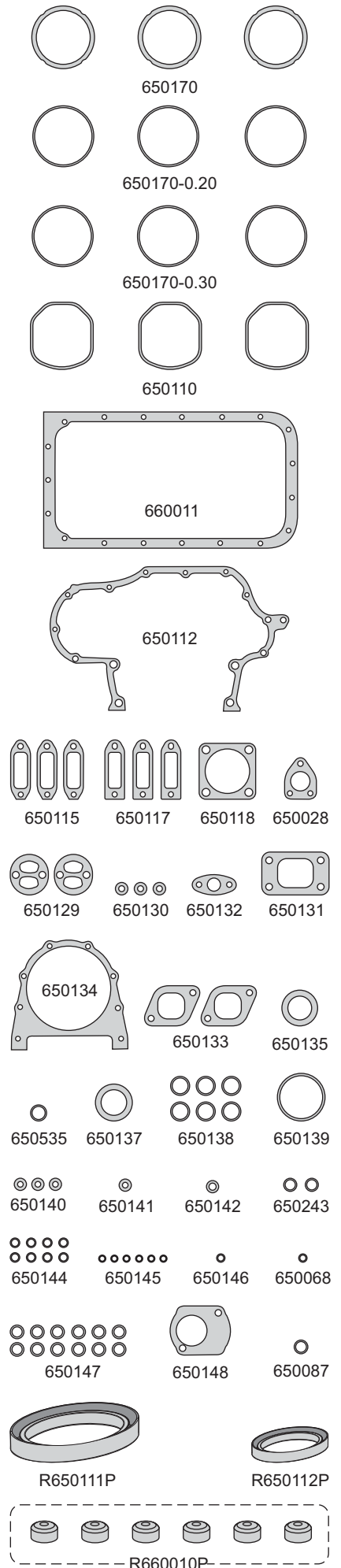

DEUTZ



Motor/Engine	Cm ³	HP	Ø
F4 L 913 (OHV) 8V	4086	87	102

Deutz: Tractor - Agrale 4.913
Turbo 4.913 1978/...



DIESEL

Nº OE	Descripción/Description	Mat.	Ref.
	Jgo. de juntas para motor	●	660100-R
	Jgo. tornillos tapa cilindros (HAS17038)		B650100
	Jgo. tornillos tapa cilindros (HAS17038)		B650100-1
3371692	Junta tapa válvulas	NB 4	650110
	Junta para cárter	NH 1	660111
3362505	Tapa distribución	CB 1	650112
13358	Acople filtro combustible	NB 1	650028
3371689	Múltiple escape	FCH 4	650115
2230704	Múltiple admisión	NB 4	650117
2231127	Lateral tubo sobrealimentador	NFT 1	650118
3362983	Soporte filtro aceite	NB 2	650129
1216307	Arandela fijación tapa válvulas	PLAST 4	650130
	Junta base sobrealimentador	NFT 1	650131
2134209	Tubo retorno a turbo	NB 1	650132
2137840	Tapa y codo múltiple admisión	NB 2	650133
3362337	Tapa trasera cigüeñal	CB 1	650134
	Arandela A 22 x 27 x 1.5 A	AL 1	650535
1231000	Tapa llenado aceite	CG 1	650135
	Arandela A 17 x 22 x 1 A	AL 2	650243
1166053	Tapa llenado aceite	CG 1	650137
1118764	Arand. tapón cabeza cilindros A 26 x 32 x 2 A	AL 8	650138
1166103	O'ring bomba inyectora G 74 x 3.35	GS 1	650139
3372164	Arandela bomba inyectora A 10 x 21 x 2 C	CU 4	650140
1167425	Radiador de aceite	GS 1	650141
1166002	O'ring tubo presión aceite G 14 x 3	GS 1	650142
1118836	Junta tapa radiador aceite G 45.5 x 52 x 2	GS	650143
1118675	Arandela tapa block A 12 x 16 x 1.5 A	AL 8	650144
D076031200	Arandela termostato sobre presión A 8 x 12 x 1 C	CU 6	650145
2232527	Retén guía válvulas	GS 16	650147
	Arandela A 10 x 16 x 1 A	AL 1	650146
	Bomba hidráulica	CB 1	650148
	Junta tapa válvulas	GS	650149
	Arandela A 10 x 14 x 1 A	AL 1	650068
2230216	Anillos intermedio	AC 4	650170
2232693	Suplemento camisa cilindros 0.30 mm.	AC 4	650170-0.30
2137256	Suplemento camisa cilindros 0.20 mm.	AC 4	650170-0.20
	Suplemento camisa cilindros 0.50 mm.	AC 1	650170-0.50
	Suplemento camisa cilindros 1.10 mm.	AC 1	650170-1.10
	Suplemento camisa cilindros 1.25 mm.	AC 1	650170-1.25
	Arandela A 18 x 23 x 1 A	AL 1	650087
	Jgo. retén válvulas (8)	P	R660110P
	Retén bancada 115 x 140 x 16	P	R650111P
	Retén distribución 65 x 85 x 13	P	R650112P



650170



650170-0.20



650170-0.30



650110

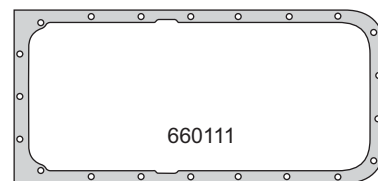

660111

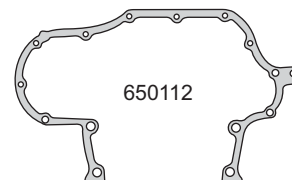

650112

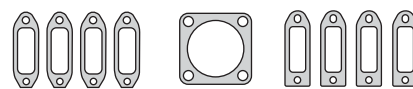

650115

650118

650117



650028

650129

650130

650132

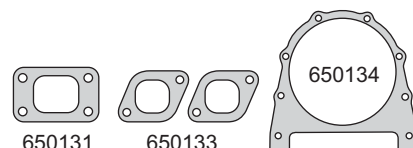

650131

650133

650134



650135

650535

650137

650139



650138



650140

650141

650142

650243



650144

650145



650146

650068

650087

650148



650147



R650111P



R650112P

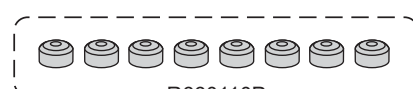

R660110P

DEUTZ



Motor/Engine	Cm³	HP	Ø
BF 5L 913	5106		102

Deutz: Tractor 1978/...



DIESEL

Nº OE	Descripción/Description	Mat.	Ref.
	Jgo. de juntas para motor		660200-R
3371642	Junta tapa válvulas	NB	5 650110
	Junta para cárter	NB	1 660211
3362503	Tapa distribución	CB	1 650112
3371689	Múltiple escape	NFT	5 650115
2230704	Múltiple admisión	NB	5 650117
2231127	Lateral tubo sobrealimentador	NFT	1 650118
13358	Acople filtro combustible	NB	1 650028
3362983	Soporte filtro aceite	NB	2 650129
1216307	Arandela fijación tapa válvulas	PLAST	5 650130
	Base sobrealimentador	NFT	1 650131
2134209	Tubo retorno aceite	NB	1 650132
2137840	Tapa y codo múltiple admisión	NB	2 650133
3362337	Junta tapa trasera cigüeñal	CB	1 650134
	Arandela A 22 x 27 x 1.5 A	AL	1 650535
1231000	Tapa llenado aceite	CG	1 650135
1166053	Tapa llenado aceite	CG	1 650137
1118764	Arandela tapón cabeza cilindros A 26 x 32 x 2 A	AL	10 650138
3372164	Arandela bomba inyectora A 10 x 21 x 2 C	CU	5 650140
1167425	Radiador aceite G 14 x 20 x 10	GS	1 650141
1166002	O'ring tubo presión aceite G 14 x 3	GS	1 650142
	Arandela A 18 x 23 x 1 A	AL	1 650243
1118675	Arandela tapa block A 12 x 16 x 1.5 A	AL	8 650144
D076031200	Arandela ter/ sobre. A 8 x 12 x 1 C	CU	6 650145
2232527	Retén guía válvulas	GS	20 650147
	Arandela A 10 x 16 x 1 A	AL	1 650146
1166103	O'ring base G 74 x 3.35	GS	1 650139
	Bomba hidráulica motor	CB	1 650148
	Junta tapas válvulas	GS	650149
	Arandela A 10 x 14 x 1 A	AL	1 650068
2230216	Anillo intermedio	AC	5 650170
2137256	Suplemento camisa cilindros 0.20 mm.	AC	5 650170-0.20
2232693	Suplemento camisa cilindros 0.30 mm.	AC	5 650170-0.30
	Suplemento camisa cilindros 0.50 mm.	AC	650170-0.50
	Suplemento camisa cilindros 1.10 mm.	AC	650170-1.10
	Suplemento camisa cilindros 1.25 mm.	AC	650170-1.25
	Arandela A 17 x 22 x 1 A	AL	2 650087
	Jgo. retén válvulas (10)	P	1 R660210P
	Retén bancadas 115 x 140 x 16	P	1 R650111P
	Retén distribución 65 x 85 x 13	P	1 R650112P

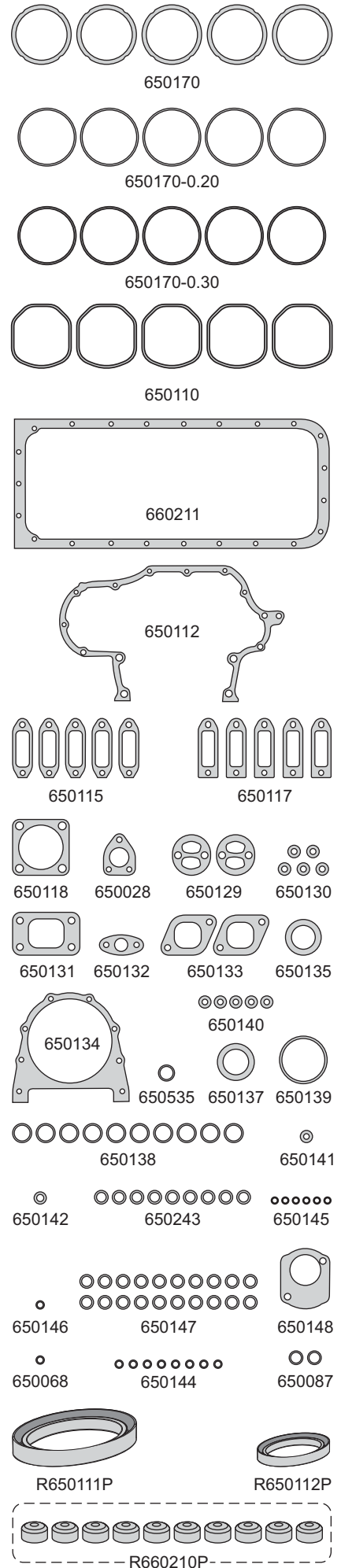



taranto

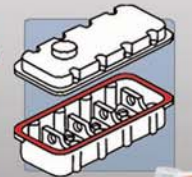
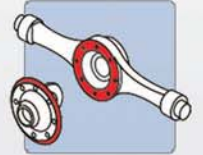

**HIGH
TEMP
350°C**

Sellador Líquido a base de Caucho de Silicona

Aprobado para motores equipados con sensor de oxígeno.

- ▶ Sellador libre de solvente, adhesivo y cubritivo compuesto a base de caucho de silicona, ha sido especialmente creado para aplicaciones de gran fuerza de torsión.
- ▶ Excelente resistencia al aceite a los combustibles, aceites, lubricantes, anticongelantes y gases.
- ▶ Resiste golpes y vibraciones.
- ▶ Es siempre flexible y se mantiene a una temperatura de entre -62°C a +350°C intermitente.

No recomendado para sellar tapas de cilindros.



DODGE



Motor/Engine	Cm³	HP	Ø
241	3956	95	85.73
251	4106	100	87.31

Dodge: D100/200/400/500 1951/64

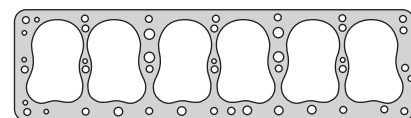

220705



220710

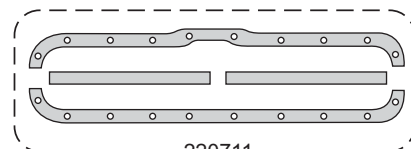

220711

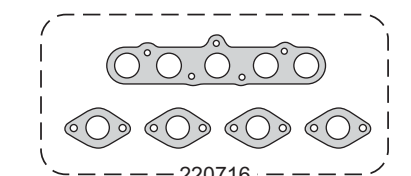

220716

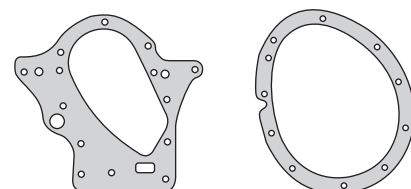

220713

220712

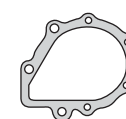

220714



220717



220018



220718



220719



540025



220726



220727



220728



220729



220730



220734



220735



A 13 x 20 x 2 A



R220712N

Nº OE	Descripción/Description	Mat.	Ref.
	Jgo. de juntas para motor		220700
	Junta tapa cilindros Ø 88.0 ± 1.40	NFT	1 220705
665690	Junta tapa válvulas	CG	2 220710
7800478	Jgo. junta para cárter (4)	CG	1 220711
600752	Tapa distribución	CB	1 220712
600749	Placa distribución	CB	1 220713
637439	Bomba de agua hasta 1948	NB	1 220714
780462	Jgo. múltiple admisión y escape (5)	NFT	1 220716
666352	Entre múltiple	NFT	1 220717
679023	Salida de escape D-100	FCH	220018
683051	Salida de escape D-400	FCH	220718
637440	Bomba de agua a block	NB	1 220719
	Base carburador	NB	540025
	Cuba carburador	FCH	220726
	Bomba aceite	FCH	220727
634704	Bomba nafta	FCH	220728
50082	Termostato	FCH	220729
	Bomba agua 49/	NB	1 220730
	Intermedia carburador	FCH	220734
695442	Base filtro aceite	FCH	220735
	Arandela tapón cárter A 13 x 20 x 2 A	AL	
1088603	Retén distribución 55.56 x 81 x 17.46	N	R220712N



taranto



VIFLON®



Revolucionario diseño de labio en VIFLON® VF

Como resultado de la permanente búsqueda de mejores diseños y materiales para ofrecer al mercado productos más eficientes a costos razonables, Taranto ha desarrollado nuevos perfiles de labio con mejores características y costo más bajo que los retenes PTFE.

VENTAJAS DE ESTE NUEVO DISEÑO Y COMPUESTO

- ▶ Contacto más estrecho con el eje.
- ▶ Menor carga sobre el eje por su diseño sin resorte.
- ▶ Menor coeficiente de fricción respecto al compuesto fluoroelastómero FKM.
- ▶ Mejor flexibilidad del labio con una mejor adaptación a ejes usados.
- ▶ Menor costo respecto al PTFE.



FIAT



Motor/Engine

Cm³

HP

Ø

Fiat: Tractor Someca 1965/74

M45 - 450 - 55
Super Son

4156

105

DIESEL

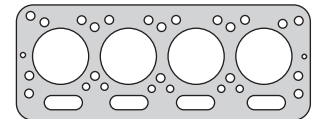

700008

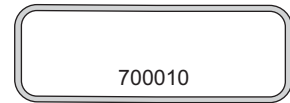

700010

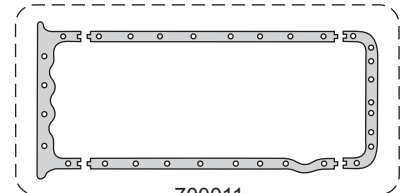

700011

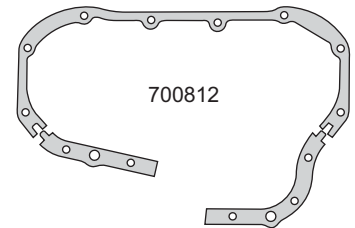

700812

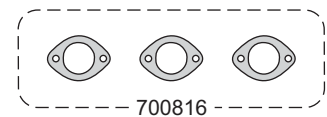

700816



700014



700818



700019



700829



700827

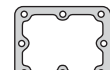

700031



700032



700832



700034



700833



700035



700837



700838



700038



700834



700840

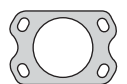

310443



700543











700544



500045



700070-0.07

Nº OE	Descripción/Description	Mat.	Ref.
	Jgo. de juntas para motor		700000
70483	Junta tapa cilindros Ø 109.0 \pm 1.80 	CNC 1	700008
	Junta tapa cilindros Ø 109.0 \pm 1.80 	NFT	700007
72840	Junta tapa válvulas superior 	CG 1	700010
546295	Jgo. junta para cárter (4) 	NB 1	700011
8817760	Tapa distribución 	NB 1	700812
540456	Bomba de agua 	NH 1	700014
3/0187486	Jgo. múltiple escape (3) 	NFT 1	700816
71227	Salida de escape 	NFT 1	700818
	Placa bomba de agua	NB 1	700019
38814976	Tubería lubricación aceite	NB 1	700827
549417	Codo termostato	NB 1	700829
546297	Tapa lateral cárter chico	NB 1	700031
544020	Codo admisión aire motor	NB 1	700032
1049122	Entre caja bomba reguladora	NB 1	700832
760203	Tapa reguladora bomba inyectora	NB 1	700833
540461	Unión bomba agua	NB 1	700034
583596	Alojamiento bomba elevadora	NB 1	700834
561999	Tapa árbol y engr. cambio	NB 1	700035
3/8814976	Cañería termostato a bomba	NB 1	700837
	Arandela conductor 57.5 x 23.5	CG 1	700038
8816260	Tubería agua a block	NB 2	700838
114802	Soporte fijación comando bomba	NB 1	700840
	Base bomba inyectora	NB 1	310443
113909	Apoyo filtro aceite	NB 1	700543
115036	Boca carga aceite	NB 1	700544
746153	Bomba alimentación 	NB 1	500045
	Jgo. suplemento camisa cilindros (0.07) (4)	CU 1	700070-0.07
	Jgo. suplemento camisa cilindros (0.10) (4)	CU	700070-0.10

FIAT



Motor/Engine	Cm³	HP	Ø
780 - R - AE	6872		125

Fiat: Tractor 1962/69

DIESEL



Nº OE	Descripción/Description	Mat.	Ref.
	Jgo. de juntas para motor		700100
583529	Junta tapa cilindros Ø 126.5 ± 1.80	CNC	1 700108
539741	Junta tapa válvulas superior	CG	1 700110
573228	Junta para cárter	NB	1 700111
539800	Tapa engranaje bomba inyectora	NB	1 700112
539672	Cuerpo soporte bomba de agua	NB	1 700114
	Jgo. múltiple escape (3)	NFT	1 700116
569966	Jgo. múltiple admisión (2)	NFT	1 700117
539120	Salida de escape	NFT	1 700118
573275	Codo termostato	NB	1 700119
	Boca carga aceite a block	CG	1 700127
551624	Boca carga aceite	NB	1 700133
539797	Tapa delantera block	NB	1 700135
586019	Tapa botadores superior	NB	2 700136
573282	Tapa botadores inferior	NB	2 700137
768673	Entre caja y bomba reguladora	NB	1 700138
581961	Soporte filtro aceite	NB	1 700139
20344	Caja dispositivo arranque	NB	1 700140
15740	Base block motor arranque	NB	1 700141
581960	Cuerpo filtro aceite	NB	1 700142
539819	Soporte cojinetes	NB	1 700143
551494	Tapa engranaje reenvío 0.5	NB	1 700144
542368	Cierre conducto bomba aceite	NB	1 700145
	Arandela conducto superior	CG	1 700146
539706	Tapa montaje árbol levas	NB	1 700147
573233	Filtro succión	NB	1 700148
	Caño anterior bomba agua	NB	2 700149
	Caño posterior bomba agua	NB	1 700151
	Suplemento bancada	SNA	16 700158
552604	Tapa engranaje reenvío 1.5	NB	1 700162
	Reductor alta y baja	NB	700163
	Superior tapa diferencial	NB	700164
	Acople diferencial	NB	700165
	Jgo. suplemento camisa cilindros (0.07) (4)	CU	1 700170-0.07
	Jgo. suplemento camisa cilindros (0.10) (4)	CU	700170-0.10

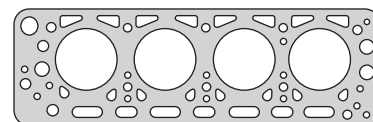

700108

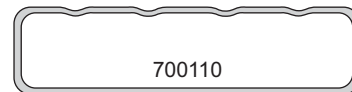

700110

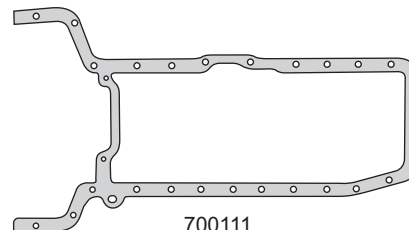

700111

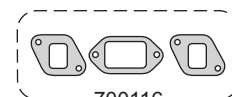

700116

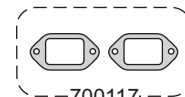

700117

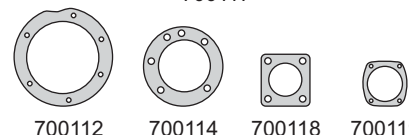

700112

700114

700118

700119

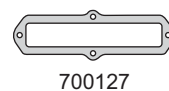

700127

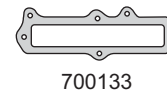

700133

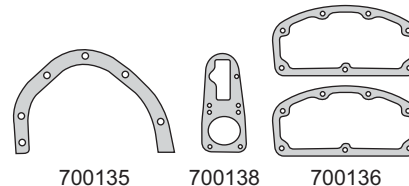

700135

700138

700136

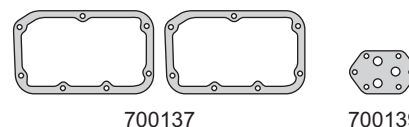

700137

700139

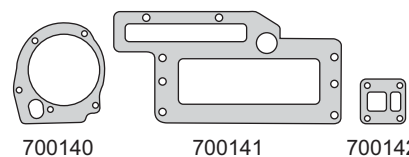

700140

700141

700142



700143

700144

700145

700146

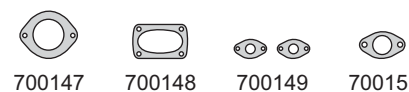

700147

700148

700149

700151



700158



700162



700170-0.07

FIAT



Motor/Engine	Cm³	HP	Ø
840 - 900 - 1100 CP3 - 900E	7412	165	110
DIESEL			

Fiat: Tractor - CP3 1972/80



Nº OE	Descripción/Description	Mat.	Ref.
	Jgo. de juntas para motor		700200
8818605	Junta tapa cilindros Ø 114.5 \pm 2.00	T	1 700207
8818605	Junta tapa cilindros Ø 114.0 \pm 1.86	CNC	700208
8304703	Junta tapa válvulas superior	CG	2 700810
8308535	Junta para cárter	NH	1 700211
8817760	Tapa distribución	NB	1 700812
8818228	Tapa bomba de agua	NB	1 700814
	Jgo. múltiple escape (3)	FCH	1 700215
8308543	Salida de escape	NFT	1 700218
8818239	Placa bomba de agua	NB	1 700819
8817468	Base bomba aceite	NB	2 700227
3/8814976	Tubería lubricación aceite	NB	2 700827
549417	Codo termostato	NB	1 700829
1049122	Entre caja y bomba reguladora	NB	1 700832
760203	Tapa reguladora bomba inyectora	NB	1 700833
583596	Tapa alojamiento bomba elevadora	NB	1 700834
8307497	Bomba aplicación levante hidráulico	NB	1 700235
3/8814976	Cañería termostato a bomba	NB	1 700837
8816260	Tubería agua a block	NB	4 700838
	Reguladora bomba inyectora	NB	1 700839
114802	Soporte fijación comando bomba	NB	1 700840
8308640	Tapa alojamiento bomba hidráulica	NB	2 700841
8828172	Retén aceite bancada cigüeñal	SNA	700842
	Suplemento bancada	SNA	12 700158
	Junta base bomba inyectora	NB	1 310443
	Jgo. suplemento camisa cilindros (0.05) (6)	CU	1 700270-0.05
	Jgo. suplemento camisa cilindros (0.07) (6)	CU	700270-0.07
	Jgo. suplemento camisa cilindros (0.10) (6)	CU	700272-0.10

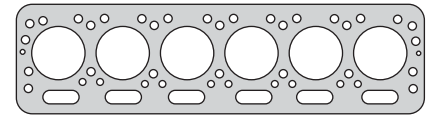

700207



700810

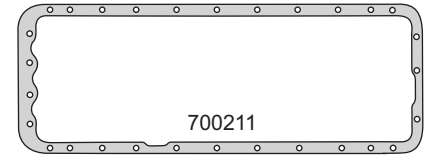

700211

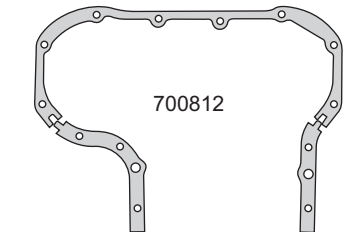

700812

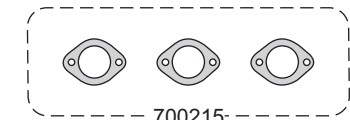

700814

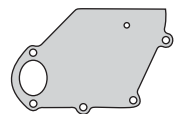
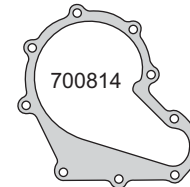

700819



700218



700829



700227



700827



700832



700833



700834

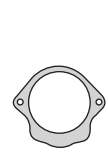

700235



700837



700838



700839



700840



700841

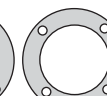

700841



310443



700158



700270-0.05

FIAT



Motor/Engine	Cm³	HP	Ø
650 - 700 CO3	3421 4397		110 108

Fiat: Tractor Someca, CN3 1961/70
Someca M45/M50, Super Som 55/46A
Tigrotto 1969/...



DIESEL

Nº OE	Descripción/Description	Mat.	Ref.
	Jgo. de juntas para motor		700300
	Junta tapa cilindros Ø 112.5 ± 1.80	CNC	1 700308
72840	Junta tapa válvulas superior	CG	1 700010
546295	Jgo. junta para cárter (4)	NB	1 700011
	Tapa distribución	NB	1 700812
540456	Bomba de agua	NB	1 700014
8818228	Bomba de agua	NB	700814
	Jgo. múltiple escape (3)	NFT	1 700316
8308543	Salida de escape	NFT	1 700818
	Placa bomba de agua	NB	1 700019
8818239	Placa bomba de agua	NB	700819
	Unión caño de agua	NB	1 700327
38814976	Tubería lubricación aceite	NB	2 700827
549417	Codo termostato	NB	1 700829
	Junta tapa lateral cárter	NB	1 700031
	Codo admisión aire	NB	1 700032
1049122	Entre caja y bomba reguladora	NB	1 700832
760203	Tapa reguladora bomba inyectora	NB	1 700833
	Codo agua	NB	1 700034
	Unión bomba de agua	NB	700334
583596	Tapa alojamiento bomba elevadora	NB	1 700834
8817453	Soporte placa filtro aceite	NB	1 700835
	Cañería termostato	NB	1 700837
	Arandela conducto	CG	1 700038
8816260	Tubería agua a block	NB	2 700838
	Soporte fijación comando bomba	CB	1 700440
	Codo agua	NB	1 700341
541065	Cuenta horas	CB	700441
8828172	Retén aceite bancada cigüeñal	SNA	700842
113909	Apoyo filtro aceite	NB	1 700543
115036	Boca carga aceite	NB	1 700544
	Bomba alimentación	NB	1 500045
	Junta base bomba inyectora	NB	1 310443
	Jgo. suplemento camisa cilindros (0.05) (4)	CU	1 700370-0.05
	Jgo. suplemento camisa cilindros (0.07) (4)	CU	700370-0.07
	Jgo. suplemento camisa cilindros (0.10) (4)	CU	700370-0.10

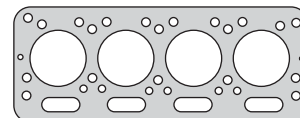

700308

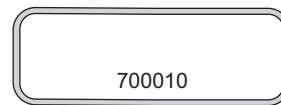

700010

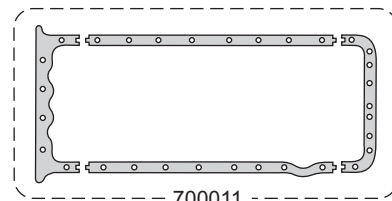

700011

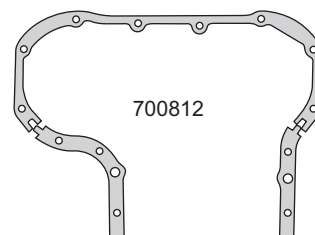

700812

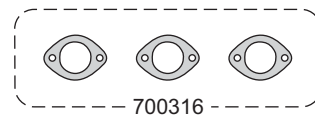

700316

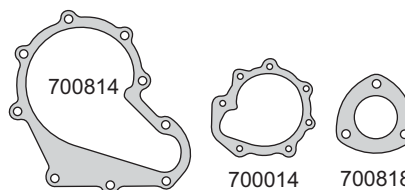

700814

700014

700818

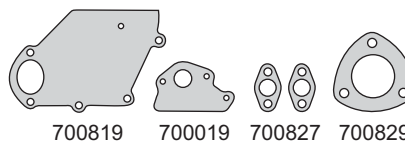

700819

700019

700827

700829

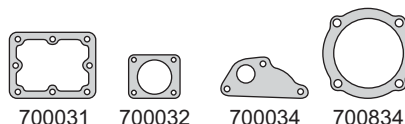

700031

700032

700034

700834

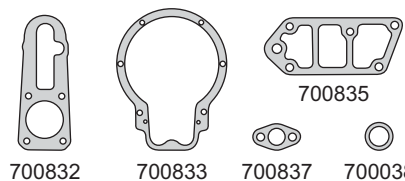

700832

700833

700837

700038

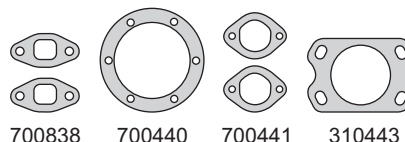

700838

700440

700441

310443

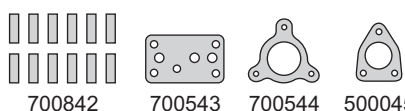

700842

700543

700544

500045



700370-0.05

FIAT



Motor/Engine	Cm³	HP	Ø
DA - 50 - 40	3456		100

Fiat: Tractor Someca, Leoncino 1950/...



DIESEL

Nº OE	Descripción/Description	Mat.	Ref.
	Jgo. de juntas para motor		700400
115362	Junta tapa cilindros Ø 104.0 ± 1.80	CNC	1 700408
72840	Junta tapa válvulas superior	CG	1 700410
546295	Jgo. junta para cárter (4)	NB	1 700011
8817760	Tapa distribución (3)	NB	1 700812
540456	Bomba de agua	NB	1 700014
3/0187486	Jgo. múltiple escape (3)	NFT	1 700816
71227	Salida de escape	NFT	1 700818
	Placa bomba de agua	NB	1 700019
38814976	Tubería lubricación aceite	NB	1 700827
549417	Codo termostato	NB	1 700829
546297	Junta tapa lateral cárter chico	NB	1 700031
544020	Codo admisión aire motor	NB	1 700032
540461	Unión bomba de agua	NB	1 700034
170245	Soporte bomba aceite	CB	1 700435
599741	Junta tapa válvulas lateral	CB	1 700436
3/8814976	Cañería termostato a bomba	NB	1 700837
	Arandela conductor 57.5 x 23.5	CG	1 700038
8816260	Tubería agua a block	NB	2 700838
187341	Bomba aceite	CB	2 700439
	Soporte fijación comando bomba	CB	1 700440
541065	Cuenta horas	CB	2 700441
3/10187185	Filtro aceite	CB	1 700442
113909	Apoyo filtro aceite	NB	1 700543
746153	Bomba alimentación	NB	1 500045
	Junta base bomba inyectora	NB	1 310443
	Jgo. suplemento camisa cilindros (0.050) (4)	CU	1 700470-0.050
	Jgo. suplemento camisa cilindros (0.075) (4)	CU	700470-0.075
	Jgo. suplemento camisa cilindros (0.100) (4)	CU	700470-0.100

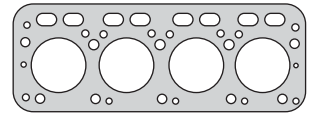

700408



700410

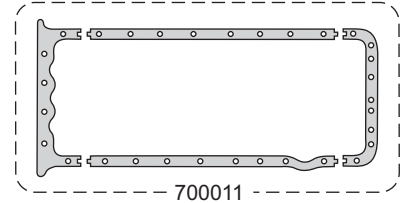

700011

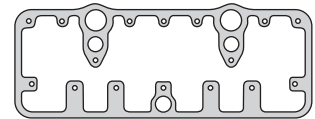

700436

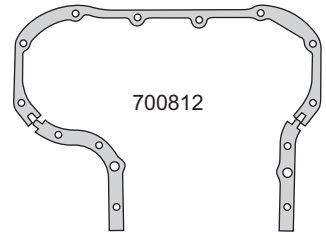

700812

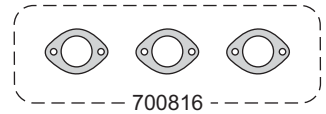

700816



700014



700818



700019



700829



700827

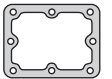

700031



700032

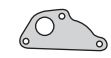

700034



700435



700837



700838



700038



700439



700440



700441



700442



700543

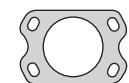

310443



500045



700470-0.050

FIAT



Motor/Engine	Cm³	HP	Ø
700E - 800E CO3 - 640 - 740	5401	90/106	115

Fiat: Tractor, CO3 1971/80

DIESEL



Nº OE	Descripción/Description	Mat.	Ref.
	Jgo. de juntas para motor		700500
8824633	Junta tapa cilindros Ø 118.0 ± 2.00	NFT	1 700507
8824633	Junta tapa cilindros Ø 118.0 ± 1.86	CNC	700508
8307703	Junta tapa válvulas superior	CG	1 700510
8307706	Junta para cárter	NB	1 700511
8817760	Tapa distribución	NB	1 700812
8818228	Tapa bomba de agua	NB	1 700814
	Jgo. múltiple escape (3)	FCH	1 700215
8308543	Salida de escape	NFT	1 700218
8818239	Placa bomba de agua	NB	1 700819
8817468	Base bomba aceite	NB	2 700227
38814976	Tubo lubricación aceite	NB	2 700827
549417	Codo termostato	NB	1 700829
1049122	Entre caja y bomba reguladora	NB	1 700832
760203	Tapa reguladora bomba inyectora	NB	1 700833
583596	Tapa alojamiento bomba elevadora	NB	1 700834
8307497	Bomba aplicación levante hidráulico	NB	1 700235
8817453	SopORTE placa filtro aceite	NB	1 700835
3/8814976	Cañería termostato a bomba	NB	1 700837
8816260	Tubería agua a block	NB	1 700838
1049197	Regulador bomba inyectora	NB	1 700839
114802	SopORTE fijación comando bomba	NB	1 700840
8308640	Tapa alojamiento bomba hidráulica	NB	1 700841
8828172	Retén aceite bancada cigüeñal	SNA	700842
541353	Junta base bomba inyectora	NB	1 310443
113909	Apoyo filtro aceite	NB	1 700543
115036	Boca carga aceite	NB	1 700544
540456	Tapa bomba agua	NB	1 700545
	Válvula rotativa		700546
	Suplemento bancada	SNA	12 700158
	Jgo. supl. camisa cilindros (0.050) pollera larga (4)	CU	1 700570-0.050
	Jgo. supl. camisa cilindros (0.075) pollera larga (4)	CU	700570-0.075
	Jgo. supl. camisa cilindros (0.100) pollera larga (4)	CU	700570-0.100
	Jgo. suplemento camisa cilindros (1.00)	CU	700570-1.00
	Jgo. suplemento camisa cilindros (3.09)	AC	700570-3.09
	Jgo. suplemento camisa cilindros (3.12)	AC	700570-3.12
	Jgo. suplemento camisa cilindros (3.15)	AC	700570-3.15
	Jgo. suplemento camisa cilindros (3.18)	AC	700570-3.18
	Jgo. suplemento camisa cilindros (3.21)	AC	700570-3.21
	Jgo. suplemento camisa cilindros (3.24)	AC	700570-3.24
	Jgo. suplemento camisa cilindros (3.27)	AC	700570-3.27
	Jgo. suplemento camisa cilindros (3.30)	AC	700570-3.30
	Jgo. suplemento camisa cilindros (3.33)	AC	700570-3.33

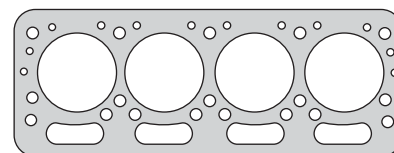

700507

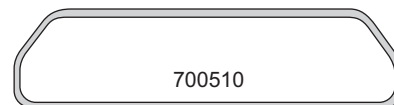

700510

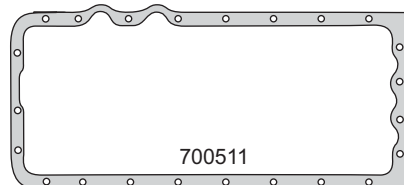

700511

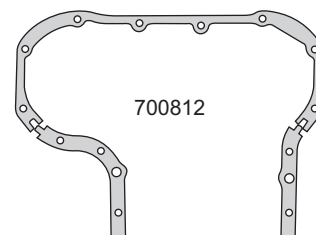

700812

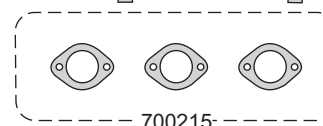

700215

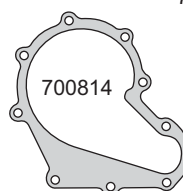

700814

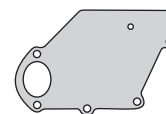

700819



700218



700227



700827



700829



700832



700833



700834



700235

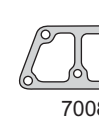

700835



700837

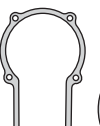

700838



700839



700840



700841



310443



700544



700545



700543



700158



700570-0.05

FIAT



Motor/Engine	Cm³	HP	Ø
U25 - 211R - CD	1135		85

Fiat: Tractor U25 1957/62
Tractor 211R 1962/65



DIESEL

Nº OE	Descripción/Description	Mat.	Ref.
556247	Jgo. de juntas para motor		700600
531316	Junta tapa cilindros Ø 87 ± 1.40	NFT	1 700605
561377	Junta tapa válvulas	CG	1 700610
561379	Jgo. junta para cárter (4)	CG	1 700611
893339	Tapa distribución	CB	1 700612
561233	Placa distribución	NB	1 700613
561507	Tapa bomba de agua	CB	1 700614
860639	Jgo. múltiple admisión y escape (2)	FCH	1 700615
561234	Salida de escape	FCH	1 700618
561358	Entre base bomba de agua	NB	1 700619
561352	Eje mando bomba inyectora	CB	1 700628
561353	Sop. post. bancada cigüeñal	NB	2 700629
561310	Tapa caja reductor	CB	1 700633
561361	Soporte bomba aceite	CB	2 700435
1/26828/80	Tapa inspección distribución	CB	1 700637
563414	Aspiración bomba aceite	CB	1 700639
1/26833/80	Entrada agua	CB	1 700640
746153	Salida agua	CB	1 700641
541353	Junta base bomba inyectora	NB	1 310443
561377	Bomba alimentación	NB	1 500045
563755	Jgo. junta para cárter		700660
	Base carburador motor arranque	NB	1 700765
	Jgo. suplemento camisa cilindros (4)	CU	700760-0.05
	Jgo. suplemento camisa cilindros (4)	CU	700760-0.07
	Jgo. suplemento camisa cilindros (4)	CU	700760-0.10

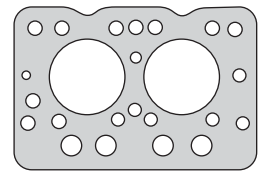

700605

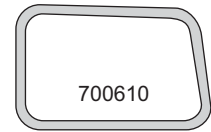

700610

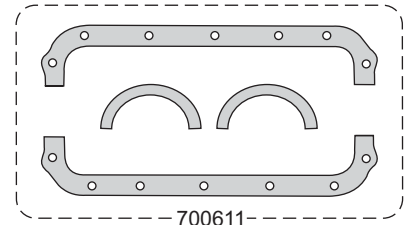

700611

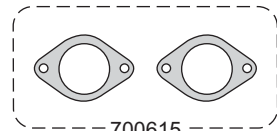

700615

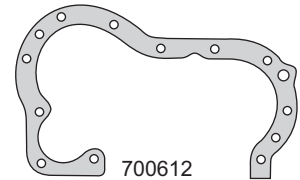

700612

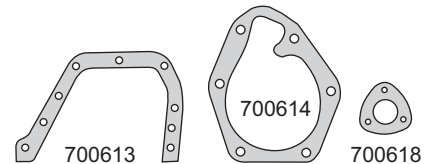

700613

700614

700618

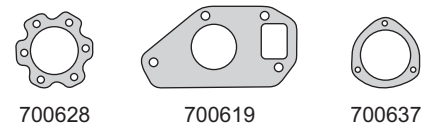

700628

700619

700637

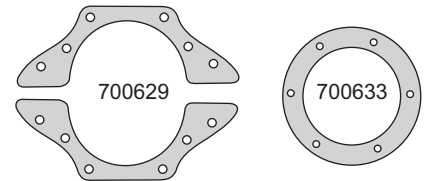

700629

700633

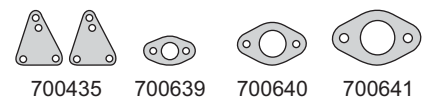

700435

700639

700640

700641



310443

500045

700765

FIAT



Motor/Engine

Cm³

HP

Ø

Fiat: Tractor 1955/...

60 RL

6546

122

DIESEL



Nº OE	Descripción/Description	Mat.	Ref.
	Jgo. de juntas para motor		700700
	Junta tapa cilindros Ø 126 \pm 1.80	CNC	1 700708
539741	Junta tapa válvulas superior	CG	1 700110
	Jgo. junta para cárter (3)	NB	1 700711
539800	Tapa engranaje bomba inyectora	NB	1 700112
539672	Cuerpo soporte bomba de agua	NB	1 700114
	Jgo. múltiple escape (3)	NFT	1 700116
569966	Jgo. múltiple admisión (2)	NFT	1 700117
539120	Salida de escape	NFT	1 700118
573275	Codo termostato	NB	1 700119
	Boca carga aceite a block	CG	1 700127
551624	Boca carga aceite	NB	1 700133
539797	Tapa delantera a block	NB	1 700135
586019	Tapa botadores superior	NB	2 700136
573282	Tapa botadores inferior	NB	2 700137
20344	Caja dispositivo arranque	NB	1 700140
15740	Base block motor arranque	NB	1 700141
581960	Cuerpo filtro aceite	NB	1 700142
539819	SopORTE cojinetes	NB	1 700143
551494	Tapa engranaje reenvío	NB	1 700144
	Arandela conducto superior	CG	1 700146
539706	Tapa montaje árbol de levas	NB	1 700147
	Cañería bomba aceite	NB	1 800048
	Caño anterior bomba agua	NB	2 700149
	Caño posterior bomba agua	NB	1 700151
552604	Tapa engranaje reenvío	NB	1 700162
	Bomba alimentación	NB	1 700763
	Tapa totalizador horas	NB	2 700764
	Base carburador motor arranque	NB	1 700765
	Tapa registro cárter	NB	1 700766
	Jgo. suplemento camisa cilindros (4)	CU	1 700170-0.07
	Jgo. suplemento camisa cilindros (4)	CU	1 700170-0.10

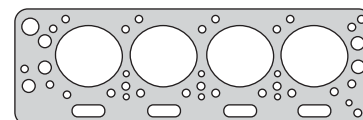

700708

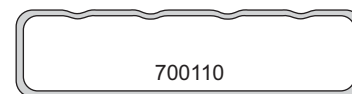

700110

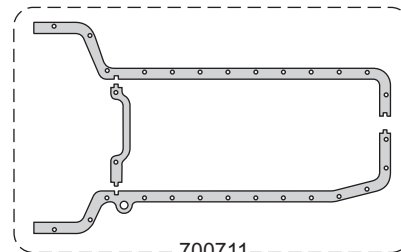

700711

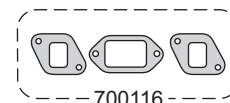

700114

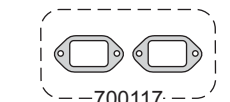

700116

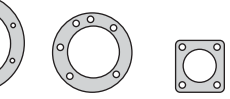

700117

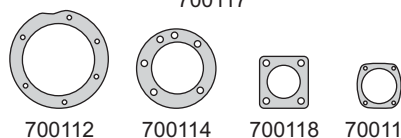

700112

700114

700118

700119



700127

700142

700133



700136

700143

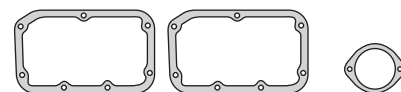

700137

700144

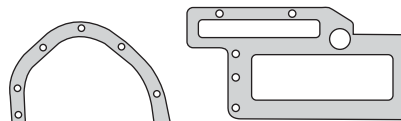

700135

700141

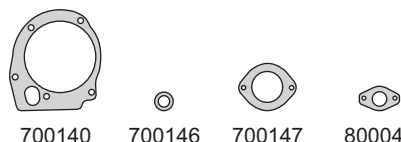

700140

700146

700147

800048

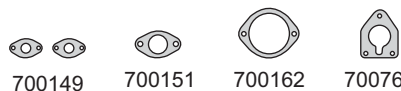

700149

700151

700162

700763

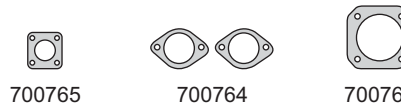

700765

700764

700766



700170-0.07

FIAT



Motor/Engine	Cm³	HP	Ø
CN3	3421		110
CN4	3705		110

Fiat: Tractor 400 E.V.U, 500, Super 600E
480 1969/80



DIESEL

Nº OE	Descripción/Description	Mat.	Ref.
	Jgo. de juntas para motor		700800
8823404	Junta tapa cilindros Ø 114.0 \pm 2.00	NFT	1 700807
8823404	Junta tapa cilindros Ø 114.0 \pm 1.86	CNC	700808
8304703	Junta tapa válvulas	CG	1 700810
8304242	Jgo. junta para cárter (4)	NB	1 700811
8817760	Tapa distribución	NB	1 700812
8818228	Tapa bomba de agua	NB	1 700814
	Jgo. múltiple escape	NFT	700815
	Jgo. múltiple escape (3)	NFT	1 700816
71227	Salida de escape	NFT	1 700818
8818239	Placa bomba de agua	NB	1 700819
	Tubería lubricación aceite	NB	1 700827
549417	Codo termostato	NB	1 700829
1049122	Entre caja bomba reguladora	NB	1 700832
760203	Tapa reguladora bomba inyectora	NB	1 700833
583596	Tapa alojamiento bomba elevadoraz	NB	1 700834
8817453	Soporte placa filtro	NB	1 700835
3/8814976	Cañería termostato a bomba	NB	1 700837
8816260	Tubería agua a block	NB	2 700838
	Reguladora bomba inyectora	NB	1 700839
	Soporte fijación comando bomba	NB	1 700840
	Tapa alojamiento bomba hidráulica	NB	1 700841
8828172	Retén aceite bancada cigüeñal	SNA	700842
541353	Junta base bomba inyectora	NB	1 310443
	Junta para cárter enterizo	NB	700845
	Jgo. juntas caja velocidades	VS	700950
	Suplemento bancada	SNA	12 700158
	Jgo. suplemento camisa cilindros (3)	CU	1 700270-0.05
	Jgo. suplemento camisa cilindros (3)	CU	700270-0.07
	Jgo. suplemento camisa cilindros (3)	CU	700270-0.10

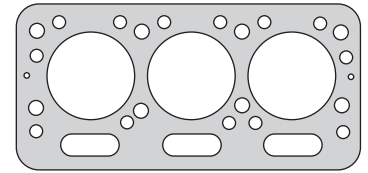

700807

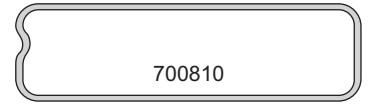

700810

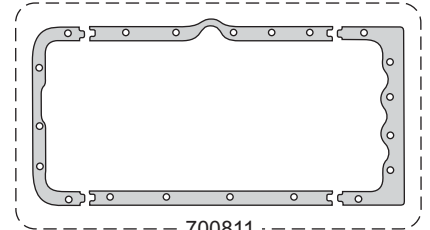

700811

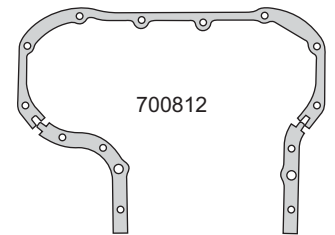

700812

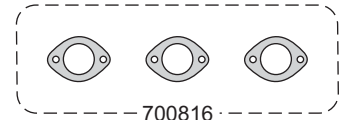

700816

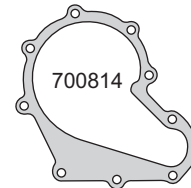

700814

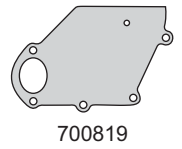

700819



700818



700827



700829



700834



700833



700832

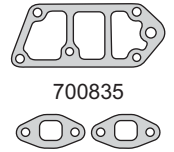

700835

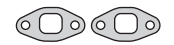

700838



700837



700839

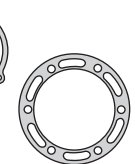

700840

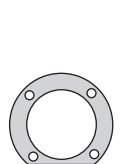

700841

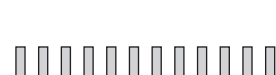

700158

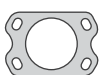

310443



700270-0.05

FIAT



Motor/Engine Cm³ HP Ø

615 2270 40 85

Fiat: Tractor 411R, 411T, 431R 1959/85

DIESEL



Nº OE	Descripción/Description	Mat.	Ref.
	Jgo. de juntas para motor		700900
566236	Junta tapa cilindros Ø 86.0 ± 1.65	CNC 1	700908
565468	Junta tapa válvulas superior	CG 1	700910
563621	Jgo. junta para cárter (4)	CB 1	700911
561379	Tapa distribución	CB 1	700612
893339	Placa distribución	NB 1	700613
565395	Tapa bomba de agua	NB 1	700914
	Jgo. múltiple escape (3)	NFT 1	700916
565481	Jgo. múltiple admisión (2)	NFT 1	700917
568012	Salida de escape	NFT 1	700918
565396	Entre block y bomba de agua	NB 1	700919
565458	Apoyo filtro aceite	NB 1	700927
561358	Eje mando bomba inyectora	CB 1	700628
565153	Tapa asiento bomba levante hidráulico	CB 1	700933
563611	Junta para cárter chico	CB 1	700934
565490	Termostato		700935
565443	Junta tapa válvulas lateral	CG 1	700936
561361	Tapa inspección tapa distribución	CB 1	700637
541353	Junta base bomba inyectora	NB 1	310443
746153	Bomba alimentación	NB 1	500045
	Jgo. juntas caja de velocidades	VS	700950
563755	Base cuenta horas	NB 1	700765

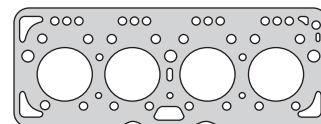

700908

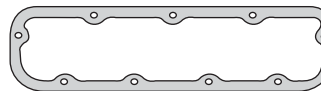

700910

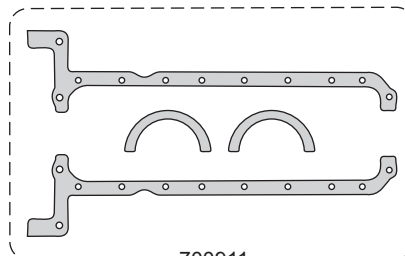

700911

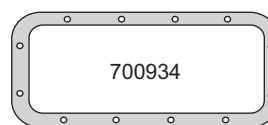

700934

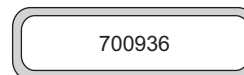

700936

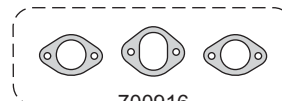

700916

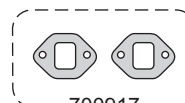

700917

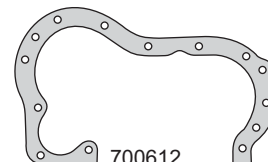

700612

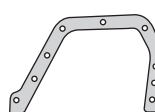

700613



700914

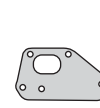

700919



700918



700927



700628

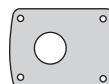

700933



700935



700637



310443



500045



700765

FIAT



Motor/Engine	Cm³	HP	Ø
673N - CP 840 - 900	7412		110
DIESEL			

Fiat: Camión 1964/83



Nº OE	Descripción/Description	Mat.	Ref.
	Jgo. de juntas para motor		710100
	Junta tapa cilindros Ø 114.5 \pm 2.00	NFT 1	700207
	Junta tapa cilindros Ø 114.0 \pm 1.86	CNC	700208
8304703	Junta tapa válvulas superior	CG 2	700810
	Junta para cárter	NB 1	710111
8817760	Tapa distribución	NB 1	700812
	Bomba de agua	NB 1	710114
	Jgo. múltiple escape (3)	FCH 1	700215
8308543	Salida de escape	NFT 1	700218
	Placa bomba de agua	NB 1	710119
8817468	Base bomba aceite	NB 2	700227
	Tubería lubricación aceite	NB 2	700827
	Brida bomba combustible	NB 1	710128
	Filtro aceite	NB 1	710129
1049122	Entre caja y bomba reguladora	NB 1	700832
760203	Tapa reguladora bomba inyectora	NB 1	700833
	Tapa inspección distribución	CB 1	710134
	Enfriador aceite	NB 1	710135
3/8814976	Cañería termostato a bomba	NB 1	700837
8816260	Tubería agua a block	NB 4	700838
	Reguladora bomba inyectora	NB 1	700839
	Tapa asiento bomba levante hidráulica	CB 1	700933
	Carcaza tapa trasera	CB 1	710140
	Reguladora bomba inyectora	NB 2	710141
8828172	Retén aceite bancada cigüeñal	SNA	700842
	Cañería codo bomba agua	NB 2	710142
	Bomba agua a cañería	NB 1	710143
541353	Junta base bomba inyectora	NB 1	310443
	Caño agua	NB 2	710144
	Bomba alimentación	NB 1	500045
	Jgo. juntas caja de velocidades	VS	710150
	Suplemento bancada	SNA 12	700158
	Jgo. juntas compresor Marelli	VS 1	710168
	Jgo. suplemento camisa cilindros (0.05) (6)	CU	700270-0.05
	Jgo. suplemento camisa cilindros (0.07) (6)	CU	700270-0.07
	Jgo. suplemento camis cilindros (0.10) (6)	CU	700270-0.10

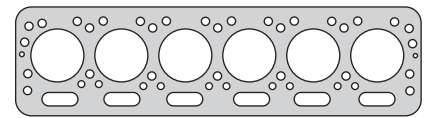

700207



700810

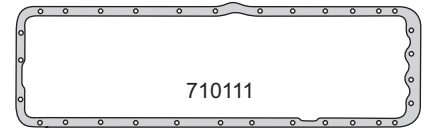
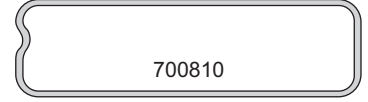

710111

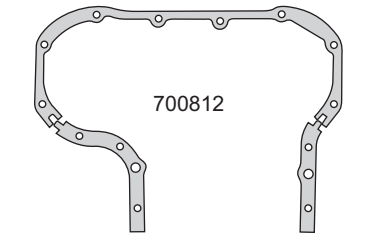

700812

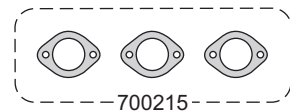

700215

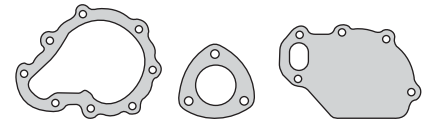

710114

700218

710119

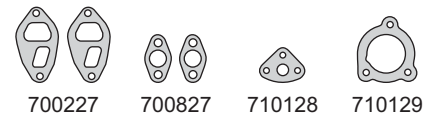

700227

700827

710128

710129



700832

700933

700833

710134

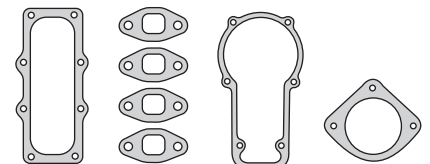

710135

700838

700839

710140

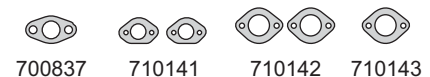

700837

710141

710142

710143



700158

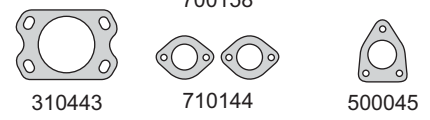

310443

710144

500045



700270-0.05

FIAT



Motor/Engine	Cm³	HP	Ø
Motorino 55/60/788R	665		75

Fiat: Motor Arranque, Tractor 1955/74



DIESEL

Nº OE	Descripción/Description	Mat.	Ref.
	Jgo. de juntas para motor		710200
15649	Junta tapa cilindros Ø 79.0 ±1.40	NFT 2	710205
15826	Tapa distribución	CB 1	710212
15737	Múltiple escape	NB 1	710215
15881	Salida de escape	NFT 1	710218
15818	Soporte post. cigüeñal	CB 1	710229
	Dispositivo arranque	CB 1	710230
15740	Base block cilindro	NB 1	700141
563755	Base carburador	NB 1	700765

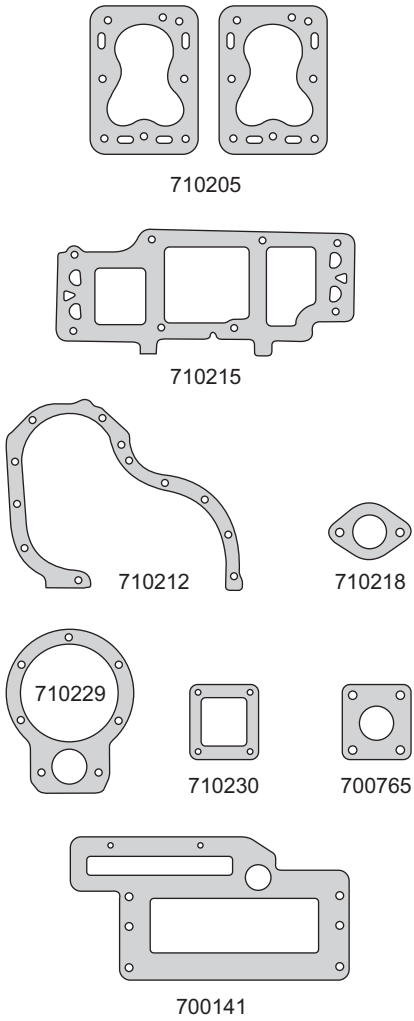

FIAT IVECO



Motor/Engine	Cm³	HP	Ø
8210.02 (OHV) 12V	13798	260	137

Fiat: Camión 619N1, 697N TB
Bus 391, 691, 319N
Bus 221A 1970/...

DIESEL



Nº OE	Descripción/Description	Mat.	Ref.
	Jgo. de juntas para motor		800000-R
	Jgo. de juntas para motor		800001
	Jgo. de juntas superior		800095
	Jgo. de juntas superior		800095-C
4680722	Jta. tapa cilindros Ø 144.0 \pm 1.40	NFT	2 800007
	Jta. tapa cilindros Ø 139.0 \pm 1.25	ACT	800008
	Jta. tapa cilindros Ø 139.0 \pm 1.25	AC	800008-CU
4654928/29	Jgo. tornillos tapa cilindros		B800000
4530174	Junta tapa válvulas superior	NB	2 2 800010
4541081	Jgo. junta para cárter (3)	NB	1 800011
4628500	Tapa distribución	NB	1 800012
4537363	Placa distribución	NB	1 800013
4006034	Bomba de agua	NB	1 800014
4871982	Jgo. múltiple escape (6)	FCH	800015
4871982	Jgo. múltiple escape (6)	CHA	1 1 800015L
	Jgo. múltiple admisión (6)	NB	1 1 800017
4530835	Salida de escape	CHA	2 2 800018L
4530835	Salida de escape	FCH	800018
4606046	Entrada bomba de agua	NB	1 1 800019
	Porta retén bancada	NB	1 800029
4547637	Tubo bomba agua	NB	1 1 800030
4606094	Tubo termostato a bomba	NB	2 2 800031
4614887	Cuerpo termostato	NB	1 800032
4616568	Entrada y salida agua	NB	6 6 800033
4621025	Cambiador temperatura	NB	2 2 800034
	Salida cañería agua		800035
4615254	Termostato	NB	1 1 800036
4617079	Tubería entrada agua	NB	20 20 800037
4632138	Cañería bomba aceite a block	NB	1 800038
768673	Entre caja y bomba reguladora		800039
4530123	Tapa registro válvulas	NB	1 800040
4526340	Soporte árbol comando bomba inyectora	NB	1 1 800041
4638506	Cuerpo respiración motor	NB	2 800042
4638621	Tapa respiración motor	NB	2 800043
4643730	Tromba de admisión	NB	1 800044
4511313	Compresor Marelli	NB	1 800045
4606042	Entrada bomba agua	NB	1 1 800046
4575911	Cañería agua	NB	1 800047
	Cañería bomba aceite	NB	1 800048
	Cañería lubricación	NB	4 800049
	Jgo. juntas caja de velocidades	VS	800050
	Pegada (71162A/71162B)	NB	1 710162
	Pegada (71163A/71163B)	NB	1 710163
	Jgo. reparación compresor Burmor s/v	VS	800066
	Jgo. juntas cañerías refrigeración	VS	800067
	Jgo. juntas compresor Marelli (11)	VS	1 800068
	Jgo. reparación compresor Burmor	VS	800069
	Retorno de agua	NB	4 4 800087
	Retorno de agua	NB	2 2 800088
	Soporte bomba hidráulica	NB	1 800089
	Soporte bomba hidráulica	NB	1 800090
	Bomba hidráulica	NB	1 800091
	Base compresor	NB	1 800092

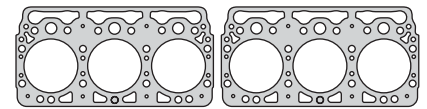

800007

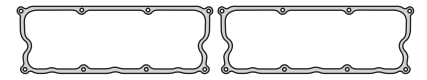

800010

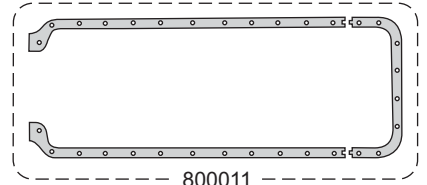

800011

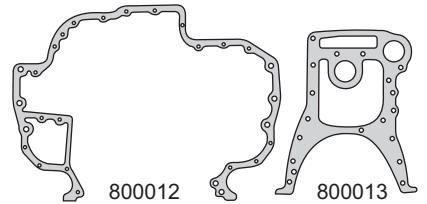

800012

800013

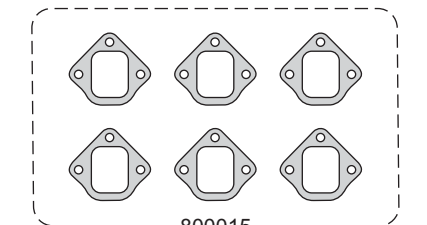

800015

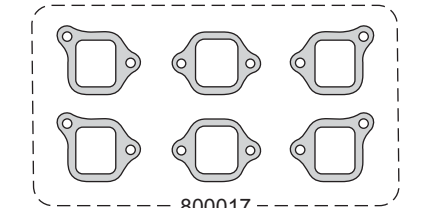

800017

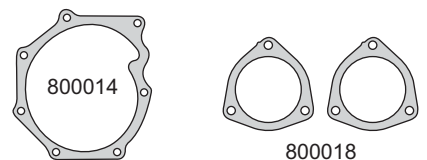

800014

800018

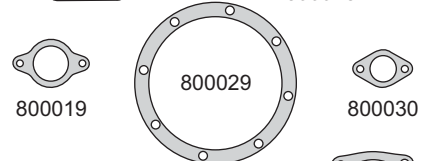

800019

800029

800030



800031

800034

800032



800033

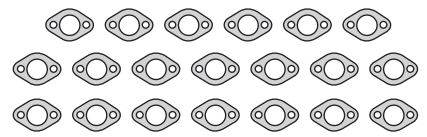

800037

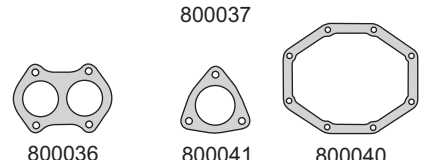

800036

800041

800040

FIAT IVECO



Motor/Engine	Cm³	HP	Ø
8210.02 (OHV) 12V	13798	260	137

Fiat: Camión 619N1, 697N TB
Bus 391, 691, 319N
Bus 221A 1970/...

DIESEL



Nº OE	Descripción/Description	Mat.		Ref.
	Intermedia compresor	CB	1	800093
	Jgo. juntas cañería bomba aceite	VS		800094
	Junta placa	CG	1	800096
	Bomba aceite	NB	1	800098
	Bomba aceite	NB	2	800099
	Arandela A 12 x 16 x 1 C	CU	2	
	Arandela A 6 x 10 x 1 C	CU	1	1
	Arandela A 8 x 13 x 1 C	CU	12	12
	Arandela bomba inyectora C 10 x 20 x 0.5 C	CU	6	6
	Arandela A 14 x 20 x 1.5 C	CU	10	10
	Arandela A 16 x 21 x 1 A	AL		3
	Arandela A 24 x 30 x 1.5 A	AL		2
	Arandela A 16 x 21 x 1.5 C	CU	6	6
	O´ring G 112 x 4	GS		3
	O´ring G 28.24 x 2.62	GS		2
	Kit de retenes completo			R800000
	Retén bancada 140 x 165 x 13	P	1	R800511P
	Retén distribución 70 x 90 x 15	P	1	R800012P
	Retén árbol de levas 25 x 40 x 8	N	1	R280415N

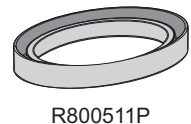
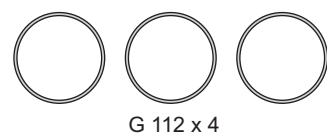
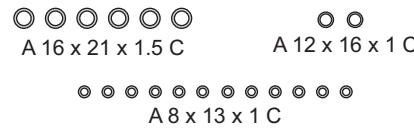
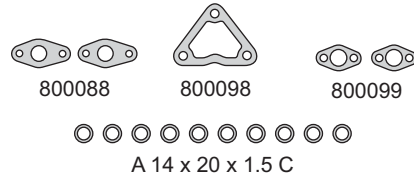
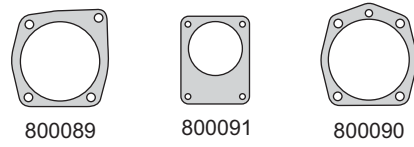
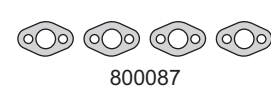
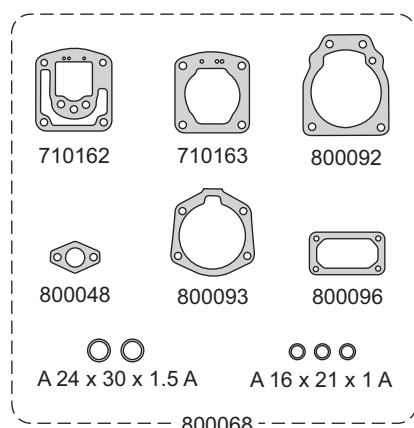
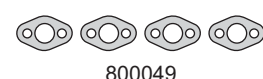
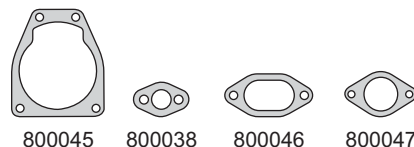
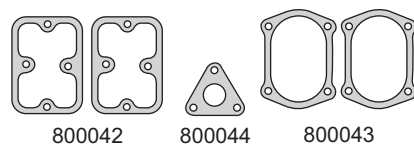

FIAT



Motor/Engine	Cm³	HP	Ø
682 N2 MK3	10676		125
DIESEL			

Fiat: Camión 203



Nº OE	Descripción/Description	Mat.	Ref.
	Jgo. de juntas para motor		800100
758025	Junta tapa cilindros Ø 127.0 ± 1.40	NFT 2	800105
968684	Junta tapa válvulas superior	CG 2	800110
	Jgo. junta para cárter (4)	CB 1	800111
1902214	Tapa distribución	CB 1	800112
	Placa distribución	CB 1	800113
	Tapa bomba de agua	CB 1	800114
968689	Jgo. múltiple escape (6)	NFT 1	800115
969035	Jgo. múltiple admisión (6)	NFT 1	800117
851774	Salida de escape	NFT 2	800118
852384	Bomba agua a block	CB 1	800119
889459	Tapa filtro aceite	CB 1	800127
889757	Tapa filtro aceite	CB 1	800129
889458	Base soporte bomba aceite	CB 1	800130
	Tubo aspiración	NB 1	800131
	Cuerpo termostato	NB 1	800132
	Base filtro aceite	CB 1	800133
	Cabecera cárter	CB 1	800134
	Cañería aspiración a tubo	NB 6	800135
858924	Junta tapa válvulas lateral	CG 2	800136
	Tubo colector agua (4)	NB 4	800137
	Cañería agua	NB 6	800138
	Tubo lubricación a bomba aceite	NB 1	800139
	Cañería agua	NB 1	800140
	Cañería agua	NB 1	800141
80142	Cañería agua	NB 1	800142
	Cañería agua	NB 1	800143
	Tapa inspección distribución	CB 1	800144

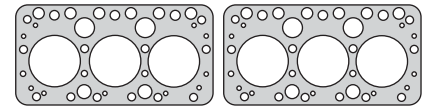

800105



800110

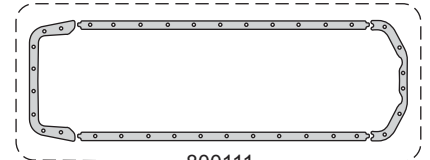

800111



800114

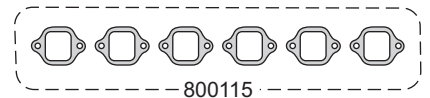

800115

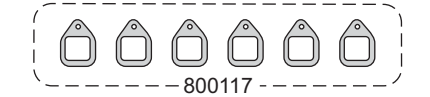

800117

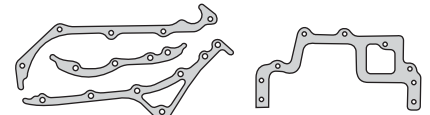

800112

800113

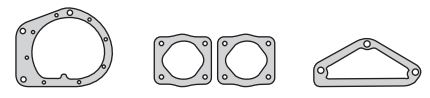

800114

800118

800119

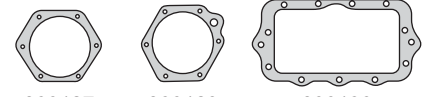

800127

800129

800130

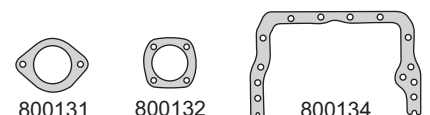

800131

800132

800134

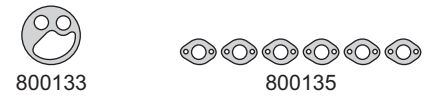

800133

800135



800138



800139

800137

800140

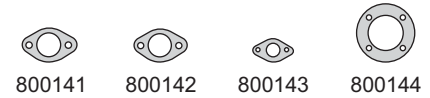

800141

800142

800143

800144

FIAT IVECO



Motor/Engine	Cm³	HP	Ø
221- 8210.01	12883	240	135

Fiat: Camión Bus 341A, 221, 221H
619 NP 1965/66
693 N/N1 - T/T1 1965/68



DIESEL

Nº OE	Descripción/Description	Mat.	Ref.
	Jgo. de juntas para motor	●	800200-R
	Junta tapa cilindros Ø 137.0 ± 1.40	NFT 2	800207
4654928/29	Jgo. tornillos tapa cilindros		B800000
4530174	Junta tapa válvulas superior	NB 2	800010
4541081	Jgo. junta para cárter (3)	NB 1	800011
	Tapa distribución	NB 1	800212
	Placa distribución	CB 1	800213
4006034	Bomba de agua	NB 1	800014
	Jgo. múltiple escape (6)	NFT 1	800115
	Jgo. múltiple admisión (6)	NB 1	800017
4530835	Salida de escape	NFT 2	800018
4614887	Cuerpo termostato	NB 1	800032
4616568	Entrada y salida agua	NB 6	800033
	Junta	NB 1	800233
	Salida cañería agua	NB 2	800035
4617079	Tubería entrada agua	NB 20	800037
4632138	Cañería aceite a block	NB 1	800038
4511313	Compresor marelli	NB 1	800045
4606042	Entrada bomba agua	NB 1	800046
4575911	Cañería agua	NB 1	800047
	Jgo. reparación compresor marelli		800269
	Kit de retenes completo		R800000
	Retén bancada 140 x 165 x 13	P 1	R800511P
	Retén distribución 70 x 90 x 15	P 1	R800012P
	Retén árbol de levas 25 x 40 x 8	N 1	R280415N

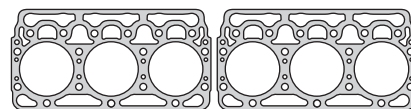

800207



800010

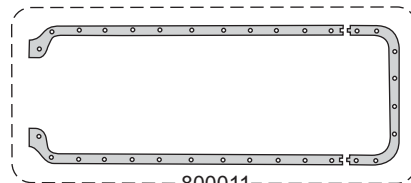

800011

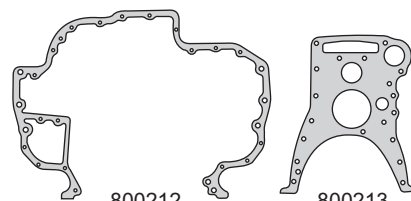

800212

800213

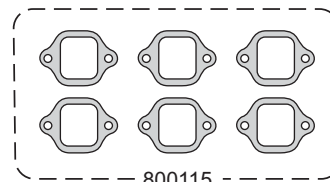

800115

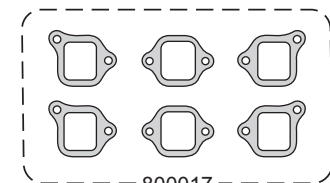

800017



800014

800018

800032



800033

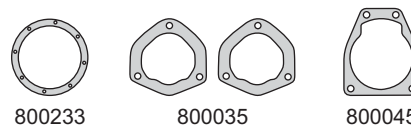

800233

800035

800045



800046

800038

800047

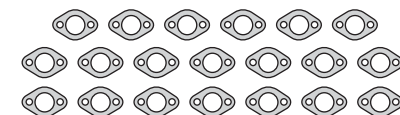

800037



R800511P



R800012P



R280415N

FIAT IVECO



Motor/Engine	Cm³	HP	Ø
8060.25	5861	177	104
8060.45/45S (OHV) 12V	5861	207	104

Iveco: Camión 150 N Turbo AU130
Eurocargo 150 E23, 150 E20

DIESEL



Nº OE	Descripción/Description	Mat.	Ref.
1907934	Jgo. de juntas para motor		800300-R
1907832	Junta tapa cilindros Ø 105.3 \pm 1.70	NFT	1 800307
98427866	Junta tapa válvula	GS	1 800310
1902553	Jgo. junta para cárter (4)	NB	1 800311
98424045	Junta tapa distribución	NB	1 800312
98424046	Placa distribución	NB	1 800313
4599560	Tapa bomba de agua	NB	1 800314
98489690	Jgo. múltiple escape (6)	CHA	1 800315
4851921	Jgo. múltiple admisión (3)	NB	1 800317
4702409	Salida de escape	NFT	1 800018
98400779	Placa bomba de agua	NB	1 800319
4850986	Tapa anterior distribución	NB	1 800320
4653283	Tapa posterior distribución	NB	1 800321
1904985	Bomba hidráulica	NB	1 800322
4791332	Mando bomba inyectora	NB	1 800323
98418534	Tubo admisión	NB	1 800324
98400783	Base compresora	NB	1 800325
4851926	Base termostato	NB	1 800326
4851926	Codo termostato	NB	1 800327
4657434	Porta reten trasero	NB	1 800329
98400776	Base bomba agua	NB	1 800330
4848840	Codo termostato	NB	1 800331
4799060	Regulador bomba inyectora	NB	1 800332
4632138	Cañería agua	NB	2 800333
	Cuenta vueltas	NB	2 800334
98400786	Enfriador de aceite	NB	1 800335
4853970	Cañería aceite	NB	1 800336
4638370	Cañería aceite	NB	1 800337
	Caño de agua	NB	1 800338
	Retorno agua	NB	1 800339
	Retorno bomba de agua	NB	1 800340
4658663	Cuerpo bomba de agua	NB	1 800341
	Admisión turbo	NB	1 800342
541353	Junta base bomba inyectora	NB	1 310443
8583008	Turbina turbo	AC	1 800343
	Caño de agua	NB	1 800344
4769429	Mando bomba inyectora	NB	1 800345
	Bomba hidráulica	NB	1 800346
93161602/3	Acople trasero	NB	1 800347
98400783	Junta para cárter	NB	1 800348
619376	Entrada aceite	NB	1 800349
	Jgo. juntas caja de velocidades	VS	800350
93161602/1	Tapa pegada	NH	1 710162
93161602/2	Tapa de cilindro	NH	1 710163
98428396	Colector turbo	AC	1 350462
	Junta acople a distribución	NB	800092
93161602	Jgo. junta compresor Marelli (12)	VS	800368
	Junta tapa cilindros competición		800390
14457581	O'ring inyector G 25.12 x 1.78	GS	6
14457581	O'ring enfriador G 20.30 x 2.62	GS	2
14457681	O'ring caño bomba de aceite G 21.89 x 2.62	GS	4
17281981	O'ring enfriador G 18.72 x 2.62	GS	3
98465110	O'ring enfriador G 31.42 x 2.62	GS	2

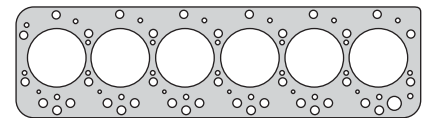

800307

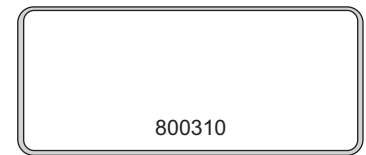

800310

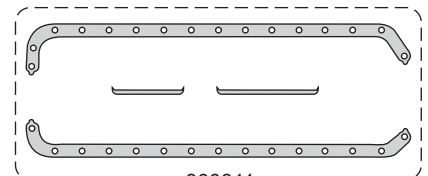

800311



800314

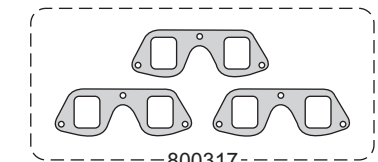

800315

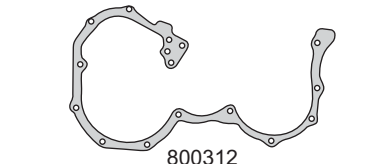

800317

800312

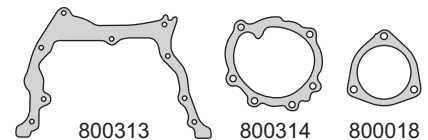

800313

800314

800018

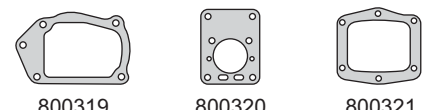

800319

800320

800321



800322

800323

800324



800325

800326

800327

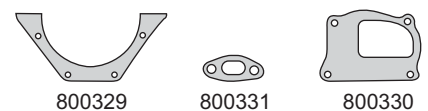

800329

800331

800330



800333

800332

800334

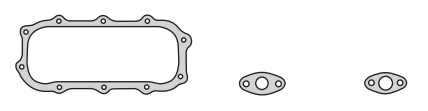

800335

800336

800337

FIAT IVECO



Motor/Engine	Cm³	HP	Ø
8060.25	5861	177	104
8060.45/45S (OHV) 12V	5861	207	104

Iveco: Camión 150 N Turbo AU130
Eurocargo 150 E23, 150 E20



DIESEL

Nº OE	Descripción/Description	Mat.	Ref.
561293	O'ring bomba de aceite G 7.3 x 2.4	GS	1
	Arandela A 16 x 20 x 1 A	AL	4
	Arandela A 24 x 32 x 1.5 A	AL	2
	Arandela A 18 x 22 x 1.5 C	CU	7
	Arandela A 22 x 26 x 1.5 C	CU	6
	Arandela C 10 x 20 x 0.5 C	CU	6
99457401	Retén bancada 114 x 135 x 13	V	R800311V
99469265	Retén distribución 42 x 65 x 10	P	R800312P

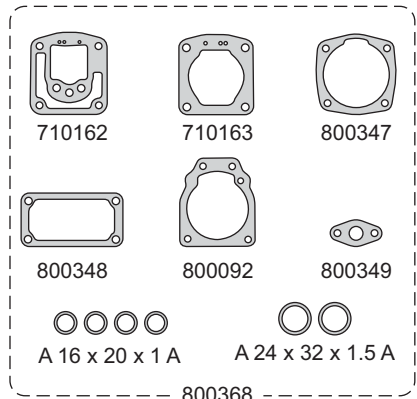
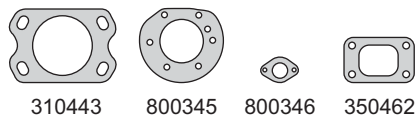
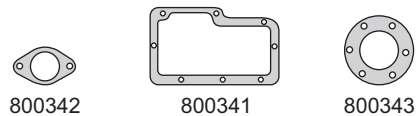
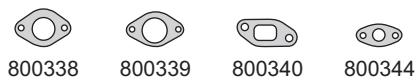

G 7.3 x 2.4

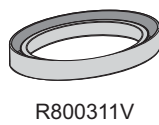
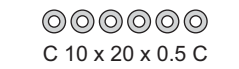
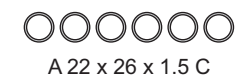

FIAT IVECO



Motor/Engine	Cm³	HP	Ø
8210.42L LE2	13798	370	137
8210.42K KE2	13798	420	137
8210.22.800 (SOHC) 12V	13798	310	137

Iveco: Euro Trakker, Euro Star, Euro Tech 1989/...
180E42, 190E31/E42/E36, 240E42/E36
260E37/E42/E36, 400E31/E37/E42
410E37/E42, 440E37/E42
720E31, 380E31 1991/...



DIESEL

Nº OE	Descripción/Description	Mat.	Ref.
0019088191	Jgo. de juntas para motor		800500-R
	Jgo. de juntas superior		800595
99465715	Junta tapa cilin. Ø 139.0 ±1.25	AC 2 2	800508
4769615/16	Jgo. tornillos tapa cilindros		B800500
98480127	Junta tapa válvulas superior	NB 2 2	800010
4791426	Jgo. junta para cárter - 1er Tipo (3)	NB 1 1	800011
98493262	Junta para cárter - 2do Tipo	NB 1 1	800511
98476488	Junta tapa distribución - 1er Tipo	NB 1 1	800512
99450903	Junta tapa distribución - 2do Tipo	NB 1 1	800512-1
99431449	Placa distribución	NB 1 1	800513
99409494	Jgo. múltiple escape (6)	NFT 1 1	800515
99440847	Jgo. múltiple admisión (6)	NFT 1 1	800517
99440847/2	Jgo. múltiple admisión (6) 2do Tipo	NFT 1 1	800517-2
4530835	Salida de escape	NFT 2 2	800018
500308780	Entrada de agua a tapa de cilindros a block	NB 11 11	800537
	Guarnición goma	GS	800538
4863958	Tapa lateral motor	NB 1 1	800040
	Tubo refrigeración	NB 1 1	800540
	Tubo refrigeración	NB 1 1	800541
	Cuerpo respiración motor	NB 2 2	800542
	Tubo refrigeración	NB 1 1	800543
	Tromba de admisión	NB 1 1	800544
4863970	Radiador enfriador aceite	NB 1 1	800545
	Tubo refrigeración	NB 1 1	800546
4575911	Cañería agua	NB 4 4	800047
4852097	Tubo refrigeración	NB 4 4	800547
	Cañería aceite turbo	NB 1 1	800048
61318850	Tubo refrigeración	NB 1 1	800549
4512366	Escape turbo	AC 1 1	810163
	Tubo refrigeración	NB 1 1	800583
	Tubo refrigeración	NB 1 1	800584
61318823	Tubo refrigeración	NB 1 1	800586
98474309	Retorno de agua	NB 4 4	800587
99435380	Entrada de agua a tapa de cilindros	NB 4 4	800588
	Tubo refrigeración	NB 1 1	800589
	Bomba hidráulica	NB 1 1	800591
	Acople compresor Marelli - bicilindrico	NB 2 2	800592
	Bomba aceite	CB 1 1	800598
	Arandela A 40 x 48.5 x 1.5 C	CU 1 1	
	Arandela A 28 x 36 x 1.5 C	CU 1 1	
	Arandela A 24 x 30 x 1.5 C	CU 1 1	
	Arandela A 18 x 24 x 1.5 C	CU 2 2	
	Arandela A 16 x 22 x 1.5 C	CU 4 4	
	Arandela A 14 x 20 x 1.5 C	CU 9 9	
	Arandela A 14 x 20 x 1 C	CU 12 12	
	Arandela A 12 x 20 x 1.5 C	CU 10 10	
	Arandela A 12 x 17 x 1.5 C	CU 5 5	
	Arandela A 10 x 18 x 1 C	CU 2 2	
	Arandela A 10 x 16 x 0.5 C	CU 2 2	
	Arandela A 10 x 16 x 1 C	CU 6 6	
	Arandela A 8 x 14 x 0.5 C	CU 5 5	
	Arandela A 20 x 26 x 1.5 C	CU 3 3	
	O'ring G 246.30 x 6.99	GS 1 1	

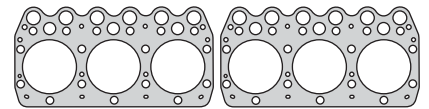

800508

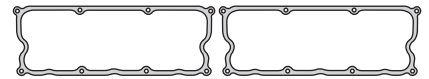

800010

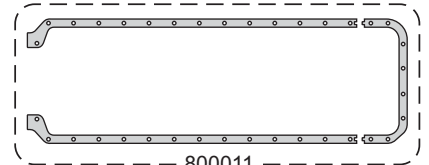

800011

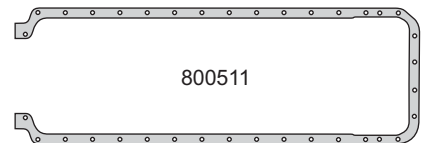

800511

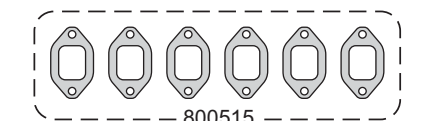

800515

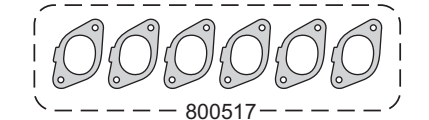

800517

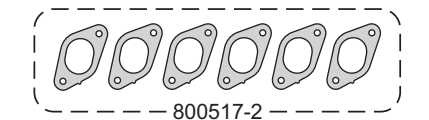

800517-2

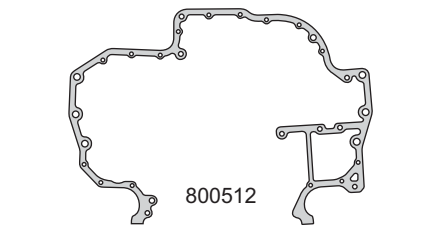

800512

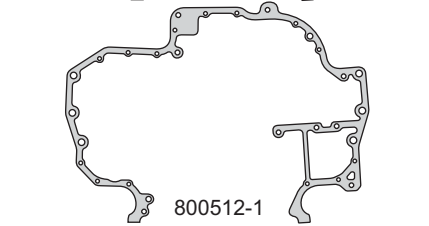

800512-1

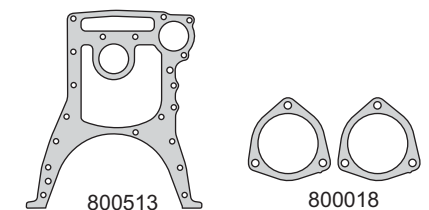

800513



800018

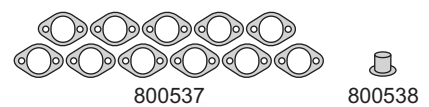

800537



800538

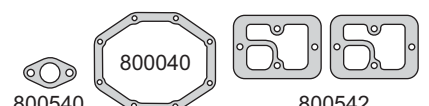

800040

800542

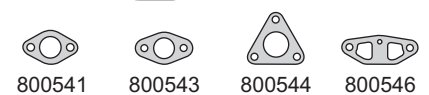

800540

800541

800543

800544

800546

FIAT IVECO



Motor/Engine	Cm³	HP	Ø
8210.42L LE2	13798	370	137
8210.42K KE2	13798	420	137
8210.22.800 (SOHC) 12V	13798	310	137

Iveco: Euro Trakker, Euro Star, Euro Tech 1989/...
 180E42, 190E31/E42/E36, 240E42/E36
 260E37/E42/E36, 400E31/E37/E42
 410E37/E42, 440E37/E42
 720E31, 380E31 1991/...



DIESEL

Nº OE	Descripción/Description	Mat.	Ref.
	O´ring G 132.94 x 3.53	GS	1
	O´ring G 100 x 2	GS	1
	O´ring G 75.79 x 3.53	GS	1
	O´ring G 71.12 x 2.62	GS	1
	O´ring G 61.60 x 2.62	GS	1
	O´ring G 60 x 4	GS	2
	O´ring G 59.92 x 3.53	GS	1
	O´ring G 59.52 x 5.33	GS	4
	O´ring G 29.82 x 2.62	GS	2
	O´ring G 25.12 x 1.78	GS	12
	O´ring G 24.99 x 3.53	GS	8
	O´ring G 24.99 x 3.53	GS	4
	O´ring G 21.89 x 2.62	GS	1
	O´ring G 18.72 x 2.62	GS	1
	O´ring G 18.77 x 1.78	GS	6
	O´ring G 6.07 x 1.78	GS	2
	O´ring G 113.89 x 3.53	GS	1
	Kit de retenes completo		R800500
98494987	Retén bancada trasera 140 x 165 x 13	V	1 R800511V
98494984	Retén distribución 70 x 90 x 10	V	1 R270112V
98494989	Retén árbol de levas 45 x 75 x 10	V	1 R800513V

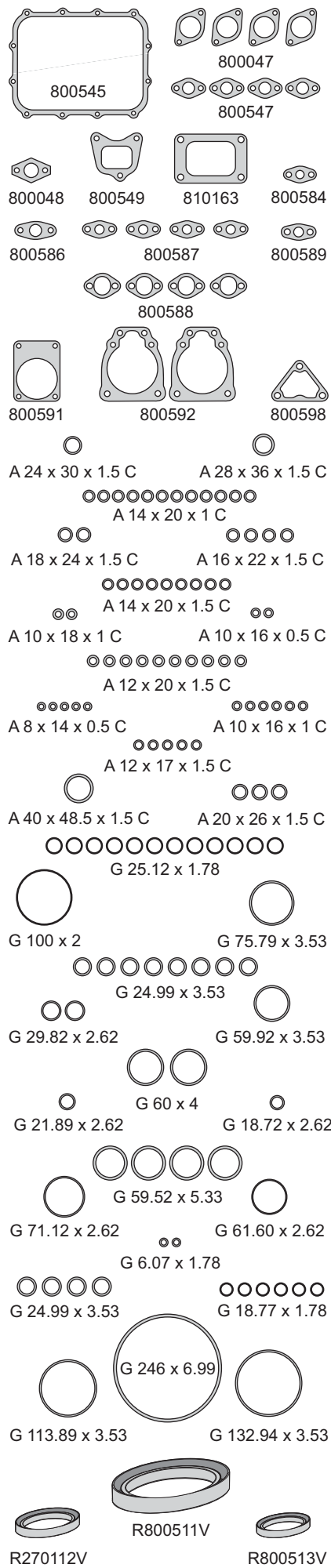

FIAT IVECO



Motor/Engine	Cm³	HP	Ø
8060.25	5861	143/177	104
8060.45/S (OHV) 12V	5861	207/277	104

Iveco: Eurocargo 75/80/85/95/100/120/130/150
170, E15 Turbo 1991/..., 80/85/100/120
130/135/150/170 E18 Turbo 1991/...
135/150/170/180/E23
80/90/100/E21



DIESEL

Nº OE	Descripción/Description	Mat.	Ref.
1907853	Jgo. de juntas para motor		800600-R
	Junta tapa cilindros Ø 105.3 ± 1.70	NFT	1 800307
4845138	Junta tapa de válvulas	GS	1 800310
1907811	Jgo. juntas para cárter (4)	NH	1 800611
9842040	Junta tapa distribución 150	NB	1 800312
9842045	Junta tapa distribución eurocargo	NB	1 800612
98424046	Placa distribución 150	NB	1 800313
98424046	Placa distribución eurocargo	NB	1 800613
	Bomba de agua	NB	1 800614
98489690	Jgo. múltiple escape (6)	NFT	1 800616
4851921	Jgo. múltiple admisión - 150 (3)	NB	1 800317
4849995	Jgo. múltiple admisión - Eurocargo (3)	NB	1 800617
4842823	Placa bomba de agua	NB	1 800619
4850986	Tapa anterior distribución	NB	1 800320
4653283	Tapa posterior block	NB	1 800321
1904985	Bomba hidráulica	NB	1 800322
4791332	Mando bomba inyectora 150	NB	1 800323
4851926	Base termostato	NB	1 800326
4849994	Porta retén trasero cigueñal	NB	1 800629
4849996	Junta base bomba inyectora	NB	1 800630
	Junta caño aceite	NB	1 800631
	Junta retorno aceite	NB	1 800632
	Junta caño aceite	NB	1 800633
	Junta caño aceite turbo	NB	1 800634
4843348	Junta intercambiador aceite	NB	1 800635
500378359	Junta hidráulica eurobase	NB	1 800636
4638370	Cañería cierre	NB	1 800337
99445563	Junta base compresor	NB	1 800639
	Jgo. juntas turbo	AC	800640
	Junta tapa	NB	1 800641
4848525	Junta admisión euroturbo	NB	1 800642
8583008	Turbina turbo 150	AC	1 800343
	Junta conducto aceite	NB	1 800643
	Turbina turbo	AC	1 800644
4769429	Mando bomba inyectora	NB	1 800345
	Acople turbo	AC	1 800645
500378761	Junta base bomba de agua	NB	1 800646
	Junta inspección aire	NB	1 800647
4851923	Junta bomba inyectora	NB	1 800648
	Junta caño agua	NB	2 800649
4851004	Junta bomba hidráulica	NB	1 800655
	Retorno aceite turbo	NB	1 800656
3520140922	Colector a escape turbo	AC	1 350462
	O´ring G 79.69 x 3	GS	1
	O´ring G 66.27 x 3.53	GS	1
	O´ring G 63.09 x 3.53	GS	1
	O´ring G 61.60 x 2.62	GS	1
	O´ring G 53.57 x 3.53	GS	1
	O´ring G 45.36 x 3.53	GS	1
	O´ring G 44.12 x 2.62	GS	1
	O´ring G 43.82 x 5.33	GS	2
	O´ring G 37.77 x 2.62	GS	1
	O´ring G 31.42 x 2.62	GS	2

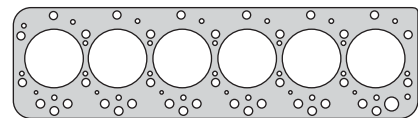

800307

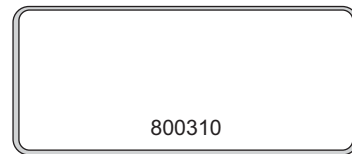

800310

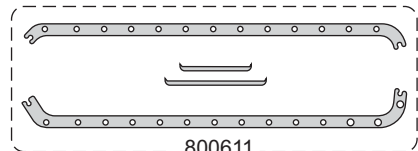

800611

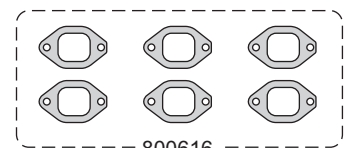

800616

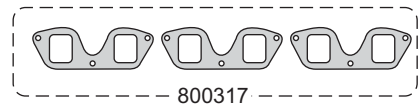

800317

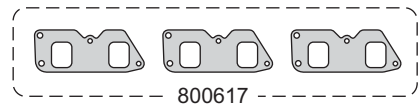

800617

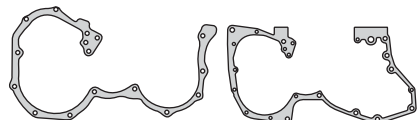

800312

800612

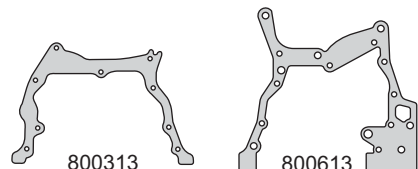

800313

800613

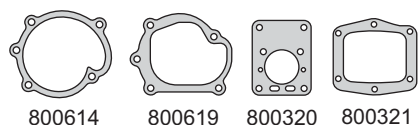

800614

800619

800320

800321

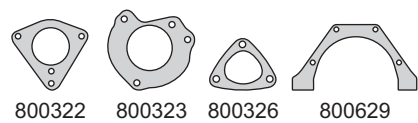

800322

800323

800326

800629

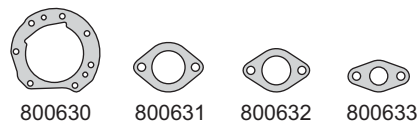

800630

800631

800632

800633

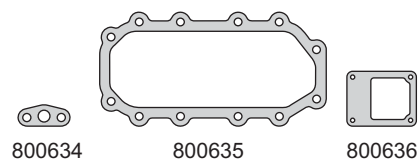

800634

800635

800636

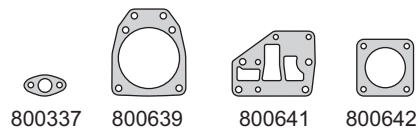

800337

800639

800641

800642

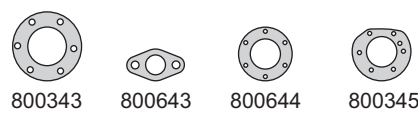

800343

800643

800644

800345

FIAT IVECO



Motor/Engine	Cm³	HP	Ø
8060.25	5861	143/177	104
8060.45/S (OHV) 12V	5861	207/277	104

Iveco: Eurocargo 75/80/85/95/100/120/130/150
170, E15 Turbo 1991/..., 80/85/100/120
130/135/150/170 E18 Turbo 1991/...
135/150/170/180/E23
80/90/100/E21



DIESEL

Nº OE	Descripción/Description	Mat.	Ref.
	O´ring G 28.3 x 1.78	GS	1
	O´ring G 26.64 x 2.62	GS	1
	O´ring G 26.57 x 3.53	GS	1
	O´ring G 25.12 x 1.78	GS	1
	O´ring G 24.99 x 3.53	GS	2
	O´ring G 23.52 x 1.78	GS	12
	O´ring G 21.89 x 2.62	GS	4
	O´ring G 21.95 x 1.78	GS	1
	O´ring G 20.30 x 2.62	GS	4
	O´ring G 5.28 x 1.78	GS	1
	Arandelas A 42 x 48 x 1.5 C	CU	1
	Arandelas A 35 x 41 x 1.5 C	CU	1
	Arandelas A 23 x 36 x 2 C	CU	1
	Arandelas A 26 x 32 x 1.5 C	CU	1
	Arandelas A 20 x 26 x 1 C	CU	2
	Arandelas A 22 x 26 x 1.5 C	CU	1
	Arandelas A 18 x 24 x 1.5 C	CU	1
	Arandelas A 18 x 22 x 1.5 C	CU	1
	Arandelas A 16 x 21 x 1.5 C	CU	7
	Arandelas A 16 x 22 x 1.5 C	CU	10
	Arandelas A 16 x 20 x 1.5 C	CU	10
	Arandelas A 14 x 20 X 1.5 C	CU	16
	Arandelas A 14 x 18 X 1.5 C	CU	12
	Arandelas A 12 x 18 X 1 C	CU	10
	Arandelas A 12 x 18 x 1.5 C	CU	7
	Arandelas A 10 x 16 x 1.5 C	CU	4
	Arandelas A 10 x 16 x 1 C	CU	11
	Arandelas A 12 x 17 x 1.5 C	CU	10
	Arandelas A 8 x 17 x 2 C	CU	6
	Arandelas A 10 x 14 x 1 C	CU	6
	Arandelas A 8 x 14 x 0.5 C	CU	5
	Arandelas A 8 x 12 x 1 C	CU	4
	Arandelas A 6 x 10 x 1 C	CU	1
	Arandelas A 5 x 8 x 1 C	CU	3
	Arandelas A 22 x 28 x 1 F	F	1
98488393	Retén distribución 42 x 65 x 10	V	1 R800312V
98488395	Retén bancada 114 x 135 x 13	V	1 R800311V

800645 800646 800647 800648

800649 800655 800656 350462

G 66.27 x 3.53

G 79.69 x 3 G 63.09 x 3.53

G 53.57 x 3.53

G 61.60 x 2.62 G 45.36 x 3.53

G 43.82 x 5.33

G 44.12 x 2.62 G 37.77 x 2.62

G 28.3 x 1.78

G 31.42 x 2.62 G 26.64 x 2.62

G 25.12 x 1.78

G 26.57 x 3.53 G 24.99 x 3.53

G 21.95 x 1.78

G 20.30 x 2.62 G 21.89 x 2.62

G 5.28 x 1.78

G 23.52 x 1.78

A 42 x 48 x 1.5 C A 35 x 41 x 1.5 C

A 26 x 32 x 1.5 C

A 23 x 36 x 2 C A 22 x 26 x 1.5 C

A 20 x 26 x 1 C

A 18 x 24 x 1.5 C A 18 x 22 x 1.5 C

A 14 x 18 x 1.5 C

A 16 x 21 x 1.5 C A 10 x 16 x 1.5C

A 14 x 20 x 1.5C

A 16 x 22 x 1.5C

A 8 x 17 x 2 C A 10 x 14 x 1 C

A 16 x 20 x 1.5C

A 8 x 14 x 0.5 C A 8 x 12 x 1 C

A 10 x 16 x 1C

A 6 x 10 x 1C A 22 x 28 x 1F

A 12 x 18 x 1.5 C

A 5 x 8 x 1 C A 12 x 18 x 1C

A 12 x 17 x 1.5 C

R800311V R800312V

FIAT IVECO



Motor/Engine

170E22
F4AE0681D
ISBe 6
(OHV) 24V

Cm³

5880
5883

HP

180/210
275

Ø

102
102

DIESEL

Cummins: ISB 2004/...

Iveco: Eurocargo 80/90 E18, 80/90 E21
Tector, Common Rail Turbo
EDC 130 E18
120 E24/E28
150 E18 2004/...



Nº OE	Descripción/Description	Mat.	Ref.
2995642	Jgo. de juntas para motor Jgo. de juntas superior	● ●	800800-R 800895
2830704	Junta tapa cilin. Ø 105 ± 1.20	MLS 1 1	800808
4891025-L14	Jgo. de tornillos para tapa de cilindros	AC	B800800
504070038	Junta tapa válvulas superior	GS 1 1	800810
504070040	Junta tapa válvulas inferior	GS 1 1	800836
4897861	Junta para cárter	GS 1	800811
50406856	Anillo goma bomba de agua G 88 x 99 x 5	GS 1	800814
2830444	Jgo. múltiple escape (6)	GFT 1 1	800816
4895121	Anillo de goma G 50 x 60 x 5	GS 1	800819
4899239	Guarnición tapa de válvulas	GS 6 6	870533
4886408	Junta enfriador aceite tapa	NFT	800834
4896409	Junta enfriador aceite placa	NFT	1 800835
4896811	Guarnición central eléctrica	GS 1	800837
4894510	Junta entrada turbo	AC 1 1	800838
4842146	Guarnición llenado aceite	GS 1 1	800839
	Junta placa separador aceite	NFT	1 870539
50403096	Guarnición termostato	GS 1 1	260039
4891288	Junta salida aceite turbo	NB	1 800840
4898301	Junta chupador aceite	NB	1 800841
4899584	Junta salida escape turbo	SLS 1 1	800844
	Kit radiador aceite (2)	NFT	1 870545
4895132	Junta escape turbo	AC 1 1	350462
	Juego turbo (4)	VS 1	800868
4830926	O´ring inyector G 21 x 3	GS 3 3	800842
4893741	Arandela pico inyector A 8 x 15 x 1.5 C	CU 6 6	800843
	Arandela A 12.5 x 17 x 1.5 C	CU	6
	Arandela A 18 x 22 x 1 C	CU	1
00R0P004	Arandela A 6 x 9 x 1 A	AC	1
	Anillo de goma G 105 x 111 x 3.65	GS	1
4830926	O´ring G 21.82 x 3.53	GS	1
	O´ring G 13.94 x 2.62	GS	2
	O´ring G 11 x 3	GS	6
	O´ring G 75.87 x 2.62	GS	1
	O´ring G 59.99 x 2.62	GS	1
	O´ring G 44 x 3	GS	1
	O´ring G 23.47 x 2.62	GS	1
	O´ring G 23.52 x 1.78	GS	2
	O´ring G 20.30 x 2.62	GS	1
	O´ring G 18.72 x 2.62	GS	1
	O´ring G 17.12 x 2.62	GS	2
	O´ring G 15.6 x 1.78	GS	2
	O´ring G 10.82 x 1.78	GS	1
	O´ring G 10.77 x 2.62	GS	1
	O´ring G 9.19 x 2.62	GS	1
	O´ring G 9.25 x 1.78	GS	1
	O´ring G 8 x 2.40	GS	12
	O´ring G 8 x 1.50	GS	2
	Kit de retenes completo		R800800
4895872/411	Jgo. retén válvulas (24)	V	1 R800810V
4890833	Retén bancada 130 x 155 x 12,5/16	T	1 R800811T
4890832	Retén distribución 70 x 100 x 12,5/16	T	1 R800812T

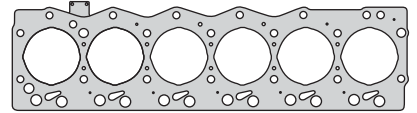

800808

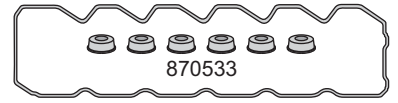

870533

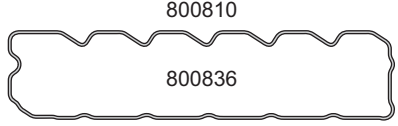

800810



800836

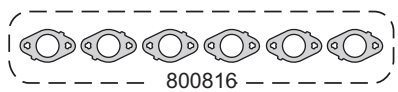

800811



800814 800819 800839 260039

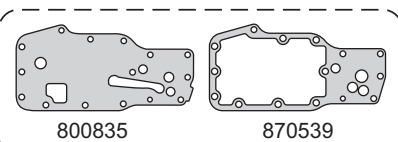

800835 870539

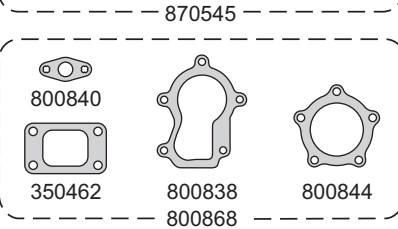

800840 350462 800838 800844 800868



800837 800841 G 75.87 x 2.62



A 8 x 15 x 1.5 C A 12.5 x 17 x 1.5 C



G 11 x 3 G 44 x 3 G 13.94 x 2.62

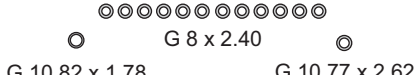

G 20.3 x 2.62 G 21 x 3 G 21.82 x 3.53



G 23.52 x 1.78 G 9.25 x 1.78 G 23.47 x 2.62



G 15.6 x 1.78 G 18.72 x 2.62

G 10.82 x 1.78 G 10.77 x 2.62

FIAT IVECO



Motor/Engine	Cm³	HP	Ø
F2BE0681 F2BE3681 E4 (SOHC) 24V	8000	310	115

Iveco: Cursor 8 Eurotech (E24/E31/E35)
Eurotrakker (E24/E27/E31/E35/T27/T31
T33/T35/T36), Stralis (S27/S30/S31/S33
S35-S36), Euro mover (E24)
Cavallino 2007/...



DIESEL

Nº OE	Descripción/Description	Mat.	Ref.
	Jgo. de juntas para motor		800900-R
	Jgo. de juntas superior	●	800995
500382172	Junta tapa cilin. Ø 127.5 ± 1.50	MLS 1 1	800908
500354580	Jgo. tornillos tapa cilindros		B800900
99446692	Junta tapa válvulas	GS 1 1	800910
99443902	Junta para cárter	GS 1 1	800911
500383038	Junta distribución	GS 1 1	800912
504154202	Jgo. múltiple escape (6)	GF 1 1	800916
504026624	Junta plano admisión	AC 2 2	800917
500301732	Salida de escape	AC 1 1	800918
504043725	Junta termostato	SLS 1 1	800919
500383043	Junta respiradero motor	GS 2	800920
504045791	Junta plano motor	SLS 1	800926
504045796	Junta enfriador de aceite	SLS 1	800938
99450932	Junta soporte frente de motor	SLS 1	800939
504013562	Junta base filtro de aceite	SLS 1	800940
	Junta	SLS 1	800941
	Junta	SLS 1	800942
	Junta brida	SLS 1	800943
	Junta brida	SLS 1	800944
	Junta	SLS 1	800945
98451118	Junta entrada turbo a escape	AC 1 1	880263
504164259	Jgo. o´ring inyector (18)	GS 1	800946
	O´ring inyector G 30 x 2.5	V 6	
	O´ring inyector G 26.5 x 2.5	S 6	
	O´ring inyector G 29 x 2.3	P 6	
	Arandela con inserto A 36.5 x 53 x 3.5	AC/GS 1	
	Arandela con inserto A 31.5 x 46 x 2	AC/GS 3	
	Arandela con inserto A 27.5 x 41.5 x 3	AC/GS 1	
	Arandela con inserto A 26 x 39 x 2	AC/GS 3	
	Arandela con inserto A 20.5 x 32 x 3	AC/GS 1	
	Arandela con inserto A 17 x 28 x 2	AC/GS 3	
	Arandela con inserto A 15 x 26 x 2	AC/GS 7	
	Arandela con inserto A 13.5 x 24 x 1.5	AC/GS 31	
	Arandela con inserto A 11.5 x 22 x 2	AC/GS 7	
	Arandela con inserto A 8 x 18 x 2	AC/GS 1	
	Arandela con inserto A 6.5 x 14 x 1.5	AC/GS 4	
	Arandela con inserto A 6.5 x 13 x 1.5	AC/GS 2	
	O´ring G 130 x 3.3	P 2	
	O´ring G 127 x 3.4	P 1	
	O´ring G 120 x 3.4	S 18	
	O´ring G 110 x 3.4	P 1	
	O´ring G 62 x 3	S 1	
	O´ring G 57 x 3.5	P 1	
	O´ring G 48 x 3	P 1	
	O´ring G 45 x 2.5	P 1	
	O´ring G 39 x 3	P 1	
	O´ring G 35 x 3.5	S 1	
	O´ring G 25 x 3.3	S 1	
	O´ring G 24 x 1.8	P 12	
	O´ring G 22 x 2.5	P 1	
	O´ring G 10 x 2.5	P 1	
	Kit de retenes completo		R800900

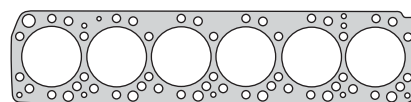

800908

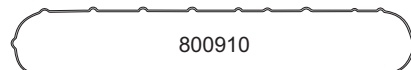

800910

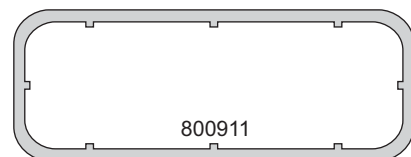

800911

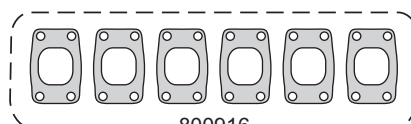

800916

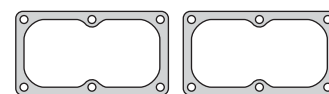

800917

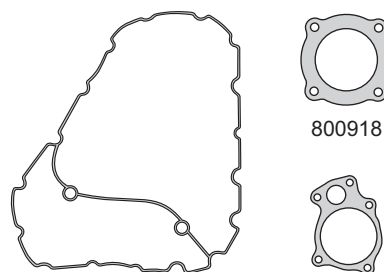

800912

800918

800919

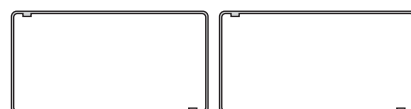

800920

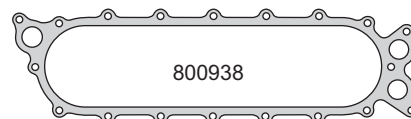

800938

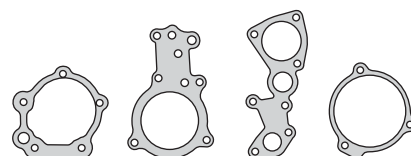

800926

800939

800940

800941

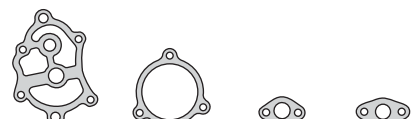

800942

800943

800944

800945

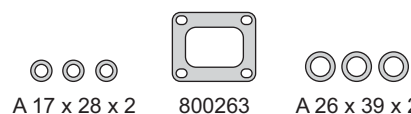

800263

A 17 x 28 x 2

A 26 x 39 x 2



A 36.5 x 53 x 3.5



A 27.5 x 41.5 x 3

A 31.5 x 46 x 2

FIAT IVECO



Motor/Engine	Cm³	HP	Ø
F2BE0681 F2BE3681 E4 (SOHC) 24V	8000	310	115

Iveco: Cursor 8 Eurotech (E24/E31/E35)
Eurotrakker (E24/E27/E31/E35/T27/T31
T33/T35/T36), Stralis (S27/S30/S31/S33
S35-S36), Eurolover (E24)
Cavallino 2007/...



DIESEL

Nº OE	Descripción/Description	Mat.	Ref.
4895872/411	Jgo. retén válvulas (24)	V	1 R800910V
99447291	Retén bancada 112 x 147 x 13.65	V	1 R800911V
99447290	Retén distribución 88 x 123 x 13.65	V	1 R800912V
	Retén auxiliar 35 x 44 x 6.2	V	1 R800913V

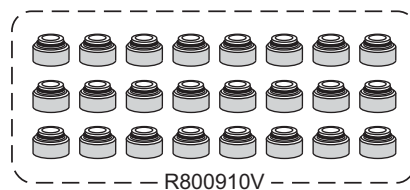
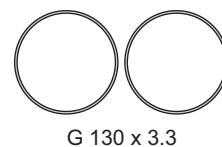
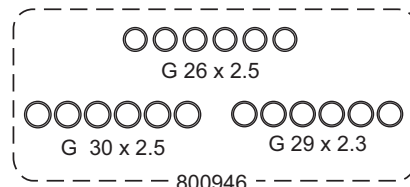
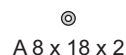
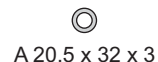

FIAT IVECO



Motor/Engine

Cm³

HP

Ø

F3BE3681A

13000















380/420

135

Iveco: Cursor 13, Euro Stard 260E48, 440E46
440E48, Stralis 260/440S44, 190/260
440S48/260/440S50/54/56, Eurotrakker
190/260/340/380E38/E44
400/410/440/720E38/E44



DIESEL

Nº OE	Descripción/Description	Mat.	Ref.
	Jgo. de juntas para motor 		801000-R
	Jgo. de juntas superior 	●	801095
504007514	Junta tapa cilin. Ø 151.0 ±1.44  N.R. 	MLS 1 1	801008
	Junta tapa de válvulas 	GS 1 1	801010
504024777	Junta para cárter 	GS 1 1	801011
500382999	Junta tapa distribución 	GS 1 1	801012
500383189	Junta placa distribución 	SLS 1 1	801013
99043768	Jgo. múltiple escape (6) 	GFT 1 1	801016
504026624	Junta plano admisión 	AC 2 2	801017
500362150	Junta carcasa termostato	SLS 1 1	801019
500383043	Junta respiradero motor	GS 2 2	801020
500398649	Junta filtro aire respiradero motor	GS 1 1	801021
99448739	Junta plano árbol levas a engranaje	SLS 1 1	801026
99452273	Junta tapa bomba aceite	SLS 1 1	801027
500343518	Junta chupador bomba aceite	SLS 1 1	801029
504045796	Junta empalme refrigerador aceite	SLS 1 1	801030
504015752	Junta acople filtros aceite	SLS 1 1	801031
	Junta	SLS 1 1	801032
99460940	Junta codo bomba de agua 	SLS 1 1	801033
	Junta	SLS 1 1	801034
98412509	Junta retorno aceite turbo	SLS 1 1	801035
504045796	Junta enfriador aceite	SLS 1 1	800938
	Junta carga aceite	GS 1 1	801040
500379769	Jgo. o´ring inyector (18)	GS 1 1	801046
500387050	Junta salida turbo	AC 1 1	810362
99458095	Junta entrada turbo	AC 1 1	810363
	Arandelas con inserto A 41 x 53 x 3	AC/GS 1	
	Arandelas con inserto A 35 x 46 x 2	AC/GS 3	
	Arandelas con inserto A 30 x 39 x 2	AC/GS 3	
	Arandelas con inserto A 23 x 32 x 2.5	AC/GS 1	
	Arandelas con inserto A 20 x 28 x 2	AC/GS 6	
	Arandelas con inserto A 18 x 22 x 2	AC/GS 26	
	Arandelas con inserto A 14 x 22 x 2	AC/GS 7	
	Arandelas con inserto A 10 x 18 x 2	AC/GS 2	
	Arandelas con inserto A 8 x 14 x 1.5	AC/GS 4	
	O´ring G 143 x 3.5	GS 18	
	O´ring G 128.5 x 3.3	GS 3	
	O´ring G 120 x 3.5	GS 1	
	O´ring G 47 x 3	GS 1	
	O´ring G 45 x 2.5	GS 2	
	O´ring G 37.5 x 3.5	GS 1	
	O´ring G 29 x 3.5	GS 1	
	O´ring porta inyector G 27 x 1.7	GS 12	
	O´ring G 12 x 2.5	GS 1	
	Kit de retenes completo 		R801000
40101874	Jgo. retén válvulas (12) 	V 1	R801010V
40102693	Retén bancada 130 x 160 x 13.5 	S 1	R801011S
40102683	Retén distribución 100 x 130 x 13 	S 1	R801012S
	Retén auxiliar fijación 34 x 43.8 x 6	P 2	R801015P

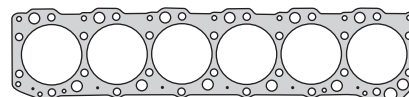

801008

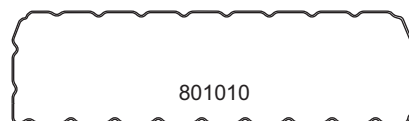

801010

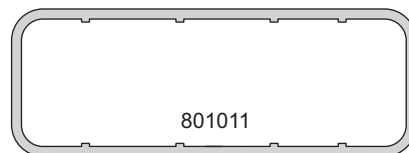

801011

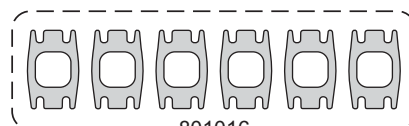

801016



801017

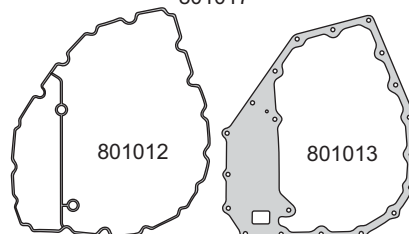

801012

801013



801020



801019

801021

801026



801027

801029

801031



800938

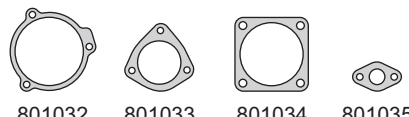

801032

801033

801034

801035



810362

810363



R801011S



R801012S



R801015P

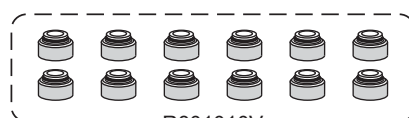

R801010V

FORD



Motor/Engine	Cm³	HP	Ø
351 V8	5900		
391 V8	6400		

Ford: Camión 1964/78



Nº OE	Descripción/Description	Mat.	Ref.
	Jgo. de juntas para motor		● 311100-RMX
	Jgo. junta tapa cilindros Ø 109.0 ± 1.20 (2)	NFT	1 311105
	Junta tapa válvulas	CG	2 310310
	Jgo. junta para cárter (3)	CG	1 311111
	Tapa distribución	CB	1 311112
	Bomba de agua	CB	1 310314
	Bomba de agua	CB	2 311114
	Jgo. múltiple escape (2)	NFT	1 311116
	Jgo. múltiple admisión (4)	NB	1 311117
	Termostato	CB	2 310319
	Bomba aceite	CB	1 311127
	Base bomba nafta	CB	1 200028
	Junta unión entre múltiples	GS	2 310330
	Entrada aceite	CB	1 310338
	Succión aceite	CB	1 310339
	O'ring G 7 x 10 x 2	GS	16
	Arandela A 14 x 18 x 1.5 A	AL	1
	Kit de retenes completo		R311100
	Jgo. retén válvulas (8)	P	1 R311110P
	Retén distribución 60.3 x 82.5 x 11	P	1 R330012P

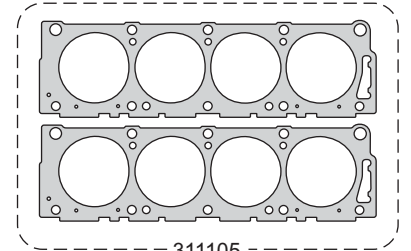

311105

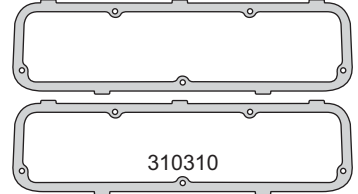

310310

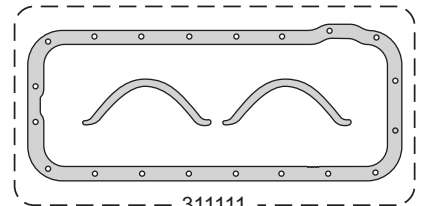

311111

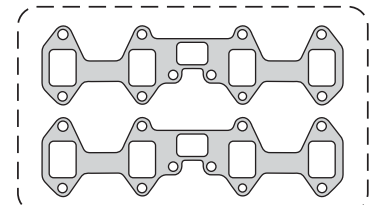

311116

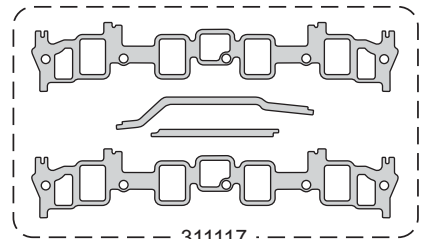

311117

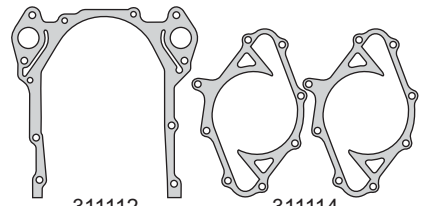

311112

311114

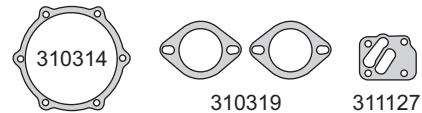

310314

310319

311127

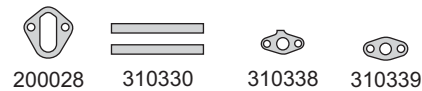

200028

310330

310338

310339



G 7 x 10 x 2

A 14 x 18 x 1.5 A



R330012P

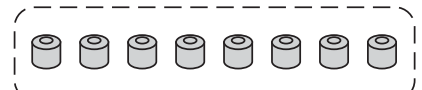

R311110P

FORD



Motor/Engine	Cm³	HP	Ø
BSD 332 - 333/H	3294	81	111.8

Ford: Tractor 4600, 4110, 4140, 4190, 4200
4400, 4410 1965/74
4610, 4610H, 4610SU 1981/90



DIESEL

Nº OE	Descripción/Description	Mat.	Ref.
	Jgo. de juntas para motor		330000
	Jgo. de juntas superior	●	330095
D3NN-6051G	Jta. tapa cilindros Ø114.5 ± 1.50	NFT	1 1 330007
C7NN-6548B	Junta tapa válvulas	CG	1 1 330010
D0NN-6710A	Junta para cárter	NB	1 1 330011
C5NE-6020A	Tapa distribución	NB	1 1 330012
C5NE-60045A	Placa distribución	NB	1 1 330013
D6NN-8513A	Tapa bomba de agua	NB	1 1 330014
C5NE-9448A	Múltiple escape	NFT	1 1 330016
D3NN-9439A	Múltiple admisión	NB	1 1 330017
D6NN-8507A	Placa bomba de agua	NB	1 1 330019
CEDE-8255A	Conexión salida de agua	NB	1 1 330119
C5NE-9F598A	Inspección distribución	NB	1 1 330029
C7NN-6659A	Bomba aceite a block	NB	1 1 330030
D0NN-H918A	Carcasa termostato	NB	1 1 330031
C5NE-9F596A	Protector inyector	CG	3 3 330032
D3NN0-9439A	Entre colectores	NB	1 1 330034
C7NN-6N008B	Tapa trasera motor	CG	1 1 330036
C5HN6N305C	Junta	CG	1 1 330037
	Válvula termostato	NB	1 1 330038
C5NE-9F585-A	Bomba inyectora	NB	1 1 330046
D3NN-6336-A	Jgo. empaquetadura lateral cigüeñal (2)	SNA	1 1 330058
C5NE-9E529-A	Arandela inyector A 10 x 16 x 1 C	CU	4 4
	Arandela A 24 x 30 x 2.5 A	AL	1 1
	Arandela A 8 x 12 x 1 C	CU	8 8
	Arandela A 19 x 25 x 1 A	AL	1 1
87095594	O'ring G 136 x 3.5	GS	1 1
379275594	O'ring G 82 x 2.5	GS	1 1
	O'ring G 56 x 4	GS	3 3
	O'ring G 20 x 4	GS	1
	O'ring G 7 x 11 x 2	GS	3 3
	Kit de retenes completo		R330000
	Jgo. retén válvulas (6)	P	1 1 R330010P
	Retén bancada 122.2 x 140.8 x 12	P	R330011P
	Retén distribución 60.3 x 82.5 x 11	P	R330012P

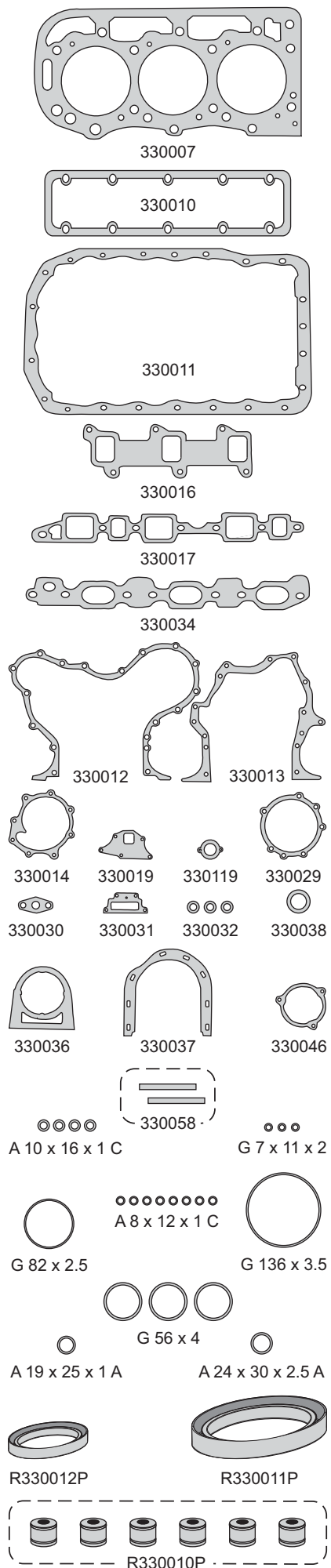

FORD



Motor/Engine	Cm³	HP	Ø
BSD 442 - 256	4196	72	111.8
BSD 444	4385	80	111.8
BSD 444T	4392	82	111.8
268	4393	82/87	111.8

Ford: Tractor 5610, 5030, 5110, 5610, 5900
6600, 6700, 7000, 7100, 7200 72HP
6410, 6610, 6710, 7600, 7700 80HP
6810, 7410, 7610, 7710 82HP
F2000, F4000, FB4000 87HP
Tractor 6600/6610 87HP



DIESEL

Nº OE	Descripción/Description	Mat.	Ref.
	Jgo. de juntas para motor		330100
	Jgo. de juntas superior		330195
D3NN-6051H	Jta. tapa cilindros Ø114.5 ±1.50	NFT	1 1 330107
C7NN-6584C	Junta tapa válvulas	CG	1 1 330110
D4NN-6710A	Junta para cárter	NB	1 1 330111
C5NE-6020A	Tapa distribución	NB	1 1 330012
C5NE-60045A	Placa distribución	NB	1 1 330013
D6NN-8513A	Tapa bomba de agua	NB	1 1 330014
C5NE-9448B	Múltiple escape	NFT	1 1 330116
	Múltiple admisión	NB	1 1 330117
D6NN-8507A	Placa bomba de agua	NB	1 1 330019
CEDE-8255A	Conexión salida de agua	NB	1 1 330119
C5NE-9F598A	Inspección distribución	NB	1 1 330029
C7NN-6659A	Bomba aceite a block	NB	1 1 330030
D0NN-H918A	Carcasa termostato	NB	1 1 330031
C5NE-9F596A	Protector inyector	CG	4 4 330032
D3NN0-9439B	Entre colectores	NB	1 1 330134
	Colector admisión	NB	1 1 330135
C7NN-6N008B	Tapa trasera motor	CG	1 1 330036
C5HN6N305C	Junta	CG	1 1 330037
	Válvula termostato	NB	1 1 330038
C5NE-9F585-A	Bomba inyectora	NB	1 1 330046
D3NN-6336-A	Jgo. empaquetadura lateral cigüeñal (2)	SLA	1 1 330058
C5NE-9E529-A	Arandela inyector A 9.6 x 17 x 1.5 C	CU	
	Arandela A 24 x 30 x 2.5 A	AL	1 1
	Arandela A 19 x 25 x 1 A	AL	1 1
	Arandela A 8 x 12 x 1 C	CU	8 8
	Arandela A 10 x 16 x 1 C	CU	4 4
87095594	O'ring G 136 x 3.5	GS	1 1
379275594	O'ring G 82 x 2.5	GS	1 1
	O'ring G 56.5 x 4	GS	1 1
	O'ring G 20 x 4	GS	1 1
	O'ring G 7 x 11 x 2	GS	4 4
	Kit de retenes completo		R330100
	Jgo. retén válvulas (8)	P	1 1 R330110P
	Retén bancada 122.2 x 140.8 x 12	P	R330011P
	Retén distribución 60.3 x 82.5 x 11	P	R330012P

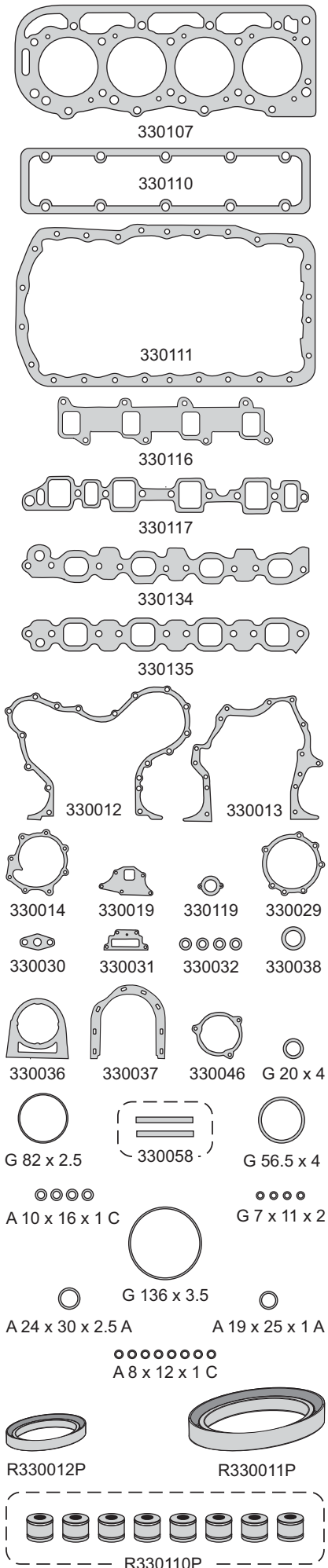

FORD



Motor/Engine	Cm³	HP	Ø
Fase I-II Cargo 6.6/7.8 Simples/Turbo	6572	110	111.8

Ford: 7810, 7910, 8210, 8530 1988/...
8630, 8750, 8830 1992/...
Fase I-II, Cargo 6.6/7.8 Simples/Turbo



DIESEL

Nº OE	Descripción/Description	Mat.	Ref.
	Jgo. de juntas para motor		330200-R
ETHN-6051AA	Junta tapa cilindros Ø 114.5 ± 1.50	NFT	1 330207
E5HN-6584AA	Junta tapa válvulas		1 330210
E3HN-6710AA	Junta para cárter		1 330211
E5HN-6020AB	Tapa distribución		1 330212
E5HN6N645AB	Placa distribución	NH	1 330013
E3HN-6020AA	Tapa distribución		1 330213
E5HN-8507AA	Bomba de agua		1 330214
E5HN-9448AB	Jgo. múltiple escape (2)		1 330215
C5NE-9448A	Jgo. múltiple escape (2)		1 330216
E5HN-9439AA	Múltiple admisión		1 330217
E5HN-8255AA	Salida de agua		1 330219
E5HN-9L437AC	Conexión admisión		1 330220
E6NN-6N653AB	Pasaje aceite		1 330230
64HN-6N652AB	Pasaje aceite turbo		1 330231
E3HN-9439AA	Entre colector admisión		1 330234
E5HN-6N305C	Tapa placa	CG	1 330037
	Junta		1 330263
E5HN-6N640AA	Entrada turbina	AC	1 810363
	Arandela A 24.8 x 19.6 x 2 N	N	1
	Arandela A 17.9 x 9.5 x 1.5 C	CU	6
	Arandela A 9.9 x 6.3 x 0.83 C	CU	12
	O'ring G 7.65 x 1.78	GS	2
	O'ring G 10.82 x 1.78	GS	8
	O'ring G 17.17 x 1.78	GS	6
	O'ring G 21.82 x 3.53	GS	3
	O'ring G 26.57 x 3.53	GS	3
	O'ring G 23.47 x 2.90	GS	1
	O'ring G 32.92 x 3.53	GS	1
	O'ring G 38 x 3.40	GS	3
	O'ring G 55.25 x 2.50	GS	1
	O'ring G 44.12 x 2.62	GS	1
	O'ring G 82.22 x 2.62	GS	1
	Kit de retenes completo		R330200
	Jgo. retén válvulas (12)	P	1 R330210P
	Retén bancada 122.2 x 140.8 x 12	P	1 R330011P
	Retén distribución 66.7 x 88.89 x 11/12.5	P	1 R330212P

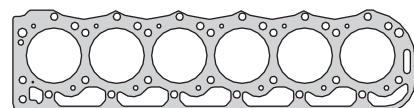

330207

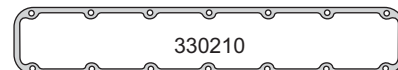

330210

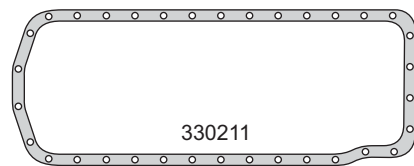

330211

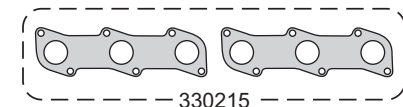

330212

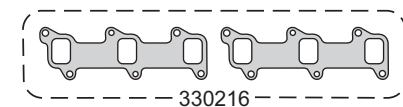

330013

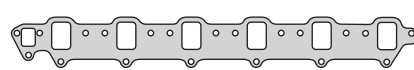

330214



330215



330216

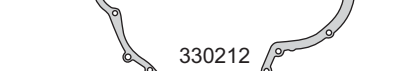

330219



330220



330230



330231



330234



330037



330263



810363

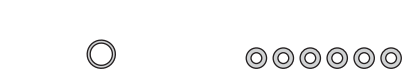

A 24.8 x 19.6 x 2 N



A 17.9 x 9.5 x 1.5 C

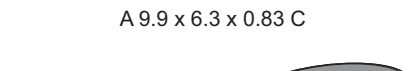

A 9.9 x 6.3 x 0.83 C



R330212P



R330011P

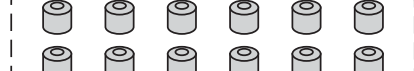

R330210P

HANOMAG



Motor/Engine **R45/55/60/75** Cm³ **5702** HP **110** Ø **110**

Hanomag: Tractor, D57 1963/...

DIESEL



Nº OE	Descripción/Description	Mat.	Ref.
	Jgo. de juntas para motor		750000
507904	Junta tapa cilindros Ø 117.5 \pm 0.80	NFT	750009-0.80
507904	Junta tapa cilindros Ø 117.5 \pm 0.60	NFT	750009-0.60
509219	Junta tapa válvulas superior	CB	750010
505559	Junta para cárter	NB	750011
503864	Tapa distribución	NB	750012
512760	Bomba de agua	NB	750014
71511B	Jgo. múltiple escape (3)	NFT	750015
	Jgo. múltiple admisión (2)	NFT	750017
71511A	Salida de escape	NFT	750018
507632	Acople bomba de agua	NB	750019
503865	Entre caja distribución	CB	750029
503884	Tapa reguladora	NB	750030
503151	Tapa bomba inyectora	NB	750032
504173	Purificación aire	NB	750034
506676	Bomba combustible	NB	750035
503871	Junta tapa válvulas lateral	NB	750036
996800009	22 din 71511	NFT	750037
996800036	26 din 71511	NFT	750038
996800013	56 din 71511	NFT	750039
996800012	50 din 71511	NFT	750040
509199	Brida ciega	NFT	750041
512579	Filtro aire	NB	750042
504005	Salida agua	NB	750043
510978	Tubo aspiración	NB	750044
	Entrada agua	NB	750045
512102000	Filtro aceite	NB	750046
	Tapón desagote	NB	750047
540289	Tapa inspección	CB	750048
	Jgo. juntas bancada cigüeñal (2)	SNA	750058

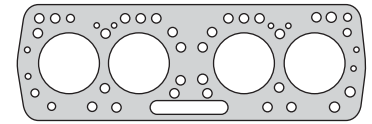

750009 - 0.60

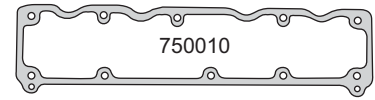

750010

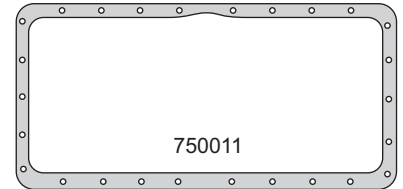

750011

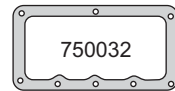

750012

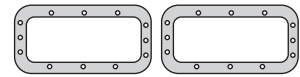

750014



750015

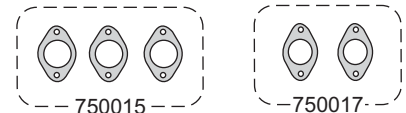

750017

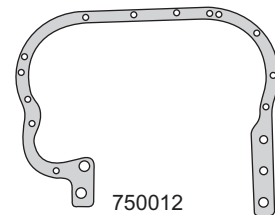

750018

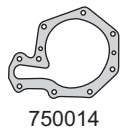

750019

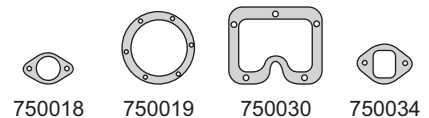

750030

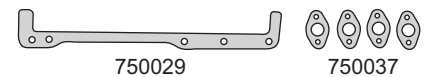

750034



750035

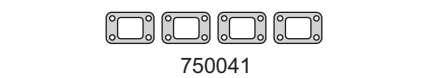

750038

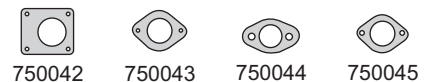

750039



750040



750041



750042



750043

750044

750045

750046

750047

750048

750058

HANOMAG



Motor/Engine	Cm ³	HP	Ø
R25 - L28 R35 - R40 R435 Brillant	2800		90

Hanomag: Tractor, D28LA, D28 1950/55

DIESEL



Nº OE	Descripción/Description	Mat.	Ref.
	Jgo. de juntas para motor	●	750100
151100-34	Junta tapa cilindros Ø 96.0 ± 1.00	NFT	1 750109
151127-3	Junta tapa válvulas superior	CG	1 750110
151100-5	Junta para cárter	CB	1 750111
151100-23	Tapa distribución	CB	1 750112
151250-16	Bomba de agua	NB	1 750114
151100-59	Múltiple admisión y escape	NFT	1 750116
151100-14	Bomba de agua a block	NB	1 750119
151253-3	Salida de agua	NB	1 750129
151100-33	Regulador refrigeración	CB	1 750130
151100-68	Tubería aceite	CB	4 750131
	Codo aspirante	CB	1 750132
	Caño admisión	CB	1 750133
151178-10	Bomba inyectora	CB	1 750134
151106-4	Brida ciega	CG	1 750135
152200-11	Junta tapa válvulas lateral	CG	2 750136
	Bomba alimentación	NB	1 750035

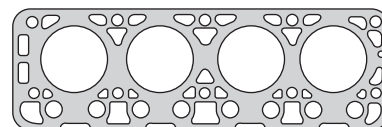

750109



750110

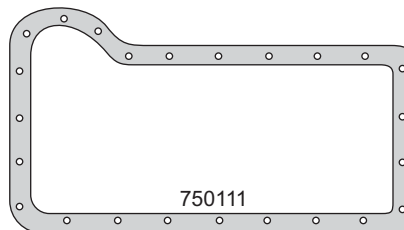

750111



750136



750116

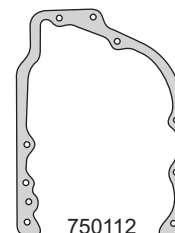

750112

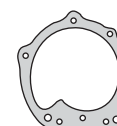

750114

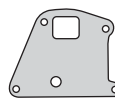

750119



750129



750130



750132



750131



750133

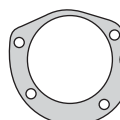

750134



750035

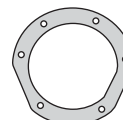

750135

HANOMAG



Motor/Engine	Cm³	HP	Ø
R40 25e R57 - R46	2800		90
DIESEL			

Hanomag: Brillant, Tractor D28C 1965/71



Nº OE	Descripción/Description	Mat.	Ref.
	Jgo. de juntas para motor		750200
	Junta tapa cilindros Ø 96.0 ± 1.00	NFT	1 750209
	Junta tapa válvulas	CG	1 750210
151100-5	Junta para cárter	CB	1 750111
	Tapa distribución	CB	1 750212
	Tapa bomba de agua	NB	1 750114
	Múltiple admisión y escape	NFT	1 750216
	Bomba de agua a block	NB	1 750119
151253-3	Salida de agua	NB	1 750129
151100-33	Regulador refrigeración	CB	1 750130
151100-68	Tubería aceite	CB	4 750131
	Codo aspirante	CB	1 750132
	Caño admisión	CB	1 750133
151178-10	Bomba inyectora	CB	1 750134
151106-4	Brida ciega	CG	1 750135
	Bomba alimentación	NB	1 750035
152200-11	Junta tapa válvulas lateral	CG	2 750136

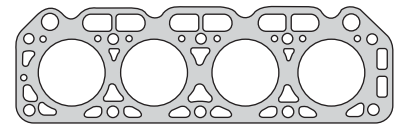

750209

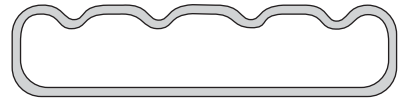

750210

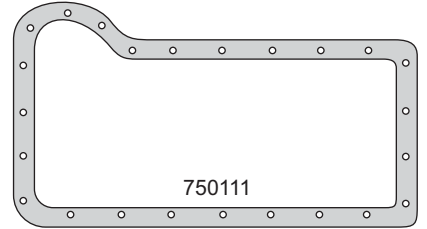

750111



750136



750216

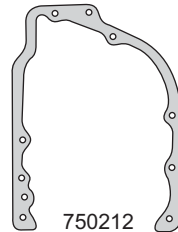

750212

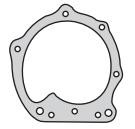

750114

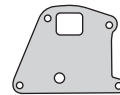

750119



750129



750130



750131



750132



750133

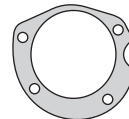

750134



750035

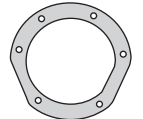

750135



taranto



Sistemas de Embrague Taranto Premium

Diseñado para resistir las altas temperaturas generadas durante su funcionamiento, garantizando el óptimo desempeño en las más exigentes condiciones.

- ▶ Suavidad de acople en arranques y cambios de velocidades
- ▶ Transmisión de fuerza garantizada
- ▶ Óptima resistencia térmica
- ▶ Mayor confort y durabilidad
- ▶ Soporta altas exigencias
- ▶ Bajo esfuerzo operativo.

INCLUYE RODAMIENTOS

SKF



HYUNDAI



Motor / Engine	Cm ³	HP	Ø
D4AL (SOHC) 8V	3298	120	100
DIESEL			

Hyundai: Mighty, County
Turbo Intercooler



995108

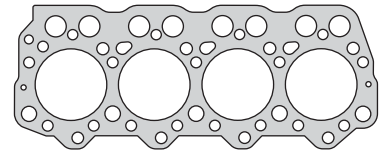

995110

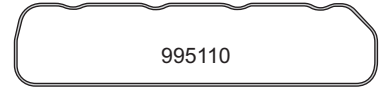

995111

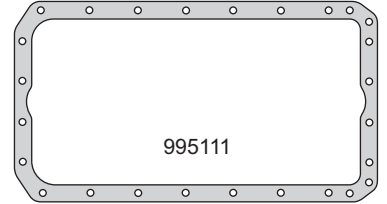

995115

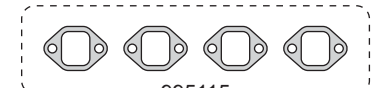

995117

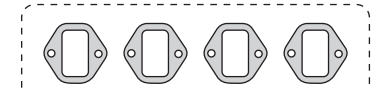

995112

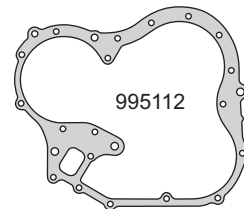

995118 995119



995113

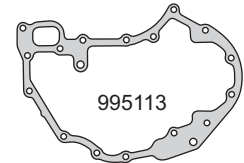

995127 995128

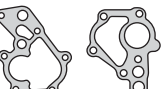

995129



995130



995132



995133



995137



995140



995141



995142

G 60 x 3



G 13.94 x 2.62



G 17 x 3



G 21.82 x 3.53



G 21.82 x 3.53



G 98 x 3



G 135 x 3



R995111S



R920612S



R995110P

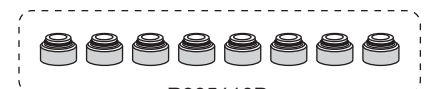

Nº OE	Descripción / Description	Mat.	Ref.
	Jgo. de juntas para motor		995100-R MLS
	Junta tapa cilindros Ø 102.5 x 1.45	MLS	1 995108
	Junta tapa válvulas	GS	1 995110
	Junta para cárter	NB	1 995111
	Tapa distribución	NB	1 995112
	Placa distribución	NB	1 995113
	Jgo. múltiple escape (4)	AC	1 995115
	Jgo. múltiple admisión (4)	NB	1 995117
	Salida de escape	FCH	1 995118
	Junta termostato	NB	1 995119
	Tapa bomba de aceite	NB	1 995127
	Junta	NB	1 995128
	Junta	CG/AC	1 995129
	Chupador aceite	NB	2 995130
	Junta cámara de agua	NB	1 995132
	Tapa bomba de aceite	NB	1 995133
	Cierre bancada	AC/GS	4 995135
	Junta bomba inyección combustible	NB	1 995137
	Junta	NB	1 995140
	Junta	NB	1 995141
	Junta	NB	1 995142
	O'ring G 17 x 3	S	2
	O'ring G 13.94 x 2.62	GS	5
	O'ring G 21.82 x 3.53	GS	2
	O'ring G 21.82 x 3.53	S	6
	O'ring G 60 x 3	GS	2
	O'ring G 98 x 3	GS	1
	O'ring G 135 x 3	GS	1
	Kit de retenes completo		R995100
	Jgo. retén válvulas (8)	P	1 R995110P
	Retén bancada 100 x 124/158 x 14.5	S	1 R995111S
	Retén distribución 55 x 78 x 12	S	1 R920612S

HYUNDAI



Motor / Engine Cm³ HP Ø

D4AF 3568 96 104

Hyundai: Mighty, County Aspirado

DIESEL



Nº OE	Descripción / Description	Mat.	Ref.
	Jgo. de juntas para motor		995200-R MLS
	Junta tapa cilindros Ø 105.5 ±1.45	MLS	1 995208
	Junta tapa válvulas	GS	1 995110
	Junta para cárter	NB	1 995111
	Tapa distribución	NB	1 995112
	Placa distribución	NB	1 995113
	Jgo. múltiple escape (4)	AC	1 995115
	Jgo. múltiple admisión (4)	NB	1 995117
	Salida de escape	FCH	1 995118
	Junta termostato	NB	1 995219
	Tapa bomba de aceite	NB	1 995127
	Junta	NB	1 995128
	Junta	CG/AC	1 995229
	Chupador aceite	NB	2 995130
	Junta cámara de agua	NB	1 995232
	Tapa bomba de aceite	NB	1 995133
	Cierre bancada	AC/GS	4 995135
	Junta bomba inyección combustible	NB	1 995137
	Junta	NB	1 995140
	Junta	NB	1 995141
	Junta	NB	1 995242
	Junta	NB	1 995243
	O'ring G 17 x 3	GS	4
	O'ring G 13.94 x 2.62	GS	5
	O'ring G 21.89 x 2.62	GS	2
	O'ring G 21.82 x 3.53	GS	6
	O'ring G 60 x 3	GS	2
	O'ring G 98 x 3	GS	1
	O'ring G 135 x 3	GS	1
	Kit de retenes completo		R995200
	Jgo. retén válvulas (8)	P	1 R995110P
	Retén bancada 100 x 120 x 13	S	1 R995211S
	Retén distribución 55 x 78 x 12	S	1 R920612S

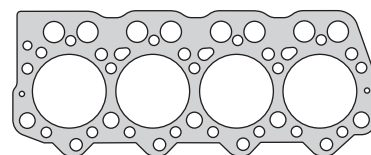

995208

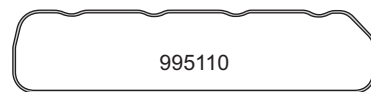

995110

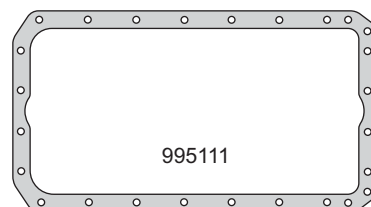

995111

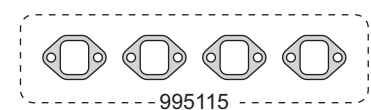

995115

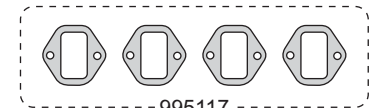

995117

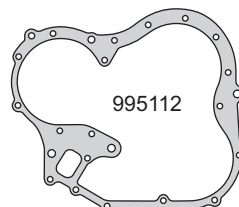

995112

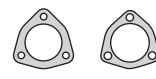

995118 995219

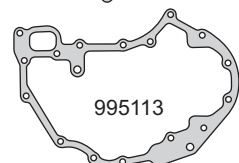

995113

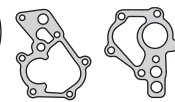

995127 995128

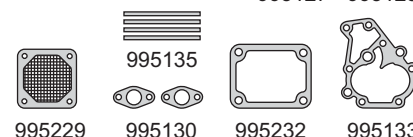

995229 995130 995232 995133

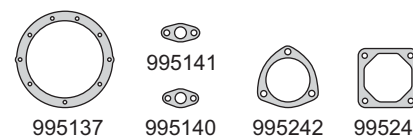

995137 995140 995242 995243

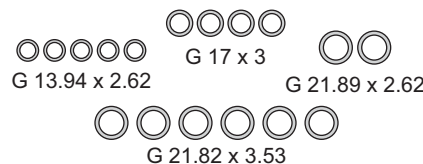

G 17 x 3
G 13.94 x 2.62 G 21.89 x 2.62
G 21.82 x 3.53

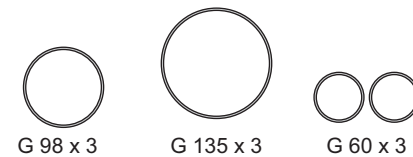

G 98 x 3 G 135 x 3 G 60 x 3

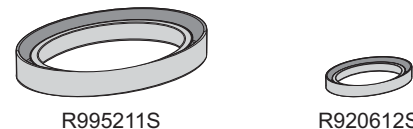

R995211S R920612S

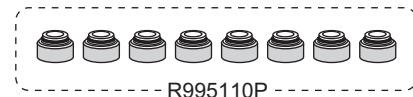

R995110P

HYUNDAI



Motor / Engine **Cm³** **HP** **Ø**

D4DA
(SOHC) 8V **3907** **155** **104**

Hyundai: Mighty, County
Turbo Intercooler

DIESEL



Nº OE	Descripción / Description	Mat.	Ref.
	Jgo. de juntas para motor		995300-R MLS
	Junta tapa cilindros Ø 105.0 ±1.50	MLS	1 995308
	Junta tapa válvulas	GS	1 995110
	Junta para cárter	NB	1 995111
	Junta frente motor	NB	1 995312
	Jgo. múltiple escape (4)	AC	1 995315
	Jgo. múltiple admisión (4)	NB	1 995117
	Junta subida aceite	NB	1 995328
	Base termostato y tapa trasera tapa cilindros	NB	2 995331
	Tapa radiador aceite	SLS	1 995337
	Junta	NB	1 995340
	Retorno turbo	NB	1 995364
	Arandela cónica A 7 x 13.8 x 3.8	CU	4
	Arandela A 14.5 x 21 x 1 C	CU	1
	Arandela A 14.3 x 21 x 1 A	AL	4
	Arandela A 10.4 x 15.7 x 1 C	CU	14
	Anillo G 22 x 27 x 3.5	S	2
	Anillo G 25 x 30 x 3.5	S	2
	Anillo G 22.5 x 30 x 5.6	S	1
	O'ring G 17 x 3	S	1
	O'ring G 11 x 2.25	GS	1
	O'ring G 21.82 x 3.53	S	2
	O'ring G 98 x 3	GS	1
	O'ring G 135 x 3	GS	1
	Kit de retenes completo		R995100
	Jgo. retén válvulas (8)	P	1 R995110P
	Retén bancada 100 x 124/158 x 14.5	S	1 R995111S
	Retén distribución 55 x 78 x 12	S	1 R920612S

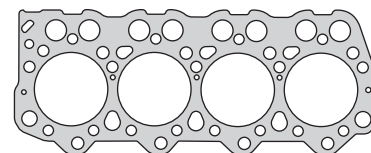

995308

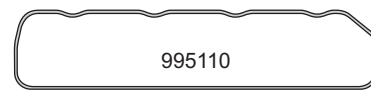

995110

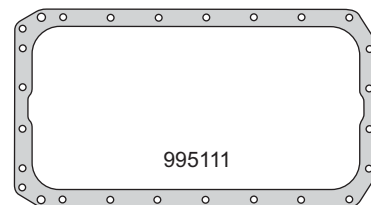

995111

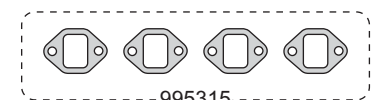

995315

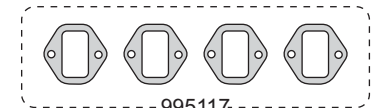

995117

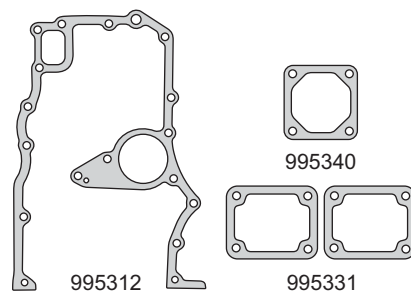

995312

995340

995331

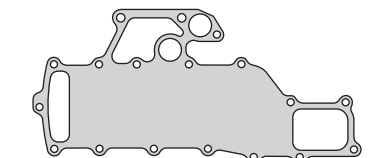

995337

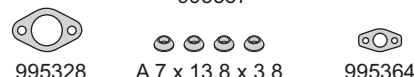

995328

A 7 x 13.8 x 3.8

995364

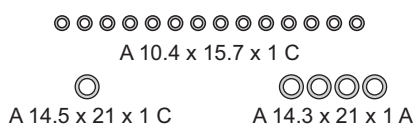

A 10.4 x 15.7 x 1 C

A 14.5 x 21 x 1 C

A 14.3 x 21 x 1 A

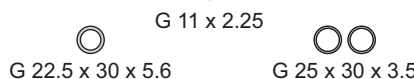

G 22.5 x 30 x 5.6

G 11 x 2.25

G 25 x 30 x 3.5

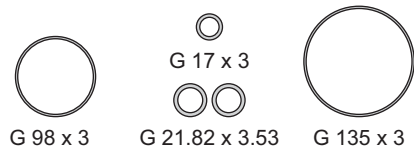

G 98 x 3

G 17 x 3

G 21.82 x 3.53

G 135 x 3



R995111S

R920612S

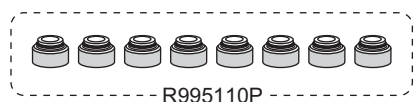

R995110P



taranto



HANC12130K

Kit Atornilladora Neumática - Encastre de 1/2"

- ▶ Atornilladora Trabajo Pesado en Aluminio Pulido, encastre 1/2" (12mm).
- ▶ Doble martillo.
- ▶ Torque Máximo 950ft/lbs (1288Nm).
- ▶ Material Composite Alta Resistencia, Ultra Liviano.
- ▶ Tubos Cromo-Molibdeno Alto Impacto Standart. (Medidas 17,19 y 21mm).
- ▶ Tubos Cromo-Molibdeno Alto Impacto largos, pared fina. (Medidas 17,19 y 21mm).



JOHN DEERE



Motor/Engine	Cm³	HP	Ø
3164D	2696		102

John Deere: 1030, 1035, 1520, 1530
204, JD302 1973/...



DIESEL

Nº OE	Descripción/Description	Mat.	Ref.
	Jgo. de juntas para motor	●	850000-R
	Jgo. de juntas para motor	●	850001-R
	Junta tapa cilindros Ø 119.0 ± 1.40	NFT	1 850007
T 20111	Junta tapa válvulas superior	CG	1 850010
T 24534	Junta para cárter	NB	1 850011
T 20155	Tapa distribución	NB	1 850012
T 24965	Placa distribución	NB	1 850013
T 20271	Tapa bomba de agua	NB	1 850014
T 20006	Múltiple escape	FCH	3 850015
T 20243	Placa bomba de agua	NB	1 850019
T 20336	Boca llenado aceite	NB	1 850027
R 27285	Bomba alimentación	NB	1 850028
T 23596	Caja volante	NB	1 850030
T 20159	Entrada aire	NB	2 850033
T 24460	Bomba inyectora a placa block cilindro	NB	1 850034
	Arandela base silenciador	NFT	1 850035
T 20364	Tapa engranaje bomba inyectora	NB	1 850037
T 20328	Tapa boca llenado aceite	CG	1 850038
	Tapa	NB	1 850040
T 20215	Tapa termostato	NB	1 850041
T 20219	Caja termostato	NB	1 850042
A 152739	Jgo. suplemento camisa cilindros	GS	3 850070
	O´ring suplemento camisa G105.46 x 3.53 (3)	GS	
	O´ring suplemento camisa G110 x 3.53 (Rojo) (3)	S	
	O´ring suplemento camisa G110 x 3.53 (Verde) (3)	S	
	Retén bancada 120.65 x 146.07 x 12.7	P	1 R850011P
	Retén distribución 57.15 x 76.2 x 9.5	P	1 R850012P

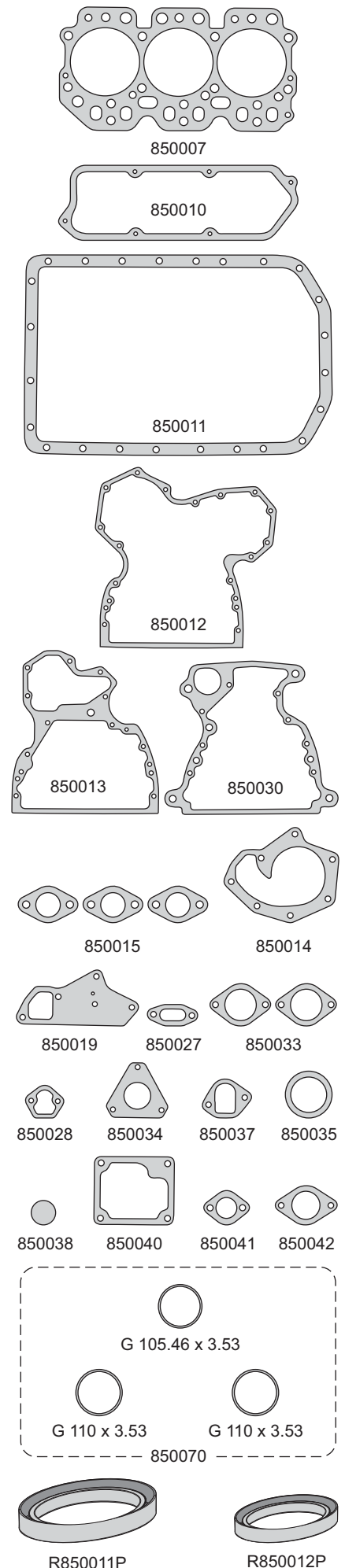

JOHN DEERE



Motor/Engine	Cm³	HP	Ø
4219 D	3590	81	102
4239 D/T	3918	81	102

John Deere: Tractor - Equipos Viales 2120, 2030 2035, 2270, 2280, 2340, JD310 401, 440, 450, 480 1974/... 2130, 2135, 1640, 1840, 2040, 2140 JD4400, 540B, 550, 555 1980/...



DIESEL

Nº OE	Descripción/Description	Mat.	Ref.
	Jgo. de juntas para motor		850100-R
	Jgo. de juntas para motor		850101-R
T 20075	Junta tapa cilindros Ø 119.0 ± 1.40	NFT	1 850107
T 32266	Junta tapa válvulas superior	CG	1 850110
	Junta para cárter	NB	1 850111
T 20155	Tapa distribución	NB	1 850012
T 24965	Placa distribución	NB	1 850013
T 20271	Tapa bomba de agua	NB	1 850014
T 20006	Múltiple escape	FCH	4 850015
T 20243	Placa bomba de agua	NB	1 850019
T 20336	Boca llenado aceite	NB	1 850027
R 27285	Bomba alimentación	NB	1 850028
T 23596	Caja volante	NB	1 850030
T 20159	Entrada aire	NB	2 850033
T 24460	Bomba inyectora a placa block cilindro	NB	1 850034
	Arandela base silenciador	NFT	1 850035
T 20364	Tapa engranaje bomba inyectora	NB	1 850037
T 20328	Tapa boca llenado aceite	CG	1 850038
	Tapa	NB	1 850040
T 20215	Tapa termostato	NB	1 850041
T 20219	Caja termostato	NB	1 850042
	Jgo. juntas caja de velocidades	VS	850150
A 152739	Jgo. suplemento camisa cilindros	GS	4 850070
	O ring suplemento camisa G105.46 x 3.53 (4)	N	
	O ring suplemento camisa G110 x 3.53 (Rojo) (4)	S	
	O ring suplemento camisa G110 x 3.53 (Verde) (4)	S	
	Retén bancada 120.65 x 146.07 x 12.7	P	1 R850011P
	Retén distribución 57.15 x 76.2 x 9.5	P	1 R850012P

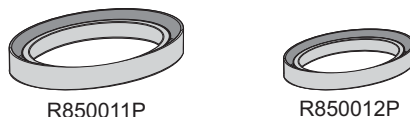
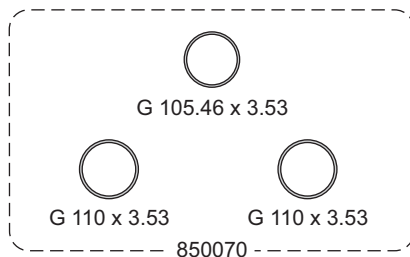
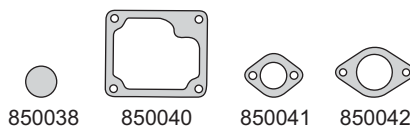
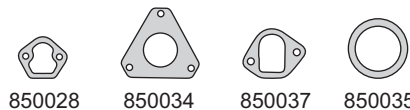
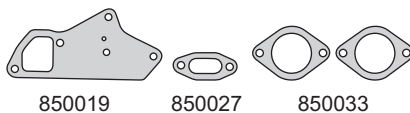
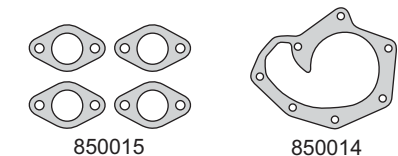
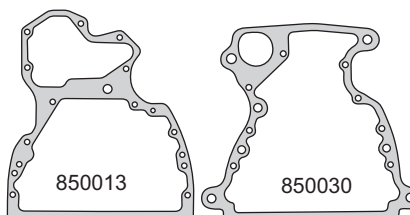
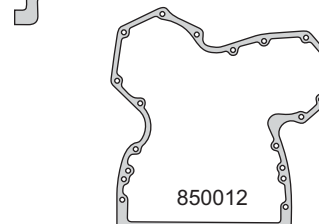
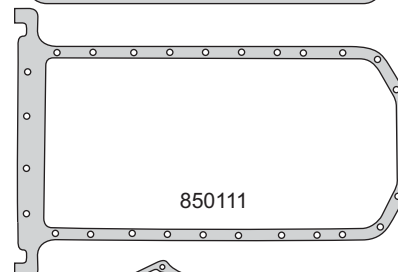
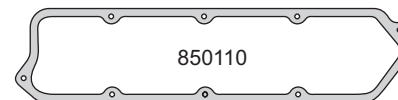
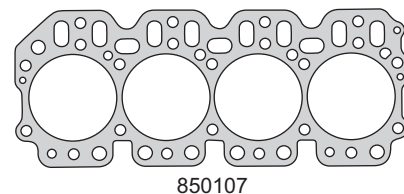

JOHN DEERE



Motor/Engine	Cm³	HP	Ø
6.329D	5395	87	102
6.359D	5877	87	106.5

John Deere: Tractor Motoniveladora
 6329D - 3120/3130/3135/2840/630
 730/JD303/444/540/570/482
 6359D - 3140/3040/3640/4040/960
 975/2940/3050/3350/3650



DIESEL

Nº OE	Descripción/Description	Mat.	Ref.
AJ 53537	Jgo. de juntas para motor	●	850200-R
	Jgo. de juntas para motor		850201-R
R 59449	Junta tapa cilindros Ø 119 \pm 1.40	NFT	1 850207
T 20467	Junta tapa válvulas superior	CG	1 850210
T 32267	Junta para cárter	NB	1 850211
T 20155	Tapa distribución	NB	1 850012
T 24965	Placa distribución	NB	1 850013
T 25485	Tapa bomba de agua	NB	1 850214
T 20006	Múltiple escape	FCH	6 850015
T 20243	Placa bomba de agua	NB	1 850019
T 20336	Boca llenado aceite	NB	1 850027
R 27285	Bomba alimentación	NB	1 850028
T 23596	Caja volante	NB	1 850030
T 20159	Entrada aire	NB	2 850033
T 24460	Bomba inyectora a plano block cilindro	NB	1 850034
R 31142	Arandela base silenciador	NFT	1 850235
T 20364	Engranaje bomba inyectora	NB	1 850037
T 20328	Tapa boca llenado aceite	CG	1 850038
T 23002	Múltiple salida agua	CG	3 850239
T 24932	Tapa termostato	NB	1 850241
R 54641	Caja termostato	CB	1 850242
R 54638	Tapa caja termostato	CB	1 850243
A 152739	Jgo. suplemento camisa cilindros (6)	GS	1 850071
	Retén bancada 120.65 x 146.07 x 12.7	P	1 R850011P
	Retén distribución 57.15 x 76.2 x 9.5	P	1 R850012P

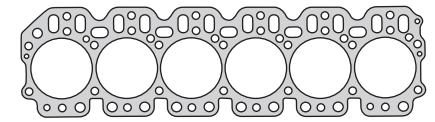

850207



850210

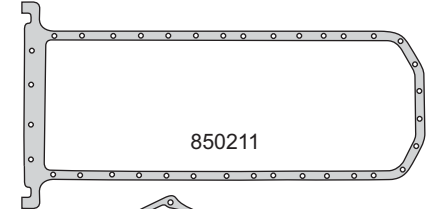

850211

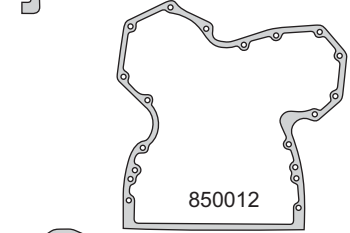

850012

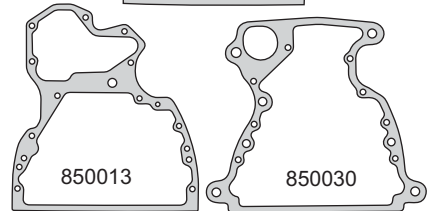

850013

850030

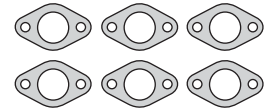

850015

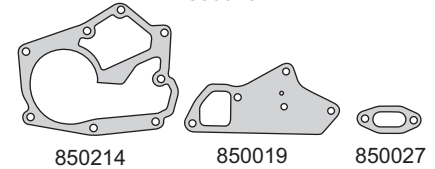

850214

850019

850027



850028

850033

850034

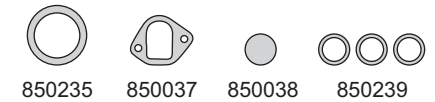

850235

850037

850038

850239



850241

850242

850243

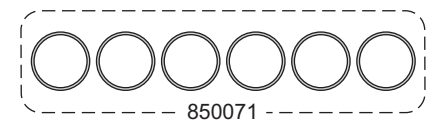

850071



R850011P



R850012P

JOHN DEERE



Motor/Engine	Cm³	HP	Ø
303	4976	85	98.04
329	5393	87	102

John Deere: 3420, J10, 4420, 570
Tractor Motoniveladora 1972/...



DIESEL

Nº OE	Descripción/Description	Mat.	Ref.
	Jgo. de juntas para motor		850300-R
	Junta tapa cilindros Ø 115.0 ± 1.40	NFT	1 850307
T 20467	Junta tapa válvulas superior	CG	1 850210
T 32267	Junta para cárter	NB	1 850211
T 20155	Tapa distribución	NB	1 850012
T 24965	Placa distribución	NB	1 850013
T 25485	Tapa bomba de agua	NB	1 850214
T 20006	Múltiple escape	FCH	6 850015
T 20243	Placa bomba de agua	NB	1 850019
T 20336	Boca llenado aceite	NB	1 850027
R 27285	Bomba alimentación	NB	1 850028
T 23596	Caja volante	NB	1 850030
T 20159	Entrada aire	NB	2 850033
T 24460	Bomba inyectora a placa block cilindro	NB	1 850034
R 31142	Arandela base silenciador	NFT	1 850235
T 20364	Engranaje bomba inyectora	NB	1 850037
T 20328	Tapa boca llenado aceite	CG	1 850038
T 23002	Múltiple salida agua	CG	3 850239
T 24932	Tapa termostato	NB	1 850241
	Jgo. suplemento camisa cilindros	GS	6 850070
	O ring suplemento camisa G105.46 x 3.53 (6)	N	
	O ring suplemento camisa G110 x 3.53 (Rojo) (6)	S	
	O ring suplemento camisa G110 x 3.53 (Verde) (6)	S	
	Retén bancada 120.65 x 146.07 x 12.7	P	1 R850011P
	Retén distribución 57.15 x 76.2 x 9.5	P	1 R850012P

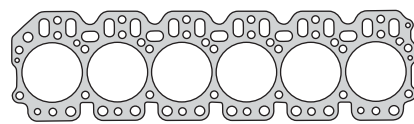

850307

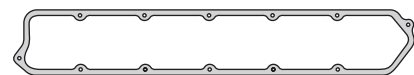

850210

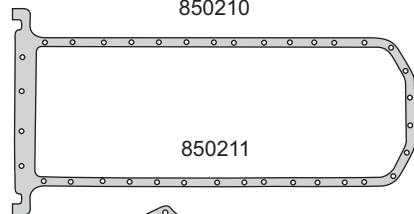

850211

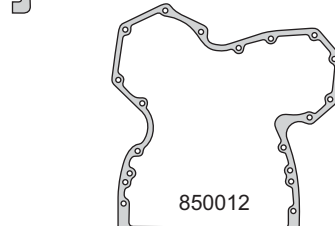

850012

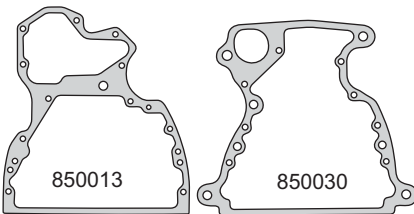

850013

850030

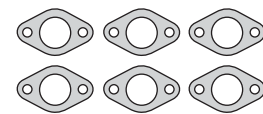

850015

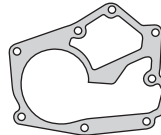

850214

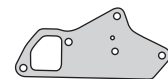

850019

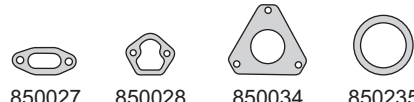

850027

850028

850034

850235



850037

850033

850241



850239

850038

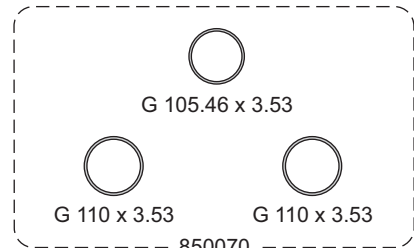

G 105.46 x 3.53

G 110 x 3.53

G 110 x 3.53

850070



R850011P



R850012P

JOHN DEERE



Motor/Engine	Cm³	HP	Ø
6.359D	5879	110/125	106.5
DIESEL			

John Deere: 3350, 3550, 6500, 6600, 7500
Cosechadora 1075 1991/...



Nº OE	Descripción/Description	Mat.	Ref.
	Jgo. de juntas para motor	●	850400
	Jgo. de juntas para motor		850401
R114157	Junta tapa cilindros Ø 119.0 ± 1.40	NFT	1 850207
R75728	Junta tapa válvulas superior	CG	1 850210
R97344	Junta para cárter	NB	1 850411
R126513	Tapa distribución	NB	1 850012
R131794	Placa distribución	NH	1 850413
T20243	Tapa bomba de agua	NB	1 850214
R119395	Jgo. múltiple escape (6)	AC	1 850415
	Jgo. múltiple escape (6)	NFT	1 850416
	Placa bomba de agua	NB	1 850019
R87259	Boca llenado aceite	NB	1 850027
R97350	Bomba alimentación	NB	1 850028
R97351	Caja volante	NB	1 850030
R81275	Entrada aire	NB	1 850033
R97354	Bomba inyectora a placa distribución	NB	1 850034
	Arandela base silenciador	NFT	1 850235
R125026	Tapa engranaje bomba inyectora	NB	1 850037
	Tapa bomba llenado aceite	CG	1 850038
	Múltiple salida agua	CG	3 850239
R54638	Tapa termostato	NB	1 850241
R54641	Caja termostato	CB	1 850242
	Tapa caja termostato	CB	1 850243
	Jgo. caja de velocidades transmisión	VS	850450
R87879	Salida escape turbo	AC	850463
AR65507	Jgo. suplemento camisa cilindros (6)	GS	1 850071
	Jgo. suplemento camisa cilindros (6)	GS	850470
	O´ring G 110 x 3.53	GS	6
	O´ring G 117.07 x 3.53	GS	6
	O´ring G 15.6 x 1.78	GS	1
	O´ring G 24.99 x 3.53	GS	1
	O´ring G 28.17 x 3.53	GS	2
	Anillo G 69 x 77 x 5	GS	1
RE44574	Retén bancada 120.65 x 146.07 x 12.7	P	R850011P
AR67942	Retén distribución 57.15 x 76.2 x 9.5	P	R850012P

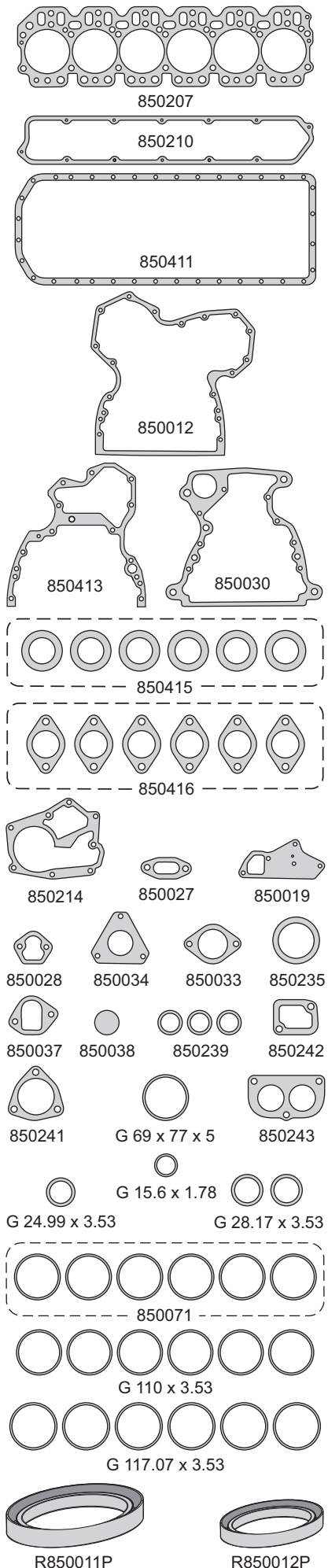

JOHN DEERE



Motor/Engine	Cm³	HP	Ø
	6156		155.6
DIESEL			

John Deere: 730, Tractor 375 1960/74



Nº OE	Descripción/Description	Mat.	Ref.
	Jgo. de juntas para motor		850500-R
R 21449 R	Junta tapa cilindros Ø 159.5 x 1.60	NFT	1 850507
	Junta tapa balancines	CG	1 850510
F 1898 R/J	Junta cuerpo bomba de agua	NB	1 850514
J 10081 J	Jgo. múltiple escape (3)	NFT	1 850515
	Termostato	CB	1 850519
	Entrada agua a tapa cilindros	CB	1 850529
F 519 R/J	Soporte motor arranque	CB	1 850530
R 20169 R/J	Base cilindros a caja	NFT	1 850531
F 2251 R	Salida agua cabeza cilindros	CB	2 850532
F 1779 R/J	Tapa caja cigüeñal lado derecho	CG	1 850533
F 1803 R/J	Salida agua block	CB	1 850534
F 1777 R/J	Soporte bomba inyectora a cilindros	NB	2 850535
F 2438 R/J	Tapa bombas inyectora	CG	1 850536
R 61 R/J	Tapa cojinete extremo eje transmisión	CG	1 850537
A 3817 R/J	Freno derecho	CB	1 850538
F 157 R/J	Caja retén de aceite volante	CB	1 850539
R 20232 R	Purificador aire	CG	1 850540
R 20037 R/J	Caja palanca reguladora	CB	1 850541
F 2043 R/J	Caja regulador	CB	1 850542
F 2041 R/J	Caja cojinete	CB	1 850543
F 1922 R/J	Cubierta 1ra. reguladora engranaje	CB	1 850544
F 2504 R/J	Cubierta reguladora engranaje	CB	1 850545
F 2589 R/J	Retén aceite polea	CB	1 850546
F 1396 R/J	Arandela espárrag. cabeza cilindros A 20 x 28 x 1 C	CU	10 850547
264 R/J	Arandela bulón sujeta tapa bomba A 11 x 18 x 1.5 A	AL	2 850548
A 3439 R/J	Arandela bulón sujeta tapa balancines A 11 x 18 x 1.5 C	CU	3 850549
A 3439 R/J	Arandela tobera inyector A 8 x 18 x 1.5 A	AL	2 850562
R 463	Empaquetadura caño agua inferior G 62.87 x 5.33	GS	2 850563
F 1056 R	Empaquetadura tubo entrada aceite bba G 9.19 x 2.62	GS	2 850564
A 4365 R	Empaquetadura caño agua superior G 46.99 x 5.33	GS	2 850565
RE44574	Retén bancada 101.60 x 127 x 7.94	P	1 R850511P
AR67942	Retén distribución 57.15 x 76.2 x 9.5	P	1 R850512P

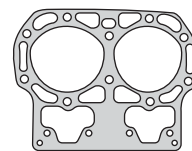

850507



850510

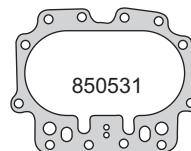

850531



850536

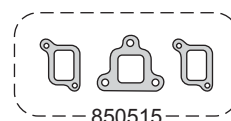

850515

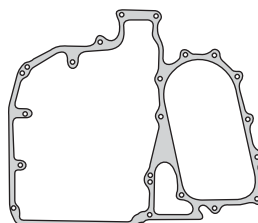

850545

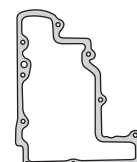

850542



850514



850519



850529



850530



850532



850533



850534

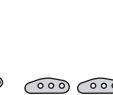

850535



850537



850538



850539



850540

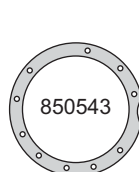

850543



850541

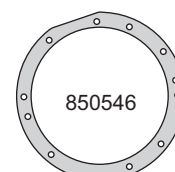

850546

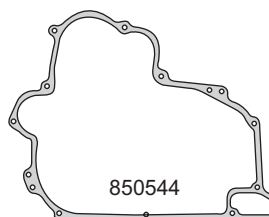

850544



850547



850548



850549



850562



850563



850564



850565



R850511P



R850512P

JOHN DEERE



Motor/Engine	Cm³	HP	Ø
6068TJ31/32/61 6068HJ63	5395	150/178	106

John Deere: 6505, 6605, 6615, 7500
Power Tech - MUM
Power Tech - Gen Set



DIESEL

Nº OE	Descripción/Description	Mat.	Ref.
	Jgo. de juntas para motor	●	850601-R
	Jgo. de juntas para motor		850601
	Juntas tapa cilindros Ø 120.0 \pm 1.40	NFT	850607
	Junta tapa válvulas	P	1 850610
	Junta para cárter	NB	1 850611
	Junta distribución	NH	1 850612
	Junta distribución	NH	1 850612-1
	Junta distribución	NH	1 850612-2
	Junta distribución	NH	1 850612-3
	Junta placa distribución	NH	1 850613
	Jgo. múltiple escape (6)	AC	1 850615
	Junta	GFT	1 850630
	Junta	CB	1 850637
	Junta	CB	1 850638
	Junta	NB	1 850639
	Junta	CB	1 850640
	Junta	CB	1 850641
	Junta	NB	2 850642
	Junta tapa termostato	CB	1 850243
	Junta	CB	1 850643
	Junta	NB	1 850647
	Junta	NB	1 850648
	Junta	AC	1 850662
	Arandela A 26 x 32 x 1.25 A	AL	1
	O'ring G 18.64 x 3.53	GS	4
	O'ring G 7.59 x 2.62	GS	6
	O'ring G 15.47 x 3.53	GS	2
	O'ring G 37.77 x 2.62	GS	2
	O'ring G 29.87 x 1.78	GS	2
	O'ring G 31.47 x 1.78	GS	1
	O'ring G 18.77 x 1.78	GS	1
	O'ring G 24.99 x 3.53	GS	1
	O'ring G 50.39 x 3.53	GS	1
	O'ring G 91.67 x 3.53	GS	1
	O'ring G 69.52 x 2.62	GS	1
	Kit de retenes completo		R850600
	Jgo. retén válvulas (12)	V	1 R850610V
	Retén bancada 120.65 x 146.07 x 12.7	P	1 R850011P
	Retén distribución 57.15 x 76.2 x 9.5	P	1 R850012P

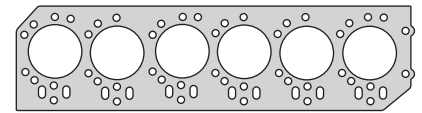

850607

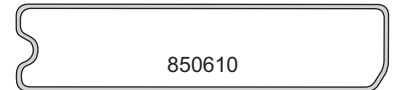

850610



850611

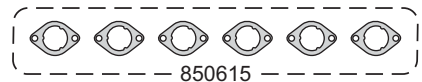

850615

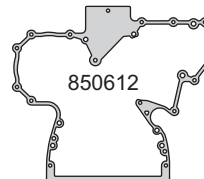

850612

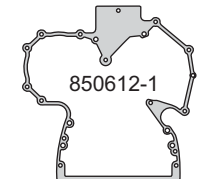

850612-1

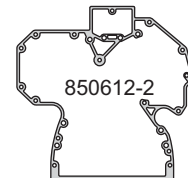

850612-2

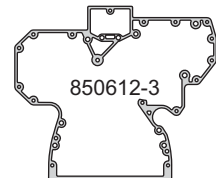

850612-3

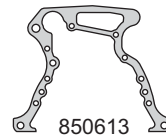

850613

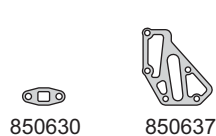

850630



850637

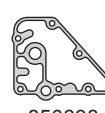

850638



850639

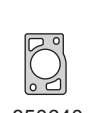

850640



850641



850642

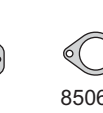

850643

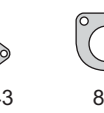

850243

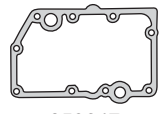

850647



850648

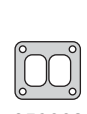

850662

A 26 x 32 x 1.25 A



G 7.59 x 2.62



G 18.64 x 3.53



G 37.77 x 2.62

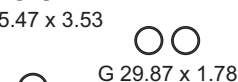

G 29.87 x 1.78

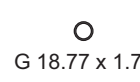

G 18.77 x 1.78

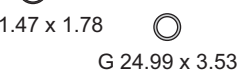

G 24.99 x 3.53



R850011P



R850012P



R850610V

JOHN DEERE



Motor/Engine	Cm³	HP	Ø
4540TJ31	4500	107	106
4045DJ31	4500	74	106

John Deere: Motores Agrícolas e Industriales



DIESEL

Nº OE	Descripción/Description	Mat.	Ref.
	Jgo. de juntas para motor	●	850701-R
	Jgo. de juntas para motor		850701
	Junta tapa cilindros Ø 120.0 ± 1.40	NFT	850707
	Junta tapa válvulas	GS 1	850710
	Junta para cárter	NB 1	850711
	Junta distribución	NH 1	850612
	Junta distribución	NH 1	850612-1
	Junta distribución	NH 1	850612-2
	Junta distribución	NH 1	850612-3
	Placa distribución	NH 1	850613
	Jgo. múltiple escape (4)	AC 1	850715
	Junta	GFT 1	850630
	Junta	CB 1	850637
	Junta	CB 1	850638
	Junta	NB 2	850639
	Junta	CB 1	850640
	Junta	CB	850641
	Junta	NB 1	850642
	Junta	CB 1	850643
	Junta radiador aceite	NB 1	850647
	Junta radiador aceite	NB 1	850648
	Junta turbo	AC 1	850762
	Arandela A 26 x 32 x 1.25 A	AL 1	
	O'ring G 18.64 x 3.53	GS 4	
	O'ring G 7.59 x 2.62	GS 4	
	O'ring G 15.47 x 3.53	GS 2	
	O'ring G 34.52 x 3.53	GS 2	
	O'ring G 29.82 x 2.62	GS 2	
	O'ring G 31.42 x 2.62	GS 1	
	O'ring G 18.72 x 2.62	GS 1	
	O'ring G 24.99 x 3.53	GS 1	
	O'ring G 50.39 x 3.53	GS 1	
	O'ring G 91.67 x 3.53	GS 1	
	O'ring G 69.52 x 2.62	GS 1	
	Kit de retenes completo		R850700
	Jgo. retén válvulas (8)	V 1	R850710V
	Retén bancada 120.65 x 146.07 x 12.7	P 1	R850011P
	Retén distribución 57.15 x 76.2 x 9.5	P 1	R850012P

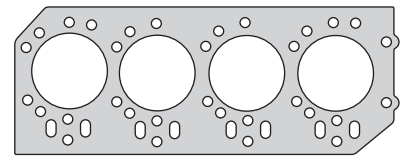

850707

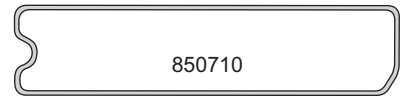

850710

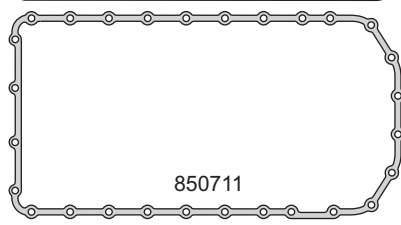

850711

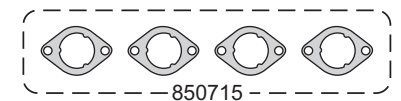

850715

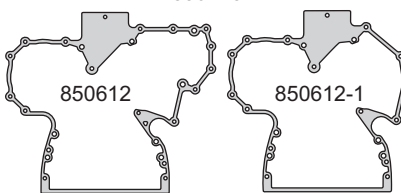

850612

850612-1

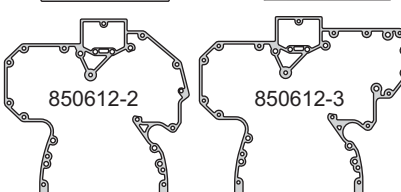

850612-2

850612-3

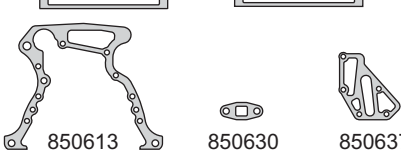

850613

850630

850637

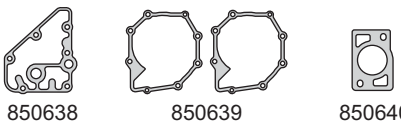

850638

850639

850640

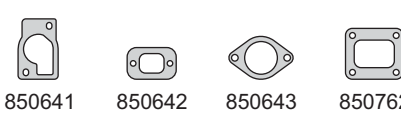

850641

850642

850643

850762



850647

850648

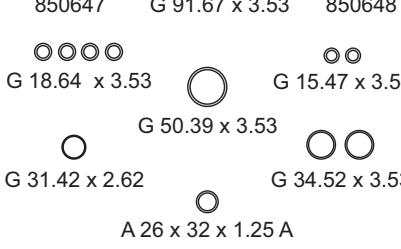

G 18.64 x 3.53

G 15.47 x 3.53

G 50.39 x 3.53

G 31.42 x 2.62

G 34.52 x 3.53

A 26 x 32 x 1.25 A

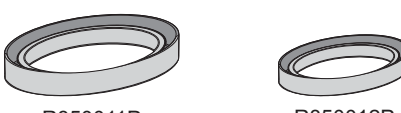

R850011P

R850012P

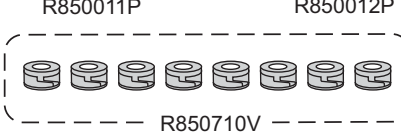

R850710V

KOMATSU

Motor / Engine

Cm³

HP

Ø

Komatsu: Tractor, Autoelevador

4D94

2940

39

104

DIESEL



Nº OE	Descripción / Description	Mat.	Ref.
	Jgo. de juntas para motor		760000-R
	Junta tapa cilindros Ø 105.0 ± 1.70	NFT 1	760007
	Junta tapa válvulas	GS 1	760010
	Jgo. para cárter (4)	NB 1	760011
	Tapa distribución	NB 1	760012
	Tapa distribución	NB 1	760012-1
	Tapa distribución	NB 1	760012-2
	Placa distribución	NB 1	760013
	Placa distribución	NB 1	760013-1
	Placa distribución	NB 1	760013-2
	Bomba de agua	NB 1	760014
	Múltiple de escape	FCH 1	760015
	Múltiple de admisión	NB 1	760017
	Colector escape	AC 2	760018
	Junta termostato	NB 1	760019
	Junta	NB 1	760026
	Junta filtro aceite	NB 1	760027
	Salida catalizador a silenciador	CU 1	760028
	Junta filtro aceite	NB 2	760029
	Soporte metálico	H 3	760030
	Soporte acople filtro combustible	H 3	760031
	Brida aceite	NB 1	760032
	Cierre lado volante	NB 1	760033
	Brida conector	NB 1	760034
	Junta enfriador de aceite	NB 1	760036
	Junta entrada refrigeracion	NB 1	760037
	Guarnición goma G 47.5 x 54 x 4.5	GS 1	760038
	Soporte filtro aceite	NB 1	760039
	Junta	NB 1	760041
	Junta	NB 1	760042
	Junta	NB 1	760043
	Junta	NB 1	760044
	Soporte bomba inyectora	NB 1	760045
	Comando bomba combustible	NB 1	760046
	Guarnición tapón goma	GS 1	760047
	Junta filtro aire	NB 1	760048
	Chaveta de cobre	CU 2	760049
	Junta	NB 1	760050
	Junta diferencial	NB 1	760059
	O´ring suplemento camisa cilindros G 104.37 x 3.53	S 4	
	O´ring suplemento camisa cilindros G 104.37 x 3.53	GS 4	
	Arandela tapón cárter A 9 x 18 x 1.5	F 2	
	Arandela A 10 x 22 x 1 C	CU 4	
	Arandela especial A 12.5 x 30 x 1.20 H	H 1	
	Arandela especial A 5.5 x 11 x 2 A	AC/GS 1	
	Arandela especial A 7.8 x 13.6 x 2 A	AC/GS 10	
	Arandela especial A 10 x 15.7 x 2 A	AC/GS 5	
	Arandela especial A 13.6 x 20 x 2 A	AC/GS 8	
	Arandela especial A 16 x 22.7 x 2 A	AC/GS 8	
	Arandela A 22 x 28 x 1.50 C	CU 2	
	Anillo G 19 x 24 x 12	GS 1	
	O´ring G 15.54 x 2.62	GS 2	
	O´ring G 21.82 x 3.53	GS 2	

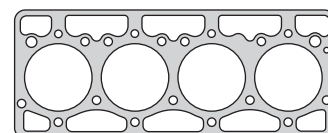

760007

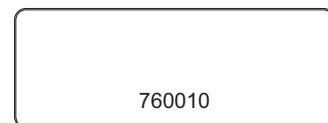

760010

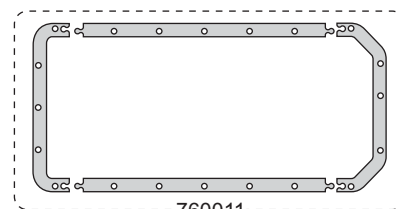

760011



760015

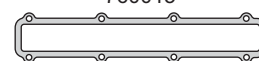

760017

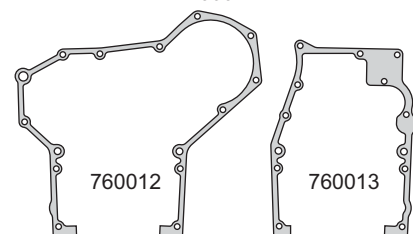

760012

760013

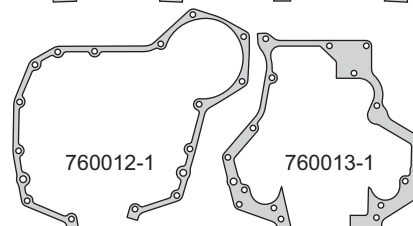

760012-1

760013-1

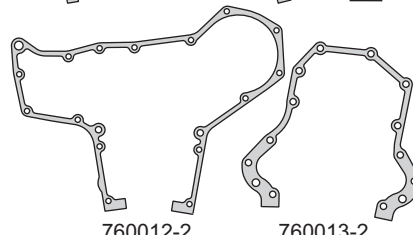

760012-2

760013-2

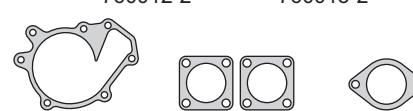

760014

760018

760019

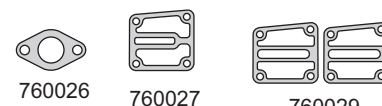

760026

760027

760029

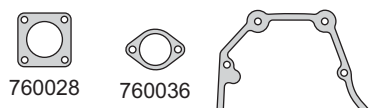

760028

760036

760033

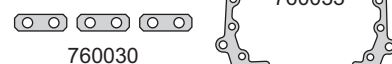

760030



760031

760032

760034

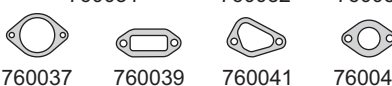

760037

760039

760041

760042

KOMATSU



Motor / Engine **4D94** **2940** Cm³ **39** HP **104** Ø

Komatsu: Tractor, Autoelevador

DIESEL



Nº OE	Descripción / Description	Mat.	Ref.
	O'ring G 44.04 x 3.53	GS	2
	O'ring G 47.22 x 3.53	GS	1
	O'ring G 63.09 x 3.53	GS	1
	O'ring G 69.44 x 3.53	GS	1
	O'ring G 75.87 x 2.62	GS	1
	O' ring G 80 x 3.15	GS	1
	O' ring G 89 x 3.15	GS	1
	O' ring G 98.02 x 3.53	GS	1
	O' ring G 107.62 x 2.62	GS	1
	O' ring G 135.89 x 3.53	GS	1
	Kit de retenes completo		R760000
	Jgo. retén válvulas (8)	P	1 R760010P
	Retén bancada 90 x 120 x 17	S	1 R760311S
	Retén bancada 90 x 120 x 13	S	1 R760011S
	Retén distribución 55 x 72 x 9	S	1 R760012S
	Retén árbol de levas 17 x 30 x 7	P	1 R760013P

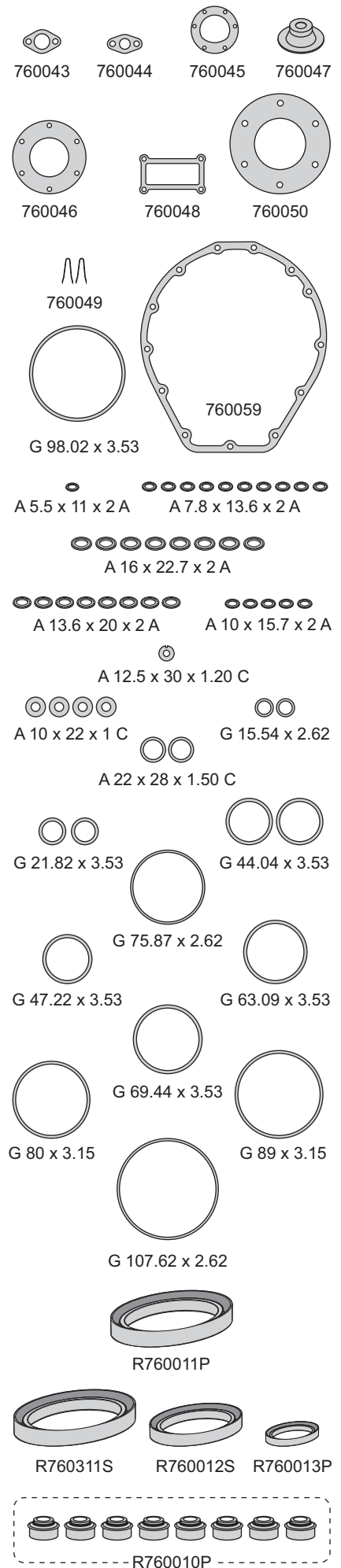

KOMATSU



Motor / Engine **Cm³** **HP** **Ø**
4D94-E **2800** **40** **93**

Komatsu: Tractor, Autoelevador

DIESEL

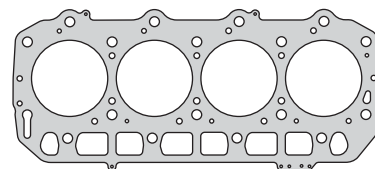

760108

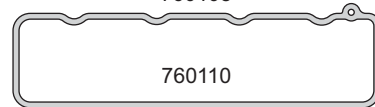

760110



760115

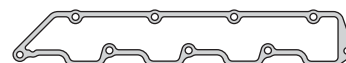

760117

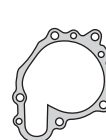

760114

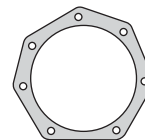

760113



760118



760119



760129



760132



760134



760137



760138

G 9.19 x 2.62

A 8.5 x 14 x 1 C

A 12 x 19.5 x 1 C

A 14 x 18 x 1 C

A 10.5 x 14 x 1 C

A 16.5 x 24 x 2 C

A 12.5 x 18 x 1 C

G 11 x 2.20

G 13.94 x 2.62

G 34.52 x 3.53

G 50.47 x 2.62

G 31.5 x 4

G 20.3 x 2.62



R760111S



R760113S

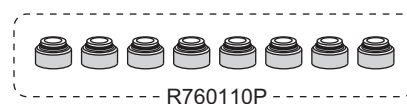

R760110P

Nº OE	Descripción / Description	Mat.	Ref.
	Jgo. de juntas para motor		760100-R MLS
	Junta tapa cilindros Ø 95.0 ± 1.60	NFT	760107
	Junta tapa cilindros Ø 94.0 ± 0.40	MLS	1 760108
	Sellador líquido - caucho de silicona		TRN0085G
	Junta tapa válvulas	GS	1 760110
	Frente distribución	NB	1 760113
	Bomba de agua	NB	1 760114
	Múltiple de escape	AC	1 760115
	Múltiple de admisión	SLS	1 760117
	Salida de escape	GFT	1 760118
	Base termostato	NB	1 760119
	Cubre volante	NB	1 760129
	Entrada admisión	NB	1 760132
	Cuerpo termostato	NB	1 760134
	Casquillo metálico fijación A 12.8 x 17.6 x 7.3 A	AC	4 760137
	Junta	NB	1 760138
	Arandela A 8.5 x 14 x 1 C	CU	4
	Arandela A 10.5 x 14 x 1 C	CU	1
	Arandela A 12 x 19.5 x 1 C	CU	4
	Arandela A 12.5 x 18 x 1 C	CU	3
	Arandela A 14 x 18 x 1 C	CU	8
	Arandela A 16.5 x 24 x 2 C	CU	1
	O'ring G 9.19 x 2.62	GS	1
	O'ring G 11 x 2.20	GS	3
	O'ring G 13.94 x 2.62	GS	1
	O'ring G 20.3 x 2.62	GS	2
	O'ring G 31.5 x 4	GS	1
	O'ring G 34.52 x 3.53	GS	2
	O'ring G 50.47 x 2.62	GS	1
	Kit de retenes completo		R760100
	Jgo. retén válvulas (8)	P	1 R760110P
	Retén bancada 95 x 115 x 12	S	1 R760111S
	Retén distribución 62 x 77 x 9	S	1 R760113S

KOMATSU



Motor / Engine **4D94-E** Cm³ **2800** HP **40** Ø **94**

Komatsu: Tractor, Autoelevador

DIESEL



Nº OE	Descripción / Description	Mat.	Ref.
	Jgo. de juntas para motor	●	760200-R
	Junta tapa cilindros Ø 95.5 x 1.65	NFT 1	760207
	Sellador líquido - caucho de silicona	TRN	TRN0085G
	Junta tapa válvulas	GS 1	760110
	Frente distribución	NB 1	760113
	Bomba de agua	NB 1	760114
	Múltiple de escape	AC 1	760115
	Múltiple de admisión	SLS 1	760117
	Salida de escape	GFT 1	760118
	Base termostato	NB 1	760119
	Cubre volante	NB 1	760129
	Entrada admisión	NB 1	760132
	Cuerpo termostato	NB 1	760134
	Casquillo metálico fijación A 12.8 x 17.6 x 7.3 A	AC 4	760137
	Junta	NB 1	760138
	Arandela A 8.5 x 14 x 1 C	CU 4	
	Arandela A 10.5 x 14 x 1 C	CU 1	
	Arandela A 12 x 19.5 x 1 C	CU 4	
	Arandela A 12.5 x 18 x 1 C	CU 3	
	Arandela A 14 x 18 x 1 C	CU 8	
	Arandela A 16.5 x 24 x 2 C	CU 1	
	O'ring G 9.19 x 2.62	GS 1	
	O'ring G 11 x 2.20	GS 3	
	O'ring G 13.94 x 2.62	GS 1	
	O'ring G 20.3 x 2.62	GS 2	
	O'ring G 31.5 x 4	GS 1	
	O'ring G 34.52 x 3.53	GS 2	
	O'ring G 50.47 x 2.62	GS 1	
	Kit de retenes completo		R760100
	Jgo. retén válvulas (8)	P 1	R760110P
	Retén bancada 95 x 115 x 12	S 1	R760111S
	Retén distribución 62 x 77 x 9	S 1	R760113S

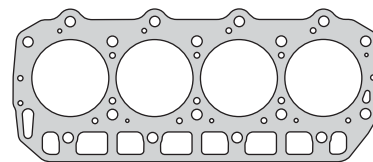

760207

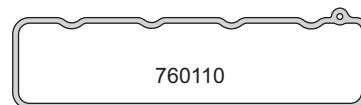

760110

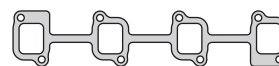

760115



760114



760115

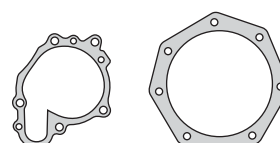

760117

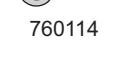

760118

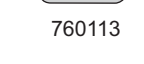

760119



760113



760129



760132



760134



760134



760137



760138



G 9.19 x 2.62



A 8.5 x 14 x 1 C



A 12 x 19.5 x 1 C



A 14 x 18 x 1 C



A 10.5 x 14 x 1 C



A 16.5 x 24 x 2 C



A 12.5 x 18 x 1 C



G 11 x 2.20



G 13.94 x 2.62



G 34.52 x 3.53



G 50.47 x 2.55



G 31.5 x 4



G 20.30 x 2.62



R760111S



R760113S



R760110P

KOMATSU



Motor / Engine **Cm³** **HP** **Ø**

4D94 **2940** **39** **104**

Komatsu: Tractor, Autoelevador

DIESEL



Nº OE	Descripción / Description	Mat.	Ref.
	Jgo. de juntas para motor		760300-R
	Junta tapa cilindros Ø 105.0 ± 1.70	NFT	1 760007
	Junta tapa válvulas	GS	1 760010
	Junta para cárter	CG	1 760311
	Tapa distribución	NB	1 760012
	Placa distribución	NB	1 760013
	Bomba de agua	NB	1 760314
	Múltiple de escape	FCH	1 760015
	Múltiple de admisión	NB	1 760017
	Junta	NB	1 760026
	Junta filtro de aceite	NB	2 760029
	Brida aceite	NB	1 760032
	Cierre lado volante	NB	1 760033
	Junta enfriador aceite	NB	1 760036
	Guarnición G 47.5 x 54 x 4.5	GS	1 760038
	Soporte filtro aceite	NB	1 760039
	Junta	NB	1 760041
	Junta	NB	1 760044
	Junta unión	NB	1 760345
	Junta comando bomba combustible	NB	1 760046
	Junta filtro aire	NB	1 760048
	Arandela A 7.8 x 13.6 x 2 A	ACGS	10
	Arandela A 10 x 15.7 x 2 A	ACGS	7
	Arandela A 13.6 x 20 x 2 A	ACGS	4
	Arandela A 8.5 x 17 x 0.8 F	F	2
	Arandela A 10 x 20 x 1 C	CU	4
	O'ring suplemento tapa de cilindros G 104.37 x 3.53	S	4
	O'ring suplemento tapa de cilindros G 104.37 x 3.53	GS	4
	O'ring G 13.94 x 2.62	GS	1
	O'ring G 21.82 x 3.53	GS	5
	O'ring G 50.39 x 3.53	GS	1
	O'ring G 64 x 3	GS	1
	O'ring G 97 x 3.25	GS	1
	O'ring G 107.62 x 2.62	GS	1
	O'ring G 134 x 3	GS	1
	Kit de retenes completo		R760300
	Jgo. retén válvulas (8)	P	1 R760010P
	Retén bancada 90 x 120 x 17	S	1 R760311S
	Retén distribución 55 x 72 x 9	S	1 R760012S

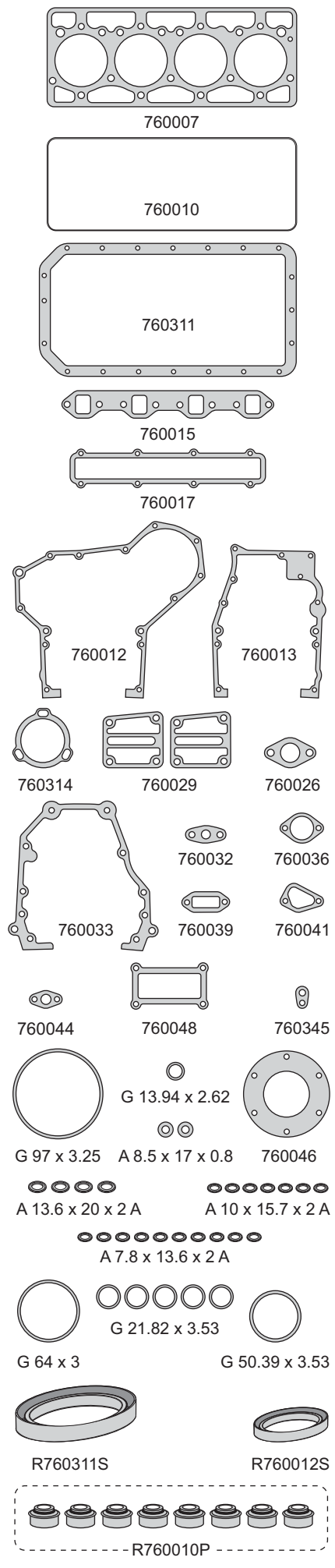

KOMATSU



Motor / Engine	Cm ³	HP	Ø
4D95L	3260	54/65	96
DIESEL			

Komatsu: Tractor, Autoelevador



Nº OE	Descripción / Description	Mat.	Ref.
	Jgo. de juntas para motor	●	760400-R
	Junta tapa cilindros Ø 97.0 ± 1.45	NFT	1 760407
	Junta tapa válvulas	GS	1 760410
	Jgo. junta para cárter (4)	NB	1 760411
	Tapa distribución	NB	1 760412
	Placa distribución	NB	1 760413
	Bomba de agua	NB	1 760414
	Múltiple de escape	AC	1 760415
	Salida de escape	AC	1 760418
	Junta codo de agua	NB	1 760430
	Guarnición goma G 11.65 x 29 x 5/7.70	GS	3 760434
	Entrada de aire a colector	NB	2 760436
	Junta refrigerador aceite	NB/GS	2 760437
	Guarnición G 47.5 x 54 x 4.5	GS	1 760038
	Placa bomba de agua	NB	1 760438
	Placa bomba de agua	NB	1 760439
	Junta tubo escape	NB	1 760440
	Arandela cónica A 7.8 x 13.8 x 3.8	CU	4
	Arandela A 8 x 13.6 x 2 A	AC/GS	1
	Arandela A 10 x 15.7 x 1.70 A	AC/GS	4
	Arandela A 13.6 x 20 x 2 A	AC/GS	8
	Arandela A 20.5 x 31 x 1 C	CU	1
	O'ring G 18 x 2	GS	1
	O'ring G 20.32 x 2.62	S	1
	O'ring G 40.87 x 3.53	GS	1
	O'ring G 50.39 x 3.53	GS	1
	O'ring G 64 x 3	GS	1
	O'ring G 94 x 3	GS	1
	O'ring G 134 x 3	GS	2
	Kit de retenes completo		R760400
	Jgo. retén válvulas (8)	P	1 R760410P
	Retén bancada 95 x 120 x 17	S	1 R760411S
	Retén distribución 62 x 85 x 12	S	1 R760412S

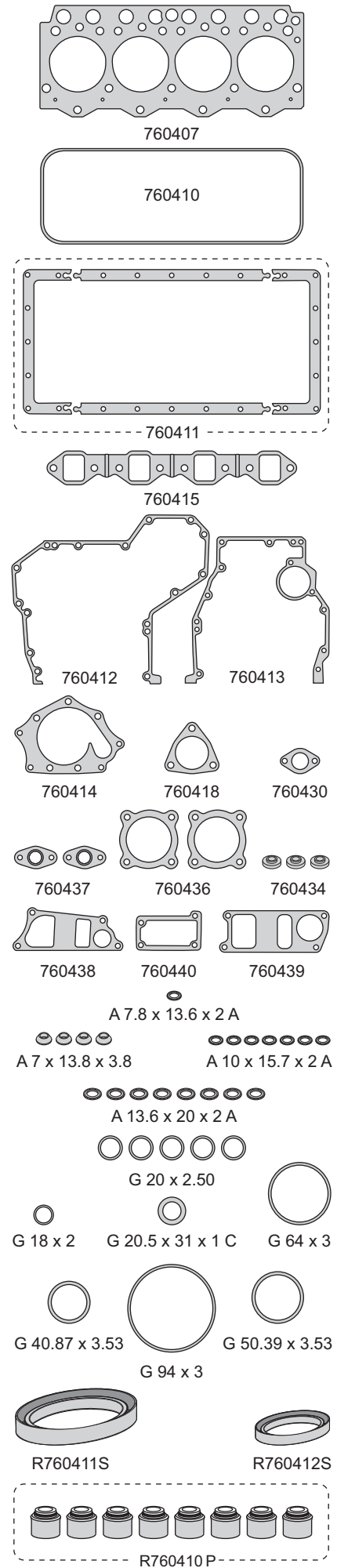

KOMATSU



Motor / Engine	Cm ³	HP	Ø
4D95	3260	54	96
DIESEL			

Komatsu: Tractor, Autoelevador



Nº OE	Descripción / Description	Mat.	Ref.
	Jgo. de juntas para motor		760500-R MLS
	Junta tapa cilindros Ø 97.0 ± 1.40	MLS	1 760508
	Junta tapa válvulas	GS	1 760410
	Jgo. junta para cárter (4)	NB	1 760411
	Tapa distribución	NB	1 760412
	Placa distribución	NB	1 760413
	Bomba de agua	NB	1 760414
	Múltiple de escape	AC	1 760415
	Salida de escape	AC	1 760518
	Salida de escape	AC	1 760518-1
	Junta codo de agua	NB	1 760430
	Guarnición goma G 11.65 x 29 x 5/7.70	GS	3 760434
	Entrada de aire a colector	NB	2 760436
	Junta refrigerador aceite	NB/GS	2 760437
	Guarnición G 47.5 x 54 x 4.5	GS	1 760038
	Placa bomba de agua	NB	1 760438
	Placa bomba de agua	NB	1 760439
	Junta tubo de escape	NB	1 760440
	Anillo G 14 x 19 x 2.80	GS	1
	Arandela cónica A 7 x 13.8 x 3.8	CU	4
	Arandela A 7.8 x 13.6 x 2 A	AC/GS	1
	Arandela A 10 x 15.7 x 2 A	AC/GS	4
	Arandela A 13.6 x 20 x 2 A	AC/GS	8
	Arandela A 20.5 x 31 x 1 C	CU	1
	O'ring G 18 x 2	GS	1
	O'ring G 20.32 x 2.62	S	1
	O'ring G 40.87 x 3.53	GS	1
	O'ring G 50.39 x 3.53	GS	1
	O'ring G 64 x 3	GS	1
	O'ring G 94 x 3	GS	1
	O'ring G 134 x 3	GS	2
	Kit de retenes completo		R760400
	Jgo. retén válvulas (8)	P	1 R760410P
	Retén bancada 95 x 120 x 17	S	1 R760411S
	Retén distribución 62 x 85 x 12	S	1 R760412S

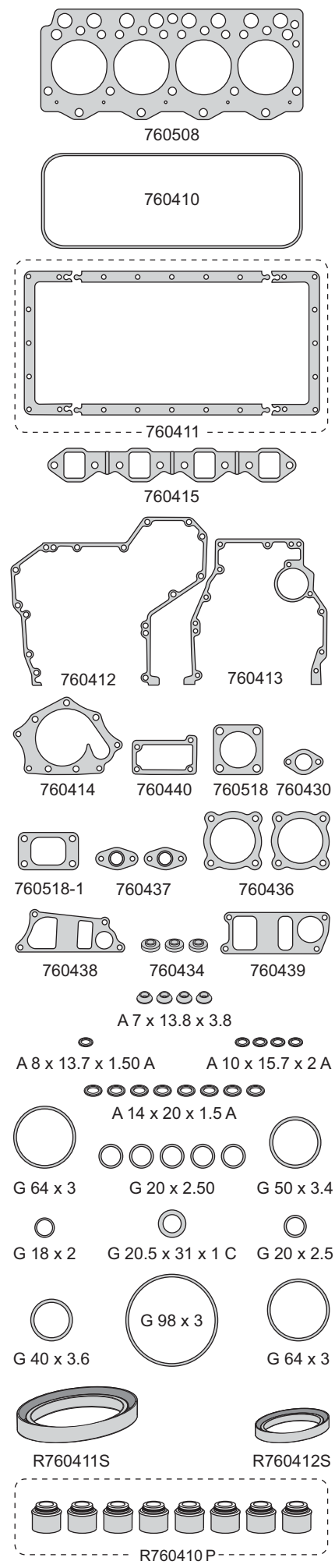

KOMATSU

Motor / Engine

Cm³

HP

Ø

Komatsu: Tractor, Autoelevador

4D105-5

4330

63/66

112

DIESEL



Nº OE	Descripción / Description	Mat.	Ref.
	Jgo. de juntas para motor	●	760600-R
	Junta tapa cilindros Ø 113.0 ± 1.70	NFT	1 760607
	Junta tapa válvulas	GS	1 760610
	Jgo. junta para cárter (4)	NB	1 760611
	Tapa distribución	NB	1 760612
	Placa distribución	NB	1 760613
	Bomba de agua	NB	1 760614
	Jgo. múltiple escape (2)	AC	1 760615
	Múltiple admisión	NB	1 760617
	Salida de escape	AC	1 760418
	Acople filtro de aceite	NB	1 760628
	Acople bomba de agua	NB	1 760629
	Junta codo de agua	NB	1 760630
	Cierre lado volante	NB	1 760633
	Guarnición goma G 11.65 x 29 x 5/7.7	GS	3 760434
	Placa adaptadora bomba inyección	NB	1 760635
	Entrada de aire a colector	NB	2 760636
	Junta enfriador aceite	NB	1 760638
	Junta brida	NB	1 760637
	Guarnición goma G 72 x 85 x 6	GS	1 760639
	Tapa engranaje	NB	1 760643
	Tapa inspección	NB	1 760644
	Junta	NB	1 760648
	Tapa inspección	NB	1 760649
	Arandela A 10 x 15.7 x 2 A	ACGS	4
	Arandela A 7.8 x 13.6 x 2 A	ACGS	8
	Arandela A 13.6 x 20 x 2 A	ACGS	8
	Arandela A 16 x 22.7 x 2	ACGS	1
	Arandela A 27.5 x 33 x 2 C	CU	1
	Anillo G 111 x 116 x 8.2	GS	4
	O'ring G 20.32 x 2.62	GS	1
	O'ring G 21.82 x 3.53	GS	1
	O'ring G 24.99 x 3.53	S	3
	O'ring G 26.57 x 3.53	GS	2
	O'ring G 34.52 x 3.53	S	1
	O'ring G 63 x 3	GS	1
	O'ring G 107.62 x 2.62	GS	1
	O'ring G 134 x 3	GS	1
	O'ring suplemento junta tapa cilindros G 108 x 4	S	4
	O'ring suplemento junta tapa cilindros G 108 x 4	GS	4
	Kit de retenes completo		R760600
	Retén bancada 105 x 135 x 18	S	1 R760611S
	Retén distribución 65 x 90 x 13	S	1 R760612S
	Retén árbol de levas 57.15 x 76.2 x 9.5	P	1 R850012P
	Retén auxiliar 11 x 22 x 7	P	1 R760615P

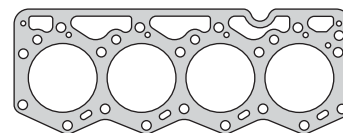

760607

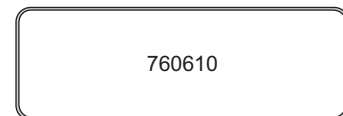

760610

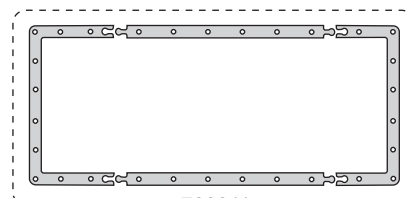

760611

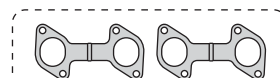

760615



760617

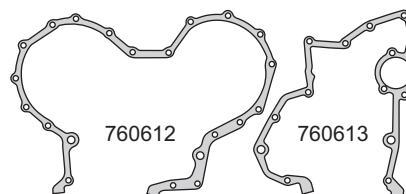

760612

760613

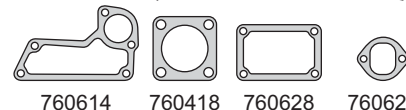

760614

760418

760628

760629

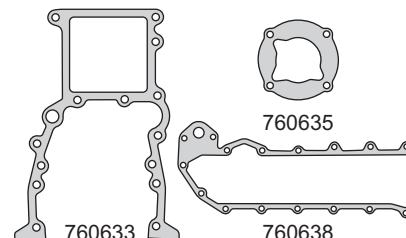

760635



760636

760643

760644

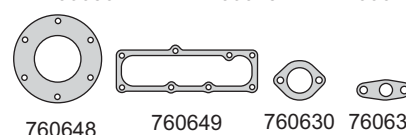

760638



760648

760649

760630

760637



760434

A 13.6 x 20 x 2 A



A 7.8 x 13.6 x 2 A

A 10 x 15.7 x 2 A



A 16 x 22.7 x 2

G 20.32 x 2.62

G 21.82 x 3.53

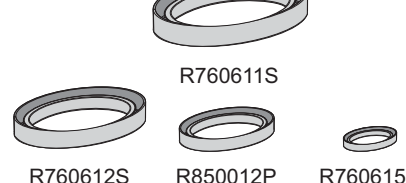

R760611S

R760612S

R850012P

R760615P

KOMATSU



Motor / Engine	Cm ³	HP	Ø
4D105-3	4330	63	111

Komatsu: Tractor, Autoelevador

DIESEL



Nº OE	Descripción / Description	Mat.	Ref.
	Jgo. de juntas para motor		760700-R
	Junta tapa cilindros Ø 112.0 ± 1.75	NFT 1	760707
	Junta tapa válvulas	NB 1	760710
	Junta para cárter	CG 1	760711
	Frente motor	NB 1	760712
	Bomba de agua	NB 1	760714
	Múltiple de escape	FCH 1	760715
	Salida de escape	AC 1	760718
	Junta soporte tapa aceite	NB 1	760727
	Junta base filtro aceite a block	NB 1	760728
	Junta conector agua	NB 1	760731
	Junta tapa block lado volante	NB 1	760733
	Junta alojamiento volante a placa	NB 1	760734
	Junta refrigeración aceite	NB 2	760737
	Junta	NB 1	760738
	Guarnición G 47.5 x 54 x 4.5	GS 1	760038
	Junta	NB 1	760740
	Junta	NB 1	760741
	Junta tubo llenado aceite	NB 1	760742
	Junta tapa engranaje	NB 1	760743
	Guarnición G 12 x 23.5 x 8.6	GS 4	760744
	Junta tapa frontal inspección	NB 1	760748
	Junta tapa inspección	NB 1	760749
	Arandela A 7.8 x 13.6 x 2 A	AC/GS 12	
	Arandela A 13.6 x 20 x 2 A	AC/GS 10	
	Arandela A 11.8 x 18 x 2 A	AC/GS 6	
	Arandela A 14 x 24 x 1.5 A	AL 6	
	Arandela A 30 x 40 x 2 A	AL 1	
	O'ring G 11 x 2.20	GS 4	
	O'ring G 18 x 2.20	GS 1	
	O'ring G 21.82 x 3.53	GS 1	
	O'ring G 23.39 x 3.53	GS 2	
	O'ring G 23.47 x 2.62	GS 1	
	O'ring G 28.17 x 3.53	GS 2	
	O'ring G 29.74 x 3.53	GS 1	
	O'ring G 53.57 x 3.53	GS 1	
	O'ring G 64 x 3.10	GS 1	
	O'ring G 75 x 3.10	GS 1	
	O'ring G 88 x 3.10	GS 2	
	O'ring G 88 x 3.10	GS 1	
	O'ring G 97 x 3.20	GS 1	
	O'ring G 107.62 x 2.62	GS 1	
	O'ring suplemento camisa cilindros G 117.07 x 3.45	S 4	
	O'ring suplemento camisa cilindros G 117.07 x 3.45	GS 4	
	Kit de retenes completo		R760700
	Jgo. retén válvulas (8)	S 1	R760710S
	Retén bancada 105 x 135 x 18	S 1	R760611S
	Retén distribución 60 x 82 x 12	S 1	R760712S
	Retén árbol de levas 11 x 22 x 7	S 1	R760615S

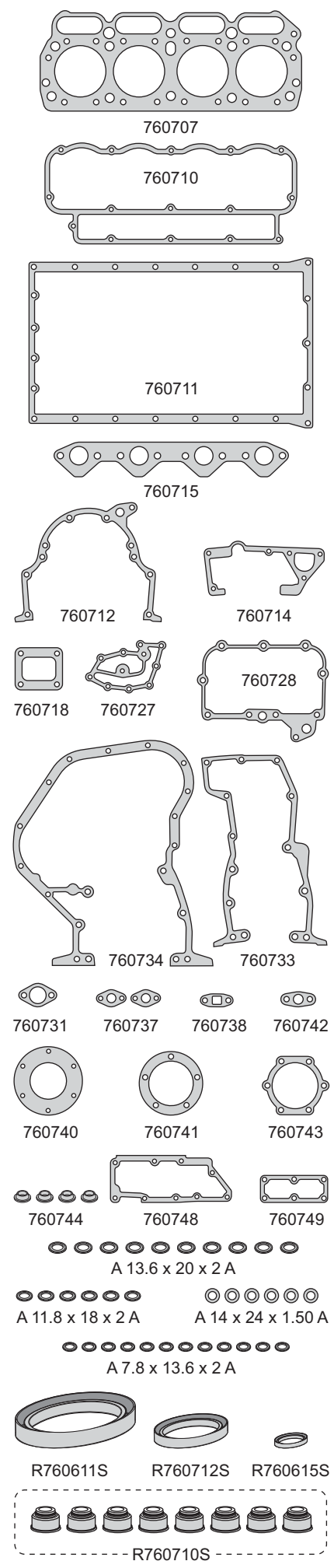

KOMATSU



Motor / Engine



Cm³

HP

Ø

6D95

4890

71

97

Komatsu: Tractor, Excavadora

DIESEL



Nº OE	Descripción / Description	Mat.	Ref.
	Jgo. de juntas para motor	●	760800-R
	Junta tapa cilindros Ø 96.8 ±1.70	NFT	1 760807
	Junta tapa válvulas	GS	1 760810
	Junta para cárter	NB	1 760811
	Tapa distribución	NB	1 760412
	Placa distribución	NB	1 760413
	Bomba de agua	NB	1 760814
	Jgo. múltiple de escape (2)	AC	1 760815
	Salida de escape	AC	1 760818
	Junta codo de agua	NB	1 760830
	Guarnición goma G 29 x 11 x 5/8	GS	4 760634
	Entrada de aire a colector	NB	2 760436
	Junta refrigerador aceite	GS/NB	2 760837
	Guarnición G 47.5 x 54 x 4.5	NB	1 760038
	Placa bomba de agua	GS	1 760438
	Junta tubo de escape	NB	1 760440
	Arandela cónica A 7 x 13.8 x 3.8	CU	6
	Arandela A 7.8 x 13.6 x 2 A	AC/GS	1
	Arandela A 10 x 15.7 x 2 A	AC/GS	4
	Arandela A 13.6 x 20 x 2 A	AC/GS	8
	Arandela A 20 x 30 x 1 A	AL	1
	O'ring G 17.12 x 2.62	GS	1
	O'ring G 28.17 x 3.53	GS	1
	O'ring G 40.87 x 3.53	GS	1
	O'ring G 50.39 x 3.53	GS	1
	O'ring G 72 x 2	GS	1
	O'ring G 97 x 3.10	GS	1
	O'ring G 134 x 3	GS	1
	Kit de retenes completo		R760800
	Jgo. retén válvulas (12)	P	1 R760810P
	Retén bancada 95 x 120 x 17	S	1 R760411S
	Retén distribución 62 x 85 x 12	S	1 R760412S

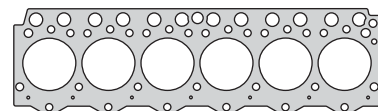

760807

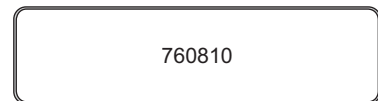

760810

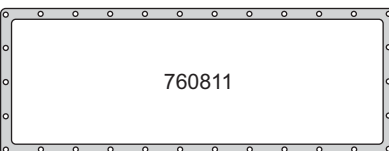

760811



760412

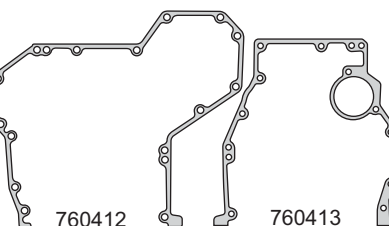

760413

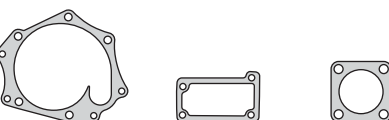

760440

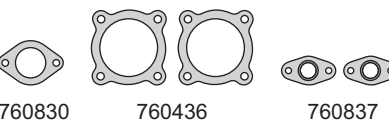

760830

760436

760837

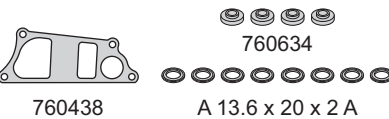

760634

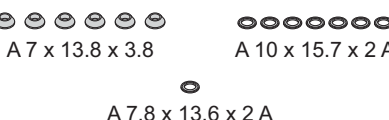

A 7 x 13.8 x 3.8

A 10 x 15.7 x 2 A

A 13.6 x 20 x 2 A

A 7.8 x 13.6 x 2 A



G 28.17 x 3.53

G 17.12 x 2.62



G 40.87 x 3.53

G 72 x 2

G 50.39 x 3.53



G 97 x 3.10



R760411P

R760412S

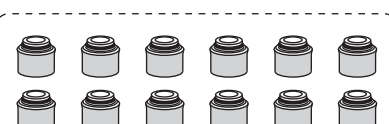

R760810P

KOMATSU



Motor / Engine **Cm³** **HP** **Ø**

6D95 **4890** **71** **94**

Komatsu: Tractor, Autoelevador

DIESEL

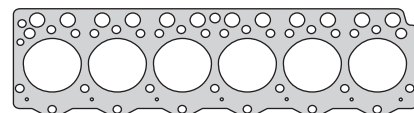

760908

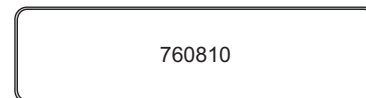

760810

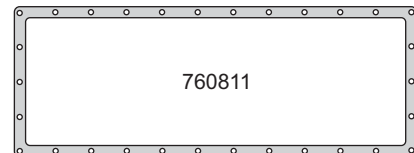

760811



760815

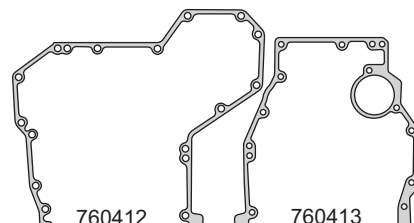

760412

760413

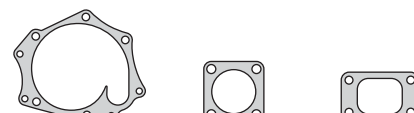

760814

760818

760918

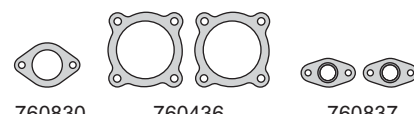

760830

760436

760837



760438

760434

G 40 x 3.6



A 7 x 13.8 x 3.8

A 10 x 15.7 x 2 A

A 7.8 x 13.6 x 2 A

A 13.6 x 20 x 2 A

A 20 x 30 x 1 A

G 14 x 19 x 2.80

G 17.12 x 2.62



G 50.39 x 3.53

G 28.17 x 3.53

G 97 x 3.1



R760411P

R760412S



R760810P

Nº OE	Descripción / Description	Mat.	Ref.
	Jgo. de juntas para motor		760900-R MLS
	Junta tapa cilindros Ø 96.8 ± 1.40	MLS	1 760908
	Junta tapa válvulas	GS	1 760810
	Junta para cárter	NB	1 760811
	Tapa distribución	NB	1 760412
	Placa distribución	NB	1 760413
	Bomba de agua	NB	1 760814
	Jgo. múltiple de escape (2)	AC	1 760815
	Junta tubo de escape	AC	1 760918
	Salida de escape	AC	1 760818
	Junta codo de agua	NB	1 760830
	Guarnición goma G 29 x 11.8 x 5/7.70	GS	4 760434
	Entrada de aire a colector	NB	2 760436
	Junta refrigerador aceite	NB/GS	2 760837
	Guarnición G 47.5 x 54 x 4.5	GS	1 760038
	Placa bomba de agua	NB	1 760438
	Arandela cónica A 7.8 x 13.8 x 3.8 C	CU	6
	Arandela A 7.8 x 13.6 x 2 A	AC/GS	1
	Arandela A 10 x 15.7 x 2 A	AC/GS	4
	Arandela A 13.6 x 20 x 2 A	AC/GS	8
	Arandela A 20 x 30 x 1 A	AL	1
	Anillo G 14 x 19 x 2.80	GS	1
	O'ring G 17.12 x 2.62	GS	1
	O'ring G 28.17 x 3.53	GS	1
	O'ring G 40.87 x 3.53	GS	1
	O'ring G 50.39 x 3.53	GS	1
	O'ring G 97 x 3.1	GS	1
	O'ring G 134 x 3	GS	1
	Kit de retenes completo		R760800
	Jgo. retén válvulas (12)	P	1 R760810P
	Retén bancada 95 x 120 x 17	S	1 R760411S
	Retén distribución 62 x 85 x 12	S	1 R760412S



taranto



Retenes Taranto. Un sello de garantía

El permanente desafío que presenta la evolución de los motores de combustión actuales para asegurar el sellado de sus componentes requiere del desarrollo y aplicación de tecnología moderna y eficiente en la fabricación de los retenes. La constante actividad de nuestro Departamento de Ingeniería, aplicada al desarrollo e investigación de nuevos materiales y componentes para lograr la mejor performance de nuestros productos, acompañada de la realización de ensayos de vida y exigentes pruebas específicas que garantizan el perfecto desempeño en los distintos medios funcionales y la utilización de modernas técnicas de diseño aplicada a la construcción de nuevos labios y perfiles hidrodinámicos, permite ofrecer al mercado productos que superan las necesidades de estanqueidad del motor.



1 - NUEVOS PERFILES

Facilita el montaje y asegura el agarre.

2 - POSICION PREFERENCIAL DEL LABIO

Permite trabajar el labio en posiciones no utilizadas del eje.

3 - MODERNOS DISEÑOS

Permite trabajar el labio en una parte del eje no utilizable hasta el momento.



KUBOTA



Motor / Engine	Cm ³	HP	Ø
3D66	719	20	86
DIESEL			

Kubota: Maquinaria Agrícola D722



Nº OE	Descripción / Description	Mat.	Ref.
	Jgo. de juntas para motor		770000-R
	Junta tapa cilindro Ø 68.8 ± 1.70	NFT	1 770007
	Junta tapa válvulas	GS	1 770010
	Junta para cárter	NB	1 770011
	Junta distribución	NB	1 770012
	Junta tapa trasera	NB	1 770013
	Bomba de agua	NB	1 770014
	Múltiple de escape	FCH	1 770015
	Salida de escape	FCH	1 770018
	Junta termostato	SLS	1 770019
	Bomba de combustible	SLS	1 770029
	Bomba de aceite	NB	1 770031
	Cuerpo termostato	NB	1 770034
	Comando bomba inyectora	SLS	1 770035
	Junta	NB	1 770037
	Junta	NB	1 770038
	Arandela A 6 x 10 x 1C	CU	8
	Arandela A 8.5 x 12.5 x 1.50 C	CU	2
	Arandela A 10.5 x 13.5 x 1 C	CU	2
	Arandela A 11.5 x 18 x 1.60 C	CU	3
	Arandela A 22.5 x 28 x 1.50 C	CU	1
	Anillo G 135 x 138 x 2.62	GS	1
	O'ring G 6 x 1.40	GS	1
	O'ring G 6.5 x 2	GS	1
	O'ring G 12.37 x 2.62	GS	3
	O'ring G 15.6 x 1.78	GS	1
	O'ring G 16.5 x 2.40	GS	1
	O'ring G 29 x 3	GS	1
	Kit de retenes completo		R770000
	Jgo. retén válvulas (6)	P	1 R770010P
	Retén bancada 68 x 80 x 10	S	1 R770011S
	Retén distribución 35 x 47 x 7	S	1 R550613S

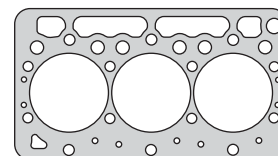

770007

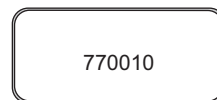

770010

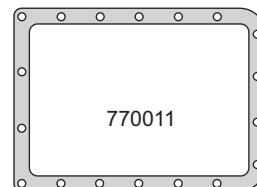

770011



770012



770013



770014

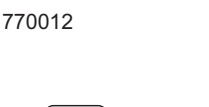

770015



770018

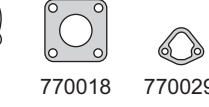

770019



770029

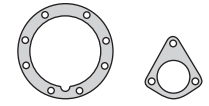

770031

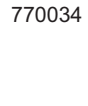

770034

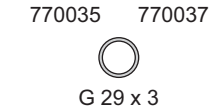

770035



770037

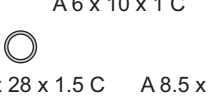

770038

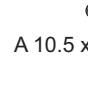

A 10.5 x 13.5 x 1 C



A 11.5 x 18 x 1.60 C

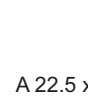

A 22.5 x 28 x 1.50 C

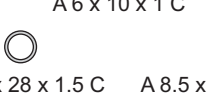

A 8.5 x 12.5 x 1.50 C



G 12.37 x 2.62

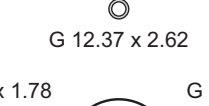

G 15.6 x 1.78



G 16.5 x 2.40

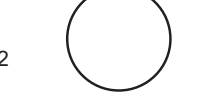

G 6.5 x 2



G 6 x 1.40

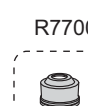

G 135 x 138 x 2.62



R770011S



R550613S

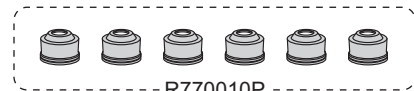

R770010P

KUBOTA



Motor / Engine	Cm ³	HP	Ø
3D72	898		72
DIESEL			

Kubota: Maquinaria Agrícola D905



Nº OE	Descripción / Description	Mat.	Ref.
	Jgo. de juntas para motor		770100-R
	Junta tapa cilindro Ø 73.0 \pm 1.70	GFT	1 770107
	Junta tapa válvulas	GS	1 770110
	Junta para cárter	NB	1 770111
	Junta distribución	SLS	1 770112
	Junta tapa trasera	SLS	1 770113
	Bomba de agua	NB	1 770114
	Múltiple de escape	FCH	1 770115
	Múltiple de admisión	NB	1 770117
	Salida de escape	FCH	1 770018
	Junta termostato	SLS	1 770119
	Bomba combustible	NB	2 770128
	Bomba de combustible	SLS	1 770129
	Junta acople inyección	NB	1 770130
	Junta cuerpo acelerador	SLS	1 770131
	Comando bomba inyectora	SLS	1 770135
	Brida válvula combustible	NB	1 770140
	Tapa trasera a tapa de cilindros	SLS	1 770142
	Junta brida	NB	1 770145
	Arandela A 6 x 10 x 1 C	CU	6
	Arandela A 8.5 x 12 x 1C	CU	1
	Arandela A 7.5 x 12 x 1.5 C	CU	3
	Arandela A 10.5 x 13.5 x 1 C	CU	2
	Arandela A 12.5 x 16 x 1.50 C	CU	1
	Arandela A 11.5 x 18 x 1.60 C	CU	3
	Arandela A 22.5 x 28 x 1.50 C	CU	2
	O´ring G 6.02 x 2.62	S	1
	O´ring G 9 x 2	S	1
	O´ring G 9.19 x 2.62	S	2
	O´ring G 15.54 x 2.62	S	4
	O´ring G 27.5 x 2	S	1
	O´ring G 29 x 3	S	1
	O´ring G 58 x 3	S	1
	Kit de retenes completo		R770100
	Jgo. retén válvulas (6)	P	1 R770010P
	Retén bancada 77 x 90 x 10	S	1 R770111S
	Retén distribución 35 x 50 x 8	S	1 R861112S
	Retén auxiliar 10 x 15 x 4	S	1 R770115P

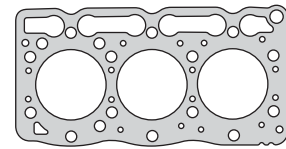

770107

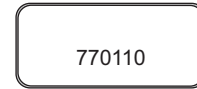

770110

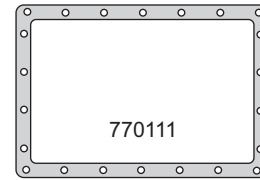

770111



770114

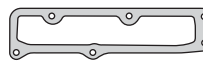

770115



770117

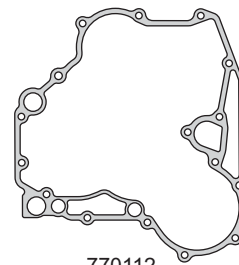

770112

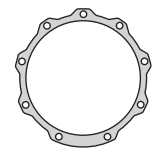

770113

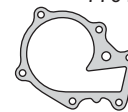

770114



770018



770119



770129



770128



770130



770131



770140

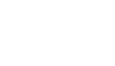

770142

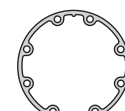

770135



770145

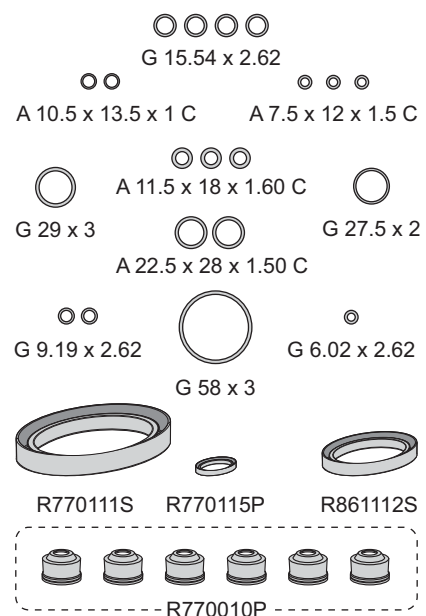

KUBOTA



Motor / Engine	Cm ³	HP	Ø
3D66	719	20	77

Kubota: Maquinaria Agrícola D722



DIESEL

Nº OE	Descripción / Description	Mat.	Ref.
	Jgo. de juntas para motor		770200-R
	Junta tapa cilindro Ø 78.0 ± 1.70	NFT	1 770207
	Junta tapa válvulas	GS	1 770210
	Junta para cárter	NB	1 770211
	Junta distribución	NB	1 770212
	Junta tapa trasera	NB	1 770213
	Bomba de agua	NB	1 770214
	Jgo. múltiple de escape (3)	NFT	1 770215
	Múltiple de admisión	NB	1 770217
	Salida de escape	FCH	1 770018
	Junta termostato	NFT	1 770219
	Placa bomba de agua	NB	1 770319
	Junta tapa bomba inyección	NB	1 770230
	Junta bomba de aceite	NB	1 770231
	Junta cierre bancada interior	NB	1 770234
	Junta cierre bancada exterior	NB	1 770235
	Junta	NB	1 770236
	Junta	NB	1 770237
	Junta	NB	1 770238
	Tapa inspección	NB	1 770249
	O´ring G 7 x 1.65	GS	1
	O´ring G 8 x 2.40	GS	1
	O´ring G 13.94 x 2.62	GS	3
	O´ring G 15 x 3	GS	3
	O´ring G 28 x 2	GS	1
	O´ring G 31.42 x 2.62	GS	1
	O´ring G 34.52 x 3.53	GS	1
	Arandela A14.5 x 19 x 1C	CU	4
	Arandela A 8.5 x 14 x 1 C	CU	4
	Kit de retenes completo		R770200
	Jgo. retén válvulas (6)	P	1 R770210P
	Retén bancada 85 x 102 x 13	S	1 R770211S
	Retén distribución 42 x 55 x 9	S	1 R770212S

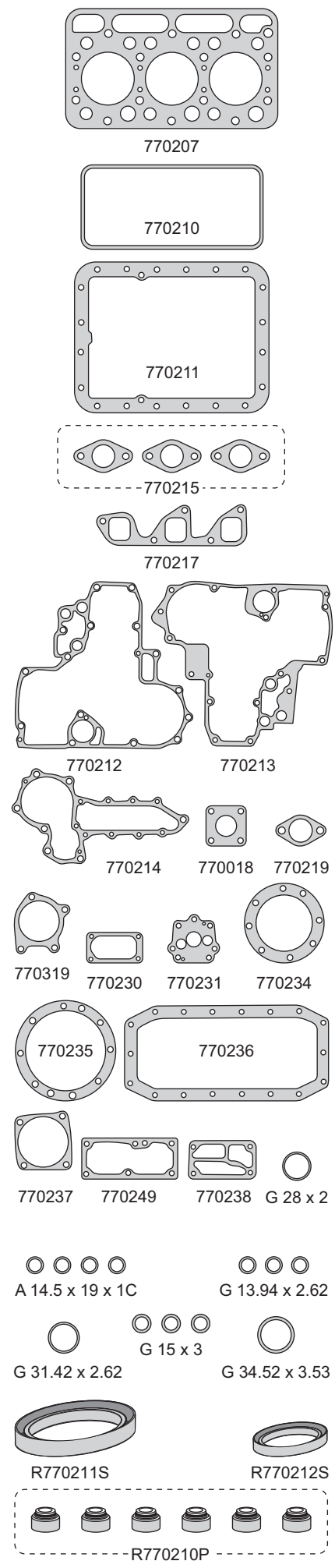

KUBOTA



Motor / Engine	Cm ³	HP	Ø
3D85	1395	35	77

Kubota: Maquinaria Agrícola D1402

DIESEL



Nº OE	Descripción / Description	Mat.	Ref.
	Jgo. de juntas para motor	●	770300-R
	Junta tapa cilindro Ø 88.0 ± 1.70	NFT	1 770307
	Junta tapa válvulas	GS	1 770210
	Junta para cárter	NB	1 770211
	Junta distribución	NB	1 770212
	Junta tapa trasera	NB	1 770213
	Bomba de agua	NB	1 770214
	Jgo. múltiple de escape (3)	NFT	1 770215
	Múltiple de admisión	NB	770217
	Salida de escape	FCH	1 770018
	Junta termostato	SLS	1 770219
	Placa bomba de agua	NB	1 770319
	Junta tapa bomba inyección	NB	1 770230
	Junta bomba de aceite	NB	1 770231
	Junta cierre bancada interior	NB	1 770234
	Junta cierre bancada exterior	NB	1 770235
	Junta	NB	1 770236
	Junta	NB	1 770237
	Junta	NB	1 770238
	Tapa inspección	NB	1 770249
	O´ring G 7 x 1.65	GS	1
	O´ring G 8 x 2.40	GS	1
	O´ring G 13.94 x 2.62	GS	3
	O´ring G 15 x 3	GS	3
	O´ring G 28 x 2	GS	1
	O´ring G 31.42 x 2.62	GS	1
	O´ring G 34.52 x 3.53	GS	1
	Arandela AA14.5 x 19 x 1C	CU	4
	Arandela AA 8.5 x 14 x 1 C	CU	4
	Kit de retenes completo		R770200
	Jgo. retén válvulas (6)	P	1 R770210P
	Retén bancada 85 x 102 x 13	S	1 R770211S
	Retén distribución 42 x 55 x 9	S	1 R770212S

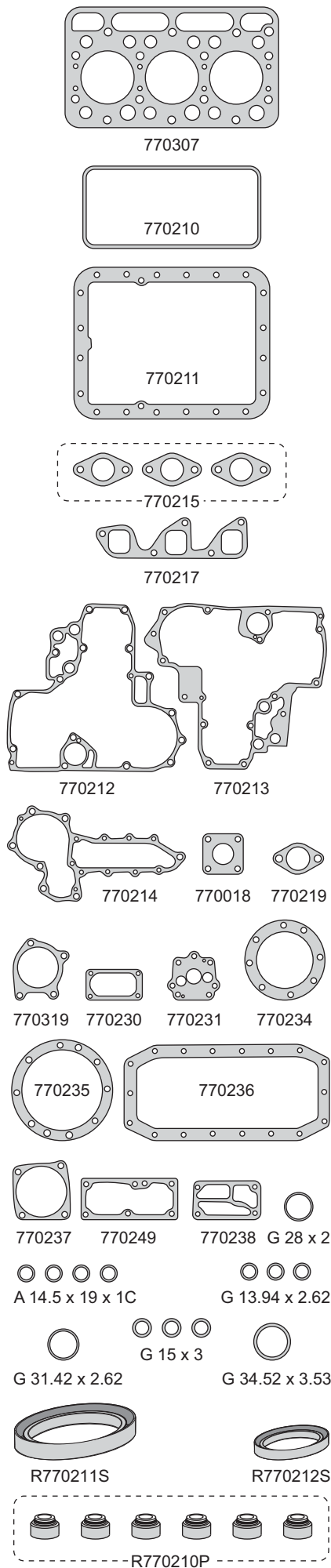

KUBOTA



Motor / Engine **4D72** Cm³ **1200** HP **72.5** Ø

Kubota: Maquinaria Agrícola V1205

DIESEL

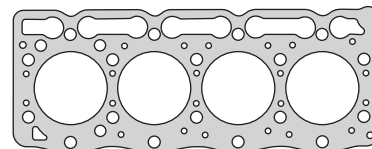

770407

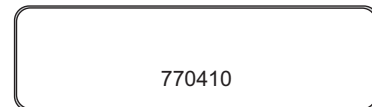

770410

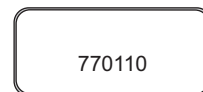

770110

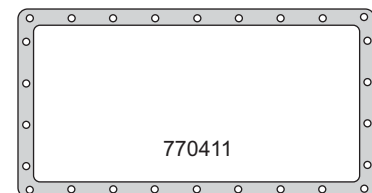

770411



770415

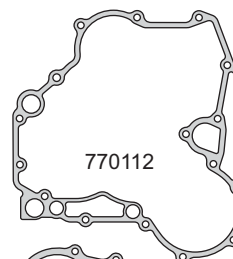

770112

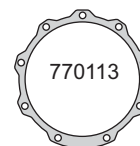

770113



770414

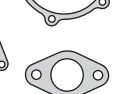

770418



770119



770129



770128



770130

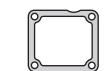

770131



770140

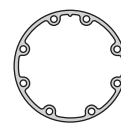

770135

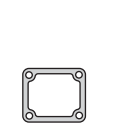

770142

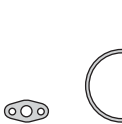

770145



G 58 x 3



A 8.5 x 12 x 1 C



G 13.94 x 2.62



A 6 x 10 x 1 C

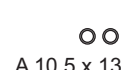

A 10.5 x 13.5 x 1 C

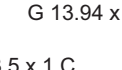

A 7.5 x 12 x 1.5 C

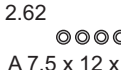

A 11.5 x 18 x 1.60 C



G 29 x 3

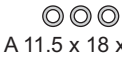

A 17 x 21 x 1.50 C

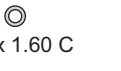

G 26 x 2

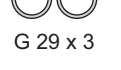

G 9.19 x 2.62

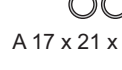

G 7 x 2

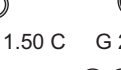

G 15.54 x 2.62

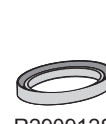

R290912S

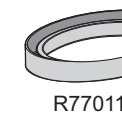

R770111S

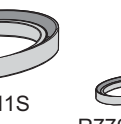

R770115P

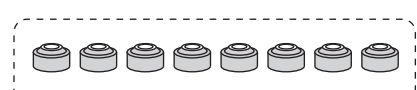

R770410P

Nº OE	Descripción / Description	Mat.	Ref.
	Jgo. de juntas para motor		770400-R
	Junta tapa cilindro Ø 73.0 ± 1.70	GFT 1	770407
	Junta tapa válvulas	GS 1	770410
	Junta tapa válvulas	GS 1	770110
	Junta para cárter	NB 1	770411
	Junta distribución	SLS 1	770112
	Junta tapa trasera	SLS 1	770113
	Bomba de agua	SLS 1	770414
	Múltiple de escape	FCH 1	770415
	Salida de escape	FCH 1	770418
	Junta termostato	SLS 1	770119
	Bomba combustible	NB 2	770128
	Bomba de combustible	SLS 1	770129
	Junta acople inyección	NB 1	770130
	Junta cuerpo acelerador	SLS 1	770131
	Comando bomba inyectora	SLS 1	770135
	Brida válvula combustible	NB 1	770140
	Tapa trasera a tapa de cilindros	SLS 1	770142
	Junta brida	NB 1	770145
	Arandela A 6 x 10 x 1 C	CU 5	
	Arandela A 8.5 x 12 x 1 C	CU 1	
	Arandela A 7.5 x 12 x 1.5 C	CU 4	
	Arandela A 10.5 x 13.5 x 1 C	CU 2	
	Arandela A 11.5 x 18 x 1.60 C	CU 4	
	Arandela A 17 x 21 x 1.50 C	CU 2	
	O´ring G 7 x 2	GS 1	
	O´ring G 9.19 x 2.62	GS 3	
	O´ring G 13.94 x 2.62	GS 2	
	O´ring G 15.54 x 2.62	GS 2	
	O´ring G 26 x 2	S 1	
	O´ring G 29 x 3	S 2	
	O´ring G 58 x 3	S 1	
	Kit de retenes completo		R770400
	Jgo. retén válvulas (8)	P 1	R770410P
	Retén bancada 77 x 90 x 10	S 1	R770111S
	Retén distribución 38 x 50 x 8	S 1	R290912S
	Retén auxiliar 10 x 15 x 4	P 1	R770115P

KUBOTA



Motor / Engine **Cm³** **HP** **Ø**

4D76 **1498** **46** **77**

Kubota: Maquinaria Agrícola V1502

DIESEL



Nº OE	Descripción / Description	Mat.	Ref.
	Jgo. de juntas para motor	●	770500-R
	Junta tapa cilindro Ø 78.0 ±1.75	NFT	1 770507
	Junta tapa válvulas	GS	1 770510
	Junta para cárter	NB	1 770511
	Junta distribución	NB	1 770212
	Junta tapa trasera	NB	1 770213
	Bomba de agua	NB	1 770214
	Múltiple de escape	FCH	1 770515
	Jgo. múltiple de admisión (2)	NB	1 770517
	Salida de escape	FCH	1 770018
	Junta termostato	NFT	1 770219
	Placa bomba de agua	NB	1 770319
	Junta tapa bomba inyección	NB	1 770230
	Junta bomba de aceite	NB	1 770231
	Junta cierre bancada interior	NB	1 770234
	Junta cierre bancada exterior	NB	1 770235
	Junta	NB	1 770236
	Junta	NB	1 770237
	Junta	NB	1 770238
	Tapa inspección	NB	1 770249
	O´ring G 7 x 1.65	GS	1
	O´ring G 8 x 2.20	GS	1
	O´ring G 13.94 x 2.62	GS	3
	O´ring G 15 x 3	GS	3
	O´ring G 28 x 2	GS	1
	O´ring G 31.42 x 2.62	GS	1
	O´ring G 34.52 x 3.53	GS	1
	Arandela A 14.5 x 19 x 1 C	CU	4
	Arandela A 8.5 x 14 x 1 C	CU	4
	Kit de retenes completo		R770500
	Jgo. retén válvulas (8)	P	1 R770510P
	Retén bancada 85 x 102 x 13	S	1 R770211S
	Retén distribución 42 x 55 x 9	S	1 R770212S

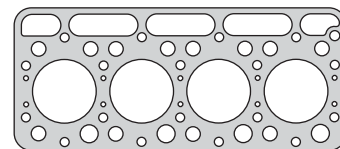

770507

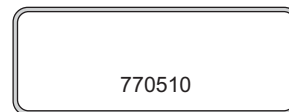

770510

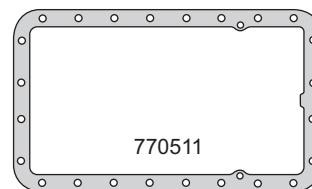

770511



770515

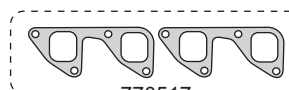

770517

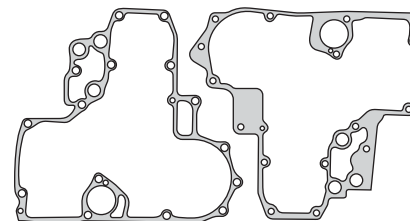

770212

770213

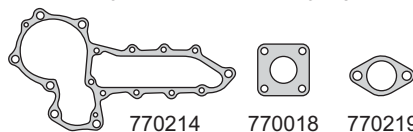

770214

770018

770219

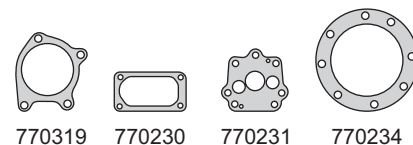

770319

770230

770231

770234

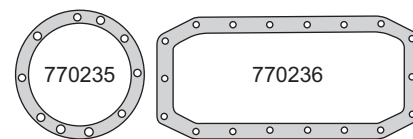

770235

770236

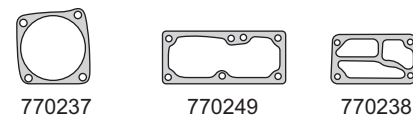

770237

770249

770238

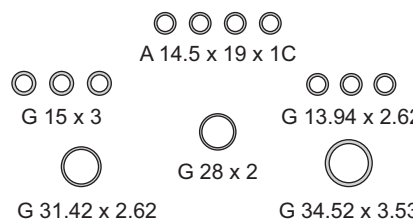

A 14.5 x 19 x 1C

G 15 x 3

G 13.94 x 2.62

G 31.42 x 2.62

G 28 x 2

G 34.52 x 3.53

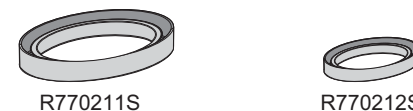

R770211S

R770212S

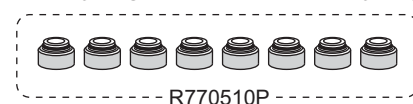

R770510P

KUBOTA



Motor / Engine	Cm ³	HP	Ø
4D87	2197	46	88
DIESEL			

Kubota: Maquinaria Agrícola V2203

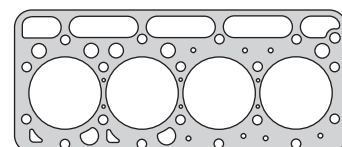

770607

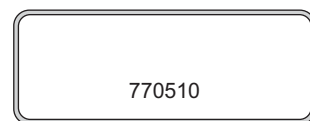

770510

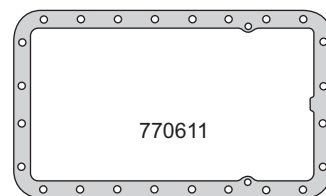

770611

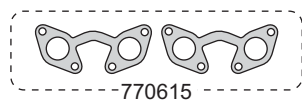

770615



770617

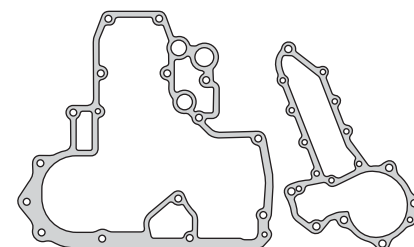

770612

770614

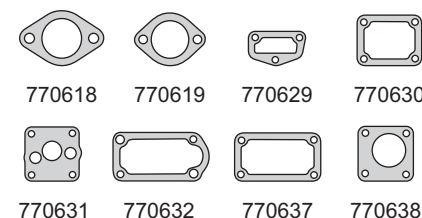

770618

770619

770629

770630

770631

770632

770637

770638

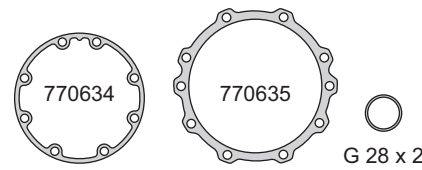

770634

770635

G 28 x 2



G 5.28 x 1.78

770137

G 20.3 x 2.62



G 29.82 x 2.62

G 6.5 x 2

G 34.52 x 3.53

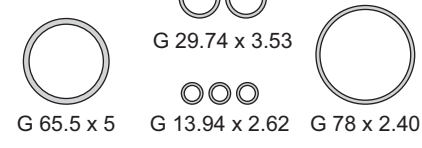

G 29.74 x 3.53

G 65.5 x 5

G 13.94 x 2.62

G 78 x 2.40

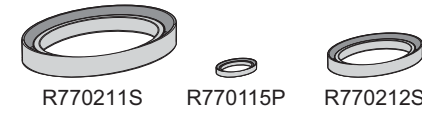

R770211S

R770115P

R770212S

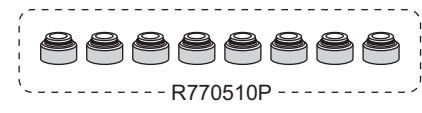

R770510P

Nº OE	Descripción / Description	Mat.	Ref.
	Jgo. de juntas para motor		770600-R
	Junta tapa cilindro Ø 88.9 ±1.70	GFT 1	770607
	Junta tapa válvulas	GS 1	770510
	Junta para cárter	NB 1	770611
	Junta distribución	NB 1	770612
	Bomba de agua	NB 1	770614
	Jgo. múltiple de escape (2)	FCH 1	770615
	Múltiple de admisión	NB 1	770617
	Salida de escape	FCH 1	770618
	Junta termostato	NB 1	770619
	Junta retorno agua	NB 1	770629
	Junta tapa bomba inyección	NB 1	770630
	Junta bomba de aceite	NB 1	770631
	Junta cuerpo acelerador	NB 1	770632
	Junta cierre bancada interior	SLS 1	770634
	Junta cierre bancada exterior	NB 1	770635
	Casquillo metálico fijación A 3.45 x 17.6 x 7.30	AC 4	770137
	Junta	NB 1	770637
	Junta	NB 1	770638
	O´ring G 5.28 x 1.78	GS 1	
	O´ring G 6.5 x 2	GS 1	
	O´ring G 11 x 2.25	S 1	
	O´ring G 13.94 x 2.62	S 3	
	O´ring G 20.3 x 2.62	GS 1	
	O´ring G 28 x 2	S 1	
	O´ring G 29.74 x 3.53	S 2	
	O´ring G 29.82 x 2.62	S 1	
	O´ring G 34.52 x 3.53	S 1	
	O´ring G 65.5 x 5	GS 1	
	O´ring G 78 x 2.40	S 1	
	Arandela A 6 x 10 x 1 C	CU 2	
	Arandela A 8 x 12.5 x 1.50 C	CU 9	
	Arandela A 14 x 18 x 1.50 C	CU 2	
	Arandela A 14 x 21 x 2 C	CU 4	
	Arandela A 26.5 x 36 x 2 C	CU 1	
	Kit de retenes completo		R770600
	Jgo. retén válvulas (8)	P 1	R770510P
	Retén bancada 85 x 102 x 13	S 1	R770211S
	Retén distribución 42 x 55 x 9	S 1	R770212S
	Retén auxiliar 10 x 15 x 4	P 1	R770115P

KUBOTA



Motor / Engine	Cm ³	HP	Ø
4D87	2197	46	88

Kubota: Maquinaria Agrícola V2203

DIESEL



Nº OE	Descripción / Description	Mat.	Ref.
	Jgo. de juntas para motor		770700-R MLS
	Junta tapa cilindro Ø 88.0 ±1.25	MLS 1	770708
	Junta tapa válvulas	GS 1	770710
	Junta para cárter	NB 1	770711
	Junta distribución	NB 1	770612
	Bomba de agua	NFT 1	770714
	Jgo. múltiple de escape (2)	FCH 1	770615
	Múltiple de admisión	NB 1	770717
	Salida de escape	GFT 1	770718
	Junta termostato	NB 1	770619
	Junta retorno agua	NB 1	770629
	Junta tapa bomba inyección	NB 2	770630
	Junta bomba de aceite	NB 1	770631
	Junta cuerpo acelerador	NB 1	770632
	Junta cierre bancada interior	SLS 1	770634
	Junta cierre bancada exterior	NB 1	770735
	Junta	NB 1	770737
	Junta	NB 1	770638
	Junta	NB 1	770744
	O´ring G 10.77 x 2.62	GS 1	
	O´ring G 13.94 x 2.62	GS 2	
	O´ring G 15.54 x 2.62	GS 1	
	O´ring G 20.3 x 2.62	GS 2	
	O´ring G 28.5 x 3.15	GS 1	
	O´ring G 34.52 x 3.53	GS 1	
	Kit de retenes completo		R770700
	Jgo. retén válvulas (8)	P 1	R770710P
	Retén bancada 85 x 102 x 13	S 1	R770211S
	Retén distribución 42 x 55 x 9	S 1	R770212S

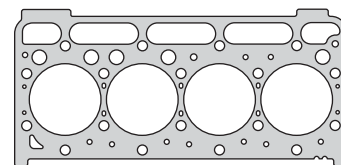

770708



770710

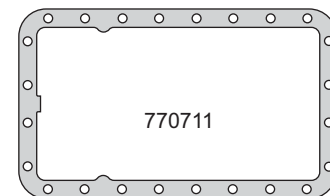

770711



770615



770717

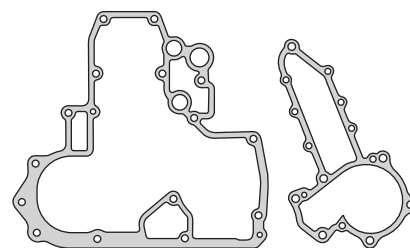

770612

770714



770718

770619

770629

770631

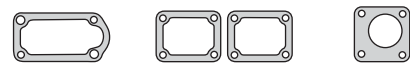

770632

770630

770638

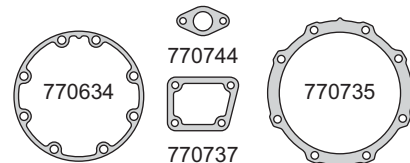

770634

770744

770735

770737



G 10.77 x 2.62

G 15.54 x 2.62

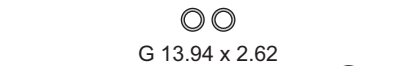

G 13.94 x 2.62

G 20.3 x 2.62

G 28.5 x 3.15

G 34.52 x 3.53



R770211S



R770212S

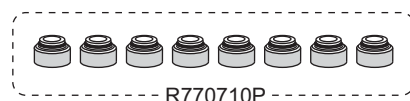

R770710P

KUBOTA



Motor / Engine	Cm ³	HP	Ø
4D98T	3318		98
DIESEL			

Kubota: Maquinaria Agricola V3300

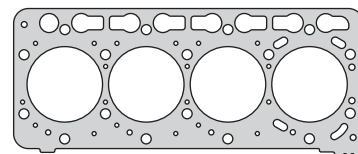

770808

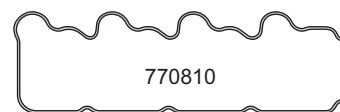

770810



770815

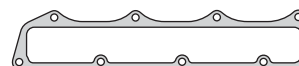

770814

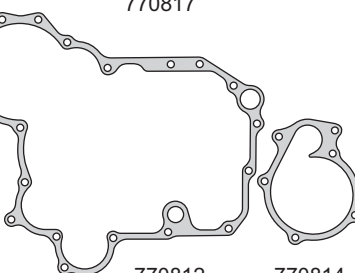

770817

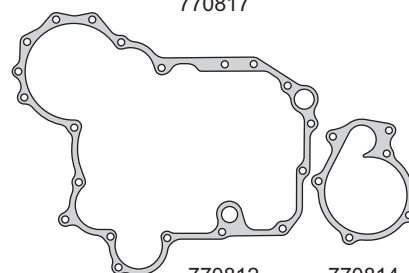

770812

770814



770819



770831



770829

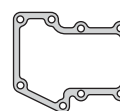

770832

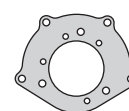

770834

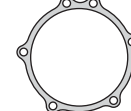

770835



G 40.87 x 3.53



G 94.97 x 1.78



G 71.12 x 2.62



G 29 x 3

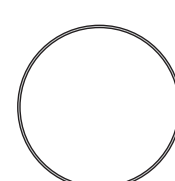

G 140 x 2



G 63 x 4



R770811V



R770812S

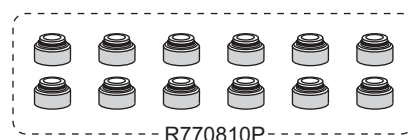

R770810P

Nº OE	Descripción / Description	Mat.	Ref.
	Jgo. de juntas para motor		770800-R MLS
	Junta tapa cilindro Ø 99.5 x 0.85	MLS	1 770808
	Junta tapa válvulas	GS	1 770810
	Junta distribución	NB	1 770812
	Bomba de agua	NB	1 770814
	Múltiple de escape	AC	1 770815
	Múltiple de admisión	NB	1 770817
	Junta termostato	NB	1 770819
	Bomba de combustible	NB	1 770829
	Base termostato	NB	1 770831
	Placa termostato	NB	1 770832
	Cierre bancada	NB	1 770834
	Placa adaptador bomba inyección	NB	1 770835
	O´ring G 29 x 3	S	1
	O´ring G 40.87 x 3.53	S	1
	O´ring G 63 x 4	GS	1
	O´ring G 71.12 x 2.62	GS	2
	O´ring G 94.97 x 1.78	GS	1
	O´ring G 140 x 2	GS	1
	Kit de retenes completo		R770800
	Jgo. retén válvulas (12)	P	1 R770810P
	Retén bancada 100 x 120 x 11.5	V	1 R770811V
	Retén distribución 58 x 80 x 12	S	1 R770812S



taranto

INSTRUCCIONES DE MONTAJE

1



Seleccionar el eje piloto para encajar el diámetro interno del retén guía de válvula e insertar.

2



Seleccionar el mandril con el diámetro interno más pequeño que encaja en el retén y montarlo a mano.

3



Deslizar el mandril en el eje piloto e insertar el mismo en la guía de válvulas. Deslizar hacia abajo y luego retirarla la herramienta.



HCRV - Herramienta de Instalación RGV Taranto.

Este dispositivo permite alinear correctamente el retén a la guía de válvula, eliminando así el riesgo de dañar el mismo durante el montaje.

- ▶ Permite instalar el retén de guía de válvulas evitando su caída hacia el interior del cilindro, permitiendo así el recambio del retén sin desmontar la tapa de cilindros.
- ▶ Es aplicable en vehículos nacionales e importados.



MAZDA



Motor / Engine	Cm ³	HP	Ø
HA/WEF	2977	86	95

Mazda: Pick Up, Camión T3000 1985/...
Autoelevador Yale 1984/...



DIESEL

Nº OE	Descripción / Description	Mat.	Ref.
SE01-99-100C	Jgo. de juntas para motor		971200-R
SE01-10-271	Junta tapa cilindros Ø 99.5 ± 1.78	NFT	1 971207
	Jgo. tornillos tapa cilindros (HAD14038)		B971200
SE-01-10235	Junta tapa válvulas	GS	1 971110
SE01-991022A	Jgo. junta para cárter (4)	NB	1 971111
	Tapa distribución	CB	1 971112
	Placa distribución	CB	1 971113
	Bomba de agua	CB	1 971114
SL01-13-461-A	Jgo. múltiple escape (4)	FCH	1 971115
SE01-13-111	Múltiple admisión	NB	1 971117
	Termostato	CG	1 971119
	Radiador aceite	CB	1 971130
	Junta cárter inferior	CG	1 971131
	Caja termostato	CB	1 971132
	Porta retén bancada trasera	CB	1 971134
	Bomba inyectora	CB	1 971135
	Chupador aceite	CB	1 971137
	Base entrada admisión	CB	2 971138
	Conducto aceite	CB	1 971139
	Guarnición especial tapa válvulas	GS	4 971140
	Arandela con inserto especial	AC/GS	2 971141
	Arandela con inserto A 35 x 42 x 2.5 A	AC/GS	1 971142
	Arandela con inserto A 25 x 32 x 2.5 A	AC/GS	1 971143
	Arandela inyector A 15 x 21 x 1 C	CU	4
	Arandela tapón cárter A 14 x 20 x 1 C	CU	1
	O´ring G 10.5 x 2.5	GS	3
	O´ring G 15.5 x 2.5	GS	2
	O´ring G 26 x 3.5	GS	2
	Kit de retenes completo		R971100
SE70-10-155	Jgo. retén válvulas (8)	V	1 R971110V
SE08-10-399	Retén bancada trasera 101.57 x 125 x 13	P	1 R900811P
SE08-10-602	Retén distribución 51 x 70 x 11	P	1 R900812P

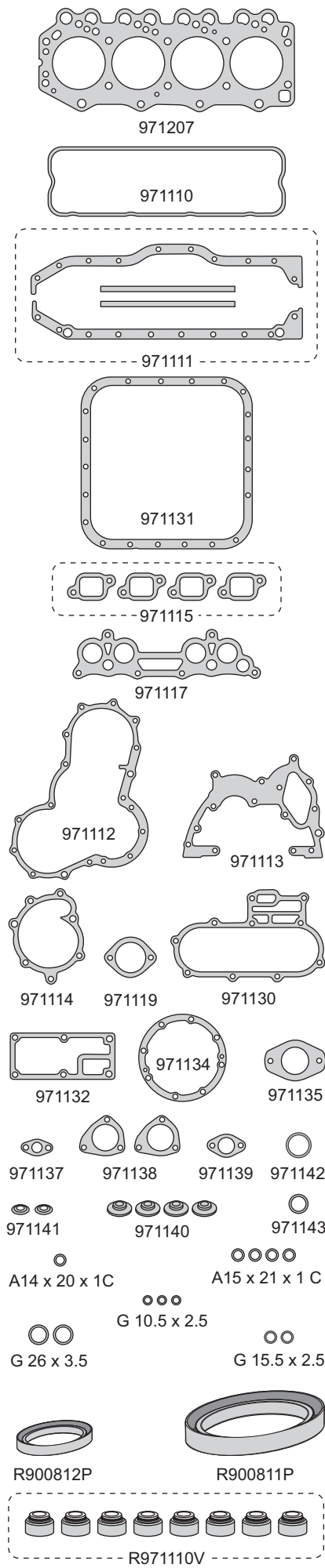

MAZDA



Motor / Engine	Cm ³	HP	Ø
HA	2977	86	95

DIESEL

Mazda: T3000 1981/84



Nº OE	Descripción / Description	Mat.	Ref.
	Jgo. de juntas para motor	●	974100-R
	Junta tapa cilindros Ø 99.5 ± 1.70	NFT	1 974107
	Jgo. tornillos tapa cilindros		B971200
	Junta tapa válvulas	GS	1 974110
	Jgo. junta para cárter (4)	NB	1 974111
	Tapa distribución	NB	1 974112
	Placa distribución	NB	1 974113
	Bomba de agua	NB	1 974114
	Jgo. múltiple escape (4)	AC	1 974115
	Múltiple admisión	NB	1 974117
	Termostato	NB	1 974119
	Radiador aceite	NB	1 974130
	Junta cárter inferior	NB	1 974131
	Caja termostato	NB	1 974132
	Arandela fijación tapa válvulas	AC/GS	3 974133
	Porta retén bancada trasera	NB	1 974134
	Bomba inyectora	NB	1 974135
	Chupador aceite	NB	1 974137
	Base entrada admisión	NB	1 974138
	Conducto aceite	NB	1 974139
	O'ring G 13.94 x 2.62	GS	1
	Kit de retenes completo		R974100
	Jgo. retén válvulas (8)	P	1 R974110P
	Retén bancada 101.57 x 125 x 13	S	1 R900811S
	Retén distribución 50.8 x 69.85 x 11	S	1 R973712S

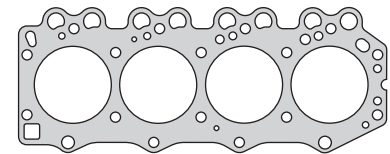

974107

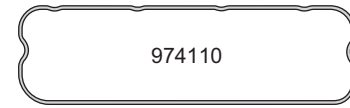

974110

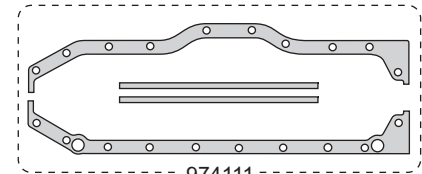

974111

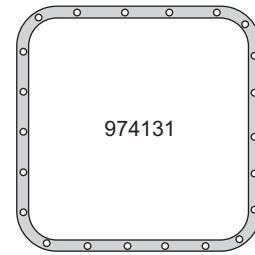

974131



974115

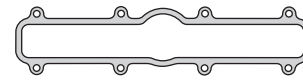

974117

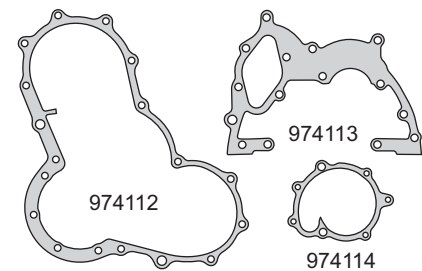

974112

974113

974114

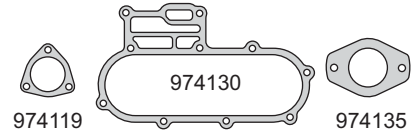

974119

974130

974135



974132

974134

974138



974139

974133

974137

G 13.94 x 2.62



R973712S

R900811S

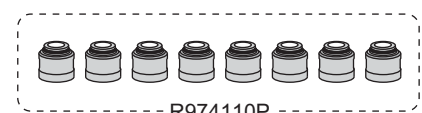

R974110P

MAZDA



Motor / Engine	Cm ³	HP	Ø
HA	2977	86	95

Mazda: E3000 1978/81



DIESEL

Nº OE	Descripción / Description	Mat.	Ref.
	Jgo. de juntas para motor		974200-R
	Junta tapa cilindros Ø 99.5 ± 1.55	NFT 1	974207
	Junta tapa válvulas	CG 1	974210
	Jgo. junta para cárter (4)	CG 1	974211
	Tapa distribución	NB 1	974212
	Placa distribución	NB 1	974213
	Bomba de agua	NB 1	974214
	Jgo. múltiple escape (4)	NFT 1	974215
	Jgo. múltiple admisión (4)	NB 1	974217
	Salida de escape	NB 1	974218
	Termostato	NB 1	974219
	Bomba de aceite	NB 1	974227
	Bomba combustible	NB 1	974228
	Base filtro aceite	NB 1	974229
	Junta base termostato	NB 1	974231
	Caja termostato	NB 1	974232
	Tapa trasera tapa cilindros	NB 1	974233
	Porta retén bancada trasera	NB 1	974134
	Bomba inyectora	NB 1	974135
	Descarga gases	NB 1	974236
	Acople caño aceite	NB 2	974237
	Arandela llenada aceite A 33 x 45 x 1.50 F	F 1	974239
	Junta	NB 1	974240
	Junta	NB 1	974241
	Junta	NB 1	974242
	Junta	NB 1	974243
	Junta	NB 1	974244
	Junta	NB 1	974245
	Kit de retenes completo		R973700
	Jgo. retén válvulas (8)	P 1	R971010P
	Retén bancada 101.57 x 125 x 13	S 1	R900811S
	Retén distribución 50.8 x 69.85 x 11	S 1	R973712S

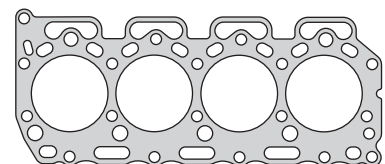

974207



974210

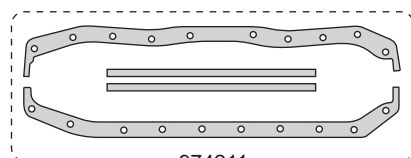

974211

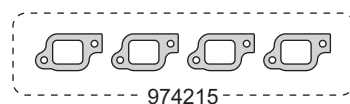

974215

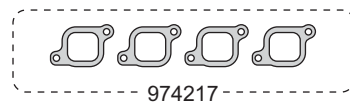

974217

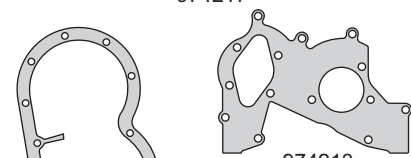

974212

974213

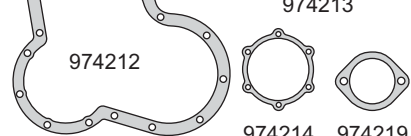

974214 974219



974218 974227 974228 974229

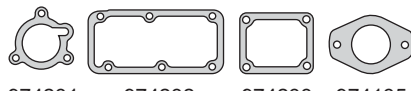

974231 974232 974233 974135



974134 974236 974240

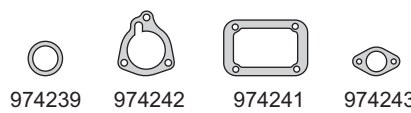

974239 974242 974241 974243

974244

974245



R973712S R900811S

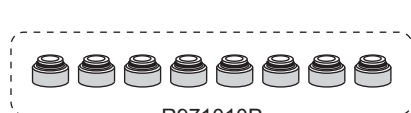

R971010P

MAZDA



Motor / Engine **Cm³** **HP** **Ø**

SL
(OHV) 8V **3455** **103**

Mazda: T3500 1984/...

DIESEL



Nº OE	Descripción / Description	Mat.	Ref.
	Jgo. de juntas para motor		974300-R
	Junta tapa cilindros Ø 104.0 ± 1.75	NFT	1 974307
	Junta tapa válvulas	GS	1 974310
	Jgo. junta para cárter (4)	NB	1 974311
	Tapa distribución	NB	1 974312
	Placa distribución	NB	1 974313
	Bomba de agua	NB	1 974314
	Jgo. múltiple escape (4)	AC	1 974115
	Múltiple admisión	NB	1 974317
	Termostato	NB	1 974319
	Retorno agua	NB	1 974329
	Radiador aceite	NB	1 974330
	Junta cárter inferior	GS	2 974331
	Caja termostato	NB	1 974132
	Arandela fijación tapa válvulas A6.8 x 23 x 4.6	AC/GS	3 974133
	Porta retén bancada trasera	NB	1 974134
	Chupador aceite	NB	1 974337
	Conducto aceite	NB	1 974339
	O'ring G 13.94 x 2.62	GS	1
	Kit de retenes completo		R974100
	Jgo. retén válvulas (8)	P	1 R974110P
	Retén bancada 101.57 x 125 x 13	S	1 R900811S
	Retén distribución 50.8 x 69.85 x 11	S	1 R973712S

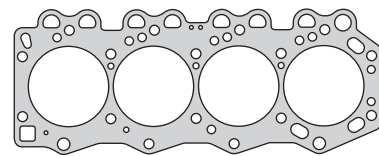

974307

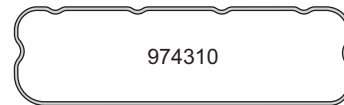

974310

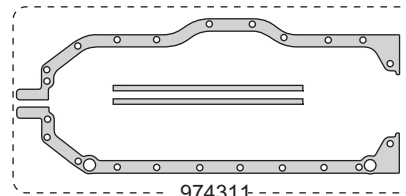

974311

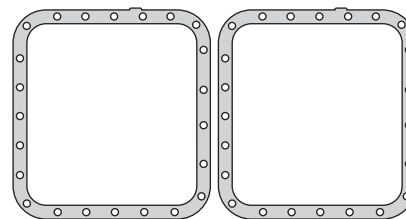

974331



974115



974317

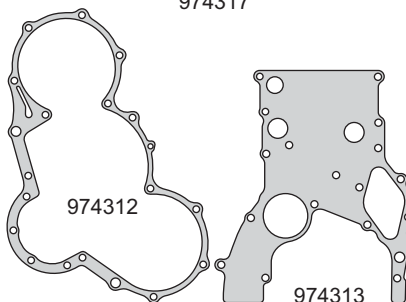

974312

974313

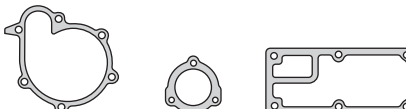

974314

974319

974132



974329

974133

974337

974339

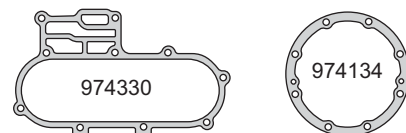

974330

974134



G 13.94 x 2.62



R973712S

R900811S

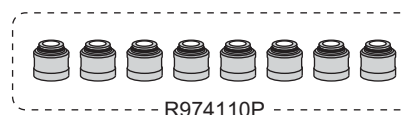

R974110P

MAZDA



Motor / Engine **Cm³** **HP** **Ø**

SL-T
(OHV) 8V **3455** **103**

Mazda: T3500 1984/...

DIESEL



Nº OE	Descripción / Description	Mat.	Ref.
	Jgo. de juntas para motor		974400-R MLS
	Junta tapa cilindros Ø 104.0 ± 1.45	MLS	1 974408
	Junta tapa válvulas	GS	1 974310
	Jgo. junta para cárter (4)	NB	1 974311
	Tapa distribución	NB	1 974312
	Placa distribución	NB	1 974313
	Bomba de agua	NB	1 974314
	Jgo. múltiple escape (4)	AC	1 974415
	Múltiple admisión	NB	1 974417
	Termostato	NB	1 974319
	Retorno agua	NB	1 974329
	Radiador aceite	NB	1 974330
	Junta cárter inferior	NB	2 974331
	Caja termostato	NB	1 974132
	Arandela fijación tapa válvulas	AC/GS	3 974133
	Porta retén bancada trasera	NB	1 974134
	Chupador aceite	NB	1 974337
	Conducto aceite	NB	1 974339
	O'ring G 13.94 x 2.62	GS	1
	Kit de retenes completo		R974100
	Jgo. retén válvulas (8)	P	1 R974110P
	Retén bancada 101.57 x 125 x 13	S	1 R900811S
	Retén distribución 50.8 x 69.85 x 11	S	1 R973712S

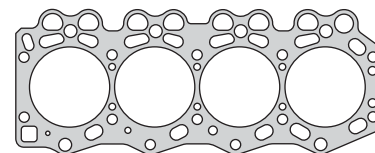

974408

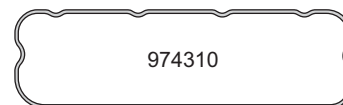

974310

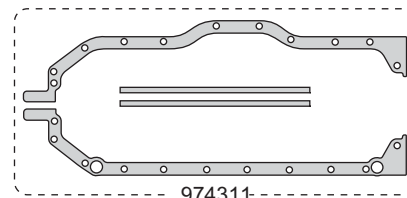

974311

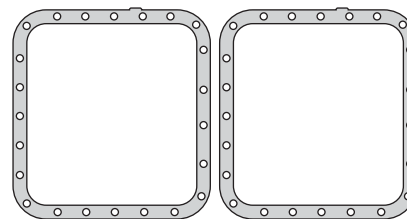

974331



974415



974417

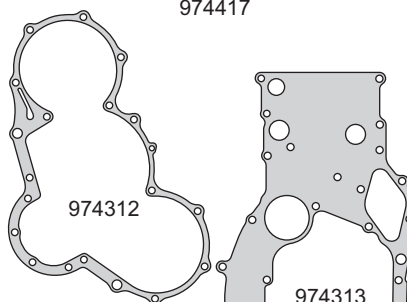

974312

974313



974314

974319

974132



974329

974133

974337

974339

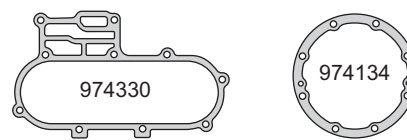

974330

974134

G 15 x 2.50



R973712S

R900811S

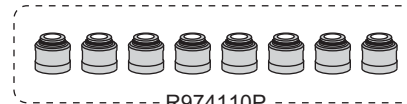

R974110P

MAZDA



Motor / Engine **Cm³** **HP** **Ø**

TF **4021** **HP** **105.5**

(OHV) 8V

Mazda: T4000

DIESEL



Nº OE	Descripción / Description	Mat.	Ref.
	Jgo. de juntas para motor		● 974500-R MLS
	Junta tapa cilindros Ø 109.8 ± 1.30	MLS 1	974508
	Junta tapa válvulas	GS 1	974510
	Junta para cárter	GS 1	974511
	Junta distribución	NB 1	974512
	Tapa distribución	NB 1	974513
	Bomba de agua	NB 1	974514
	Múltiple escape	AC 1	974515
	Múltiple admisión	NB 1	974517
	Termostato	NB 1	974519
	Distribuidor aceite radiador	NB 2	974529
	Junta caja termostato	NB 1	974531
	Junta caja termostato	NB 1	974532
	Arandela fijación tapa de válvulas	AC/GS 3	974133
	Junta	NB 1	974534
	Junta entrada aire	NB 1	974537
	Junta	NB 1	974538
	Junta	NB 1	974539
	Junta	NB 2	974540
	Arandela A 14.5 x 20 x 1.50	AL 1	
	Arandela A 7.5 x 14 x 2 C	CU 4	
	Arandela A 10.5 x 16 x 1 C	CU 4	
	O´ring G 12.37 x 2.62	GS 1	
	O´ring G 13.94 x 2.62	GS 1	
	O´ring G 15.54 x 2.62	GS 2	
	O´ring G 17.12 x 2.62	GS 2	
	O´ring G 11.5 x 2.30	S 4	
	O´ring G 24.99 x 3.53	S 2	
	O´ring G 8 x 2.20	GS 1	
	O´ring G 8.5 x 2.20	GS 8	
	Kit de retenes completo		R974500
	Jgo. retén válvulas (8)	P 1	R974110P
	Retén bancada 105 x 125 x 13	S 1	R974511S
	Retén distribución 60 x 81 x 11	S 1	R974512S

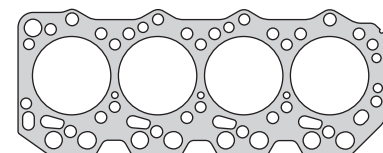

974508

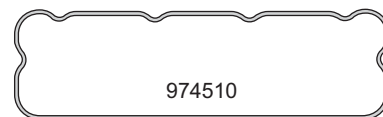

974510

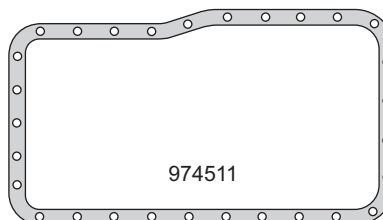

974511

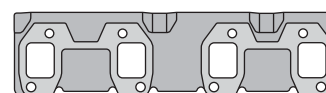

974512

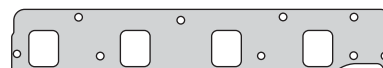

974513

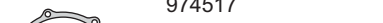

974514



974515

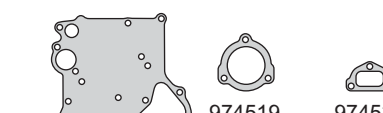

974517

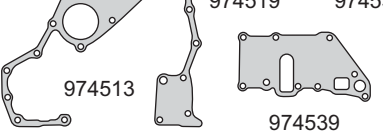

974519

974534

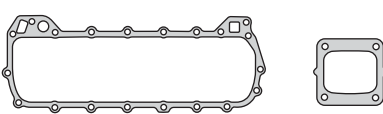

974512

974513

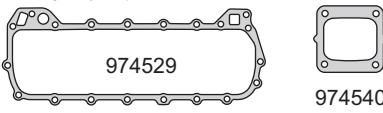

974512

974513

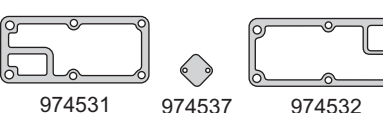

974512

974513

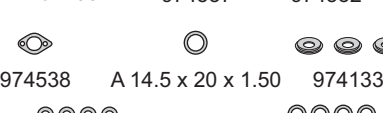

974512

974513

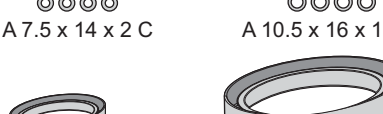

974512

974513



974512

974513

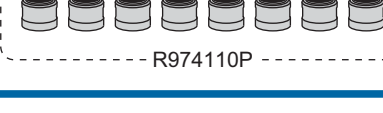

974512

974513



974512

974513

MAZDA



Motor / Engine **Cm³** **HP** **Ø**

TM **4553** **HP** **109**

(OHV) 8V

Mazda: T4500

DIESEL

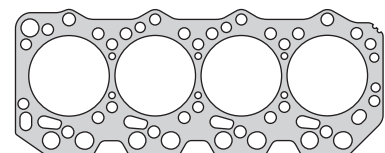

974608

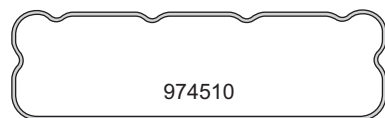

974510

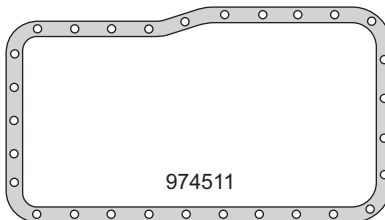
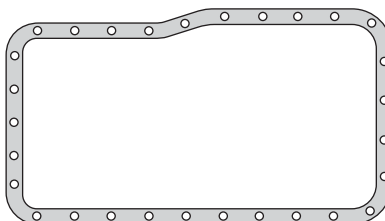

974511

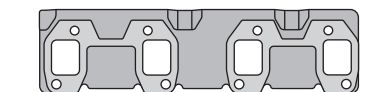

974515



974617

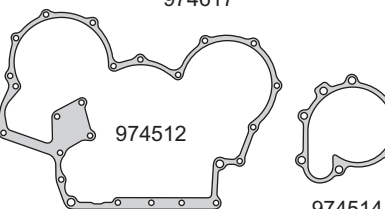

974512

974514

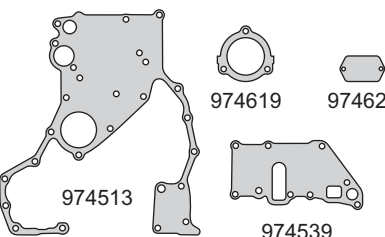

974513

974619

974628

974539



974534

974133

974538

G 21.89 x 2.62



R974512P

R974511P

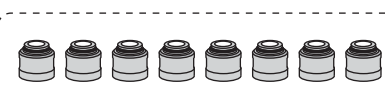

R974110P

Nº OE	Descripción / Description	Mat.	Ref.
	Jgo. de juntas para motor		● 974600-R MLS
	Junta tapa cilindros Ø 113.0 ±1.30	MLS	1 974608
	Junta tapa válvulas	GS	1 974510
	Junta para cárter	GS	2 974511
	Junta distribución	NB	1 974512
	Tapa distribución	NB	1 974513
	Bomba de agua	NB	1 974514
	Múltiple escape	AC	1 974515
	Múltiple admisión	SLS	1 974617
	Termostato	NB	1 974619
	Junta	NB	1 974629
	Arandela fijación tapa de válvulas	AC/GS	3 974133
	Junta	NB	1 974534
	Junta	NB	1 974538
	Junta	NB	1 974539
	O´ring G 21.89 x 2.62	GS	1
	Kit de retenes completo		R974500
	Jgo. retén válvulas (8)	P	1 R974110P
	Retén bancada 105 x 125 x 13	S	1 R974511S
	Retén distribución 60 x 81 x 11	S	1 R974512S



Junta Tapa de Cilindros Taranto.

Las juntas están diseñadas para superar las exigencias de presión y temperatura que producen los motores de última generación.

- Eliminación del retorque en juntas 07 y 08.
- Mayor resistencia mecánica y térmica.
- Compuestos sellantes especiales que aseguran la máxima estanqueidad.
- Superficie sellante antiadherente que no daña las partes metálicas del motor.
- Ahorro de mano de obra, evita trabajos adicionales.
- Utilización de materiales ecológicos.



**MERCEDES
BENZ**



Motor/Engine **L911 OM311/312** **CM³** **4580** **HP** **98** **Ø** **90**

Mercedes Benz: MB 3500, L3250, L3500
1949/52

DIESEL



Nº OE	Descripción/Description	Mat.	Ref.
	Jgo. de juntas para motor		● 350000-R
3120162120	Junta tapa cilindros Ø 93.0 ± 1.40	NFT	1 350005
	Jgo. tornillos tapa cilindros		B350000
3520160421	Junta tapa válvulas superior	CG	350310
3520160421	Junta tapa válvulas superior	NH	350331
3520160421	Junta tapa válvulas superior	NFT	1 350332
3525860301	Jgo. junta para cárter (4)	CG	1 350011
3520150320	Tapa distribución	CG	1 350012
3120150580	Placa distribución	NB	1 350013
3122010480	Tapa bomba de agua	NB	1 350014
3521420180	Jgo. múltiple escape (2)	NFT	1 350015
3524921080	Salida de escape	FCH	1 350018
3122010380	Placa bomba de agua	NB	1 350019
3121841079	Filtro aceite a block	NB	1 350027
	Junta tapa cilindros compresor aire	NB	1 350034
3520150522	Junta tapa válvulas lateral	CG	1 350036
3211880179	Refrigerador aceite	CB	1 350037
3121881479	Tapa refrigerador aceite	NB	1 350038
	Arandela radiador aceite	NB	16 350040
	Junta tapa cilindros compresor aire	NB	1 350042
3520760279	Soporte bomba inyectora	NB	1 350045
3120150680	Cierre distribución	CG	1 350046
	Jgo. juntas refrigeración aceite	VS	350048
	Jgo. juntas refrigeración P. P.	VS	1 350048B
	Jgo. juntas caja de velocidades G-27	CB	350050
	Palier	AL	350256
	Jgo. empaquetadura cigüeñal (2)	SNA	1 350458
	Tapa diferencial	CG	350059
3525860301	Jgo. junta para cárter (2)	CGT	350060
	Tapa diferencial	CG	350069
	O'ring camisa inyector G 30.54 x 7.3	GS	
	Anillo retorno inyector G 6.5 x 14 x 8	GS	
	Retén distribución 65 x 90 x 15	S	1 R350212S

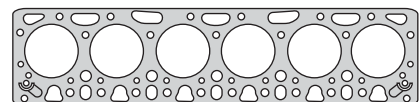

350005



350332

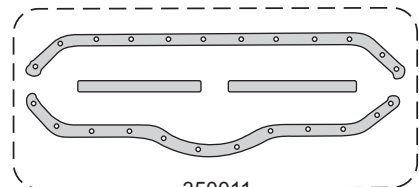

350011

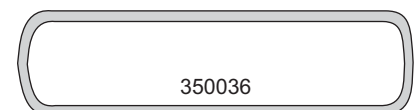

350036

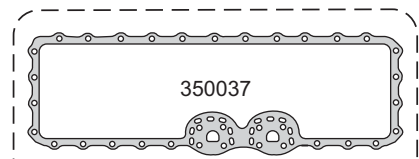

350037



350040

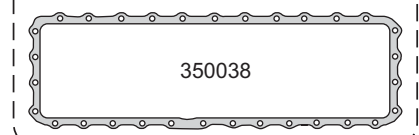

350038

350048

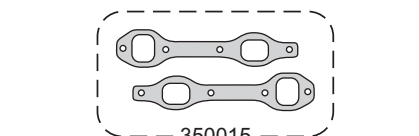

350015

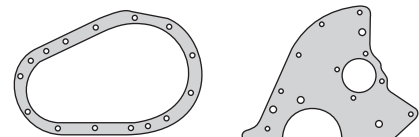

350012

350013

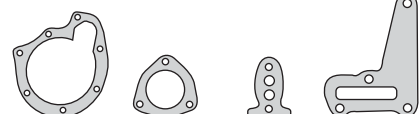

350014

350018

350027

350019



350034

350042

350045

350046

G 6.5 x 14 x 8



G 30.54 x 7.3

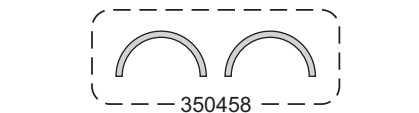

350458



R350212S

**MERCEDES
BENZ**



Motor/Engine	Cm³	HP	Ø
OM 314 (OHV) 8V	3786	85	97
DIESEL			

Mercedes Benz: MB L608 D/Unimog
1966/...



Nº OE	Descripción/Description	Mat.	Ref.
	Jgo. de juntas para motor		350100-R
	Jgo. de juntas superior	●	350195
3140160220	Jta. tapa cilindros Ø 99.0 ± 1.40	NFT	1 1 350805
	Jta. tapa cilindros Ø 99.0 ± 1.40 N.R. G	NFT	350807
	Jgo. tornillos tapa cilindros (HAD19038)		B350100
3140160221	Junta tapa válvulas superior	NFT	1 1 350132
3140160221	Junta tapa válvulas superior	NH	350131
3140160221	Junta tapa válvulas superior	CG	350110
3140140772	Jgo. junta para cárter (4)	CG	1 350111
3520150320	Tapa distribución	CG	1 350012
3520150320	Tapa distribución	NB	1 350312
3120150580	Placa distribución	NB	1 350013
3522010480	Tapa bomba de agua	NB	1 350314
3141420080	Múltiple admisión y escape	NFT	1 1 350115
3094920080	Salida de escape	FCH	1 350118
3141840379	Base filtro aceite	NB	1 350127
3140160280	Salida agua	NB	1 1 350129
3141840079	Base filtro aceite	NB	1 350130
	Arandela doble raccord	CU	4 4 350032
3240150080	Tapa lateral agua a block	NB	1 350133
3211310079	Cilindros compresor aire	NB	1 350034
	Carcasa termostato	NB	1 1 350035
3140150622	Junta tapa válvulas lateral	CG	1 350136
3522030780	Tapa carcasa termostato	NB	1 1 350041
3211310279	Cabeza cilindros compresor	NB	1 350042
3522030080	Galería superior agua	NB	3 3 350043
3120760279	Galería inferior agua	NB	2 2 350044
3120150680	Soporte bomba inyectora	NB	1 350045
	Cierre distribución	CG	1 350046
	Jgo. juntas caja de velocidades	VS	350150
	Palier	AL	350256
	Jgo. empaquetadura cigüeñal (2)	SNA	1 350458
3140140772	Tapa diferencial	CG	350159
	Jgo. junta para cárter	CGT	350160
0169978248	O'ring camisa inyector G 30.8 x 3.7	GS	4 4 350840
3129970840	Tubo retorno G 6.4 x 13.8 x 8	GS	5
	Arandela A 10 x 20 x 1C	CU	4 4
	Arandela A 16 x 22 x 1.5 A	AL	2 2
	Arandela A 20 x 24 x 1.5 A	AL	1 1
	Arandela A 24 x 32 x 2 A	AL	1 1
	Arandela A 26 x 32 x 2 A	AL	1
	Arandela A 8 x 14 x 1C	CU	6 6
	O'ring G 13.94 x 2.62	GS	1
	Jgo. retén válvulas (8)	P	R350110P
	Retén distribución 65 x 90 x 15	S	1 R350212S

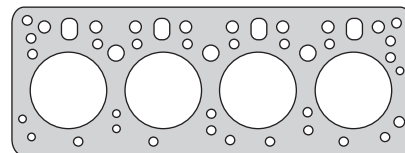

350805

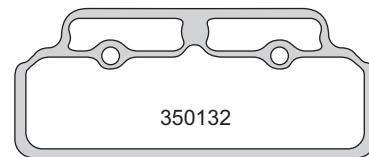

350132

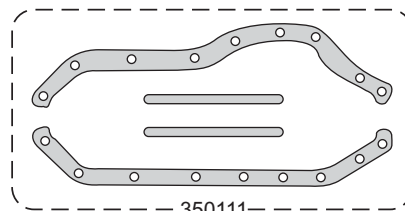

350111

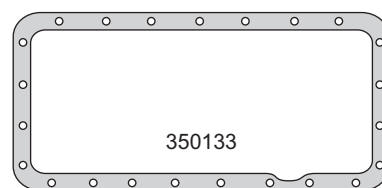

350133

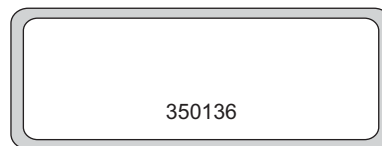

350136



350115

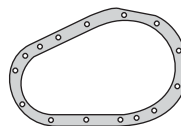

350012

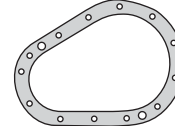

350312



350314

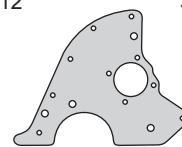

350013



350118



350129



350130



350032



350127



350034



350035



350041



350042



350043



350044

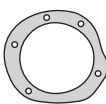

350045



350046



R350212S



350458



R350110P

**MERCEDES
BENZ**



Motor/Engine	Cm³	HP	Ø
OM 321 (OHV) 12V	5100	108	95
DIESEL			

Mercedes Benz: MB 1112, 1114, 0140, L1112
L1514 1957/...



Nº OE	Descripción/Description	Mat.	Ref.
	Jgo. de juntas para motor		● 350200-R
3120162220	Junta tapa cilindros Ø 96.0 ± 1.40	NFT	1 350205
	Jgo. tornillos tapa cilindros (HAD19038)		B350300
3520160421	Junta tapa válvulas superior	NFT	1 350332
3520160421	Junta tapa válvulas superior	NH	350331
3520160421	Junta tapa válvulas superior	CG	350310
3525860301	Jgo. junta para cárter (4)	CG	1 350011
3520150320	Tapa distribución	CG	1 350012
3120150580	Placa distribución	NB	1 350013
3122010480	Tapa bomba de agua	NB	1 350014
3521420180	Jgo. múltiple escape (2)	NFT	1 350015
3524921080	Salida de escape	FCH	1 350018
3122010380	Placa bomba de agua	NB	1 350019
	Soporte bomba de agua	NB	1 350219
3121841079	Filtro aceite a block	NB	1 350027
3520180180	Llenado aceite motor	CG	1 350327
	Arandela doble raccord	CU	6 350032
3211310079	Base compresor aire Ø 77 mm.	NB	1 350034
3520150522	Junta tapa válvulas lateral	CG	1 350036
3211880179	Refrigerador aceite inferior	CB	1 350037
3121881479	Tapa refrigerador aceite superior	NB	1 350038
0090911280	Base bomba combustible	NB	1 350039
	Llenado aceite		350239
	Arandela refrigerador aceite	NB	16 350040
3211310279	Tapa cilindro compresor	NB	1 350042
	Tapa compresor	NB	1 350242
3522030680	Galería superior agua	NB	1 350043
3520760279	Soporte bomba inyectora	NB	1 350045
3120150680	Cierre distribución	CG	1 350046
	Jgo. juntas refrigerador aceite	VS	350048
	Juego juntas refrigeración P.P.	VS	1 350048B
	Jgo. juntas caja de velocidades G-27	CB	350050
	Jgo. juntas caja de velocidades G32	VS	350350
	Jgo. juntas diferencial eaton 161/162	VS	210155
	Núcleo diferencial Eaton 132 A y B (chico)	CB	350355
	Palier (16 agujeros)	AL	350257
0009979641	Jgo. empaquetadura cigüeñal (2)	SNA	1 350458
	Tapa diferencial simple	CG	350259
	Jgo. juntas compresor aire 77 mm.	VS	1 350359
3525860301	Jgo. junta para cárter (2)	CGT	350060
	Jgo. juntas motor electrónico Eaton	VS	210166
	Núcleo diferencial Eaton 132 A y B	CG	350368
	Tapa diferencial Eaton 161/162	CG	350369
	Tapa diferencial eaton 132 A y B (chico)	CG	350388
	O'ring camisa inyector G 30.8 x 3.7	GS	350840
	Anillo retorno inyector G 6.5 x 14 x 8	GS	
	Jgo. retén válvulas (12)	P	R350210-2P
0009975446	Retén distribución 65 x 90 x 15	S	1 R350212S

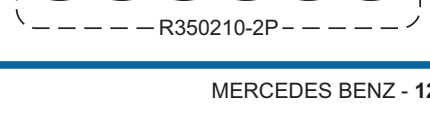
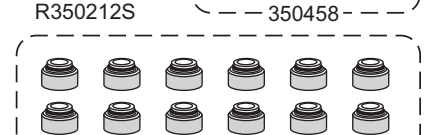
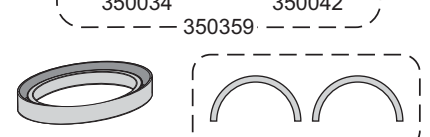
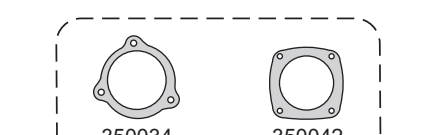
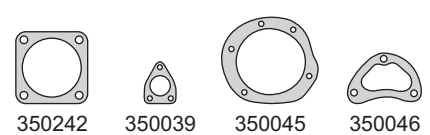
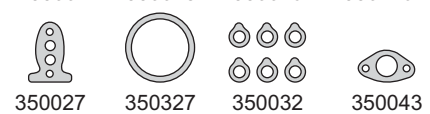
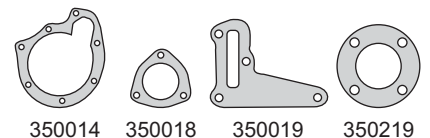
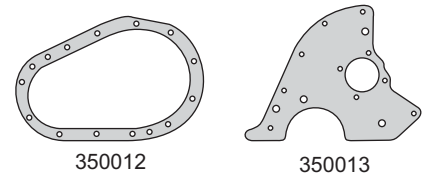
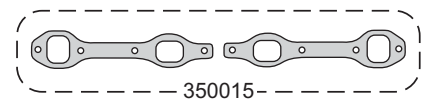
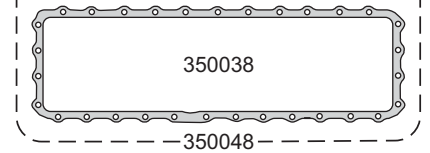
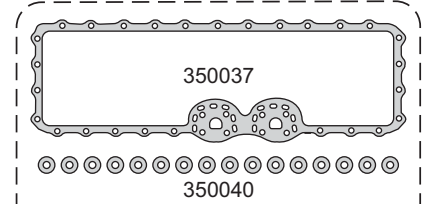
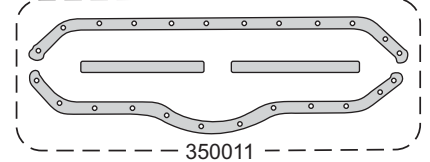
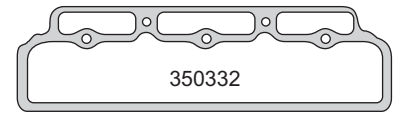
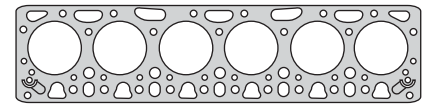

**MERCEDES
BENZ**



Motor/Engine	Cm³	HP	Ø
OM 352 (OHV) 12V	5675	100	97
DIESEL			

Mercedes Benz: MB 1114, 0140 1972/...
OM 352 Turbinado 1981/...
OM 352 Aspirado 1981/...



Nº OE	Descripción/Description	Mat.	Ref.
3525861390	Jgo. de juntas para motor		350300-R
	Jgo. de juntas para motor		350301-R
	Jgo. de juntas superior		350395
3520160220	Junta tapa cilindros Ø 98.5 ±1.40	NFT 1 1	350305
	Jgo. tornillos tapa cilindros (HAD19038)		B350300
3520160421	Junta tapa válvulas superior	CG	350310
3520160421	Junta tapa válvulas superior	NB	350331
3520160421	Junta tapa válvulas superior	NFT 1 1	350332
3525860301	Jgo. junta para cárter (4)	CGT	350011
3520150320	Tapa distribución	CG	350012
3520150320	Tapa distribución	NB	350312
3120150580	Placa distribución	NB	350013
3522010480	Tapa bomba de agua	NB	350314
3521420180	Jgo. múltiple escape (2)	NFT 1 1	350015
3524921080	Salida de escape	FCH 1 1	350018
3522010980	Placa bomba de agua	NB	350319
	Llenado aceite	CG	350327
3520780080	Arandela doble raccord	CU 15 6	350032
3271840280	Filtro aceite a block	NB	350033
3211310079	Base compresor aire 77 mm.	NB	350034
3522030480	Carcaza termostato	NB	350035
3520150522	Junta tapa válvulas lateral	CG	350036
3211880179	Refrigerador aceite inferior	CB	350037
3121881479	Tapa refrigerador aceite superior	NB	350038
0090911280	Base bomba combustible	NB	350039
	Arandela radiador aceite	NB	350040
3522030780	Tapa carcaza termostato	NB 1 1	350041
	Junta vaso bomba de agua	CG 1	540041
3211310279	Cabeza cilindro compresor	NB	350042
3522030680	Galería superior agua	NB 2 2	350043
3522030080	Galería inferior agua	NB 2 2	350044
352076279	Soporte bomba inyectora	NB	350045
3120150680	Cierre distribución	CG	350946
	Kit de arandelas (83)	CU	350347
	Jgo. juntas refrigerador aceite	VS	350048
	Jgo. juntas refrigerador aceite P.P (18)	VS	350048B
	Jgo. juntas cañería refrigeración (6)	VS	350349
	Jgo. juntas caja velocidades G32	VS	350350
	Jgo. juntas diferencial Eaton 161/162	VS	210155
	Núcleo diferencial Eaton 132 chico	CB	350355
	Palier	AL	350257
	Jgo. empaquetaduras cigüeñal (2)	SNA	350458
	Jgo. juntas compresor aire 77 mm. (2)	VS	350359
3525860301	Jgo. junta para cárter (2)	CGT	350060
	Base compresor aire 94 mm.	NB	350463
	Tapa compresor aire 94 mm.	NFT	350464
	Jgo. juntas compresor aire 94 mm. (2)	VS	350465
	Jgo. juntas motor electrico Eaton	VS	210166
	Jgo. juntas compresor aire reforma	VS	350466
	Núcleo diferencial Eaton 161/162	CB	350467
	Tapa diferencial Eaton 161/162	CG	350369
	Kit de gomas (19)	GS	350375
	Tapa filtro aceite	GS	350376

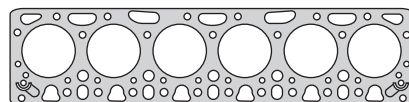

350305

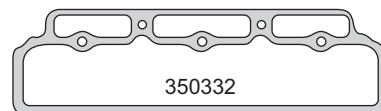

350332

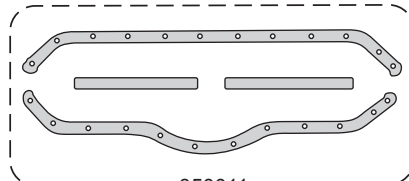

350011

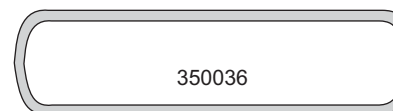

350036

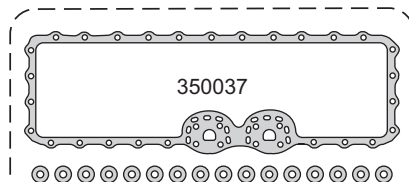

350037

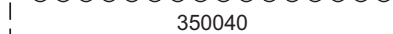

350040

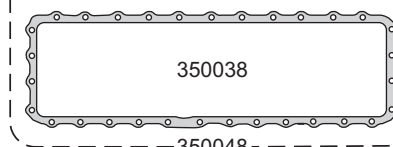

350038

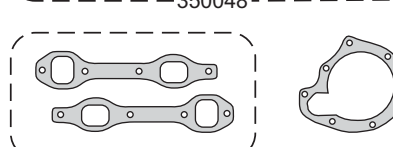

350048

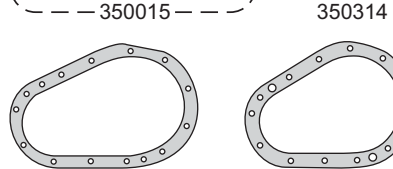

350015



350314

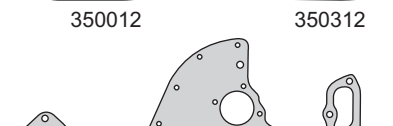

350012

350312

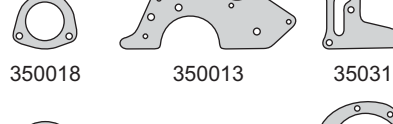

350018

350013

350319

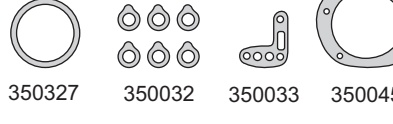

350327

350032

350033

350045

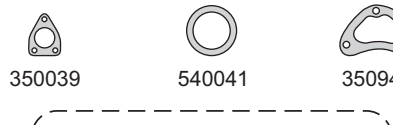

350039

540041

350946

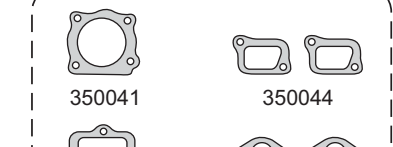

350041

350044

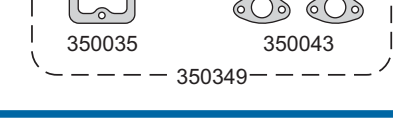

350035

350043

350349

**MERCEDES
BENZ**



Motor/Engine	Cm³	HP	Ø
OM 352 (OHV) 12V	5675	100	97

Mercedes Benz: MB 1114, 0140 1972/...
OM 352 Turbinado 1981/...
OM 352 Aspirado 1981/...



DIESEL

Nº OE	Descripción/Description	Mat.		Ref.
	Tapón goma	GS		350377
	Núcleo diferencial Eaton 162 A y B	CB		350389
	Tapa diferencial Eaton 161/162	CG		350382
	Junta tapa cilindros competición	NFT		350390
	Arandela A 10 x 14 x 1 A	AL	6 6	
	Arandela A 18 x 24 x 1.5 A	AL		2
	Arandela A 22 x 27 x 1.5 A	AL	1 1	
	Arandela A 24 x 32 x 1.5 A	AL		1
	Arandela A 14 x 20 x 1.5 A	AL		18
	Arandela A 8 x 12 x 1 Fe	F		16
	Arandela A 10 x 20 x 1 C	CU	6 6	
	Arandela A 8 x 14 x 1 C	CU	6 10	
	Arandela A 11 x 15 x 1 C	CU		4
	Arandela A 18 x 22 x 1.5 C	CU		3
	Arandela A 16 x 22 x 1.5 C	CU		2
	Arandela A 24 x 29 x 1.5 C	CU		1
	Arandela A 14 x 18 x 1.5 A	AL		1
	Arandela A 14 x 20 x 1.25 A	AL	4	
	Arandela A 16 x 22.5 x 1.5 A	AL		4
	Arandela A 16 x 21 x 1.25 A	AL	4	
	Arandela B 26 x 32 x 3 CN	CN		1
	Arandela B 24 x 32 x 3 CN	CN		1
0169978248	O'ring camisa inyector G 30.5 x 3.5	GS	6 6	
	O'ring G 13.5 x 2.5	GS		1
	O'ring G 8 x 2.4	GS		1
	O'ring G 114.5 x 5	GS		1
	O'ring G 61.8 x 3	GS		1
	O'ring G 28 x 2	GS		1
	Anillo G 95 x 104.2 x 3	GS		1
	Anillo G 6.4 x 13.8 x 8	GS	7 7	
	Jgo. retén válvulas (12)	P		R350210-2P
	Ret. banc. refor. expansible 90 x 106 x 7.5	S		R350211-1S
	Retén distribución 65 x 90 x 15	S	1	R350212S

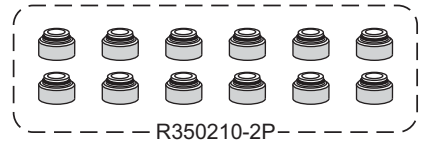
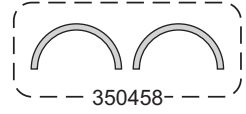
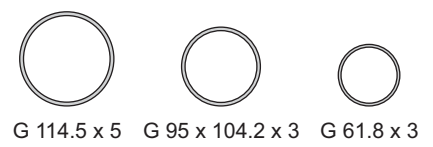
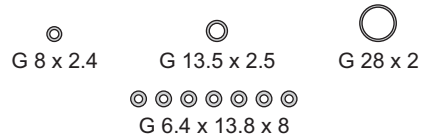
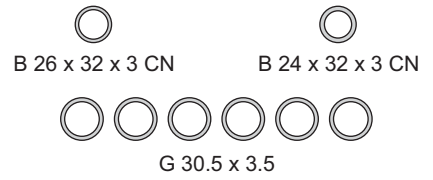
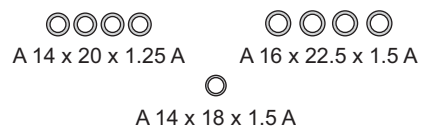
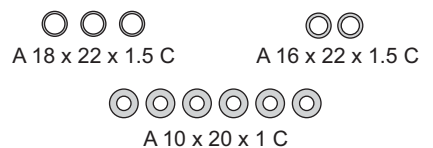
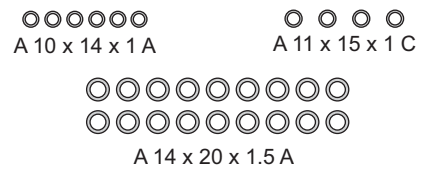
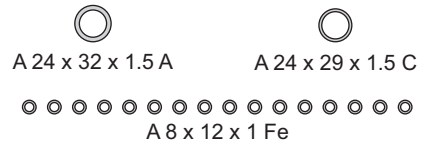
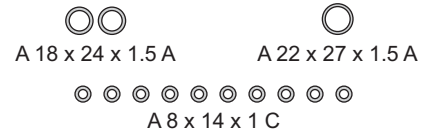
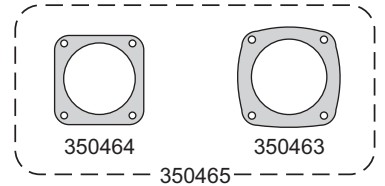
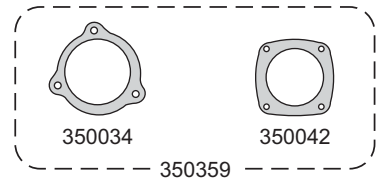

MERCEDES BENZ



Motor/Engine	Cm³	HP	Ø
OM 352A (OHV) 12V	5675	130	97
DIESEL			

Mercedes Benz: MB 1517 Turbo 0170, L911
L1518 1978/...



Nº OE	Descripción/Description	Mat.	Ref.
	Jgo. de juntas para motor		350400-R
	Jgo. de juntas para motor		350401-R
	Jgo. de juntas superior		350495
3660160220	Jta. tapa cilindros Ø 98.5 ± 1.40	NFT	350405
3660160220	Jta. tapa cilindros Ø 98.5 ± 1.30	NFT 1 1	350407
	Jgo. tornillos tapa cilindros (HAD19038)		B350300
3520160421	Junta tapa válvulas superior	CG	350310
3520160421	Junta tapa válvulas superior	NB	350331
3520160421	Junta tapa válvulas superior	NFT 1 1	350332
3525860301	Jgo. junta para cárter (4)	CGT	1 350011
3520150320	Tapa distribución	CG	1 350012
3520150320	Tapa distribución	NB	1 350312
3120150580	Placa distribución	NB	1 350013
3522010480	Tapa bomba de agua	NB	1 350314
	Jgo. múltiple escape (2)	AC 1 1	350415
	Salida de escape	FCH 1 1	350418
3522010980	Placa bomba de agua	NB	1 350319
	Tubo llenado	CG	1 350327
	Base bomba nafta	NB	1 550628
3520780080	Arandela doble raccord	CU 15 6	350032
3271840280	Filtro aceite a block	NB	1 350033
3211310079	Base compresor aire 77 mm.	NB	1 350034
3522030480	Carcaza termostato	NB 1 1	350035
3520150522	Junta tapas válvulas lateral	CG	1 350036
3211880179	Refrigerador aceite inferior	CB	1 350037
3121881479	Tapa refrigerador aceite superior	NB	1 350038
0090911280	Base bomba combustible	NB	1 350039
	Arandela radiador aceite	NB	16 350040
	Jgo. juntas sobrealimentador GARRET (5)	VS	350440
3522030780	Tapa carcaza termostato	NB 1 1	350041
	Entrada aceite turbo	NB	1 350441
	Junta vaso bomba de nafta	CG 1	540041
3211310279	Cabeza cilindro compresor	NB	1 350042
3520980880	Turbina a codo colector	AC 1 1	350442
3522030680	Galería superior agua	NB 2 2	350043
3520980580	Codo admisión	NB 1 1	350443
3522030080	Galería inferior agua	NB 2 2	350044
3520180380	Brida cárter sobrealimentador	NB 1 1	350444
3520760279	Soporte bomba inyectora	NB	1 350045
3521870080	Cañería retorno aceite	NB 1	350445
3520150480	Cierre distribución	CG	1 350946
	Kit de arandelas (83)	VS	1 350347
	Jgo. juntas refrigerador aceite	VS	350048
	Jgo. juntas refrigerador aceite (18)	VS	1 350048B
3525860301	Jgo. juntas cañería refrigeración (6)	VS	1 350349
	Jgo. juntas caja de velocidades G-32	VS	350350
	Jgo. juntas caja de velocidades G-60	VS	350450
	Palier	CB	350456
	Jgo. empaquetadura cigüeñal (2)	SNA	1 350458
	Tapa diferencial	CG	350459
3525860301	Jgo. juntas compresor aire 77 mm. (2)	NB	1 350359
	Jgo. junta para cárter (2)	CGT	1 350060
	Colector a escape turbo	AC 1 1	350462

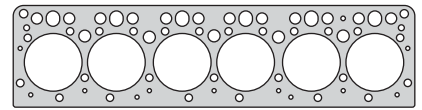

350407

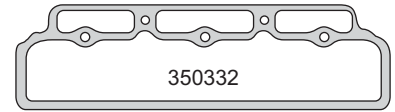

350332

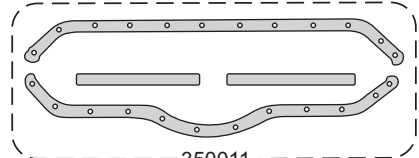

350011

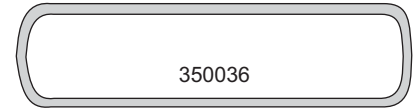

350036

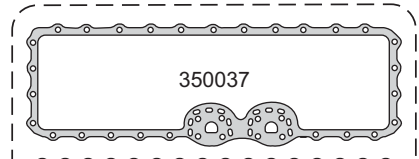

350037

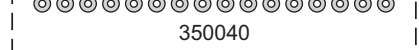

350040

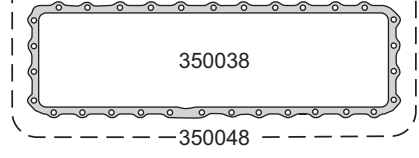

350038

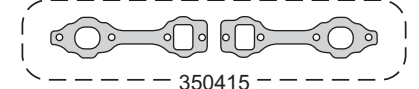

350048

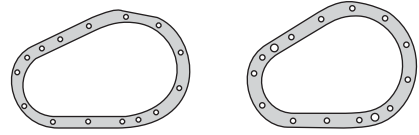

350415

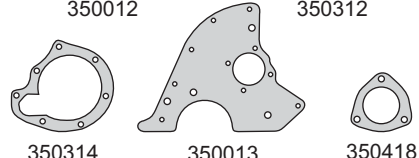

350012

350312



350314

350013

350418



350319

350327

350032

350033

350039

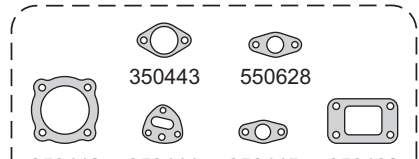

350441

350045

350946

350968

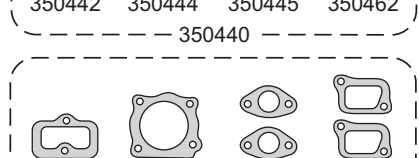

350442

350444

350445

350462

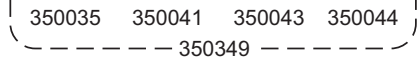

350035

350041

350043

350044

350349

**MERCEDES
BENZ**



Motor/Engine	Cm³	HP	Ø
OM 352A (OHV) 12V	5675	130	97
DIESEL			

Mercedes Benz: MB 1517 Turbo 0170, L911
L1518 1978/...



Nº OE	Descripción/Description	Mat.	Ref.
	Base compresor aire 94 mm.	NB	1 350463
	Tapa compresor aire 94 mm.	NFT	1 350464
	Jgo. juntas compresor aire 94 mm. (2)	VS	1 350465
	Jgo. juntas compresor aire reforma	VS	350466
	Tapa diferencial	NH	350467
	Palier	NH	350468
	Base bomba de agua	NB	1 350968
	Kit de gomas (19)	GS	1 350375
	Tapa filtro aceite	GS	350376
	Tapón goma	GS	350377
	Junta tapa cilindros competición		350490
0169978248	O'ring camisa inyector G 30.5 x 3.5	GS	6 6
	Tubo retorno G 6.4 x 13.8 x 8	GS	7 7
	O'ring G 114.5 x 5	GS	1
	O'ring G 13.5 x 2.5	GS	1
	O'ring G 28 x 2	GS	1
	O'ring G 61.8 x 3	GS	1
	O'ring G 8 x 2.4	GS	1
	O'ring G 95 x 104.2 x 3	GS	1
	Arandela A 10 x 14 x 1 A	AL	6
	Arandela A 14 x 18 x 1.5 A	AL	1
	Arandela A 16 x 22.5 x 1.5 A	AL	4
	Arandela A 18 x 24 x 1.5 A	AL	2
	Arandela A 22 x 27 x 1.5 A	AL	1
	Arandela A 24 x 32 x 1.5 A	AL	1
	Arandela A 14 x 20 x 1.5 A	AL	18
	Arandela A 8 x 12 x 1 Fe	F	16
	Arandela A 10 x 20 x 1 C	CU	6 6
	Arandela A 8 x 14 x 1 C	CU	10
	Arandela A 11 x 15 x 1 C	CU	4
	Arandela A 18 x 22 x 1.5 C	CU	3
	Arandela A 16 x 22 x 1.5 C	CU	2
	Arandela A 24 x 29 x 1.5 C	CU	1
	Arandela B 26 x 32 x 3 CN	CN	1
	Arandela B 24 x 32 x 3 CN	CN	1
	Arandela A 16 x 21 x 1.25 A	AL	4
	Arandela A 10 x 14 x 1.25 A	AL	6
	Arandela A 22 x 28 x 1.25 A	AL	1
	Arandela A 8 x 13 x 1 C	CU	6
3469970445	Jgo. retén válvulas (12)	P	R350210-2P
	Ret. banc. refor. expansible 90 x 106 x 7.5	S	R350211-1S
	Retén distribución 65 x 90 x 15	S	1 R350212S

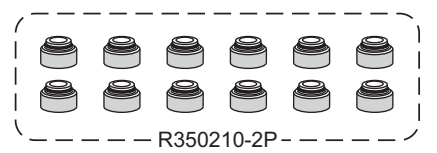
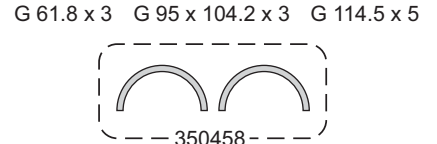
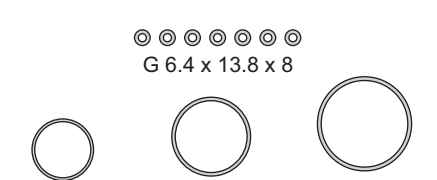
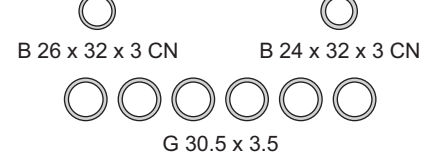
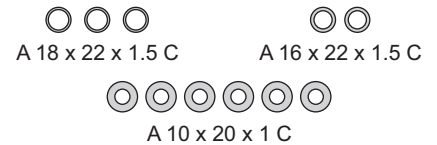
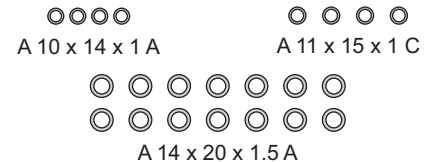
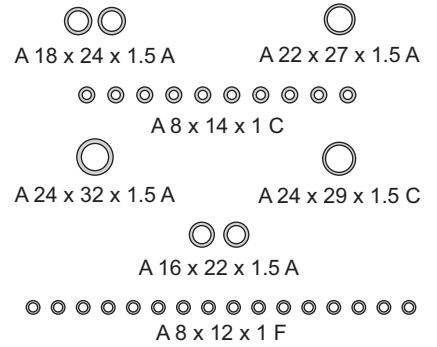
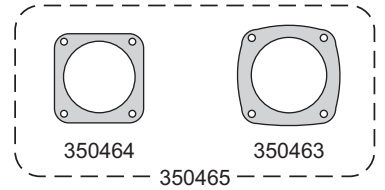
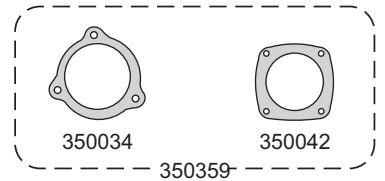

**MERCEDES
BENZ**



Motor/Engine	Cm³	HP	Ø
OM 355-5 (OHV) 20V	9650	84	128
DIESEL			

Mercedes Benz: MB 1521, 1526 1985/87



Nº OE	Descripción/Description	Mat.	Ref.
	Jgo. de juntas para motor		350600-R
3450160221	Junta tapa cilindros Ø 130.0 ± 1.30	NFT	350607-1
3460160320	Junta tapa cilindros Ø 130.0 ± 1.30	NFT	1 350607-2
3550160220	Junta tapa cilindros Ø 130.0 ± 1.30	NFT	1 350607-3
	Jgo. tornillos tapa cilindros (HAS19038)		B350600
3460160221	Junta tapa válvulas superior	NFT	5 350610
3562010180	Jgo. junta para cárter (4)	NB	1 350611
3460150120	Tapa distribución	CG	1 350612
3562010180	Cuerpo bomba de agua	NB	1 350614
3451427060	Múltiple escape	AC	5 350615
0664920080	Jgo. múltiple admisión (2)	NFT	1 350617
3551840480	Salida de escape	NFT	1 350718
3551840480	Termostato	NB	1 350619
3552010080	Bomba de aceite	NB	1 350627
3269970149	Cañería agua	NB	2 350629
0001846380	Cañería agua	NB	6 350630
3600770180	Arandela doble raccord A 8 x 12 x 1.5 C	CU	10 350032
3550150020	Junta tapa lateral válvulas	NB	1 350632
3560150121	Tacómetro	NB	1 350633
071511026008	Conducto de aceite	NB	1 350634
3600770180	Bomba inyectora	NB	2 350635
3550150020	Junta tapa válvulas lateral	NB	1 350636
3560150121	Tapa lateral cámara agua	NB	1 350637
3551880080	Cañería de aceite	NB	1 350638
071511040015	Compresor de aire a block	NB	1 350639
	Compresor de aire tapa válvulas	NB	1 350640
3530180180	Llenado aceite	CG	1 540041
	Compresor de aire entre cuerpo	NB	1 350641
3551880080	Bomba de aceite	NB	1 350642
071511040015	Entrada aire	NB	1 350643
	Bomba aceite	NB	1 350644
	Jgo. juntas compresor aire (3)	VS	1 350645
	Jgo. juntas caja de velocidades 1521	VS	350650
	Jgo. juntas caja de velocidades 1526	VS	350651
3520780080	Filtro de aceite		350657
	Jgo. empaquetadura cigüeñal (2)	SNA	350458
	Jgo. junta compresor turbo (5)	VS	1 590260
3030180079	Cañería aceite	NB	350662
	Junta turbina turbocompresor	AC	1 810162
	Junta base turbocompresor	AC	1 810163
	Junta retorno turbo	NB	1 810364
	Junta entrada aceite turbo	NB	1 810365
	Junta salida aceite turbo	NB	1 810366
	O'ring G 18 x 2	GS	1
3469970445	O'ring camisa inyector G 30 x 4	GS	6
	Arandela A 12 x 16 x 1.5 H	H	5
	Arandela A 8 x 17 x 1.5 H	H	18
	Arandela A 14 x 20 x 1.5 C	CU	12
	Arandela A 18 x 22 x 1.5 C	CU	2
	Arandela A 20 x 26 x 1.5 C	CU	2
	Arandela A 24 x 29 x 1.5 A	AL	2
	Arandela A 8.5 x 12 x 1.5 C	CU	10
	Arandela A 9.5 x 20 x 1 C	CU	5

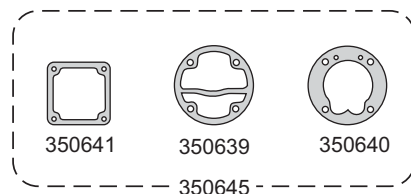
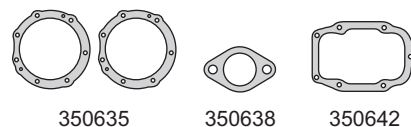
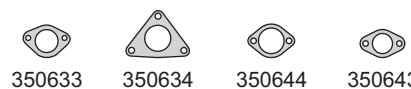
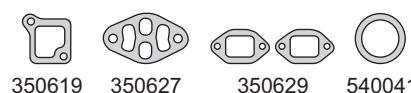
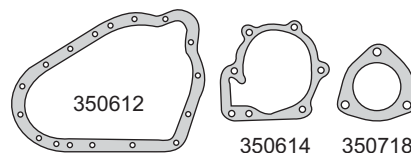
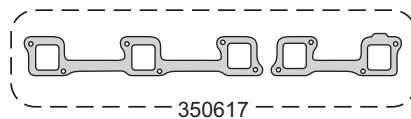
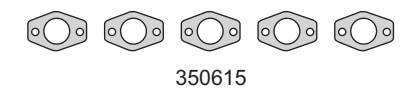
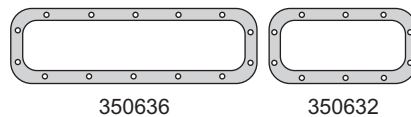
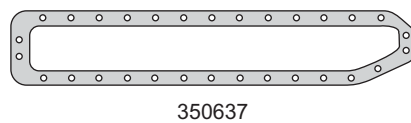
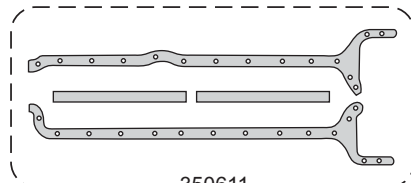
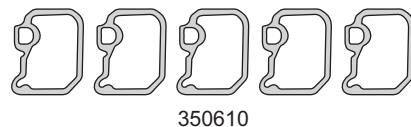
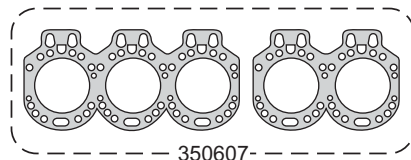

MERCEDES BENZ



Motor/Engine	Cm³	HP	Ø
OM 355-5 (OHV) 20V	9650	84	128
DIESEL			

Mercedes Benz: MB 1521, 1526 1985/87



Nº OE	Descripción/Description	Mat.	Ref.
	Arandela A 30 x 36 x 2 C	CU	1
	Arandela A 30 x 36 x 2 A	AL	2
	Arandela A 27 x 33.5 x 2 C	CU	1
	Arandela A 20 x 24 x 1.5 C	CU	1
	Arandela A16 x 22 x 1.5 C	CU	2
	O´ring G 44.5 x 57 x 14	GS	5
	O´ring G 48 x 62.5 x 16	GS	1
	O´ring G 23.5 x 3	GS	2
	O´ring G 28 x 2.5	GS	2
	O´ring G 59 x 4	GS	2
	Jgo. retén válvulas (20)	P	1 R350610P
	Retén distribución 75 x 100 x 12	S	1 R350612S

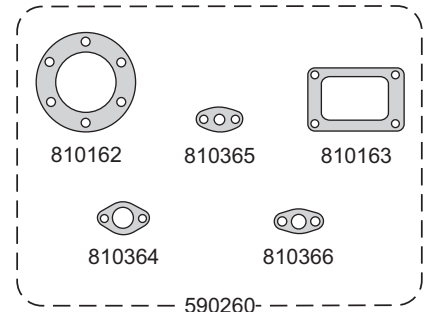

590260-

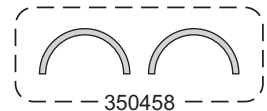
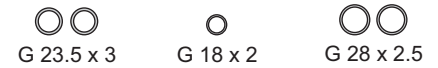
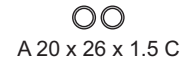
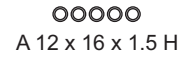
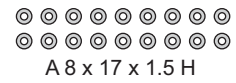
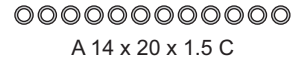

R350612S



R350610P-

**MERCEDES
BENZ**



Motor/Engine	Cm³	HP	Ø
OM 364 (OHV) 8V	3971	90/115	97.5
DIESEL			

Mercedes Benz: 711D, 811D, 609D
614D, 709D, 809D
OM364 Aspirado 1987/...



Nº OE	Descripción/Description	Mat.	Ref.
	Jgo. de juntas para motor		350800-R
3640160021	Jgo. de juntas para motor		350801-R
	Jgo. de juntas superior		350895
3640160320	Jta. tapa cilindros Ø 99.0 ± 1.40	NFT 1 1	350805
	Jta. tapa cilindros Ø 100.0 ± 1.40	NFT	350805-100
3640160320	Jta. tapa cilindros Ø 99.0 ± 1.40	NFT	350807
	Jgo. tornillos tapa cilindros (HAD19038)		B350100
3640101180	Junta tapa válvulas superior	NFT 1 1	350832
	Jgo. junta para cárter (4)	CG 1	350111
3660150020	Tapa distribución	NB 1	350312
3660150080	Placa distribución	NB 1	350013
3642010280	Bomba de agua	NB 1	350314
3661420180	Múltiple escape	AC 3 3	350815
3661410580	Múltiple admisión	NFT 2 2	350817
	Salida de escape	FCH	350818
3662030280	Caja termostato	NB 1 1	350919
3641040180	Base filtro aceite	NB 1	350127
3641840280	Base filtro aceite		350830
3520780080	Arandela tubería recuperación doble raccord	CU 4 4	350032
3640150180	Lateral a block	NB 1	350133
	Base compresor aire	NB 1	350034
4421870080	Tubería presión aceite	NB 1	350934
3640150160	Tapa lateral	GS 1	350836
	Junta refrigerador	NB	350837
	Base bomba combustible	NB 1	350839
3469970445	O'ring camisa inyector G 30.8 x 3.7	GS 4 4	350840
	Tapa termostato	NB 1 1	350041
	Anillo retorno inyector G 6.4 x 13.8 x 7.8	GS 5 5	350841
3662030380	Cañería agua a tapa	NB 2 3	350043
3660180380	Brida cárter sobrealimentador	NB	350444
	Soporte bomba inyectora	NB 1	350045
4421870180	Tubería retorno aceite	NB	350445
	Cierre distribución	CG 1	350946
	Jgo. empaquetadura cigüeñal	SNA 1	350458
	Jgo. junta para cárter (3)	CGT	350860
	Base compresor aire	NB	350463
3521310280	Tapa compresor aire	NFT 1	350464
	Jgo. juntas compresor aire (2)	VS	350465
	Arandela A 10 x 20 x 1 C	CU 4 4	
	Arandela A 16 x 22 x 1.5 A	AL 2 2	
	Arandela A 20 x 24 x 1.5 C	CU 1	
	Arandela A 20 x 24 x 1.5 A	AL 1	
	Arandela A 24 x 32 x 2 A	AL 1	
	Arandela A 8 x 14 x 1 C	CU 6 5	
	Arandela A 26 x 32 x 2 A	AL 1 1	
	O'ring G 13.94 x 2.62	GS 3	
	Jgo. retén válvulas (8)	P	R350110P
	Retén distribución 65 x 90 x 15	S 1	R350212S

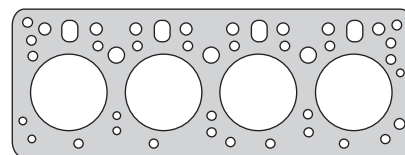

350805

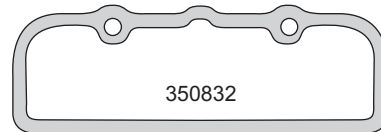

350832

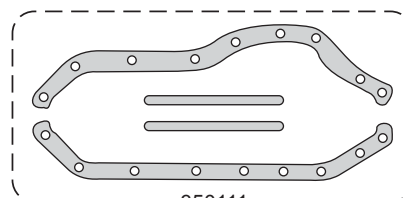

350111

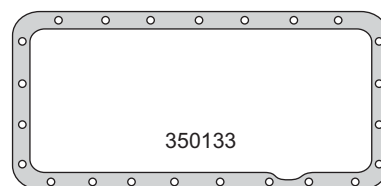

350133



350836

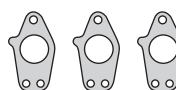

350815

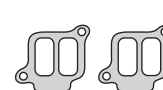

350817

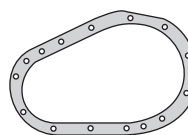

350312

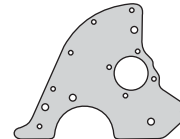

350013



350314



350818



350919



350127



350830



350032



350934



350839

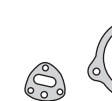

350444



350034



350041



350043



350045



350464



350463



350946



350465



R350212S



350458



R350110P

MERCEDES BENZ



Motor/Engine	Cm³	HP	Ø
OM 366	5957	138	97.50
OM 366A/LA	5957	170	97.50

Mercedes Benz: Euro Ecológico OH1215/1315
 1316/1319/1320/1420/1615
 Aspirado Turbo 1620, OHL1621,
 OS1318, L1915
 1314/1318/1365
 2018/3611R
 2214/2217



DIESEL

Nº OE	Descripción/Description	Mat.	Ref.
	Jgo. de juntas para motor		350900-R
3660160220	Jgo. de juntas para motor		350901-R
	Jgo. de juntas superior		350995
3660160220	Jta. tapa cilindros Ø 98.5 ± 1.40		350405
3660160220	Jta. tapa cilindros Ø 98.5 ± 1.30	NFT 1 1	350407
	Jgo. tornillos tapa cilindros (HAD19038)		B350300
3660160021	Junta tapa válvulas superior	NFT 1 1	350932
	Jgo. junta para cárter (4)	CGT 1	350960
3660150020	Tapa distribución	NB 1	350912
3660150080	Placa distribución	NB 1	350013
3642010280	Bomba de agua	NB 1	350314
3661420180	Múltiple escape	AC 4 4	350815
3661410580	Múltiple admisión	NFT 3 3	350817
	Salida de escape	FCH 1 1	350918
3662030280	Caja termostato	NB 1 1	350919
	Base bomba nafta	NB 1	550628
3662010180	Bomba agua a block	NH 1	350929
3760157217	Tapa distribución OM 366 LA	NB 1	350931
3520780080	Arandela doble raccord	CU 6 6	350032
3661840080	Filtro aceite a block	NB 1	350933
4421870180	Tubería presión aceite	NB 1	350934
3520150160	Tapa lateral	GS 1	350936
3661880780	Refrigerador aceite a block	NB 1	350937
3621881479	Tapa refrigerador aceite	NB 1	350938
0090911280	Base bomba combustible	NB 1	350839
3121881579	Arandela radiador aceite	NB 16	350040
0169978248	O'ring camisa inyector G 30.5 x 3.5	GS 6 6	350840
	Jgo. juntas sobrealimentador OM 366		350940
	Anillo retorno inyector G 5.4 x 13.8 x 7.8	GS 7 7	350841
	O'ring termostato base G 34 x 3	GS 2	350941
	Codo turbina	AC 1	350442
	Tapa distribución euro ecológico 00/...	NB	350942
3662030380	Cañería agua a tapa	NB 1 1	350043
	Codo admisión	NB 1 1	350443
	Cañería agua	NB 2 2	350943
3660180380	Brida cárter sobrealimentador	NB 1	350444
	Codo admisión	NB 1 1	350944
	Soporte bomba inyectora	NB 1	350045
4421870080	Cañería retorno aceite	NB	350445
	Jgo. juntas radiador aceite (18)	NB 1	350945
3520150480	Cierre distribución	CG 1	350946
	Kit arandelas (83)	CU 1	350347
	O'ring tapa termostato G 61.8 x 3	NB 1 1	350947
6004920080	Acople escape	FCH 1 1	350948
	Jgo. empaquetaduras cigüeñal	SNA 1	350458
3520140922	Jgo. junta para cárter (2)	CGT	350060
3520980208	Colector a escape turbo	AC 1 1	350462
3521310280	Base compresor aire	NB 1	350463
	Tapa compresor aire	NFT 1	350464
	Jgo. juntas compresor aire 90 (2)	VS 1	350465
	O'ring termostato G 60 x 4	GS 1 1	350965
	Bomba agua block	NB 1	350968
	Kit de gomas (28)	GS 1	350975

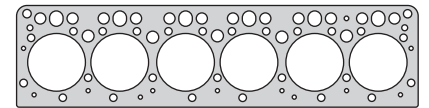

350407



350932

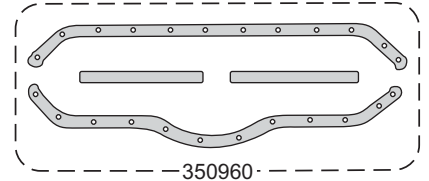

350960



350936

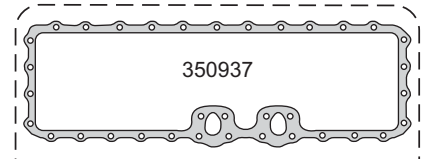

350937

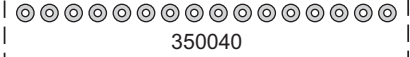

350040

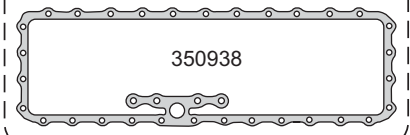

350938

350945

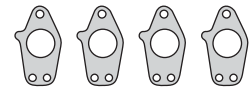

350815

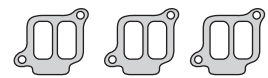

350817

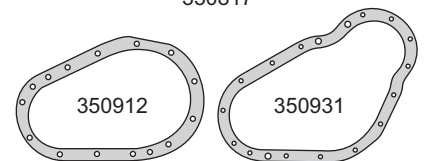

350912

350931

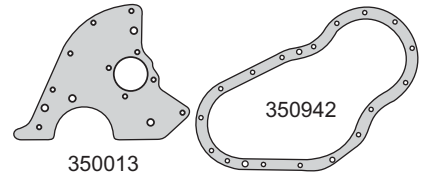

350013

350942

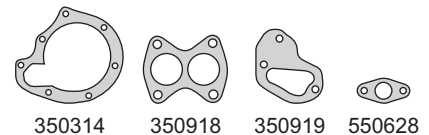

350314

350918

350919

550628

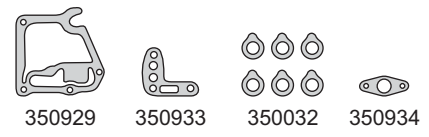

350929

350933

350032

350934

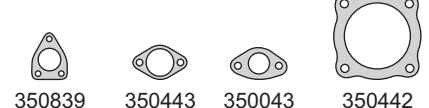

350839

350443

350043

350442

**MERCEDES
BENZ**



Motor/Engine	Cm³	HP	Ø
OM 366	5957	138	97.50
OM 366A/LA	5957	170	97.50

Mercedes Benz: Euro Ecológico OH1215/1315
1316/1319/1320/1420/1615
Aspirado Turbo 1620, OHL1621,
OS1318, L1915
1314/1318/1365
2018/3611R
2214/2217



DIESEL

Nº OE	Descripción/Description	Mat.		Ref.
	Tapa filtro aceite	GS	1	350376
	O´ring G 26.64 x 2.62	GS	1	
	O´ring G 119 x 3	GS	1	
3469970445	O´ring G 101 x 4	GS	1	
	O´ring G 28.2 x 2.5	GS	1	
	O´ring G 13.5 x 2.5	GS	1	
	O´ring G 33.5 x 4.2	GS	2	
	O´ring G 45 x 4	GS	2	
	O´ring G 61.8 x 3	GS	1	
	O´ring G 8 x 2.4	GS	4	
	O´ring G 75 x 3	GS	1	
	Arandela A 10 x 14 x 1 A	AL	6	6
	Arandela A 10 x 20 x 1 C	CU	6	6
	Arandela A 11 x 15 x 1 C	CU		4
	Arandela A 14 x 20 x 1.5 A	AL		18
	Arandela A 14 x 18 x 1.5 A	AL		1
	Arandela A 16 x 22 x 1.5 C	CU		2
	Arandela A 16 x 22.5 x 1.5 A	AL	4	4
	Arandela A 18 x 24 x 1.5 A	AL		2
	Arandela A 18 x 22 x 1.5 C	CU		3
	Arandela A 22 x 27 x 1.5 A	AL	1	1
	Arandela A 24 x 29 x 1.5 C	CU		1
	Arandela A 24 x 32 x 1.5 A	AL		1
	Arandela A 8 x 12 x 1 FE	FE		16
	Arandela A 8 x 14 x 1 C	CU	6	10
	Arandela B 26 x 32 x 3 CN	CN		1
	Arandela B 24 x 32 x 3 CN	CN		1
	Jgo. retén válvulas (12)	P		R350210P
	Retén distribución 65 x 90 x 15	S	1	R350212S

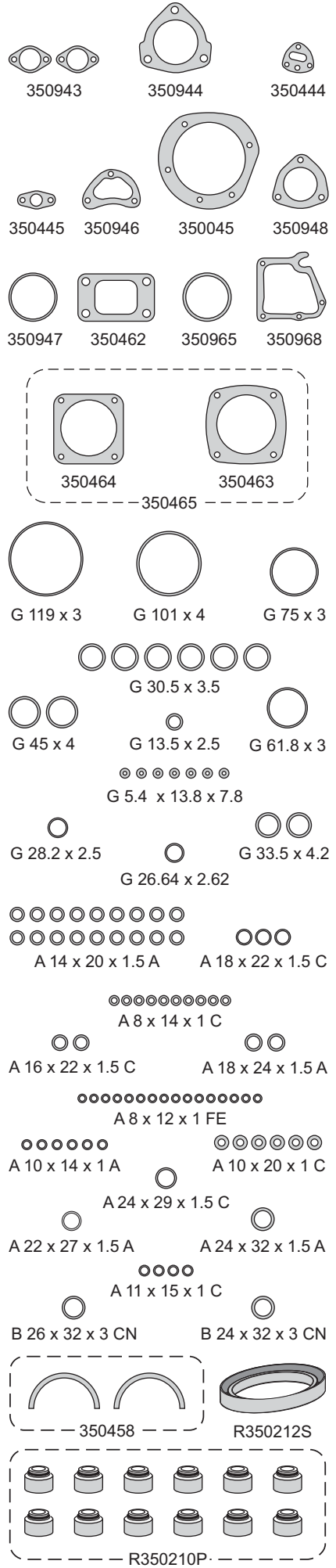

**MERCEDES
BENZ**



Motor/Engine	Cm³	HP	Ø
OM 904 LA	4250	75/125	102
OM 904 LA IMO (OHV) 12V Electrónico	4250	75/125	102

Mercedes Benz: Vario 614/814/815/810
Atego 712/714/715/717/720/812
814/815/817/917/1017/1214
1215/1217/1317
1517



DIESEL

Nº OE	Descripción/Description	Mat.	Ref.
9040102220	Jgo. de juntas para motor		351000-R
	Jgo. de juntas superior		351095
9040160620	Jta. tapa cilindros Ø 104.0 \pm 1.30	NFT	1 1 351007
9040161120	Jta. tapa cilindros Ø 103.5 \pm 1.20	MLS	351008
	Jgo. tornillos tapa cilindros (HAD19038)		B351000
9040160621	Conj. junta tapa válvulas (6)	N	1 351010
9040140622	Junta para cárter	NB	1 351011
9062010080	Bomba de agua	NB	1 351014
9061420280	Jgo. múltiple escape (2)	AC	1 1 351015
9061410180	Jgo. múltiple admisión (2)	SLS	1 1 351017
9062030180	Junta tuboladora bomba de agua	NB	1 351019
9061840280	Filtro aceite a block	GS	1 351027
9060910380	Base bomba combustible	SLS	1 351028
0020941580	Filtro combutible	GS	1 351031
0000160421	Conj. junta tapa válvulas (plástico) (6)	GS	1 1 351032
	Arandela tapa válvulas	GS	5 5 351033
	Junta lateral tapa de válvulas	GS	1 351036
0001883280	Tapa refrigerador aceite	GS	1 351037
9041880280	Radiador aceite	NB	1 351038
9060980480	Tubo aire sobrealimentador	SLS	1 351039
0800180480	Difusor aceite en tapa válvula		351040
	Junta turbo	AC	351042
	Junta turbo	NB	351044
	Junta turbo	AC	351045
6703510085	Tapa diferencial (CE)	CG	350159
	Junta asiento delgas compresor	NFT	1 351062
	Junta tapa válvulas compresor	NFT	1 351063
	Junta tapa cilindros compresor	AL	1 351064
00013658015	Jgo. juntas compresor (5)	VS	1 351065
	Jgo. juntas turbo (5)	VS	1 351068
	Junta tapa cilindros	MLS	351090
	Arandela A 12 x 18 x 1 C	CU	1
	Arandela A 10 x 14 x 1 C	CU	1
	O'ring compresor G 88.57 x 2.62	GS	1
	O'ring compresor G 117.07 x 3.53	GS	1
	Kit de retenes completo		R351000
	Jgo. retén válvulas (12)	V	1 R351010V
	Retén bancada 115 x 140 x 13	VF	1 R351011VF
	Retén distribución 78 x 104 x 11	VF	1 R351012VF

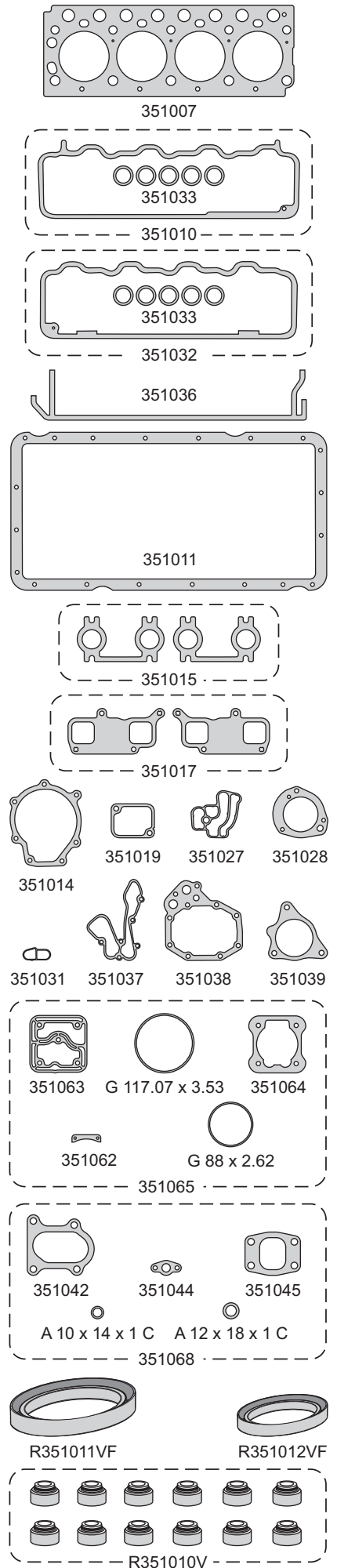

MERCEDES BENZ



Motor/Engine	Cm³	HP	Ø
OM906 LA OM906.911/919 920/921/922/923 (OHV) 18V Electrónico	6370	231 245/279	102
DIESEL			

Mercedes Benz: Atego I 925/1225/1228/1325
1328/1525/1528/1823/1828
2523/2528/2628 1998/...



Nº OE	Descripción/Description	Mat.	Ref.
	Jgo. de juntas para motor		352000-R
9060101721	Jgo. de juntas superior	●	352095
9060161220	Jta. tapa cilindros Ø 103.5 \pm 1.30	MLS 1	352008
9060160769	Jgo. tornillos tapa cilindros (HAD19038)		B352000
9060160621	Conj. junta tapa válvulas (7)	GS 1	352010
9060140422	Junta para cárter	NB 1	352011
9062010080	Bomba de agua	NB 1	351014
9061400280	Jgo. múltiple escape (3) 351015/1	AC 1	352015
9061410480	Jgo. múltiple admisión (3) 351017/1	SLS 1	352017
9062030180	Junta tubuladora bomba de agua	NB 1	351019
9061840280	Junta filtro aceite a block	GS 1	351027
9060910780	Junta base bomba combustible	SLS 1	351028
0020941580	Junta filtro combustible	GS 1	351031
0000160521	Conj. junta tapa válvulas (8)	GS 1	352032
9060160080	Arandelas especiales tapa de válvulas	AC/GS 6	351033
9063320080	Junta adaptador superior volante		352034
	Junta lateral tapa de válvulas	GS 1	352036
4420150980	Junta inspección inferior volante		352037
9061880280	Junta radiador aceite	NB 1	352038
0000180133	Junta especial diafragma tapa de válvulas	GS	352039
	Junta tapa cilindros importada	MLS	352090
0249972148	O´ring G 117.07 x 3.53	GS 1	
0289975648	O´ring G 39.34 x 2.62	GS 6	
0289975648	O´ring G 36.17 x 2.62	GS 6	
0239976848	O´ring G 9.19 x 2.62	GS 6	
	O´ring G 16 x 4	GS 1	
	Arandela A 20 x 26 x 1.5 C	CU 1	
	Arandela A 18 x 24 x 1.5 C	CU 1	
	Arandela A 16 x 22 x 1.5 A	AL 1	
	Arandela A 14 x 20 x 1.5 A	AL 1	
	Arandela inyector A 10 x 14 x 1 C	CU 6	
	Kit de retenes completo		R352000
3660530058	Jgo. retén válvulas (18)	V 1	R352010V
0229977647	Retén distribución 78 x 104 x 11	VF 1	R351012VF
0259975047	Retén bancada 115 x 140 x 13	VF 1	R351011VF

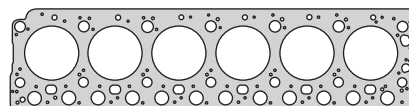

352008

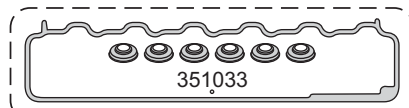

351033

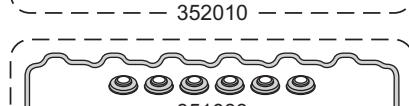

352010

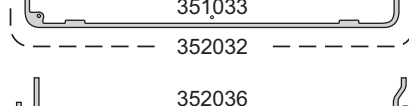

351033

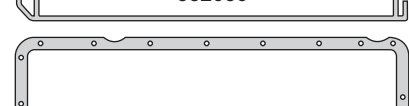

352032



352036

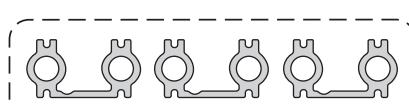

352011

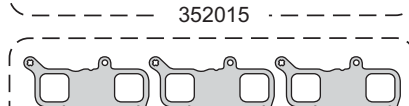

352015



352017



351014

351019

351027

351028

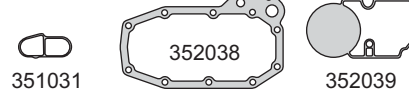

351031

352038

352039

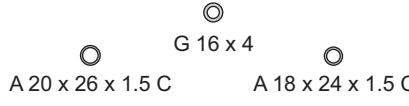

G 16 x 4

A 20 x 26 x 1.5 C

A 18 x 24 x 1.5 C

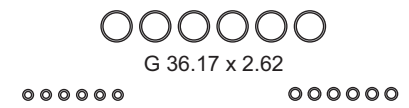

G 36.17 x 2.62

G 9.19 x 2.62

A 10 x 14 x 1 C



G 39.34 x 2.62

A 16 x 22 x 1.5 A

A 14 x 20 x 1.5 A



G 117.07 x 3.53



R351012VF

R351011VF



R352010V

MERCEDES BENZ

taranto

Motor/Engine **Cm³** **HP** **Ø**
OM 352 **5675** **130** **97**
OM 352A Turbo **5675** **156** **97**
 (OHV) 12V

Mercedes Benz: MB 1518 1991/... Motor Híbrido
 Con junta tapa lateral de goma

DIESEL



Nº OE	Descripción/Description	Mat.	Ref.
	Jgo. de juntas para motor	●	352200-R
3660160220	Jta. tapa cilindros Ø 98.5 ± 1.40	NFT	350405
3660160220	Jta. tapa cilindros Ø 98.5 ± 1.30	NFT	1 350407
	Jgo. tornillos tapa cilindros (HAD19038)		B350300
3525860301	Jgo. junta para cárter (4)	CG	1 350011
3520150320	Tapa distribución	NB	1 350312
3120150580	Placa distribución	NB	1 350013
3522010480	Tapa bomba de agua	NB	1 350314
	Jgo. múltiple escape (2)	AC	1 350415
	Salida de escape	FCH	1 350418
3522010980	Placa bomba de agua	NB	1 350319
	Junta bomba de agua	NB	1 352219
	Base bomba nafta	NB	1 550628
3520780080	Arandela doble raccord	CU	6 350032
3520160421	Junta tapa válvulas	NFT	1 350332
3271840280	Filtro aceite a block	NB	1 350033
3211310079	Base compresor aire 77 mm.	NB	1 350034
	Junta tubería aceite	NB	1 350934
3522030480	Carcaza termostato	NB	1 350035
3520150160	Junta tapa lateral	GS	1 350936
3661880780	Refrigerador aceite a block	NB	1 350937
3121881479	Tapa refrigerador aceite superior	NB	1 350038
	Arandela radiador aceite	NB	16 350040
	Jgo. juntas sobrealimentador GARRET (5)	VS	1 350440
3522030780	Tapa carcaza termostato	NB	1 350041
	Entrada aceite turbo	NB	1 350441
	Junta vaso bomba combustible	CG	1 540041
3211310279	Cabeza cilindro compresor	NB	1 350042
3520980880	Turbina a codo colector	AC	1 350442
3522030680	Galería superior agua	NB	2 350043
3520980580	Codo admisión	NB	1 350443
3522030080	Galería inferior agua	NB	2 350044
3520180380	Brida cárter sobrealimentador	NB	1 350444
	Codo admisión	NB	1 350944
3520760279	Soporte bomba inyectora	NB	1 350045
3521870080	Cañería retorno aceite	NB	1 350445
3520150480	Cierre distribución	CG	1 350946
	Kit de arandelas (83)	VS	1 350347
3525860301	Jgo. juntas cañería refrigeración (6)	VS	1 350349
	Jgo. empaquetadura cigüeñal (2)	SNA	1 350458
3525860301	Jgo. juntas compresor aire 77 mm. (2)	VS	1 350359
	Jgo. junta para cárter (2)	CGT	1 350060
	Colector a escape turbo	AC	1 350462
	Base compresor aire 94 mm.	NB	1 350463
	Tapa compresor aire 94 mm.	NFT	1 350464
	Jgo. juntas compresor aire 94 mm. (2)	VS	1 350465
	Base bomba de agua	NB	1 350968
	Kit de gomas (19)	GS	1 350375
0169978248	O'ring camisa inyector G 30.5 x 3.5	GS	6
	Tubo retorno G 6.4 x 13.8 x 8	GS	7
	O'ring G 114.5 x 5	GS	1
	O'ring G 13.5 x 2.5	GS	1
	O'ring G 28 x 2	GS	1

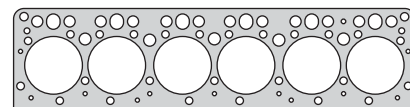

350407

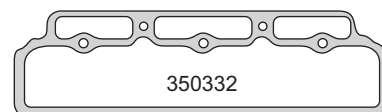

350332

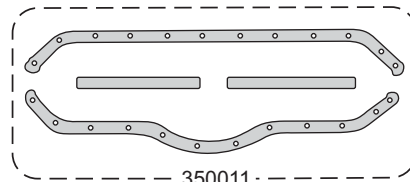

350011

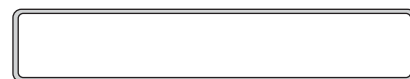

350936

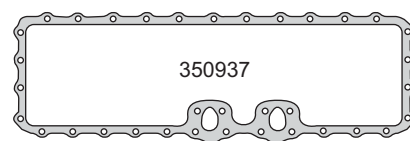

350937

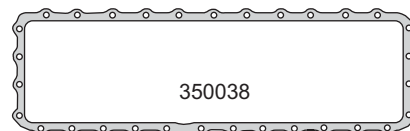

350038

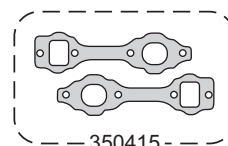

350415

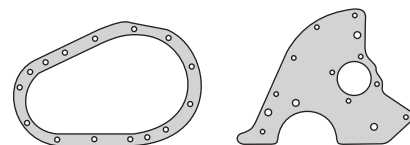

350312

350013



350314

350418

350319

352219

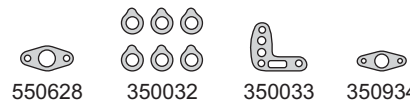

550628

350032

350033

350934

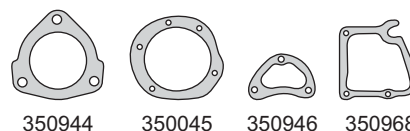

350944

350045

350946

350968

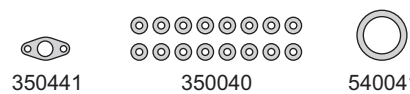

350441

350040

540041

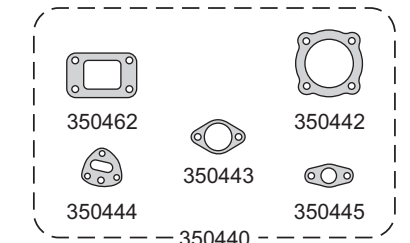

350462

350442

350443

350444

350445

350440

MERCEDES BENZ



Motor/Engine	Cm³	HP	Ø
OM 352	5675	130	97
OM 352A Turbo (OHV) 12V	5675	156	97

Mercedes Benz: MB 1518 1991/... Motor Híbrido
Con junta tapa lateral de goma



DIESEL

Nº OE	Descripción/Description	Mat.	Ref.
	O´ring G 61.8 x 3	GS	1
	O´ring G 8 x 2.4	GS	1
	O´ring G 95 x 104.2 x 3	GS	1
	Arandela A 10 x 14 x 1 A	AL	6
	Arandela A 18 x 24 x 1.5 A	AL	2
	Arandela A 22 x 27 x 1.5 A	AL	1
	Arandela A 24 x 32 x 1.5 A	AL	1
	Arandela A 14 x 20 x 1.5 A	AL	18
	Arandela A 8 x 12 x 1 Fe	FE	16
	Arandela A 10 x 20 x 1 C	CU	6
	Arandela A 8 x 14 x 1 C	CU	10
	Arandela A 11 x 15 x 1 C	CU	4
	Arandela A 14 x 18 x 1.5 A	AL	1
	Arandela A 16 x 22.5 x 1.5 A	AL	4
	Arandela A 18 x 22 x 1.5 C	CU	3
	Arandela A 16 x 22 x 1.5 C	CU	2
	Arandela A 24 x 29 x 1.5 C	CU	1
	Arandela B 26 x 32 x 3 CN	CN	1
	Arandela B 24 x 32 x 3 CN	CN	1
3469970445	Jgo. retén válvulas (12)	P	R350210P
	Retén distribución 65 x 90 x 15	S	R350212S

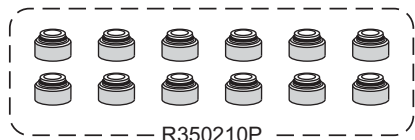
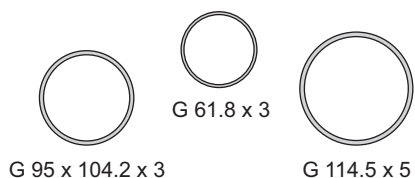
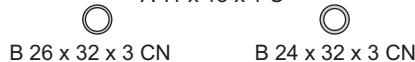
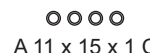
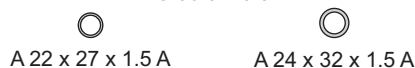
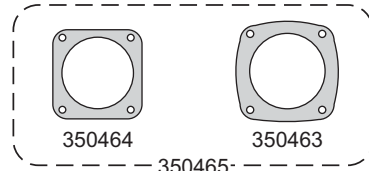
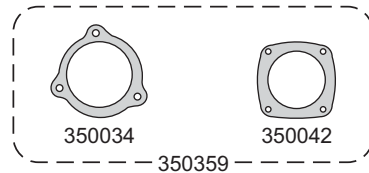
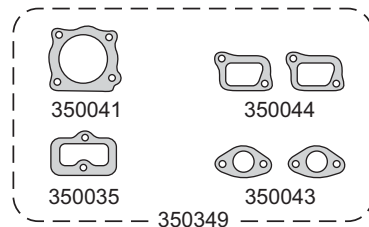

MERCEDES BENZ

taranto





















Motor/Engine  **Cm³** **HP** **Ø**

OM 449A/LA/HLA **9973** **180/200** **128**
(OHV) 10V

Mercedes Benz: 1630, 1632, 1633, MB485.980
MB489.960/961, MB475.907/950
MB954/976/979/982/984/986
989/991/994/997
998



DIESEL

Nº OE	Descripción/Description	Mat.	Ref.
	Jgo. de juntas para motor 		● 360000-R
	Jgo. de juntas para motor 		360001-R
	Jgo. de juntas superior (1 cilindro) 	●	360095-R
	Jgo. de juntas superior (1 cilindro) 		360095
4220160420	Jta. tapa cilindros Ø143.5 ± 1.30  N.R. 	ACG 1 5	360008 B360000
4030160321	Junta tapa válvulas superior 	NB 1 5	360010
4050140222	Jgo. junta para cárter (4) 	NB 1	360011
4290150080	Tapa distribución 	NB 1	360012
4030110080	Tapa delantera block 	NB 1	360013
4032011080	Bomba de agua 	NB 1	360014
40314220380	Múltiple escape 	AC 1 5	360015
4421410480	Múltiple admisión 	NFT 1 5	360017
4071310880	Tapa compresor 0.80	NB 1	360027
4071310880	Tapa compresor 0.50	NB 1	360027/1
	Tapa compresor	NB 1	360327
	Base bomba nafta	NB 1	550628
4422010480	Bomba de agua 	NB 1	360029
917003040003	Acople lateral	NB 1	360030
917003036002	Base bomba aceite	NB 1	360030/1
4030180180	Llenado cárter	NB 1	360031
6171870180	Entrada aceite	NB 1	360032
	Pico inyector	GS	360033
4031840280	Refrigerador aceite	NB 1	360038
4031310780	Carcasa inferior compresor superior	NB 1	360039
4071310780	Tapa compresor	NB 1	360040
4750880280	Colector admisión	NB 1	360041
4750980380	Admisión entrada	NB 1	360042
917003026000	Refrigerador aceite	NB 2	360043
3521870080	Codo admisión	NB 1	350443
3520980580	Salida aceite	NB	350445
4750150180	Cierre distribución	CG 1	360046
007603026305	Arandela tapón cárter A 26 x 34 x 2 A	AL 1	360048
	Arandela A 10 x 20 x 1 C	CU 1	
4230110284	Suplemento camisa cilindros - 1 boca (0.08) 	CHA	360070-0.08
4230110084	Suplemento camisa cilindros - 1 boca (0.10) 	CHA	360070-0.10
4230110184	Suplemento camisa cilindros - 1 boca (0.15) 	CHA	360070-0.15
	Kit de retenes completo 		R360000
	Jgo. retén válvulas (10)	P 1 1	R360010-1P
0139971447	Retén bancada 120 x 140 x 13 	V 1	R360011V
0149974647	Retén distribución 105 x 130 x 12 	V 1	R360012V

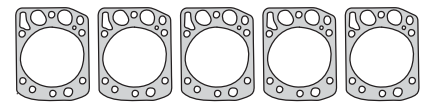

360008



360010

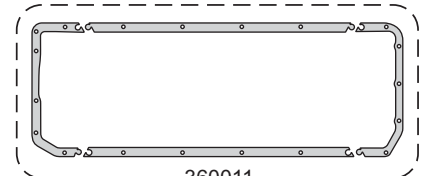

360011

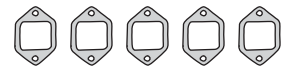

360015



360017

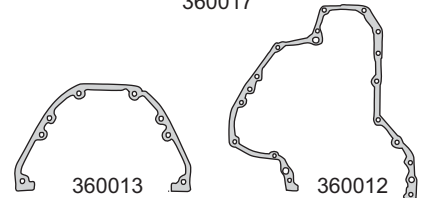

360013

360012

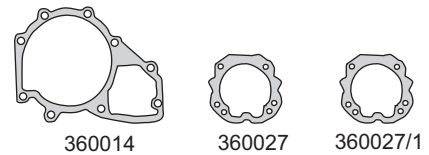

360014

360027

360027/1

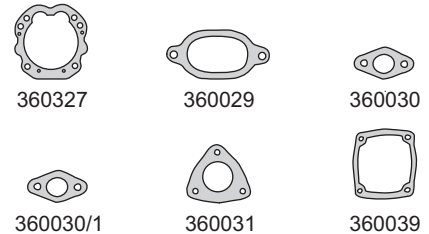

360327

360029

360030

360030/1

360031

360039

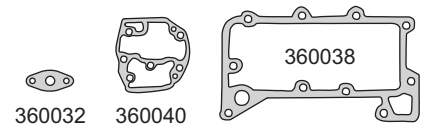

360032

360040

360038

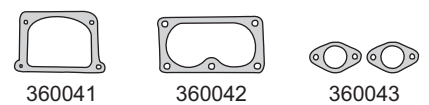

360041

360042

360043

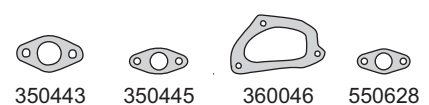

350443

350445

360046

550628



A 26 x 34 x 2 A

A 10 x 20 x 1 C



R360011V

R360012V

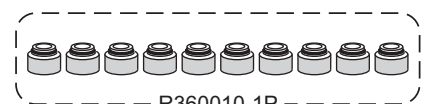

R360010-1P

MERCEDES BENZ



Motor/Engine	Cm³	HP	Ø
OM 616.912	2404	65	91
OM 616.934/960	2404	65	91
OM 616.916/940	2404	72	91
OM 616.961/963 (SOHC) 8V	2404	72	91

Mercedes Benz: 240D/TD 1973/..., 207/307D 407/507/510D, L406/407DG 0309D 1977/..., 240GD 76/87 MB100/200/300/400/180D MB150/170



DIESEL

Nº OE	Descripción/Description	Mat.	Ref.
	Jgo. de juntas para motor		360100-R
6210100321	Junta tapa cilindros Ø 92.0 ± 1.70	NFT 1	360107
	Jgo. tornillos tapa cilindros (HAN12100/12055)		B360100
6150160080	Junta tapa válvulas	N 1	360110
	Jgo. junta para cárter (3)	NB 1	360111
6211421180	Múltiple admisión y escape	NFT 1	360116
	Base filtro aceite	NB 1	360128
	Intercambiador	NB 1	360129
	Bomba hidráulica	NB 1	360130
	Bomba vacío	NB 2	360131
	Termostato	NB 1	360132
	Tensor hidráulico	NB 1	360133
	Acople termostato	NB 1	360134
	Junta	NB 1	360135
	Cuerpo aceite	NB 1	360137
	Junta	NB 1	360138
	Junta	NB 1	360139
	Junta	NB 1	360140
0019971241	Retén cigüeñal	SNA 1	360158
	Arandela A 28 x 34 x 1.5 A	AL 4	
	Arandela A 26 x 32 x 2 A	AL 2	
	Arandela A 14 x 18 x 1.5 A	AL 1	
	O'ring G 25.07 x 2.62	GS 1	
	O'ring G 7.59 x 2.62	GS 1	
	O'ring G 6.07 x 1.78	GS 2	
	Kit de retenes completo		R360100
	Jgo. retén válvulas (8)	P 1	R360110P
0119972247	Retén distribución 45 x 74.5/79.5 x 12/14.5	P 1	R360112P

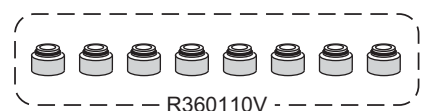
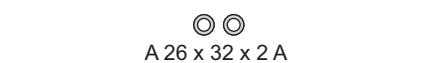
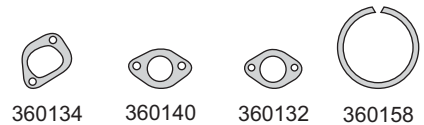
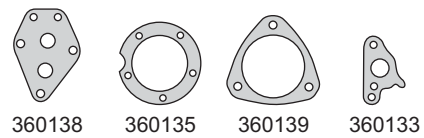
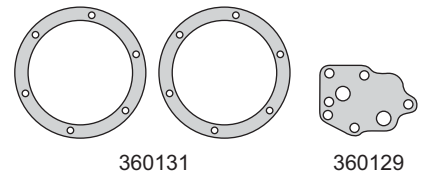
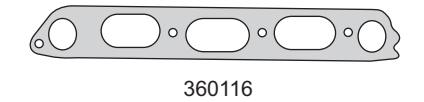
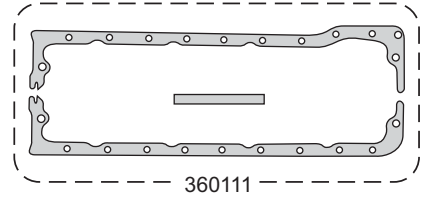
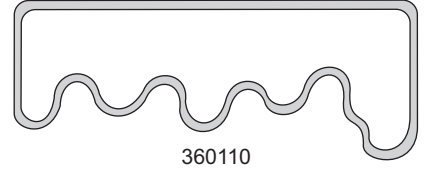
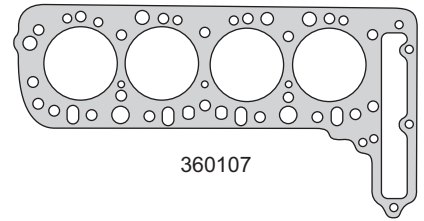

**MERCEDES
BENZ****taranto**

Motor/Engine	Cm³	HP	Ø
OM352	5675	131	97
OM352A (OHV) 12V	5675	156	97

Mercedes Benz: Turbinado, Aspirado 1981/...

DIESEL

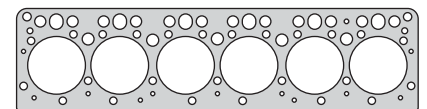

350405



350332

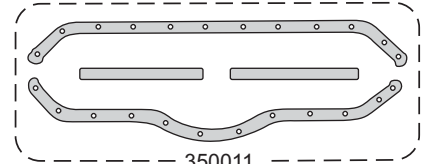

350011



350936

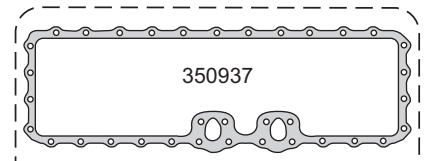

350937



350040

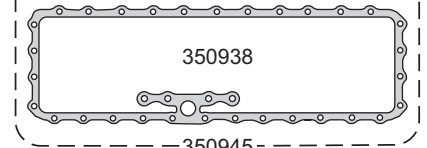

350938



350945

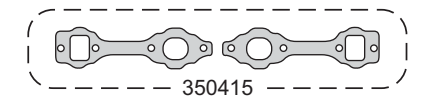

350415

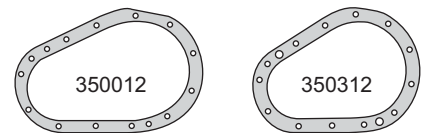

350012

350312



350314

350013

350319

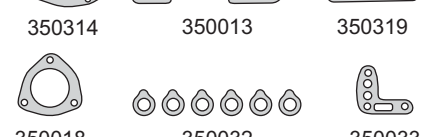

350018

350032

350033

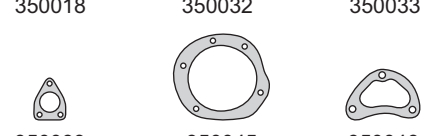

350039

350045

350046

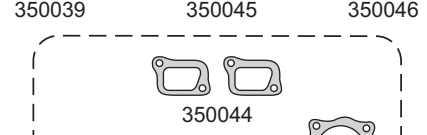

350044

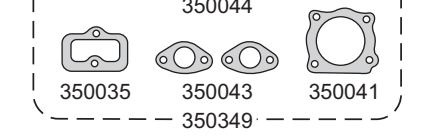

350035

350043

350041

350349

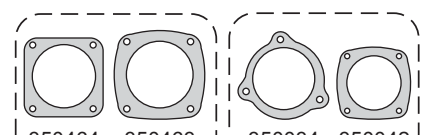

350464

350463

350034

350042

350465

350359

Nº OE	Descripción/Description	Mat.	Ref.
	Jgo. de juntas para motor		360200
	Junta tapa cilindros Ø 98.5 ± 1.40	NFT 1	350405
	Junta tapa cilindros Ø 98.5 ± 1.30	NFT 1	350407
	Jgo. tornillos tapa cilindros (HAD19038)		B350300
	Jgo. junta para cárter (4)	CG 1	350011
	Tapa distribución	CG 1	350012
	Tapa distribución	NB 1	350312
	Placa distribución	NB 1	350013
	Bomba de agua	NB 1	350314
	Jgo. múltiple escape (2)	AC 1	350415
	Salida de escape	FCH 1	350018
	Placa bomba de agua	NB 1	350319
	Junta tapa válvulas	NFT 1	350332
	Arandela doble raccord A 8 x 12 x 1.5 C	CU 6	350032
	Filtro aceite a block	NB 1	350033
	Junta cilindro compresor aire	NB 1	350034
	Carcaza termostato	NB 1	350035
	Lateral botadores	GS 1	350936
	Refrigerador aceite block	NB 1	350937
	Tapa refrigerador aceite	NB 1	350938
	Base bomba combustible	NB 1	350039
	Arandela radiador aceite	NB 16	350040
	Tapa carcaza termostato	NB 1	350041
	Junta cabeza cilindro compresor	NB 1	350042
	Galería superior agua	NB 2	350043
	Galería inferior agua	NB 2	350044
	Soporte bomba inyectora	NB 1	350045
	Jgo. juntas radiador aceite (18)	VS 1	350945
	Cierre distribución	CG 1	350046
	Kit arandelas (71)	VS 1	350347
	Jgo. juntas cañería refrigeración (6)	VS 1	350349
	Jgo. juntas compresor aire 77 mm. (2)	VS 1	350359
	Jgo. juntas para cárter (2)	CGT 1	350060
	Base compresor 0.4 mm	NB 1	350463
	Tapa compresor aire 94 mm.	NFT 1	350464
	Jgo. juntas compresor aire 94 mm. (2)	VS 1	350465
	Arandela A 10 x 14 x 1 A	AL 6	
	Arandela A 10 x 20 x 1 C	CU 6	
	Arandela A 11 x 15 x 1 C	CU 4	
	Arandela A 14 x 20 x 1.5 A	AL 18	
	Arandela A 16 x 22 x 1.5 C	CU 2	
	Arandela A 18 x 24 x 1.5 A	AL 2	
	Arandela A 18 x 22 x 1.5 C	CU 3	
	Arandela A 22 x 27 x 1.5 A	AL 1	
	Arandela A 24 x 29 x 1.5 C	CU 1	
	Arandela A 24 x 32 x 1.5 A	AL 1	
	Arandela A 8 x 12 x 1 FE	FE 16	
	Arandela A 8 x 14 x 1 C	CU 10	
	Arandela A 14 x 18 x 1.5 A	AL 1	
	Arandela A 16 x 22.5 x 1.5 A	AL 4	
	Arandela B 26 x 32 x 3 CN	CN 1	
	Arandela B 24 x 32 x 3 CN	CN 1	

**MERCEDES
BENZ**



Motor/Engine	Cm³	HP	Ø
OM 447-6 (OHV) 12V	11967	250/300	128
DIESEL			

Mercedes Benz: O372, O400, L1395
1939, 1941 1973/...



Nº OE	Descripción/Description	Mat.	Ref.
	Jgo. de juntas para motor	●	360300-R
	Jgo. de juntas para motor		360300
	Jgo. de juntas para motor		360301-R
4220160420	Junta tapa cilindros Ø 143.5 ± 1.30	ACG 6	360008
	Jgo. tornillos tapa cilindros (HAS17038)		B360000
4030160321	Junta tapa válvulas superior	NB 6	360010
070140222	Jgo. junta para cárter (4)	NB 1	360311
4290150080	Tapa distribución	NB 1	360012
4030110080	Tapa delantera block	NB 1	360013
4032011080	Bomba de agua	NB 1	360014
40314220380	Múltiple escape	AC 6	360015
4421410480	Múltiple admisión	NFT 6	360017
4071310880	Tapa compresor 0.80	NB 1	360027
4071310880	Tapa compresor 0.50	NB 1	360027/1
	Tapa compresor	NB 1	360327
	Base bomba nafta	NB 1	550628
4422010480	Bomba de agua	NB 1	360029
917003040003	Acople lateral	NB 1	360030
917003036002	Base bomba aceite	NB 1	360030/1
4030180180	Llenado cárter	NB 1	360031
6171870180	Entrada aceite	NB 1	360032
4031840280	Refrigerador aceite	NB 1	360038
4031310780	Carcasa inferior compresor superior	NB 1	360039
4071310780	Tapa compresor	NB 1	360040
	Colector admisión	NB 1	360041
	Admisión entre múltiples	NB 1	360042
917003026000	Refrigerador aceite	NB 2	360043
3521870080	Salida aceite	NB 1	350443
4750150180	Cierre distribución	CG 1	360046
007603026305	Arandela tapón cárter A 26 x 32 x 2 A	AL 1	360048
4230110284	Suplemento camisa cilindros - 1 boca (0.08)	CHA	360070-0.08
4230110084	Suplemento camisa cilindros - 1 boca (0.10)	CHA	360070-0.10
4230110184	Suplemento camisa cilindros - 1 boca (0.15)	CHA	360070-0.15
	Kit de retenes completo		R360300
4220530196	Jgo. retén válvulas (12)	P 1	R360010P
0139971447	Retén bancada 120 x 140 x 13	V 1	R360011V
0149974647	Retén distribución 105 x 130 x 12	V 1	R360012V

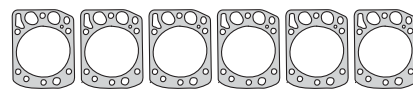

360008



360010

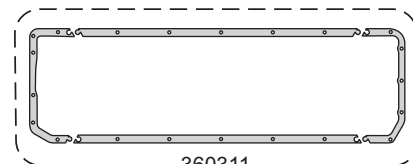

360311

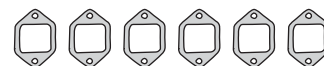

360015



360017

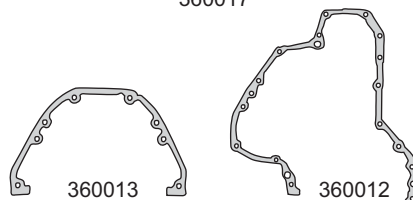

360013

360012

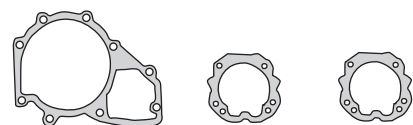

360014

360027

360027/1



360327

360029

360030

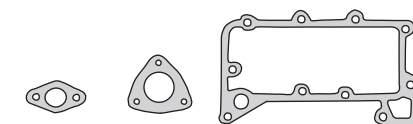

360030/1

360031

360038

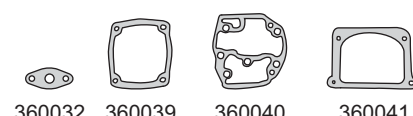

360032

360039

360040

360041



360042

360043

350443

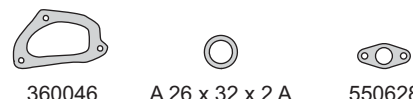

360046

A 26 x 32 x 2 A

550628



R360011V

R360012V

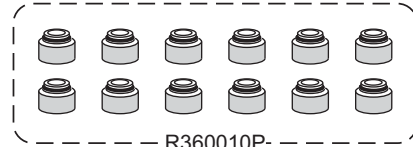

R360010P

MERCEDES BENZ

taranto





















Motor/Engine  **Cm³** **HP** **Ø**

OM 355-6 **11580** **230** **128**

Mercedes Benz: 0371, Bus 1926 1985/...

DIESEL



Nº OE	Descripción/Description	Mat.	Ref.
3555860390	Jgo. de juntas para motor 	●	360400-R
3550160220	Junta tapa cilindros Ø 130.0 \pm 1.30  N.R. 	NFT	2 350607-3
	Jgo. tornillos tapa cilindros (HAS19038) 		B350600
3460160221	Junta tapa válvulas 	NFT	6 350610
3265800196	Jgo. junta para cárter (6) 	NB	1 360411
3460150120	Tapa distribución 	CG	1 350612
3562010180	Tapa bomba de agua 	NB	1 350614
3451427060	Múltiple escape 	AC	6 350615
0664920080	Jgo. múltiple admisión (2) 	NFT	1 360417
0664920080	Salida de escape 	NFT	1 350718
3552030080	Termostato 	NB	1 350619
3551840480	Bomba aceite 	NB	1 350627
3552010080	Bomba de agua 	NB	2 350629
3269970149	Cañería de agua 	NB	6 350630
3520780080	Arandela retorno inyector A 8 x 12 x 1.5 C	CU	15 350032
3270750180	Tacómetro 	NB	1 350633
3460180080	Conducto aceite 	NB	1 350634
3600770180	Bomba inyectora 	NB	2 350635
3550150020	Junta tapa lateral válvulas 	NB	2 350636
3150150121	Tapa lateral cámara agua 	NB	1 360437
3030180079	Medidor aceite 	NB	1 350638
	Base a block compresor aire	NB	1 350639
	Tapa válvulas compresor aire	NB	1 350640
3520180180	Anular	CG	1 540041
	Entre cuerpo compresor aire	NB	1 350641
3551880080	Bomba aceite	NB	1 350642
071511040015	Entrada aire	NB	1 350643
0651810079	Bomba aceite	NB	1 350644
	Jgo. juntas compresor WAABCO (3)	VS	1 350645
	Kit de arandelas (100)	VS	1 360447
	Jgo. empaquetadura cigüeñal (2)	SNA	1 350458
	Jgo. juntas compresor (5)	VS	1 590260
071511026008	Tubo ventilación	NB	1 350662
	Junta de turbina turbo compresor	AC	1 810162
	Junta base turbo compresor	AC	1 810163
	Junta retorno turbo	NB	1 810364
	Junta entrada aceite turbo	NB	1 810365
	Junta salida aceite turbo	NB	1 810366
446.9970445	O'ring camisa inyector G 30.8 x 3.7	GS	6
	Arandela A 12 x 16 x 1 F	F	6
	Arandela A 14 x 18 x 1.5 A	AL	13
	Arandela A 14 x 20 x 1.5 C	CU	2
	Arandela A 16 x 21 x 1.5 C	CU	1
	Arandela A 18 x 22 x 1.5 A	AL	1
	Arandela A 18 x 22 x 1.5 C	CU	2
	Arandela A 20 x 24 x 1.5 C	CU	1
	Arandela A 20 x 26 x 1.5 C	CU	2
	Arandela A 22 x 27 x 1.5 C	CU	7
	Arandela A 24 x 30 x 1.5 A	AL	2
	Arandela A 26 x 34 x 2 A	AL	1
	Arandela A 30 x 36 x 2 A	AL	2
	Arandela A 30 x 36 x 2 C	CU	1
	Arandela A 35 x 41 x 2 C	CU	7

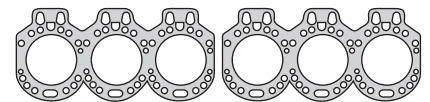

350607-3

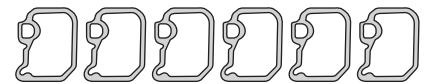

350610

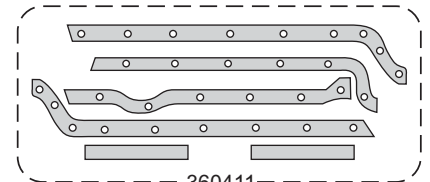

360411

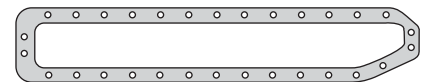

350615

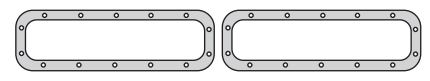

350718



350619

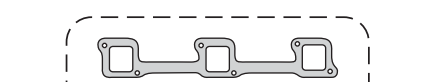

350627

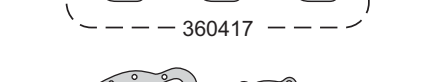

350629



350630

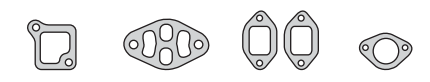

350633



350634

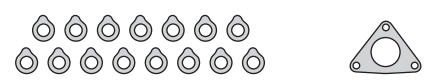

350635



350636

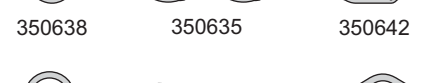

360437

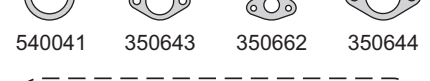

350638



350639

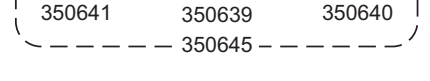

350640

MERCEDES BENZ



Motor/Engine	Cm³	HP	Ø
OM 355-6	11580	230	128

Mercedes Benz: 0371, Bus 1926 1985/...

DIESEL



Nº OE	Descripción/Description	Mat.	Ref.
	Arandela A 8 x 12 x 1 C	CU	13
	Arandela A 8 x 14 x 1 C	CU	18
	Arandela A 9.5 x 20 x 1 C	CU	6
	Jgo. retén válvulas (24)	P	R360410P
	Retén distribución 75 x 100 x 12	S	R350612S

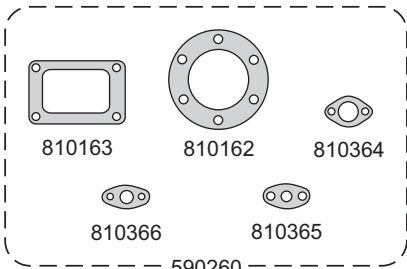

590260

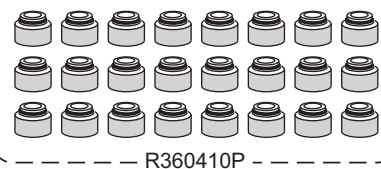
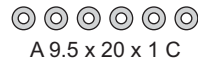
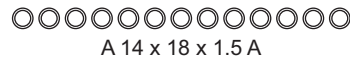

MERCEDES BENZ



Motor/Engine	Cm³	HP	Ø
OM457 (OHV) 24V Electrónico 252 - 456PS	11967	355/380	128

Mercedes Benz: OM457LA/LAIII/HLA/HLA III
OM457.933/938/940/944/949
OM458.960/970/980/938CAM
O400BUS, Camión LS1938, LK/LS
L2638, Axor 2035/40/44
2540/44, 2640/44
3340/44 4140/44



DIESEL

Nº OE	Descripción/Description	Mat.	Ref.
	Jgo. de juntas para motor		360800-R
4570161120	Junta tapa cilindros Ø 143.0 ± 0.45	MLS 6	360808
442900040/30/201	Jgo. tornillos tapa cilindros		B360800
4570160021	Junta tapa válvulas	NH 6	360810
	Junta tapa válvulas	GS 6	360810-1
440140022	Junta para cárter enteriza	NB 1	360811
4470150080	Tapa distribución	NB 1	360012
4570110080	Junta porta retén bancada	NB 1	360013
4572010080	Tapa bomba de agua	NB 1	360014
4031420380	Múltiple escape	AC 6	360015
4571410080	Múltiple admisión	NFT 6	360817
0249972848	O´ring termostato G 67 x 59 x 4	GS 2	360819
4422010481	Acople bomba de agua	NB 1	360029
4420180080	Tubo llenado aceite cárter	NB 1	360031
4421880580	Junta tapa refrigerador aceite	NB 1	360838
4572010180	Acople lateral block	AC	360839
4602010080	Empalme calefactor A	NB 1	360842
917003026003	Acople radiador aceite	NB 2	360043
9060170200	Arandela pico inyector	CU	360844
4570980080	Acople admisión	NB 1	360845
4570150080	Acople cierre distribución	CG 1	360046
4570150080	Acople cierre distribución	CG 1	360846
4421870080	Descarga aceite turbo	NB 1	360847
4421870180	Entrada aceite turbo	NB 1	360848
917003036003	Chupador de aceite	NB 2	360849
	Junta bomba combustible 025/030	NB	360863
	Asiento block bomba de aceite	NB 1	360864
	Válvula presión de aceite	NB 1	360865
4570110259	Jgo. suplemento camisa cilindros G146 x 155 (0.15)	AC	360870-0.15
4570110459	Jgo. suplemento camisa cilindros G146 x 155 (0.30)	AC	360870-0.30
4570110559	Jgo. suplemento camisa cilindros G146 x 155 (0.50)	AC	360870-0.50
1579970545	Jgo. o´ring camisa cilindros G146 x 155 (12)	GS 1	360870
	Junta tapa cilindros competición	AC	360890
	O´ring G 85 x 3	GS 1	
	O´ring G 45 x 2.5	GS 1	
	O´ring G 16.5 x 3	GS 1	
	Arandela A 26 x 32 x 2 A	AL 1	
	Arandela A 22 x 27 x 1.5 C	CU 1	
	Arandela A 16 x 20 x 1C	CU 2	
	Arandela A 14 x 20 x 1.5 C	CU 1	
	Kit de retenes completo		R360800
A0000533558	Jgo. retén válvulas (24)	V 1	R360810V
0219975347	Retén bancada 113 x 140 x 12	V 1	R360811V
0259973947	Retén bancada delant. 110 x 130 x 11	V 1	R360812V

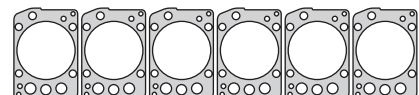

360808



360810

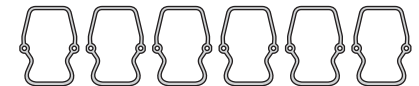

360810-1

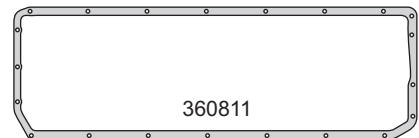

360811

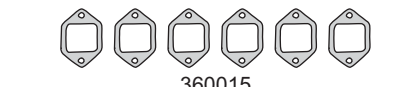

360015



360817



360013



360012

360014



360819

360029

360838



360031

360839

360842

360043

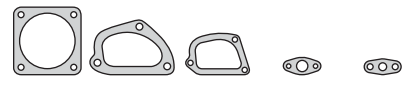

360845

360046

360846

360847

360848

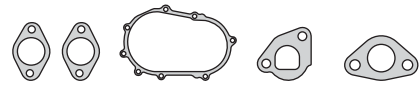

360849

360863

360864

360865



A 14 x 20 x 1.5 C

A 26 x 32 x 2 A

A 16 x 20 x 1 C

G 16.5 x 3

G 85 x 3

G 45 x 2.5

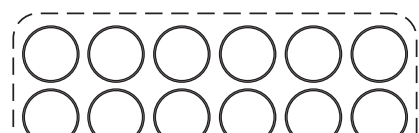

360870



R360811V

R360812V

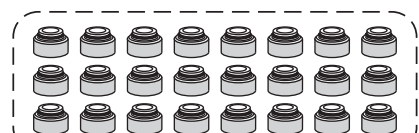

R360810V



taranto



Paso a Paso



Lubricar las roscas y debajo de la cabeza del tornillo



Seguir la especificación Taranto incluida en cada caja de tornillos, generalmente el ajuste inicial se da con torquimetro.



Realizar el apriete final según lo especificado en la ficha de ajuste. Para la generalidad de los motores modernos el apriete es angular.

RECUERDE... Siempre que se realiza un cambio de Junta y se aprieta la Tapa de Cilindros con un ajuste angular, se deben cambiar los tornillos de fijación, para asegurar así un correcto funcionamiento de la pieza.

Tornillos de Tapa de Cilindros Taranto.

Las consecuencias de NO cambiar los Tornillos de Tapa de Cilindros son más costosas que reemplazarlos. No lo dude!!!

- ▶ Indispensable para el buen funcionamiento del motor.
- ▶ Diseñados para resistir el estiramiento.
- ▶ Resisten altas temperaturas y presiones, característica de los motores modernos de alta performance.



MITSUBISHI



Motor / Engine	Cm ³	HP	Ø
K4E	1415	33	77
DIESEL			

Mitsubishi: Tractor, Autoelevador

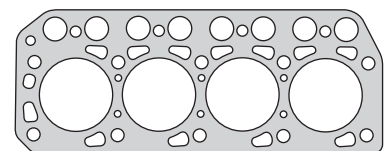

962807



962810

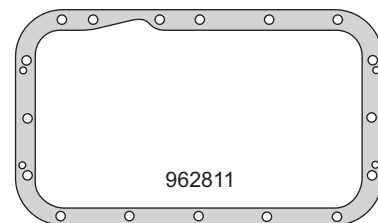

962811



962815



962817

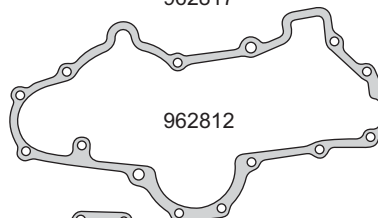

962812

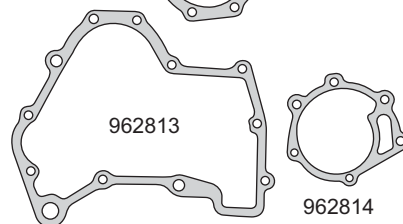

962813

962814

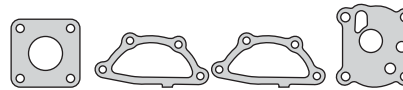

962818

962833

962836

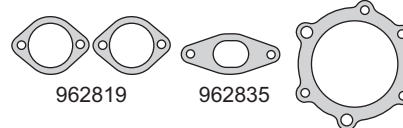

962819

962835

962837

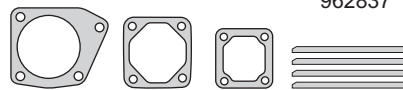

962832

962838

962839

962858



G 40 x 3.50

G 9.19 x 2.62

G 43 x 3.50

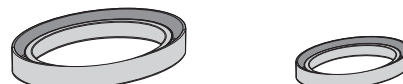

R962811S

R962812S



R961910P

Nº OE	Descripción / Description	Mat.	Ref.
	Jgo. de juntas para motor		962800-R
	Junta tapa cilindros Ø 78.0 ± 1.60	GFT 1	962807
	Junta tapa válvulas	GS 1	962810
	Junta para cárter	NB 1	962811
	Junta distribución	NB 1	962812
	Tapa distribución	NB 1	962813
	Bomba de agua	NB 1	962814
	Múltiple escape	NFT 1	962815
	Múltiple admisión	NFT 1	962817
	Salida de escape	FCH 1	962818
	Junta termostato	NB 2	962819
	Junta cuerpo admisión	NB 1	962832
	Junta	NB 2	962833
	Junta brida	NB 1	962835
	Junta	NB 1	962836
	Junta inspección distribución	NB 1	962837
	Junta entre colectores	NFT 1	962838
	Junta filtro aceite	NB 1	962839
	Cierre bancada	GS 4	962858
	Arandela A 7.5 x 15.5 x 1 C	CU 4	
	Arandela A 14.4 x 21 x 1 C	CU 4	
	Arandela A 18 x 24 x 1 C	CU 2	
	O´ring G 9.19 x 2.62	GS 1	
	O´ring G 43 x 3.50	GS 1	
	O´ring G 40 x 3.50	GS 1	
	Kit de retenes completo		R962800
	Jgo. retén válvulas (8)	P 1	R961910P
	Retén bancada 70 x 92 x 12	S 1	R962811S
	Retén distribución 48 x 70 x 12	S 1	R962812S

MITSUBISHI



Motor / Engine **Cm³** **HP** **Ø**

S4L
(OHV) 8V **1500** **16/37** **78**

Mitsubishi: Tractor, Autoelevador

DIESEL



Nº OE	Descripción / Description	Mat.	Ref.
	Jgo. de juntas para motor	●	963100-R
	Junta tapa cilindros Ø 80.5 x 1.65	GFT 1	963107
	Sellador líquido - caucho de silicona	TRN	TRN0085G
	Junta tapa válvulas	GS 1	963110
	Junta distribución	NB 1	963112
	Tapa distribución	NB 1	963113
	Bomba de agua	NB 1	963114
	Múltiple escape	NFT 1	963115
	Múltiple admisión	NB 1	963117
	Junta termostato	NB 1	963119
	Junta cuerpo admisión	NB 1	963132
	Junta	NB 1	963133
	Junta brida	NB 1	963135
	Junta inspección distribución	NB 1	963137
	Junta entre colectores	NB 2	963138
	Junta filtro aceite	NB 1	962839
	Junta	GS 1	963139
	Junta	NB 1	963140
	Guarnición goma	GS 1	963141
	Cierre bancada	GS 4	962858
	Arandela espiralada A 14 x 19 x 2.30 A	AL 1	
	Arandela A 25.5 x 31.5 x 1.50 C	CU 1	
	Arandela A 16.5 x 24 x 1 A	AL 1	
	Arandela A 12 x 19 x 1 A	AL 4	
	Arandela A 16.5 x 22 x 1.50 A	AL 3	
	Arandela A 12 x 17.5 x 1.50 C	CU 4	
	Kit de retenes completo		R963100
	Jgo. retén válvulas (8)	P 1	R961910P
	Retén bancada 70 x 95 x 13	S 1	R963111S
	Retén distribución 35 x 50 x 8	S 1	R960013S

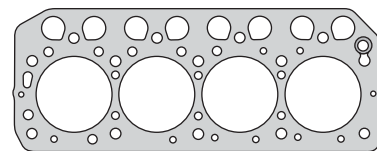

963107



963110



963110



963112



963114



963117

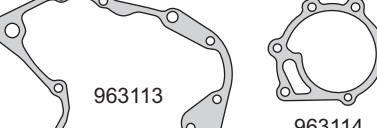

963112

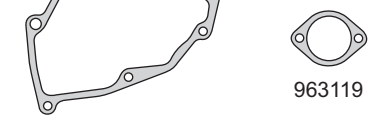

963119

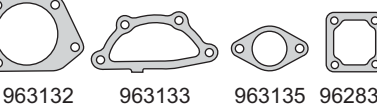

963132 963133 963135 962839

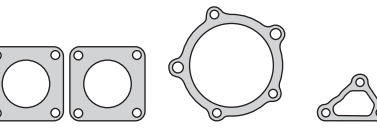

963138 963137 963140



963139 963141 962858

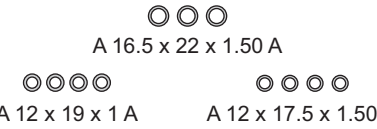

A 16.5 x 22 x 1.50 A
A 12 x 19 x 1 A A 12 x 17.5 x 1.50 C

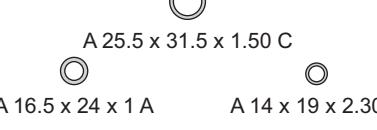

A 25.5 x 31.5 x 1.50 C
A 16.5 x 24 x 1 A A 14 x 19 x 2.30 A

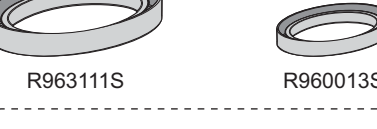

R963111S R960013S



R961910P

MITSUBISHI



Motor / Engine Cm³ HP Ø

4G63 1997

Mitsubishi: Tractor, Autoelevador

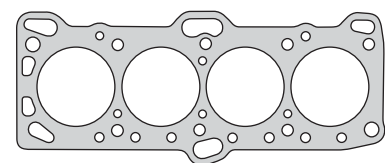

964107



963410

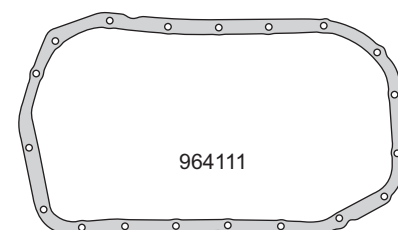

964111



963415



963417

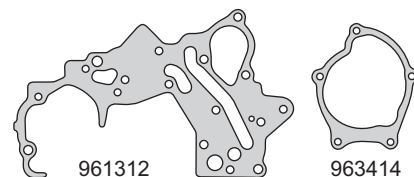

961312

963414

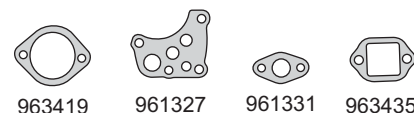

963419

961327

961331

963435

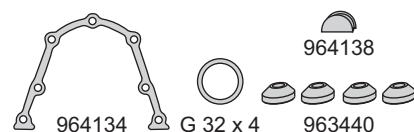

964134

964138

G 32 x 4

963440

G 8 x 2.20

A 14 x 19 x 2.30

A 10.5 x 16 x 1.50 A

G 46 x 3.5

G 20 x 2.50

G 21.5 x 3.5



R961511S



R950312S

R960013S

R950615S

R961315P



R910510P

Nº OE	Descripción / Description	Mat.	Ref.
	Jgo. de juntas para motor		964100-R
	Junta tapa cilindros Ø 87.0 ±1.70	NFT 1	964107
	Junta tapa válvulas	GS 1	963410
	Junta para cárter	CG 1	964111
	Junta distribución	NB 1	961312
	Bomba de agua	NB 1	963414
	Múltiple de escape	FCH 1	963415
	Múltiple admisión	NB 1	963417
	Tapa termostato	NB 1	963419
	Filtro aceite	NB 1	961327
	Bomba aceite	NB 1	961331
	Bancada trasera	NB 1	964134
	Codo agua	NB 1	963435
	Guarnición medialuna árbol de levas	GS 1	964138
	Arandela fijación tapa válvulas	GS 4	963440
	Arandela espiralada A 14 x 19 x 2.30	AL 1	
	Arandela A 10.5 x 16 x 1.50 A	AL 1	
	O`ring G 46 x 3.5	GS 1	
	O`ring G 32 x 4	GS 1	
	O`ring G 21.5 x 3.50	GS 1	
	O`ring G 20 x 2.50	GS 1	
	O`ring G 8 x 2.20	GS 4	
	Kit de retenes completo		R961300
	Jgo. retén válvulas (8)	P 1	R910510P
	Retén bancada 85 x 103 x 8	S 1	R961511S
	Retén distribución 44 x 60 x 7	S 1	R950312S
	Retén árbol de levas 35 x 50 x 8	S 1	R960013S
	Retén auxiliar 25 x 35 x 6	S 1	R950615S
	Retén auxiliar 20 x 30 x 7	P 1	R961315P

MITSUBISHI



Motor / Engine Cm³ HP Ø

4DQ5 2084 40 86

Mitsubishi: Tractor, Canter

DIESEL



Nº OE	Descripción / Description	Mat.	Ref.
	Jgo. de juntas para motor	●	964200-R
	Junta tapa cilindros Ø 87.0 ±1.70	NFT 1	964207
	Junta tapa válvulas	GS 1	964210
	Junta para cárter	CG 1	964211
	Jgo. junta para cárter (4)	NB 1	964211-1
	Junta distribución	NB 1	964212
	Placa distribución	NB 1	964213
	Placa distribución	NB 1	964213-1
	Bomba de agua	NB 1	964214
	Bomba de agua	NB 1	964314
	Múltiple de escape	NFT 1	964215
	Múltiple admisión	NB 2	964217
	Salida de escape	FCH 1	964218
	Salida de escape	FCH 1	964218-1
	Junta	NB 1	964226
	Bomba de aceite	NB 1	964227
	Entrada de aire	NB 2	964233
	Junta	NB 1	964231
	Junta	NB 1	964232
	Junta	NB 1	964234
	Junta	NB 1	964235
	Junta	NB 1	964237
	Junta	NB 1	964238
	Apoyo filtro de aceite	NB 1	964243
	Arandela A 16.5 x 22 x 1.5 A	AL 4	
	Arandela A 10.5 x 14 x 2 C	CU 4	
	O´ring G 9 x 5.8	GS 2	
	Kit de retenes completo		R964200
	Jgo. retén válvulas (8)	P 1	R964210P
	Retén bancada 90 x 115 x 13	S 1	R270111S
	Retén distribución 45 x 68 x 12	S 1	R900612S
	Retén árbol de levas 32 x 48 x 7	S 1	R964213S
	Retén auxiliar 17 x 30 x 7	P 1	R964215P

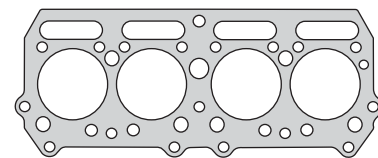

964207



964210

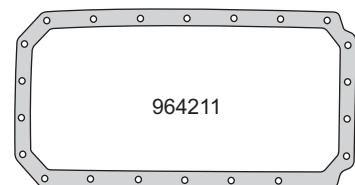

964211

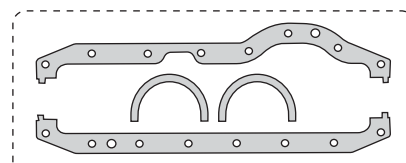

964211-1

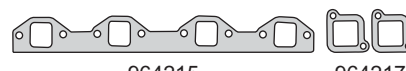

964215

964217



964212

964213

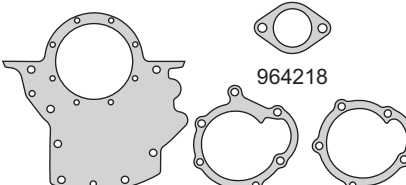

964218

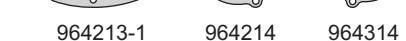

964213-1

964214

964314

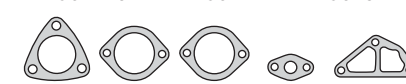

964218-1

964233

964226

964227



964231

964232

964235

964243



964234

964237

964238



964234

964237

964238

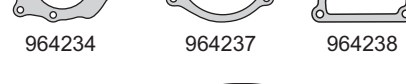

964234

964237

964238



964234

964237

964238



964234

964237

964238



964234

964237

964238



964234

964237

964238



964234

964237

964238

MITSUBISHI



Motor / Engine	Cm ³	HP	Ø
4DQ7	2080		89
DIESEL			

Mitsubishi: Tractor, Canter



Nº OE	Descripción / Description	Mat.	Ref.
	Jgo. de juntas para motor		964300-R
	Junta tapa cilindros Ø 90.0 ± 1.65	NFT 1	964307
	Junta tapa válvulas	GS 1	964210
	Junta para cárter	GS 1	964311
	Junta distribución	NB 1	964212
	Placa distribución	NB 1	964213
	Placa distribución	NB 1	964313
	Bomba de agua	NB 1	964314
	Múltiple de escape	NFT 1	964215
	Múltiple admisión	NB 2	964217
	Bomba de aceite	NB 1	964227
	Junta	NB 1	964231
	Arandela con inserto tapa válvulas	AC/GS 4	964333
	Junta	NB 1	964235
	Junta	NB 1	964337
	Junta	NB 1	964238
	Apoyo filtro de aceite	NB 1	964243
	Junta	NB 1	964345
	Junta	NB 1	964346
	Junta	NB 1	964347
	Junta	NB 1	964348
	Arandela especial A 7.8 x 13.5 x 2	AC/GS 4	
	Arandela especial A 13.8 x 20 x 2.60	AC/GS 8	
	Arandela A 10 x 16 x 1 C	CU 3	
	Arandela A 12 x 17.5 x 1.60 C	CU 4	
	Arandela A 14.5 x 22 x 1 C	CU 1	
	Arandela A 10.5 x 14 x 2 C	CU 4	
	Arandela A 12 x 19 x 1 A	AL 4	
	Arandela A 16.5 x 22 x 1.50 A	AL 6	
	O`ring G 7 x 6	GS 2	
	O`ring G 10 x 2.5	GS 1	
	O`ring G 73 x 3.10	GS 1	
	O`ring G 80 x 2	GS 1	
	Jgo. retén válvulas (8)	P 1	R910510P

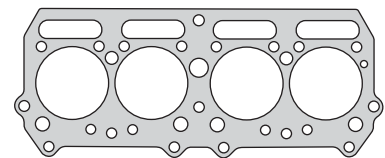

964307



964210

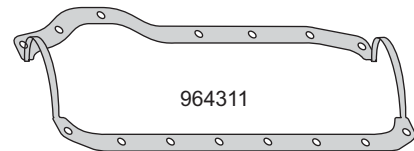

964311

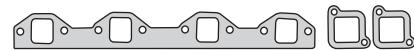

964215

964217



964212

964213

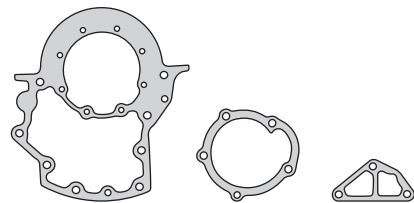

964313

964314

964227



964231

964333

964235

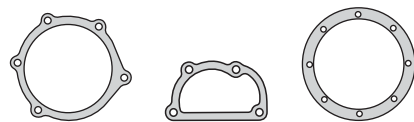

964337

964238

964348

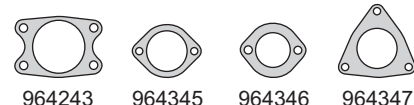

964243

964345

964346

964347



A 12 x 17.5 x 1.60 C



A 10.5 x 14 x 2 C



A 12 x 19 x 1 A



A 16.5 x 22 x 1.50 A



A 14.5 x 22 x 1 C



A 10 x 16 x 1 C



A 13.8 x 20 x 2.60



A 7.8 x 13.5 x 2

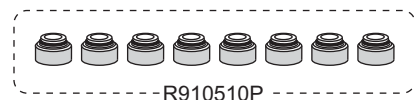

-R910510P

MITSUBISHI



Motor / Engine	Cm ³	HP	Ø
S4E	2477		95
DIESEL			

Mitsubishi: Tractor, Autoelevador



Nº OE	Descripción / Description	Mat.	Ref.
	Jgo. de juntas para motor		964700-R
	Junta tapa cilindros Ø 96.0 ± 1.70	GFT	1 964707
	Junta tapa válvulas	GS	1 964710
	Junta para cárter	NB	1 964711
	Tapa distribución	NB	1 964712
	Placa distribución	NB	1 964713
	Bomba de agua	NB	1 964714
	Múltiple escape	NFT	1 964715
	Múltiple admisión	NB	1 964717
	Salida de escape	FCH	1 964718
	Tapa bomba de agua	NB	1 964719
	Junta	NB	1 964732
	Tapa trasera cigueñal	NB	1 964734
	Junta	NB	1 964237
	Junta	NB	1 964740
	Junta	NB	1 964741
	Junta	CG	1 964742
	Junta apoyo filtro de aceite	NB	1 964743
	Junta	NB	1 964744
	Junta	NB	1 964745
	Junta	CG	1 964746
	Arandela especial A 8 x 13.5 x 2	AC/GS	2
	Arandela especial A 9.5 x 17.5 x 2.60	AC/GS	2
	Arandela especial A 11 x 19 x 2.80	AC/GS	2
	Arandela especial A 8.80 x 18.5 x 3.40	AC/GS	4
	Anillo G 33 x 42 x 4.4	GS	1
	Arandela A 10.5 x 14 x 2 C	CU	4
	Arandela A 12 x 18 x 2 C	CU	1
	O`ring G 6 x 2	GS	1
	O`ring G 80 x 2	GS	1
	O`ring G 113 x 2.2	GS	1
	Kit de retenes completo		R964700
	Jgo. retén válvulas (8)	P	1 R910510P
	Retén bancada 90 x 115 x 13	S	1 R270111S
	Retén distribución 45 x 68 x 12	S	1 R900612S
	Retén árbol de levas 32 x 48 x 7	S	1 R964213S
	Retén auxiliar 17 x 30 x 7	P	1 R964215P

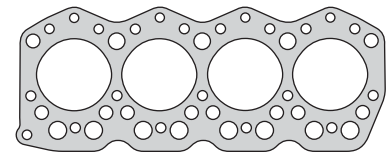

964707

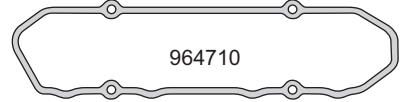

964710

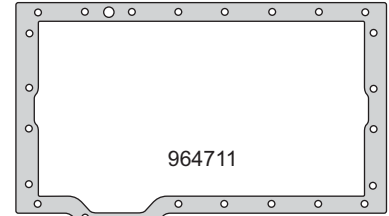

964711

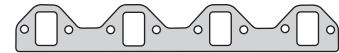

964715

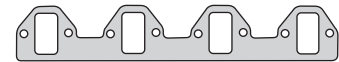

964717

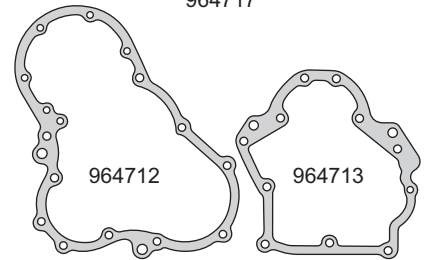

964712

964713



964714



964718



964719



964732



964740



964741



964742



964743

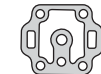

964744



964745



964746

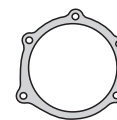

964237

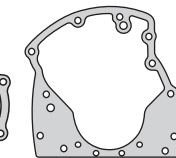

964734



G 80 x 2



R270111S



R900612S

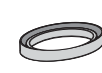

R964213S



R964215P

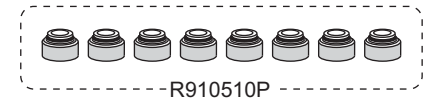

R910510P

MITSUBISHI



Motor / Engine	Cm ³	HP	Ø
4DR51 (SOHC) 8V	2659 2800	80	92 92
DIESEL			

Mitsubishi: Canter Serie FB3 1985/93
Truck 2.8 Serie FB308 1985/89

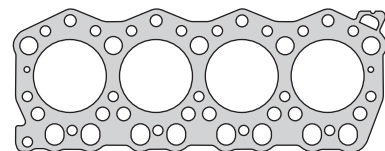

965108

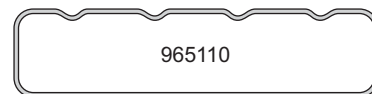

965110

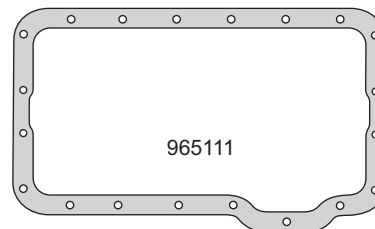

965111

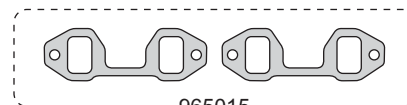

965015

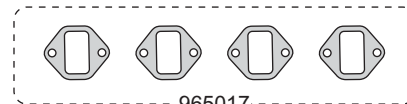

965017

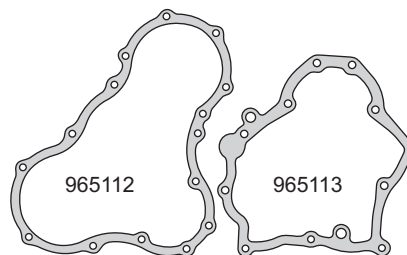

965112

965113

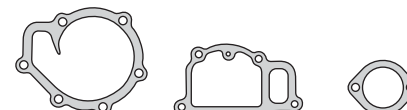

965014

965119

965037



965138

965039

965140

965141



A 7 x 10 x 1.8 C

A 10 x 16 x 1 C



G 11 x 2.3



A 14 x 21 x 1 C



G 21.89 x 2.62

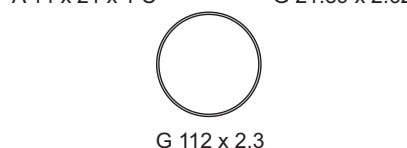

G 112 x 2.3

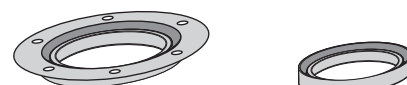

R965011S

R900012S



R910510P

Nº OE	Descripción / Description	Mat.	Ref.
	Jgo. de juntas para motor		965100-R-MLS
	Junta tapa cilindros Ø 93.5 ± 1.30	MLS	1 965108
	Junta tapa válvulas	GS	1 965110
	Junta para cárter	NB	1 965111
	Tapa distribución	NB	1 965112
	Placa distribución	NB	1 965113
	Bomba de agua	NB	1 965014
	Jgo. múltiple escape (2)	FCH	1 965015
	Jgo. múltiple admisión (4)	NB	1 965017
	Junta termostato	NB	1 965119
	Junta	NB	1 965037
	Junta	NB	1 965138
	Junta	CG	1 965039
	Junta	NB	1 965140
	Junta	NB	1 965141
	Anillo A 7 x 10 x 1.8 C	CU	4
	Arandela A 10 x 16 x 1 C	CU	6
	Arandela A 14 x 21 x 1 C	CU	4
	O´ring G 11 x 2.30	GS	1
	O´ring G 21.89 x 2.62	GS	4
	O´ring G 112 x 2.3	GS	1
	Kit de retenes completo		R965100
	Jgo. retén válvulas (8)	P	1 R910510P
	Retén bancada 90 x 113/146 x 16	S	1 R965011S
	Retén distribución 48 x 70 x 9	S	1 R900012S

MITSUBISHI



Motor / Engine Cm³ HP Ø

S4E2 2960 100 100

Mitsubishi: Tractor, Autoelevador

DIESEL



Nº OE	Descripción / Description	Mat.	Ref.
	Jgo. de juntas para motor	●	965200-R
	Junta tapa cilindros Ø 101.0 ± 1.75	NFT	1 965207
	Junta tapa válvulas	GS	1 964710
	Junta para cárter	NB	1 964711
	Tapa distribución	NB	1 964712
	Placa distribución	NB	1 964713
	Bomba de agua	NB	1 964714
	Múltiple escape	NFT	1 964715
	Múltiple admisión	NB	1 964717
	Salida de escape	FCH	1 964718
	Tapa bomba de agua	NB	1 964719
	Junta	NB	1 964732
	Tapa trasera cigueñal	NB	1 964734
	Junta	NB	1 964237
	Junta	NB	1 964740
	Junta	NB	1 964741
	Junta	CG	1 964742
	Junta apoyo filtro de aceite	NB	1 964743
	Junta	NB	1 964744
	Junta	NB	1 964745
	Junta	CG	1 964746
	Arandela especial A 8 x 13.5 x 2	AC/GS	2
	Arandela especial A 9 x 17.5 x 2.60	AC/GS	2
	Arandela especial A 11 x 19 x 2.80	AC/GS	2
	Arandela especial A 8.8 x 18.5 x 3.40	AC/GS	4
	Anillo G 33 x 42 x 4.4	GS	1
	Arandela A 10.5 x 14 x 2 C	CU	4
	Arandela A 12 x 18 x 2 C	CU	1
	O`ring G 6 x 2	GS	1
	O`ring G 80 x 2	GS	1
	O`ring G 113 x 2.2	GS	1
	Kit de retenes completo		R964700
	Jgo. retén válvulas (8)	P	1 R910510P
	Retén bancada 90 x 115 x 13	S	1 R270111S
	Retén distribución 45 x 68 x 12	S	1 R900612S
	Retén árbol de levas 32 x 48 x 7	S	1 R964213S
	Retén auxiliar 17 x 30 x 7	P	1 R964215P

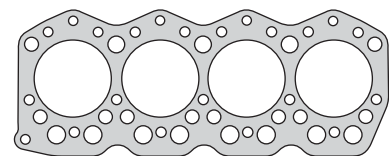

965207

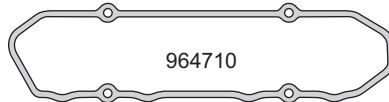

964710

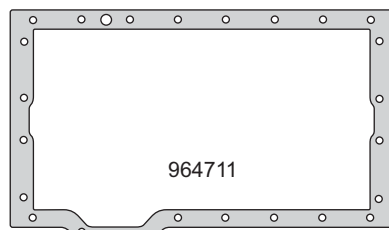

964711



964715



964717

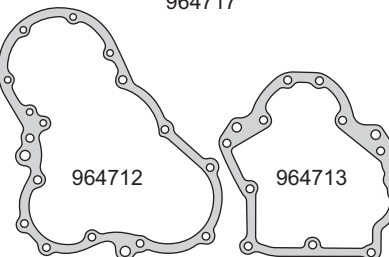

964712

964713



964714



964718

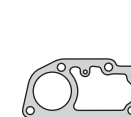

964719



964732



964740



964741



964742



964743



964744



964745



964746



964237



964734



G 80 x 2



R270111S



R900612S



R964213S



R964215P



-R910510P

MITSUBISHI



Motor / Engine	Cm ³	HP	Ø
S4S	3331		
DIESEL			

Mitsubishi: Tractor, Autoelevador

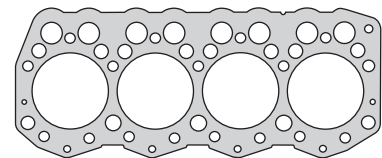

965308

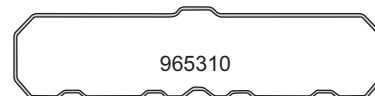

965310

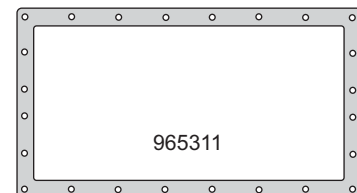

965311



965315

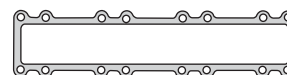

965317

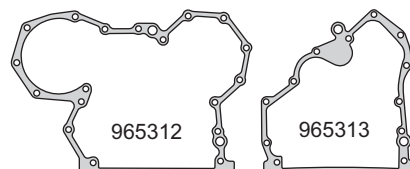

965312

965313

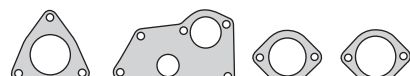

965318

965319

965339

965340

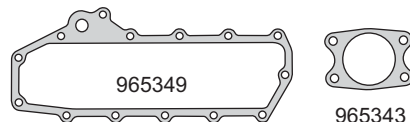

965349

965343

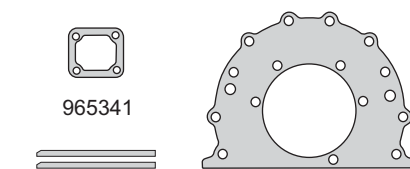

965341

965334



965358

965334



A 12 x 17.5 x 1.5 C

A 28 x 32 x 1 C

A 18.5 x 26 x 1 C



A 12 x 19 x 1 A

A 16.5 x 22 x 1.5 A

A 14.5 x 22 x 1 C

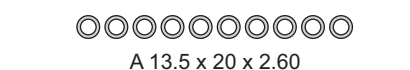

A 13.5 x 20 x 2.60

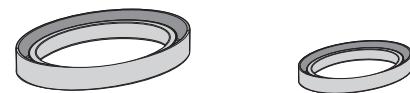

R270111S

R920612S

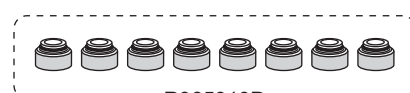

R965310P

Nº OE	Descripción / Description	Mat.	Ref.
	Jgo. de juntas para motor		965300-R MLS
	Junta tapa cilindros Ø 95.5 ± 1.00	MLS	1 965308
	Junta tapa válvulas	GS	1 965310
	Junta para cárter	NB	1 965311
	Junta distribución	NB	1 965312
	Tapa distribución	NB	1 965313
	Múltiple escape	FCH	1 965315
	Múltiple admisión	NB	1 965317
	Salida de escape	NB	1 965318
	Placa bomba de agua	NB	1 965319
	Tapa trasera cigüeñal	NB	1 965334
	Junta	NB	1 965339
	Junta	NB	1 965340
	Junta salida turbo	NB	1 965341
	Junta apoyo filtro aceite	NB	1 965343
	Junta tapa inspección	NB	1 965349
	Cierre bancada	AC/GS	2 965358
	Arandela A 18.5 x 26 x 1 C	CU	1
	Arandela A 28 x 32 x 1 C	CU	1
	Arandela A 14.5 x 22 x 1 C	CU	1
	Arandela A 12 x 17.5 x 1.5 C	CU	4
	Arandela A 12 x 19 x 1 A	AL	4
	Arandela A 16.50 x 22 x 1.5 A	AL	2
	Arandela especial A 9 x 17.5 x 2.60	AC/GS	2
	Arandela especial A 13.5 x 20 x 2.60	AC/GS	10
	O´ring G 11 x 2.20	GS	1
	O´ring G 20 x 2.50	GS	3
	O´ring G 60 x 2	GS	1
	O´ring G 80 x 2.50	GS	1
	O´ring G 117 x 2	GS	1
	O´ring G 140 x 2	GS	2
	Kit de retenes completo		R965300
	Jgo. retén válvulas (8)	P	1 R965310P
	Retén bancada 90 x 115 x 13	S	1 R270111S
	Retén distribución 55 x 78 x 12	S	1 R920612S

MITSUBISHI



Motor / Engine Cm³ HP Ø

S6E 3900

Mitsubishi: Tractor, Autoelevador

DIESEL



Nº OE	Descripción / Description	Mat.	Ref.
	Jgo. de juntas para motor		965400-R
	Junta tapa cilindros Ø 96.0 ± 1.70	GFT 2	965407
	Junta tapa válvulas	GS 2	965410
	Junta para cárter	CG 1	965411
	Tapa distribución	NB 1	964712
	Placa distribución	NB 1	964713
	Bomba de agua	NB 1	964714
	Jgo. múltiple escape (4)	NFT 1	965415
	Jgo. múltiple escape (4)	NFT 1	965415-1
	Jgo. múltiple admisión (2)	NB 1	965417
	Salida de escape	FCH 1	964718
	Tapa bomba de agua	NB 1	964719
	Junta	NB 1	965432
	Tapa trasera cigueñal	NB 1	964734
	Junta	NB 6	965435
	Junta	NB 1	964237
	Junta	NB 1	964740
	Junta	NB 1	964741
	Junta	CG 1	964742
	Junta apoyo filtro de aceite	NB 1	964743
	Junta	NB 1	964744
	Junta	NB 1	964745
	Junta	CG 1	964746
	Arandela especial A 8 x 13.5 x 2	AC/GS 2	
	Arandela especial A 9 x 17.5 x 2.60	AC/GS 2	
	Arandela especial A 11 x 19 x 2.80	AC/GS 2	
	Arandela especial A 8.80 x 18.5 x 3.40	AC/GS 6	
	Anillo G 33 x 42 x 4.4	GS 1	
	Arandela A 10.5 x 14 x 2 C	CU 6	
	Arandela A 12 x 18 x 2 C	CU 1	
	O`ring G 6 x 2	GS 1	
	O`ring G 80 x 2	GS 1	
	O`ring G 113 x 2.2	GS 1	
	Kit de retenes completo		R965400
	Jgo. retén válvulas (12)	P 1	R965410P
	Retén bancada 90 x 115 x 13	S 1	R270111S
	Retén distribución 45 x 68 x 12	S 1	R900612S
	Retén árbol de levas 32 x 48 x 7	S 1	R964213S
	Retén auxiliar 17 x 30 x 7	P 1	R964215P

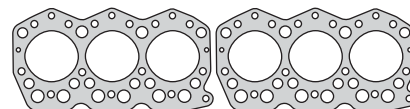

965407



965410

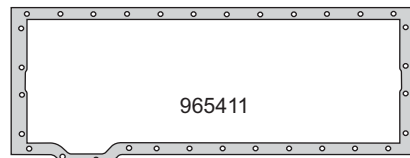

965411

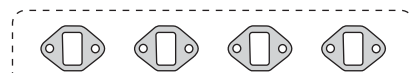

965415

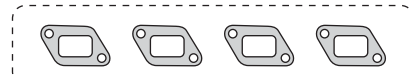

965415-1

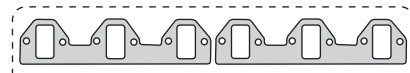

965417

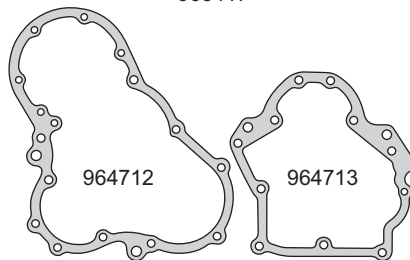

964712

964713

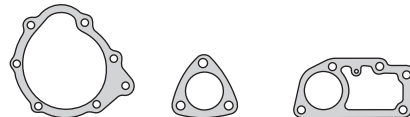

964714

964718

964719

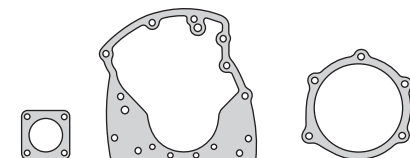

965432

964734

964237



965435



964740

964741

964742

964746

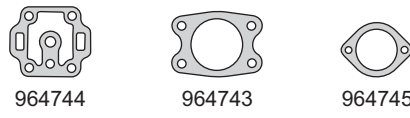

964744

964743

964745



R270111S



R900612S

R964213S

R964215P

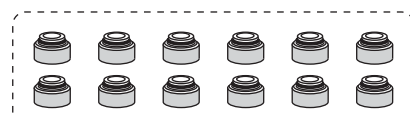

R965410P

MITSUBISHI



Motor / Engine **Cm³** **HP** **Ø**

S4K **4249** **102**

Mitsubishi: Tractor

DIESEL



Nº OE	Descripción / Description	Mat.	Ref.
	Jgo. de juntas para motor		965500
	Junta tapa cilindros Ø 103.5 ± 1.70	NFT	1 965507
	Junta tapa válvulas	GS	1 965510
	Junta para cárter	NB	1 965511
	Tapa distribución	NB	1 965512
	Placa distribución	NB	1 965513
	Bomba de agua	NB	1 965514
	Jgo. múltiple escape (4)	AC	1 965515
	Múltiple admisión	NB	1 965517
	Salida de escape	AC	1 965518
	Salida de escape	FCH	1 964718
	Junta	CG	1 965527
	Junta base chupador aceite	NB	1 965528
	Junta filtro aceite	NB	1 965529
	Tapa trasera cigüeñal	NB	1 965534
	Junta	NB	1 965535
	Junta	NB	1 965537
	Tubo salida de escape	AC	1 965538
	Junta	NB	1 965539
	Junta	NB	1 965540
	Junta	NB	1 965541
	Junta	NB	1 965542
	Junta enfriador aceite	NB	2 965543
	Junta	NB	1 965544
	Arandela A 7.5 x 15.5 x 1 C	CU	4
	Arandela A 10 x 16 x 1 C	CU	2
	Arandela A 14 x 20 x 1 C	CU	1
	Arandela A 22 x 34 x 1 C	CU	1
	Arandela especial A 5.5 x 11 x 2	AC/GS	8
	Arandela especial A 8 x 13.5 x 2	AC/GS	2
	Arandela especial A 9.5 x 16 x 2	AC/GS	5
	Arandela especial A 13.5 x 20 x 2.30	AC/GS	10
	Arandela especial A 16 x 23 x 2	AC/GS	2
	Anillo G 41 x 51 x 4.8	GS	1
	O´ring G 140 x 2	GS	2
	O´ring G 110 x 2	GS	1
	O´ring G 80 x 2	GS	1
	O´ring G 75 x 2	GS	1
	O´ring G 41 x 4	GS	2
	O´ring G 28.17 x 3.53	S	2
	O´ring G 25 x 3	S	1
	O´ring G 25.5 x 3	GS	1
	O´ring G 9.19 x 2.62	GS	1
	O´ring G 10 x 2	GS	1

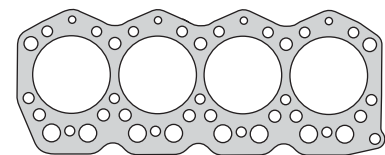

965507

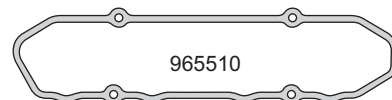

965510

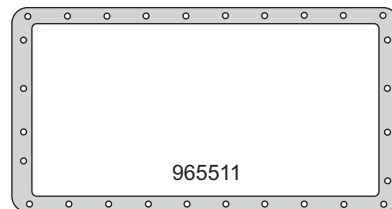

965511

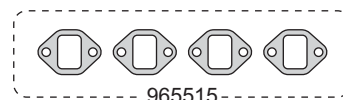

965515



965514

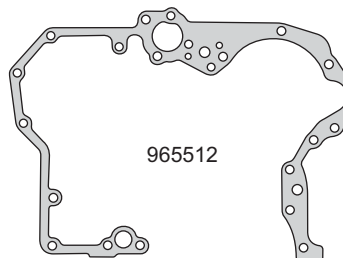

965512

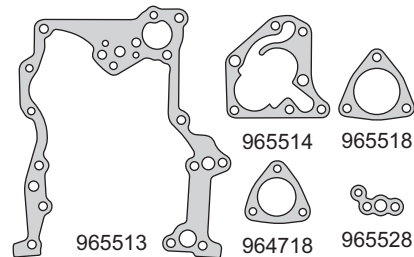

965514

965518

965513

964718

965528

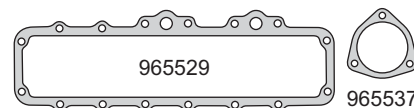

965529

965537

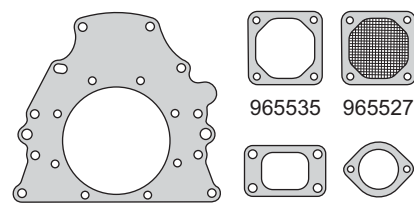

965534

965535

965527

965538

965539

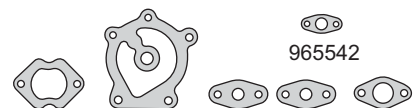

965542

965540

965541

965543

965544

A 9.8 x 16 x 1 C

A 7.4 x 15.5 x 1 C

A 13.8 x 20 x 1 C

A 21.8 x 34 x 1 C

MITSUBISHI



Motor / Engine Cm³ HP Ø

6D31T 4948 145 100

Mitsubishi: Canter 1992/96



DIESEL

Nº OE	Descripción / Description	Mat.	Ref.
	Jgo. de juntas para motor		● 965600-R MLS
	Junta tapa cilindros Ø 101.5 ± 1.50	MLS	1 965608
	Junta tapa válvulas	GS	1 965610
	Junta para cárter	NB	1 965611
	Tapa distribución	NB	1 965612
	Jgo. múltiple escape (6)	AC	1 965615
	Jgo. múltiple admisión (6)	NB	1 965617
	Salida de escape	AC	1 965618
	Junta	CG	1 965627
	Distribuidor de aceite radiador	SLS	1 965629
	Caja termostato	NB	1 965632
	Porta retén bancada trasera	NB	1 965634
	Arandela cónica pico inyector	CU	6 962136
	Chupador aceite	NB	1 965637
	Arandela A 10.5 x 16 x 1 C	CU	15
	Arandela A 14 x 20 x 1 A	AL	4
	Arandela A 18 x 28 x 1.50 C	CU	1
	Arandela A 20 x 28 x 1 C	CU	3
	Arandela A 27 x 36 x 1.50 C	CU	2
	Anillo G 22 x 30 x 5.60	S	2
	Anillo G 22 x 27 x 3.50	S	1
	Anillo G 25 x 30 x 3.50	S	1
	O´ring G 9 x 2	GS	1
	O´ring G 14 x 2.5	GS	1
	O´ring G 17 x 3	S	1
	O´ring G 21.82 x 3.53	GS	1
	O´ring G 50 x 3	GS	1
	O´ring G 98 x 3.2	GS	1
	O´ring G 134 x 3	GS	1
	Kit de retenes completo		R965600
	Jgo. retén válvulas (12)	P	1 R965610P
	Retén bancada 100 x 124/158 x 14.5	S	1 R965611S
	Retén distribución 55 x 78 x 8	S	1 R965612S

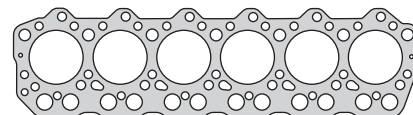

965608



965610

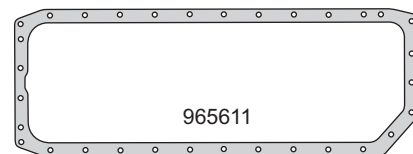

965611

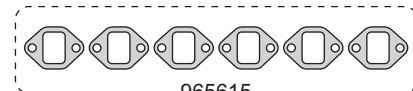

965615

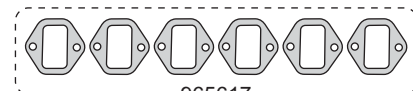

965617

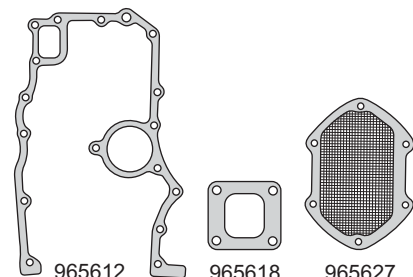

965612

965618

965627

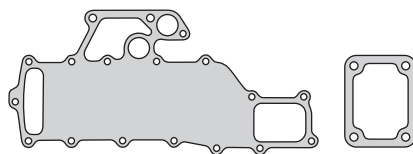

965629

965632

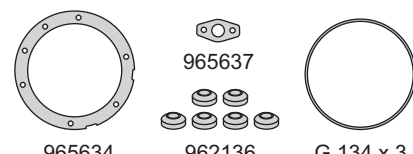

965634

965637

962136

G 134 x 3



G 50 x 3

G 98 x 3.2

G 17 x 3



G 14 x 2.5

G 22 x 30 x 5.6

G 9 x 2



G 21.82 x 3.53

G 22 x 27 x 3.5

G 25 x 30 x 3.5



R965611S

R965612S

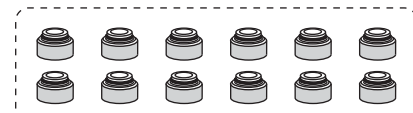

R965610P

MITSUBISHI



Motor / Engine	Cm ³	HP	Ø
S6S	4996		
DIESEL			

Mitsubishi: Tractor, Autoelevador

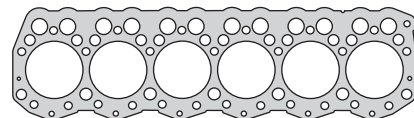

965708

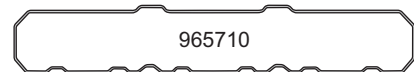

965710

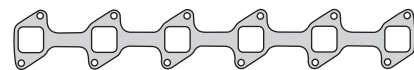

965715

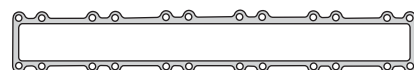

965717

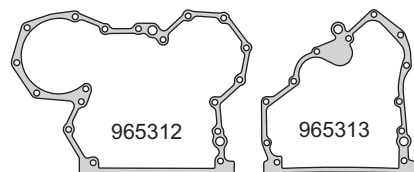

965312

965313

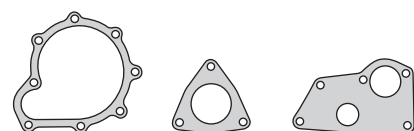

965714

965318

965319

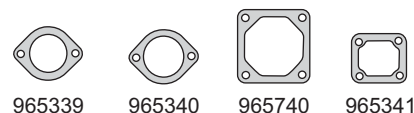

965339

965340

965740

965341



965749

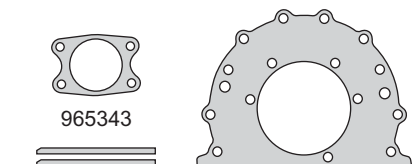

965343

965358

965334

A 12 x 17.5 x 1.5 C

A 20.5 x 27 x 1 C A 18 x 25 x 1 C

A 12 x 19 x 1 A

A 16.5 x 22 x 1.5 A A 20.5 x 31 x 1 C

A 13.8 x 20 x 2.20

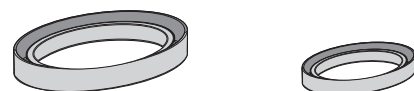

R270111S

R920612S

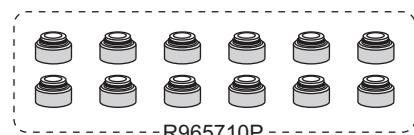

R965710P

Nº OE	Descripción / Description	Mat.	Ref.
	Jgo. de juntas para motor		965700-R MLS
	Junta tapa cilindros Ø 95.5 ± 1.00	MLS	1 965708
	Sellador líquido - caucho de silicona		TRN0280R
	Junta tapa válvulas	GS	1 965710
	Junta distribución	NB	1 965312
	Tapa distribución	NB	1 965313
	Bomba de agua	NB	1 965714
	Múltiple escape	FCH	1 965715
	Múltiple admisión	NB	1 965717
	Salida de escape	NB	1 965318
	Placa bomba de agua	NB	1 965319
	Tapa trasera cigüeñal	NB	1 965334
	Junta	NB	1 965339
	Junta	NB	1 965340
	Junta tapa	NB	1 965740
	Junta salida turbo	NB	1 965341
	Junta apoyo filtro aceite	NB	1 965343
	Junta tapa inspección	NB	1 965749
	Cierre bancada	AC/GS	2 965358
	Arandela A 18 x 25 x 1 C	CU	1
	Arandela A 20.5 x 27 x 1 C	CU	1
	Arandela A 20.5 x 31 x 1 C	CU	1
	Arandela A 12 x 17.5 x 1.5 C	CU	6
	Arandela A 12 x 19 x 1 A	AL	6
	Arandela A 16.50 x 22 x 1.5 A	AL	1
	Arandela especial A 8 x 13.5 x 2	AC/GS	1
	Arandela especial A 9.5 x 16 x 2	AC/GS	4
	Arandela especial A 13.5 x 20 x 2.20	AC/GS	10
	O´ring G 11 x 2.40	GS	1
	O´ring G 20 x 2.40	GS	1
	O´ring G 60 x 2	GS	1
	O´ring G 80 x 2	GS	1
	O´ring G 140 x 2	GS	2
	Kit de retenes completo		R965700
	Jgo. retén válvulas (12)	P	1 R965710P
	Retén bancada 90 x 115 x 13	S	1 R270111S
	Retén distribución 55 x 78 x 12	S	1 R920612S

MITSUBISHI



Motor / Engine **6D14T** **6557** **HP** **110**

Mitsubishi: 6000 Bus, 6000 Truck 1984/92 (FK115/FK215/FK415/FK425/FK515)

DIESEL



Nº OE	Descripción / Description	Mat.	Ref.
	Jgo. de juntas para motor	●	965900-R
	Junta tapa cilindros Ø 123.5 x 2.20	NFT 1	965907
	Junta tapa válvulas	GS 1	965910
	Junta para cárter	NB 1	965911
	Tapa distribución	NB 1	965912
	Placa distribución	NB 1	965913
	Bomba de agua	NB 1	965914
	Múltiple de escape	AC 1	965915
	Múltiple admisión	NFT 1	965917
	Salida de escape a turbo	NB 1	965918
	Junta	CG 1	965627
	Filtro aceite	NB 1	965929
	Bancada trasera	NB 1	965934
	Junta	NB 3	965937
	Junta	NB 2	965938
	Junta	NB 1	965939
	Junta	NB 1	965940
	Junta	NB 1	965941
	Junta escape a turbo	NB 1	965945
	O´ring G 9 x 2	GS 2	
	O´ring G 17.12 x 2.62	GS 2	
	O´ring G 40 x 3	GS 1	
	O´ring G 18.72 x 2.62	S 2	
	O´ring G 13.94 x 2.62	S 4	
	O´ring G 23.47 x 2.62	S 1	
	O´ring G 25.5 x 2.15	S 6	
	O´ring G 20.30 x 2.62	S 2	
	O´ring G 89 x 3.10	GS 2	
	O´ring G 120.24 x 3.53	GS 1	
	O´ring G 135 x 3.10	GS 1	
	O´ring G 140 x 3	S 1	
	Anillo G 16.5 x 24.5 x 5.6	S 4	
	Arandela A 10 x 18 x 1	CU 6	
	Kit de retenes completo		R965900
	Jgo. retén válvulas (12)	P 1	R965610P
	Retén bancada 100 x 125/134 x 12.5	S 1	R965911S
	Retén distribución 72 x 94 x 12	S 1	R965812S

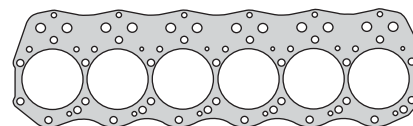

965907



965910

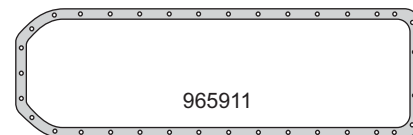

965911

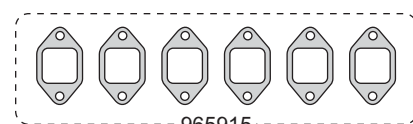

965914



965917

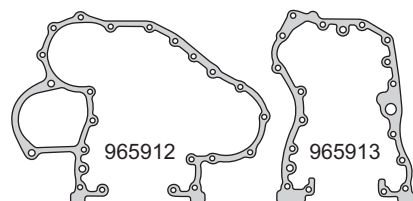

965912

965913

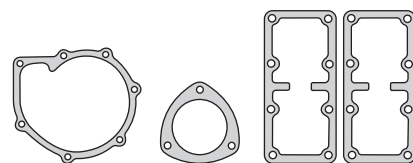

965914

965918

965928



965929



965627

965934

965945

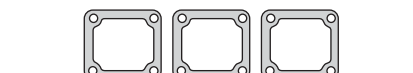

965937

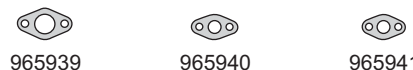

965939

965940

965941

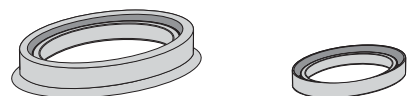

R965911S

R965812S

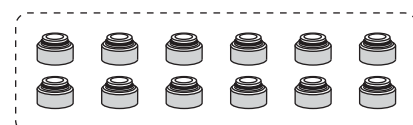

R965610P

MITSUBISHI



Motor / Engine	Cm ³	HP	Ø
6D15 (OHV) 12V	6919	131	118

Mitsubishi: 6900 Bus 1982/88
(MK116F/MM116H/MM516H)
6900 Truck 1984/92
(FK116/FK215/FK216/FM316)



DIESEL

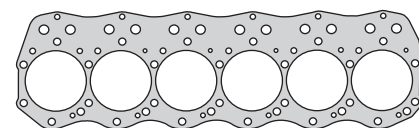

966007



966010

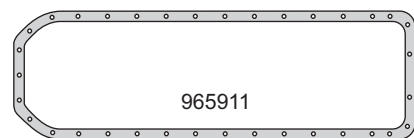

965911

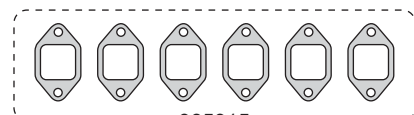

965915

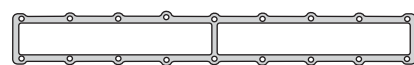

965917

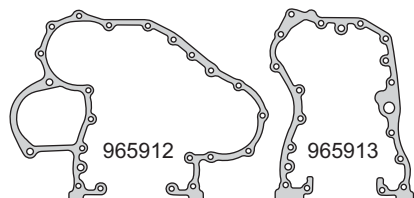

965912

965913

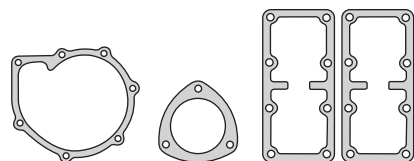

965914

965918

965938



965929

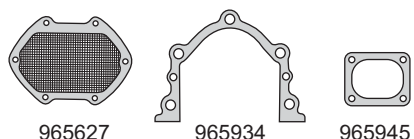

965627

965934

965945

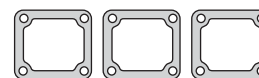

965937



965939

965940

965941



R966011S



R965812S

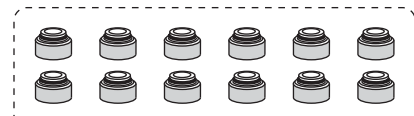

R965610P

Nº OE	Descripción / Description	Mat.	Ref.
	Jgo. de juntas para motor		966000-R
	Junta tapa cilindros Ø 126.0 ± 2.30	NFT	1 966007
	Junta tapa válvulas	GS	1 966010
	Junta para cárter	NB	1 965911
	Tapa distribución	NB	1 965912
	Placa distribución	NB	1 965913
	Bomba de agua	NB	1 965914
	Múltiple de escape	AC	1 965915
	Múltiple admisión	NFT	1 965917
	Salida de escape a turbo	NB	1 965918
	Junta	CG	1 965627
	Filtro aceite	NB	1 965929
	Bancada trasera	NB	1 965934
	Junta	NB	3 965937
	Junta	NB	2 965938
	Junta	NB	1 965939
	Junta	NB	1 965940
	Junta	NB	1 965941
	Junta escape a turbo	NB	1 965945
	O´ring G 9 x 2	GS	2
	O´ring G 17.12 x 2.62	GS	2
	O´ring G 40 x 3	GS	1
	O´ring G 18.72 x 2.62	S	2
	O´ring G 13.94 x 2.62	S	4
	O´ring G 23.47 x 2.62	S	1
	O´ring G 25.5 x 2.15	S	6
	O´ring G 20.3 x 2.62	S	2
	O´ring G 89 x 3.10	GS	2
	O´ring G 120.24 x 3.53	S	1
	O´ring G 135 x 3.10	GS	1
	O´ring G 140 x 3	S	1
	Anillo G 16.5 x 24.5 x 5.6	S	4
	Arandela A 10 x 18 x 1	CU	6
	Kit de retenes completo		R966000
	Jgo. retén válvulas (12)	P	1 R965610P
	Retén bancada 105 x 125 x 11.7	S	1 R966011S
	Retén distribución 72 x 94 x 12	S	1 R965812S

MITSUBISHI



Motor / Engine **Cm³** **HP** **Ø**

S6KT **6380** **102**

Mitsubishi: Tractor, Autoelevador

DIESEL



Nº OE	Descripción / Description	Mat.	Ref.
	Jgo. de juntas para motor		● 966100 MLS
	Junta tapa cilindros Ø 103.0 ±1.30	MLS 2	966108
	Junta tapa válvulas	GS 2	966110
	Junta para cárter	NB 1	966111
	Tapa distribución	NB 1	965512
	Placa distribución	NB 1	965513
	Bomba de agua	NB 1	965514
	Jgo. múltiple escape (2)	AC 1	966115
	Jgo. múltiple admisión (2)	NB 1	966117
	Salida de escape	AC 1	965518
	Junta	CG 1	965527
	Junta base chupador aceite	NB 1	965528
	Junta filtro aceite	NB 1	966129
	Tapa trasera cigüeñal	NB 1	965534
	Junta	NB 1	965535
	Junta	NB 1	965537
	Tubo salida de escape	AC 1	965538
	Junta	NB 1	965539
	Junta	NB 1	965540
	Junta	NB 1	965541
	Junta	NB 1	965542
	Junta	NB 7	966143
	Junta	NB 2	965544
	Junta	NB 1	966145
	Arandela A 7.5 x 15.5 x 1 C	CU 6	
	Arandela A 10 x 16 x 1 C	CU 2	
	Arandela A 16.5 x 22 x 1.50 A	AL 1	
	Arandela A 22.5 x 31.5 x 1.50 C	CU 1	
	Arandela A 25 x 34 x 1.50 C	CU 1	
	Arandela especial A 5.5 x 11 x 2	AC/GS 14	
	Arandela especial A 8 x 13.5 x 2	AC/GS 5	
	Arandela especial A 9.5 x 16 x 2	AC/GS 1	
	Arandela especial A 13.5 x 20 x 2.30	AC/GS 10	
	Arandela especial A 16 x 23 x 2	AC/GS 4	
	Anillo G 41 x 51 x 4.8	GS 1	
	O´ring G 140 x 2	GS 2	
	O´ring G 110 x 2	GS 1	
	O´ring G 80 x 2	GS 1	
	O´ring G 75 x 2	GS 1	
	O´ring G 41 x 4	GS 1	
	O´ring G 28.17 x 3.53	S 2	
	O´ring G 55 x 3	GS 1	
	O´ring G 24 x 3	S 1	
	O´ring G 11 x 2.5	GS 1	

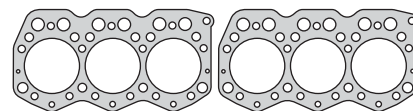

966108



966110

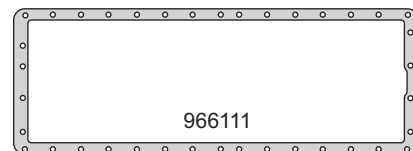

966111

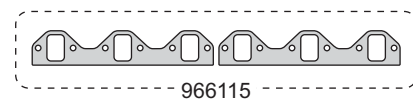

965512

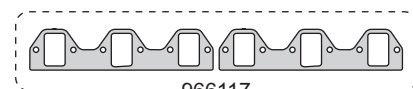

965513

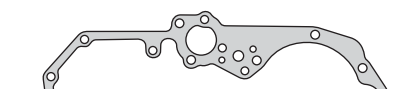

965514

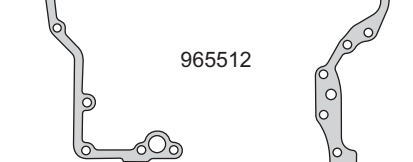

966115

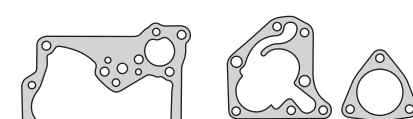

966117



965518

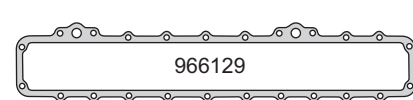

965527

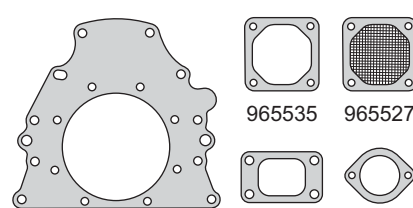

965528



965534



965535



965538

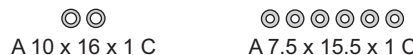

965540



965542



966143



G 41 x 4

G 16 x 23 x 2

G 55 x 3

MITSUBISHI



Motor / Engine **Cm³** **HP** **Ø**

6D16A **7545** **118**

Mitsubishi: Bus, Truck (FK416/FK516) 1988/...

DIESEL

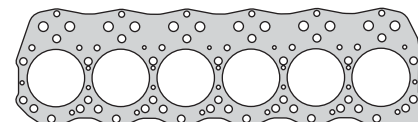

966207



965910

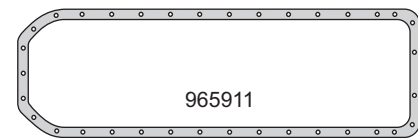

965911

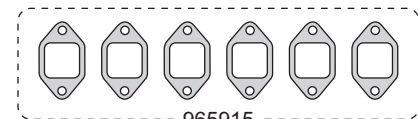

965915



966217

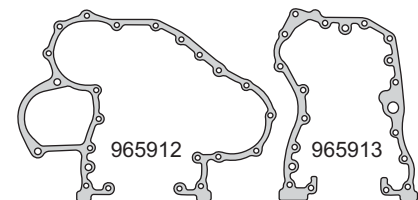

965912

965913

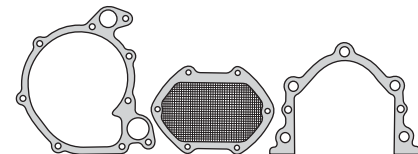

966214

965627

965934



965929

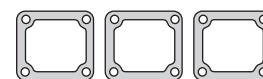

965937

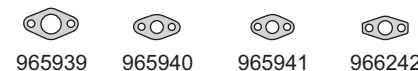

965939

965940

965941

966242

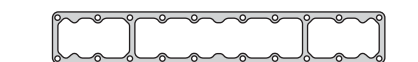

966249



A 10 x 16 x 1 C



A 9 x 18 x 1 C



A 20 x 28 x 1 C



R966211S



R965812S

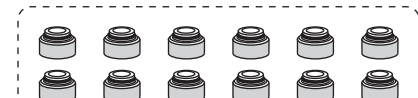

R965610P

Nº OE	Descripción / Description	Mat.	Ref.
	Jgo. de juntas para motor		966200-R
	Junta tapa cilindros Ø 119.0 ± 2.10	NFT	1 966207
	Junta tapa válvulas	GS	1 965910
	Junta para cárter	NB	1 965911
	Tapa distribución	NB	1 965912
	Placa distribución	NB	1 965913
	Bomba de agua	NB	1 966214
	Múltiple de escape	AC	1 965915
	Múltiple admisión	NFT	1 966217
	Junta	CG	1 965627
	Filtro aceite	NB	1 965929
	Bancada trasera	NB	1 965934
	Junta	NB	3 965937
	Junta	NB	1 965939
	Junta	NB	1 965940
	Junta	NB	1 965941
	Junta	NB	1 966242
	Junta tapa inspección	NB	1 966249
	Arandela A 9 x 18 x 1 C	CU	6
	Arandela A 10 x 16 x 1 C	CU	8
	Arandela A 18.5 x 28 x 1 C	CU	1
	Arandela A 20 x 28 x 1 C	CU	2
	Arandela A 36 x 48 x 1.5 C	CU	1
	Arandela A 14 x 21 x 1 A	AL	8
	Anillo G 16 x 24 x 5.6	S	4
	Anillo G 22.5 x 31 x 5.7	S	1
	O´ring G 9 x 2	GS	2
	O´ring G 9.19 x 2.62	GS	2
	O´ring G 14.5 x 2.5	S	1
	O´ring G 17.12 x 2.62	S	1
	O´ring G 20.3 x 2.62	S	1
	O´ring G 21.82 x 3.53	GS	2
	O´ring G 60 x 3	GS	1
	O´ring G 62 x 2	GS	1
	O´ring G 88 x 3.10	S	2
	O´ring G 90 x 2.80	S	1
	O´ring G 140 x 2	GS	1
	O´ring G 135 x 3.10	GS	2
	Kit de retenes completo		R966200
	Jgo. retén válvulas (12)	P	1 R965610P
	Retén bancada 108 x 140/180 x 17	S	1 R966211S
	Retén distribución 72 x 94 x 12	S	1 R965812S

MITSUBISHI



Motor / Engine **Cm³** **HP** **Ø**

6D22T
(OHV) 12V

11149

260/310

93

Mitsubishi: Camión FP418/FV418/FS428
Bus FB418 T850 1988/...



DIESEL

Nº OE	Descripción / Description	Mat.	Ref.
	Jgo. de juntas para motor		● 966300-R MLS
	Junta tapa cilindros Ø 95.5 x 2.10	MLS 6	966308
	Junta tapa válvulas	GS 6	966310
	Junta para cárter	CG 1	966311
	Junta distribución	NB 1	966312
	Tapa distribución	NB 1	966313
	Jgo. múltiple escape (6)	AC 1	966315
	Jgo. múltiple admisión (6)	NB 1	966317
	Salida de escape	AC 1	966318
	Junta	CG 1	966327
	Filtro aceite	NB 1	966329
	Junta	NB 1	966331
	Junta	CG 1	966332
	Junta	NB 1	966333
	Bancada trasera	NB 1	966334
	Junta	NB 1	966335
	Junta	NB 2	966336
	Junta	NB 2	966337
	Junta	NB 1	966338
	Junta	NB 1	966339
	Junta	CG 1	966340
	Junta	NB 6	966341
	Junta	NB 1	966342
	Junta	CG 1	966343
	Junta	NB 1	966344
	Junta	NB 1	966345
	Tapa inspección	NB 3	966349
	Anillo G 24 x 32 x 4	S 4	
	O´ring G 17.12 x 2.62	GS 1	
	O´ring G 8.5 x 1.9	GS 1	
	O´ring G 9.19 x 2.62	GS 2	
	O´ring G 15 x 2.4	GS 2	
	O´ring G 17.17 x 1.78	S 6	
	O´ring G 34 x 3.1	GS 3	
	O´ring G 13.94 x 2.62	S 6	
	O´ring G 25.5 x 2.1	S 6	
	O´ring G 23.39 x 3.53	S 2	
	O´ring G 24 x 2.5	S 1	
	O´ring G 74 x 3.5	GS 1	
	O´ring G 64 x 3	GS 1	
	O´ring G 81 x 2.5	GS 1	
	O´ring G 88.57 x 2.62	GS 1	
	O´ring G 72.62 x 3.53	S 1	
	O´ring G 120 x 3.40	GS 1	
	O´ring G 155 x 3.6	S 1	
	Arandela A 10 x 18 x 1C	CU 6	
	Kit de retenes completo		R966300
	Jgo. retén válvulas (12)	P 1	R966310P
	Retén bancada 135 x 157.4 x 12.5	S 1	R966311S
	Retén distribución 101 x 125/130 x 13.5/21.5	S 1	R966312S

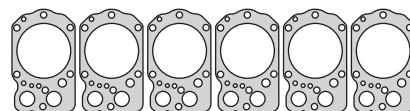

966308



966310

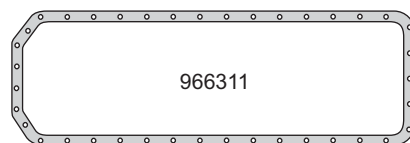

966311

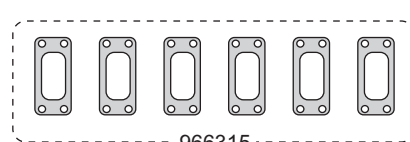

966315

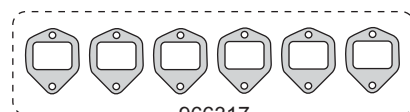

966317

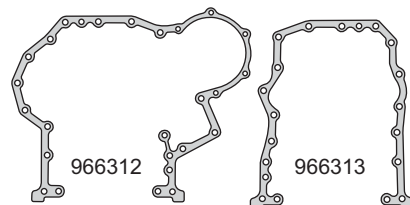

966312

966313

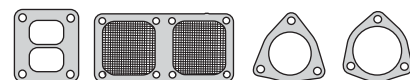

966318

966327

966331

966332

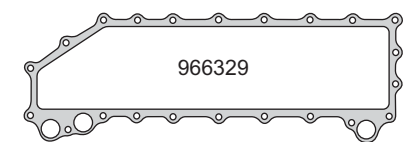

966329

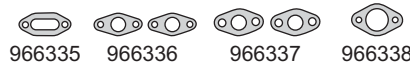

966335

966336

966337

966338

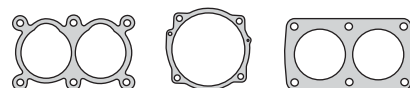

966333

966339

966340

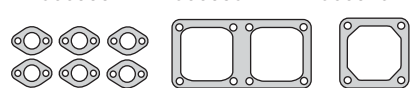

966341

966342

966343

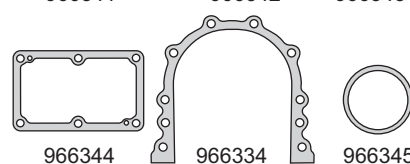

966344

966334

966345

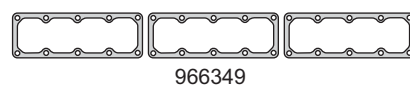

966349



R966311S

R966312S

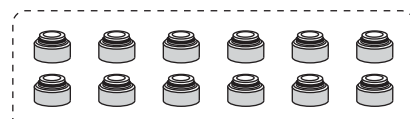

R966310P

MWM



Motor/Engine **Cm³** **HP** **Ø**

D229-4 **3922** **96** **102**

(SOHC) 8V

Ford: F100 1993/95, F1000 1994/96
F4000 1992/93, F2000 1980/...
FB4000 1985/...

Fiat: Excavadora FB80

DIESEL



Nº OE	Descripción/Description	Mat.	Ref.
922900013005/87	Jgo. de juntas para motor		310400-R
	Jgo. de juntas superior		310495
622708541044	Jta. tapa cilindros Ø110.0 ±1.45 N.R. HAS17038	NFT 4 4	310407
	Jgo. tornillos tapa cilindros		B310400
920808530014	Junta tapa válvulas	N 4 4	310410
630508530164	Jgo. junta para cárter (4)	NB 1 1	310411
632508530184	Tapa distribución	NB 1 1	310412
632508530154	Distribución bomba aceite	NB 1 1	310413
922208530134	Tapa bomba de agua	NB 2 2	310414
632138530094	Jgo. múltiple escape y admisión (8)	NFT 1 1	310416
	Salida de escape 58 x 71 x 11	NFT 1 1	310418
620808530014	Placa bomba de agua	NB 1 1	310419
62290853052	Bomba alimentación	NB 1 1	220128
	Base bomba nafta	NB 1 1	550628
	Junta	NB 1 1	310430
	Junta	NB 1 1	310435
	Junta	NB 1 1	310434
922408530575	Base bomba inyección	NB 1 1	400435
930508530214	Base filtro aceite	NB 1 1	310437
632508530054	Tapa trasera bancada	NB 1 1	310438
604931060443	O'ring G 30.8 x 3.7	GS 1 1	310439
604931000202	O'ring G 20 x 2	GS 4 4	310440
604931000324	O'ring G 6 x 2	GS 1 1	310441
90411025515	Acople escape	NB 1 1	310541
632148530124	Bombin bomba inyectora	NB 1 1	310442
620508530124	Base bomba inyectora lineal	NB 1 1	310443
604931060204	O'ring G 42 x 3	GS 2 2	310444
922508510014	Curva escape	NFT 1 1	310445
630508530154	Acople con escape	NFT 1 1	310446
630508530164	Complemento cárter	NB 2 2	310447
632488510144	Fijación filtro aire	NB 1 1	310448
922508510044	Tapa inspección	NB 1 1	310449
	Caja velocidades F100/1000/clark 5V	VS 1 1	310450
604931040062	O'ring G 20 x 4	GS 1 1	310451
604931000344	O'ring G 45 x 3	GS 1 1	310452
	Palier F4000	CB 1 1	310456
	Diferencial DANA 46 F100-45/97- 96/98	NH 1 1	310459
	Tubo ventilación	AC 1 1	350462
	Colector a escape a turbo	NB 1 1	350662
	Junta caract. turabo MWM D229	AC 1 1	310463
6049313041124	Junta suplemento camisa cilindros G110 x 4	V 8 8	310470
904920101014	Arandela A 8 x 11 x 1 A	AL 1 1	
904920100814	Arandela A 8 x 12 x 1 A	AL 1 1	
904921101014	Arandela A 10 x 14 x 1.5 A	AL 4 4	
904920101418	Arandela A 14 x 18 x 1.5 A	AL 16 16	
604921100811	Arandela A 8 x 14 x 1 A	AL 3 3	
904921101018	Arandela A 10 x 16 x 1 A	AL 1 1	
	Arandela A 20 x 26 x 1 C	CU 1 1	
604920600211	Arandela tapón cárter A 22 x 27 x 1 A	AL 1 1	
606901281017	Arandela A 10 x 20 x 2 C	CU 4 4	
	Arandela A 40 x 60 x 1.5	NB 1 1	
	Arandela A 12 x 18 x 1.5 A	AL 2 2	
	Arandela A 14 x 20 x 1.5 A	AL 2 2	

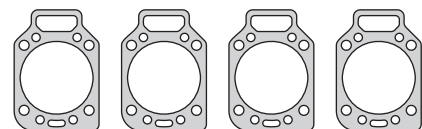

310407



310410

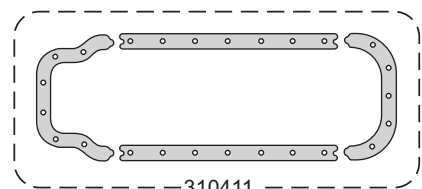

310411

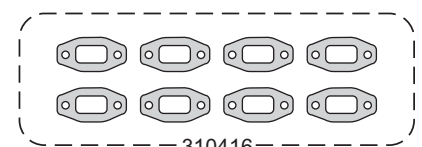

310416

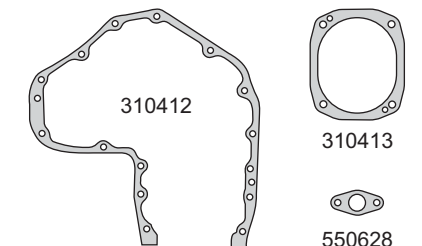

310412

310413

550628

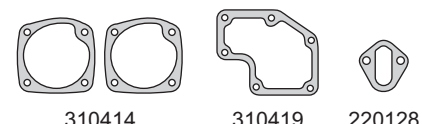

310414

310419

220128

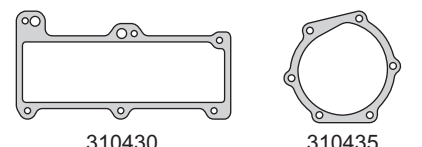

310430

310435



310437

310434

400435

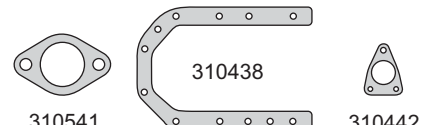

310541

310438

310442

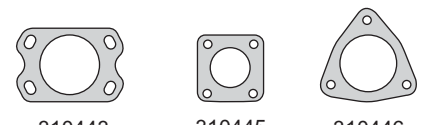

310443

310445

310446

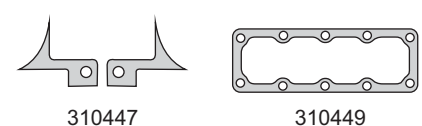

310447

310449

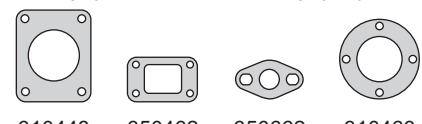

310448

350462

350662

310463

MWM



Motor/Engine	Cm³	HP	Ø
D229-4 (SOHC) 8V	3922	96	102

DIESEL

Ford: F100 1993/95, F1000 1994/96
F4000 1992/93, F2000 1980/...
FB4000 1985/...
Fiat: Excavadora FB80



Nº OE	Descripción/Description	Mat.	4	1	1	Ref.
	Arandela A 16 x 20 x 1.5 C	CU				
	O'ring G 46 x 3	GS				
	Kit de retenes completo					R310400
	Jgo. retén válvulas (8)	V		1		R310410V
	Retén bancada 110 x 130 x 13	P		1		R310411P
	Retén distribución 78 x 100 x 13	V		1		R310412V

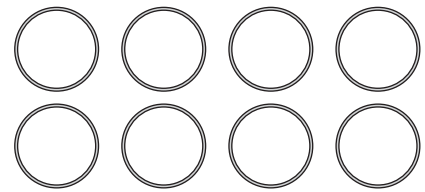

310470

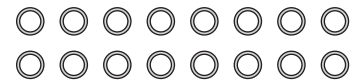
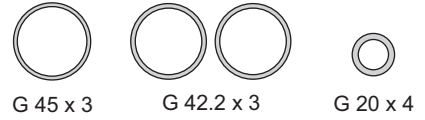

A 14 x 18 x 1.5 A



A 16 x 20 x 1.5 C



A 8 x 11 x 1 A



G 40 x 60 x 1.5



G 30.8 x 3.7



G 20 x 2



A 8 x 14 x 1 A



A 10 x 14 x 1.5 A



A 10 x 20 x 2 C



A 10 x 16 x 1 A



A 8 x 12 x 1 A



A 16 x 20 x 1.5 C



A 14 x 20 x 1.5 A



A 20 x 26 x 1 C



G 6 x 2



A 12 x 18 x 1.5 A



A 22 x 27 x 1 A



R310412V



R310411P

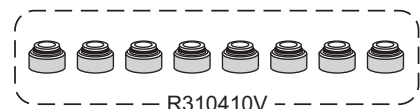

R310410V

MWM



Motor/Engine	Cm³	HP	Ø
D229-6	5883	145	102
D229-6 Turbo	5883	160	102

Ford: F14000, F4000 1994/96
Cargo, F12000, F14000 1985/...
Fiat: Tractor S90, FE105, FA120
FE105B



DIESEL

Nº OE	Descripción/Description	Mat.	Ref.
922900130177	Jgo. de juntas para motor		310500-R
	Jgo. de juntas superior		310595
622708541044	Jta. tapa cilindros Ø110.0 ±1.45 N.R.º	NFT 6 6	310407
	Jgo. tornillos tapa cilindros (HAS17038)		B310500
920808530014	Junta tapa válvulas	N 6 6	310410
	Junta tapa válvulas C/G - 6.40 mm.	CG	310510
	Junta tapa válvulas C/G - 3.20 mm.	CG	310531
	Junta tapa válvulas AH 651 - 2.70 mm.	NB	310532
922508530137	Jgo. junta para cárter (4)	NB	1 310511
632508530184	Tapa distribución	NB	1 310412
632508530154	Distribución bomba aceite	NB	1 310413
922208530134	Tapa bomba de agua	NB	2 310414
632138530094	Múltiple admisión y escape	NFT 12 12	310416
	Salida de escape	NB 1 1	400218
620608530014	Bomba de agua a block	NB	1 310419
62290853052	Bomba combustible	NB	1 220128
	Base bomba nafta	NB	1 550628
	Junta	NB	1 310430
	Junta	NB	1 310434
	Junta	NB	1 310435
922408530575	Base boma inyectora rotativa	NB	1 400435
930508530214	Base filtro aceite	NB	1 310437
632508530054	Tapa trasera bancada	NB	1 310438
	Complemento cárter	NB	2 310539
	Complemento cárter	NB	2 310540
90411025515	Acople caño escape	NB 1 1	310541
632148530124	Bomba alimentadora	NB	1 310442
922908530094	Tubo llenado aceite	NFT	1 310542
620508530124	Bomba inyectora linea	NB	1 310443
922508510014	Curva escape	NFT 1 1	310445
630508530154	Acople sin escape	NFT 1 1	310446
632488510144	Fijación filtro aire	NB	1 310448
	Jgo. juntas con caja 5 velocidades 1992/...	VS	310550
	Palier 1992/...	NB	310556
604931000344	O'ring G 30.8 x 3.7	GS	1 310439
604931000202	O'ring G 20 x 2	GS	1 310440
	Complemento cárter	NB	310540
604931040062	O'ring G 6 x 2	GS	1 310441
604931060204	O'ring G 42 x 3	GS 4 6	310444
604931040062	O'ring G 20 x 4	GS	1 310451
604931000344	O'ring G 45 x 3	GS	2 310452
	Escape a turbo	AC	1 310462
	Turbo ventilación	NB	1 350662
	Junta caract. turbo S-2 A	AC	1 310563
604931041104	Suplemento camisa cilindros G110 x 4	V	12 310470
904920101014	Arandela A 10 x 14 x 1 A	AL	6
	Arandela A 8 x 12 x 1 A	AL	6
904921101016	Arandela A 14 x 18 x 1.5 A	AL	16
904921101014	Arandela A 10 x 16 x 1 A	AL	6
	Arandela A 40 x 60 x 1.5	NB	1
	Arandela A 10 x 14 x 1.5 A	AL	6
	Arandela A 10 x 14 x 1 C	CU	1
	Arandela A 10 x 20 x 2 C	CU	6

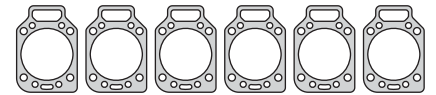

310407



310410

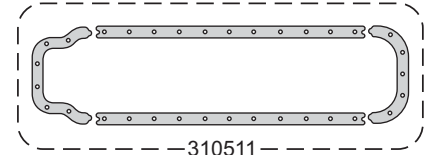

310511

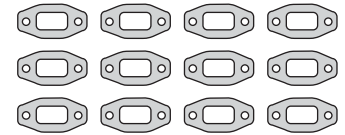

310416

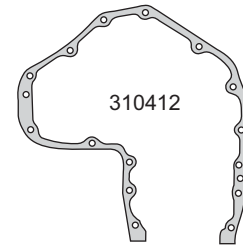

310412



310413

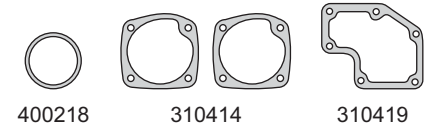

400218

310414

310419

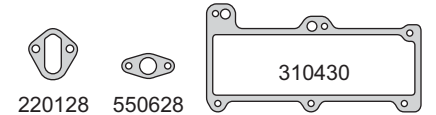

220128

550628

310430

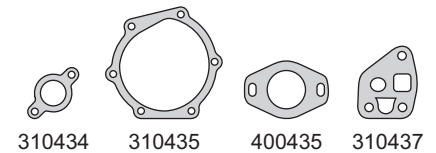

310434

310435

400435

310437

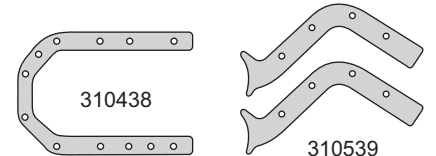

310438

310539

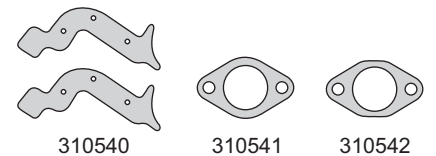

310540

310541

310542

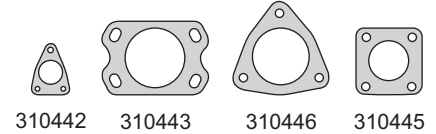

310442

310443

310446

310445

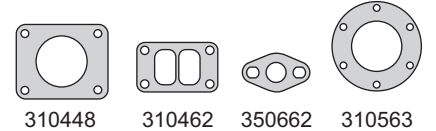

310448

310462

350662

310563

MWM



Motor/Engine	Cm³	HP	Ø
D229-6	5883	145	102
D229-6 Turbo	5883	160	102

Ford: F14000, F4000 1994/96
Cargo, F12000, F14000 1985/...
Fiat: Tractor S90, FE105, FA120
FE105B



DIESEL

N° OE	Descripción/Description	Mat.		Ref.
604920600211	Arandela A 12 x 15 x 1.5 C	CU	2	
	Arandela A 14 x 20 x 1.5 A	AL	4	
	Arandela A 16 x 20 x 1.5 C	CU	6	
	Kit de retenes completo			R310500
	Jgo. retén válvulas (12)	P	1	R310510P
	Retén bancada 110 x 130 x 13	P	1	R310411P
	Retén distribución 78 x 100 x 13	V	1	R310412V

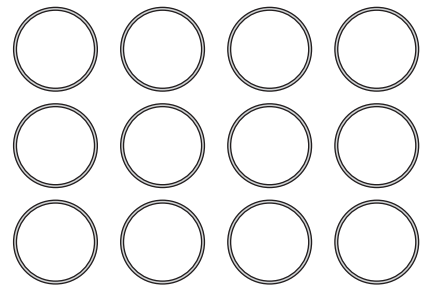

310470



G 20 x 2



G 45 x 3

G 42.2 x 3

G 20 x 4

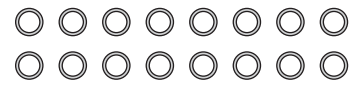

A 14 x 18 x 1.5A



A 10 x 14 x 1 A

A 12 x 15 x 1.5 C



A 10 x 20 x 2 C



A 10 x 16 x 1 A

A 8 x 12 x 1 A



A 16 x 20 x 1.5 C



A 10 x 14 x 1.5 A

A 10 x 14 x 1 C



A 40 x 60 x 1.5

G 6 x 2

G 30.8 x 3.7



A 14 x 20 x 1.5 A

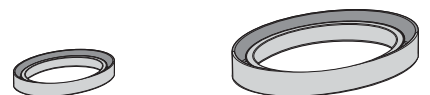

R310412V

R310411P

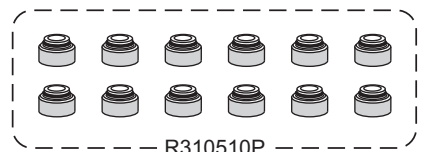

R310510P

MWM



Motor/Engine	Cm³	HP	Ø
D226-4 (OHV) 8V	4156	82	105

Ford: Camión F4000 1986/...
M. Ferguson: Tractor 85 1986/...
Valmet: Tractor 86-ID



DIESEL

Nº OE	Descripción/Description	Mat.	Ref.
	Jgo. de juntas para motor		● 320400-R
	Jgo. de juntas para motor		● 320400
922608548014	Junta tapa cilindros Ø 107.0 ± 1.20	NFT	4 320407
92250853.8054	Junta tapa válvulas	CG	4 310531
922508530114	Junta para cárter	NB	1 320411
632508530184	Tapa distribución	NB	1 310412
632508530154	Distribución bomba vacío	NB	1 320813
922208530134	Tapa bomba de agua	NB	1 310414
632138530094	Múltiple admisión y escape	NFT	8 310416
	Salida de escape		1 320418
922508510014	Placa bomba de agua	NB	1 310419
922208330024	Base filtro aceite	NB	1 310437
632508530054	Tapa trasera bancada	NB	1 310438
632148530124	Bombín inyectora	NB	1 310442
620508530124	Bomba inyectora lineal	NB	1 310443
922608530124	Junta	NFT	1 320444
922508510014	Salida de escape	NFT	1 310445
922608530134	Junta	NB	2 320445
	Refuerzo cárter	NB	2 310447
922608530104	Filtro de aire	NB	1 320448
	O'ring G 40 x 3	GS	2
	O'ring G 30.8 x 3.7	GS	3
	O'ring G 20 x 4	GS	1
	O'ring G 6 x 2	GS	1
	Arandelas A 10 x 14 x 1 A	AL	4
	Arandelas A 22 x 27 x 1.5 A	AL	1
	Arandelas A 11 x 16 x 1.5 A	AL	12
	Arandelas A 8 x 12 x 1 C	CU	8
	Arandelas pico inyector A 10 x 20 x 2 C	CU	4
	Arandelas A 14 x 18 x 1.5 A	AL	8
	Anillo G 22 x 33 x 8	GS	4
	O'ring G 45 x 3	GS	1
	Kit de retenes completo		R310400
	Jgo. retén válvulas (8)	P	R310410P
	Retén bancada 110 x 130 x 13	P	1 R310411P
	Retén distribución 78 x 100 x 13	V	1 R310412V

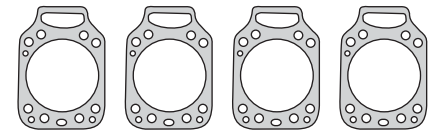

320407

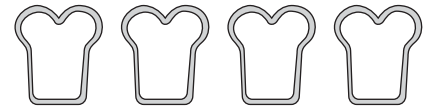

310531

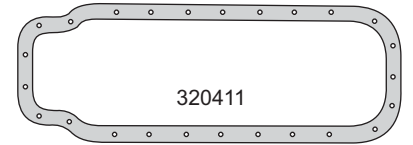

320411

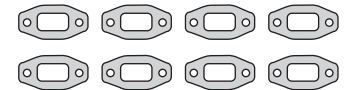

310416

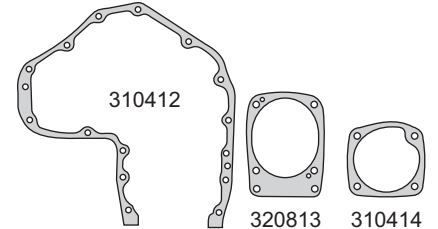

310412

320813

310414

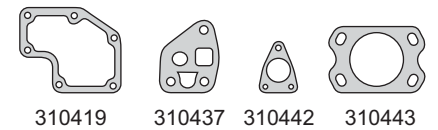

310419

310437

310442

310443

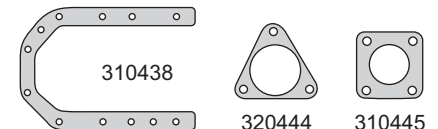

310438

320444

310445

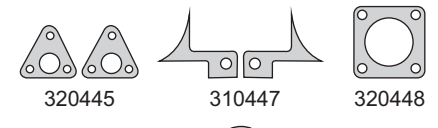

320445

310447

320448



G 40 x 3

G 45 x 3

G 20 x 4



G 30.8 x 3.7

G 22 x 23 x 8

G 6 x 2



A 14 x 18 x 1.5 A

A 8 x 12 x 1 C



A 10 x 14 x 1 A

A 10 x 20 x 2 C

A 22 x 27 x 1.5 A

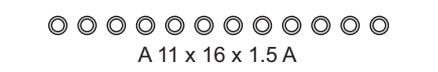

A 11 x 16 x 1.5 A

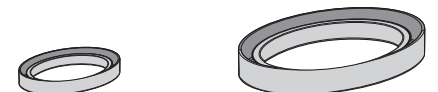

R310412V

R310411P

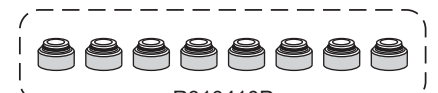

R310410P

MWM



Motor/Engine	Cm³	HP	Ø
D225-3	2550	50	95

Valmet: Tractor 65ID, 62ID 1970/76

DIESEL



Nº OE	Descripción/Description	Mat.	Ref.
	Jgo. de juntas para motor		320800-R
	Jgo. de juntas para motor		320800
622708540024	Junta tapa cilindros Ø 110.0 ± 1.20	NFT 3	320807
922508538054	Junta tapa válvulas		320810
	Junta para cárter	NB 1	320811
63250830184	Tapa distribución	NB 1	310412
	Distribución bomba vacío	NB 1	320813
922208530134	Bomba de agua	NB 2	310414
632138530094	Múltiple escape (6)	NFT 6	310416
	Salida de escape	NFT 1	320818
922208530134	Placa bomba de agua	NB 1	310419
	Junta tapa válvulas	CG 3	310531
922208530024	Base filtro aceite	NB 1	310437
632508530054	Tapa trasera bancada	NB 1	310438
604931000202	O'ring G 20 x 2	GS	310440
604931000324	O'ring G 6 x 2	GS 1	310441
	Acople escape	NB 1	310541
632148530124	Bomba inyectora	NB 1	310442
	Brida	NFT	320842
620508530124	Bomba inyectora	NB 1	310443
604931060204	O'ring G 42 x 3	GS	310444
922508510014	Curva escape	NFT 1	310445
	Curva escape	NFT	320845
630508530154	Acople caño escape	NFT 1	310446
	O'ring G 45 x 3	GS 1	320846
632488510144	Fijación filtro aire	NB 1	310448
	Arandela A 10 x 20 x 2 C	CU 3	320848
	Arandela A 22 x 27 x 1 C	CU 1	320849
604931040062	O'ring G 20 x 4	GS 1	310451
	Junta suplemento camisa cilindros G110 x 4	V 6	310470
	Jgo. suplemento camisa cilindros G 110 x 4 (6)	GS	320870
604921100811	Arandela A 8 x 14 x 1 C	CU 6	
904921101014	Arandela A 10 x 14 x 1 C	CU 4	
904921101018	Arandela A 10 x 16 x 1 A	AL 3	
	O'ring G 30.8 x 3.7	GS 3	
	O'ring G 40 x 3	GS 2	
	Arandela A 14 x 18 x 1.5 A	AL 16	
	Kit de retenes completo		R320800
	Jgo. retén válvulas (6)	P	R320810P
	Retén bancada 110 x 130 x 13	P 1	R310411P
	Retén distribución 78 x 100 x 13	V 1	R310412V

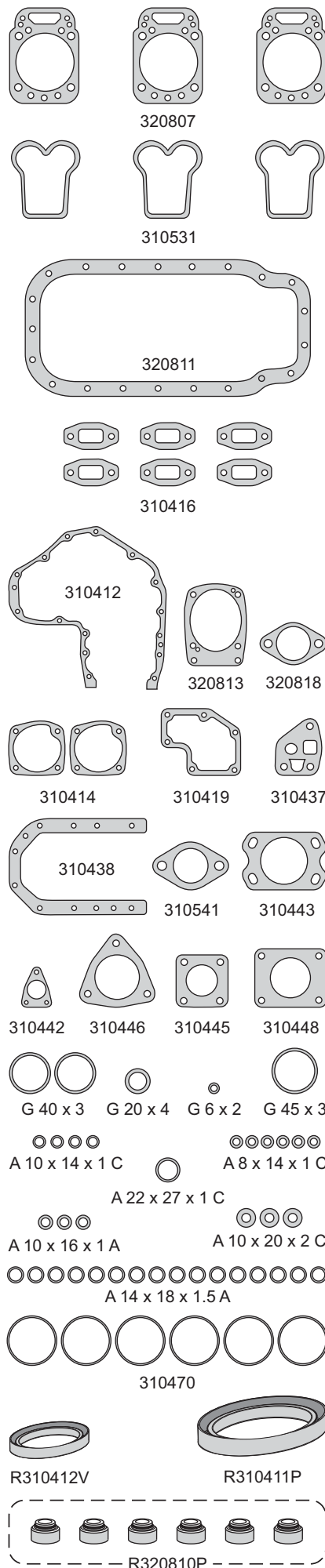

MWM



Motor/Engine	Cm³	HP	Ø
4.10 X10	4300	90	103
4.10T	4300	133	103
4.10TCA	4300	167	103

Agrale: 7000/7500/8500
Ford: Euro I/II/III
Volkswagen: 7100/8120/8140/8150/13150



DIESEL

Nº OE	Descripción/Description	Mat.	Ref.
	Jgo. de juntas para motor		330400-R
961008540144	Junta tapa cilindros Ø 113.4 ± 1.45	NFT	4 330407
961008530014	Junta tapa válvulas	N	4 330410
941008530064	Junta para cárter	NB	1 330411
941008530044	Tapa distribución	NB	1 330412
941008530054	Placa distribución	NB	1 330413
961008530204	Múltiple escape	GFT	4 330415
961008530144	Múltiple admisión	NFT	4 330417
941008530024	Salida de escape	NFT	1 330418
961008530174	Entrada agua	NB	1 330419
922908530584	Base bomba alimentación	NB	1 220128
961008530094	Termostato	NB	1 330430
623208520064	Retorno aceite	NB	1 330431
961008530074	Cabeza intercambiador	NB	1 330432
623208520044	Lubricación a turbo	NB	1 330433
961008530044	Cuerpo respiradero motor	NB	1 330434
961008530084	Radiador aceite	NB	2 330435
922908530604	Base bomba inyectora	NB	1 330436
	O'ring G 14 x 3	GS	4
	O'ring G 24.99 x 3.53	GS	4
	O'ring G 28.2 x 5	GS	2
	O'ring G 34 x 3	GS	1
	O'ring G 40.64 x 5.33	GS	2
	O'ring G 50.52 x 1.78	GS	2
	O'ring G 79 x 1.8	GS	1
	O'ring G 88.27 x 5.33	GS	1
	O'ring G 126.67 x 2.62	GS	1
	Arandela A 8 x 14 x 1 A	AL	8
	Arandela A 7 x 15 x 2 C	CU	4
	Arandela A 10 x 16 x 1 A	AL	1
	Arandela A 12 x 18 x 1.5 C	CU	4
	Arandela A 14 x 18 x 1.5 A	AL	14
	Arandela A 18 x 24 x 1.5 C	CU	2
	Arandela A 22 x 26 x 1.5 C	CU	1
	Arandela A 21 x 30 x 2 A	AL	1
	Anillo G 74 x 85 x 10	GS	
	Anillo G 43 x 51 x 6.5	GS	
	Suplemento camisa cilindros G 110 x 4	V	8 310470
	Kit retenes completo		R330400
	Jgo. retén válvulas (8)	V	1 R310410V
	Retén bancada 130 x 160 x 12	V	1 R330411V
	Retén distribución 78 x 100 x 13	V	1 R310412V

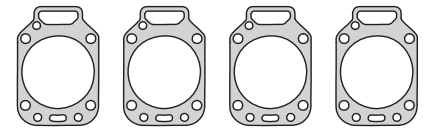

330407

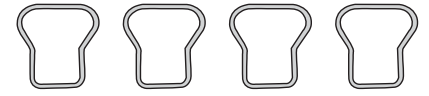

330410

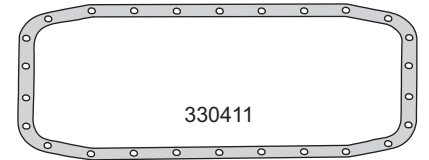

330411



330415



330417

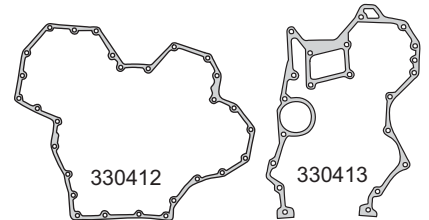

330412

330413

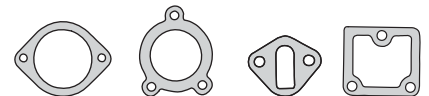

330418

330419

220128

330430

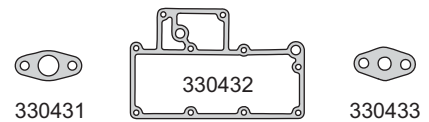

330431

330432

330433

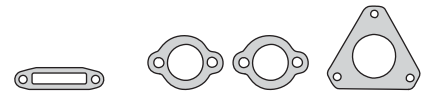

330434

330435

330436



G 34 x 3

G 88.27 x 5.33

G 79 x 1.8

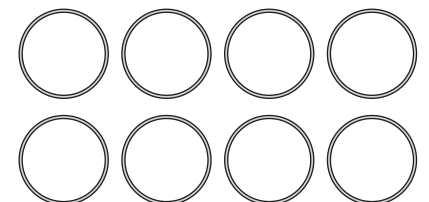

310470



R330411V

R310412V

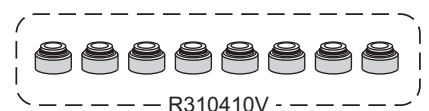

R310410V

MWM



Motor/Engine	Cm ³	HP	Ø
6.10 X10	6450	139	103
6.10T	6450	201	103
6.10TCA	6450	250	103

Ford: F14000 1995/98 - Euro I/II
 Volkswagen: 13180,15180, 16210



DIESEL

Nº OE	Descripción/Description	Mat.	Ref.
	Jgo. de juntas para motor		330700-R
	Junta tapa cilindros Ø 113.4 ± 1.45	NFT 6	330407
	Junta tapa válvulas	N 6	330410
	Junta para cárter	NB 1	330711
	Tapa distribución	NB 1	330412
	Tapa distribución 6.10	NB 1	330712
	Placa distribución	NB 1	330413
	Placa distribución 6.10	NB 1	330713
	Múltiple escape	GFT 6	330415
	Múltiple admisión	NFT 6	330417
	Salida de escape	NFT 1	330718
	Entrada agua	NB 1	330419
	Curva múltiple admisión	NFT 1	330720
	Múltiple admisión	NFT 1	330721
	Anillo 115 x 77	NB 1	330723
	Base bomba alimentación	NB 1	220128
	Termostato	NB 1	330430
	Retorno aceite	NB 1	330431
	Cabeza intercambiador	NB 1	330432
	Lubricación a turbo	NB 1	330433
	Cuerpo respiradero motor	NB 1	330434
	Radiador aceite	NB 2	330435
	Base bomba inyectora	NB 1	330436
	Bomba aceite	NB 1	330737
	Suplemento camisa cilindros G 110 x 4	V 12	310470
	O'ring G 126.67 x 2.62	GS 1	
	O'ring G 88.27 x 5.33	GS 1	
	O'ring G 79 x 1.8	GS 1	
	O'ring G 75 x 3	GS 2	
	O'ring G 50.39 x 3.53	GS 2	
	O'ring G 46.99 x 5.33	GS 2	
	O'ring G 50.52 x 1.78	GS 2	
	O'ring G 42.2 x 3	GS 1	
	O'ring G 34 x 3	GS 1	
	O'ring G 28.2 x 5	GS 2	
	O'ring G 25.07 x 2.62	GS 1	
	O'ring G 24.99 x 3.53	GS 6	
	O'ring G 20 x 4	GS 1	
	O'ring G 14 x 3	GS 6	
	O'ring G 74 x 8.5 x 10	GS	
	O'ring G 12.5 x 1.5	GS 1	
	O'ring G 6 x 2	GS 2	
	Arandela A 21 x 30 x 2 A	AL 1	
	Arandela A 22 x 26 x 1.5 C	CU 1	
	Arandela A 14 x 19 x 1.5 C	CU 3	
	Arandela A 14 x 18 x 1.5 A	AL 18	
	Arandela A 12 x 18 x 1.5 C	CU 2	
	Arandela A 10 x 16 x 1 A	AL 4	
	Arandela A 7 x 15 x 1 F	FI 6	
	Arandela A 7 x 15 x 2 C	CU 6	
	Arandela A 10 x 14 x 1 F	FI 1	
	Arandela A 8 x 14 x 1 A	AL 6	
	Kit de retenes completo		R330700

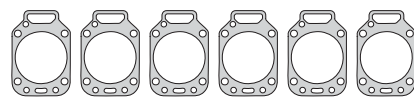

330407



330410

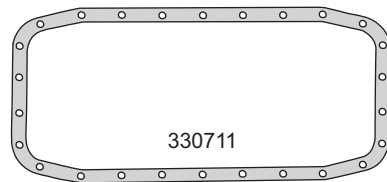

330711



330415



330417

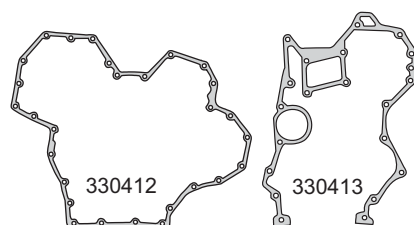

330412

330413

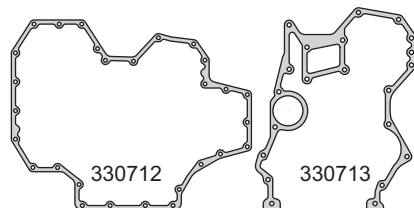

330712

330713

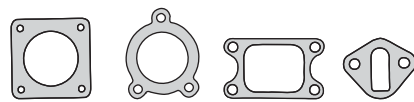

330718

330419

330720

220128

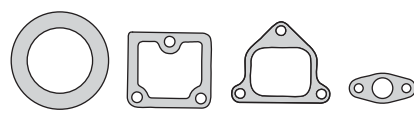

330723

330430

330721

330431

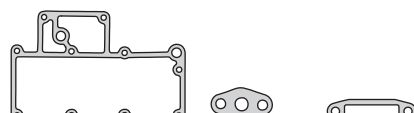

330432

330433

330434

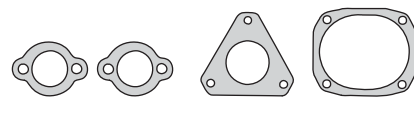

330435

330436

330737



G 75 x 3



G 24.99 x 3.53

MWM



Motor/Engine	Cm³	HP	Ø
D229-3 (SOHC) 6V	2942	72	102

Agrale: Camión TX 1600 1983/...
Dynapac: Cilindro Vibratorio CHF 44 1983/...
Valmet: Autoelevador, E300, Tractor 68 1983/...



DIESEL

Nº OE	Descripción/Description	Mat.	Ref.
92290013005/87	Jgo. de juntas para motor		330800-R
	Junta tapa cilindros Ø 110.0 ± 1.45	NFT 3	310407
622708541044	Jgo. tornillos tapa cilindros (HAS17038)		B330800
	Junta para cárter	NB 1	320811
	Tapa distribución	NB 1	310412
632508530184	Distribución bomba vacío	NB 1	320813
	Tapa bomba de agua	NB 2	310414
922208530134	Múltiple escape	NFT 6	310416
632138530094	Salida de escape	NFT 1	320818
	Placa bomba de agua	NB 1	310419
620808530014	Junta tapa válvulas	CG 3	310531
	Base filtro aceite	NB 1	310437
930508530214	Tapa trasera bancada	NB 1	310438
632508530054	O'ring G 20 x 2	GS 3	310440
604931000202	O'ring G 6 x 2	GS 1	310441
604931000324	Acople escape	NB 1	310541
90411025515	Bombin bomba inyectora	NB 1	310442
632148530124	Base bomba inyectora lineal	NB 1	310443
604931060204	O'ring G 42 x 3	GS 2	310444
604931060204	Curva escape	NFT 1	310445
922508510014	Acople con escape	NFT 1	310446
630508530154	Fijación filtro aire	NB 1	310448
604931040062	O'ring G 20 x 4	GS 1	310451
604931040062	Suplemento camisa cilindros G110 x 4	V 6	310470
	Arandela A 14 x 18 x 1.25 A	AL 16	
	Arandela A 8 x 14 x 1 A	AL 3	
604921100811	Arandela A 20 x 26 x 1 C	CU 1	
	Arandela tapón cárter A 22 x 27 x 1 A	AL 1	
604920600211	Arandela A 10 x 20 x 2 C	CU 3	
606901281017	Arandela A 10 x 20 x 1.5 A	AL 2	
	Arandela A 12 x 18 x 1.5 A	AL 2	
	Arandela A 10 x 14 x 1 A	AL 4	
	O'ring G 30.8 x 3.7	GS 1	
	O'ring G 44 x 3	GS 1	
	Kit de retenes completo		R330800
	Retén bancada 110 x 130 x 13	P 1	R310411P
	Retén distribución 78 x 100 x 13	V 1	R310412V

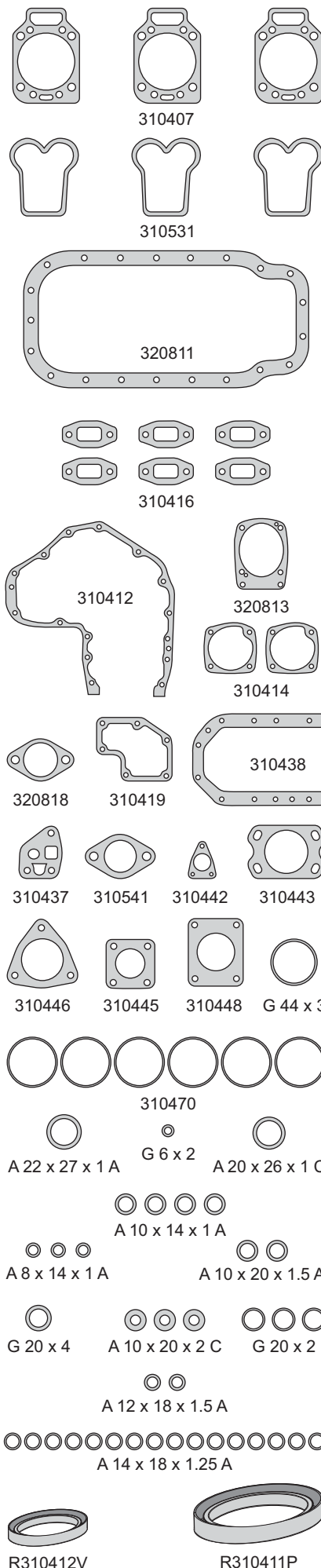

MWM



Motor/Engine	Cm³	HP	Ø
4.12 TCE (OHV) 8V	4800	150/180	105
DIESEL			

Agrale: 8500, 9200
Volkswagen: Constellation 13.180E, 15.180E
 Common Rail



Nº OE	Descripción/Description	Mat.	Ref.
	Jgo. de juntas para motor		● 331200-R MLS
961288540044	Junta tapa cilindros Ø 113.5 ± 1.30	NFT	2 331208
961008530034	Junta tapa válvulas	N	4 330410
941008530474	Junta para cárter	NB	1 330411
961208530014	Junta tapa distribución	NB	1 331212
961208530024	Junta placa distribución	NB	1 331213
961008530204	Múltiple escape	GFT	4 330415
941008530164	Múltiple admisión	NFT	4 330417
	Salida escape a turbo	AC	1 331218
941088530354	Entrada de agua	NB	1 330419
941088530354	Termostato	NB	1 330430
941088530454 941208530034	Retorno aceite	NB	1 330431
941088530394	Cabeza intercambiador	NB	1 330432
941088530444	Lubricación a turbo	NB	1 330433
961007160024	Cuerpo respiradero motor	NB	1 330434
941088530334	Radiador aceite	NB	1 330435
941208530014	Junta	NFT	1 331245
961008530214	Colector a escape turbo	AC	1 350462
	Junta caract. turbo S-2 A	AC	1 310563
904931361131	Suplemento camisa cilindros G 110 x 4	V	8 310470
961083400384	O'ring camisa cilindros	CU	4 330470-0.10
	O'ring G 209.14 x 3.53	GS	1
	O'ring G 91.67 x 3.53 S	GS	1
	O'ring G 85.09 x 5.33	GS	1
	O'ring G 79 x 1.8	GS	1
	O'ring G 77.62 x 3.53	GS	1
	Anillo G 73 x 84 x 9	GS	2
	O'ring G 56.82 x 2.62	GS	1
	O'ring G 50.39 x 3.53	GS	1
	O'ring G 34 x 3	GS	1
	O'ring G 24.99 x 3.53	GS	4
	O'ring G 20 x 4	GS	1
	O'ring G 17.17 x 1.78	GS	5
	O'ring G 8 x 2.4	GS	1
	O'ring G 7.65 x 1.78	GS	4
	Arandela A 24 x 29 x 2 C	CU	1
	Arandela A 22 x 26 x 1.5 C	CU	2
	Arandela A 21 x 30 x 2 A	AL	1
	Arandela A 18 x 22 x 1.5 A	AL	1
	Arandela A 16 x 22 x 1.5 A	AL	1
	Arandela A 14 x 18 x 1.5 A	AL	11
	Arandela A 12 x 18 x 1.5 C	CU	2
	Arandela A 8 x 12 x 1 C	CU	2
	Arandela A 8 x 14 x 1 A	AL	6
	Arandela A 7 x 15 x 2 C	CU	4
	Kit de retenes completo		R330400
904960640089	Jgo. retén válvulas (8)	V	1 R310410V
904960651301	Retén bancada 130 x 160 x 12	V	1 R330411V
904960640784	Retén distribución 78 x 100 x 13	V	1 R310412V

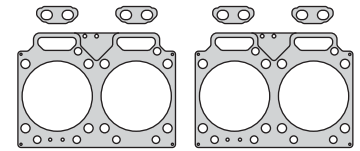

331208

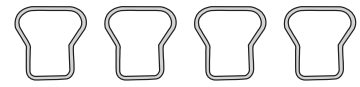

330410

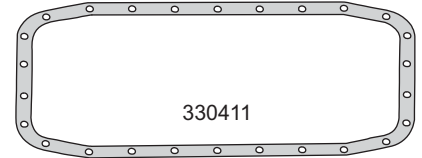

330411



330415



330417

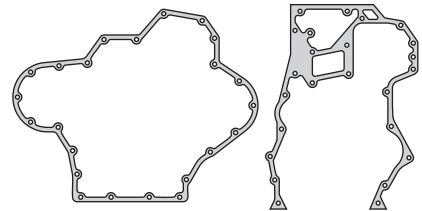

331212

331213

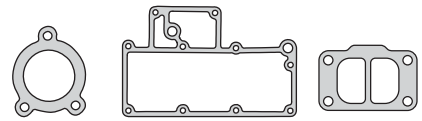

330419

330432

331218

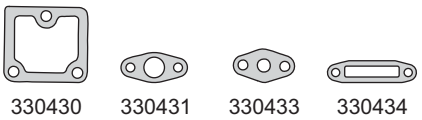

330430

330431

330433

330434

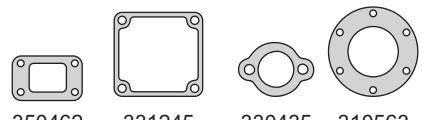

350462

331245

330435

310563

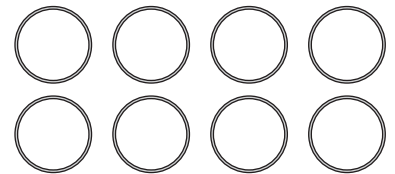

310470



330470-0.10

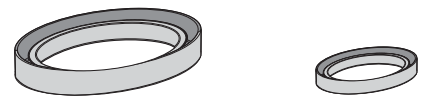

R330411V

R310412V

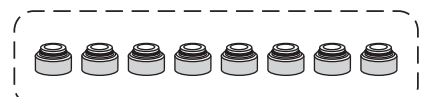

R310410V

MWM



Motor/Engine	Cm³	HP	Ø
6.12 TCE (OHV) 12V	7118	210/260 310	105
DIESEL			

Volkswagen: 26.260E, 31.260E, 17.260EOT, 17.210EOD

Volvo: VM210, 260, 310
Common Rail



Nº OE	Descripción/Description	Mat.	Ref.
	Jgo. de juntas para motor		331300-R MLS
961288540044	Junta tapa cilindros Ø 113.5 ±1.30	NFT	3 331208
961008530034	Junta tapa válvulas	N	6 330410
961088530354 961008530434	Junta para cárter	NB	1 330711
961208530014	Junta tapa distribución	NB	1 331212
961208530024	Junta placa distribución	NB	1 331213
961008530204	Múltiple escape	GFT	6 330415
941008530164	Múltiple admisión	NFT	6 330417
941088530354	Entrada de agua	NB	1 330419
941088530354	Termostato	NB	1 330430
941088530454 941208530034	Retorno aceite	NB	1 330431
941088530394	Cabeza intercambiador	NB	1 330432
941088530444	Lubricación a turbo	NB	1 330433
961007160024	Cuerpo respiradero motor	NB	1 330434
941088530334	Radiador aceite	NB	1 330435
941208530014	Junta	NFT	1 331245
961008530214	Colector a escape turbo	AC	1 350462
	Junta caract. turbo S-2 A	AC	1 310563
904931361131	Suplemento camisa cilindros G 110 x 4	V	12 310470
961083400384	O'ring camisa cilindros	CU	6 330470-0.10
	O'ring G 209.14 x 3.53	GS	1
	O'ring G 91.67 x 3.53	S	1
	O'ring G 85.09 x 5.33	GS	1
	O'ring G 79 x 1.8	GS	1
	O'ring G 77,62 x 3.53	GS	1
	O'ring G 73 x 84 x 9	GS	1
	O'ring G 56.82 x 2.62	GS	1
	O'ring G 50.39 x 3.53	S	1
	O'ring G 34 x 3	S	1
	O'ring G 24.99 x 3.53	GS	6
	O'ring G 20 x 4	S	1
	Arandela A 24 x 29 x 2 C	CU	1
	Arandela A 22 x 26 x 1.5 C	CU	2
	Arandela A 21 x 30 x 2 A	AL	1
	Arandela A 20 x 26 x 1 A	AL	1
	Arandela A 18 x 22 x 1.5 A	AL	1
	Arandela A 16 x 22 x 1.5 A	AL	2
	Arandela A 14 x 18 x 1.5 A	AL	13
	Arandela A 12 x 18 x 1.5 A	AL	1
	Arandela A 12 x 18 x 1.5 C	CU	2
	Arandela A 8 x 12 x 1 C	CU	2
	Arandela A 8 x 14 x 1 A	AL	8
	Arandela A 7.5 x 15 x 2 C	CU	6
	Kit de retenes completo		R330700
904960640089	Jgo. retén válvulas (12)	V	1 R330710V
904960651301	Retén bancada 130 x 160 x 12	V	1 R330411V
904960640784	Retén distribución 78 x 100 x 13	V	1 R310412V

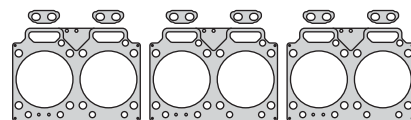

331208



330410

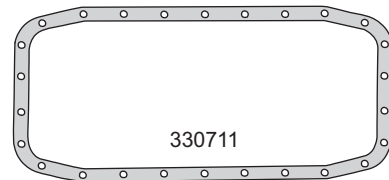

330711



330415



330417

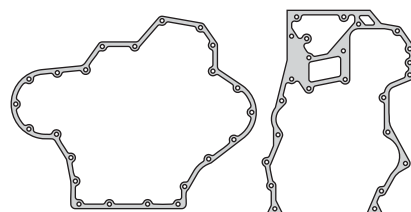

331212

331213

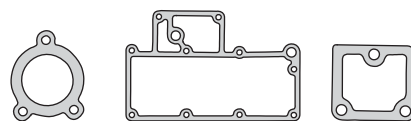

330419

330432

330430

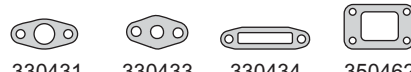

330431

330433

330434

350462

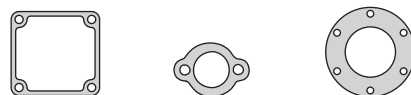

331245

330435

310563

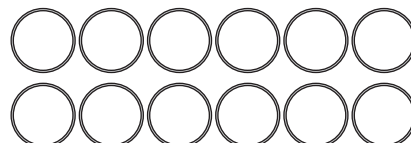

310470



330470-0.10

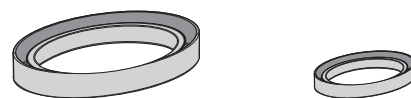

R330411V

R310412V

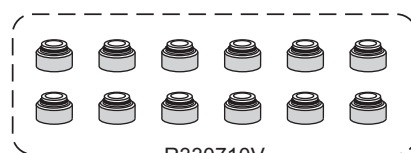

R330710V

MWM



Motor/Engine	Cm³	HP	Ø
D225-4	2977	68	95
D225-4	3400	68	95

Fiat: 850E
Valmet: Tractor 85ID 1970/76



DIESEL

Nº OE	Descripción/Description	Mat.	Ref.
922500130297	Jgo. de juntas para motor		440000
622708540024	Junta tapa cilindros Ø 110.0 ±1.20	NFT 4	320807
922508538054	Junta tapa válvulas	CG 4	310531
630508530144	Junta para cárter enterizo	NB 1	440011
632508530184	Tapa distribución	NB 1	310412
632508530154	Distribución bomba de aceite	NB 1	320813
922208570134	Tapa bomba de agua	NB 2	310414
632138570094	Multiple escape	NFT 8	310416
623208520034	Salida de escape	NFT 1	320818
922208530134	Placa bomba de agua	NB 1	310419
620808510014	Colector escape	NFT 2	440035
922508100014	Junta	NB 1	440036
922208330024	Baje filtro aceite	NB 1	310437
632508530054	Tapa trasera bancada	NB 1	310438
922508530014	Tapa carcasa intercambiable	NB 1	440040
90411025515	Llenado de aceite	NFT 1	310542
620508530124	Bomba inyectora	NB 1	310443
922508510014	Salida de escape	NFT 1	310445
630588530154	Acople caño escape	NFT 1	310446
632488510144	Fijación filtro de dire	NB 1	310448
922588510044	Tapa inspección	NB 1	310449
604931301124	Suplemento camisa cilindros G110 x 4	V 8	310470
	O'ring G 42.2 x 3	GS 2	
	O'ring G 45 x 3	GS 1	
	O'ring G 20 x 4	GS 1	
	O'ring G 18.77 x 1.78	GS 4	
	O'ring G 6 x 2	GS 1	
	O'ring G 30.8 x 3.7	GS 1	
906901281017	Arandela A 10 x 21 x 2 C	CU 4	
904920101418	Arandela A 14 x 18 x 1.5 A	AL 16	
	Arandela A 8 x 12 x 1 A	AL 4	
904920102227	Arandela A 22 x 27 x 1.5 C	CU 1	
	Arandela A 13 x 18 x 1.5 C	CU 2	
	Arandela A 10 x 14 x 1 C	CU 1	
90492010081	Arandela A 8 x 14 x 1 A	AL 3	
	Arandela A 20 x 26 x 1 A	AL 1	
	Kit de retenes completo		R310400
	Jgo. retén de válvulas (8)	V	R310410V
	Retén bancada 110 x 130 x 13	P	R310411P
	Retén distribución 78 x 100 x 13	V	R310412V

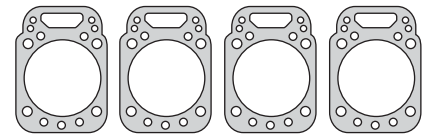

320807

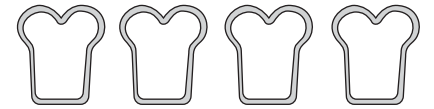

310531

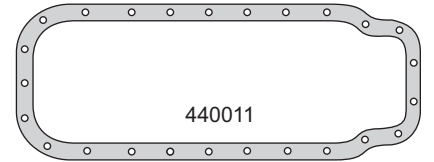

440011

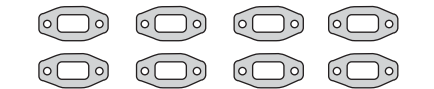

310416

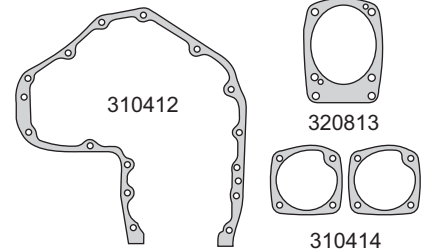

310412

320813

310414

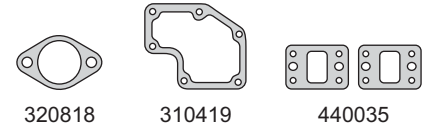

320818

310419

440035

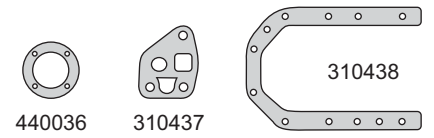

440036

310437

310438

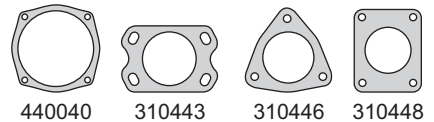

440040

310443

310446

310448

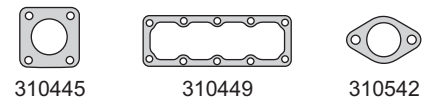

310445

310449

310542

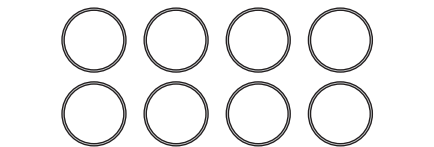

310470

G 45 x 3

G 42.2 x 3

G 30.8 x 3.7

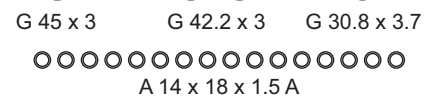

A 14 x 18 x 1.5 A



R310411P

R310412V



R310410V

MWM



Motor/Engine	Cm³	HP	Ø
D225-6	5100	102	95

Dodge: Camión 1978/...
Fiat: Tractor AD7B, 980E, S90
Valmet: Tractor 110ID



DIESEL

Nº OE	Descripción/Description	Mat.	Ref.
922500130318	Jgo. de juntas para motor	●	440100-R
622708540014	Junta tapa cilindros Ø 110.0 ± 1.20	NFT	6 320807
922508538054	Juntas tapa válvulas	CG	6 310531
630508530164	Jgo. junta para cárter (4)	NB	1 310511
632508530184	Tapa distribución	NB	1 310412
632508530154	Distribución bomba aceite	NB	1 320813
922208530134	Bomba de agua	NB	2 310414
632138530094	Múltiple escape	NFT	12 310416
623208520034	Salida de escape	NFT	1 320818
922208530134	Placa bomba de agua	NB	1 310419
922508500014	Junta	NB	1 440036
922208330024	Base filtro aceite	NB	1 310437
632508530054	Tapa trasera bancada	NB	1 310438
	Complemento cárter	NB	2 310539
922508530014	Tapa carcasa intercambiador	NB	1 440040
	Complemento cárter	NB	2 310540
90411025515	Acople caño escape	NB	1 310541
620508530124	Bomba inyectora	NB	1 310443
922508510014	Acople salida de escape	NFT	1 310445
632488510144	Fijación filtro aire	NB	1 310448
604931301124	Suplemento camisa cilindros G110 x 4	V	12 310470
	O'ring G 42.2 x 3	GS	2
	O'ring G 45 x 3	GS	1
	O'ring G 20 x 4	GS	1
	O'ring G 18.77 x 1.78	GS	6
	O'ring G 6 x 2	GS	1
	O'ring G 30.8 x 3.7	GS	1
	Arandela A 22 x 27 x 1.5 C	CU	1
904920101418	Arandelas A 14 x 18 x 1.5 A	AL	16
	Arandelas A 12 x 18 x 1.5 A	AL	2
90492010081	Arandelas A 8 x 14 x 1 A	AL	3
	Arandelas A 10 x 14 x 1 C	CU	1
904960182227	Arandelas A 20 x 26 x 1 A	AL	1
9069012081017	Arandelas A 10 x 20 x 1 C	CU	6
	Jgo. retén válvulas (12)	V	R310510V
	Retén bancada 110 x 130 x 13	P	1 R310411P
	Retén distribución 78 x 100 x 13	V	1 R310412V

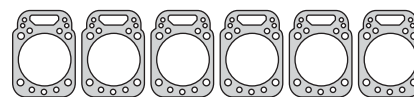

320807



310531

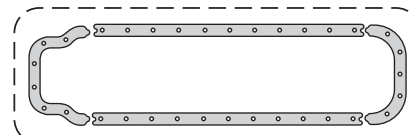

310511

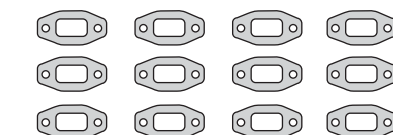

310416

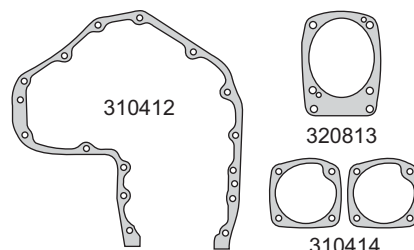

310412

320813

310414

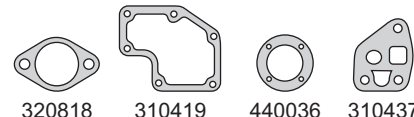

320818

310419

440036

310437

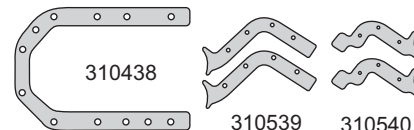

310438

310539

310540

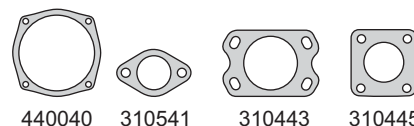

440040

310541

310443

310445

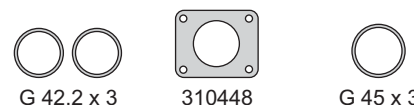

G 42.2 x 3

310448

G 45 x 3

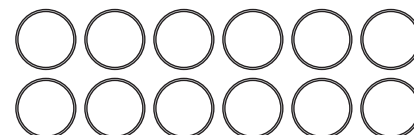

310470



G 20 x 4

G 18.77 x 1.78

G 6 x 2



G 30.8 x 3.7

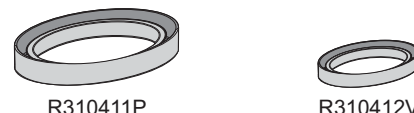

R310411P

R310412V

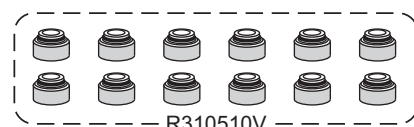

R310510V

NISSAN



Motor / Engine	Cm ³	HP	Ø
H15	1500		76

Nissan: Tractor

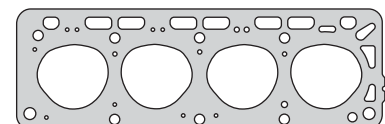

901907

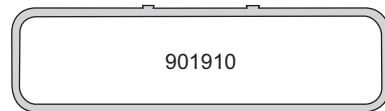

901910

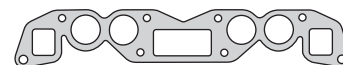

901917

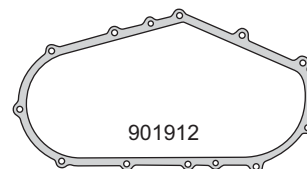

901912

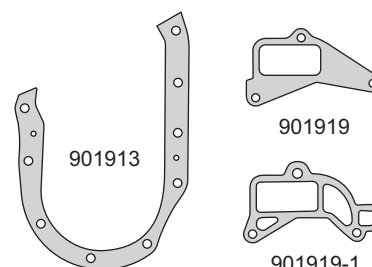

901913

901919

901919-1



901923



901927



901926



901928



901930



901931



R901911S



R901912S



R901913S

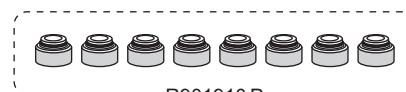

R901910P

Nº OE	Descripción / Description	Mat.	Ref.
	Jgo. de juntas para motor		901900-R
	Junta tapa cilindros Ø 77.5 ± 1.70	NFT	1 901907
	Sellador líquido - caucho de silicona		TRN0085G
	Junta tapa de válvulas	CG	1 901910
	Tapa distribución	NB	1 901912
	Placa distribución	CG	1 901913
	Múltiple admisión	NFT	1 901917
	Junta termostato	NB	1 901919
	Junta termostato	NB	1 901919-1
	Base carburador	NB	1 901923
	Junta carburador	NB	1 901926
	Bomba de aceite	NB	1 901927
	Chupador aceite	NB	1 901928
	Junta brida	NB	2 901930
	Junta brida	NB	1 901931
	Kit de retenes completo		R901900
	Jgo. retén válvulas (8)	P	1 R901910P
	Retén bancada 80 x 100 x 12	S	1 R901911S
	Retén distribución 70 x 95 x 13	S	1 R901912S
	Retén árbol de levas 48 x 70 x 9	S	1 R901913S

NISSAN



Motor / Engine **Cm³** **HP** **Ø**

SD15 **1500** **83**
SD16 **1600** **83**

Nissan: Tractor, Autoelevador

DIESEL



Nº OE	Descripción / Description	Mat.	Ref.
	Jgo. de juntas para motor	●	902000-R
	Junta tapa cilindros Ø 85.5 \times 1.70	NFT	1 902007
	Junta tapa de válvulas	GS	1 902010
	Jgo. junta para cárter (3)	NB	1 902011
	Tapa distribución	NB	1 902012
	Placa distribución	NB	1 902013
	Bomba de agua	NB	1 902014
	Múltiple admisión	NFT	1 902017
	Junta termostato	NB	1 902019
	Base filtro de aceite	NB	1 902022
	Bomba de aceite	NB	1 902027
	Placa filtro de aceite	NB	1 902029
	Inspección distribución	NB	1 902030
	Cámara de agua	NB	1 902031
	Arandela fijación tapa de válvulas	AC/GS	2 902033
	Cierre bancada	AC/GS	2 902035
	Inspección distribución	NB	1 902037
	Junta	NB	1 902040
	Junta	NB	1 902041
	Arandela A 7 x 12 x 2	AC/GS	4
	Arandela A 9.5 x 14 x 4.30	AC/GS	1
	Arandela A 9.5 x 15 x 2	AC/GS	2
	Arandela A 16.5 x 22 x 2.40	AC/GS	2
	O´ring G 26 x 3	GS	1
	Kit de retenes completo		R902000
	Jgo. retén válvulas (6)	P	1 R902010P
	Retén bancada 71.6 x 92.7 x 6.2	S	R902011S
	Retén distribución 58 x 80/88 x 12	S	1 R902012S

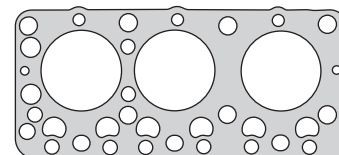

902007



902010

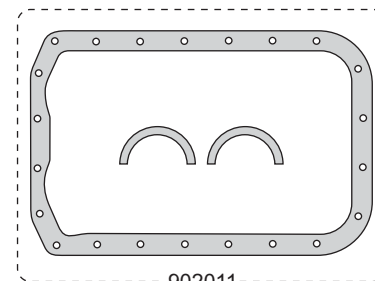

902011



902017

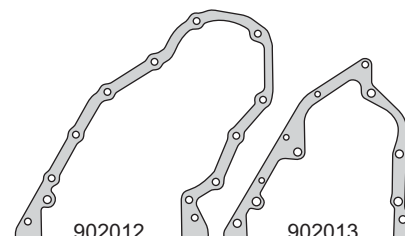

902012

902013

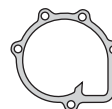

902014



902019



902022



902027



902030

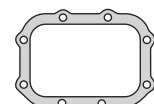

902029



902031



902033



902035

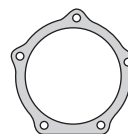

902037

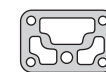

902040



A 7 x 12 x 2



902041



A 9.5 x 15 x 2



G 26 x 3



A 9.5 x 14 x 4.30



A 16.5 x 22 x 2.40



R902011S



R902012S



R902010V

NISSAN



Motor / Engine **Cm³** **HP** **Ø**

H20-II
(DOHC) 8V **1982** **92** **87.2**

Nissan: Autoelevador 1983/...

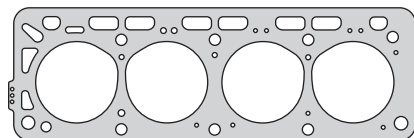

904907

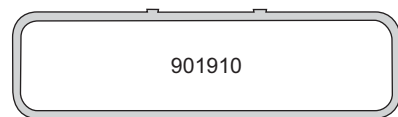

901910

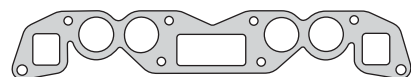

901917

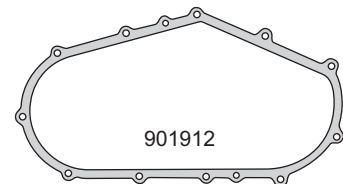

901912

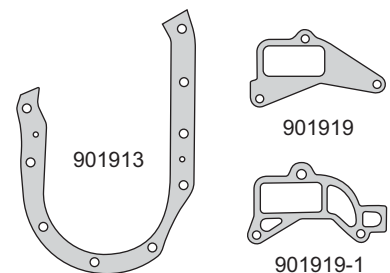

901913

901919

901919-1



901923



901927

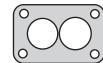

901926



901928



901930



901931



R901911S



R901912S



R901913S



R901910P

Nº OE	Descripción / Description	Mat.	Ref.
	Jgo. de juntas para motor		904900-R
	Junta tapa cilindros Ø 89.5 ± 1.70 N.R.	NFT	1 904907
	Sellador líquido - caucho de silicona		TRN0085G
	Junta tapa de válvulas	CG	1 901910
	Tapa distribución	NB	1 901912
	Placa distribución	CG	1 901913
	Múltiple admisión	NFT	1 901917
	Junta termostato	NB	1 901919
	Junta termostato	NB	1 901919-1
	Base carburador	NB	1 901923
	Junta carburador	NB	1 901926
	Bomba de aceite	NB	1 901927
	Chupador aceite	NB	1 901928
	Junta brida	NB	2 901930
	Junta brida	NB	1 901931
	Kit de retenes completo		R901900
	Jgo. retén válvulas (8)	P	1 R901910P
	Retén bancada 80 x 100 x 12	S	1 R901911S
	Retén distribución 70 x 95 x 13	S	1 R901912S
	Retén árbol de levas 48 x 70 x 9	S	1 R901913S

NISSAN



Motor / Engine **Cm³** **HP** **Ø**

H25
(DOHC) 8V **2472** **62** **92**

Nissan: Tractor, Autoelevador



Nº OE	Descripción / Description	Mat.	Ref.
	Jgo. de juntas para motor	●	905900-R
	Junta tapa cilindros Ø 94.0 \pm 1.70	NFT	1 905907
	Sellador líquido - caucho de silicona		TRN0085G
	Junta tapa de válvulas	CG	1 905910
	Junta distribución	NB	1 905912
	Junta distribución	NB	1 905913
	Bomba de agua	NB	1 905914
	Múltiple admisión y escape	NFT	1 905916
	Junta termostato	NB	1 905919
	Junta carburador	NB	1 905925
	Junta bomba de aceite	NB	1 905927
	Junta bomba combustible	NB	2 905928
	Salida de agua	NB	1 905929
	Junta chupador aceite	NB	1 905937
	Arandela A 36.5 x 55.5 x 3	CG	1
	O´ring G 24.99 x 3.53	GS	1
	Kit de retenes completo		R905900
	Jgo. retén válvulas (8)	P	1 R901910P
	Retén bancada 80 x 100 x 8.5	S	1 R924111S
	Retén distribución 48 x 70 x 9	S	1 R900012S

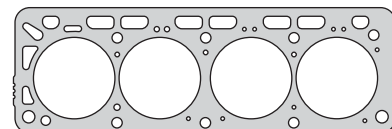

905907



905910

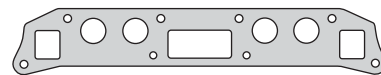

905912

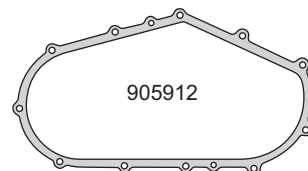

905913

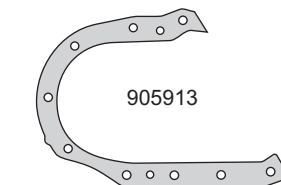

905914



905916

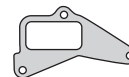

905919



905925



905927



905928



905929



905937



A 36.5 x 55.5 x 3



G 24.99 x 3.53



R924111S



R900012S



R901910 P

NISSAN



Motor / Engine	Cm ³	HP	Ø
BD30 (SOHC) 8V	2953	86	96
DIESEL			

Nissan: Tractor 1992/...
Condor 1992/94

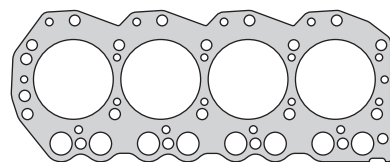

906708

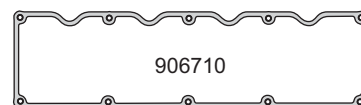

906710

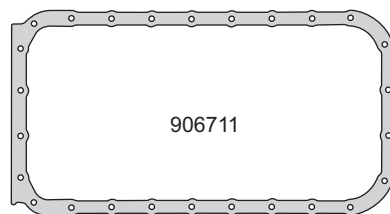

906711

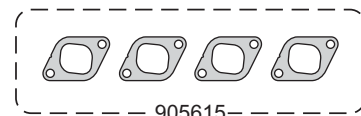

905615



905617

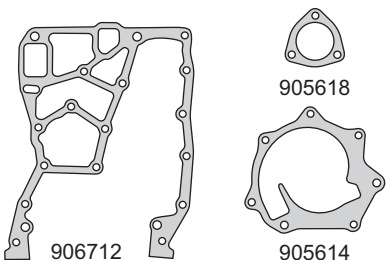

906712

905618

905614

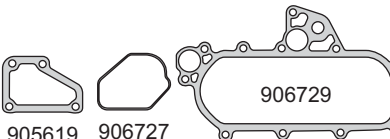

905619

906727

906729

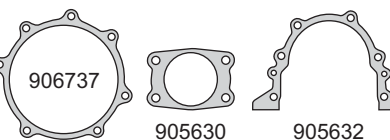

906737

905630

905632

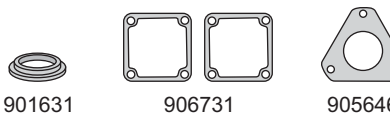

901631

906731

905646



905640

905641

905642

G 14 x 2.50



A 8.5 x 16 x 1 C

A 12.40 x 16.7 x 1 A

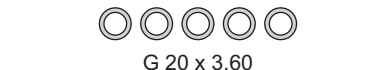

G 20 x 3.60



R920211V

R920212V

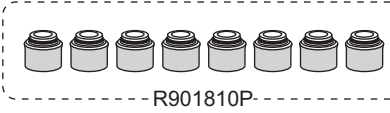

R901810P

Nº OE	Descripción / Description	Mat.	Ref.
	Jgo. de juntas para motor		● 906700-R MLS
	Junta tapa cilindros Ø 97.0 \pm 1.20	MLS	906708-1M
	Junta tapa cilindros Ø 97.0 \pm 1.25	MLS	906708-2M
	Junta tapa cilindros Ø 97.0 \pm 1.30	MLS	906708-3M
	Junta tapa cilindros Ø 97.0 \pm 1.25	MLS	1 906708
	Junta tapa de válvulas	AC/GS	1 906710
	Junta para cárter	NB	1 906711
	Frente motor	NB	1 906712
	Bomba de agua	NB	1 905614
	Jgo. múltiple escape (4)	AC	1 905615
	Múltiple admisión	SLS	1 905617
	Salida de escape	NB	1 905618
	Junta termostato	NB	1 905619
	Guarnición bomba aceite a block	GS	1 905627
	Radiador aceite	SLS	1 906729
	Inspección distribución	NB	1 905630
	Guarnición tapón depósito aceite G 32 x 43 x 5.5	GS	1 901631
	Base precalentador aire	NB	2 906731
	Porta retén trasero	NB	1 905632
	Inspección distribución	NB	1 906737
	Guarnición goma	GS	1 905640
	Guarnición goma	GS	1 905641
	Guarnición goma	GS	1 905642
	Junta bomba inyectora	NB	1 905646
	Arandela tapón cárter A 15.3 x 22 x 3.27 C	CU	1
	Arandela A 8.5 x 16 x 1 C	CU	4
	Arandela A 12.40 x 16.7 x 1 A	AL	1
	O'ring G 14 x 2.50	GS	4
	O'ring G 20 x 3.60	GS	5
	Kit de retenes completo		R905600
	Jgo. retén válvulas (8)	S	1 R901810P
	Retén bancada 86 x 100 x 10	S	1 R920211V
	Retén distribución 58 x 80 x 10	S	1 R920212V

NISSAN



Motor/Engine	Cm³	HP	Ø
BD30-Ti (OHV) 8V	3000	86	96

Nissan: Trade 1993/96, Cabstar 1998/2001

DIESEL



Nº OE	Descripción/Description	Mat.	Ref.
	Jgo. de juntas para motor		● 906800-R MLS
	Jgo. de juntas para motor	●	906895
	Jta. tapa cilindros Ø 97.0 \pm 1.20	MLS	906708-1M
	Jta. tapa cilindros Ø 97.0 \pm 1.25	MLS	906708-2M
	Jta. tapa cilindros Ø 97.0 \pm 1.30	MLS	906708-3M
	Jta. tapa cilindros Ø 97.0 \pm 1.25	MLS	1 1 906708
	Junta tapa de válvulas	GS	1 1 906710
	Junta para cárter	NB	1 906711
	Frente motor	NB	1 906712
	Bomba de agua	NB	1 905614
	Múltiple escape	AC	1 1 906815
	Múltiple admisión	SLS	1 905617
	Salida de escape	NB	1 905618
	Salida de escape	AC	1 906318
	Junta termostato	SLS	1 1 905619
	Guarnición bomba aceite a block	GS	1 906827
	Radiador aceite	NB	1 905629
	Guarnición tapón depósito aceite G 32 x 43 x 5.5	GS	1 1 901631
	Base precalentador aire	NB	1 1 906731
	Porta retén trasero	NB	1 905632
	Junta sensor de presión	NB	1 906833
	Válvula control ventilación	NB	1 905634
	Junta entrada aire	NB	1 906838
	Tapa termostato	NB	1 906839
	Guarnición goma	GS	1 905640
	Guarnición goma	GS	1 1 905641
	Entrada de aire a turbo	NB	1 906841
	Guarnición goma	NFT	1 905642
	Junta	NB	2 906842
	Junta bomba inyectora	NB	1 905646
	Acople bomba inyectora	AC	1 906846
	Limitador de torque A 7.5 x 9 x 13 A	AL	10 10
	Arandela tapón cárter A 15.3 x 22 x 3.27 C	CU	1
	Arandela A 8.5 x 16 x 1 C	CU	4 4
	Arandela A 10.4 x 15.7 x 1 C	CU	2
	Arandela A 11.8 x 19.5 x 1 C	CU	4
	Arandela A 12 x 16 x 1.15 A	AL	1 1
	Arandela A 12 x 18 x 1 C	CU	4 4
	Arandela A 14.4 x 21 x 1 A	AL	4
	Anillo G 6 x 15 x 7	AC/GS	10
	Anillo G 53.5 x 43 x 3	GS	1
	O'ring G 15.5 x 2.45	GS	4
	O'ring G 19 x 3	GS	1
	O'ring G 20 x 3.70	GS	1
	Kit de retenes completo		R905600
	Jgo. retén válvulas (8)	P	1 1 R901810P
	Retén bancada 86 x 100 x 10	V	1 R920211V
	Retén distribución 58 x 80 x 10	V	1 R920212V

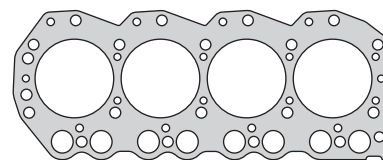

906708

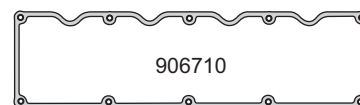

906710

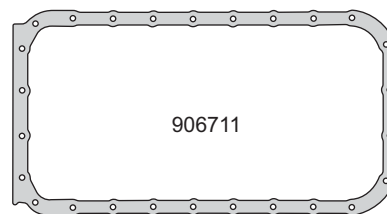

906711



906815



905617

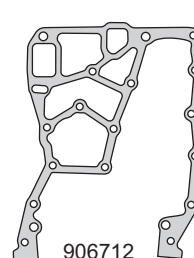

906712

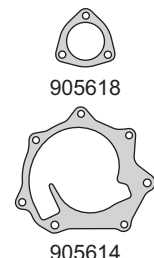

905614

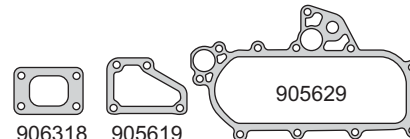

905629



906318



905619



906827



901631

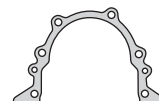

905632



906731



906833



905634



906838



905640



905641



905642



906841



906839



906842



906846



905646



G 6 x 15 x 7



R920211V



R920212V

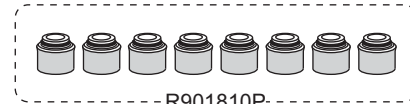

R901810P

NISSAN



Motor / Engine **Cm³** **HP** **Ø**

SD33 **3246** **95/100** **83**
(OHV) 12V

Nissan: Truck 1980/..., Patrol 1982/89

DIESEL

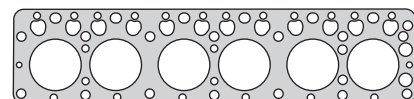

907007

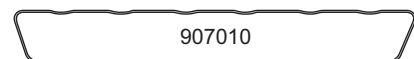

907010

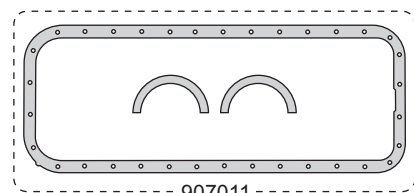

907011



907016

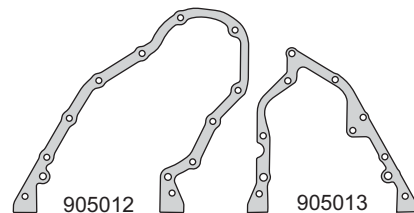

905012

905013

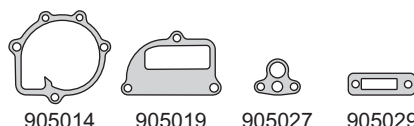

905014

905019

905027

905029

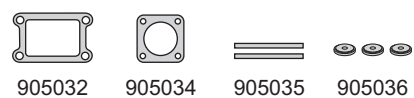

905032

905034

905035

905036

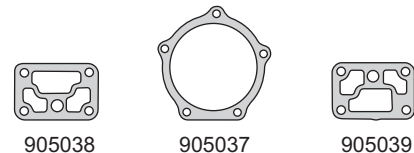

905038

905037

905039

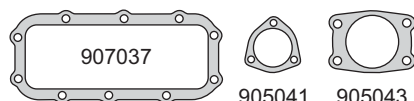

907037

905041

905043



G 7 x 12 x 2

905046

G 9.6 x 15 x 2



G 16.5 x 22 x 2.40

G 27 x 3

G 9.3 x 14 x 4.30



R905012S

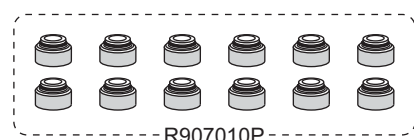

R907010P

Nº OE	Descripción / Description	Mat.	Ref.
	Jgo. de juntas para motor		907000-R
	Junta tapa cilindros Ø 85.5 ± 1.30	NFT	1 907007
	Junta tapa de válvulas	GS	1 907010
	Jgo. junta para cárter (3)	CG	1 907011
	Tapa distribución	NB	1 905012
	Placa distribución	NB	1 905013
	Bomba de agua	NB	1 905014
	Múltiple admisión y escape	GFT	1 907016
	Junta termostato	NB	1 905019
	Junta bomba de aceite	NB	1 905027
	Junta retorno agua	NB	1 905029
	Junta filtro aceite a block	NB	1 905032
	Junta curva escape	NB	1 905034
	Junta cierre bancada	AC/GS	2 905035
	Arandela fijación tapa válvula	AC/GS	3 905036
	Refrigerador aceite	NB	1 907037
	Placa distribución bomba inyectora	NB	1 905037
	SopORTE filtro aceite a block	NB	1 905038
	SopORTE filtro aceite a block	NB	1 905039
	Salida de agua	NB	1 905041
	Bomba inyectora	NB	1 905043
	Acople con escape	NB	1 905046
	Anillo G 7 x 12 x 2	AC/GS	6
	Anillo G 9.6 x 15 x 2	AC/GS	2
	Anillo G 16.5 x 22 x 2.40	AC/GS	2
	Anillo G 9.3 x 14 x 4.30	AC/GS	1
	O´ring G 27 x 3	GS	1
	Kit de retenes completo		R907000
	Jgo. retén válvulas (12)	P	1 R907010P
	Retén distribución 58 x 80/88.5 x 12	S	1 R905012S

NISSAN



Motor / Engine Cm³ HP Ø

SD33T (OHV) 12V 3246 115 83

Nissan: Truck 1986/..., Patrol 1983/...

DIESEL



Nº OE	Descripción / Description	Mat.	Ref.
	Jgo. de juntas para motor		907100-R MLS
	Junta tapa cilindros Ø 86.0 ± 1.40	MLS	1 907108
	Junta tapa de válvulas	GS	1 907110
	Jgo. junta para cárter (3)	CG	1 907011
	Tapa distribución	NB	1 905012
	Placa distribución	NB	1 905013
	Bomba de agua	NB	1 905014
	Múltiple admisión y escape	GFT	1 907116
	Junta termostato	NB	1 905019
	Junta bomba de aceite	NB	1 905027
	Junta retorno agua	NB	1 905029
	Junta filtro aceite a block	NB	1 905032
	Junta curva escape	NB	1 905034
	Junta cierre bancada	AC/GS	2 905035
	Arandela fijación tapa válvula	AC/GS	3 905036
	Refrigerador aceite	NB	1 907037
	Placa distribución bomba inyectora	NB	1 905037
	Soporte filtro aceite a block	NB	1 905038
	Soporte filtro aceite a block	NB	1 905039
	Salida de agua	NB	1 905041
	Bomba inyectora	NB	1 905043
	Acople con escape	NB	1 905046
	Anillo G 9.3 x 14 x 4.30	AC/GS	1
	O´ring G 27 x 3	GS	1
	Kit de retenes completo		R907100
	Jgo. retén válvulas (12)	P	1 R907110P
	Retén bancada 86 x 100 x 10	S	1 R920211S
	Retén distribución 58 x 80 x 10	S	1 R920212S

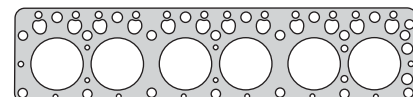

907108

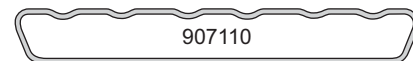

907110

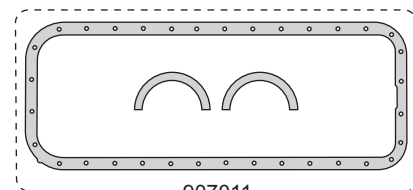

907011



905012

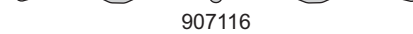

905013



905014

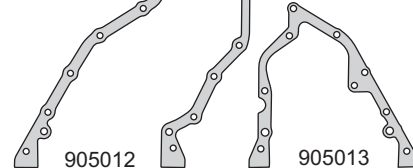

907116



905019



905027



905029



905032

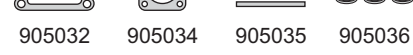

905034



905035



905036



907037



905037



905038



905041



905043



905046

G 9.3 x 14 x 4.30

G 27 x 3



R920211S



R920212S

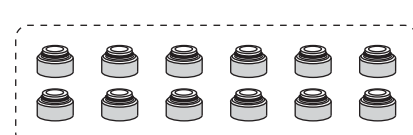

R907110P

NISSAN



Motor / Engine **Cm³** **HP** **Ø**

FD33 **3298** **99** **108**

Nissan: Atlas 1984/86, Truck 1984/...

DIESEL



Nº OE	Descripción / Description	Mat.	Ref.
	Jgo. de juntas para motor		907200-R
	Junta tapa cilindros Ø 110.0 ± 1.60	CNC 1	907208
	Junta tapa válvulas	GS 1	907210
	Junta para cárter	NB 1	907211
	Frente motor	NB 1	907212
	Frente motor	NB 1	907213
	Bomba de agua	NB 1	907214
	Jgo. múltiple escape (4)	AC 1	907215
	Múltiple admisión	GS 1	907217
	Junta termostato	NB 1	907219
	Base carburador	NB 2	907225
	Bomba aceite a block	NB 1	907231
	Cierre lado volante	NB 1	907233
	Junta entrada de aceite	NB 4	907234
	Junta filtro aceite	NB 1	907235
	Arandela con inserto tapa válvulas	AC/GS 4	907236
	Junta refrigeración aceite	NB 1	907237
	Base precalentador aire	GFT 1	907238
	Salida de agua	NB 1	907239
	Junta	NB 1	907240
	Junta	NB 1	907241
	Comando bomba combustible	NB 1	907246
	Arandela especial A 8 x 16.6 x 2.90	AC/GS 4	
	Arandela especial A 10 x 19 x 4.30	AC/GS 4	
	Arandela tapón cárter A 15 x 22 x 3.30 C	CU 1	
	Arandela A 7.5 x 15.5 x 1 C	CU 4	
	Arandela A 12 x 16 x 1 C	CU 1	
	O'ring G 19.5 x 2.40	GS 2	
	O'ring G 23.5 x 3.30	GS 2	
	O'ring G 25.5 x 3	GS 1	
	O'ring G 40 x 2.50	GS 1	
	O'ring G 70 x 2.53	GS 1	
	O'ring G 150 x 2	GS 1	
	Kit de retenes completo		R907200
	Jgo. retén válvulas (8)	P 1	R907210P
	Retén bancada 105 x 135 x 12.5	S 1	R907211S
	Retén distribución 62 x 85 x 12	S 1	R907212S

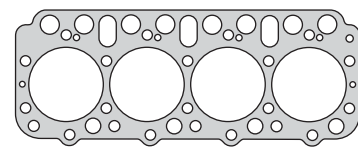

907208

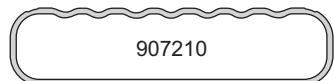

907210

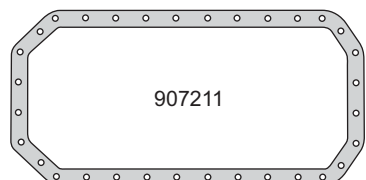

907211

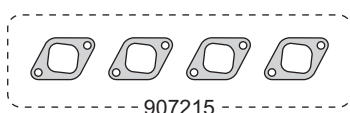

907215



907217

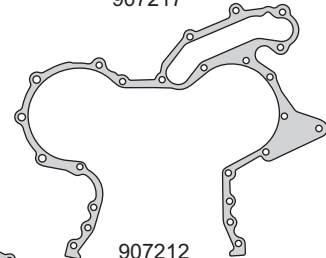

907212

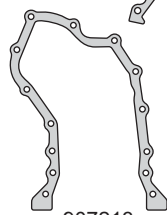

907213



907214



907219

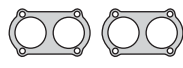

907225



907235



907231

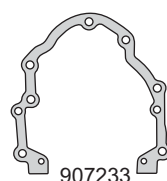

907233



907238

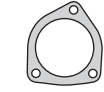

907239



907234

907236

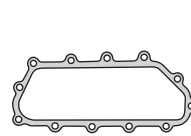

907237



907240

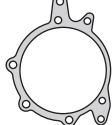

907241

907246



A 10 x 19 x 4.30



A 8 x 16.6 x 2.90



R907211S



R907212S



R907210P

NISSAN



Motor / Engine **Cm³** **HP** **Ø**

FD33T **3298** **118** **108**

Nissan: Atlas 1983/86, Civilian 1984/88
Truck 1984/...

DIESEL



Nº OE	Descripción / Description	Mat.	Ref.
	Jgo. de juntas para motor		● 907300-R MLS
	Junta tapa cilindros Ø 110.0 ± 1.60	CNC	1 907208
	Junta tapa válvulas	GS	1 907310
	Junta para cárter	NB	1 907211
	Frente motor	NB	1 907212
	Frente motor	NB	1 907213
	Bomba de agua	NB	1 907214
	Bomba de agua	NB	1 907314
	Jgo. múltiple escape (4)	AC	1 907215
	Múltiple admisión	GS	1 907217
	Junta termostato	NB	1 907219
	Base carburador	NB	2 907225
	Bomba aceite a block	NB	1 907231
	Cierre lado volante	NB	1 907233
	Arandela con inserto tapa válvulas	AC/GS	8 907333
	Junta entrada de aceite	NB	4 907234
	Junta filtro aceite	NB	1 907235
	Arandela con inserto tapa válvulas	AC/GS	8 907336
	Junta refrigeración aceite	NB	1 907237
	Base precalentador aire	GFT	1 907238
	Guarnición goma G 77 x 85 x 3.40	GS	1 907338
	Salida de agua	NB	1 907239
	Junta	NB	1 907240
	Junta	NB	1 907241
	Guarnición goma	GS	4 907342
	Comando bomba combustible	NB	1 907346
	Arandela A 12 x 16.5 x 1 A	AL	1
	Arandela A 10 x 14.5 x 1 A	AL	8
	Arandela A 8 x 12 x 1 A	AL	4
	Arandela A 10.3 x 15.7 x 1 C	CU	1
	O'ring G 22 x 4	GS	4
	O'ring G 39 x 3	GS	1
	Kit de retenes completo		R907300
	Jgo. retén válvulas (8)	P	1 R907210P
	Retén bancada 105 x 135 x 12.5	S	1 R907311S
	Retén distribución 62 x 85 x 12	S	1 R907312S

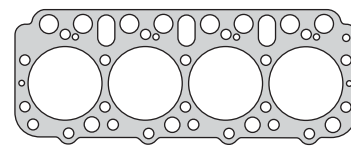

907208

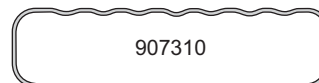

907310

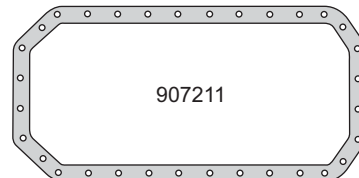

907211

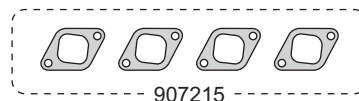

907215



907217

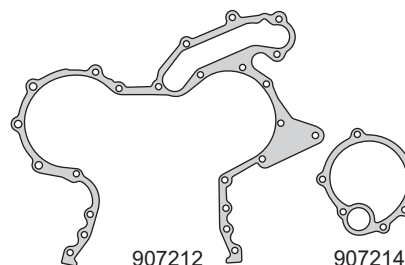

907212

907214

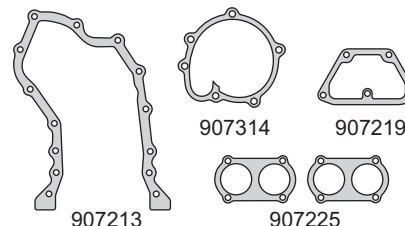

907314

907219

907213

907225

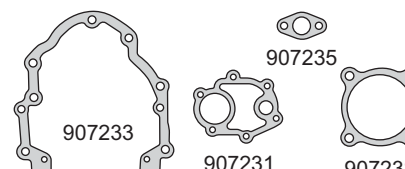

907233

907231

907238



907333

907336

907239

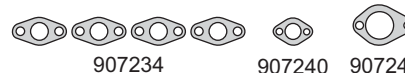

907234

907240

907241

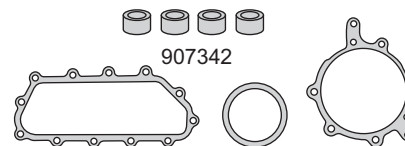

907342

907237

907338

907346

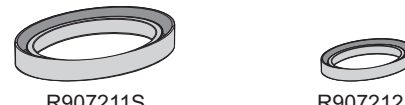

R907211S

R907212S

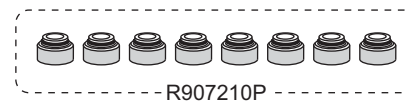

R907210P

NISSAN



Motor / Engine **Cm³** **HP** **Ø**

ED6
(SOHC) 12V **5654** **HP** **109**

Nissan: Camion 5700 1978/...

DIESEL

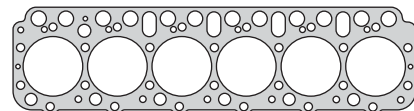

907408

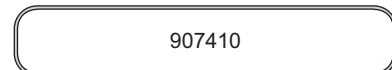

907410

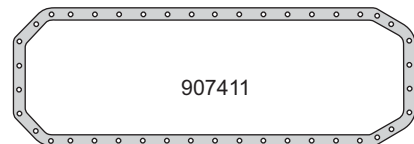

907411

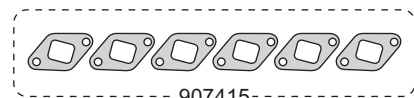

907415



907417

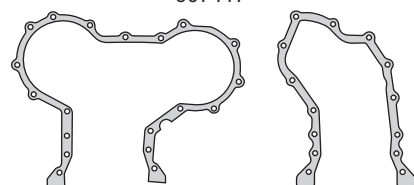

907412

907313

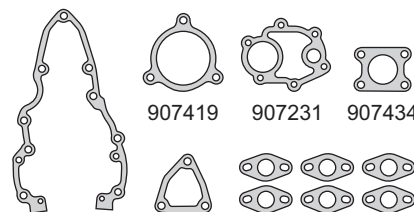

907419

907231

907434

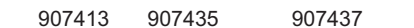

907413

907435

907437

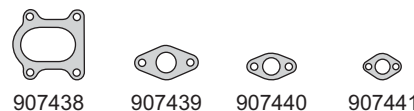

907438

907439

907440

907441



907444

907342

907445

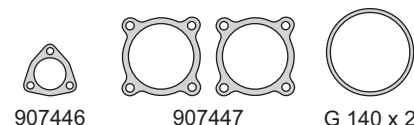

907446

907447

G 140 x 2



G 23.39 x 3.53



G 44.04 x 3.53

G 6.5 x 2

G 50.39 x 3.53



G 27 x 33.5 x 4



R907412S

R907411S

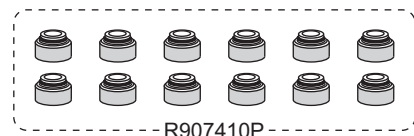

R907410P

Nº OE	Descripción / Description	Mat.	Ref.
	Jgo. de juntas para motor		907400-R
	Junta tapa cilindros Ø 110.5 ± 1.60	ACG 1	907408
	Junta tapa válvulas	GS 1	907410
	Junta para cárter	NB 1	907411
	Frente motor	NB 1	907412
	Junta distribución	NB 1	907313
	Junta distribución	NB 1	907413
	Jgo. múltiple escape (6)	FCH 1	907415
	Múltiple admisión	GS 1	907417
	Junta termostato	NB 1	907419
	Junta bomba de aceite	NB 1	907231
	Tapa diferencial	NB 1	907434
	Bomba hidráulica	NB 1	907435
	Junta entrada de agua	NB 6	907437
	Junta	NB 1	907438
	Junta	NB 1	907439
	Acople bomba dirección	NB 1	907440
	Junta	NB 1	907441
	Guarnición junta tapa válvulas	GS 6	907342
	Junta salida escape turbo	FCH 1	907444
	Junta carga de aceite	NB 1	907445
	Junta comando bomba combustible	NB 1	907446
	Junta	NB 2	907447
	Arandela A 7 x 14 x 1.50 C	CU 6	
	Anillo G 27 x 33.5 x 4	S 4	
	O'ring G 6.5 x 2	GS 1	
	O'ring G 23.39 x 3.53	S 7	
	O'ring G 44.04 x 3.53	GS 2	
	O'ring G 50.39 x 3.53	GS 1	
	O'ring G 140 x 2	GS 1	
	Kit de retenes completo		R907400
	Jgo. retén válvulas (12)	P 1	R907410P
	Retén bancada 105 x 135/146 x 13	S 1	R907411S
	Retén distribución 62 x 85/93 x 13	S 1	R907412S

NISSAN



Motor / Engine **Cm³** **HP** **Ø**

FD42	4214	123	109
FD46 (DOHC) 8V	4617	133	109

Nissan: Atlas, Condor 1993/...



Nº OE	Descripción / Description	Mat.	Ref.
	Jgo. de juntas para motor		907800-R MLS
	Junta tapa cilindros Ø 110.5 ± 1.50	MLS 1	907808
	Junta tapa válvulas	GS 1	907810
	Junta para cárter	NB 1	907811
	Frente motor	NB 1	907812
	Frente motor	NB 1	907813
	Bomba de agua	NB 1	907814
	Jgo. múltiple escape (4)	AC 1	907815
	Múltiple admisión	NB 1	907817
	Base a colector admision	AC 1	907830
	Guarnición tapón depósito aceite G 32 x 43 x 5.5	NB 1	901631
	Bomba aceite a block	NB 1	907231
	Base precalentador aire	NFT 1	907832
	Cierre lado volante	NB 1	907833
	Enfriador de aceite	NB 1	907835
	Refrigeración aceite	NB 1	907837
	Guarnición goma G 76 x 84 x 3.50	GS 1	907838
	Tubería agua a block	NB 1	907839
	Junta	NB 1	907840
	Arandela tapón cárter A 15.45 x 22 x 3.30 C	CU 1	
	Arandela A 8.5 x 16 x 1 C	CU 4	
	Arandela A 12 x 16 x 1.20 A	AL 1	
	Arandela A 18 x 24 x 1.58 A	AL 1	
	Arandela A 36.5 x 44 x 2 C	GS 1	
	Anillo G 21 x 28 x 4	GS 4	
	O'ring G 15 x 2.53	GS 4	
	O'ring G 150 x 2	GS 1	
	Kit de retenes completo		R907800
	Jgo. retén válvulas (8)	P	R907810P
	Retén bancada 108 x 135 x 9	S	R907811S
	Retén distribución 62 x 85 x 12	S	R907812S

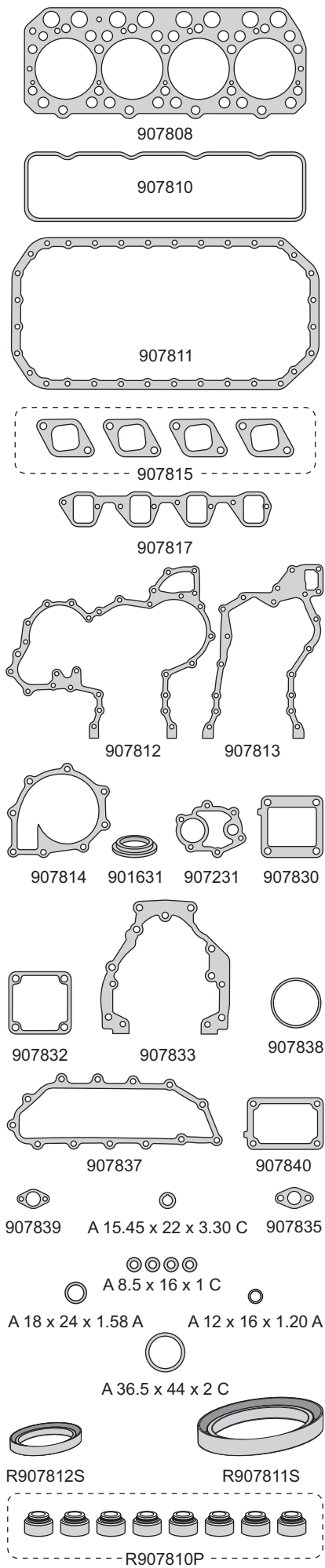

NISSAN



Motor / Engine	Cm ³	HP	Ø
FD46 (DOHC) 8V	4617	133	109

Nissan: Atlas, Condor 1995/...

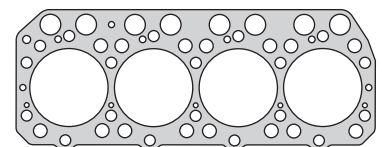

907808

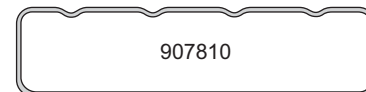

907810

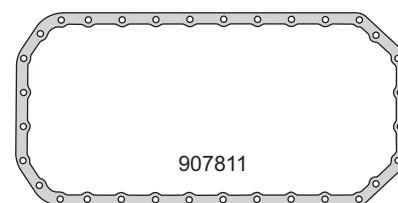

907811

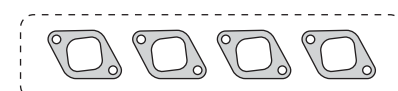

907815



907817

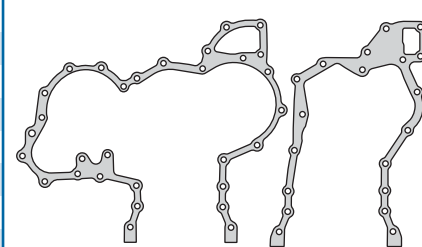

907812

907813

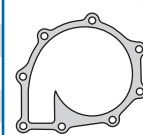

907814

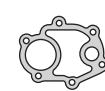

907231



907830

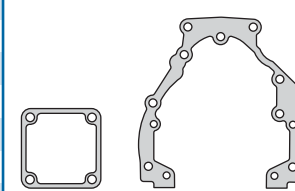

907832

907833

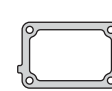

907840

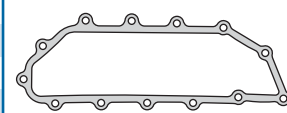

907837

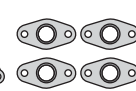

907938



907939



A 8.5 x 16 x 1 C



907935



A 12 x 16 x 1.20 A



G 15 x 2.53



G 21 x 28 x 4



R907812S



R907811S



R907810P

Nº OE	Descripción / Description	Mat.	Ref.
	Jgo. de juntas para motor		907900-R MLS
	Junta tapa cilindros Ø 110.5 ±1.50	MLS	1 907808
	Junta tapa válvulas	GS	1 907810
	Junta para cárter	NB	1 907811
	Frente motor	NB	1 907812
	Frente motor	NB	1 907813
	Bomba de agua	NB	1 907814
	Jgo. múltiple escape (4)	AC	1 907815
	Múltiple admisión	NB	1 907817
	Base a colector admision	AC	1 907830
	Bomba aceite a block	NB	1 907231
	Base precalentador aire	NFT	1 907832
	Cierre lado volante	NB	1 907833
	Enfriador de aceite	CG	1 907935
	Refrigeración aceite	NB	1 907837
	Junta	CG/GS	4 907838
	Tubería agua a block	CG	1 907939
	Junta	NB	1 907840
	Arandela A 8.5 x 16 x 1 C	CU	4
	Arandela A 12 x 16 x 1.20 A	AL	1
	Anillo G 21 x 28 x 4	GS	4
	O'ring G 15 x 2.53	GS	4
	O'ring G 150 x 2	GS	1
	Kit de retenes completo		R907800
	Jgo. retén válvulas (8)	P	1 R907810P
	Retén bancada 108 x 135 x 9	S	1 R907811S
	Retén distribución 62 x 85 x 12	S	1 R907812S

NISSAN



Motor / Engine **Cm³** **HP** **Ø**

FD6 **5654** **170** **108**

(SOHC) 12V

Nissan: Camion 5700 1980/...

DIESEL



Nº OE	Descripción / Description	Mat.	Ref.
	Jgo. de juntas para motor	●	908200-R
	Junta tapa cilindros Ø 110.0 ± 1.70	ACG	1 907408
	Junta tapa válvulas	GS	1 907410
	Junta para cárter	NB	1 907411
	Frente motor	NB	1 907412
	Junta distribución	NB	1 907313
	Junta distribución	NB	1 907413
	Jgo. múltiple escape (6)	FCH	1 907415
	Múltiple admisión	GS	1 907417
	Salida de escape	NB	2 907418
	Junta termostato	NB	1 907419
	Junta bomba de aceite	NB	1 907427
	Guarnición junta tapa válvulas	GS	6 907430
	Tapa diferencial	NB	1 907434
	Bomba hidráulica	NB	1 907435
	Junta entrada de agua	NB	6 907437
	Junta	NB	1 907438
	Junta	NB	1 907439
	Acople bomba dirección	NB	1 907440
	Junta	NB	1 907441
	Junta salida escape turbo	MLS	1 908244
	Junta carga de aceite	NB	1 907445
	Junta comando bomba combustible	NB	1 907446
	Arandela A 7 x 14 x 1.50 C	CU	6
	Anillo G 27 x 33.5 x 4	GS	4
	O'ring G 6.5 x 2	GS	1
	O'ring G 24.3 x 3.50	GS	7
	O'ring G 45 x 3.40	GS	2
	O'ring G 51 x 3.53	GS	1
	O'ring G 150 x 2	GS	1
	Kit de retenes completo		R907400
	Jgo. retén válvulas (12)	P	1 R907410P
	Retén bancada 105 x 135/146 x 13	S	1 R907411S
	Retén distribución 62 x 85/93 x 13	S	1 R907412S

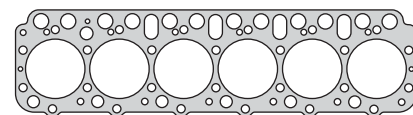

907408

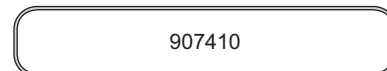

907410

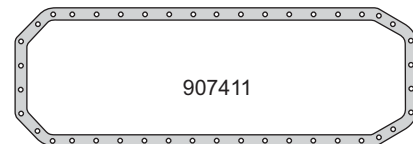

907411

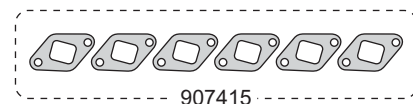

907412



907413

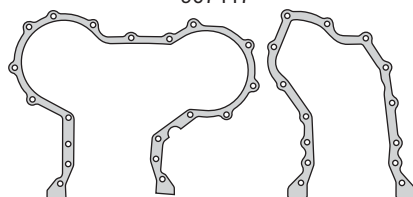

907415



907417

907418

907313



907419

907327

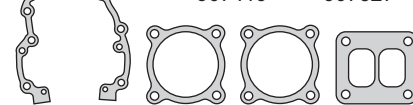

907427

907418

908244



907430

907418

908244



907434

907435

907445

907446



907437

907438

907439

907440



907439

907434

907441

907440



907441

907445

907446



908244



907445



907446



907446



G 6.5 x 2

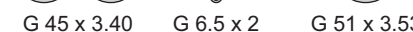

G 24.3 x 3.50



G 45 x 3.40



G 51 x 3.53

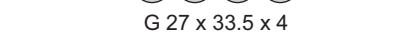

G 150 x 2



G 27 x 33.5 x 4



R907411S



R907412S



R907410P

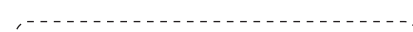

R907400

NISSAN



Motor / Engine **Cm³** **HP** **Ø**

FD6T **5654** **175** **108**

(SOHC) 12V

Nissan: Camión 5700 1975/83

DIESEL

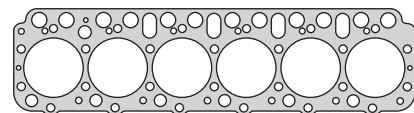

907408

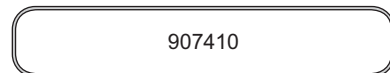

907410

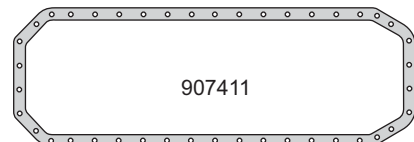

907411

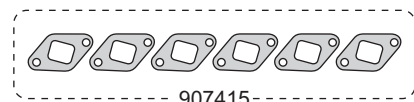

907415



907417

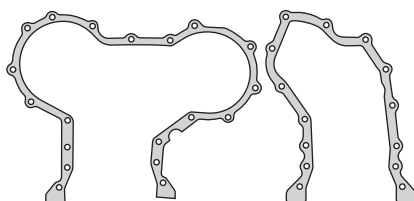

907412

907313

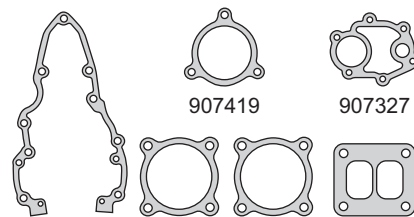

907419

907327

907413 907418 908344



907437



907438

907435

907445

907446

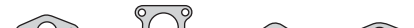

907439

907434

907441

907440



907430



G 24.3 x 3.50



G 45 x 3.40



G 6.5 x 2



G 51 x 3.53



G 27 x 33.5 x 4

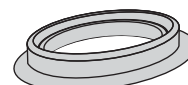

R907411S



R907412S



R907410P

Nº OE	Descripción / Description	Mat.	Ref.
	Jgo. de juntas para motor		908300-R
	Junta tapa cilindros Ø 110.0 ± 1.70	ACG 1	907408
	Junta tapa válvulas	GS 1	907410
	Junta para cárter	NB 1	907411
	Frente motor	NB 1	907412
	Junta distribución	NB 1	907313
	Junta distribución	NB 1	907413
	Jgo. múltiple escape (6)	FCH 1	907415
	Múltiple admisión	GS 1	907417
	Salida de escape	NB 2	907418
	Junta termostato	NB 1	907419
	Junta bomba de aceite	NB 1	907427
	Guarnición junta tapa válvulas	GS 6	907430
	Tapa diferencial	NB 1	907434
	Bomba hidráulica	NB 1	907435
	Junta entrada de agua	NB 6	907437
	Junta	NB 1	907438
	Junta	NB 1	907439
	Acople bomba dirección	NB 1	907440
	Junta	NB 1	907441
	Junta salida escape turbo	MLS 1	908344
	Junta carga de aceite	NB 1	907445
	Junta comando bomba combustible	NB 1	907446
	Arandela A 7 x 14 x 1.50 C	CU 6	
	Anillo G 27 x 33.5 x 4	GS 4	
	O'ring G 6.5 x 2	GS 1	
	O'ring G 24.3 x 3.50	GS 7	
	O'ring G 45 x 3.40	GS 2	
	O'ring G 51 x 3.53	GS 1	
	O'ring G 150 x 2	GS 1	
	Kit de retenes completo		R907400
	Jgo. retén válvulas (12)	P 1	R907410P
	Retén bancada 105 x 135/146 x 13	S 1	R907411S
	Retén distribución 62 x 85/93 x 13	S 1	R907412S

NISSAN



Motor / Engine **Cm³** **HP** **Ø**

ND6
(SOHC) 12V **6842** **133** **110**

Nissan: Camión, Bus 1977/...

DIESEL



Nº OE	Descripción / Description	Mat.	Ref.
	Jgo. de juntas para motor		● 908400-R
	Junta tapa cilindros Ø 113.5 \pm 1.95	AGC 2	908408
	Junta tapa de válvulas	CG 2	908410
	Junta para cárter	CG 1	908411
	Junta frente motor	NB 1	908412
	Junta frente motor	NB 1	908413
	Jgo. múltiple escape (6)	FCH 1	908415
	Jgo. múltiple admisión (6)	NB 1	908417
	Junta entre colectores admisión	NB 2	908427
	Junta	NB 3	908428
	Junta	CG 4	908429
	Junta	CG 2	908430
	Junta	NB 5	908431
	Junta	NB 1	908432
	Junta	NB 1	908433
	Junta	NB 1	908434
	Guarnición goma	GS 6	908435
	Junta	NB 1	908436
	Junta	NB 1	908437
	Junta	NB 1	908438
	Junta	NB 1	908439
	Junta	NB 2	908440
	Junta	NB 1	908441
	Junta	NB 2	908442
	Junta	NB 1	908443
	Junta	CG 1	908444
	Junta	NB 1	908445
	Junta	NB 1	908446
	Junta	CG 1	908447
	Junta	NB 2	908448
	Junta	CG 1	908449
	Junta	NB 1	908450
	Junta	NB 1	908451
	Arandela A 9.80 x 19 x 2 C	CU 1	
	Anillo G 27 x 34 x 4	GS 1	
	Anillo G 32 x 43.8 x 3	GS 1	
	O´ring G 9 x 4	GS 1	
	O´ring G 18 x 2.20	GS 1	
	O´ring G 43.5 x 4	GS 1	
	O´ring G 79 x 3	GS 1	
	O´ring G 110 x 3.70	GS 1	
	Kit de retenes completo		R908400
	Jgo. retén válvulas (12)	P 1	R908410P
	Retén bancada 120 x 140/146 x 13	S 1	R908411S
	Retén distribución 62 x 85/93 x 13	S 1	R907412S

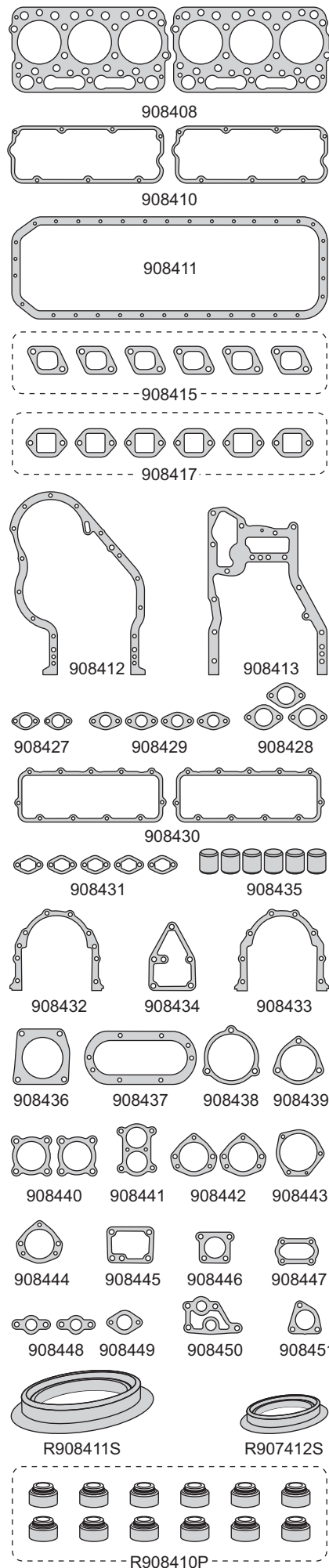

NISSAN



Motor / Engine Cm³ HP Ø

NF6T 9160 300 120

Nissan: Camión, Bus 1992/95

DIESEL

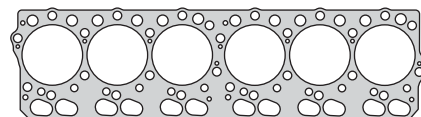

908508

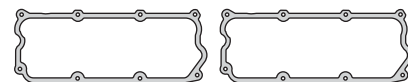

908510

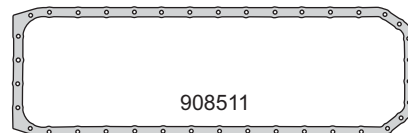

908511



908515

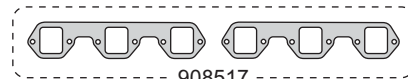

908517

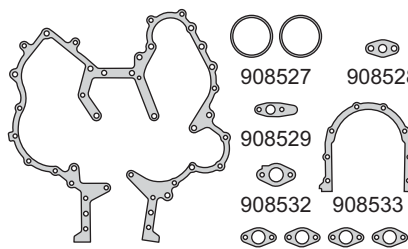

908527

908528

908529

908532

908533

908512

908534

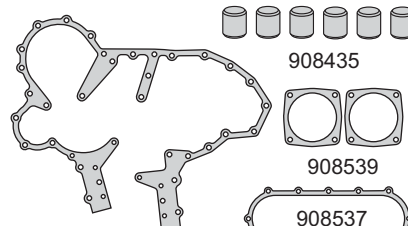

908435

908539

908537

908513

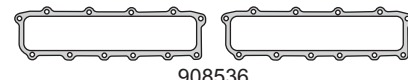

908536

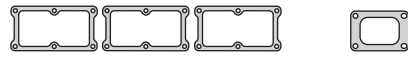

908538

908540

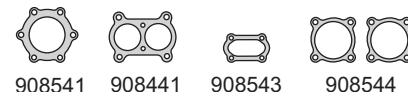

908541

908441

908543

908544



908545

908546

908547

908548



908549

A 9.8 x 19 x 2 C

G 8 x 3.70

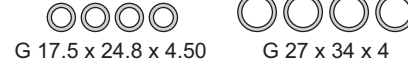

G 17.5 x 24.8 x 4.50

G 27 x 34 x 4

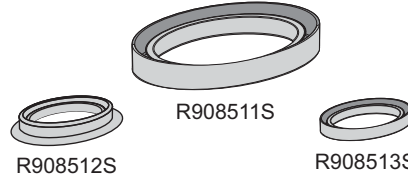

R908511S

R908512S

R908513S



-R908410P-

Nº OE	Descripción / Description	Mat.	Ref.
	Jgo. de juntas para motor		908500-R MLS
	Junta tapa cilindros Ø 122.5 ± 1.60	MLS	1 908508
	Junta tapa válvulas	AC/GS	2 908510
	Junta para cárter	CG	1 908511
	Junta frente motor	NB	1 908512
	Junta frente motor	NB	1 908513
	Jgo. múltiple escape (6)	AC	1 908515
	Jgo. múltiple admisión (2)	NFT	1 908517
	Junta	AC	2 908527
	Junta	CG	1 908528
	Junta	CG	1 908529
	Junta	NB	1 908532
	Junta	NB	1 908533
	Junta	NB	4 908534
	Junta	GS	6 908435
	Junta	NB	2 908536
	Junta	NB	1 908537
	Junta	NB	3 908538
	Junta	CG	2 908539
	Junta	NB	1 908540
	Junta	NB	1 908541
	Junta	CG	1 908441
	Junta	NB	1 908543
	Junta	NFT	2 908544
	Junta	CG	2 908545
	Junta	CG	2 908546
	Junta	NB	1 908547
	Junta	NB	1 908548
	Junta	NB	3 908549
	Arandela A 9.8 x 19 x 2 C	CU	6
	Anillo G 17.5 x 24.8 x 4.5	CU	4
	Anillo G 27 x 34 x 4	GS	4
	O'ring G 8 x 3.70	GS	1
	O'ring G 17 x 2.75	GS	1
	O'ring G 16.5 x 2.40	GS	1
	O'ring G 22 x 2.60	GS	1
	O'ring G 24 x 3.56	GS	5
	O'ring G 32 x 3.63	GS	1
	O'ring G 36 x 3	GS	1
	O'ring G 43 x 3	GS	1
	O'ring G 54 x 3	GS	1
	O'ring G 50 x 3.5	GS	3
	O'ring G 68 x 3	GS	1
	O'ring G 81 x 3	GS	2
	O'ring G 82 x 2.63	GS	1
	O'ring G 86 x 3.10	GS	1
	O'ring G 96 x 3	GS	1
	O'ring G 110 x 3	GS	1
	Kit de retenes completo		R908500
	Jgo. retén válvulas (12)	P	1 R908410P
	Retén bancada 126 x 150 x 13	S	1 R908511S
	Retén distribución 62 x 85/93 x 13	S	1 R908512S
	Retén árbol de levas 58 x 80 x 12	S	1 R908513S

NISSAN



Motor / Engine **Cm³** **HP** **Ø**

PD6
(SOHC) 12V

10308

200/300

125

Nissan: Camión, Bus 1969/...

DIESEL



Nº OE	Descripción / Description	Mat.	Ref.
	Jgo. de juntas para motor		908600-R
	Junta tapa cilindros Ø 128.5 x 1.95	ACG 2	908608
	Junta tapa válvulas	NB 2	908610
	Junta para cárter	CG 1	908611
	Frente motor	NB 1	908612
	Frente motor	NB 1	908613
	Bomba de agua	NB 1	908614
	Jgo. múltiple escape (6)	AC 1	908615
	Jgo. múltiple admisión (6)	NFT 1	908617
	Salida de escape	AC 2	908618
	Junta	AC 2	908627
	Junta accionamiento taquímetro	NB 1	908628
	Radiador aceite	NB 1	908629
	Junta	NB 1	908630
	Conexión salida agua	NB 1	908631
	Junta cierre lado volante	NB 1	908633
	Guarnición goma	GS 6	908635
	Junta	NB 2	908636
	Junta refrigeración aceite	NB 1	908637
	Junta	NB 1	908638
	Junta	NB 2	908639
	Junta	NB 1	908640
	Junta	NB 1	908641
	Junta	NB 2	908642
	Junta	NB 4	908643
	Junta	NB 3	908644
	Junta	NB 2	908645
	Junta	NB 1	908646
	Junta	NB 1	908647
	Arandela A 9.8 x 19 x 2 C	CU 6	
	Anillo G 27 x 34 x 4	GS 4	
	Anillo G 16 x 24 x 6	GS 1	
	O'ring G 11.5 x 2.30	GS 12	
	O'ring G 20 x 3.5	GS 2	
	O'ring G 52.5 x 4	GS 4	
	O'ring G 79 x 3	GS 1	
	Kit de retenes completo		R908600
	Jgo. retén válvulas (12)	P 1	R908610P
	Retén bancada 126 x 150/156 x 14	S 1	R908611S
	Retén distribución 62 x 85/93 x 13	S 1	R908512S

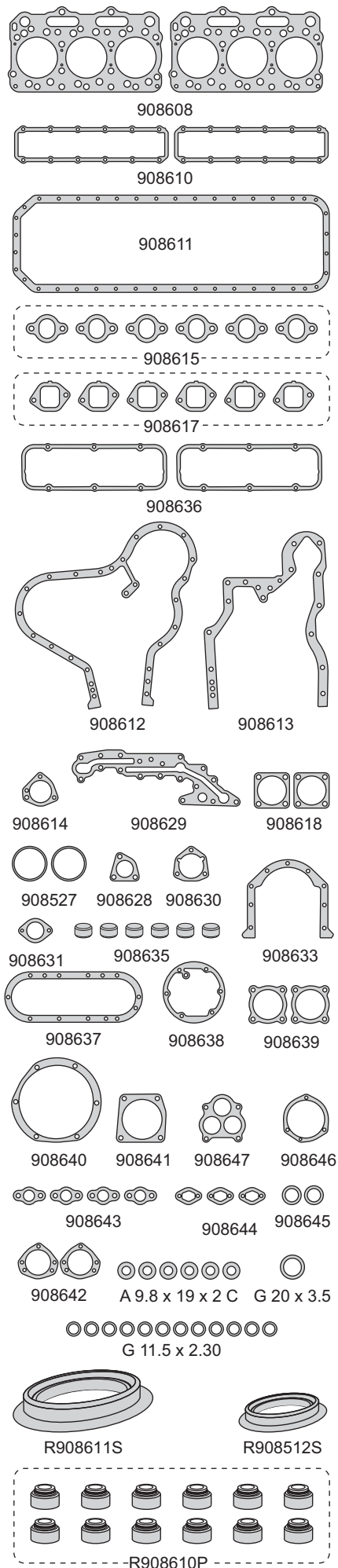

NISSAN



Motor / Engine **Cm³** **HP** **Ø**

PD6T
(SOHC) 12V

10308

260/300

127

Nissan: Camión, Bus 1970/...

DIESEL

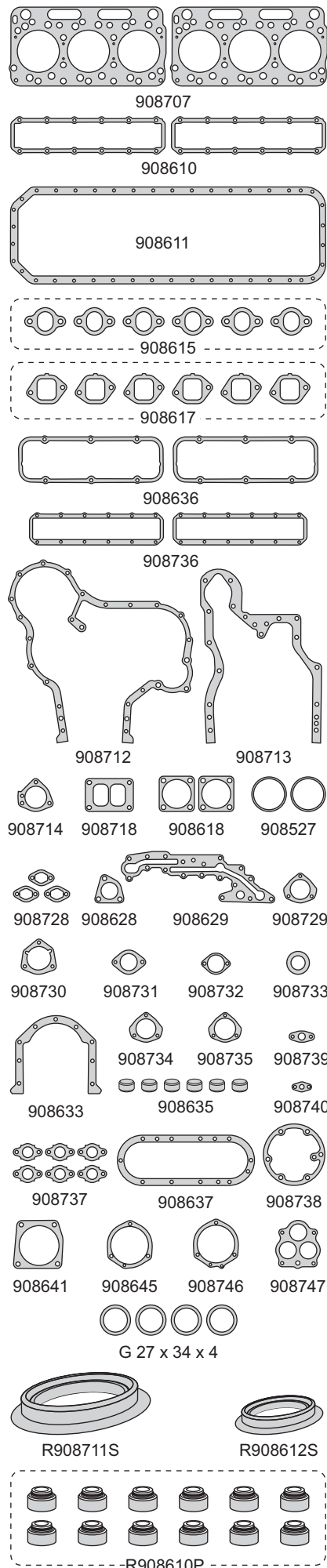

Nº OE	Descripción / Description	Mat.	Ref.
	Jgo. de juntas para motor		908700-R
	Junta tapa cilindros Ø 129.0 ± 1.60	NFT 2	908707
	Junta tapa válvulas	NB 2	908610
	Junta para cárter	CG 1	908611
	Frente motor	NB 1	908712
	Frente motor	NB 1	908713
	Bomba de agua	NB 1	908714
	Jgo. múltiple escape (6)	AC 1	908615
	Jgo. múltiple admisión (6)	NFT 1	908617
	Salida de escape	AC 2	908618
	Salida de escape	AC 1	908718
	Junta	AC 2	908527
	Junta	NB 2	908728
	Junta accionamiento taquímetro	NB 3	908628
	Radiador aceite	NB 1	908629
	Junta	NB 1	908729
	Junta	NB 1	908730
	Conexión salida agua	NB 1	908731
	Junta	NB 1	908732
	Junta cierre lado volante	NB 1	908633
	Junta	NB 1	908733
	Junta	NB 1	908734
	Junta	NB 1	908735
	Junta	NB 2	908636
	Junta	NB 2	908736
	Junta refrigeración aceite	NB 1	908637
	Junta	NB 6	908737
	Junta	NB 1	908738
	Junta	NB 1	908739
	Junta	NB 1	908740
	Junta	NB 1	908641
	Junta	NB 1	908645
	Junta	NB 1	908746
	Junta	NB 1	908747
	Arandela A 9.8 x 19 x 2 C	CU 6	
	Anillo G 8.45 x 13.5 x 2.5	GS 1	
	Anillo G 27 x 34 x 4	GS 6	
	Anillo G 16 x 24 x 6	GS 2	
	Anillo G 160 x 165 x 4.3	GS 1	
	O'ring G 20 x 3.5	GS 1	
	O'ring G 52.5 x 4	GS 4	
	O'ring G 39 x 3	GS 6	
	Kit de retenes completo		R908700
	Jgo. retén válvulas (12)	P 1	R908610P
	Retén bancada 126 x 150 x 14	S 1	R908711S
	Retén distribución 62 x 85/93 x 13	S 1	R908512S



taranto

Para garantizar un trabajo óptimo, utilice el Kit de Herramientas Especiales HAK12-38, con su completa línea de puntas en todas la versiones aplicables para cada modelo de cabeza de ajuste.



KIT HAK12-38

Tubos Hexagonales

6 PT Socket



Tubos Torx

Torx Socket



Tubos Estriados

12 PT Socket



Tubos con Punta Torx

Torx Socket Bit



Tubos con Punta Ribe

Ribe Socket Bit



Tubos con Punta Estriada

Torx Spline Socket Bit



Tubos con Punta Hexagonal

Hex. Socket Bit



Goniometro - Torquimetro Taranto.

Diseñado especialmente para facilitar el apriete de los tornillos de tapa de cilindros.

- ▶ HTORQ-110 - Herramienta Torquimetro 19-110NM
- ▶ HTORQ-210 - Herramienta Torquimetro 40-210NM
- ▶ HTORQ-350 - Herramienta Torquimetro 60-350NM
- ▶ HGONIOMETRO - Herramienta de Ajuste Angular - Goniometro
- ▶ HGONIOMETRO-M - Herramienta de Ajuste Angular - Goniometro Magnético



PERKINS



Motor/Engine	Cm³	HP	Ø
4.203-P4-192Z (OHV) 8V	3336	71	91.49

Dodge: D100, D200 1987/...
Ford: F100, Falcon 1970/...

DIESEL



Nº OE	Descripción/Description	Mat.	Ref.
105379	Jgo. de juntas para motor		400000-R
	Jgo. de juntas superior		400095
	Jgo. de juntas superior		400095/7
	Junta tapa cilindros Ø92.5 ± 1.40		400005
36812125	Junta tapa cilindros Ø92.5 ± 1.40 N.R.	NFT	400007
36812125	Junta tapa cilindros Ø92.5 ± 1.15 N.R.	CNC	400008
	Jgo. tornillos tapa cilindros (HAS19038)		B400000
0490704	Conjunto junta tapa válvulas (4)	CG	400010
003248	Jgo. junta para cárter (4)	NB	400011
006072	Tapa distribución	NB	400012
36814112	Block caja distribución	NB	400013
36866417	Bomba de agua placa trasera	NB	400014
006002	Jgo. múltiple escape (2)	FCH	400015
006061	Múltiple admisión	NFT	400017
0490032	Salida de escape	FCH	400018
	Arandela tapa válvulas	GS	400130
	Arandela base inyector A 14 x 20 x 1.5 C	CU	400033
33825409	Tapa frontal a tapa inspección	NB	400034
066081	Tapa trasera cigüeñal	NB	400035
0490485	Tapa trasera tapa cilindro	NB	400036
0066054	Tapa precámara combustible	CU	400037
006054	Precámara combustión	AL	410037
33826111	Porta retén bancada trasera	NB	400038
36866416	Caja distribución bomba vacío	NB	400039
0490867	Tapa trasera termoarranque	CG	400140
36853105	Caja distribución tapa toma fuerza	NB	400045
0490685	Comando bomba combustible	NB	400146
0490699	Tapa trasera árbol levas	NB	400047
0490692	Conexión entrada agua	NB	400048
36835411	Conexión salida agua	NB	400051
0490024	Salida agua a tapa	NB	400052
0490391	Cuerpo codo paso agua	NB	400153
006007	Filtro aceite a block	NB	400057
36883106	Jgo. juntas bancada cigüeñal (2)	SLA	400158
	Junta base depresor	NB	400059
36866428	Bomba vacío tapa brida	NB	400062
006074	Bomba alimentación combustible	NB	400165
36865543	Soporte bomba inyectora	NB	400066
	Kit arandelas (57)	VS	400075
	Arandela A 10 x 14 x 1 A	AL	15
	Arandela A 13 x 20 x 1 A	AL	10
	Arandela A 17.5 x 22 x 1 A	AL	10
	Arandela A 19 x 27 x 2 A	AL	1
	Arandela A 8 x 12.5 x 1 A	AL	15
	Arandela A 14.5 x 20.5 x 1.5 C	CU	6
	Kit de retenes completo 4.203 hasta 1987		R400000
	Kit de retenes completo 4.203 1988/...		R400000-1
	Jgo. retén válvulas (8)	P	R300310P
	Jgo. retén válvulas (8)	P	R400010P
	Retén bancada 133.35 x 158.75 x 11/13	P	R400211P
	Retén distribución 60.32 x 79.36 x 9.5	P	R400012P

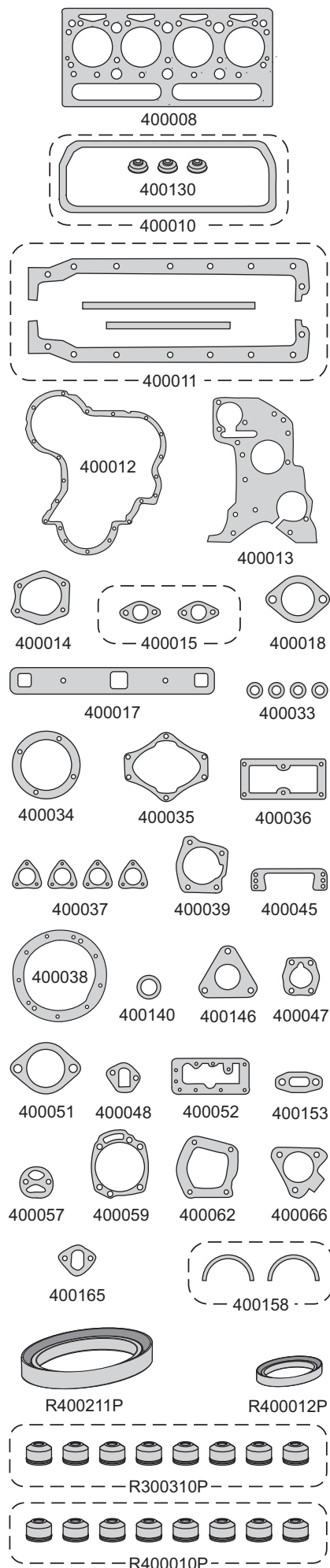

PERKINS



Motor/Engine	Cm ³	HP	Ø
6.305 Cadenero (SOHC) 12V	5004	100	91.44
DIESEL			

Dodge: DP 400/500 1964/...
Ford: F350/600



Nº OE	Descripción/Description	Mat.	Ref.
005016	Jgo. de juntas para motor		400100-R
	Jgo. de juntas superior	●	400195
	Jgo. de juntas superior	●	400195/7
36812511	Junta tapa cilindros Ø 93.0 ± 1.40 N.R.	NFT	400107
36812511	Junta tapa cilindros Ø 93.0 ± 1.15 N.R.	CNC	400108
0490769	Conj. junta tapa válvulas (5)	CG	400110
0490018	Jgo. junta para cárter (4)	NB	400111
0490005	Tapa frontal distribución	NB	400112
0490002	Tapa distribución a block	NB	400113
36866417	Bomba de agua placa trasera	NB	400014
0490028	Múltiple escape	FCH	400015
0490026	Jgo. múltiple admisión (2)	NFT	400117
0490032	Salida de escape	FCH	400018
	Arandela tapa válvulas	GS	400130
0490632	Base inferior caja distribución	NB	400131
0490756	Block a soporte bomba vacío	NB	400132
0920113	Arandela base inyector A 14 x 20 x 1.25 C	CU	400033
36817134	Tapa trasera cigüeñal	NB	400035
0490485	Tapa trasera tapa cilindros	NB	400036
006054	Precámara combustión	CU	400037
0490003	Tapa inferior distribución	NB	400138
0490011	Tapa reguladora aceite block	NB	400139
0490687	Tapa trasera termoarranque	CG	400140
0490013	Tapa superior comando auxiliar	NB	400141
0490685	Codo bomba combustible	NB	400146
	Block tapa trasera	NB	400047
	Block con entrada de agua	NB	400048
0490234	Soporte bomba vacío	NB	400149
36835411	Conexión salida agua	NB	400051
0490024	Salida agua a tapa	NB	400052
0490391	Cuerpo codo paso agua	NB	400153
0490025	Múltiple entrada agua	NB	400156
	Filtro aceite a block	NB	400057
0490187	Cuerpo bomba aceite a block	NB	400157
36883106	Jgo. juntas retén aceite cigüeñal (2)	SLA	400158
0490007	Tubo carga aceite	NB	400159
	Junta base depresor	NB	400059
36851106	Soporte bomba vacío	NB	400163
36861719	Bomba vacío bomba combustible	NB	400164
36862126	Bomba alimentación combustible	NB	400165
0490012	Caja comando auxiliar a distribución	NB	400167
0490020	Depósito cárter	NB	400168
0490027	Múltiple admisión a conexión	NB	400169
	Kit de arandelas (57)	VS	400175
002251	Tapa frontal bomba vacío	NB	400186
	Arandela A 10 x 14 x 1 A	AL	15
	Arandela A 13 x 20 x 1.25 A	AL	10
	Arandela A 17 x 22 x 1 A	AL	10
	Arandela A 19 x 27 x 2 A	AL	1
	Arandela A 8 x 12 x 1 A	AL	15
	Kit de retenes completo		R400100
	Jgo. retén válvulas (12)	P	R540210P
	Jgo. retén válvulas (12)	P	R400110P
	Retén distribución 60.32 x 79.36 x 9.5	P	R400012P

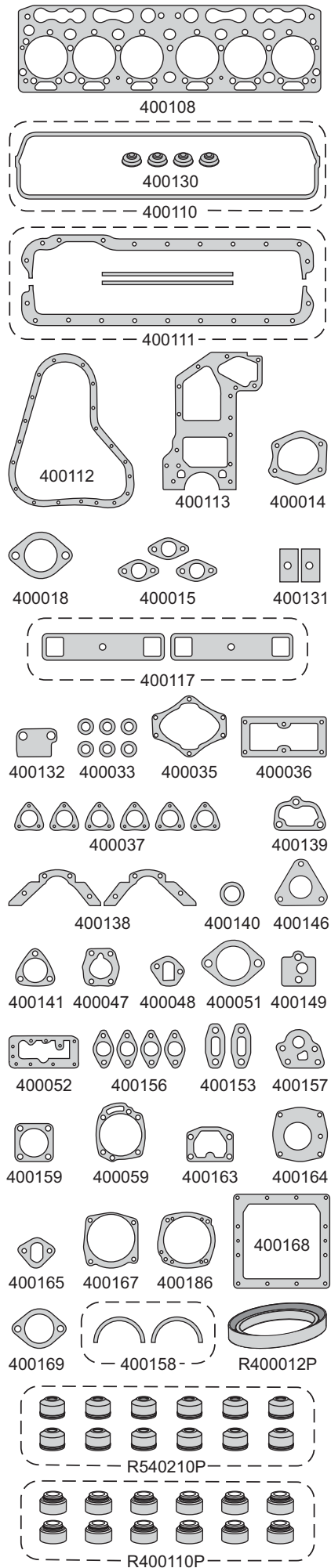

PERKINS**taranto**

Motor/Engine

Cm³

HP

Ø

Dodge: DP 600/800 1968/...

Ford: F600/700

6.354-2
(OHV) 12V

5798

140

98.47

DIESEL



Nº OE	Descripción/Description	Mat.	Ref.
	Jgo. de juntas para motor		400200-R
	Jgo. de juntas superior		400295
	Jgo. de juntas superior		400295/7
36812545	Jta. tapa cilindros Ø 104.0 \pm 1.50	NFT	400207
36812545	Jta. tapa cilindros Ø 104.0 \pm 1.30	CHA	400208
	Jgo. tornillos tapa cilin. (HAS19038)		B400200
36811412	Junta tapa válvulas	CG	400210
36816702	Junta para cárter	NB	400211
368114124	Distribución a block	NB	400212
36867108	Bomba de agua a block	NB	400214
	Jgo. múltiple escape (3)	FCH	400215
	Jgo. múltiple admisión (4)	NFT	400217
0490301	Salida de escape	FCH	400218
36847319	Depósito cárter chico	NB	400233
36816702	Junta para cárter (1.00 mm.)	NB	400234
36816702	Junta para cárter (0.08 mm.)	NB	400235
0490485	Tapa trasera tapa cilindros	NB	400036
36817157	Porta retén bancada trasera	NB	400236
003202	Base filtro aceite cámara	NB	400237
002794	Base filtro aceite	NB	400238
36831118	Válvula reguladora a block	NB	400239
0490687	Tapa trasera termoarranque	CG	400140
	Jgo. juntas compresor tensa bicil.	VS	400240
36846408	Inspección botadores	NB	400242
32811408	Lateral puente a block	GS	400442
36826107	Tapa inspección engranaje árbol de levas	CG	400243
36866434	Inspección engranaje comando auxiliar	NB	400244
002038	Vaso pre-filtro	CG	400045
	Vaso combustible	CG	450045
33828108	Comando bomba combustible	NB	400246
36832118	Brida caño succión a bomba	NB	400249
36866426	Acople compresor a block	NB	400250
36846113	Cuerpo salida agua tapa cilindros	NB	400254
	Jgo. empaquetadura cigüeñal (2)	SLA	400158
	Junta tapa válvulas superior	CG	400261
36862126	Bomba alimentación combustible	NB	400165
006090	Bomba alimentación combustible	NB	400465
	Placa cuerpo múltiple admisión	NB	400282
36867132	Porta retén bancada trasera	NB	400283
36817136	Placa adaptador bomba inyección	NB	400284
36822118	Arandela inyector A 10 x 19 x 2 C	CU	6
	Arandela A 10 x 14 x 1.5 A	AL	15
	Arandela A 13 x 21 x 2 A	AL	15
	Arandela A 17 x 22 x 1.5 A	AL	5
	Arandela A 19 x 27 x 2 A	AL	1
105393	Arandela A 8 x 13 x 1.5 A	AL	15
	Kit de retenes completo		R400200-1
	Jgo. retén válvulas (12)	P	1 R400210P
	Retén bancada 133.35 x 158.75 x 11/13	V	1 R400211V
	Retén distribución 60.32 x 79.36 x 9.5	P	1 R400012P
	Retén auxiliar 22.22 x 35.70 x 9.52	N	1 R400215N

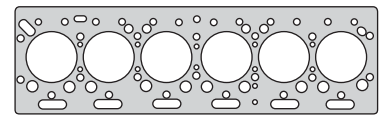

400208



400210

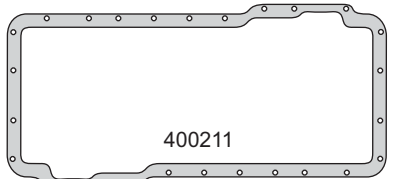

400211

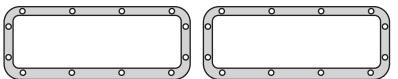

400242

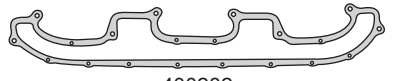

400282

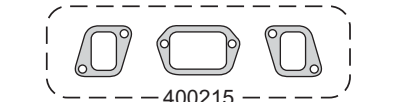

400215

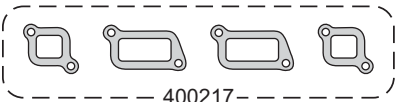

400217

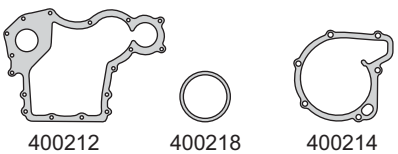

400212

400218

400214



400233

400239

400249

400236

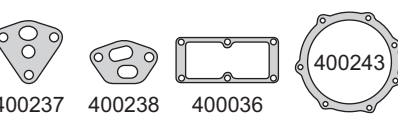

400237

400238

400036

400243

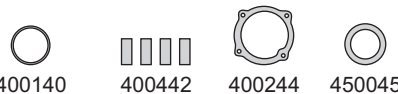

400140

400442

400244

450045

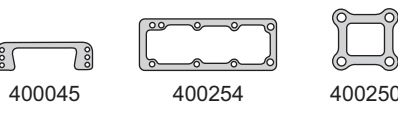

400045

400254

400250

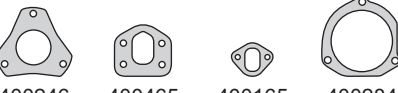

400246

400465

400165

400284



400283

400158



R400012P

R400211V

R400215N



R400210P

PERKINS



Motor/Engine	Cm³	HP	Ø
6PF - 305	5004	102	91.44

Ford: F100 - F350 - F600 1974/...



DIESEL

Nº OE	Descripción/Description	Mat.	Ref.
105388	Jgo. de juntas para motor		400300-R
	Jgo. de juntas superior		400395
	Jgo. de juntas superior		400395/7
006063	Jta. tapa cilindros Ø 92.5 x 1.40	NFT	400307
006063	Jta. tapa cilindros Ø 92.5 x 1.25	FCH 1 1	400308
	Jgo. tornillos tapa cilindros (HAS19038)		B400300
0490760	Conj. junta tapa válvulas (4)	CG 1 1	400110
006000	Jgo. junta para cárter (4)	NB 1	400311
006072	Caja distribución tapa frontal	NB 1	400012
36814112	Block caja distribución	NB 1	400013
36866417	Bomba agua placa trasera	NB 1	400014
006002	Múltiple escape	FCH 3 3	400015
0490026	Jgo. múltiple admisión (2)	NFT 1 1	400117
0490032	Salida de escape	FCH 1 1	400018
	Arandela tapa válvulas (4)	GS 4 4	400130
0920113	Arandela base inyector A 14 x 20 x 1.25 C	CU 6	400033
33825409	Tapa frontal tubo venteo	NB 1	400034
006081	Tapa trasera cigüeñal	NB 1	400035
0490458	Tapa trasera tapa cilindros	NB 1 1	400036
006054	Precámara combustión	CU 6 6	400037
006054	Precámara combustión	AL	410037
33826111	Porta retén bancada trasera	NB 1	400038
36866416	Caja distribución bomba vacío	NB 1	400039
	Válvula reguladora a block	NB 1	400239
	Junta tapa trasera	CG 1	400140
36853105	Caja distribución tapa toma fuerza	NB 1	400045
0490685	Comando bomba combustible	NB 1	400146
0490699	Block tapa trasera	NB 1	400047
0490692	Conexión entrada agua	NB 1	400048
002742	Caño aceite a block	NB 1	400249
36835411	Conexión salida agua	NB 1 1	400051
0490024	Salida agua a tapa	NB 1 1	400052
0490391	Cuerpo codo paso agua	NB 2	400153
006007	Filtro aceite a block	NB 1	400057
36883106	Jgo. juntas bancada cigüeñal (2)	SLA 1	400158
36866428	Bomba vacío a tapa distribución	NB 1	400062
006074	Bomba vacío a bomba combustible	NB 1	400165
36865543	Soporte bomba inyectora	NB 1	400066
	Placa bomba agua	NB	400363
	Kit de arandelas (57)	VS 1	400175
	Arandela A 10 x 14 x 1 A	AL	15
	Arandela A 13 x 20 x 1.25 A	AL	10
	Arandela A 17 x 22 x 1 A	AL	10
	Arandela A 19 x 27 x 2 A	AL	1
	Arandela A 8 x 12 x 1 A	AL	15
	Kit de retenes completo		R400300
	Jgo. retén válvulas (12)	P 1	R540210P
	Jgo. retén válvulas (12)	P 1	R400110P
	Retén bancada 133.35 x 158.75 x 11/13	P 1	R400211P
	Retén distribución 60.32 x 79.36 x 9.5	P 1	R400012P

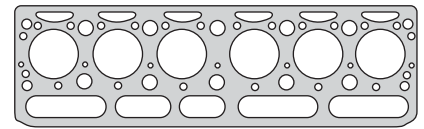

400308

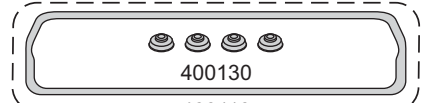

400130

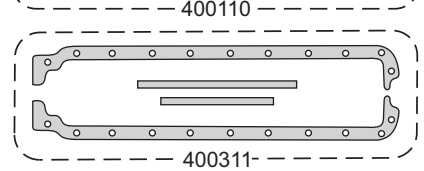

400110

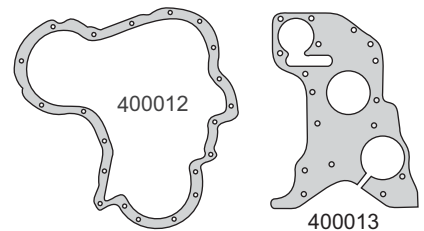

400311-

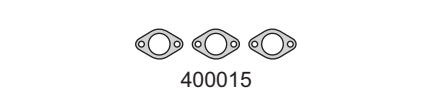

400012

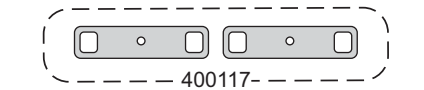

400013

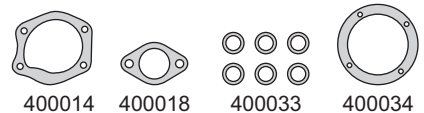

400015

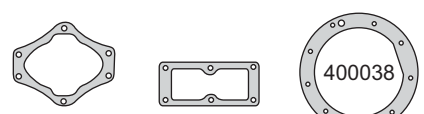

400117-

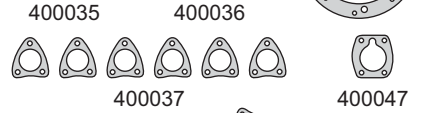

400014

400018

400033

400034

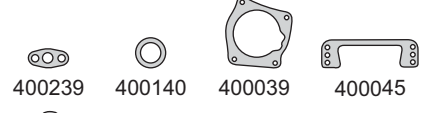

400035

400036

400038

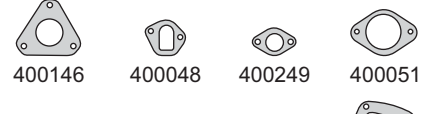

400037

400047

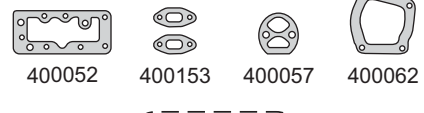

400239

400140

400039

400045

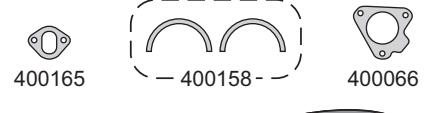

400146

400048

400249

400051



400052

400153

400057

400062

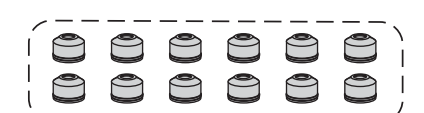

400165

400158-

400066

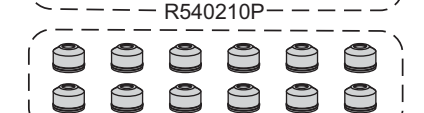

R400012P

R400211P

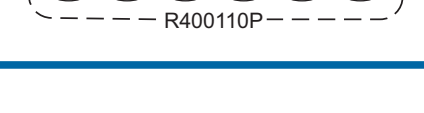

R540210P-

R400110P-

PERKINS

Motor/Engine **6.354-4 Turbo (OHV) 12V**
Cm³ 5798 **HP** 172 **Ø** 98.42

Dodge: D600/800 1976/...
Ford: F7000 Camiones
 Ford pesados y semi-pesados

DIESEL



Nº OE	Descripción/Description	Mat.	Ref.
105683	Jgo. de juntas para motor		400400-R
	Jgo. de juntas superior		400495
	Jgo. de juntas superior		400495/7
	Jta. tapa cilindros Ø 104.0 \pm 1.50	NFT	400407
36812607	Jta. tapa cilindros Ø 104.0 \pm 1.45	CHA	1 1 400408
	Jgo. tornillos tapa cilindros (HAS19038)		B400200
006104	Conj. junta tapa válvulas (5)	CG	1 1 400410
006088	Junta para cárter	NB	1 400411
36814124	Caja distribución a bock	NB	1 400212
36867162	Bomba de agua a block	NB	1 400414
	Jgo. múltiple escape (3)	AC	1 1 400416
	Jgo. múltiple admisión (4)	AC	1 1 400417
37481108	Salida de escape	AC	2 2 400418
36865532	Bomba aceite a bock	NB	1 400427
36833125	Bomba carga aceite	CG	3 3 400429
36831122	Válvula reguladora presión aceite	NB	1 400430
36832133	Caño aceite turbo	NB	2 400431
36833148	Drenaje aceite turbo	NB	1 400432
36861448	Adaptador alimentación aceite	NB	1 400433
	Base filtro óleo	NB	1 410433
36861745	Conexión salida agua	NB	1 1 400434
36834143	Bomba inyectora	NB	1 400435
0490485	Tapa trasera tapa cilindros	NB	1 1 400036
36817157	Porta retén trasero	NB	1 400236
006095	Cabezal a block	NB	1 400437
36823132	Tapa múltiple codo a múltiple admisión	NB	2 400438
36821118	Entrada agua a block	NB	1 400439
0490474	Caño ventilación a tapa válvulas	NB	1 400440
0490053	Tapa cierre	NB	2 400441
32811408	Lateral puente a block	GS	4 400442
36826107	Tapa inspección engranaje árbol de levas	CG	1 400243
36866434	Tapa inspección engranaje comando auxiliar	NB	1 400244
36833139	Caño bomba de aceite	NB	1 400444
	Drenaje turbo	NB	350445
	Arandela cierre tapa de válvulas	GS	4 4 400446
006089	Cabezal a block	NB	400447
36866426	Compresor a block	NB	1 400250
36846113	Cuerpo salida agua	NB	1 1 400254
	Colector a turbo escape	AC	350462
006090	Bomba alimentadora a bock	NB	1 400465
36822118	Placa adaptador a block	NB	1 400284
	Arandela A 10 x 20 x 1 C	CU	6 6
	Arandela A 7 x 10 x 1 A	AL	12
	Kit de retenes completo		R400200-1
	Jgo. retén válvulas (12)	P	1 R400210P
	Retén bancada 133.35 x 158.75 x 11/13	V	1 R400211V
	Retén distribución 60.32 x 79.36 x 9.5	P	1 R400012P
	Retén auxiliar 22.22 x 35.70 x 9.52	N	1 R400215N

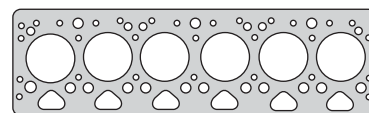

400408



400446

400410

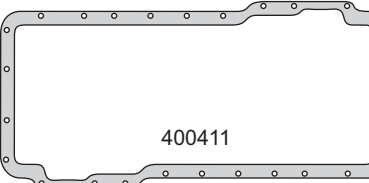

400411

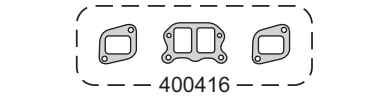

400416

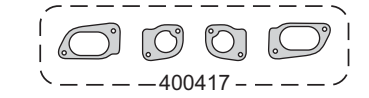

400417



400212

400414

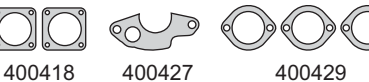

400418

400427

400429



400430

400431

400432

410433

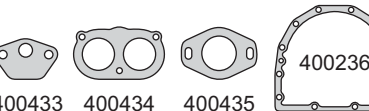

400433

400434

400435

400236

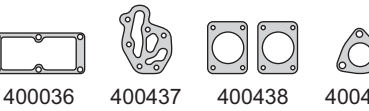

400036

400437

400438

400439

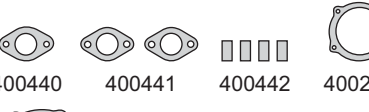

400440

400441

400442

400244



400243

400444

400254

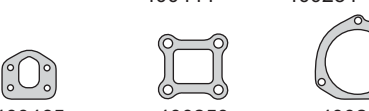

400465

400250

400284



A 7 x 10 x 1 A



A 10 x 20 x 1 C



R400211V

R400012P

R400215N



R400210P

PERKINS



Motor/Engine	Cm³	HP	Ø
P3 - 152	2362	42	91.44

Perkins: Tractor Viñatero



DIESEL

Nº OE	Descripción/Description	Mat.	Ref.
105377	Jgo. de juntas para motor	●	400500-R
368112122	Junta tapa cilindros Ø 93.0 ± 1.45	NFT	400507
368112122	Junta tapa cilindros Ø 93.0 ± 1.45	FCH	400508
	Jgo. tornillos tapa cilindros (HAS19038)		B400000
0490491	Conj. tapa válvulas superior (3)	CG	400510
003249	Jgo. junta para cárter (4)	NB	400511
002476	Tapa distribución	NB	400512
36814119	Placa distribución	NB	400513
36866417	Bomba de agua a placa	NB	400014
0490481	Múltiple escape	FCH	400015
0490032	Salida de escape	FCH	400018
	Arandela tapa válvulas	GS	400130
	Depósito cárter	NB	400533
0490482	Cuerpo salida agua	NB	400534
006081	Tapa trasera cigüeñal	NB	400035
002477	Bomba hidráulica toma fuerza	CB	400535
0490485	Tapa trasera tapa cilindros	NB	400036
0490738	Cuerpo salida agua tapa cilindros	NB	400536
006054	Precámara combustión	CU	400037
36862511	Tapa trasera árbol levas	NB	400537
006054	Precámara combustión combustible	AL	410037
	Base filtro aceite	NB	400237
0490686	Cuerpo toma aire	NB	400538
0490486	Tapa conexión entrada aire	NB	400539
0490687	Tapa trasera termoarranque	CG	400140
36862512	Tapa inspección carga aceite	NB	400540
36862165	Bomba alimentación	NB	400541
002478	Tapa inspección engranaje distribución	NB	400542
36853105	Caja a tapa toma fuerza	NB	400045
0490685	Comando bomba combustible	NB	400146
36835411	Conexión salida agua	NB	400051
0490391	Cuerpo codo paso agua	NB	400153
006047	Filtro aceite a block	NB	400057
36883106	Jgo. juntas bancada cigüeñal (2)	SLA	400158
36851106	Soporte bomba vacío	NB	400163
006074	Bomba alimentación combustible	NB	400165
	Arandela inyector A 14 x 20 x 1.5 C	CU	
	Kit de retenes completo		R400500
	Jgo. retén válvulas (6)	P	R400510P
	Jgo. retén válvulas (6)	P	R400610P
	Retén bancada 133.35 x 158.75 x 11/13	P	R400211P
	Retén distribución 60.32 x 79.36 x 9.5	P	R400012P

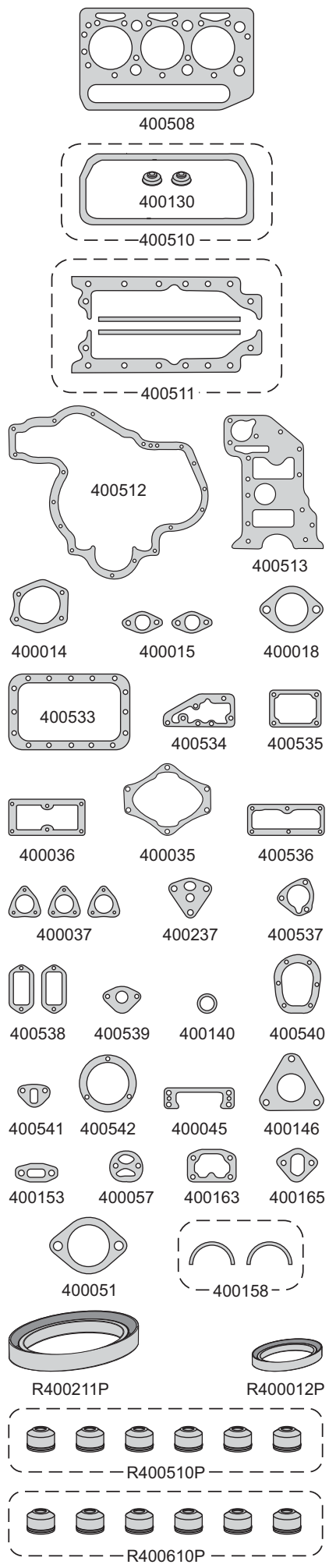

PERKINS



Motor/Engine	Cm³	HP	Ø
6PF - MF1175	5004	100	91.44

Massey Ferguson: Tractor - PF

DIESEL

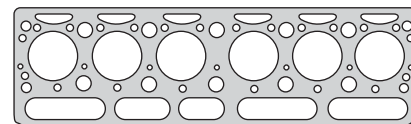

400308

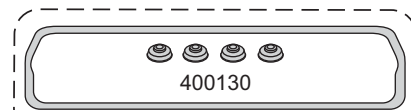

400130

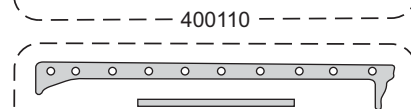

400110



400611

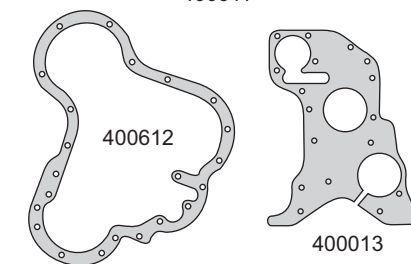

400612

400013



400015

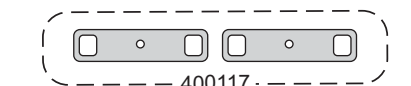

400117

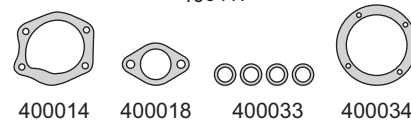

400014

400018

400033

400034

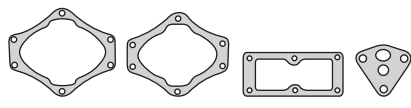

400035

400635

400036

400237



400037

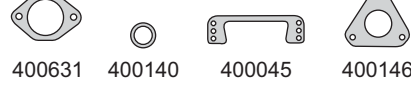

400631

400140

400045

400146



400047

400048

400249

400051

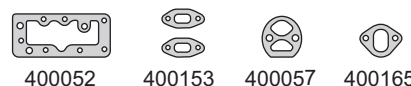

400052

400153

400057

400165



400062

400158

400066



R400211P

R400012P

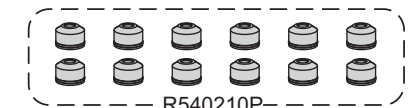

R540210P

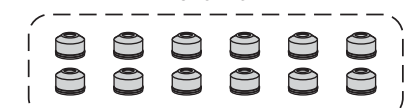

R400110P

Nº OE	Descripción/Description	Mat.	Ref.
	Jgo. de juntas para motor		400600-R
006063	Junta tapa cilindros Ø 92.5 ± 1.40	NFT	400307
006063	Junta tapa cilindros Ø 92.5 ± 1.25	FCH	400308
	Jgo. tornillos tapa cilindros (HAS19038)		B400300
0490760	Conj. tapa válvulas superior (5)	CG	400110
006080	Jgo. junta para cárter (4)	NB	400611
006013	Caja distribución tapa frontal	NB	400612
36814112	Block caja distribución	NB	400013
36866417	Bomba de agua placa trasera	NB	400014
006002	Múltiple escape	FCH	400015
0490026	Jgo. múltiple admisión (2)	NFT	400117
0490032	Salida de escape	FCH	400018
	Arandela tapa válvulas	GS	400130
	Brida bomba hidráulica	NB	400631
0920113	Arandela base inyector A 14 x 20 x 1.25 C	CU	400033
33825409	Tapa frontal tubo venteo	NB	400034
	Tapa trasera cigüeñal	NB	400035
	Tapa trasera cigüeñal	NB	400635
0490485	Tapa trasera tapa cilindros	NB	400036
006054	Precámara combustión	CU	400037
006054	Precámara combustión combustible	AL	410037
	Base filtro aceite	NB	400237
0490867	Tapa trasera termoarranque	CG	400140
36853105	Caja distribución tapa toma fuerza	NB	400045
0490685	Codo bomba combustible	NB	400146
0490699	Block tapa trasera	NB	400047
0490692	Block conexión entrada agua	NB	400048
002742	Caño paso aceite a block	NB	400249
	Jgo. juntas caja velocidad	VS	400650
36835411	Conexión salida agua	NB	400051
0490024	Salida agua a tapa	NB	400052
0490391	Cuerpo codo paso agua	NB	400153
006007	Filtro aceite a block	NB	400057
36883106	Jgo. juntas bancada cigüeñal (2)	SLA	400158
36866428	Bomba vacío tapa brida	NB	400062
006074	Bomba alimentación combustión	NB	400165
36865543	Soporte bomba inyectora	NB	400066
	Kit de arandelas (57)	VS	400175
	Arandela A 10 x 14 x 1 A	AL	15
	Arandela A 13 x 20 x 1.25 A	AL	10
	Arandela A 17 x 22 x 1 A	AL	10
	Arandela A 19 x 27 x 2 A	AL	1
	Arandela A 8 x 12 x 1 A	AL	15
	Arandela tapón cárter A 19 x 27 x 2 A	AL	
	Kit de retenes completo		R400300
	Jgo. retén válvulas (12)	P	1 R400110P
	Jgo. retén válvulas (12)	P	1 R540210P
	Retén bancada 133.35 x 158.75 x 11/13	P	1 R400211P
	Retén distribución 60.32 x 79.36 x 9.5	P	1 R400012P

MASSEY FERGUSON



Motor/Engine	Cm³	HP	Ø
MF165 - 265	3336	71	91.49

Massey Ferguson: Tractor M165 - 265



DIESEL

Nº OE	Descripción/Description	Mat.	Ref.
	Jgo. de juntas para motor		400700-R
	Junta tapa cilindros Ø 92.5 ± 1.40	NFT	400005
36812125	Junta tapa cilindros Ø 92.5 ± 1.40	NFT	400007
36812125	Junta tapa cilindros Ø 92.5 ± 1.15	CNC	400008
	Jgo. tornillos tapa cilindros (HAS19038)		B400000
0490704	Conj. junta tapa válvulas superior (4)	CG	400010
006012	Jgo. junta para cárter (4)	NB	400711
006013	Tapa distribución	NB	400612
36814112	Block caja distribución	NB	400013
36866417	Bomba de agua placa trasera	NB	400014
006002	Jgo. múltiple escape (2)	FCH	400015
006061	Múltiple admisión	NFT	400017
0490032	Salida de escape	FCH	400018
	Salida de escape	NFT	400718
	Arandela tapa válvulas	GS	400130
006020	Brida bomba hidráulica	NB	400631
0920113	Arandela base inyector A 14.5 x 20.5 x 1.5 C	CU	400033
33825409	Tapa frontal a tapa inspección	NB	400034
006081	Tapa trasera cigüeñal	NB	400035
0490485	Tapa trasera tapa cilindros	NB	400036
006054	Tapa precámara combustión	CU	400037
	Precámara combustión combustible	AL	410037
33826111	Porta retén bancada trasera	NB	400038
	Tapa trasera termoarranque	CG	400140
0490685	Comando bomba combustible	NB	400146
0490699	Tapa trasera árbol levas	NB	400047
0490692	Conexión entrada agua	NB	400048
36835411	Conexión salida agua	NB	400051
0490024	Salida agua a tapa	NB	400052
0490391	Cuerpo codo paso agua	NB	400153
006007	Filtro aceite a block	NB	400057
36883106	Jgo. juntas bancada cigüeñal (2)	SLA	400158
	Unión manga diferencial	CB	400759
006074	Bomba alimentación combustible	NB	400165
36865543	Soporte bomba inyectora	NB	400066
	O'ring G 18.77 x 1.78	GS	400767
	Kit de arandelas (57)	VS	400075
	Arandela A 10 x 14 x 1 A	AL	15
	Arandela A 13 x 20 x 1 A	AL	10
	Arandela A 17.5 x 22 x 1 A	AL	10
	Arandela A 19 x 27 x 2 A	AL	1
	Arandela A 8 x 12.5 x 1 A	AL	15
	Kit de retenes completo		R400000-1
	Jgo. retén válvulas (8)	P	1 R400010P
	Jgo. retén válvulas (8)	P	1 R300310P
	Retén bancada 133.35 x 158.75 x 11/13	P	1 R400211P
	Retén distribución 60.32 x 79.36 x 9.5	P	1 R400012P

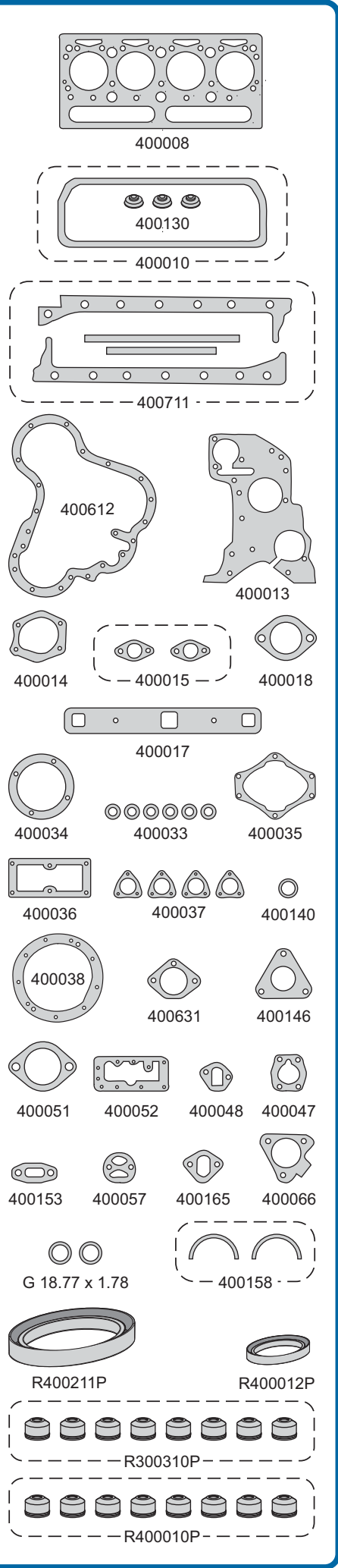

MASSEY FERGUSON



Motor/Engine	Cm³	HP	Ø
6.354-2 (OHV) 12V	5798	140	98.3
DIESEL			

Massey Ferguson: Tractor 1095 - 1098 - 1195
1215



Nº OE	Descripción/Description	Mat.	Ref.
	Jgo. de juntas para motor		● 400800-R
36812545	Junta tapa cilindros Ø 104.0 \pm 1.50	NFT	400207
36812545	Junta tapa cilindros Ø 104.0 \pm 1.30	CHA	1 400208
	Jgo. tornillos tapa cilindros (HAS19038)		B400200
36811412	Junta tapa válvulas superior	CG	1 400210
36816702	Junta para cárter	NB	1 400211
36814124	Distribución a block	NB	1 400212
36867139	Bomba de agua placa	NB	1 400814
	Jgo. múltiple escape (3)	FCH	1 400215
	Jgo. múltiple admisión (4)	NFT	1 400217
0490301	Salida de escape	FCH	1 400218
36867117	Placa montaje a block	NB	1 400819
0490485	Tapa trasera tapa cilindros	NB	1 400036
003202	Base filtro aceite c/ ref.	NB	1 400237
	Base filtro aceite s/ ref.	NB	1 400238
36831118	Válvula reguladora a block	NB	1 400239
	Jgo. juntas compresor tensa	VS	400240
	Tapa trasera termoarranque	CG	1 400140
36846408	Inspección botadores	NB	2 400242
32811408	Lateral puente a block	GS	4 400442
36826107	Inspección engranaje árbol de levas	CG	1 400243
36866434	Inspección engranaje comando auxiliar	NB	1 400244
	Vaso filtro nafta	CG	1 450045
33828108	Comando bomba combustible	NB	1 400246
36832118	Brida caño succión a bomba	NB	1 400249
36866426	Acople compresor a block	NB	1 400250
36835411	Conexión salida agua	NB	1 400051
36846113	Cuerpo salida agua tapa cilindros	NB	1 400254
	Jgo. empaquetadura cigüeñal (2)	SLA	1 400158
36811412	Junta tapa válvulas superior	CG	400261
36862126	Bomba alimentación combustible	NB	1 400165
	Junta base alimentación	NB	1 400465
	Kit de arandelas (57)	VS	1 400175
36867132	Placa cuerpo múltiple admisión	NB	1 400282
36817136	Porta retén bancada trasera	NB	1 400283
36822118	Placa adaptador bomba inyección	NB	1 400284
36866432	Placa montaje a conexión	NB	1 400885
	Arandela inyector A 14 x 20 x 1.25 C	CU	6
	Arandela A 10 x 14 x 1 A	AL	15
	Arandela A 13 x 20 x 1.25 A	AL	10
	Arandela A 17 x 22 x 1 A	AL	10
	Arandela A 19 x 27 x 2 A	AL	1
	Arandela A 8 x 12 x 1 A	AL	15
	Kit de retenes completo		R400200
	Jgo. retén válvulas (12)	P	1 R400210P
	Retén bancada 133.35 x 158.75 x 11/13	P	1 R400211P
	Retén distribución 60.32 x 79.36 x 9.5	P	1 R400012P
	Retén auxiliar 22.22 x 35.70 x 9.52	N	1 R400215N

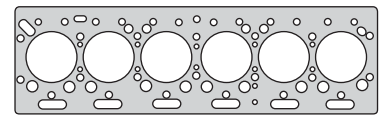

400208



400210

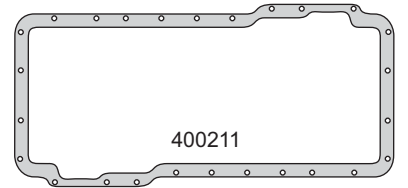

400211

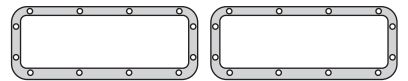

400242

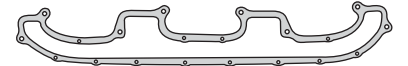

400282

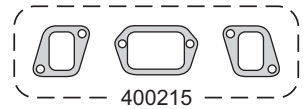

400215

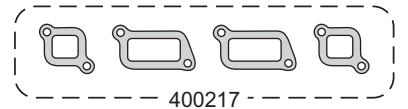

400217

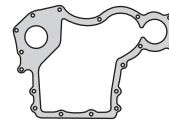

400212



400218

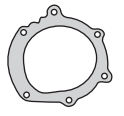

400814



400819

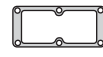

400036



400237



400238



400239



400140



400442



400244



400243

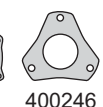

400246

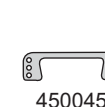

450045



450045



400249



400250



400051



400254



400165



400283



400284



400885



400158



400465



R400211P



R400012P



R400215N



R400210P

PERKINS



Motor/Engine	Cm ³	HP	Ø
6.354-1 (OHV) 12V	5798	135	98.43

Dodge: DP 600/800
Ford: F600 - F700



DIESEL

Nº OE	Descripción/Description	Mat.	Ref.
	Jgo. de juntas para motor		400900-R
	Junta tapa cilindros Ø 104.0 ± 1.45	NFT 1	400907
	Jgo. tornillos tapa cilindros (HAS19038)		B400200
36811412	Junta tapa válvulas superior	CG 1	400210
36816702	Junta para cárter	NB 1	400211
36814124	Distribución a block	NB 1	400212
36867108	Bomba de agua a block	NB 1	400214
	Jgo. múltiple escape (3)	FCH 1	400215
	Jgo. múltiple admisión (4)	NFT 1	400217
0490301	Salida de escape	FCH 1	400218
36847319	Depósito cárter chico	NB 1	400233
36816702	Junta para cárter (1.00 mm)	NH	400234
36816702	Junta para cárter (0.08 mm)	NH	400235
0490485	Tapa trasera tapa cilindros	NB 1	400036
003202	Base filtro aceite	NB 1	400237
	Base filtro aceite	NB 1	400238
36831118	Válvula reguladora a block	NB 1	400239
0490687	Tapa trasera termoarranque	CG 1	400140
36846408	Inspección botadores	NB 2	400242
32811408	Lateral puente a block	GS 4	400442
36826107	Tapa inspección engranaje árbol de levas	CG 1	400243
36866434	Inspección engranaje comando auxiliar	NB 1	400244
002038	Vaso pre-filtro	CG 1	450045
0490685	Comando bomba combustible	NB 1	400146
36832118	Brida caño succión a bomba	NB 1	400249
368866424	Acople compresor a block	NB 1	400250
36846113	Cuerpo salida agua tapa cilindros	NB 1	400254
	Jgo. juntas empaquetadura bancada (2)	SLA 1	400158
36862126	Bomba alimentación combustible	NB 1	400165
	Junta base bomba alimentación	NB 1	400465
	Jgo. juntas compresor Burmor	VS	800069
	Kit de arandelas (57)	VS 1	400275
36867132	Placa cuerpo múltiple admisión	NB 1	400282
36817136	Porta retén bancada trasera	NB 1	400283
36822118	Placa adaptador bomba inyección	NB 1	400284
	Arandela inyector A 10 x 19 x 2 C	CU 6	
	Arandela A 10 x 14 x 1.5 A	AL 15	
	Arandela A 13 x 20.5 x 2 A	AL 15	
	Arandela A 17 x 22 x 1.5 A	AL 5	
	Arandela A 19 x 27 x 2 A	AL 1	
	Arandela A 8 x 12.5 x 1.5 A	AL 15	
	Kit de retenes completo		R400900
	Jgo. retén válvulas (12)	P 1	R400210P
	Retén distribución 60.32 x 79.36 x 9.5	P 1	R400012P
	Retén auxiliar 22.22 x 35.70 x 9.52	N 1	R400215N

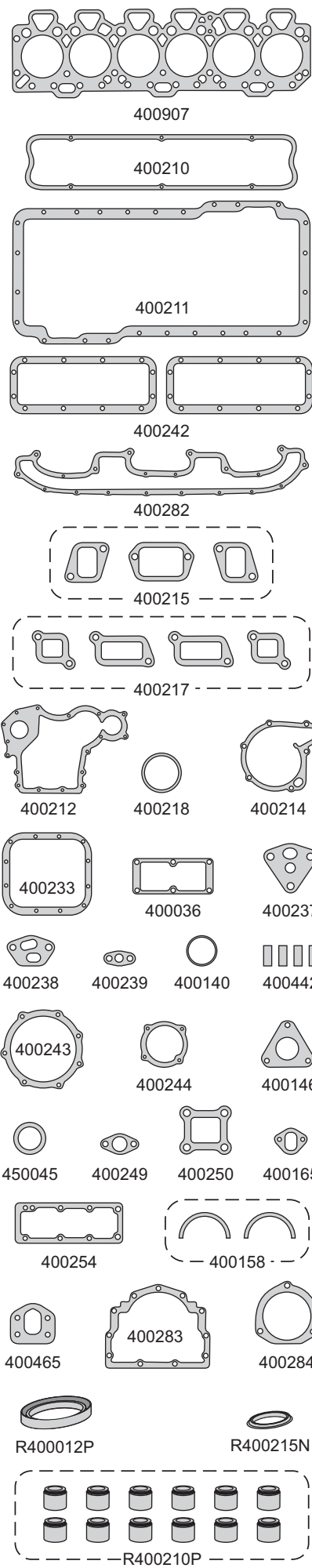

PERKINS



Motor/Engine	Cm³	HP	Ø
Q20B4 (OHV) 8V	3860	70	98.4

Chevrolet: Vehicular GM D20

DIESEL



Nº OE	Descripción/Description	Mat.	Ref.
424801/423607	Jgo. de juntas para motor		401000-R
	Jgo. de juntas superior		401095
	Jta. tapa cilindros Ø104.0 ± 1.70	NFT	410605
36812338	Jta. tapa cilindros Ø104.0 ± 1.70 N.R.	NFT	410607
70490149	Junta tapa válvulas	CG	1 1 410610
70490178	Junta para cárter	CG	1 280311
36813138	Tapa distribución	NB	1 410612
36814127	Placa distribución	NB	1 410613
36866724	Tapa bomba de agua trasera	NB	1 410614
36862134	Jgo. múltiple escape (2)	FCH	1 1 410616
0490301	Salida de escape	FCH	1 1 400218
70490144	Bomba de agua a block	NB	1 410619
36866416	Adaptador bomba vacio	NB	1 410630
70490146	Block a bomba de agua	NB	1 410631
36867156	Bomba de agua a block	NB	1 410731
36853514	Cuerpo salida agua	NB	1 1 410632
36851409	Tapa trasera tapa cilindros	NB	1 1 410633
36862517	Filtro lubricación block y placa	NB	2 410634
36834143	Bomba inyectora	NB	1 400435
0490734	Carcasa termostato	NB	1 1 410635
36817157	Porta retén bancada trasera	NB	1 400236
36862133	Múltiple admisión central	NB	1 1 410636
36862151	Conexión superior salida de agua	NB	1 1 410637
36862131	Múltiple admisión trasera	NB	1 1 410638
36866462	Múltiple admisión frontal	NB	1 1 410639
7049145	Cuerpo delantero y trasero bomba de agua	NB	1 410640
36835425	Carcaza a conexión superior	CG	1 410641
32811113	Bastón placa interior a block	GS	2 400442
36851113	Bomba alimentación a block	NB	1 410642
36832122	Tubo succión bomba aceite	NB	1 410643
36825107	Cierre inspección distribución	NB	1 400244
0490355	Tubo succión a válvula alimentación	NB	1 410644
36822111	Colector escape	NFT	2 2 410645
0490773	Comando bomba inyectora	NB	1 400146
70490100	Acoplamiento bomba inyectora	NB	1 410546
	Anillo lubricación tapa cilindros G10.7 x 6.2 x 6	GS	1 400646
	Adaptador vacio	NB	1 410747
	Junta placa ventilación	NB	1 410649
	Junta base bomba de nafta	NB	1 410650
	Junta válvula alivio	NB	1 410651
	Junta válvula alivio	NB	1 410652
	Junta conexión	NB	1 410653
	Junta base bomba de nafta	NB	1 410654
	Bomba de vacio a brida	NB	1 400062
	Arandela A 10 x 20 x 2 C	CU	4 4
	Arandela A 10 x 14 x 1.5 A	AL	4
	Arandela A 14 x 20 x 1.5 A	AL	10
	Arandela A 20 x 26 x 1 A	AL	1
	Arandela A 8 x 10 x 1 A	AL	8
	O´ring G 21 x 35 x 13	GS	4 4
	Kit de retenes completo		R410600
	Jgo. retén válvulas (8)	P	1 R300310P
	Retén bancada 133.35 x 158.75 x 11/13	P	1 R400211P
	Retén distribución 60.32 x 79.36 x 9.5	P	1 R400012P

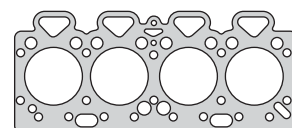

410607

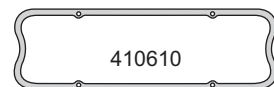

410610

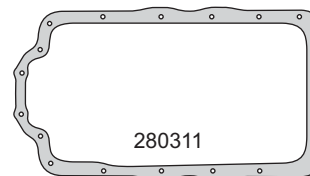

280311

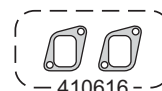

410616

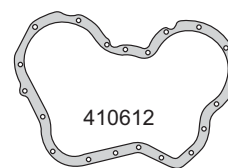

410612

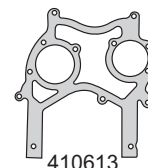

410613



410614



410619

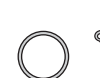

400218



410630



410631

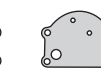

410731



410632



410633



410634



400435



410635



400236



410636



410637



410638



410639



410640



410641



410642



400442



410643



410644



400244



400146

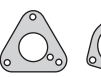

410546

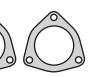

410645



410747



400062



410649

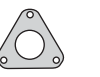

410650



410651



410652



410653

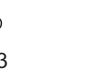

410654



R400211P



R400012P

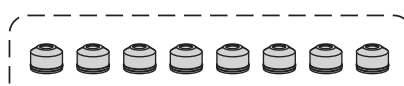

R300310P

PERKINS MAXION



Motor/Engine	Cm³	HP	Ø
P4000-4000T	4100	72/86	100

Perkins: MF290/292/610/620

DIESEL



Nº OE	Descripción/Description	Mat.	Ref.
	Jgo. de juntas para motor		401100-R
	Jgo. de juntas superior	●	401195
3681E016	Jta. tapa cilindros Ø105.0 ± 1.80 N.R.	NFT	1 1 280307
	Jgo. de tornillos para tapa de cilindros		B280300
7049258	Conj. junta tapa de válvulas (5)	N	1 1 280310
36815707	Junta para cárter	NB	1 1 401511
36813137	Tapa distribución	NB	1 1 410712
36814137	Placa distribución	NB	1 1 410613
	Bomba de agua	NB	1 1 420214
36886007	Jgo. múltiple escape (2)	NFT	1 1 280316
	Jgo. múltiple admisión (3)	NFT	1 1 280317
	Salida de escape	NFT	1 1 401118
C7NN-6659-A	Bomba aceite a block	NB	1 1 330030
	Junta conexión bomba de agua	NB	1 1 401131
36867156	Bomba agua a block	NB	1 1 410731
36853514	Cuerpo salida de agua	NB	1 1 410632
36851409	Tapa trasera tapa de cilindros	NB	1 1 410633
36862517	Filtro lubricación a block	NB	1 1 410634
36817157	Porta retén bancada trasero	NB	1 1 400236
36862151	Conexión superior salida de agua	NB	1 1 410637
36835428	Carcaza a conexión superior	CG	1 1 410641
32811113	Lateral puente a block	GS	2 2 400442
36832122	Tubo succión bomba aceite	NB	2 2 410643
36832404	Bomba succión aceite	NB	1 1 410743
36866434	Cierre inspección distribución	NB	1 1 400244
0490355	Junta tubo succión a válvula alimentación	NB	1 1 410644
36862138	Bocal lubricación	NB	1 1 410744
	Entrada aceite turbo	NB	420244
36822111	Múltiple escape	NFT	1 1 410645
	Block balanceador dinámico	NB	1 1 420245
	Arandela cierre tapa de válvulas	GS	4 4 400446
	Junta base bomba inyectora	NB	1 1 410650
	Bomba combustible	NB	410654
	Múltiple escape a turbo	AC	1 1 350462
70920104	Arandela base inyector A 7.5 x 15 x 2 C	CU	4 4
	Anillo lubricación tapa cilindros G 7.2 x 11 x 6	GS	1
	Kit de retenes completo		R410600
	Jgo. retén válvulas (8)	P	1 R300310P
	Jgo. retén válvulas (8)	P	1 R280310P
	Retén de bancada 133.35 x 158.75 x 11/13	V	1 R400211V
	Retén de distribución 60.32 x 79.36 x 9.5	P	1 R400012P

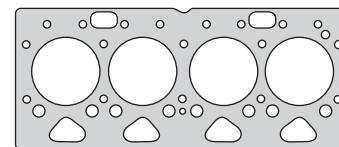

280307

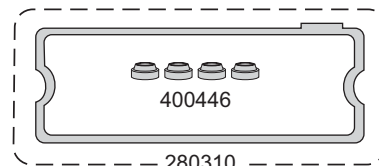

400446

280310

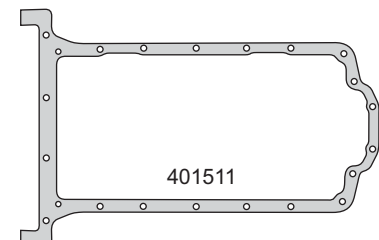

401511

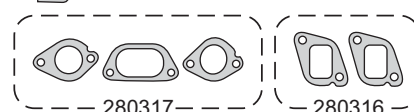

280317

280316

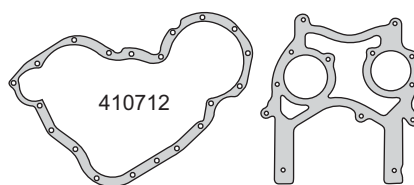

410712

410613

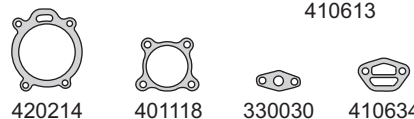

420214

401118

330030

410634

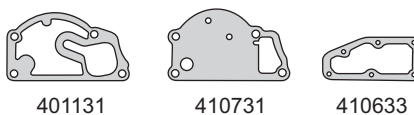

401131

410731

410633

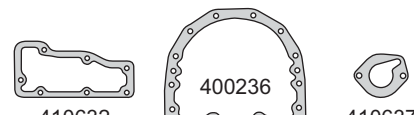

410632

400236

410637

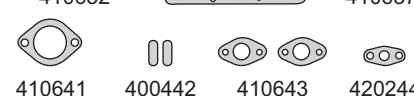

410641

400442

410643

420244

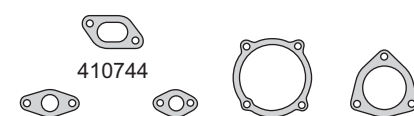

410744

410743

410644

400244

410645

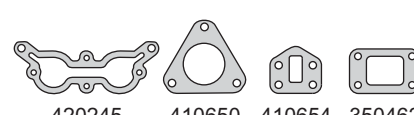

420245

410650

410654

350462

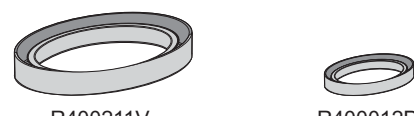

R400211V

R400012P

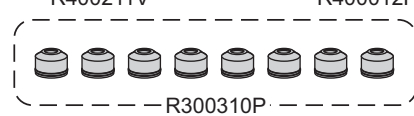

R300310P

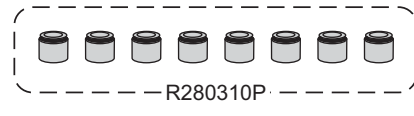

R280310P

PERKINS



Motor/Engine	Cm³	HP	Ø
1004.4	3993	86	100
1004.4T/TW (OHV) 8V	3993	91	100

Perkins: Phaser 90 - 4.40 - 110T - T4.40
Phaser 120 Ti - C4.40
MF6130/6140/6150



DIESEL

Nº OE	Descripción/Description	Mat.	Ref.
	Jgo. de juntas para motor		● 401500-R
3681E037	Junta tapa cilindros Ø 105.0 ± 1.50	NFT	1 401507
	Jgo. de tornillos para tapa de cilindros		B401500
3681A021	Junta tapa válvulas	CG	1 401510
36815721	Junta para cárter	NB	1 401511
3681P011	Tapa distribución	NB	1 401512
3681P009	Placa distribución	NB	1 401513
3382P004	Tapa bomba de agua	NB	1 401514
3688C023	Múltiple escape	AC	1 401515
3688C029	Múltiple admisión	SLS	1 401517
3686C018	Salida de escape colector	AC	1 401518
3687H005	Toma fuerza	NB	1 401529
3685R005	Cuerpo salida de agua a termostato	NB	1 401532
3685F005	Tapa trasera tapa cilindros	NB	1 401533
36864004	Base filtro aceite	NB	1 410433
	Guarnición goma G 94.84 x 3.53	GS	1 401534
3684A004	Junta termostato	NB	1 401535
36817181	Porta retén bancada trasero	NB	1 401536
	Junta	NB	1 401537
3682H003	Caracol turbina	NB	1 401637
	Junta brida entrada aceite turbo	NB	401538
	Junta brida salida aceite turbo	NB	401539
	Cierre bancada trasera	GS	2 400442
	Junta bomba alimentación	NB	1 410642
3684N008	Junta turbo escape	NB	1 401542
36832143	Bomba aceite enfriador	NH	401643
	Junta succión a lubricación aceite	NB	1 410743
33828108	Base bomba inyectora	NB	1 400246
	Entre múltiple turbo	AC	1 500546
36834143	Base bomba inyectora	NB	1 401648
36885.005	Salida de escape turbo	AC	1 350462
0490706	Base bomba inyectora	NB	1 401566
	Anillo goma G 21 x 30 x 9	GS	4
	Anillo goma G 4.5 x 8.5 x 6	GS	2
	Arandela A 8 x 11 x 1A	AL	10
	Arandela base inyector A 10 x 20 x 2 C	CU	4
	Arandela A 10 x 14 x 1.25 A	AL	3
	O'ring G 6 x 10 x 6	GS	10
	Kit de retenes completo		R401500
	Jgo. retén válvulas (8)	P	1 R280310P
	Retén bancada 133.35 x 158.75 x 11/13	V	1 R400211V
	Retén distribución 60.32 x 79.36 x 9.5	V	1 R400012V

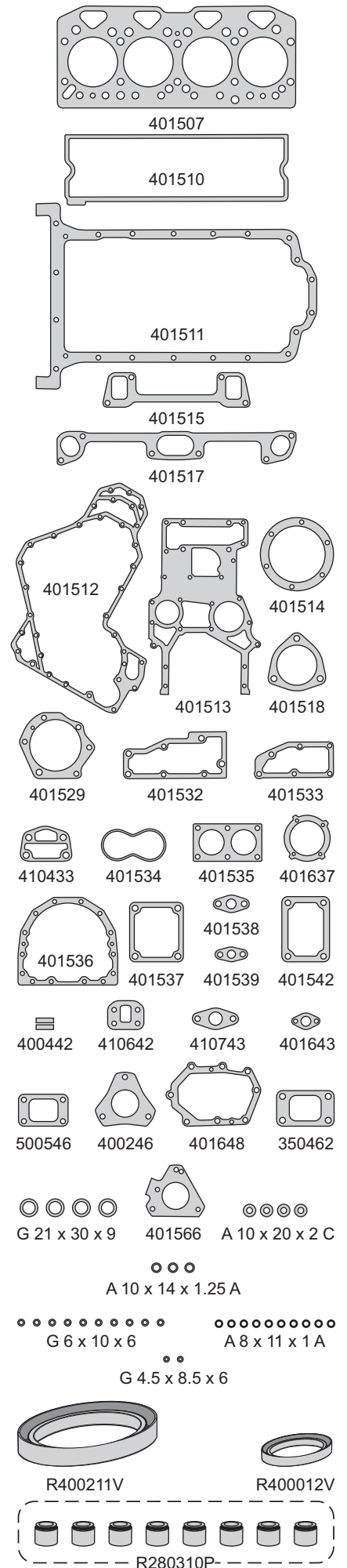

PERKINS



Motor/Engine	Cm ³	HP	Ø
1006.6C	5985	131	100
1006.6T/TW (OHV) 12V	5985	152	100

Perkins: Phaser 125 - MF396/399/630/640/3085
6160/6170 - Phaser 160Ti - MF660/3114
3125/3625/3635/3655/6189/6190/8110
8120/8130 1989/...
Phaser 180Ti 1989/...
MF399 1994/...



DIESEL

Nº OE	Descripción/Description	Mat.	Ref.
	Jgo. de juntas para motor		401600-R
3681H208	Junta tapa cilindros Ø 105.0 ± 1.50	NFT 1	401607
3681C001	Junta tapa válvulas	CG 1	401610
3681M007	Junta para cárter	NB 1	401611
3681P011	Tapa distribución	NB 1	401512
3681P001	Placa distribución	NB 1	401513
3382P004	Tapa bomba de agua	NB 1	401514
3688C173	Jgo. múltiple escape (3)	AC 1	401615
	Jgo. múltiple admisión (4)	AC 1	400417
	Junta brida	NB	401627
3686T006	Bomba alimentación combustible	NB 1	401628
3687H005	Toma fuerza	NB 1	401529
36832138	Succión de aceite turbo	NB	401631
3685R005	Cuerpo salida agua termostato	NB 1	401532
3685F005	Tapa trasera tapa cilindros	NB 1	401533
	Base filtro aceite	NB 2	410433
	Guarnición goma G 94.84 x 3.53	GS 1	401534
3687W003	Filtro aceite a block	NB 1	401634
3684A004	Junta carcasa termostato	NB 1	401535
36817181	Porta retén bancada trasera	NB 1	401536
3687Y002	Filtro aceite a block	NB 1	401636
	Junta	NB 1	401537
3682H003	Junta caracol turbina	NB 1	401637
3734K021	Junta brida	NB 1	401638
3683D006	Junta brida salida turbo	NH	401539
	Junta	NB 1	401639
	Anillo cono bronce G 6.2 x 8.5 x 6.2		401540
	Junta brida	NB 1	401640
	Anillo G 21.5 x 26.5 x 3	P	401541
	Arandela A 6 x 10 x 1 A	AL 14	401641
	Cierre bancada trasera	GS 2	400442
3683N004	Bomba de aceite	NB	401642
	Junta bomba alimentación a block	NB 1	410642
36832143	Bomba aceite enfriador	NH	401643
	Junta succióna lubricación aceite	NB 1	410743
36831127	Lubricación aceite a enfriador	NB 1	401644
	Brida recuperador aceite	NB 1	401645
	Brida	NB 1	401646
	Entre múltiples a turbo	AC 1	500546
3684R011	Junta refrigerador aceite	NB 1	401647
	Junta	NB 1	401648
3688A006	Salida de escape turbo	AC 1	350462
0490706	Superior bomba inyectora	NB 1	401566
	Guarnición goma G 21 x 30 x 9	GS 6	
	Anillo G 4.5 x 8.5 x 6	GS 2	
	Anillo G 6 x 10 x 6	GS 1	
	Arandela A 10 x 14 x 1.25 A	AL 2	
	Arandela base inyector A 10 x 20 x 2 C	CU 6	
	O´ring G 70 x 3	GS 1	
	O´ring G 45 x 2.5	GS 1	
	O´ring G 44.12 x 2.62	GS 1	
	O´ring G 31.34 x 3.53	GS 1	
	O´ring G 18.64 x 3.53	GS 1	

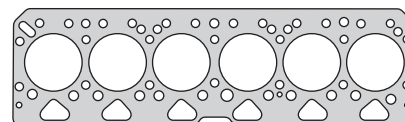

401607

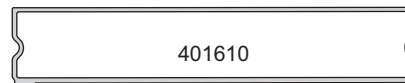

401610

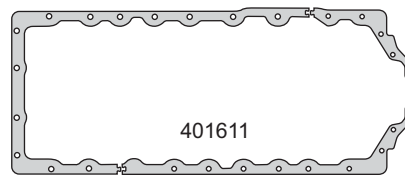

401611

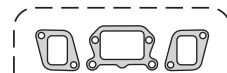

401615

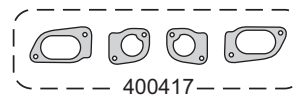

400417

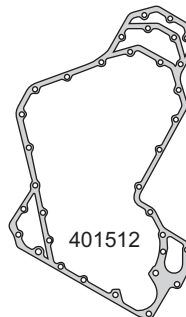

401512

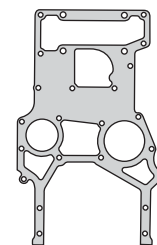

401513

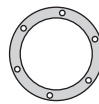

401514



401627



401628

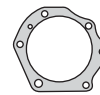

401529



401532

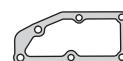

401533



401534



410433



401634



401535

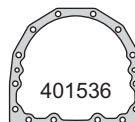

401536



401636



401637



401537



401638



401631



401639



401640



401540



400442



410642



401642



401643



410743



401644



401645



401646



500546



350462

PERKINS



Motor/Engine	Cm ³	HP	Ø
6.354-2 Turbo (OHV) 12V	5798		98.47

Massey Ferguson: 1095/1098/1195/1215 1970/...
Tractores - TD - Estancieros
Grúas - Rodantes



DIESEL

Nº OE	Descripción/Description	Mat.	Ref.
	Jgo. de juntas para motor		401700-R
	Jgo. de juntas superior	●	401795
36812545	Jta. tapa cilindros Ø 104.0 \pm 1.30 N.R.	CHA	1 1 400208
36812545	Jta. tapa cilindros Ø 104.0 \pm 1.50 N.R.	NFT	400207
	Jgo. tornillos tapa cilindros (HAS19038)		B400200
36811412	Junta tapa válvulas	CG	1 1 400210
36816702	Junta para cárter	NB	1 1 400211
368114124	Distribución a block	NB	1 1 400212
36867139	Tapa bomba de agua	NB	1 1 401714
36867173	Tapa bomba de agua inferior	NB	1 1 410414
	Jgo. múltiple escape (3)	FCH	1 1 401715
	Jgo. múltiple admisión (4)	FCH	1 1 401717
	Salida de escape	FCH	1 1 401718
36867117	Junta placa bomba agua inferior	NB	1 1 401719
36867174	Placa bomba agua	NB	1 1 410419
36847319	Depósito cárter chico	NB	1 1 400233
36866432	Codo bomba de agua	NB	1 1 401733
36816702	Junta para cárter (1.00 mm)	NB	400234
36816702	Junta para cárter (0.80 mm)	NB	400235
0490485	Tapa trasera tapa de cilindros	NB	1 1 400036
36817157	Portal retén bancada trasera	NB	1 1 400236
003202	Base filtro aceite cámara	NB	1 1 400237
002794	Base filtro aceite	NB	1 1 400238
36831118	Bomba reguladora a block	NB	1 1 400239
0490687	Tapa trasera termoarranque	CG	1 1 400140
	Jgo. juntas compresor tensa bicil.	VS	400240
36846408	Inspección botadores	NB	2 1 400242
32811408	Lateral puente a block	GS	4 1 400442
36826107	Tapa inspección engranaje árbol de levas	CG	1 1 400243
	Bomba alimentación combustible	NB	1 1 350943
	Junta turbo entrada turbina	AC	800343
36866434	Inspección engranaje comando auxiliar	NB	1 1 400244
	Junta salida aceite turbo	NB	1 1 350445
	Vaso combustible	CG	1 1 450045
33828108	Comando bomba combustible	NB	1 1 400246
36832118	Brida caño succión a bomba	NB	1 1 400249
36866426	Acople compresor a block	NB	1 1 400250
36846113	Cuerpo salida agua tapa cilindros	NB	1 1 400254
	Jgo. empaquetadura cigüeñal (2)	SLA	1 1 400158
	Tapa de válvula superior	CG	1 1 400261
	Colector escape turbo	AC	1 1 350462
36862126	Bomba alimentación combustible	NB	1 1 400165
006090	Bomba alimentación combustible	NB	1 1 400465
0490706	Junta bomba inyectora a block	NB	1 1 400066
	Kit de arandelas (57)	VS	1 1 400275
	Jgo. juntas turbo (5)	VS	800376
36867132	Placa cuerpo múltiple admisión	NB	1 1 400282
36817136	Porta retén bancada trasera	NB	1 1 400283
36822118	Placa adaptador bomba inyección	NB	1 1 400284
	Jgo. juntas turbo (5)	VS	800376
	Arandela pico inyector A 10 x 19 x 2 C	CU	6 6
	Arandela A 10 x 14 x 1.5 A	AL	15
	Arandela A 13 x 20.5 x 2 A	AL	15

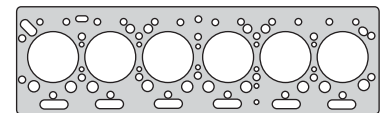

400208

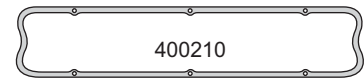

400210

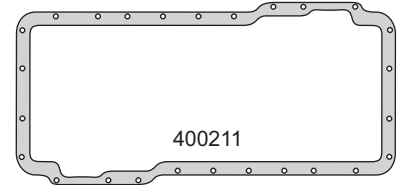

400211

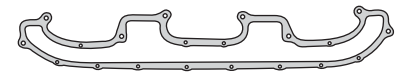

400282

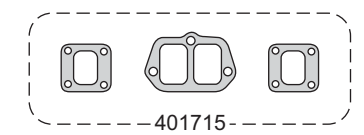

401715

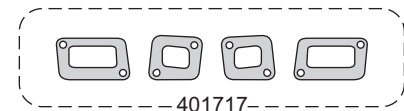

401717

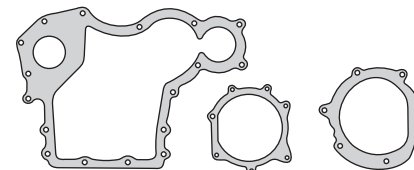

400212

410414

401714

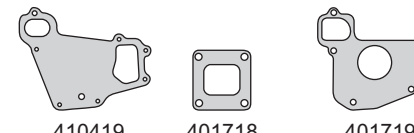

410419

401718

401719



400233

401733

400236



400036

400237

400238

400239



400140

400442

400243

400244

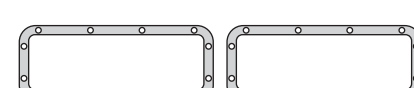

400242



400246

400249

450045

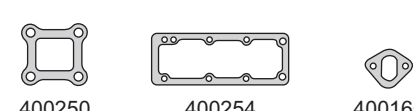

400250

400254

400165

PERKINS



Motor/Engine	Cm³	HP	Ø
6.354-2 Turbo (OHV) 12V	5798		98.47

Massey Ferguson: 1095/1098/1195/1215 1970/...
Tractores - TD - Estancieros
Grúas - Rodantes



DIESEL

Nº OE	Descripción/Description	Mat.	Ref.
	Arandela A 17 x 22 x 1.5 A	AL	5
105393	Arandela A 19 x 27 x 2 A	AL	1
	Arandela A 8 x 12.5 x 1.5 A	AL	15
	O'ring G 85.32 x 3.53	GS	1
	Kit de retenes completo		R401700
	Jgo. retén válvulas (12)	P	1 R401710P
	Retén bancada 133.35 x 158.75 x 11/13	V	1 R400211V
	Retén distribución 60.32 x 79.36 x 9.5	P	1 R400012P
	Retén auxiliar 22.22 x 35.70 x 9.52	N	R400215N

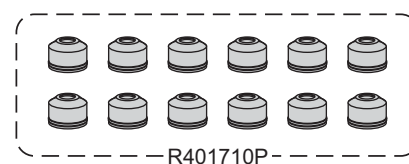
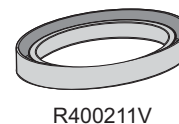
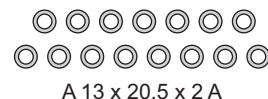
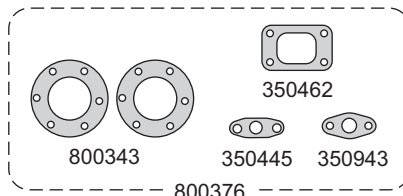
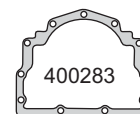

PERKINS



Motor/Engine	Cm³	HP	Ø
4.203 Potenciado (OHV) 8V	3336	71	91.44
DIESEL			

Ford: F100



Nº OE	Descripción/Description	Mat.	Ref.
	Jgo. de juntas para motor		410000-R
	Junta tapa cilindros Ø 92.5 ± 1.40	NFT 1	400005
36812125	Junta tapa cilindros Ø 92.5 ± 1.40	NFT	400007
	Junta tapa cilindros Ø 92.5 ± 1.15	CNC	400008
	Jgo. tornillos tapa cilindros (HAS19038)		B400000
0490704	Conjunto tapa válvulas superior (4)	CG 1	400010
	Jgo. junta para cárter (4)	NB 1	410011
006072	Tapa distribución	NB 1	400012
36814112	Block caja distribución	NB 1	400013
36866417	Bomba de agua	NB 1	400014
006002	Jgo. múltiple escape (2)	FCH 1	400015
006061	Múltiple admisión	NFT 1	400017
0490032	Salida de escape	FCH 1	400018
36883106	Arandela tapa válvulas	GS 3	400130
	Arandela base inyector A 14 x 20 x 1.5 C	CU	400033
33825409	Tapa frontal a tapa inspección	NB 1	400034
0490485	Tapa trasera tapa cilindro	NB 1	400036
006054	Tapa precámara combustión	CU 4	400037
006054	Precámara combustión	AL	410037
33826111	Porta retén bancada trasera	NB 1	400038
36866416	Caja distribución a bomba vacío	NB 1	400039
0490867	Tapa trasera termoarranque	CG 1	400140
36853105	Caja distribución tapa toma fuerza	NB 1	400045
0490685	Comando bomba combustible	NB 1	400146
0490699	Tapa trasera árbol levas	NB 1	400047
0490692	Conexión entrada agua	NB 1	400048
36835411	Conexión salida agua	NB 1	400051
0490024	Salida agua a tapa	NB 1	400052
0490184	Termostato	NB	400053
0490391	Cuerpo codo paso agua	NB 1	400153
006007	Filtro aceite a block	NB 1	400057
36866428	Bomba vacío tapa brida	NB 1	400062
006074	Bomba alimentación combustible	NB 1	400165
36865543	Soporte bomba inyectora	NB 1	400066
003152	Tapa inspección cárter	NB 1	410167
	Kit arandelas (57)	VS 1	400075
	Arandelas A 10 x 14 x 1 A	AL 15	
	Arandelas A 13 x 20 x 1 A	AL 10	
	Arandelas A 14.5 x 20.5 x 1.5 C	CU 6	
	Arandelas A 17.5 x 22 x 1 A	AL 10	
	Arandelas A 19 x 27 x 2 A	AL 1	
	Arandelas A 8 x 12.5 x 1 A	AL 15	
	Kit de retenes completo		R400000-1
	Jgo. retén válvulas (8)	P 1	R400010P
	Jgo. retén válvulas (8)	P 1	R300310P
	Retén bancada 133.35 x 158.75 x 11/13	P 1	R400211P
	Retén distribución 60.32 x 79.36 x 9.5	P 1	R400012P

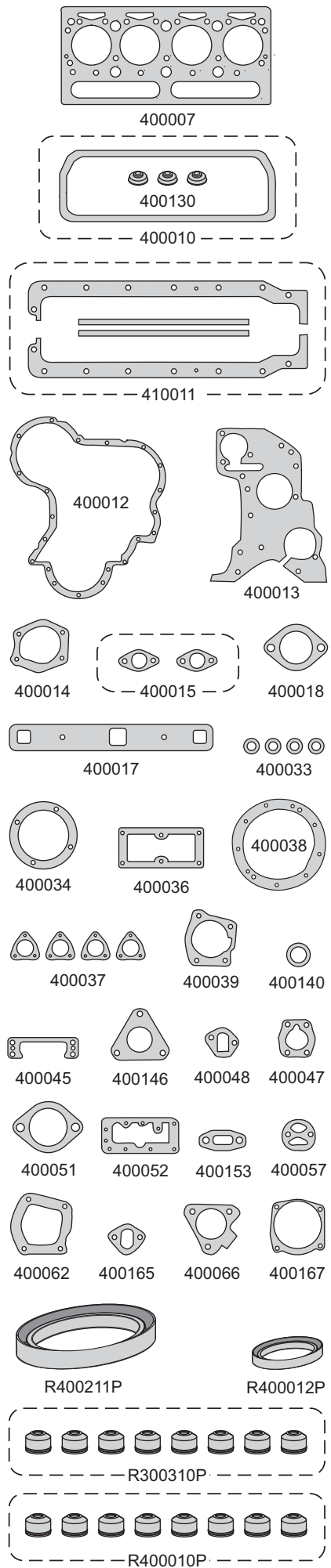

PERKINS**taranto**

Motor/Engine

Cm³

HP

Ø

Ford: F600

6PF - 305
Potenciado

5004

100

91.49

DIESEL



Nº OE	Descripción/Description	Mat.	Ref.
	Jgo. de juntas para motor		● 410100-R
006063	Junta tapa cilindros Ø 92.5 ± 1.40	NFT 1	400307
	Junta tapa cilindros Ø 92.5 ± 1.25	FCH	400308
	Jgo. tornillos tapa cilindros (HAS19038)		B400300
0490760	Conj. junta tapa válvulas superior (5)	CG 1	400110
006074	Jgo. junta para cárter (4)	NB 1	410111
006072	Caja distribución tapa frontal	NB 1	400012
36814112	Block caja distribución	NB 1	400013
36866417	Bomba de agua placa trasera	NB 1	400014
006002	Múltiple escape	FCH 3	400015
0490026	Jgo. múltiple admisión (2)	NFT 1	400117
0490032	Salida de escape	FCH 1	400018
	Arandela tapa válvulas	GS 4	400130
0920113	Arandela base inyector A 14 x 20 x 1.5 C	CU	400033
33825409	Tapa frontal tubo venteo	NB 1	400034
0490458	Tapa trasera tapa cilindros	NB 1	400036
006054	Precámara combustión	CU 6	400037
006054	Precámara combustión	AL	410037
33826111	Porta retén bancada trasera	NB 1	400038
36866416	Caja distribución bomba vacío	NB 1	400039
	Junta tapa trasera termoarranque	CG 1	400140
36853105	Caja distribución tapa t/fuerza	NB 1	400045
0490685	Comando bomba combustible	NB 1	400146
0490699	Block tapa trasera	NB 1	400047
0490692	Conexión entrada agua	NB 1	400048
002742	Caño aceite a block	NB 1	400249
36835411	Conexión salida agua	NB 1	400051
0490024	Salida agua a tapa	NB 1	400052
0490184	Termostato	NB	410053
0490351	Cuerpo codo paso agua	NB 2	400153
006007	Filtro aceite a block	NB 1	400057
36866428	Bomba vacío a tapa distribución	NB 1	400062
006074	Bomba vacío a bomba combustible	NB 1	400165
36865543	Soporte bomba inyectora	NB 1	400066
	Kit arandelas (57)	VS 1	400175
	Arandelas A 14 x 20 x 1.25 C	CU 6	
	Arandelas A 10 x 14 x 1 A	AL 15	
	Arandelas A 13 x 20 x 1.25 A	AL 10	
	Arandelas A 17 x 22 x 1 A	AL 10	
	Arandelas A 19 x 27 x 2 A	AL 1	
	Arandelas A 8 x 12 x 1 A	AL 15	
	Kit de retenes completo		R410100
	Jgo. retén válvulas (12)	P 1	R400110P
	Jgo. retén válvulas (12)	P 1	R540210P
	Retén bancada 133.35 x 158.75 x 11/13	P 1	R400211V
	Retén distribución 60.32 x 79.36 x 9.5	V 1	R400012P

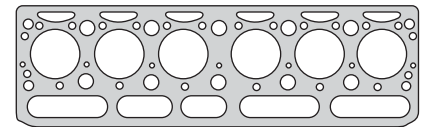

400307

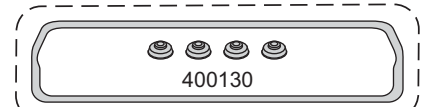

400130

400110

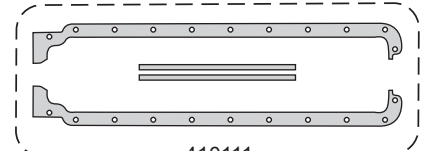

410111

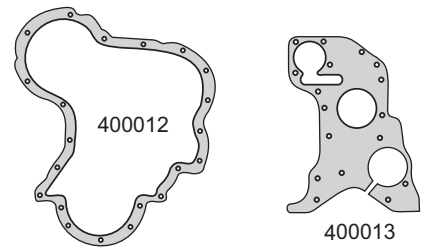

400012

400013



400015



400117

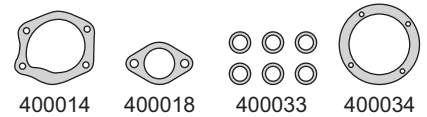

400014

400018

400033

400034

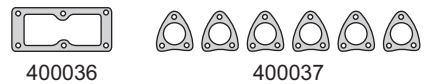

400036

400037

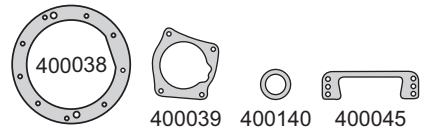

400038

400039

400140

400045

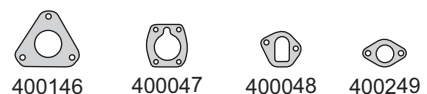

400146

400047

400048

400249

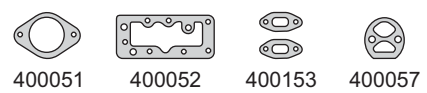

400051

400052

400153

400057



400062

400066

400165

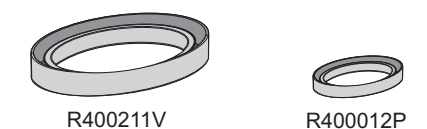

R400211V

R400012P

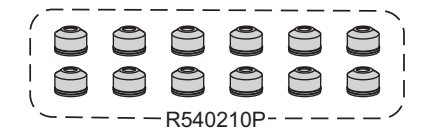

R540210P

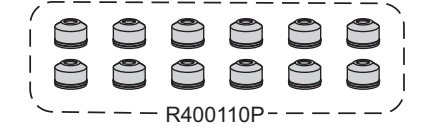

R400110P

PERKINS



Motor/Engine	Cm³	HP	Ø
P3 - 152	2502	42	91.44

Perkins: Tractor
Massey Ferguson: MF50 Tractor - MF50X/55X
 MF135/200/235/250



DIESEL

Nº OE	Descripción/Description	Mat.	Ref.
	Jgo. de juntas para motor		410200-R
	Junta tapa cilindros Ø 93.0 ± 1.45	NFT	400507
368112122	Junta tapa cilindros Ø 93.0 ± 1.45	FCH	400508
	Jgo. tornillos tapa cilindros (HAS19038)		B400000
0490491	Conj. junta tapa válvulas superior (3)	CG	400510
003249	Jgo. junta para cárter (4)	NB	400511
	Tapa distribución	NB	410212
36814119	Placa distribución	NB	400513
36866417	Bomba de agua	NB	400014
006002	Múltiple escape	FCH	400015
0490032	Salida de escape	FCH	400018
	Arandela tapa válvulas	GS	400130
	Arandela pico inyector A 14 x 20 x 1.5 C	CU	400033
	Depósito cárter	NB	400533
0490482	Cuerpo salida agua	NB	400534
85014018	Bomba hidráulica a toma fuerza	CB	400535
006081	Tapa trasera cigüeñal	NB	400035
0490485	Tapa trasera tapa cilindros	NB	400036
0490738	Cuerpo salida agua tapa cilindros	NB	400536
006054	Precámara combustible	CU	400037
36862511	Tapa trasera árbol levas	NB	400537
006054	Precámara combustión	AL	410037
	Base filtro aceite c/ref.	NB	400237
0490686	Cuerpo toma aire	NB	400538
0490486	Tapa conexión entrada aire	NB	400539
0490687	Tapa trasera termoarranque	CG	400140
36862512	Tapa inspección carga aceite	NB	400540
36862165	Bomba alimentación	NB	400541
002478	Tapa inspección engranje distribución	NB	400542
36853105	Caja a tapa toma fuerza	NB	400045
0490685	Comando bomba combustible	NB	400146
36835411	Conexión salida agua	NB	400051
0490391	Cuerpo codo paso agua	NB	400153
006047	Filtro aceite a block	NB	400057
36883106	Jgo. juntas bancada cigüeñal (2)	SLA	400158
36851106	Soporte bomba vacío	NB	400163
006074	Bomba alimentación combustible	NB	400165
	Kit de retenes completo		R400500
	Jgo. retén válvulas (6)	P	R400510P
	Jgo. retén válvulas (6)	P	R400610P
	Retén bancada 133.35 x 158.75 x 11/13	P	R400211P
	Retén distribución 60.32 x 79.36 x 9.5	P	R400012P

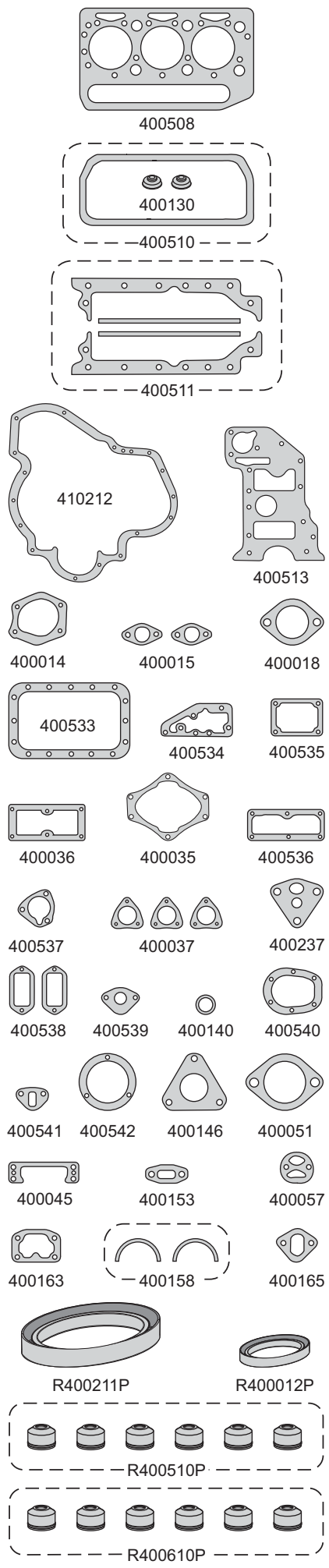

PERKINS



Motor/Engine	Cm³	HP	Ø
MF265 Potenciado	3336	71	91.44
DIESEL			

Massey Ferguson: Potenciado



Nº OE	Descripción/Description	Mat.	Ref.
	Jgo. de juntas para motor		410300-R
36812125	Junta tapa cilindros Ø 92.5 ± 1.40	NFT	400005
	Junta tapa cilindros Ø 92.5 ± 1.40	NFT	1 400007
	Junta tapa cilindros Ø 92.5 ± 1.15	CNC	400008
	Jgo. tornillos tapa cilindros (HAS19038)		B400000
0490704	Conj. junta tapa válvulas superior (4)	CG	1 400010
	Jgo. junta para cárter (4)	NB	1 410311
006013	Tapa distribución	NB	1 400612
36814112	Block caja distribución	NB	1 400013
36866417	Bomba de agua	NB	1 400014
006002	Múltiple escape	FCH	2 400015
006061	Múltiple admisión	NFT	1 400017
0490032	Salida de escape	FCH	1 400018
	Arandela tapa válvulas	GS	3 400130
006020	Brida bomba hidráulica	NB	1 400631
0920113	Arandela base inyector A 14 x 20 x 1.5 C	CU	4 400033
33825409	Tapa frontal a tapa inspección	NB	1 400034
0490485	Tapa trasera tapa cilindros	NB	1 400036
006054	Tapa precámara combustión	CU	4 400037
006054	Precámara combustión	AL	410037
33826111	Porta retén bancada trasera	NB	1 400038
	Tapa trasera termoarranque	CG	1 400140
0490685	Comando bomba combustible	NB	1 400146
0490699	Tapa trasera árbol levas	NB	1 400047
0490692	Conexión entrada agua	NB	1 400048
36835411	Conexión salida agua	NB	1 400051
0490024	Salida agua a tapa	NB	1 400052
0490184	Termostato	NB	400053
0490391	Cuerpo codo paso agua	NB	1 400153
006007	Filtro aceite a block	NB	1 400057
006074	Bomba alimentación combustible	NB	1 400165
36865543	Soporte bomba inyectora	NB	1 400066
	O'ring G 18.77 x 1.78	GS	2 400767
	Kit arandelas (57)	VS	400075
	Arandela A 8 x 12.5 x 1 A	AL	
	Arandela A 10 x 14 x 1 A	AL	
	Arandela A 13 x 20 x 1 A	AL	
	Arandela A 17.5 x 22 x 1 A	AL	
	Arandela A 14.5 x 20.5 x 1.5 C	CU	
	Arandela A 19 x 27 x 2 A	AL	
	Kit de retenes completo		R400000-1
	Jgo. retén válvulas (8)	P	1 R400010P
	Jgo. retén válvulas (8)	P	1 R300310P
	Retén bancada 133.35 x 158.75 x 11/13	P	1 R400211V
	Retén distribución 60.32 x 79.36 x 9.5	V	1 R400012P

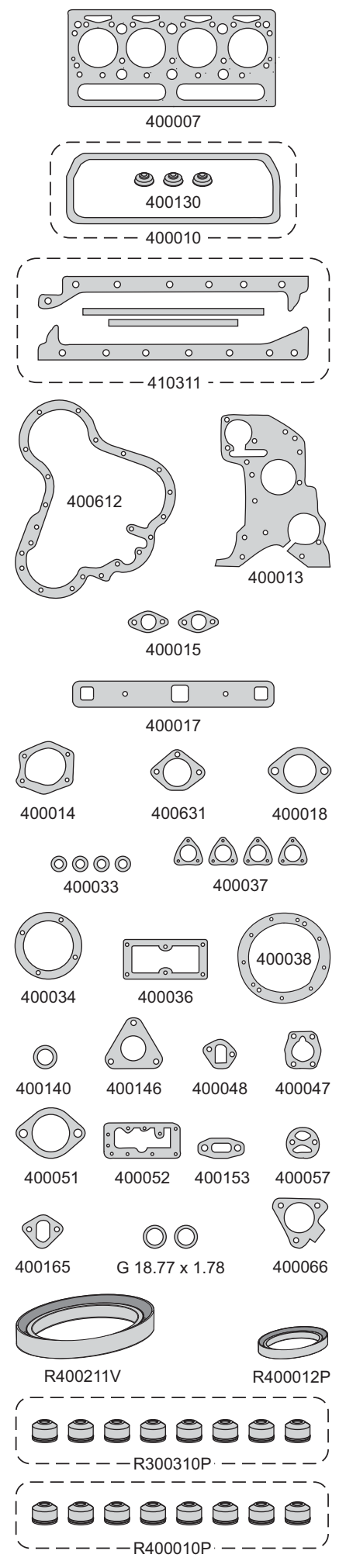

PERKINS



Motor/Engine **Cm³** **HP** **Ø**

T6.354-4 **5798** **172** **98.63**

(OHV) 12V

Perkins: Tractor 1215 - 1218

DIESEL



Nº OE	Descripción/Description	Mat.	Ref.
105784	Jgo. de juntas para motor		410400-R
	Junta tapa cilindros Ø 104.0 ± 1.50	NFT	400407
368142607	Junta tapa cilindros Ø 104.0 ± 1.45	CHA	400408
	Jgo. tornillos tapa cilindros (HAS19038)		B400200
006104	Conj. junta tapa válvulas (5)	CG	400410
006088	Junta para cárter	NB	400211
36814124	Caja distribución a block	NB	400212
36867173	Bomba de agua a block	NB	410414
	Jgo. múltiple escape (3)	AC	400416
	Jgo. múltiple admisión (4)	AC	400417
37481108	Salida de escape	AC	400418
36867174	Placa bomba de agua	NB	410419
36865532	Bomba de aceite a block	NB	400427
36833125	Bomba carga de aceite	CG	400429
36831122	Válvula reguladora aceite	NB	400430
36832133	Caño aceite turbo	NB	400431
36833148	Drenaje aceite turbo	NB	400432
36861448	Adaptador alimentación aceite	NB	400433
36862538	Base filtro aceite	NB	410433
36861745	Conexión salida agua	NB	400434
36834143	Bomba inyectora	NB	400435
0490485	Tapa trasera tapa cilindros	NB	400036
36817157	Porta retén trasero	NB	400236
36866739	Cabezal a block	NB	410437
36823132	Tapa múltiple codo a múltiple admisión	NB	400438
36821118	Entrada agua a block	NB	400439
0490474	Caño ventilación a tapa válvulas	NB	400440
0490053	Tapa cierre	NB	400441
32811408	Lateral puente a block	GS	400442
36826107	Tapa inspección engranaje árbol de levas	CG	400243
36866434	Tapa inspección engranaje codo auxiliar	NB	400244
36833139	Caño bomba de aceite	NB	400444
	Arandela tapa válvulas	GS	400446
36866426	Compresor a block	NB	400250
36846113	Cuerpo salida a agua	NB	400254
006090	Bomba alimentación a block	NB	400465
36822118	Placa adaptador a block	NB	400284
	Arandela inyector A 10 x 20 x 1 C	CU	6
	Arandelas A 7 x 10 x 1 A	AL	12
	Kit de retenes completo		R400200-1
	Jgo. retén válvulas (12)	P	R400210P
	Retén bancada 133.35 x 158.75 x 11/13	P	R400211P
	Retén distribución 60.32 x 79.36 x 9.5	P	R400012P
	Retén auxiliar 22.22 x 35.70 x 9.52	N	R400215N

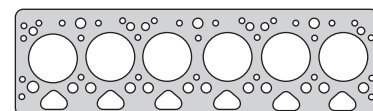

400408

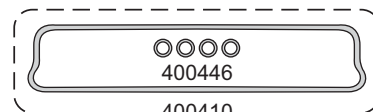

400446

400410

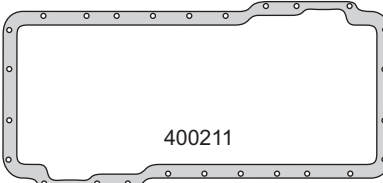

400211

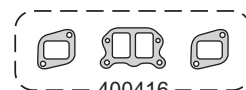

400416

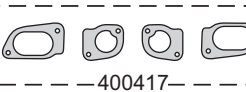

400417

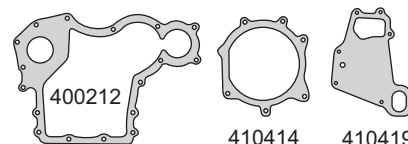

400212

410414

410419

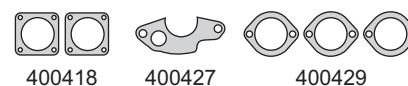

400418

400427

400429



400430

400431

400432

410433



400433

400434

400236

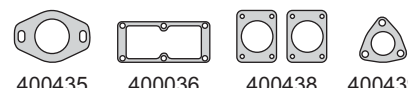

400435

400036

400438

400439



400440

400441

400442

400244



400243

400444

400254



400465

400250

400284



A 10 x 20 x 1 C

A 7 x 10 x 1 A

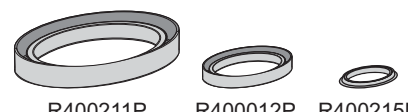

R400211P

R400012P

R400215N

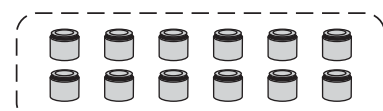

R400210P

PERKINS



Motor/Engine	Cm³	HP	Ø
D4.203 AD4.203	3330	71	91.4
DIESEL			

Massey Ferguson: Tractor MF65X - MF40B/65
MF155/158/165/260/155
MF164C - CBC1000



Nº OE	Descripción/Description	Mat.	Ref.
420311/309	Jgo. de juntas para motor	●	410500-R
	Junta tapa cilindros Ø 93.0 ± 1.40	NFT	410505
70490147	Junta tapa cilindros Ø 93.0 ± 1.40	NFT	1 410507
	Junta tapa cilindros Ø 93.0 ± 1.50	CNC	410508
36811112	Junta tapa válvulas	CG	1 410510
36884108	Jgo. junta para cárter (4)	NB	1 410511
70490031	Tapa distribución	NB	1 410512
70490030	Placa distribución	NB	1 410513
36866415	Tapa bomba de agua	NB	1 410514
36837409	Múltiple escape	NFT	2 410516
36867116	Múltiple admisión	NB	1 410517
80490032	Salida de escape	NFT	1 410518
70920081	Arandela inyector A 10 x 20 x 1.5 A	AL	410533
33817114	Arandela A 10 x 21 x 2 C	CU	410534
0490485	Tapa trasera tapa cilindro	NB	1 400036
70490014	Tubo salida de escape	NFT	1 410538
36817141	Superior	NB	1 410539
36812512	Tapa inspección delantera	NB	1 400540
70490063	Alojamiento bomba inyectora	NB	1 410546
0490699	Alojamiento comando	NB	1 400047
0490697	Tapa alojamiento engranaje	NB	2 410547
0490692	Entrada agua a block	NB	1 400048
36865108	Inspección caja distribución	NB	1 410548
0490702	Desvió lateral agua	NB	1 410549
0490707	Conexión superior bomba agua	NB	1 410551
0490701	Salida agua tapa cilindro	NB	1 400052
2415745	O'ring G 91.44 x 5.33	GS	1 410552
064144	O'ring G 21.82 x 3.53	GS	1 410553
0490514	Filtro aceite a block	NB	2 410557
	Jgo. empaquetadura cigüeñal (2)	SNA	410958
36812152	Soporte tapa alimentación	NB	1 400165
0490706	Soporte bomba inyectora	NB	1 410566
	Arandela A 14 x 20 x 1.5 C	CU	4
	Arandela A 10 x 20 x 2 C	CU	4
	Kit de retenes completo		R400000-1
	Jgo. retén válvulas (8)	P	1 R400010P
	Jgo. retén válvulas (8)	P	1 R300310P
	Retén bancada 133.35 x 158.75 x 11/13	P	1 R400211P
	Retén distribución 60.32 x 79.36 x 9.5	P	1 R400012P

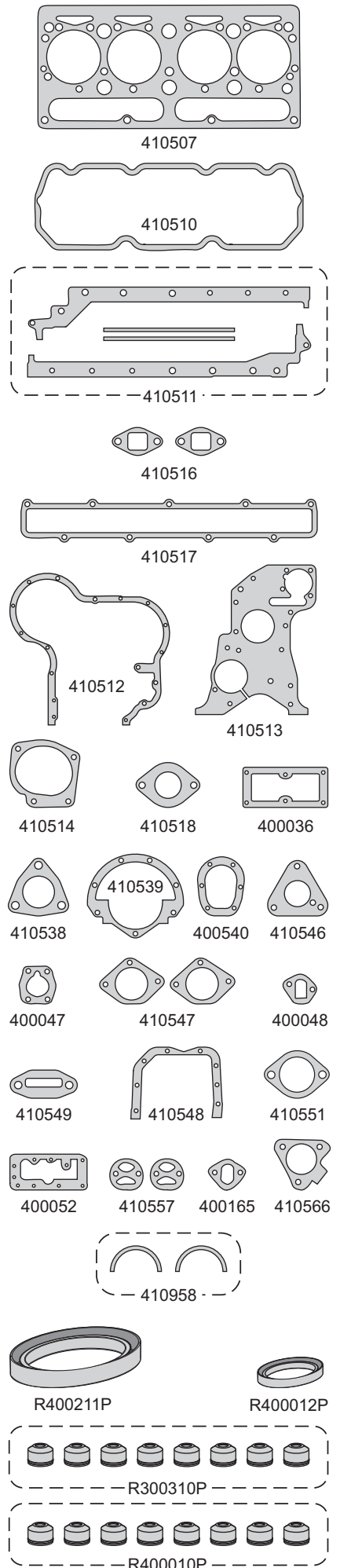

PERKINS



Motor/Engine	Cm ³	HP	Ø
Q20B4 - 4.236	3860	70	98.4
4.248	4070	70	101
(OHV) 8V			

Chevrolet: GM D10/20/40 Aspirado Turbo
Massey Ferguson: MF220 - F290 - MF85X
Maxion-Perkins: GM D10 - F350 - VW6.80 Case 550



DIESEL

N° OE	Descripción/Description	Mat.	Ref.
424801/423607	Jgo. de juntas para motor		410600-R
	Jgo. de juntas superior	●	410695
	Jta. tapa cilindros Ø 104.0 \pm 1.70	NFT	410605
36812338	Jta. tapa cilindros Ø 104.0 \pm 1.70	NFT	410607
70490149	Junta tapa válvulas	CG	410610
36815706	Junta para cárter	NB	410611
36813138	Tapa distribución	NB	410612
36814127	Placa distribución	NB	410613
36866724	Tapa bomba de agua trasera	NB	410614
36862134	Jgo. múltiple escape (2)	FCH	410616
0490301	Salida de escape	FCH	400218
70490144	Bomba de agua a block	NB	410619
36866416	Adaptador bomba de vacío	NB	410630
70490146	Block a bomba de agua	NB	410631
36853514	Cuerpo salida agua	NB	410632
0921173	Arandela pico inyector A 10 x 20 x 1.5 C	CU	410533
36851409	Tapa trasera tapa cilindros	NB	410633
36862517	Filtro lubricación block y placa	NB	410634
36834143	Bomba inyectora	NB	400435
0490734	Carcasa termostato	NB	410635
36817157	Porta retén bancada trasera	NB	400236
36862133	Múltiple admisión central	NB	410636
36862151	Conexión superior salida de agua	NB	410637
002794	Base filtro aceite	NB	400238
36862131	Múltiple admisión trasera	NB	410638
36865511	Distribución a bomba de vacío	NB	400039
36866462	Múltiple admisión frontal	NB	410639
7049145	Cuerpo delantero y trasero bomba de agua	NB	410640
36835425	Carcasa a conexión superior	CG	410641
32811113	Bastón placa interior a block	GS	400442
36851113	Bomba alimentación a block	NB	410642
36832122	Tubo succión bomba aceite	NB	410643
	Junta succión a lubricación aceite	NB	410743
36825107	Cierre inspección distribución	NB	400244
0490355	Tubo succión a válvula alimentación	NB	410644
	Junta boca lubricación	NB	410744
36822111	Colector escape	NFT	410645
0490773	Comando bomba inyectora	NB	400146
70490100	Acoplamiento bomba inyectora	NB	410546
	Adaptador vacío	NB	410747
	Bomba de vacío a brida	NB	400062
36817136	Porta retén bancada trasera	NB	400283
36866416	Anillo lubricación tapa cilindros G 7.2 x 11 x 6	GS	
	Arandela A 10 x 20 x 2 C	CU	
	Kit de retenes completo		R410600
	Jgo. retén válvulas (8)	P	R300310P
	Jgo. retén válvulas (8)	P	R410610P
	Retén bancada 133.35 x 158.75 x 11/13	P	R400211P
	Retén distribución 60.32 x 79.36 x 9.5	P	R400012P

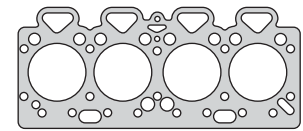

410607

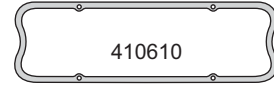

410610

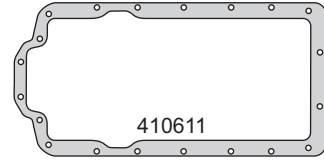

410611

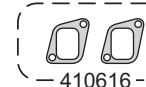

410616

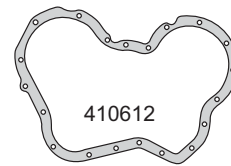

410612

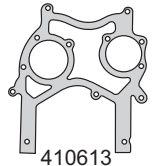

410613



410614

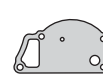

410619



400218



410630



410631



410632



410533



410633



410634



400435



410635



400236



410636



410637



400238



410638



400039



410639



410640



410641



410642



400442



410643



410743



410744



410644



400244



400146

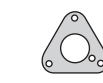

410546



410645



410747



400062



400283



R400211P



R400012P



R300310P



R410610P

PERKINS



Motor/Engine	Cm³	HP	Ø
A4 - 248	4070	75	100

Massey Ferguson: Agrícola - Case 580H - MF85
270 - 275 - 285 - 290
MF 220/220A - Hyster H110



DIESEL

Nº OE	Descripción/Description	Mat.	Ref.
424801/802	Jgo. de juntas para motor		● 410700-R
	Junta tapa cilindros Ø 104.0 ± 1.70	NFT	1 410605
36812338	Junta tapa cilindros Ø 104.0 ± 1.70	NFT	410607
70490149	Junta tapa válvulas	CG	1 410610
36815707	Junta para cárter	NB	1 401511
36813137	Tapa distribución	NB	1 410712
36814127	Placa distribución	NB	1 410613
36866724	Cuerpo bomba de agua	NB	1 410614
36862134	Jgo. múltiple escape (2)	FCH	1 410616
0490301	Salida de escape	FCH	1 400218
70490144	Bomba de agua a block	NB	1 410719
36866416	Adaptador bomba vacío	NB	1 410630
36867156	Bomba agua a block	NB	1 410731
36853514	Cuerpo salida agua	NB	1 410632
0921173	Arandela pico inyector A 10 x 20 x 2 C	CU	4 410533
36851409	Tapa trasera tapa cilindros	NB	1 410633
36862517	Filtro lubricación a block	NB	2 410634
36834143	Adaptador bomba inyectora	NB	1 400435
0490734	Carcasa termostato	NB	1 410635
	Porta retén bancada trasera	NB	1 400236
36862133	Múltiple admisión central	NB	1 410636
36862151	Conexión superior salida agua	NB	1 410637
36862131	Múltiple admisión trasera	NB	1 410638
36865511	Distribución a bomba vacío	NB	1 400039
36866462	Múltiple admisión frontal	NB	410639
70490145	Cuerpo delantero y trasero bomba agua	NB	1 410640
36835428	Carcasa a conexión superior	CG	1 410641
	Bastón placa a block	GS	2 400442
36851113	Bomba alimentación a block	NB	1 410642
	Tubo succión bomba aceite	NB	1 410643
36832404	Bomba succión a lubricación aceite	NB	1 410743
0490355	Bomba succión a válvula alivio	NB	1 410644
36862138	Boca lubricación	NB	2 410744
36822111	Colector escape	NFT	2 410645
36866722	Trasera bomba	NB	1 410745
0490773	Comando bomba inyectora	NB	1 400146
33825414	Cubierta tapa trasera	CG	1 410746
7049083	Acople bomba inyectora	NB	1 410546
	Adaptador vacío	NB	1 410747
	Jgo. empaquetadura bancada cigüeñal (2)	SLA	1 400158
	Jgo. empaquetadura bancada cigüeñal	SNA	410958
36866428	Bomba vacío a brida	NB	1 400062
36817137	Carcasa a block	NB	1 400283
	Anillo lubricación tapa de cilindros G 7.2 x 11 x 6	GS	1
	Kit de retenes completo		R410700
	Jgo. retén válvulas (8)	P	1 R300310P
	Jgo. retén válvulas (8)	P	1 R280310P
	Retén bancada 133.35 x 158.75 x 11/13	V	1 R400211V
	Retén distribución 60.32 x 79.36 x 9.5	P	1 R400012P

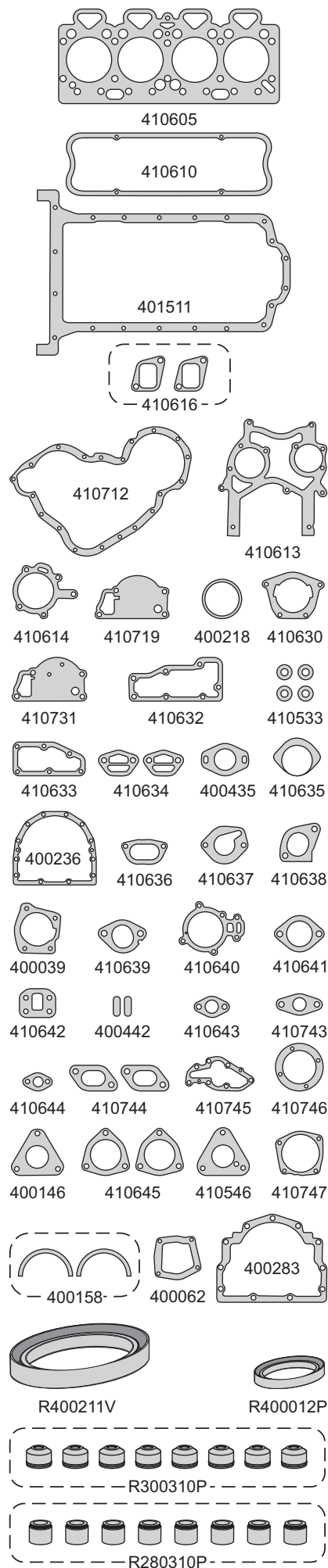

PERKINS



Motor/Engine	Cm³	HP	Ø
T 4.33 Turbo Iny. Directa	3330	91/95	91.46
DIESEL			

Perkins: Pick Up - Camiones livianos



Nº OE	Descripción/Description	Mat.	Ref.
005967	Jgo. de juntas para motor	●	410800-R
006283	Junta tapa cilindros Ø 93.0 \pm 1.40	NFT	410807
	Junta tapa cilindros Ø 93.0 \pm 1.25	CNC	1 410808
0490704	Conj. junta tapa válvulas (4)	CG	1 400010
006076	Jgo. junta para cárter (4)	NB	1 410011
006072	Tapa distribución	NB	1 400012
36814112	Placa distribución	NB	1 400013
36866417	Tapa bomba de agua	NB	1 400014
006322	Jgo. múltiple escape (2)	NFT	1 410816
006061	Múltiple admisión	NFT	1 400017
0490184	Conexión salida agua	CB	1 300019
	Arandelas tapa válvula	GS	3 400130
36833148	Drenaje aceite turbo	NB	1 400432
33825409	Tapa frontal	NB	1 400034
3686454	Turbo a descarga caño aceite	NB	1 410834
36832131	Entrada aceite turbo	NB	1 410835
0490485	Tapa trasera	NB	1 400036
006319	Múltiple admisión a codo admisión	NB	1 410836
006320	Turbo a codo salida de escape	NFT	1 410837
338261111	Porta retén bancada	NB	1 400038
36866416	Caja distribución bomba vacío	NB	1 400039
36822111	Codo a salida de escape	NFT	1 410645
006323	Comando bomba combustible	NB	1 400246
0490699	Tapa trasera árbol levas	NB	1 400047
0490692	Conexión entrada agua	NB	1 400048
3683211	Succión aceite	NB	1 400249
0490024	Salida agua a tapa cilindros	NB	1 400052
006007	Filtro aceite a block	NB	1 400057
36885008	Turbo a múltiple escape	AC	1 350462
006074	Bomba alimentación	NB	1 400165
L 311 FF 02	Arandela inyector A 15.1 x 18 x 1.5 C	CU	4
	Kit de retenes completo		R400000-1
	Jgo. retén válvulas (8)	P	1 R400010P
	Jgo. retén válvulas (8)	P	1 R300310P
	Retén bancada 133.35 x 158.75 x 11/13	P	1 R400211P
	Retén distribución 60.32 x 79.36 x 9.5	P	1 R400012P

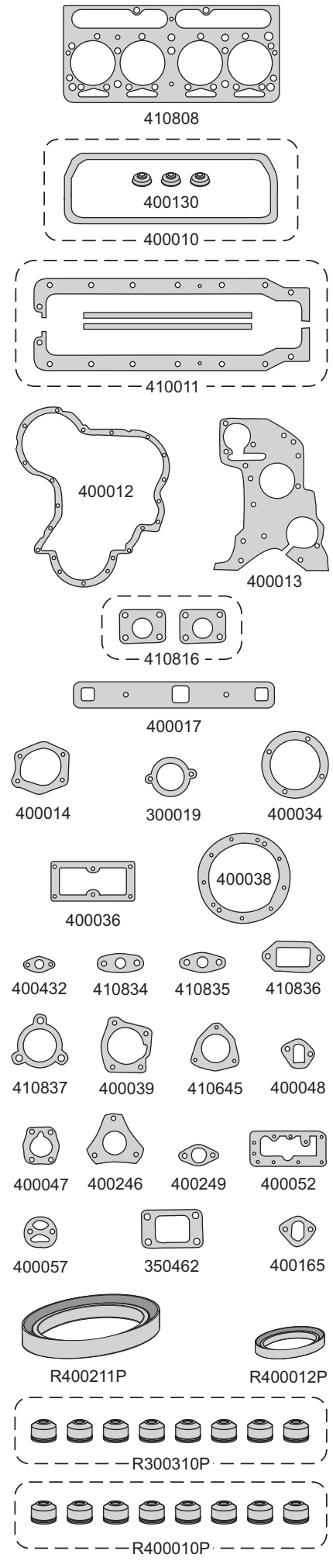

PERKINS



Motor/Engine	Cm³	HP	Ø
6-357 Vehicular	5840	120	104.1
6-357 Agrícola	5840	91	104.1
6-357 Industrial	5840	108	104.1

Chevrolet: Brasil D60 - D70
Dodge: P700D - P900
Ford: F600/750/1100 - F6000/7500/110000
Massey F: MF3366



DIESEL

Nº OE	Descripción/Description	Mat.	Ref.
635752/704	Jgo. de juntas para motor		410900-R
	Jgo. de juntas superior		410995
70490058	Junta tapa cilindros Ø 107.0 ±1.50	NFT 1 1	410907
70490139	Junta tapa válvulas	CG 1 1	410910
70490132	Junta para cárter	CG	410911
70490132	Junta cárter versión agrícola	NB 1	420011
70490092	Tapa distribución	NB 1	410912
70490065	Inspección distribución	CG 2	410913
70490050	Tapa bomba de agua	NB 1	410914
0490675	Jgo. múltiple escape (3)	NFT 1 1	410916
70490087	Múltiple admisión	NB 1 1	410917
	Salida de escape	NB 1 1	400218
70490020	Tubo salida de escape	NFT 1 1	410918
70490071	Conexión salida agua	NB 1 1	410919
70490112	Placa adaptadora bomba alimentación	NB 1	410928
70490024	Accionamiento taquímetro	NB 1	410929
704900833	Adaptador distribución	NB 1	410630
70490136	Placa adaptadora bomba	NB 1	410930
70490135	Bomba alimentación a block	NB 2	410931
70490143	Filtro aceite	NB 2	410932
70490049	Succión bomba aceite	NB 2	410933
70490091	Succión bomba aceite	NB 1	410934
0490263	Porta retén trasero	NB 1	410936
70490101	Cámara de agua	NB 2	410937
0490300	Cámara de agua tapa cilindros	NB 1 1	410938
0490676	Carcasa termostato	NB 1 1	410939
0490307	Entrada admisión	NB 1 1	410941
70490093	Conexión superior salida agua	NB 1 1	410942
0490736	Entrada agua a block	NB 1	410943
0490288	Placa a block	NB 1	410944
049025	Tubo succión a block	NB 1	410945
70490100	Acople bomba inyectora	NB 1	410546
0490433	Tubo salida escape	NFT 1 1	410946
	Jgo. empaquetadura a cigüeñal (2)	SLA 1	400158
70730006	Jgo. empaquetadura a cigüeñal	SNA	410958
	Arandela A 10 x 16 x 1 C	CU 6	
0921176	Arandela A 8 x 12 x 1 A	AL 7	
	Arandela A 8 x 12 x 1 C	CU 6	
0920113	Arandela A 14 x 20 x 1.5 C	CU 14	
	Arandela A 14 x 20 x 1 C	CU	
	Arandela A 10 x 16 x 1 A	AL 8	
	Arandela A 40 x 47 x 1 C	CU	
	Jgo. retén válvulas (12)	N 1	R410910N
	Retén distribución 50.9 x 69.8 x 9.5	N 1	R410912N

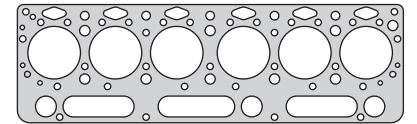

410907

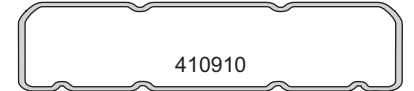

410910

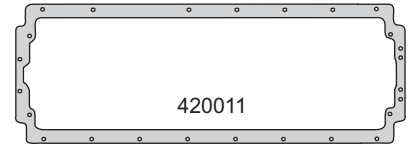

420011

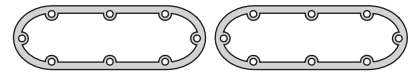

410911

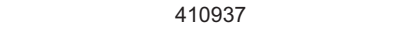

420011



410912

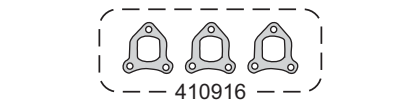

410913

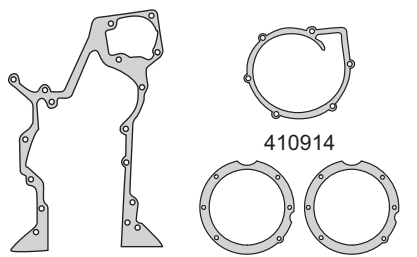

410914



410912

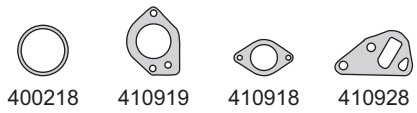

410913



400218

410919

410918

410928

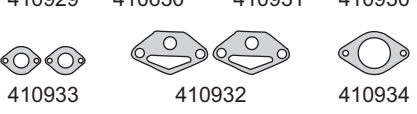

410929

410630

410931

410930



410933

410932

410934

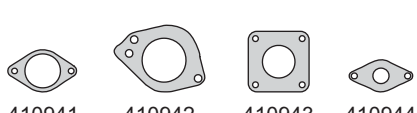

410936

410938

410939

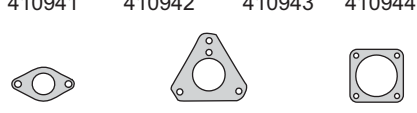

410941

410942

410943

410944



410945

410546

410946

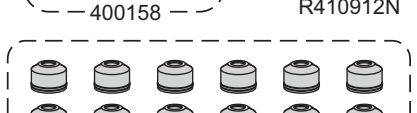

400158

R410912N

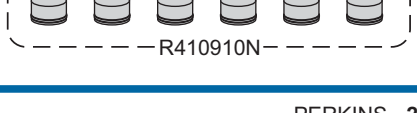

R410910N

PERKINS



Motor/Engine	Cm³	HP	Ø
6-357 Vehicular	5840	120	104.1
6-357 Agrícola	5840	91	104.1
6-357 Industrial	5840	108	104.1

Ford: F400/600/7000/11000/12000/13000
M. Ferguson: MF 400C



DIESEL

Nº OE	Descripción/Description	Mat.	Ref.
635801/802	Jgo. de juntas para motor		420000-R
	Jgo. de juntas superior		420095
3681601	Junta tapa cilindros Ø 109.0 ±1.50	NFT	1 1 420007
70490096	Junta tapa válvulas	CG	1 1 420010
	Junta para cárter versión agrícola	NB	1 1 420011
70490132	Junta para cárter	CG	1 1 410911
70490097	Tapa distribución	NB	1 1 420012
70490065	Inspección distribución	CG	2 2 410913
70490050	Tapa bomba de agua	NB	1 1 410914
	Jgo. múltiple escape (3)	NFT	1 1 420016
70490024	Accionamiento taquímetro	NB	1 1 410929
70490136	Placa adaptador bomba a block	NB	1 1 410930
	Adaptador	NB	1 1 410630
70490129	Bomba adaptador a block	NB	2 2 410931
70490143	Filtro aceite a block	NB	1 1 410932
70490049	Succión bomba aceite	NB	2 2 410933
70490091	Succión bomba aceite	NB	1 1 410934
70490128	Porta retén trasero	NB	1 1 420036
70490069	Respirador adaptador	NB	1 1 420037
70490116	Tapa carcasa termostato	NB	1 1 420038
70490083	Adaptador inspección a distribución	NB	1 1 420039
70490119	Conexión superior a carcasa	NB	1 1 420041
0490307	Colector admision filtro aire	NB	1 1 410941
7049114	Tapa trasera a tapa cilindros	NB	1 1 420042
7049118	Colector admisión central	NB	2 2 420043
0490736	Entrada agua a block	NB	1 1 410943
70490117	Colector	NB	2 2 420044
0490288	Placa a block	NB	1 1 410944
70490115	Lateral bomba de agua	NB	2 2 420045
0490275	Tubo a block	NB	1 1 410945
70490026	Tapa comando taquímetro	NB	1 1 420046
70490100	Acople bomba inyectora	NB	1 1 410546
0490433	Tubo salida de escape	NFT	1 1 410946
	Tubo acople	NFT	1 1 420047
	Arandela A 10 x 21 x 2 C	CU	6
	Arandela pico inyector A 10 x 20 x 2 C	CU	6
	Arandela A 14 x 20 x 1.5 C	CU	6
	Arandela A 41.3 x 45 x 1 C	CU	6
	Kit de retenes completo		R420000
	Jgo. retén válvulas (12)	P	1 1 R540210P
	Retén bancada 133.35 x 158.75 x 11/13	P	1 R400211P
	Retén distribución 60.32 x 79.36 x 9.5	P	1 R400012P

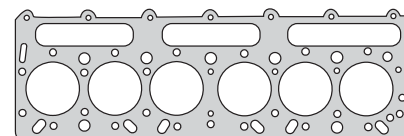

420007

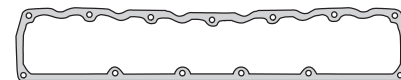

420010

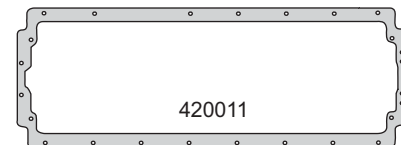

420011

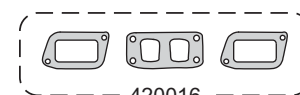

420012

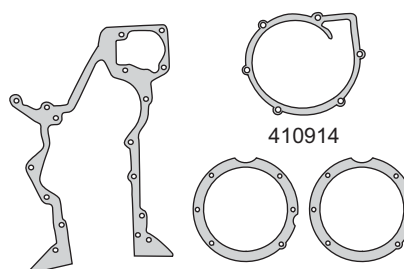

410914

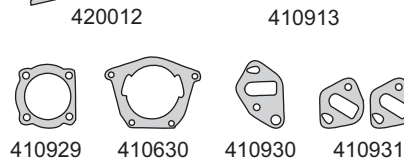

420016

410913

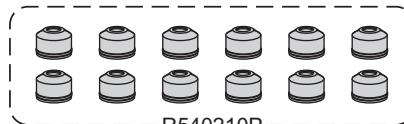
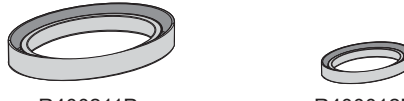
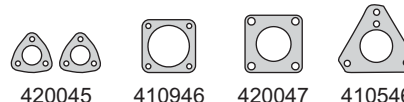
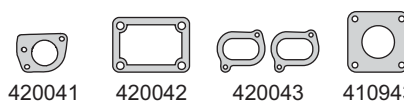
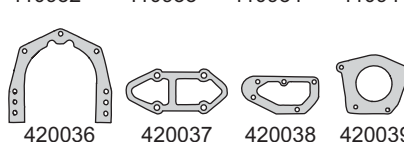
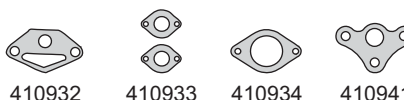

PERKINS



Motor/Engine	Cm³	HP	Ø
4.203 - 8 BR	3336	71	91.49

Perkins: Tractor 8 BR



DIESEL

Nº OE	Descripción/Description	Mat.	Ref.
420302/420310	Jgo. de juntas para motor		420100-R
	Junta tapa cilindros Ø 92.5 ± 1.40	NFT 1	400005
36812125	Junta tapa cilindros Ø 92.5 ± 1.40	NFT	400007
36812125	Junta tapa cilindros Ø 92.5 ± 1.15	CNC	400008
	Jgo. tornillos tapa cilindros (HAS19038)		B400000
0490704	Conj. junta tapa válvulas (4)	CG 1	400010
0999725	Jgo. junta para cárter (4)	NB 1	420111
36814112	Tapa distribución	NB 1	400012
38866615	Block caja distribución	NB 1	400013
006002	Bomba agua placa trasera	NB 1	410514
00490042	Múltiple escape	FCH 2	400015
80490032	Múltiple admisión	NFT 1	400017
	Salida de escape	FCH	400018
0920113	Salida de escape	NFT 1	410518
	Arandela tapa válvulas (3)	GS 3	400130
70190014	Tapa inferior cárter	NB 1	420133
066081	Tapa frontal a tapa inspección	NB 1	400034
0490485	Tapa trasera cigüeñal	NB 1	400035
36846409	Tapa trasera tapa cilindro	NB 1	400036
36864114	Inspección trasera	CG 1	420136
	Inspección delantera	CG 1	420137
70490109	Bomba aceite hidráulico	NB 1	420138
36866416	Salida de escape	NFT 1	410538
70490063	Caja distribución bomba vacío	NB 1	400039
	Caja distribución adaptador	NB 1	420139
006007	Cubierta cigüeñal	NB 1	410539
0490699	Comando bomba combustible	NB 1	400146
0490692	Tapa trasera árbol levas	NB 1	400047
36835411	Conexión entrada agua	NB 1	400048
	Desvío agua	NB 1	410549
0490701	Conexión salida agua	NB 1	400051
36817141	Salida agua a tapa	NB 1	400052
70730006	Filtro aceite a block	NB 1	400057
	Jgo. empaquetadura bancada cigüeñal (2)	SLA 1	400158
36866414	Jgo. empaquetadura bancada cigüeñal (2)	SNA	410958
36862152	Bomba vacío tapa brida	NB 1	400062
36865543	Bomba alimentación combustible	NB 1	400165
	Soporte bomba inyectora	NB 1	400066
0490702	Arandela A 40 x 47 x 0.85 C	CU 4	
33825409	Arandela base inyector A 14 x 20 x 1.5 C	CU 4	
	Arandela A 10 x 21 x 2 C	CU 4	
	O´ring G 21.82 x 3.53	GS 1	
	Kit de retenes completo		R420100
	Jgo. retén válvulas (8)	P 1	R410510P
	Retén distribución 57.30 x 76.20 x 12.70	N 1	R420112N
	Retén auxiliar 22.22 x 34.92 x 6.35	N 1	R400213N

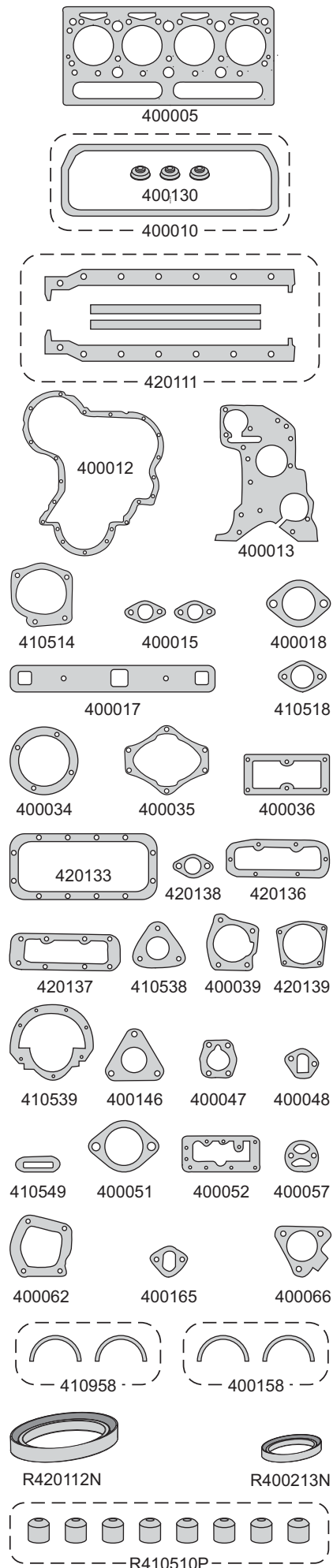

PERKINS



Motor/Engine	Cm³	HP	Ø
4.236	3860	70	98.4
4.248	4070	100	100
(OHV) 8V			

Perkins: Case 580H



DIESEL

Nº OE	Descripción/Description	Mat.	Ref.
	Jgo. de juntas para motor		420200-R
	Junta tapa cilindros Ø 104.0 ±1.70	NFT	410605
36812338	Junta tapa cilindros Ø 104.0 ±1.70	NFT	410607
70490149	Junta tapa válvulas	CG	410610
36815706	Junta para cárter	NB	410611
	Tapa distribución	NB	420212
36814127	Placa distribución	NB	410613
	Cuerpo bomba de agua	NB	420214
36866724	Tapa bomba de agua trasera	NB	410614
36886007	Jgo. múltiple escape (2)	NFT	280316
	Jgo. múltiple admisión (3)	NFT	280317
0490301	Salida de escape	FCH	400218
	Conexión entrada de agua	NB	420219
	Base bomba nafta	NB	550628
C7NN-6659-A	Bomba aceite a block	NB	330030
70490146	Bomba de agua	NB	410731
36853514	Cuerpo salida de agua	NB	410632
0921173	Arandela inyector A 10 x 20 x 1.5 A	AL	410533
36851409	Tapa trasera tapa de cilindros	NB	410633
	Placa al block	NB	420234
36862517	Filtro de aceite	NB	410634
70490091	Succión bomba aceite	NB	410934
36834143	Bomba inyectora	NB	400435
0490734	Carcasa termostato	NB	410635
36817157	Porta retén trasero	NB	400236
	Filtro aceite lubricante	NB	420236
36862151	Conexión superior salida de agua	NB	410637
36865511	Caja distribución bomba vacío	NB	400039
7049145	Cuerpo delantero y trasero bomba de agua	NB	410640
36835425	Carcasa a conexión superior	CG	410641
	Turbina - entrada aceite	NB	420241
36851113	Bomba alimentación a block	NB	410642
	Block tomada de potencia	NB	420242
36832122	Tubo succión bomba de aceite	NB	410643
36832404	Succión bomba de aceite	NB	410743
	Filtro aceite lubricante	NB	420243
32811113	Basón tapa interior a block	GS	400442
0490355	Tubo succión a válvula alimentación	NB	410644
36862138	Boca lubricación	NB	410744
36825107	Inspección engranaje comando auxiliar	NB	400244
	Tapa tomada de fuerza	NB	420244
36822111	Múltiple de escape	NFT	410645
	Block balanceador dinámico	NB	420245
0490773	Comando bomba inyectora	NB	400146
70490100	Acoplamiento bomba inyectora	NB	410546
32811408	Anillo lubricación tapa cilindros G 6 x 10 x 5.2	GS	410646
	Adaptador vacío	NB	410747
	O´ring G 21 x 35 x 13	GS	4
	O´ring G 7.2 x 11 x 6	GS	1
	Arandela A 10 x 20 x 20 C	CU	4
	Jgo. retén válvulas (8)	P	R300310P
	Retén bancada 133.35 x 158.75 x 11/13	P	R400211P
	Retén distribución 60.32 x 79.36 x 9.5	P	R400012P

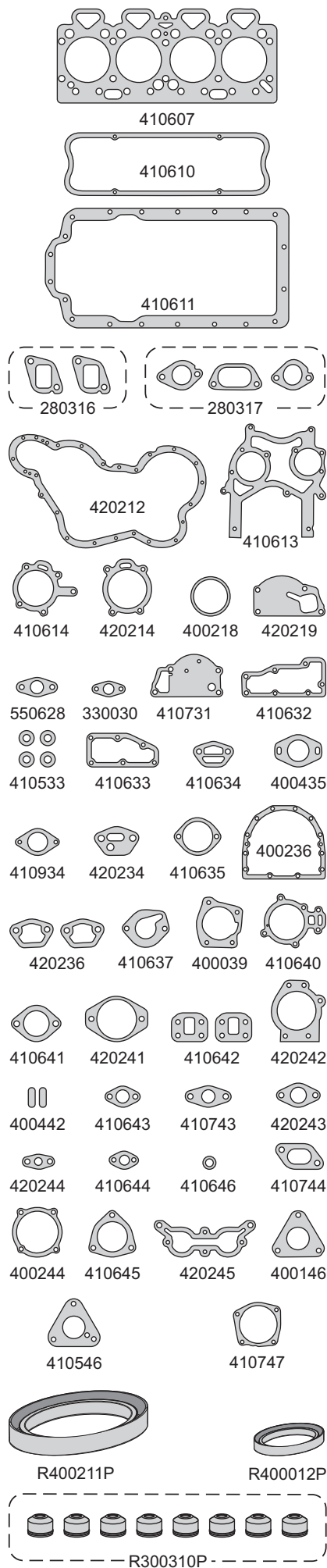

PERKINS



Motor/Engine	Cm³	HP	Ø
3.152	2360	42	89
3.152 (OHV) 6V	2502	42	91.44

Massey Ferguson: 50/50X/55X/135/200/235/250
MF 135/515



DIESEL

Nº OE	Descripción/Description	Mat.	Ref.
315202/315205	Jgo. de juntas para motor		420400-R
36812122	Junta tapa cilindros Ø 93.0 ± 1.45	NFT	400507
368112122	Junta tapa cilindros Ø 93.0 ± 1.45	FCH	400508
	Jgo. tornillos tapa cilindros (HAS19038)		B400000
0490491	Conj. junta tapa válvulas (3)	CG	400510
003249	Jgo. junta para cárter (3)	NB	400511
36813136	Tapa distribución	NB	420412
36814119	Placa distribución	NB	400513
0490484	Bomba agua a placa	NB	420414
0490481	Múltiple escape (2)	FCH	400015
0490184	Salida de agua	NB	200025
	Arandela tapa válvulas	GS	400130
0490251	Tapa filtro aceite	NB	420433
36837408	Tapa bomba hidráulica	NB	420434
0490482	Cuerpo salida agua	NB	400534
006081	Tapa trasera cigüeñal	NB	400035
70490034	Tapa trasera	NB	420435
0490485	Tapa trasera tapa cilindros	NB	400036
0490738	Cuerpo salida agua tapa cilindros	NB	400536
36862511	Tapa trasera árbol levas	NB	400537
70490014	Salida de escape	NFT	410538
0490486	Tapa conexión entrada aire	NB	400539
36862512	Tapa inspección carga aceite	NB	400540
36862165	Bomba alimentación	NB	400541
0490685	Comando bomba combustible	NB	400146
006047	Filtro aceite a block	NB	400057
70730006	Jgo. empaquetadura cigüeñal (2)	SNA	400158
	Arandela A 10 x 21 x 2 C	CU	
	Arandela A 14 x 20 x 1.5 C	CU	
	Arandela A 40 x 47 x 0.85 C	CU	
	O'ring G 44.17 x 1.78	GS	
	Kit de retenes completo		R420400
	Jgo. retén válvulas (6)	P	R420410P
	Retén distribución 57.30 x 76.2 x 12.70	N	R420112N
	Retén árbol levas 22.2 x 34.92 x 6.35	N	R400213N

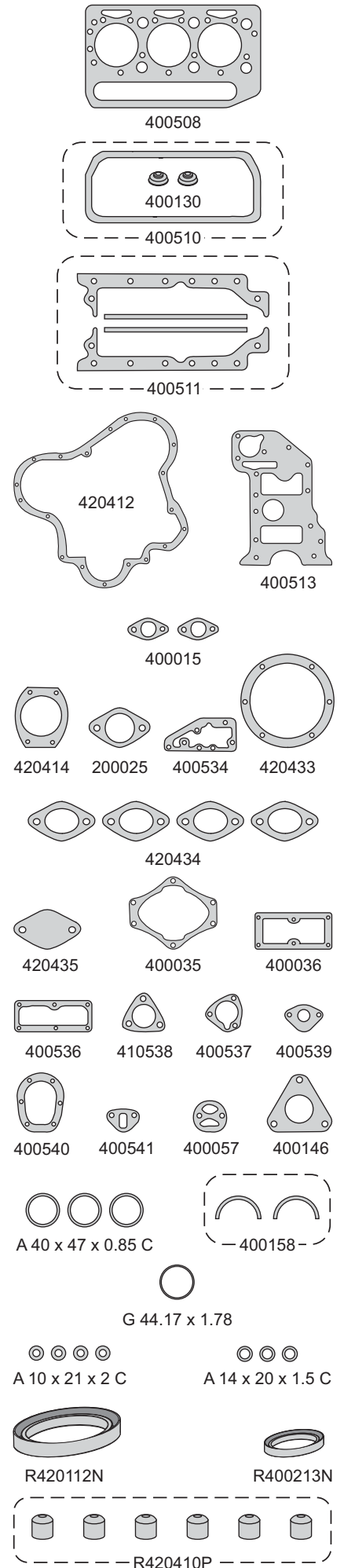

PERKINS



Motor/Engine	Cm³	HP	Ø
Prima 65/80T Leyland Prima 65 Daf TN 44	1994	64/80	84.45

Perkins: Rover - Maestro D/TD
Perkins - Marino 4.20 D/TD
Leyland Sherpa 185/200/215/220/230
240/255 1986/94
Daf Ka 200/ VS 200 1986/...

DIESEL



Nº OE	Descripción/Description	Mat.	Ref.
	Jgo. de juntas para motor		420600-R
L681EF06	Junta tapa cilindros Ø 86.0 ±1.50	NFT	1 420607
	Jgo. tornillos tapa cilindros		B420600
L681KF03	Junta para cárter	NB	1 420611
L687YF02	Frente motor para bomba aceite a block	NB	1 420612
L681VF02	Múltiple admisión y escape	NFT	1 420615
006155	Salida de escape	AC	1 420618
L683NF02	Retorno agua termostato	NB	1 420619
L687MF03	Conexión salida agua	NB	1 420621
L687MF13	Cuerpo salida agua a tapa de cilindros	NB	2 420622
L687MF05	Codo a múltiple admisión	NB	1 420623
006165	Caja drenaje aceite	NB	2 420624
L683NF02	Junta conexión salida agua	NB	2 420626
L683HF01	Junta carga aceite a block	NB	1 420627
L687MF14	Bomba aceite a cabezal	NB	1 420636
006167	Placa adaptador a block trasero	NB	1 420637
L683HF05	Tubo carga aceite a block	NB	1 420638
L688CF01	Turbo a salida escape	NFT	2 420639
	Entre múltiple turbo	AC	1 500546
36862126	Bomba combustible	NB	400165
	Arandela A 6.5 x 10 x 1 C	CU	8
	Arandela A 8 x 11 x 1 A	AL	8
	Arandela A 8 x 14 x 1.5 C	CU	4
	Arandela A 20 x 26 x 1 A	AL	2
	Arandela A 14 x 20 x 1.5 C	CU	1
	Arandela A 20 x 25 x 2 A	AL	1
	Arandela A 14 x 18 x 1.5 A	AL	1
	O´ring G 47.29 x 2.62	GS	1
	O´ring G 20 x 2	GS	1
	Kit de retenes completo		R420600
	Jgo. retén válvulas (8)	P	1 R420610P
	Retén bancada 88. 9 x 105 x 9.5	P	1 R420611P
	Retén distribución 35 x 45 x 7	P	1 R420612P
	Retén árbol de levas trasero 40 x 52 x 7	P	1 R420613P
	Retén árbol de levas trasero 45 x 60 x 7	P	1 R420614P

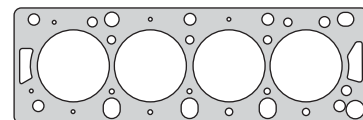

420607

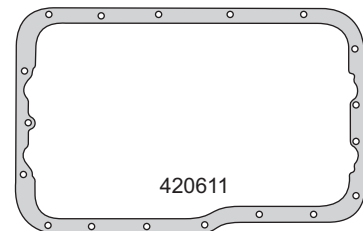

420611



420615

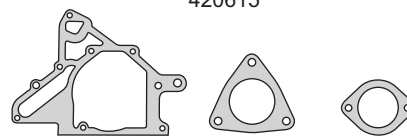

420612

420618

420619



420621

420622

420623



420624

420626



420627

420636

500546

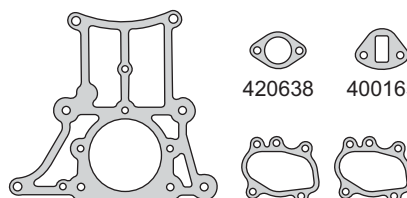

420637

420638

400165



420639



A 14 x 20 x 1.5 C

A 20 x 26 x 1 A

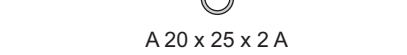

A 20 x 25 x 2 A



A 6.5 x 10 x 1 C

A 8 x 11 x 1 A



G 47.29 x 2.62

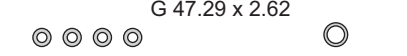

A 8 x 14 x 1.5 C

A 14 x 18 x 1.5 A



R420611P

R420614P

R420612P

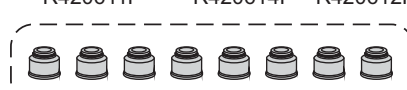

-R420610P-

PERKINS



Motor/Engine	Cm³	HP	Ø
D3.152-D3.152/2 G3.152-D3.152/4 (OHV) 8V	2500	48	91.40

Perkins: MF133/135/148/230/235/240/254/353
Industrial MF40 - Agrícola/Marino

DIESEL



Nº OE	Descripción/Description	Mat.	Ref.
	Jgo. de juntas para motor		● 422000-R
	Junta tapa cilindros Ø 93.0 ± 1.40	NFT	1 420205
	Junta tapa válvulas	CG	1 422010
	Jgo. junta para cárter (4)	NB	1 422011
	Tapa distribución	NB	1 420412
	Placa distribución	NB	1 400513
	Bomba de agua	NB	1 420414
	Jgo. múltiple escape (3)	AC	1 400416
	Múltiple admisión	NB	1 422017
	Salida de agua	NB	1 200025
	Tapa filtro aceite		422033
	Cuerpo salida de agua	NB	1 400534
	Tapa trasera cigüeñal	NB	1 400035
	Tapa trasera a block	NB	1 422035
	Tapa trasera tapa cilindros	NB	1 400036
	Porta retén bancada trasero	NB	1 400038
	Tapa conexión entrada de aire	NB	1 400539
	Tapa inspección delantera	NB	1 400540
	Bomba alimentación	NB	1 400541
	Comando bomba combustible	NB	1 400146
	Filtro aceite a block	NB	1 400057
	Jgo. empaquetadura cigüeñal (2)	SLA	1 400158
	Arandela inyector A 10 x 20 x 2 C	CU	3
	Kit de retenes completo		R422000
	Jgo. retén válvulas (8)	P	1 R300310P
	Jgo. retén válvulas (8)	P	1 R400010P
	Retén bancada 133.35 x 158.75 x 11/13	P	1 R400211P
	Retén distribución 57.3 x 76.2 x 12.70	N	1 R420112N

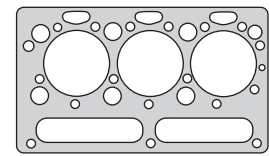

420205



422010

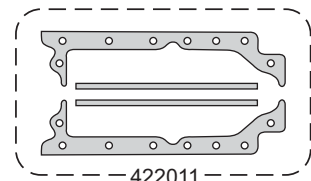

422011

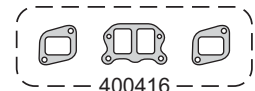

400416

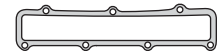

422017

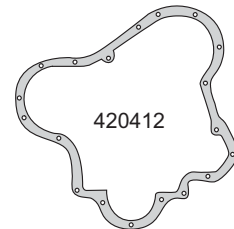

420412

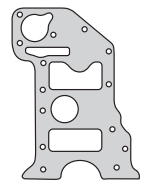

400513



420414



200025

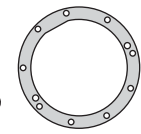

400038



422035



400534

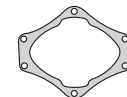

400035

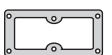

400036



400539



400541



400057



400540



A 10 x 20 x 2 C

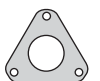

400146



400158



R400211P



R420112N



R300310P



R400010P



taranto

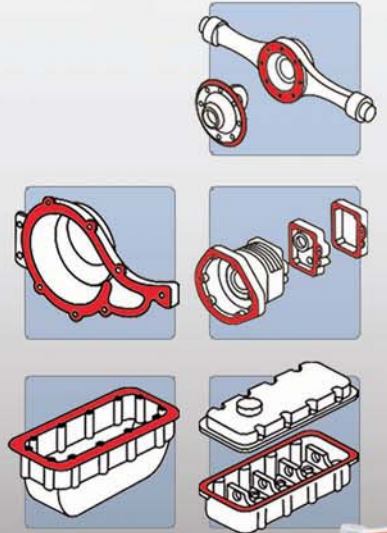

**HIGH
TEMP
350°C**

Sellador Líquido a base de Caucho de Silicona

Aprobado para motores equipados con sensor de oxígeno.

- Sellador libre de solvente, adhesivo y cubritivo compuesto a base de caucho de silicona, ha sido especialmente creado para aplicaciones de gran fuerza de torsión.
- Excelente resistencia al aceite a los combustibles, aceites, lubricantes, anticongelantes y gases.
- Resiste golpes y vibraciones.
- Es siempre flexible y se mantiene a una temperatura de entre -62°C a +350°C intermitente.

No recomendado para sellar tapas de cilindros.



SCANIA



Motor/Engine	Cm³	HP	Ø
D11 - DS11 (OHV) 12V	11020	280/333	127
DIESEL			

Scania: Camión - Omnibus L75- 76
L, LB, LBS 110, L111, LB111, LS111
LT111, LBS111, LBT111 1974/...

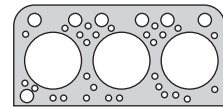

810007

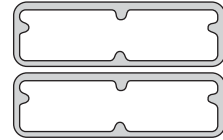
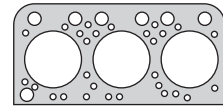

810010

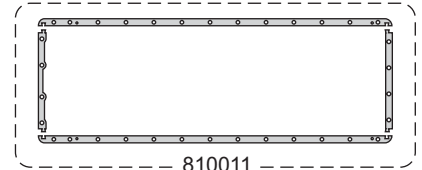

810011



810036



810039



810015

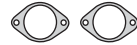

810017

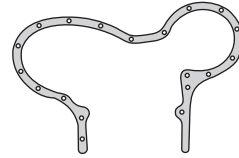

810012

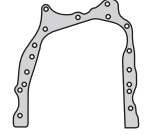

810013

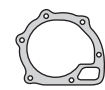

810014



810018

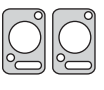

810019



810029



810030

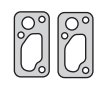

810031

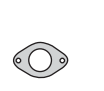

810032



810033

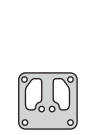

810034



810035



810037

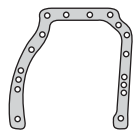

810038



810012N



810111V



810115V

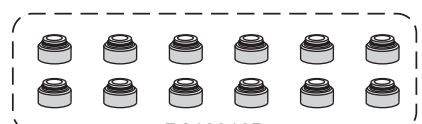

810010P

Nº OE	Descripción/Description	Mat.	Ref.
	Jgo. de juntas para motor		810000-R
	Jgo. de juntas superior		810095
161870	Jta. tapa cilindros Ø 144.0 \pm 1.40	NFT	2 2 810007
161870	Jta. tapa cilindros Ø 144.0 \pm 1.80	FCH	2 2 810008
258459	Junta tapa válvulas superior	CG	2 2 810010
131144	Jgo. junta para cárter (4)	NH	1 1 810011
287553	Tapa distribución	NB	1 1 810012
287554	Placa distribución	NB	1 1 810013
231795	Tapa bomba de agua	NB	1 1 810014
	Jgo. múltiple escape (4)	GFT	1 1 810015
139108	Múltiple admisión	CB	2 2 810017
152667	Salida de escape	NFT	1 1 810018
139044	Base termostato	CB	2 2 810019
139274	Tapa inspección distribución	CB	1 1 810029
131305	Soporte dínamo	NB	1 1 810030
291826	Salida termostato	CB	2 2 810031
35309	Tapa inspección botadores	CB	1 1 810032
35161	Cañería bomba agua	NB	1 1 810033
278602	Unión múltiple cara agua	NB	1 1 810034
	Retén cigüeñal	FIE	1 1 810035
181333	Tapa válvulas lateral	NB	2 2 810036
302226	Tapa inspección distribución	CB	1 1 810037
287555	Carcaza volante	NB	1 1 810038
277632	Tapa colector admisión	NFT	2 2 810039
	Kit de retenes completo		R810000
	Jgo. retén válvulas (12)	P	1 1 R810010P
	Retén bancada 130 x 160 x 15	V	1 1 R810111V
	Retén distribución 80 x 100 x 12	V	1 1 R810115V
	Retén auxiliar 35 x 62 x 7	N	1 1 R810012N

SCANIA



Motor/Engine	Cm³	HP	Ø
D11/DS11/DSC11 DN11/DTC11 (OHV) 12V	11020	272/354	127
DIESEL			

Scania: LB110, LBS110, L111, LS111
LT111, LBS111, LBT111, G112, L112
R112, T112, P113, P113HK, R113
R113HK, T113, K113CBL
K113GLP, K113TLB
K113TLP 1975/...



Nº OE	Descripción/Description	Mat.	Ref.
	Jgo. de juntas para motor		810100-R
	Jgo. de juntas para motor		810101-R
	Jgo. de juntas superior		810195
346143	Jta. tapa cilindros Ø 147.0 ± 1.25	ACG	2 810108
258459	Junta tapa válvulas superior	CG	2 2 810010
215242	Jgo. junta para cárter (4)	NH	1 810011
287553	Tapa distribución	NB	1 810012
1388680	Tapa distribución 112/113	NB	1 810312
287554	Placa de distribución	NB	1 810013
231795	Bomba de agua	NB	1 810014
	Jgo. múltiple escape (4)	GFT	1 1 810015
1384554/5	Jgo. múltiple escape (4)	GFT	1 1 810316
	Múltiple admisión	NFT	1 1 810117
1301628/29	Jgo. múltiple admisión (6) - 113	NFT	1 1 810317
	Salida de escape	NFT	1 1 810218
283148	Termostato	NB	1 810119
	Tapa termostato 112/113	NB	1 810219
	Bomba de agua	CB	1 810319
225835	Bomba de aceite	NB	1 810227
139274	Tapa inspección distribución	CB	1 810029
291826	Salida termostato	CB	2 2 810031
	Tapa termostato	NB	2 810231
35309	Tapa inspección botadores	CB	1 810032
	Anillo G 46 x 34 x 2	GS	1 810232
35161	Cañería bomba de agua	NB	1 810033
	Anillo G 42 x 57 x 3	GS	2 810233
278602	Unión múltiple a cámara agua	NB	1 1 810034
	Anillo G 29.5 x 17.5	GS	810234
181383	Junta tapa válvulas lateral	NB	2 810036
302226	Tapa inspección distribución	CB	1 810037
163142	Tapa inspección distribución	CB	1 810137
170765	Base filtro aceite	NB	1 810237
287555	Carcaza volante	NB	1 810038
238403	Soporte filtro aceite	NB	1 810238
277632	Tapa colector admisión	NFT	2 2 810039
232961	Soporte enfriador aceite	NB	1 810239
139123	Soporte balancines	CB	12 12 810140
	Jgo. juntas compresor KH2 Bus	VS	810240
384464	Entre múltiples	NFT	1 1 810243
	Brida	NB	1 810144
	Múltiple admisión	NFT	1 1 810244
	Retorno aceite a block	NB	1 810245
	Arandela tapón cárter	AL	810246
	Retén bomba aceite a block	NB	1 810247
	Jgo. juntas caja velocidades	VS	810150
	Jgo. juntas caja velocidades K112 Bus	VS	810250
	Jgo. juntas caja velocidades 113/114/124	VS	810350
	Jgo. juntas caja velocidades 113/114/124	VS	810351
	Jgo. juntas caja veloc. K113 Bus - P93/94	VS	810352
	Tapa diferencial 111/112	AL	810159
	Turbina turbocompresor	AC	1 1 810162
	Varilla medición aceite	NB	1 810262
	Turbina turbo	AC	1 1 810362

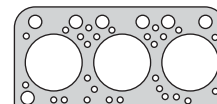

810108

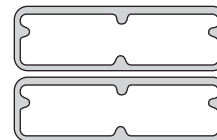
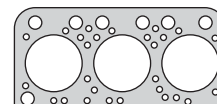

810010

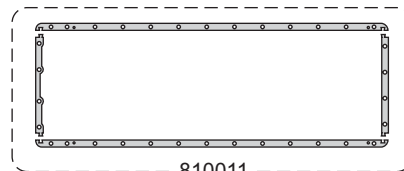

810011



810036



810039

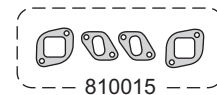

810015

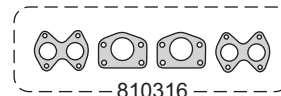

810316

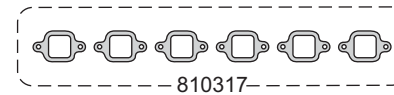

810317

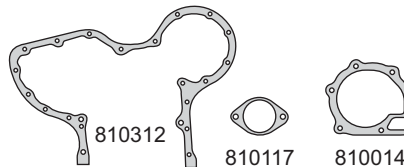

810312

810117

810014

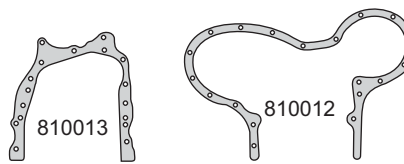

810013

810012

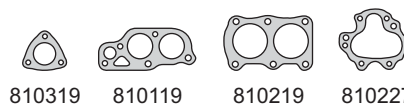

810319

810119

810219

810227

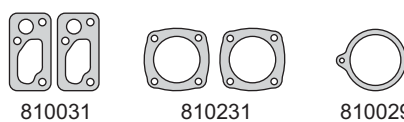

810031

810231

810029

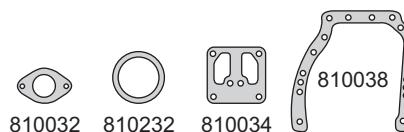

810032

810232

810034

810038

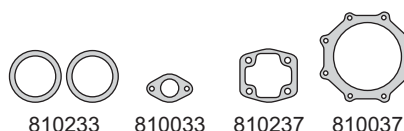

810233

810033

810237

810037

SCANIA



Motor/Engine	Cm³	HP	Ø
D11/DS11/DSC11 DN11/DTC11 (OHV) 12V	11020	272/354	127
DIESEL			

Scania: LB110, LBS110, L111, LS111
 LT111, LBS111, LBT111, G112, L112
 R112, T112, P113, P113HK, R113
 R113HK, T113, K113CBL
 K113GLP, K113TLB
 K113TLP 1975/...



Nº OE	Descripción/Description	Mat.	Ref.
	Base turbocompresor	AC 1 1	810163
	Base turbo	AC 1 1	810363
	Retorno turbo	NB 1 1	810364
	Entrada aceite a turbo	NB 1 1	810365
	Salida aceite a turbo	NB 1 1	810366
	Entrada turbo 112/113 1991/...	NB 1 1	810367
	O'ring G 10 x 2.5	GS 2	
	O'ring G 29.2 x 3	GS 2	
	O'ring G 126.67 x 2.62	GS 2	
	O'ring G 12.37 x 2.62	GS 2	
	O'ring G 122 x 5	GS 1	
	O'ring G 16 x 2.5	GS 4	
	O'ring G 19.25 x 2.9	GS 2	
	O'ring G 23.47 x 2.62	GS 1	
	O'ring G 26.2 x 3	GS 2	
	O'ring G 22.2 x 3.5	GS 1	
	O'ring G 20 x 4	GS 1	
	O'ring G 53.5 x 3	GS 1	
	O'ring G 45 x 3	GS 1	
	O'ring G 72.69 x 2.62	GS 4	
	O'ring G 102.5 x 94.5	GS 1	
	O'ring G 107.54 x 3.53	GS 1	
	O'ring G 110.72 x 3.53	GS 1	
	O'ring G 17.5 x 6	GS 4	
	Arandela A 10 x 14 x 1.5 A	AL 10 10	
	Arandela A 8 x 11 x 1 C	CU 20 20	
	Arandela A 14 x 20 x 1.5 A	CU 20 20	
	Arandela A 10 x 19 x 2 C	CU 6 6	
	Arandela A 24 x 38 x 1.25 A	AL 1	
	Kit de retenes completo		R810000
	Jgo. retén válvulas (12)	P 1	R810010P
	Retén bancada 130 x 160 x 15	V 1	R810111V
	Retén auxiliar 35 x 62 x 7	N 1	R810012N
	Retén distribución 80 x 100 x 12	V 1	R810115V

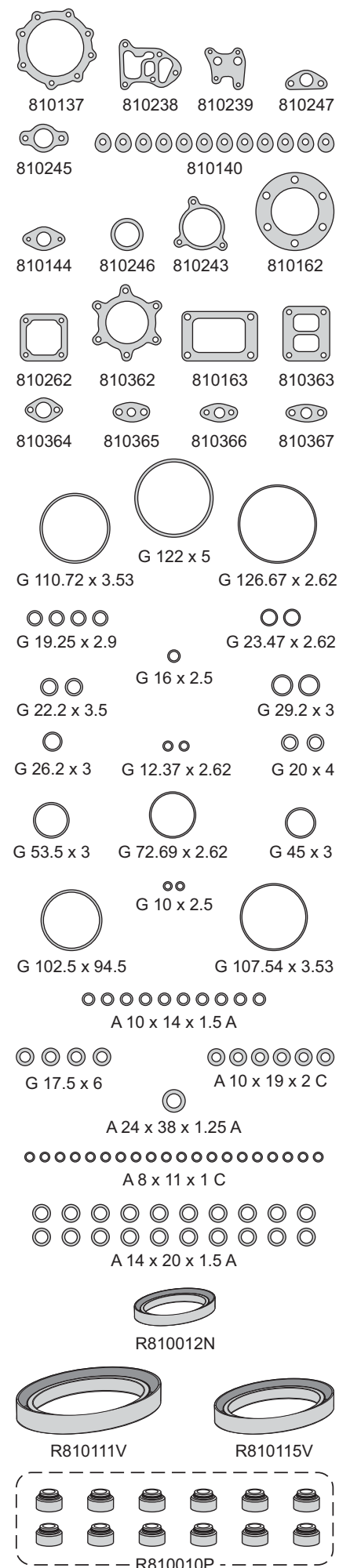

SCANIA



Motor/Engine	Cm³	HP	Ø
DS14	14190	400/500	127
DSC14	14190	400/500	127
(OHV) V6 16V			

Scania: LK-140, LK-141, LK-142 1980/96



DIESEL

Nº OE	Descripción/Description	Mat.	Ref.
	Jgo. de juntas para motor		810200-R
	Jgo. de juntas superior (1 cilindro)	●	810295
1.313.459	Junta tapa cilin. Ø 147.0 ± 0.60	MLS	1 8 810208
170.610	Junta tapa válvulas superior	GS	1 8 810236
170.700	Jgo. junta para carter (4)	NB	1 810211
170.706	Tapa distribución	NB	1 810212
170.686	Tapa bomba de agua	NB	1 810214
277.607	Jgo. múltiple escape (8)	NFT	1 1 810215
	Jgo. múltiple admisión (8)	NB	1 1 810217
170.932	Salida de escape	GFT	2 810218
170.907	Salida de escape a turbo	GFT	1 810218-1
170.206	Válvula termostato	NB	2 810219
170.687	Soporte bomba de agua	NB	1 810229
170.738	Carcasa bomba de agua	NB	1 810230
170.675	Junta cojinetes balancines	NB	1 16 810231
170.702	Tapa Lateral	NB	1 810232
170.705	Carcasa lado volante	NB	1 810233
170.668	Soporte bomba de agua	NB	1 810234
170.966	Tapa de agua a block	NB	1 810235
170.694	Tapa lateral cilindros	NB	2 810237
170.368	Junta tubo de agua	NB	1 8 810239
170.372	Tapa trasera distribución	NB	1 810240
259.718	Junta	NB	1 1 810241
170.627	Tapa lateral cilindros	NB	1 8 810243
170.696	Tapa superior delantero/trasero block	NB	4 810244
170.366	Tubo admisión izquierdo	NB	1 810245
287.559	Tubo admisión	NB	1 810246
170.916	Tapa carcasa distribución	NB	1 810247
170.937	Entrada aceite	NB	1 810248
170.804	Junta	AC	1 810249
170.411	Trava volante	NB	3 810261
170.410	Trava tornillo volante	AC	1 810262
	Trava	AC	2 810263
170.233	Trava eje bomba inyeccion	AC	1 810264
	Trava arandela	AC	1 810265
	Arandela trava A 28.3 x 45.5 x 1 A	AC	1
	Arandelas pico inyector A 9.6 x 19.9 x 2 C	CU	8
	Arandelas A 21 x 28.5 x 1 C	CU	4
	Arandelas A 16.5 x 23.9 x 0.95 C	CU	2
	Arandelas A 10.3 x 13.8 x 0.55 C	CU	1
	Arandelas A 37 x 41.5 x 1 A	AL	1
	Arandelas A 27.3 x 34.8 x 3 A	AL	4
	Arandelas A 17 x 22 x 1 A	AL	2
	Arandelas A 14.3 x 17.9 x 1.5 A	AL	22
	Arandelas A 12.5 x 16 x 1 A	AL	4
	Arandelas A 10 x 15 x 1 A	AL	7
	Arandelas A 8.3 x 11.9 x 1 A	AL	27
	Anillo G 59 x 67 x 3	GS	2
	O ring G 18.77 x 1.78	GS	8
	O ring G 20 x 4	GS	1
	O ring G 21.8 x 3.5	GS	1
	O ring G 24 x 2.8	GS	1
	O ring G 27 x 3	GS	1

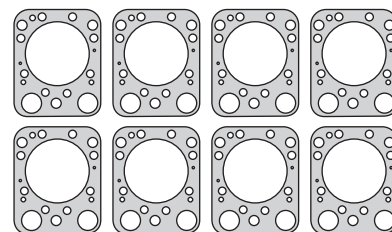

810208

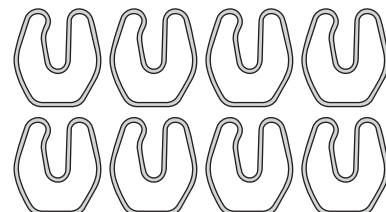

810236

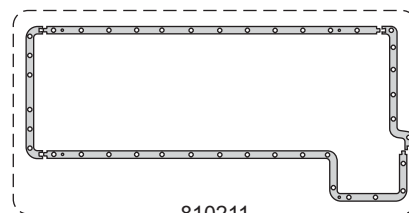

810211



810232

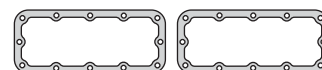

810237

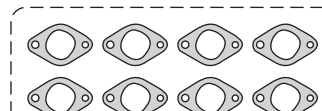

810215

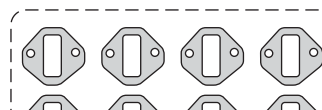

810217

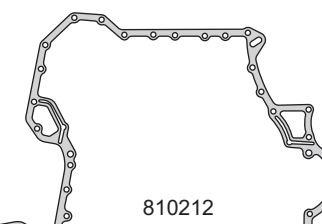

810212

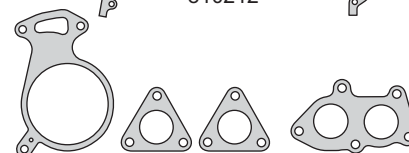

810214

810218

810218-1



810219

810229

810230



810231

SCANIA



Motor/Engine	Cm ³	HP	Ø
DN9	8475	115	115
DS9	8475	174/245	115
DSC9 (OHV) 12V	8475	220/283	115

Scania: G82, P82, F92, G92, K92, P92, R92
T92, F93, G93, K93, P93, T93 1985/96



DIESEL

Nº OE	Descripción/Description	Mat.	Ref.
	Jgo. de juntas para motor		810300-R MLS
	Jgo. de juntas superior (1 cilindro)	●	810395
	Junta. tapa cilin. Ø134.0 ±1.25	MLS	1 6 810308
	Junta tapa válvulas superior	GS	1 6 810210
	Jgo. junta para cárter (4)	NB	1 810311
	Tapa distribución	NB	1 810312
	Placa distribución	NB	1 810313
	Bomba de agua	NB	1 810314
	Jgo. múltiple escape (6)	NFT	1 1 810315
	Jgo. múltiple admisión (6)	NB	1 1 810317-1
	Jgo. múltiple admisión (6)	NFT	1 1 810317-2
	Salida de escape a turbo	AC	1 810318
	Base giratoria filtro aceite	NB	1 810327
	Junta soporte filtro de aceite	NB	1 810328
	Junta radiador aceite	NB	1 810329
	Junta cañería bomba de agua	NB	1 810331
	Junta de aceite	NB	1 810333
	Junta de aceite	NB	1 810334
	Junta filtro aceite	NB	1 810335
	Junta lateral tapa de válvulas	NB	2 810336
	Junta transmisión	NB	1 810337
	Carcaza volante	NB	1 810338
	Enfriador aceite	NB	1 810339
	Junta tapa caja	NB	1 810340
	Arandela soporte filtro aceite	NB	1 810341
	Junta montaje turbo	AC	1 810342
	Junta turbo	NB	1 810343
	Junta turbo	NB	1 810344
	Junta de escape	NB	1 810345
	Junta	NB	1 810346
	Junta	NB	1 810347
	Junta	NB	1 810348
	Guarnición goma	GS	1 810349
	Junta brida	NB	1 810350
	Jgo. suplemento tapa cilindros (12)	GS	1 810370
	Jgo. suplemento tapa cilindros (6)	GS	1 810370-1
	Arandela A 10 x 14 x 1 C	CU	8
	Arandela A 6 x 12 x 1.2 C	CU	1
	Arandela A 8 x 12 x 1.2 C	CU	13
	Arandela A 9.5 x 20 x 2 C	CU	5
	Arandela A 12 x 16 x 1.2 C	CU	3
	Arandela A 14 x 20 x 1.2 A	AL	9
	Arandela A 14 x 18.5 x 1.2 C	CU	13
	Arandela A 18 x 22 x 1.2 C	CU	1
	Arandela A 22 x 27 x 1.5 C	CU	1
	Arandela A 26 x 31 x 1.54 C	CU	1
	Arandela A 26.5 x 34 x 1.2 C	CU	1
	Arandela A 24.5 x 38 x 1.2 C	CU	1
	Anillo G 30 x 35.5 x 9.8	GS	1
	O´ring G 7.59 x 2.62	GS	1
	O´ring G 9.19 x 2.62	GS	6
	O´ring G 10.77 x 2.62	GS	9
	O´ring G 21 x 2	GS	1

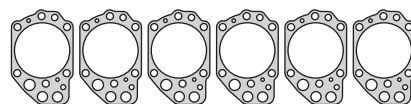

810308



810210

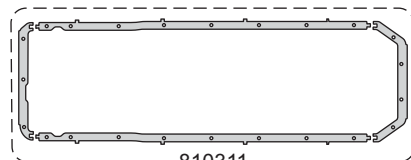

810311



810315

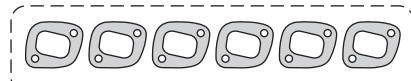

810317-1

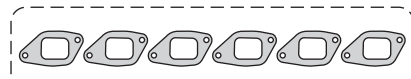

810317-2

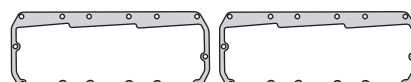

810336

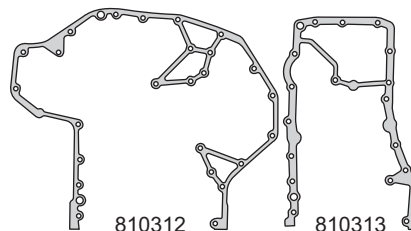

810312

810313

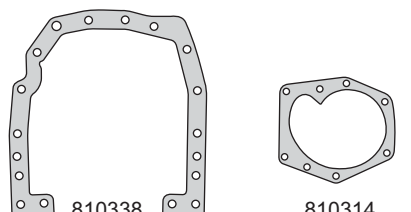

810338

810314

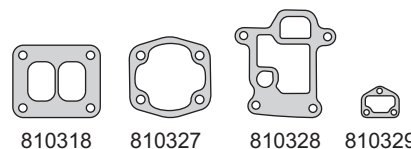

810318

810327

810328

810329

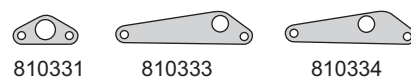

810331

810333

810334

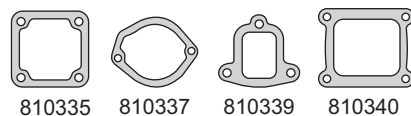

810335

810337

810339

810340

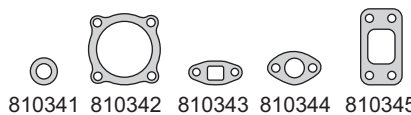

810341

810342

810343

810344

810345

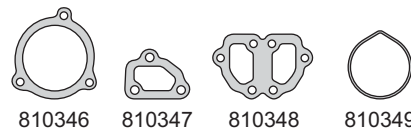

810346

810347

810348

810349

SCANIA



Motor/Engine	Cm³	HP	Ø
DN9	8475	115	115
DS9	8475	174/245	115
DSC9 (OHV) 12V	8475	220/283	115

Scania: G82, P82, F92, G92, K92, P92, R92
T92, F93, G93, K93, P93, T93 1985/96



DIESEL

Nº OE	Descripción/Description	Mat.	Ref.
	O´ring G 25.5 x 3	GS	2
	O´ring G 47 x 5.59	GS	1
	O´ring G 63 x 3.1	GS	2
	O´ring G 75 x 3.2	GS	1
	O´ring G 78.74 x 3.53	GS	1
	O´ring G 100 x 3	GS	3
	O´ring G 103 x 3	GS	2
	O´ring G 107.54 x 3.53	GS	2
	O´ring G 132.94 x 3.53	GS	1
	Retén de bancada 130 x 160 x 15	V	1 R810111V
	Retén de distribución 80 x 100 x 12	V	1 R810115V
	Retén bomba inyectora 25 x 47 x 10	N	1 R810215N

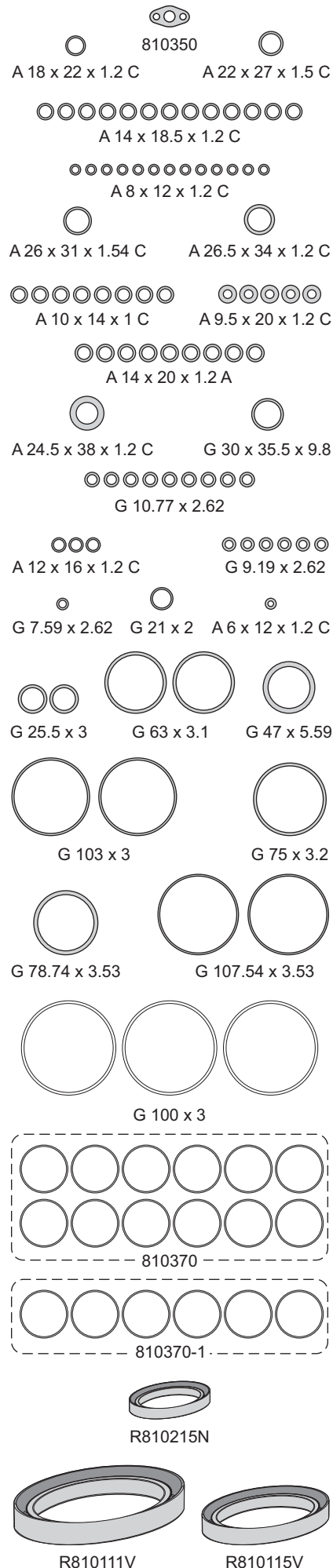

SCANIA



Motor/Engine	Cm³	HP	Ø
DC11.01/02/03/06	10640	340/380	127
DC12.01/03/09	11700	400/420	127
DSC12.05/06	11700	420	127
DT12.02/08 (OHV) 24V	11716	441/469	127

Scania: Serie 114 C340/G340/L340 1996/...
 C380/G380/L380 1998/... Series 124, C400/C420
 G400/G420/L400/L420/C360 1996/...
 C470G470/L420/L440 2001/...
 Serie Bus K420 2010/...



DIESEL

Nº OE	Descripción/Description	Mat.	Ref.
	Jgo. de juntas para motor		810400-R MLS
	Jgo. de juntas superior (1 cilindro)		810495
1.377.039	Junta tapa cilin. Ø 133.0 ± 1.00	MLS 1	6 810408
1.411.851	Junta tapa válvulas	GS 1	6 810410
1.414.422	Junta tapa válvulas	GS 1	6 810436
1.476.506	Junta tapa válvulas	GS 1	6 810536
1.460.359	Jgo. junta para cárter (4)	CG 1	1 810411
1.403.129	Junta distribución	NB 1	1 810412
1.374.334	Junta distribución	NB 1	1 810412-1
1.374.327	Caja distribución	NB 1	1 810413
1.375.387	Caja distribución	NB 1	1 810413-1
1.374.344	Bomba de agua	NB 1	1 810414
1.403.883	Guarnición bomba de agua	GS 1	1 810414-1
1.309.051	Jgo. múltiple escape (6)	GFT 1	1 810415
1.524.474	Jgo. múltiple admisión (6)	SLS 1	1 810417
1.374.338	Jgo. múltiple admisión (6)	CB 1	1 810417-1
1.374.340	Jgo. múltiple admisión (6)	CB 1	1 810417-2
1.374.346	Bomba hidráulica	NB 1	1 810421
1.374.333	Carcasa termostato	GFT 1	1 810426
1.433.886	Radiador aceite	GS 1	1 810427
1.368.061	Sello tubo combustible	GS 1	6 810428
	Sello tubo combustible	GS 1	1 810428-1
1.391.726	Radiador aceite	NB 1	1 810429
1.367.849	Filtro aceite	GS 1	1 810430
1.375.383	Tapa lateral	NB 3	1 810431
1.374.326	Tapa lateral	NB 3	1 810431-1
1.445.514	Tapa lateral 2002/...	GS 1	1 810433
1.401.985	Sellador ventilación cárter	GS 1	1 810434
1.390.211	Tubo admisión	GS 1	1 810435
1.374.517	Filtro agua	NB 1	1 810437
1.349.497	Radiador de aceite	GS 1	1 810438
1.496.381	Filtro rotativo	GS 1	1 810439
1.375.992	Tubo de aceite	NB 1	1 810440
1.374.330	Junta varilla aceite	NB 1	1 810441
	Junta turbo	AC 1	1 810442
	Junta turbo	NFT 1	1 810443
	Junta turbo	AC 1	1 810444
	Junta turbo	NB 1	1 810445
1.374.346	Tubo sensor temperatura	NB 1	1 810449
1.374.336	Junta	NB 1	1 810450
1.374.342	Tubo admisión	NB 1	1 810451
	Kit juntas turbo (4)	VS	1 810468
	Arandela A 8 x 12 x 1 A	AC	18
	Arandela pico inyector A 9.6 x 19.9 x 2 C	CU	6
	Arandela A 10.3 x 13.9 x 1 A	AC	4
	Arandela A 12 x 16 x 1.48 A	AC	8
	Arandela A 14.3 x 19.9 x 1 A	AC	20
	Arandela A 16.3 x 19.8 x 1	AC	8
	Arandela A 16.3 x 21.8 x 1.53	AC	6
	Arandela A 22.3 x 26.8 x 1.50	AC	2
	Arandela A 24.3 x 37.85 x 0.98	AC	1
1.374.842	Arandela fijación a block A 8.7 x 13 x 1/1.50	AC/GS	36
	O ring G 9.20 x 2.53	GS	1

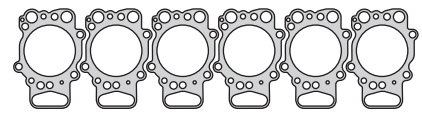

810408

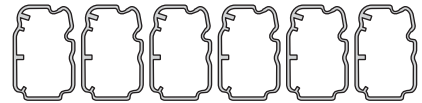

810410

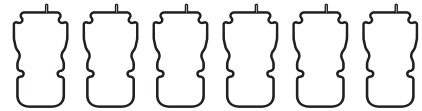

810436

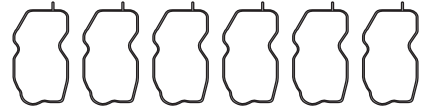

810536

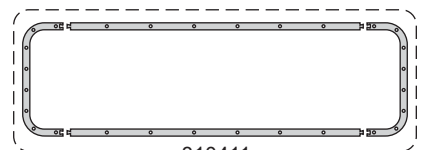

810411

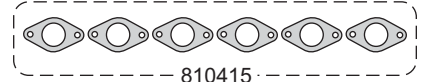

810415

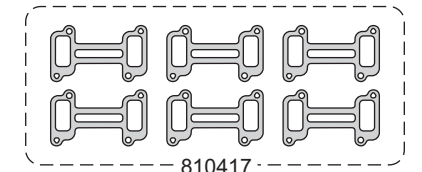

810417

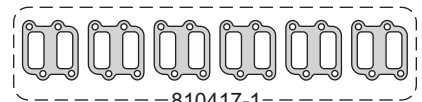

810417-1

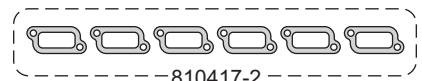

810417-2

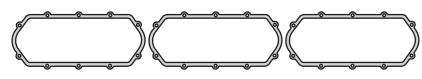

810431

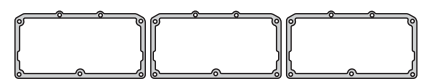

810431-1

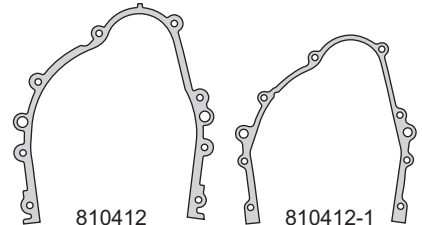

810412

810412-1

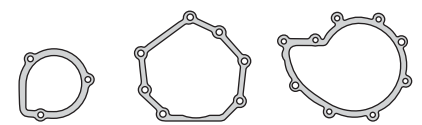

810413-1

810413

810414

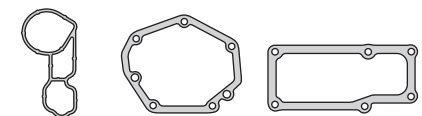

810414-1

810421

810426

SCANIA



Motor/Engine	Cm³	HP	Ø
DC11.01/02/03/06	10640	340/380	127
DC12.01/03/09	11700	400/420	127
DSC12.05/06	11700	420	127
DT12.02/08 (OHV) 24V	11716	441/469	127

Scania: Serie 114 C340/G340/L340 1996/...
C380/G380/L380 1998/... Series 124, C400/C420
G400/G420/L400/L420/C360 1996/...
C470G470/L420/L440 2001/...
Serie Bus K420 2010/...



DIESEL

Nº OE	Descripción/Description	Mat.	Ref.
	O´ring G 11 x 2.63	GS	3
	O´ring G 15.5 x 2.63	GS	4
	O´ring G 19 x 1.80	GS	24
	O´ring G 20 x 2.63	GS	1
	O´ring G 24 x 3	GS	1
	O´ring G 32 x 4.30	GS	2
	O´ring G 40 x 4	GS	2
	O´ring G 43 x 3	GS	2
	O´ring G 49 x 4	GS	2
	O´ring G 50 x 4	GS	2
	O´ring G 64 x 3	GS	1
	O´ring G 112 x 3.5	GS	1
	O´ring G 118 x 2.9	GS	1
	O´ring G 130 x 3.6	GS	1
	O´ring G 140 x 2.43	GS	6
	O´ring G 145 x 4	GS	6
	O´ring G 180 x 3	GS	1
	Kit de retenes completo		R810400
	Jgo. retén válvulas (24)	V	1 R810410V
	Retén de bancada 145 x 175 x 13	T	1 R810411T
	Retén de distribución 120 x 140 x 12	T	1 R810412T

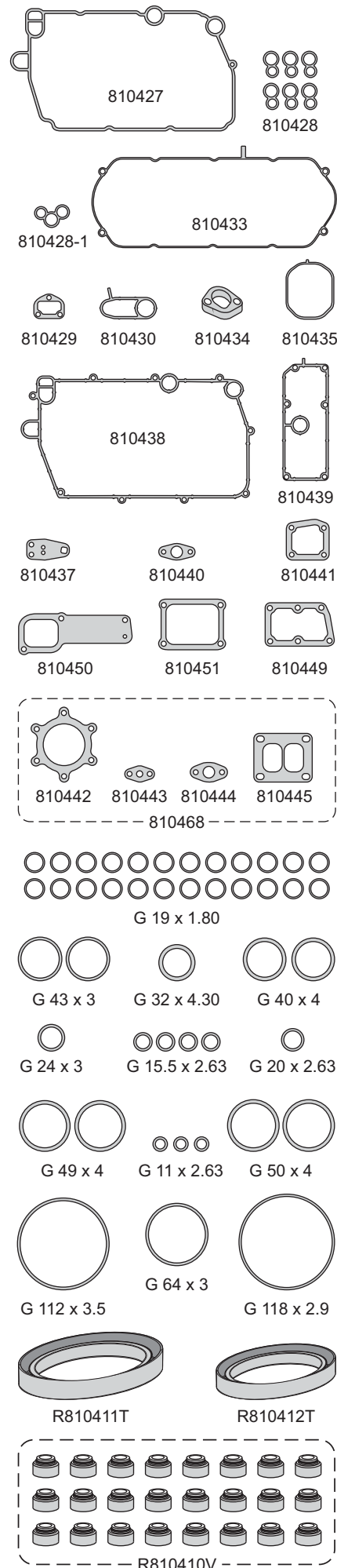

SCANIA



Motor/Engine	Cm³	HP	Ø
DC11.08	10600	340	127
DC12.06/12	11700	420	127
DC12.10/13	11700	340/380	127
DC12.17/18	11716	379	127
DT12.03/06/17/18 (OHV) 24V DIESEL	11716	440/480	127

Scania: Series P/G/R/T - Serie K
 G340/380/420, R340, P340, R340, P380,
 R380/420 2004/..., G470 2005/..., Bus K340/420
 Bus Irizar Century 420 2006/...
 Bus K380, Omniexpress 380,
 P420, G420/470 2008/...



Nº OE	Descripción/Description	Mat.	Ref.
	Jgo. de juntas para motor		● 810500-R MLS
	Jgo. de juntas superior (1 cilindro)	●	810595
	Junta tapa cilin. Ø 133 ± 0.95 N.R.	MLS 1	6 810408
	Junta tapa válvulas superior	GS 1	6 810510
	Jgo. junta para cárter (4)	CG 1	1 810411
	Junta tapa válvulas inferior	GS 1	1 810536
	Múltiple escape	GFT 1	6 810415
	Múltiple admisión	SLS 1	6 810417
	Sello tubo combustible	GS 1	1 810428
	Sello tubo combustible	GS 1	1 810428-1
	Arandela especial A 7 x 14 x 1.80	AC/GS 6	6
	Arandela A 13 x 22 x 1 A	AL 1	1
	Kit de retenes completo		R810400
	Jgo. retén válvulas (24)	V 1	1 R810410V
	Retén de bancada 145 x 175 x 13	T 1	1 R810411T
	Retén de distribución 120 x 140 x 12	T 1	1 R810412T



810408

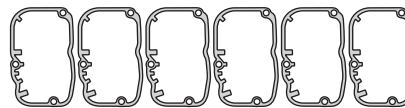

810510

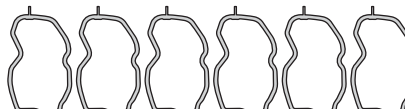

810536

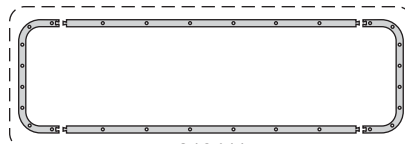

810411



810415

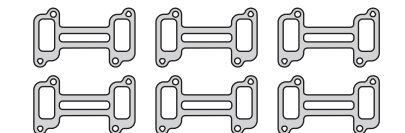

810417



810428 A 13 x 22 x 1 A 810428-1



A 7 x 14 x 1.80

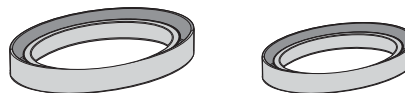

R810411T

R810412T

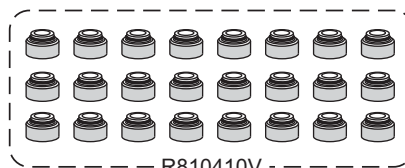

R810410V

SCANIA



Motor/Engine	Cm³	HP	Ø
DSC9, DSI9 (OHV) 12V	8974	220/310	115

Scania: P94, R94 1996/...

DIESEL



Nº OE	Descripción/Description	Mat.	Ref.
	Jgo. de juntas para motor		810600-R MLS
	Jgo. de juntas superior (1 cilindro)	●	810695
	Jta. tapa cilindros Ø134.0 \pm 1.25 N.R.	MLS 1	6 810308
	Junta tapa válvulas superior	GS 1	6 810210
	Junta para cárter	NB 1	1 810611
	Jgo. múltiple escape (6)	NB 1	1 810415
	Múltiple admisión	NB 1	1 810617
	Salida de escape a turbo	NB 1	1 810618
	Guarnición cierre tapa de válvulas	GS 1	6 810633
	Arandela especial A 7.5 x 13 x 1.80	AC/GS 2	2
	Arandela A 9.5 x 20 x 1.5 C	CU 1	1
	Retén bancada 130 x 160 x 13	V 1	R810611V
	Retén distribución 80 x 100 x 13	V 1	R810612V

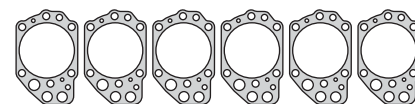

810308



810210

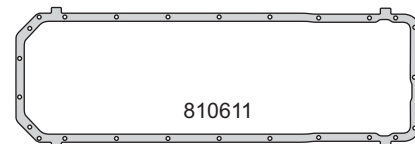

810611

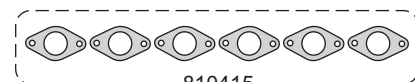

810415

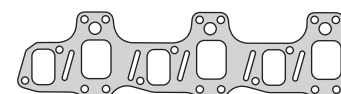

810617



810618



810633



A 9.5 x 20 x 1.5



A 7.5 x 13 x 1.80



R810611V



R810612V

SCANIA



Motor/Engine	Cm ³	HP	Ø
DC 11.07	10641	329	127
DC 12.07 (OHV) 24V	11705	379	127

Scania: Serie 4 Camión
114C, 114L 1999/04, 114G 2001/08,
114G, 114L 2005/08



DIESEL

Nº OE	Descripción/Description	Mat.	Ref.
	Jgo. de juntas para motor		810700
	Jgo. de juntas superior (1 cilindro)		810795
	Junta tapa cilin. Ø 133.5 \pm 0.95 N.R.	MLS 1	6 810708
	Junta tapa válvulas superior	GS 1	6 810710
	Junta para cárter	CG 1	1 810411
	Junta tapa válvulas inferior	GS 1	1 810736
	Jgo. múltiple escape (6)	GFT 1	1 810415
	Jgo. múltiple admisión (6)	SLS 1	1 810417
	Arandela especial A 7.5 x 13 x 1/1.90	AC/GS 6	6
	Arandela A 9.5 x 20 x 1.5 C	CU 1	1
	O´ring G 17.17 x 1.78	GS 1	1
	Jgo. retén válvulas (24)	V 1	1 R810410V
	Retén de bancada 145 x 175 x 13	T 1	1 R810411T

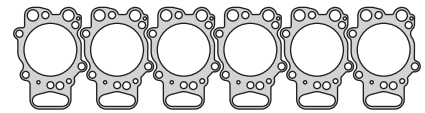

810708

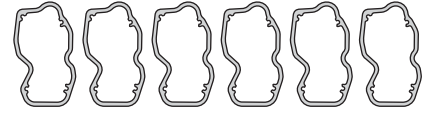

810710

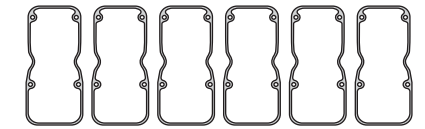

810736

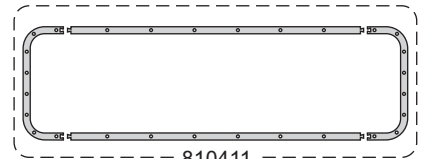

810411

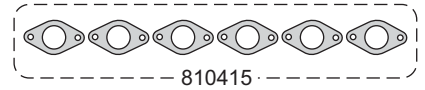

810415

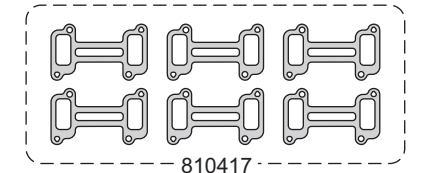

810417



A 9.5 x 20 x 1.5

G 17.17 x 1.78



A 7.5 x 13 x 1/1.90



R810411T

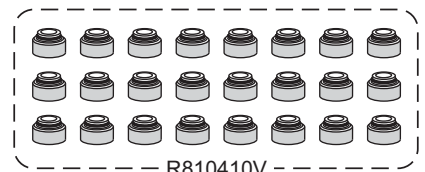

810410V

SCANIA



Motor/Engine	Cm³	HP	Ø
DSC 12.01/02 (OHV) 24V	11716	360/420	127

Scania: Serie 4 Camión
P124, R124, T124 1996/01
124C, T124C, T124G 1995/08



DIESEL

Nº OE	Descripción/Description	Mat.	Ref.
	Jgo. de juntas para motor	● ●	810800-R MLS
	Jgo. de juntas superior (1 cilindro)	●	810895
	Junta tapa cilin. Ø 133 ± 0.95	MLS 1	6 810708
	Junta tapa válvulas superior	GS 1	6 810710
	Junta tapa válvulas inferior	GS 1	6 810736
	Jgo. junta para cárter (4)	NB 1	810411
	Junta distribución	NB 1	810412
	Junta distribución	NB 1	810412-1
	Caja distribución	NB 1	810413
	Caja distribución	NB 1	810413-1
	Bomba de agua	NB 1	810414
	Guarnición bomba de agua	GS 1	810414-1
	Jgo. múltiple escape (6)	GFT 1	1 810815
	Jgo. múltiple admisión (5)	NB 1	1 810817
	Jgo. múltiple admisión (3)	NB 1	1 810817-1
	Bomba hidráulica	NB 1	810421
	Carcasa termostato	NB 1	810426
	Radiador aceite	NB 1	810429
	Filtro aceite	GS 1	810430
	Tapa lateral	NB 1	810431
	Tapa lateral	NB 3	810431-1
	Tubo admisión	GS 1	810435
	Filtro agua	NB 1	810837
	Radiador de aceite	GS 1	810438
	Filtro rotativo	GS 1	810439
	Tubo de aceite	NB 2	810840
	Junta brida	NB 1	810841
	Junta turbo	AC 1	810445
	Tubo sensor temperatura	NB 1	810449
	Junta	NB 2	810450
	Tubo admisión	NB 1	810451
	Jgo. suplemento camisa cilindros (18)	GS 1	810870
	Arandela A 6 x 10.5 x 1 A	AL 1	
	Arandela A 8 x 12 x 1 A	AL 14	
	Arandela pico inyector A 9.5 x 20 x 1.5 C	CU 1	6
	Arandela A 10 x 15 x 1.2 A	AL 7	
	Arandela A 12 x 17 x 1.2 C	CU 2	
	Arandela A 14 x 20 x 1.2 A	AL 12	
	Arandela A 14 x 18 x 1.5 C	CU 9	
	Arandela A 16 x 22 x 1.5 A	AL 2	
	Arandela A 18 x 22 x 1.2 C	CU 1	
	Arandela A 22 x 27 x 1.2 A	AL 1	
	Arandela A 27 x 35 x 1.2 C	CU 1	
	Arandela A 26.5 x 31 x 1.1 C	CU 1	
	Arandela fijación a block A 6.5 x 13 x 1/1.7 A	AC/GS 24	
	Anillo G 22 x 26 x 3.63	GS 1	
	Anillo G 30 x 35 x 9.5	GS 2	
	O´ring G 17.17 x 1.78	GS 3	19
	O´ring G 10.77 x 2.62	GS 2	
	O´ring G 25.07 x 3.53	GS 1	
	O´ring G 44 x 3.1	GS 2	
	O´ring G 64 x 3.1	GS 1	
	O´ring G 109 x 3.1	GS 1	



810708

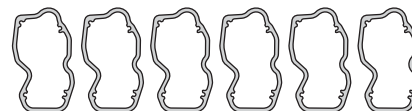

810710

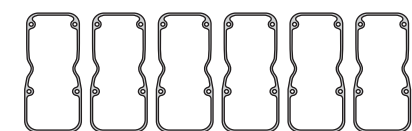

810736

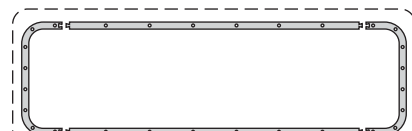

810411



810815

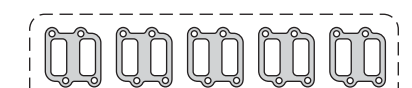

810817



810817-1

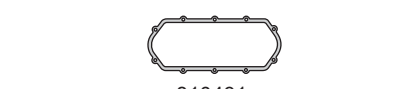

810431

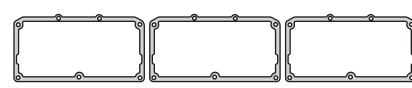

810431-1

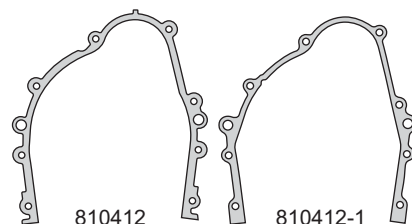

810412

810412-1



810413-1

810413

810414



810414-1

810421

810426



810429

810430

810439

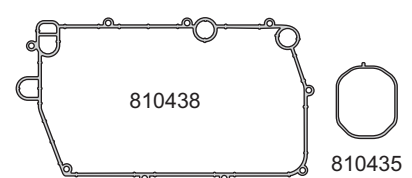

810438

810435

SHANGHAI



Motor / Engine	Cm ³	HP	Ø
495A Tracción Simple			
485A 18 Tracción Doble			
DIESEL			

Shangai: Tractor



Nº OE	Descripción / Description	Mat.	Ref.
	Jgo. de juntas para motor		910900
	Junta tapa cilindros Ø 101.0 ±1.40	NFT 1	910905
	Junta tapa válvulas	GS 1	910910
	Jgo. junta para carter (2)	NB 1	910911
	Tapa distribución	NB 1	910912
	Placa distribución	NB 1	910913
	Bomba de agua	NB 1	910914
	Múltiple escape	NFT 1	910916
	Múltiple admisión	NB 2	910917
	Salida de escape	NFT 1	910918
	Base bomba de agua	NB 1	910919
	Bomba aceite	NB 1	910927
	Junta gaseador	CG 1	910928
	Junta bomba aceite	NB 1	910929
	Cámara de agua	NB 1	910932
	Cámara de agua trasera	NB 1	910933
	Junta	NB 1	910934
	Junta acople termostato	NB 2	910935
	Junta lateral block	NB	910936
	Junta superior distribución	NB 1	910937
	Cámara lateral	CG 1	910938
	Acople salida motor	NB 1	910939
	Bomba inyectora	NB 1	910940
	Bomba inyectora	NB 1	910942
	Junta acople distribución	NB 1	910943
	Bomba de aceite	NB 1	910944
	Tapa bomba de agua	NB 1	910945

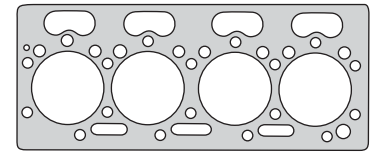

910905

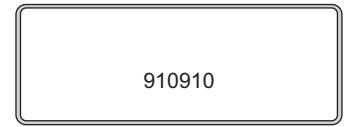

910910

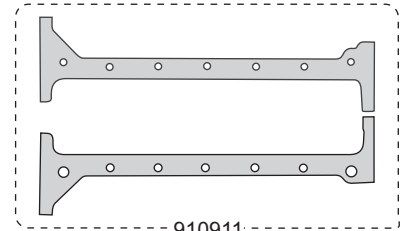

910911



910916



910917

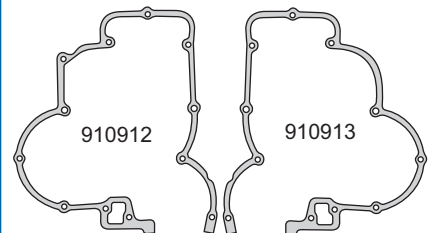

910912

910913

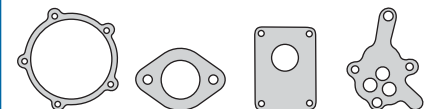

910914

910918

910919

910927



910928



910929



910932



910933



910934



910935

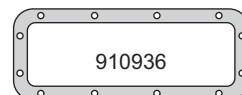

910936



910937

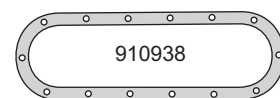

910938



910945

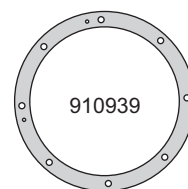

910939



910940



910942



910943



910944



taranto



KIT HAK639512-111 Taranto.

Práctico Juego de llaves combinadas para Taller.

- Contiene 111 Tubos y llaves SmarDriv encastre 1/4", 3/8" y 1/2"
- Forjados en acero especial, niquelados y cromados anticorrosión.
- Diseñados y fabricados con un rango de medidas acorde a las necesidades de cada pieza.



TOYOTA



Motor / Engine	Cm ³	HP	Ø
1DZ II (OHV) 8V	1998	54	86
DIESEL			

Toyota: Autoelevador 1995/00

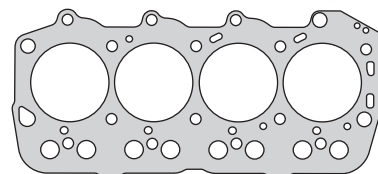

924408



924410



924415



924417

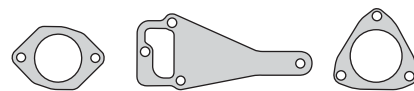

924431

924419

924435

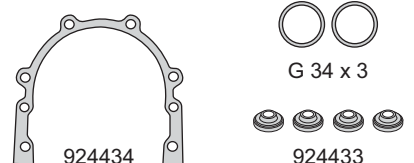

924434

G 34 x 3

924433

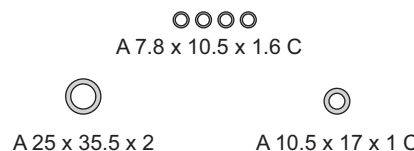

A 7.8 x 10.5 x 1.6 C

A 25 x 35.5 x 2

A 10.5 x 17 x 1 C

G 37 x 49 x 7.40

G 122 x 3



R924411S

R924412S

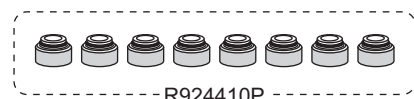

R924410P

Nº OE	Descripción / Description	Mat.	Ref.
	Jgo. de juntas para motor		● 924400-R MLS
	Junta tapa cilindros Ø 87.5 ± 0.85	MLS	1 924408
	Sellador líquido - caucho de silicona		TRN0085G
	Junta tapa válvulas	GS	1 924410
	Múltiple escape	FCH	1 924415
	Múltiple admisión	MLS	1 924417
	Junta termostato	SLS	1 924419
	Junta	SLS	1 924431
	Arandela con inserto tapa de válvulas	GS/AC	4 924433
	Porta retén bancada trasera	NB	1 924434
	Junta	NFT	1 924435
	Arandela tapón cárter A 25 x 35.5 x 2	F	1
	Arandela espiralada A 7.8 x 10.5 x 1.60 C	CU	4
	Arandela A 10.5 x 17 x 1 C	CU	1
	Anillo G 37 x 49 x 7.40	GS	1
	O`ring G 34 x 3	GS	2
	O`ring G 122 x 3	GS	1
	Kit de retenes completo		R924400
	Jgo. retén válvulas (8)	P	1 R924410P
	Retén bancada 95 x 115 x 8.5	S	1 R924411S
	Retén distribución 45 x 62 x 9	S	1 R924412S

TOYOTA



Motor / Engine	Cm ³	HP	Ø
1DZ (OHV) 8V	1998	52	86

Toyota: Autoelevador 1998/05

DIESEL



Nº OE	Descripción / Description	Mat.	Ref.
	Jgo. de juntas para motor		● 924500-R MLS
	Junta tapa cilindros Ø 87.0 ± 1.40	MLS 1	924508
	Sellador líquido - caucho de silicona		TRN0085G
	Junta tapa válvulas	GS 1	924410
	Junta distribución	NB 1	924512
	Tapa distribución	NB 1	924513
	Múltiple escape	FCH 1	924415
	Múltiple admisión	MLS 1	924517
	Salida de escape	FCH 2	923018
	Junta termostato	SLS 1	924419
	Junta bomba aceite	SLS 1	924527
	Junta	SLS 1	924431
	Junta	NB 1	924535
	Arandela con inserto tapa de válvulas	GS/AC 4	924433
	Porta retén bancada trasera	NB 1	924434
	Arandela tapón cárter A 25 x 35.5 x 2 F	F 1	
	Arandela espiralada A 7.8 x 10.5 x 1.6 C	CU 4	
	Arandela A 10.5 x 17 x 1 C	CU 1	
	Anillo G 37 x 49 x 7.4	GS 1	
	O`ring G 34 x 3	GS 2	
	O`ring G 80 x 3	GS 1	
	O`ring G 122 x 3	GS 1	
	Kit de retenes completo		R924400
	Jgo. retén válvulas (8)	P 1	R924410P
	Retén bancada 95 x 115 x 8.5	S 1	R924411S
	Retén distribución 45 x 62 x 9	S 1	R924412S

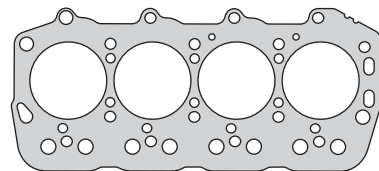

924508



924410



924415



924517

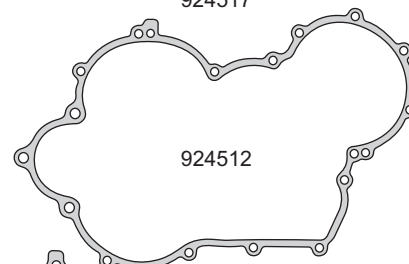

924512

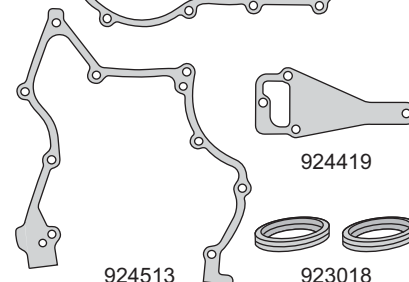

924419

924513

923018



924527

924431

924433

924535

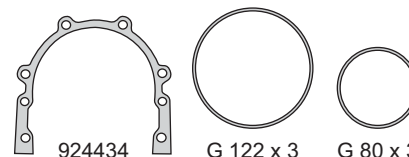

924434

G 122 x 3

G 80 x 3

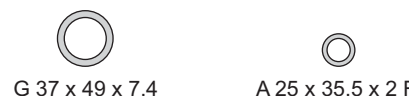

G 37 x 49 x 7.4

A 25 x 35.5 x 2 F



G 34 x 3



A 7.8 x 10.5 x 1.6 C

A 10.5 x 17 x 1 C



R924411S

R924412S



R924410P

TOYOTA



Motor / Engine	Cm ³	HP	Ø
1Z 5FD/F	2953	59	96

Toyota: Tractor 6F, Autoelevador

DIESEL

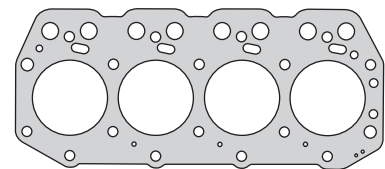

925307

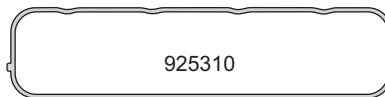

925310



925315

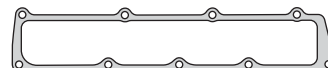

925317

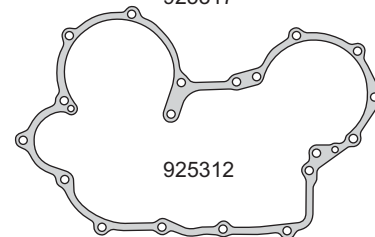

925312

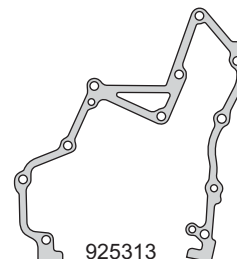

925313

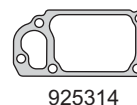

925314



925319



924518



925327

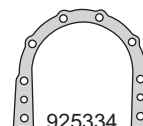

925334

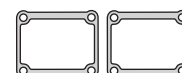

925330



G 82 x 3



G 34 x 3



G 135 x 3



924433



A 25 x 36 x 1.90



G 17 x 24.5 x 9



G 37 x 49 x 7.40



G 17 x 25 x 14



A 7 x 17 x 2.60



R925311S



R925312S

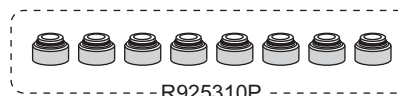

R925310P

Nº OE	Descripción / Description	Mat.	Ref.
	Jgo. de juntas para motor		925300-R
	Junta tapa cilindros Ø 97.5 ± 1.70	NFT	1 925307
	Sellador líquido - caucho de silicona		TRN0085G
	Junta tapa válvulas	GS	1 925310
	Junta distribución	NB	1 925312
	Placa distribución	NB	1 925313
	Bomba de agua	SLS	1 925314
	Múltiple escape	NFT	1 925315
	Múltiple admisión	SLS	1 925317
	Salida de escape	FCH	2 924518
	Soporte bomba de agua	SLS	1 925319
	Junta bomba de aceite	SLS	1 925327
	Junta	SLS	2 925330
	Arandela con inserto tapa de válvulas	AC/GS	4 924433
	Porta retén bancada trasera	NB	1 925334
	Anillo G 37 x 49 x 7.40	GS	1
	Arandela tapón cárter A 25 x 36 x 1.90	F	1
	Arandela A 7 x 17 x 2.60	CU	4
	Anillo G 17 x 25 x 14	GS	4
	Anillo G 17 x 24.5 x 9	GS	1
	O´ring G 34 x 3	GS	1
	O´ring G 82 x 3	GS	1
	O´ring G 135 x 3	GS	1
	Kit de retenes completo		R925300
	Jgo. retén válvulas (8)	P	1 R925310P
	Retén bancada 95 x 115 x 8.5	S	1 R925311S
	Retén distribución 55 x 77 x 8.5	S	1 R925312S

TOYOTA



Motor / Engine	Cm ³	HP	Ø
11Z	4430		96
DIESEL			

Toyota: Tractor 1988/...



Nº OE	Descripción / Description	Mat.	Ref.
	Jgo. de juntas para motor	●	926500-R
	Junta tapa cilindros Ø 97.5 ± 1.70	NFT 1	926507
	Sellador líquido - caucho de silicona		TRN0085G
	Junta tapa válvulas	GS 1	926510
	Junta distribución	NB 1	926512
	Placa distribución	NB 1	925313
	Bomba de agua	SLS 1	925314
	Jgo. múltiple escape (3)	FCH 1	926515
	Múltiple admisión	SLS 1	926517
	Salida de escape	FCH 1	925918
	Soporte bomba de agua	SLS 1	925319
	Junta bomba de aceite	SLS 1	925327
	Junta	SLS 2	925330
	Arandela con inserto tapa de válvulas	AC/GS 6	926533
	Porta retén bancada trasera	NB 1	925334
	Guarnición goma G 37 x 49 x 7.40	GS 1	926548
	Arandela tapón cárter A 25 x 36 x 1.90	F 1	
	Arandela A 7 x 17 x 2.60	CU 6	
	Anillo G 17 x 25 x 14	GS 6	
	Anillo G 17 x 24.5 x 9	GS 1	
	O´ring G 34 x 3	GS 1	
	O´ring G 80 x 3	GS 1	
	O´ring G 135 x 3	GS 1	
	Kit de retenes completo		R926500
	Jgo. retén válvulas (12)	P 1	R926510P
	Retén bancada 95 x 115 x 8.5	S 1	R925311S
	Retén distribución 55 x 77 x 8.5	S 1	R925312S

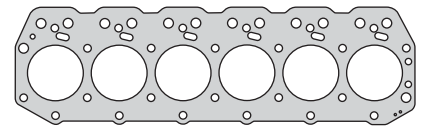

926507

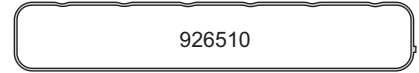

926510

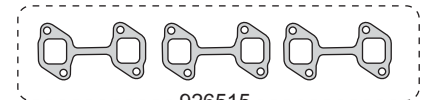

926515



926517

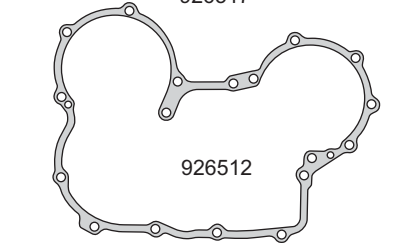

926512

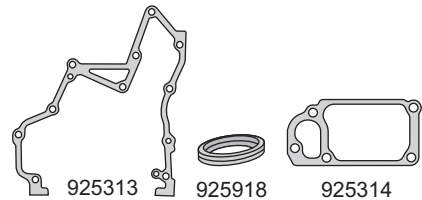

925313

925918

925314

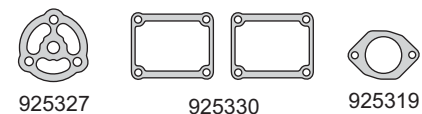

925327

925330

925319



925334

926548

G 80 x 3



926533



G 17 x 25 x 14

A 7 x 17 x 2.60



G 34 x 3

A 25 x 36 x 1.90

G 17 x 24.5 x 9



R925311S

R925312S

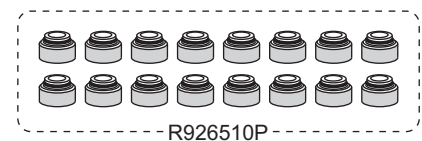

R926510P

VOLVO



Motor/Engine	Cm³	HP	Ø
THD 101 KC (OHV) 12V	9600	273/310	120.6

Volvo: B58, B10M 1987/...



DIESEL

Nº OE	Descripción/Description	Mat.	Ref.
	Jgo. de juntas para motor		880000-R
270.789	Junta tapa cilindros Ø 136.5 ±1.40	ACG	6 880008
424693.0	Junta tapa válvulas superior	GS	6 880010
424607	Jgo. junta para cárter (4)	NB	1 880011
468116	Delantera distribución	NB	1 880012
468557	Placa de distribución	NB	1 880013
479107	Jgo. múltiple escape (6)	NFT	1 880015
424618	Junta admisión	NFT	1 880017
424694.8	Tapa válvulas inferior	GS	6 880031
	Tapa válvulas lateral	GS	3 880036
	Lateral cámara de agua	NB	880037
	Enfriador de aceite	NB	1 880038
	Guarnición goma (verde claro)	GS	6 880039
	Kit de turbina (bipartida) (4)	VS	1 880040
	Guarnición	GS	1 880043
	Guarnición	GS	1 880044
	Anillo G 24 x 30 x 6	GS	3 880045
	Anillo G 18 x 23 x 3	GS	6 880046
	Kit de arandelas (87)	VS	1 880047
	Kit de gomas (134)	VS	1 880048
	Turbina turbo	AC	1 810362
	Base turbo	AC	1 810363
	Entrada aceite a turbo	NB	1 810365
	Entrada turbo	NB	1 810367
	Arandela A 8 x 12 x 1 C	CU	17
	Arandela A 12 x 20 x 1.5 C	CU	11
	Arandela A 14 x 24 x 2 C	CU	21
	Arandela A 16 x 22 x 1.5 C	CU	3
	Arandela A 18 x 22 x 1.5 C	CU	4
	Arandela A 20 x 24 x 1.5 C	CU	1
	Arandela A 24 x 30 x 1.5 C	CU	3
	Arandela A 10 x 14 x 1.5 A	AL	2
	Arandela A 22 x 27 x 1.5 A	AL	1
	Arandela A 8 x 15 x 1.5 C	CU	24
	Anillo A 45 x 50 x 1.4 PL	PLAST	6
	Anillo A 38 x 43 x 1.5 PL	PLAST	12
	Anillo A 30 x 35 x 1 PL	PLAST	1
	O'ring G 23 x 32 x 5	GS	6
	O'ring G 22 x 28 x 3	GS	2
	O'ring G 65 x 7	GS	1
	O'ring G 58 x 7	GS	1
	O'ring G 44 x 56 x 10	GS	5
	O'ring G 35 x 45 x 7	GS	6
	O'ring G 20 x 27 x 4	GS	6
	Anillo G 20 x 28 x 13	GS	5
	Anillo G 95 x 100 x 3.5	GS	1
	Anillo G 21 x 28 x 3	GS	3
	Anillo G 35 x 45 x 6.6	GS	4
	Anillo G 34 x 39 x 3	GS	3
	Anillo múltiple de escape G 75 x 81.8 x 4.5	GS	6
	Anillo G 20 x 28 x 7.5	GS	4
	Anillo G 71 x 78 x 4	GS	1
	Anillo G 46 x 55 x 4.5	GS	1

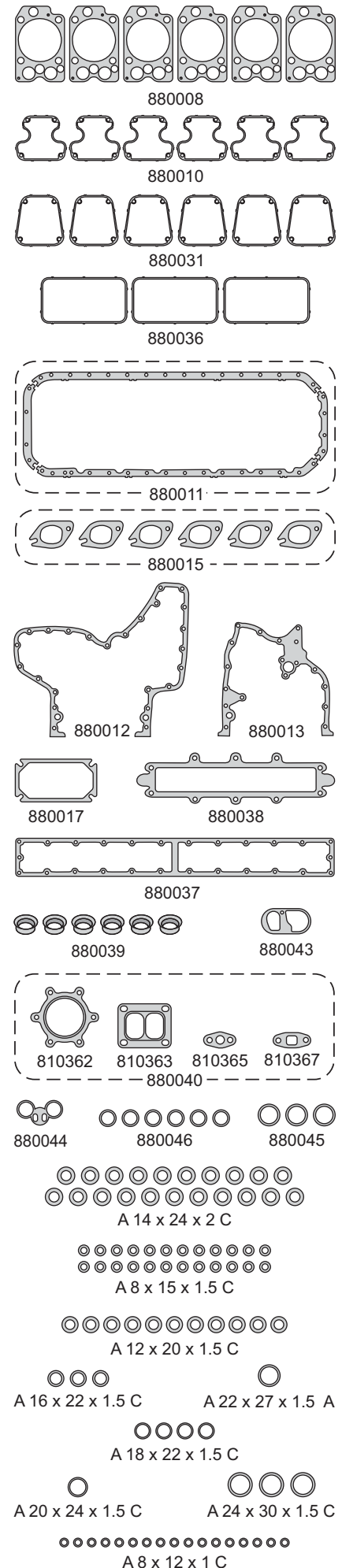

VOLVO



Motor/Engine Cm³ HP Ø

THD 101 KC (OHV) 12V 9600 273/310 120.6

Volvo: B58, B10M 1987/...

DIESEL



Nº OE	Descripción/Description	Mat.	Ref.
	Anillo G 25 x 29 x 3	GS 2	
	Anillo G 18 x 24 x 8	GS 1	
	Anillo G 13 x 20 x 5	GS 2	
	Anillo G 27 x 20 x 3	GS 1	
	Anillo G 40 x 34 x 3	GS 1	
	O´ring G 34 x 3	GS 2	
	O´ring G 19 x 3	GS 5	
	O´ring G 64 x 3	GS 1	
	O´ring G 56 x 3.4	GS 2	
	O´ring G 38 x 5	GS 2	
	O´ring G 49 x 3	GS 4	
	O´ring G 17 x 2	GS 2	
	O´ring G 26 x 3	GS 1	
	O´ring G 43 x 3	GS 1	
	O´ring G 116 x 3	V 1	
	Kit de retenes completo		R880000
	Retén bancada 155 x 180 x 15	V 1	R880011V
	Retén distribución 85.72 x 114.33 x 13	V 1	R880012V
	Retén árbol de levas 30 x 50 x 7.5	V 1	R340312V

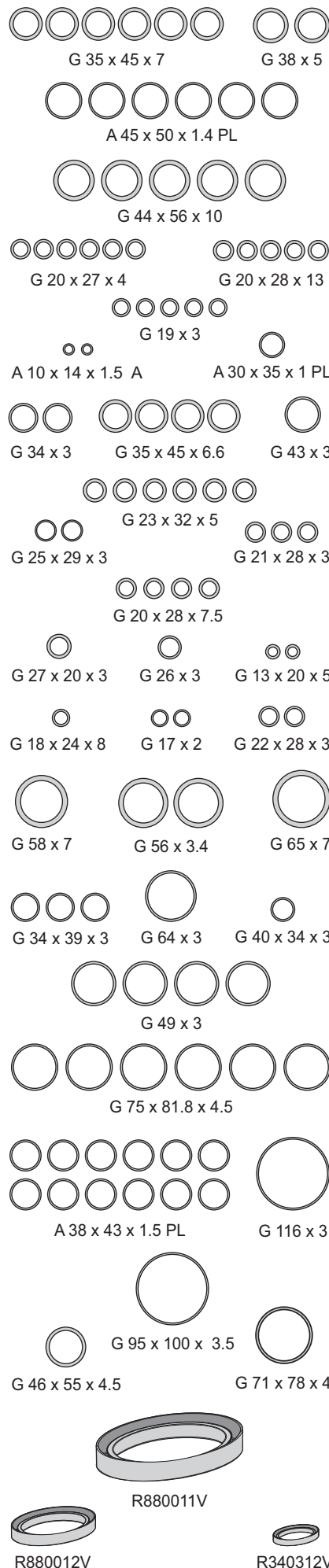

VOLVO**taranto**

Motor/Engine

Cm³

HP

Ø

Volvo: B58 1980/85

THD 100D
(OHV) 12V

9600

230/260

120.6

DIESEL



Nº OE	Descripción/Description	Mat.	Ref.
	Jgo. de juntas para motor		880100-R
275.551	Junta tapa cilindros Ø 130.0 ± 1.40	ACG 6	880108
423145.2	Junta tapa de válvulas	GS 6	880110
424.607	Jgo. junta para cárter (4)	NB 1	880011
	Delantera de distribución	NB 1	880112
468.557	Placa de distribución	NB 1	880013
	Jgo. múltiple escape (6)	NFT 1	880115
422.616	Junta admisión	NFT 1	880117
423146.2	Junta tapa de válvulas	GS 6	880131
	Junta lateral tapa de válvulas	GS 3	880036
	Guarnición goma (verde claro)	GS 6	880039
	Kit de turbina (un agujero) (4)	VS 1	880140
	Guarnición goma	GS 1	880044
	Anillo G 18 x 23 x 3	GS 4	880046
	Anillo G 15 x 18 x 4	GS 1	880146
	Kit de arandelas (84)	VS 1	880147
	Kit de gomas (104)	VS 1	880148
	Turbina turbo	AC 1	810362
	Escape turbo	AC 1	880263
	Entrada de aceite a turbo	NB 1	810365
	Entrada turbo	NB 1	810367
	Anillo múltiple escape G 75 x 81.8 x 4.5	GS 6	
	Arandela A 8 x 12 x 1 C	CU 17	
	Arandela A 12 x 20 x 1.5 C	CU 11	
	Arandela A 14 x 24 x 2 C	CU 20	
	Arandela A 16 x 22 x 1.5 C	CU 3	
	Arandela A 18 x 22 x 1.5 C	CU 5	
	Arandela A 20 x 24 x 1.5 C	CU 1	
	Arandela A 22 x 28.5 x 2 C	CU 2	
	Arandela A 24 x 30 x 1.5 C	CU 1	
	Arandela A 26.5 x 31.5 x 1.5 C	CU 2	
	Arandela A 8 x 12 x 1.5 A	AL 1	
	Arandela A 8 x 13 x 1.5 A	AL 21	
	Anillo A 45 x 50 x 1.4 PL	PLAST 6	
	Anillo A 38 x 43 x 1.5 PL	PLAST 12	
	Anillo A 30 x 35 x 1 PL	PLAST 1	
	Guarnición goma G 23 x 32 x 5	GS 6	
	Anillo de goma G 65 x 7	GS 1	
	Anillo de goma G 58 x 7	GS 1	
	Anillo de goma G 20 x 27 x 4	GS 9	
	Anillo G 20 x 28 x 13	GS 2	
	Anillo G 95 x 100 x 3.5	GS 1	
	Anillo G 21 x 28 x 3	GS 1	
	Anillo G 35 x 45 x 6.6	GS 4	
	Anillo G 34 x 39 x 3	GS 3	
	Anillo G 46 x 55 x 4.5	GS 3	
	Anillo G 25 x 29 x 3	GS 2	
	Anillo G 20 x 27.5 x 13	GS	
	Anillo G 28 x 34 x 3	GS	
	Anillo G 36 x 45 x 6	GS	
	Anillo G 50 x 56.5 x 4	GS 1	
	Anillo G 24 x 30 x 3	GS 2	
	O'ring G 34 x 3	GS 4	

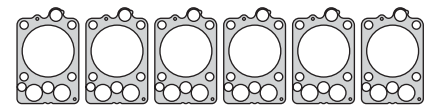

880108

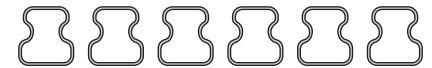

880110



880131



880036

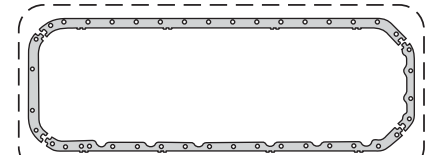

880011

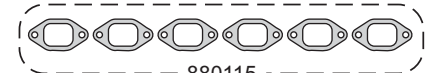

880115

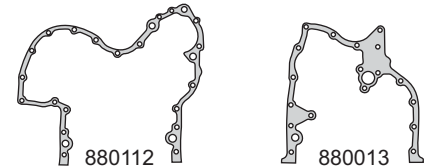

880112

880013

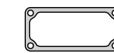

880117



880039

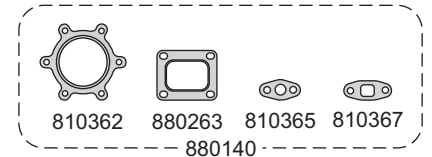

810362

880263

810365

810367

880140



880044



880046

880146



G 75 x 81.8 x 4.5



A 26.5 x 31.5 x 1.5 C

A 22 x 28.5 x 2 C

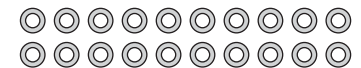

A 14 x 24 x 2 C

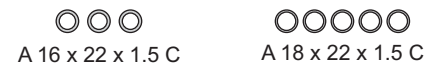

A 16 x 22 x 1.5 C

A 18 x 22 x 1.5 C



A 8 x 13 x 1.5 A



A 20 x 24 x 1.5 C

A 24 x 30 x 1.5 C



A 12 x 20 x 1.5 C

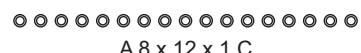

A 8 x 12 x 1 C

VOLVO**taranto**

Motor/Engine

Cm³

HP

Ø

Volvo: N10 1980/85

TD 100A
(OHV) 12V

9600

230/260

120.6

DIESEL



Nº OE	Descripción/Description	Mat.	Ref.
	Jgo. de juntas para motor		880200-R
275.551	Junta tapa cilindros Ø 130.0 ± 1.40	ACG	6
423145.2	Junta tapa de válvulas	GS	6
424.607	Jgo. junta para cárter (4)	NB	1
467.177	Delantera de distribución	NB	1
468.557	Placa de distribución	NB	1
423.127	Bomba de agua	NB	1
	Jgo. múltiple escape (6)	NFT	1
422.616	Junta admisión	NFT	1
423146.2	Junta tapa de válvulas	GS	6
	Guarnición de goma grafitada	GFT	6
	Lateral tapa de válvulas	GS	3
	Guarnición goma (verde claro)	GS	6
	Kit de turbina (un agujero) (4)	VS	1
	Anillo fieltro	FIE	1
	Guarnición goma	GS	1
	Anillo G 18 x 23 x 3	GS	1
	Kit de arandelas (89)	VS	1
	Kit de gomas (91)	VS	1
	Turbina turbo	AC	1
	Escape turbo	AC	1
	Entrada de aceite a turbo	NB	1
	Entrada turbo	NB	1
	Anillo múltiple escape G 75 x 81.8 x 4.5	GS	6
	Arandela A 8 x 12 x 1 C	CU	1
	Arandela A 10 x 16.2 x 1.5 C	CU	5
	Arandela A 12 x 20 x 1.5 C	CU	9
	Arandela A 14 x 24 x 2 C	CU	16
	Arandela A 16.2 x 22.4 x 1.4 C	CU	4
	Arandela A 19 x 22.4 x 1.4 C	CU	2
	Arandela A 19 x 28.5 x 1.8 C	CU	2
	Arandela A 22.2 x 28.5 x 1.8 C	CU	2
	Arandela A 8 x 12.2 x 1.5 A	AL	15
	Arandela A 8.2 x 13 x 1.5 A	AL	24
	Arandela A 22 x 27 x 1.5 A	AL	2
	Anillo de goma G 41 x 50 x 3	GS	2
	Anillo A 45 x 50 x 1.4 PL	PLAST	6
	Anillo A 38 x 43 x 1.5 PL	PLAST	12
	Anillo A 30 x 35 x 1 PL	PLAST	2
	Anillo G 116 x 3.5	GS	1
	Guarnición goma G 23 x 32 x 5	GS	6
	Anillo de goma G 22 x 28 x 3	GS	2
	Anillo de goma G 28 x 4	GS	6
	Anillo de goma G 65 x 7	GS	1
	Anillo de goma G 58 x 7	GS	1
	Anillo G 95 x 100 x 3.5	GS	1
	Anillo G 15 x 20 x 3	GS	6
	Anillo G 71 x 78 x 4	GS	
	Anillo G 28 x 34 x 4.6	GS	1
	O´ring G 55 x 3	GS	2
	O´ring G 22 x 3	GS	1
	O´ring G 19 x 3	GS	2
	O´ring G 65 x 3	GS	1

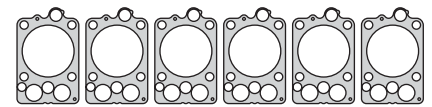

880108



880110



880131



880036

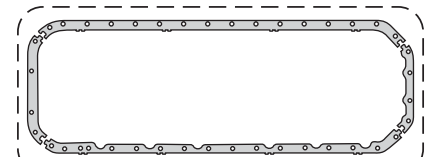

880011



880115

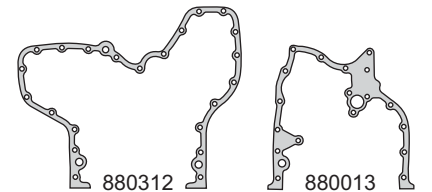

880312

880013

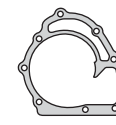

880214

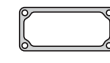

880117



880233

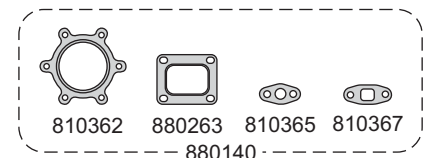

810362

880263

810365

810367

880140



880240



880046



880241



880039



G 75 x 81.8 x 4.5



A 16.2 x 22.4 x 1.4 C



A 19 x 22.4 x 1.4 C



A 14 x 24 x 2 C



A 22 x 27 x 1.5 A



A 22.2 x 28.5 x 1.8 C



A 8 x 12.2 x 1.5 A



A 19 x 28.5 x 1.8 C



A 10 x 16.2 x 1.5 C

VOLVO



Motor/Engine	Cm³	HP	Ø
TD 100G/101G 101F (OHV) 12V	9600	273/300	120.6
DIESEL			

Volvo: N10 1985/89



Nº OE	Descripción/Description	Mat.	Ref.
	Jgo. de juntas para motor		880300-R
270.789	Junta tapa cilindros Ø 136.5 ± 1.40	ACG	6 880008
424693.0	Junta tapa válvulas superior	GS	6 880010
799.264	Jgo. junta para cárter (4)	NB	1 880311
468.116	Delantera de distribución	NB	880012
467.177	Delantera de distribución	NB	880312
468.557	Placa de distribución	NB	1 880013
	Bomba de agua	NB	1 880214
	Bomba de agua	NB	1 880314
479.107	Jgo. múltiple escape (6)	NFT	1 880015
424.618	Múltiple admisión	NFT	1 880017
423.352	Tapa bomba de agua	CB	1 880319
	Junta válvula termostato	CB	1 880431
424694.8	Tapa de válvulas inferior	GS	6 880031
	Guarnición goma grafitada	GFT	6 880233
	Lateral tapa de válvulas	GS	3 880036
	Guarnición goma (verde claro)	GS	6 880039
	Kit de turbina (bipartida) (4)	VS	1 880040
	Anillo fieltro	FIE	1 880240
	Guarnición goma	GS	1 880241
	Pico metálico	AC	1 880342
	Kit de arandelas (84)	VS	1 880347
	Kit de gomas (96)	VS	1 880348
	Turbina turbo	AC	1 810362
	Base turbo	AC	1 810363
	Entrada de aceite a turbo	NB	1 810365
	Entrada turbo	NB	1 810367
	Anillo múltiple de escape G 75 x 81 x 4.5	GS	6
	Arandela A 8 x 12 x 1 C	CU	16
	Arandela A 10 x 16 x 1.5 C	CU	5
	Arandela A 12 x 20 x 1.5 C	CU	9
	Arandela A 14 x 24 x 2 C	CU	18
	Arandela A 16 x 20 x 1.5 C	CU	4
	Arandela A 18 x 22 x 1.5 C	CU	4
	Arandela A 19 x 27 x 2 C	CU	2
	Arandela A 22 x 28 x 1.5 A	AL	2
	Arandela A 24.4 x 31 x 1.8 C	CU	
	Arandela A 10 x 14.5 x 1.5 A	AL	
	Arandela A 22 x 27 x 1.5 A	AL	
	Arandela A 8 x 15 x 1.5 C	CU	24
	Anillo de goma G 41 x 50 x 3	GS	1
	Anillo A 45 x 50 x 1.4 PL	PLAST	6
	Anillo A 38 x 43 x 1.5 PL	PLAST	12
	Anillo A 30 x 35 x 1 PL	PLAST	2
	Anillo G 116 x 3.5	GS	1
	Guarnición goma G 23 x 32 x 5	GS	6
	Guarnición goma G 22 x 28 x 3	GS	2
	Guarnición goma G 19 x 28 x 7	GS	1
	Guarnición goma G 58 x 7	GS	1
	Guarnición goma G 65 x 7	GS	1
	Anillo G 95 x 100 x 3.5	GS	1
	Anillo G 15 x 20 x 3	GS	6
	Anillo G 24 x 32 x 5	GS	2

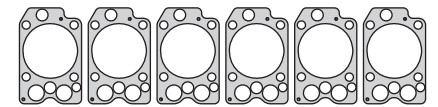

880008

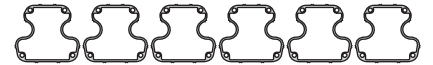

880010

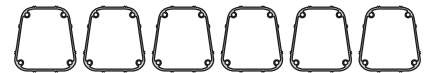

880031



880036

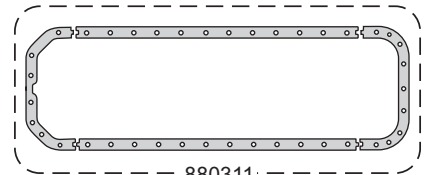

880311



880015

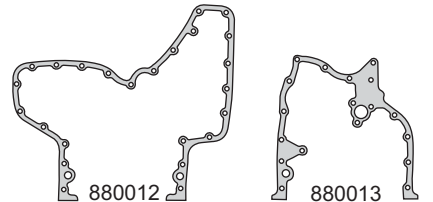

880012

880013

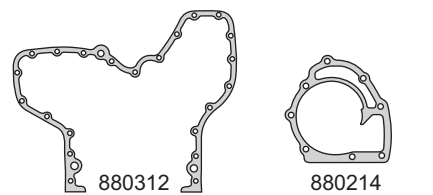

880312

880214

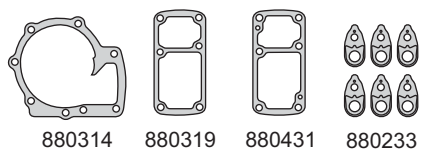

880314

880319

880431

880233

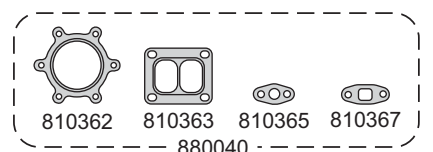

810362

810363

810365

810367

880040



880017

880039

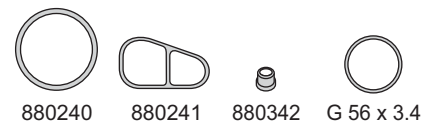

880240

880241

880342

G 56 x 3.4



G 75 x 81 x 4.5



A 16 x 20 x 1.5 C

A 10 x 16 x 1.5 C



A 14 x 24 x 2 C

VOLVO



Motor/Engine	Cm³	HP	Ø
TD 100G/101G 101F (OHV) 12V	9600	273/300	120.6

Volvo: N10 1985/89



DIESEL

Nº OE	Descripción/Description	Mat.	Ref.
	Anillo G 28 x 34 x 4.6	GS	1
	Anillo G 25 x 29 x 3	GS	1
	Anillo G 23 x 28 x 5	GS	2
	Anillo G 18 x 28 x 7	GS	1
	Anillo G 41 x 57 x 3	GS	1
	Anillo G 71 x 78 x 4	GS	1
	O´ring G 86 x 3	GS	1
	O´ring G 55 x 3	GS	1
	O´ring G 60 x 3	GS	2
	O´ring G 34 x 3	GS	3
	O´ring G 24 x 2.5	GS	1
	O´ring G 64 x 3	GS	1
	O´ring G 56 x 3.4	GS	
	Kit de retenes completo		R880000
	Retén bancada 155 x 180 x 15	V	1 R880011V
	Retén distribución 85.72 x 114.33 x 13	V	1 R880012V
	Retén árbol de levas 30 x 50 x 7.5	V	1 R340312V

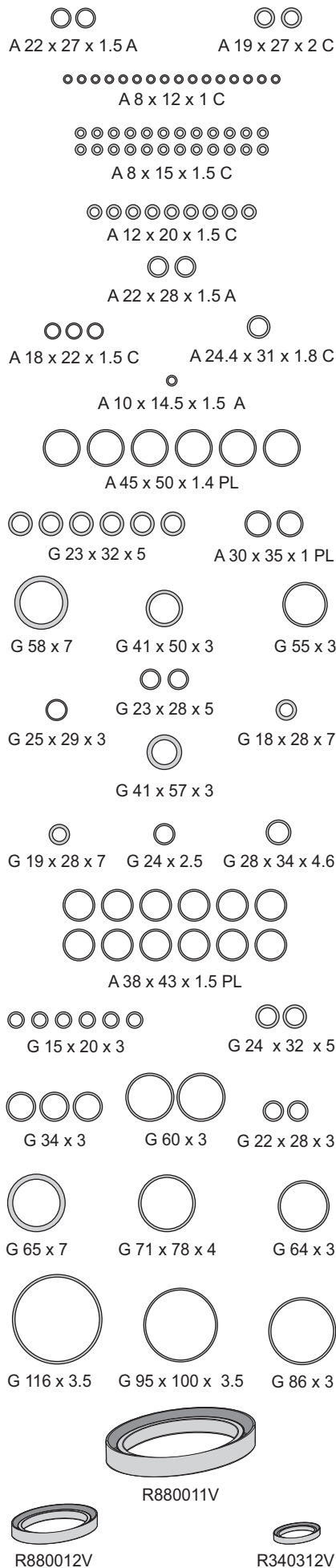

VOLVO**taranto**

Motor/Engine

Cm³

HP

Ø

Volvo: N12 1980/89

TD 121G/120GA
121F
(OHV) 12V11950
11950295/360
328/385130.2
130.2

DIESEL



Nº OE	Descripción/Description	Mat.	Ref.
	Jgo. de juntas para motor		880400-R
270.548	Junta tapa cilindros Ø 147.5 \pm 1.40	ACG 6	880308
	Jgo. tornillos tapa cilindros (HAS21038)		B880400
424692.2	Junta tapa válvulas	GS 6	880410
478.505	Jgo. junta para cárter (4)	NB 1	880411
468.116	Delantera de distribución	NB 1	880012
468.557	Placa de distribución	NB 1	880013
	Bomba de agua	NB 1	880314
479.107	Jgo. múltiple escape (6)	NFT 1	880015
422.616	Junta admisión	NFT 1	880117
423.352	Tapa bomba de agua	CB 1	880319
	Junta válvula termostato	CB 1	880419
1545244	Junta válvula termostato	CB 2	880431
	Lateral tapa de válvulas	GS 3	880036
	Guarnición goma (verde claro)	GS 6	880039
	Kit de turbina (un agujero) (4)	VS	880140
	Anillo de fieltro	FIE 1	880240
	Guarnición goma	GS 1	880741
	Anillo G 18 x 23 x 3	GS 2	880046
	Kit de arandelas (72)	VS 1	880447
	Kit de gomas (87)	VS 1	880448
	Turbina turbo	AC 1	810362
	Junta salida escape a turbo	AC	880263
	Entrada de aceite a turbo	NB 1	810365
	Entrada turbo	NB 1	810367
	Anillo múltiple de escape G 79 x 86 x 4.5	GS 6	
	Arandela A 8 x 12 x 1 C	CU 15	
	Arandela A 10 x 16 x 1.5 C	CU 5	
	Arandela A 12 x 20 x 1.5 C	CU 4	
	Arandela A 14 x 24 x 2 C	CU 21	
	Arandela A 16 x 22 x 1.5 C	CU 1	
	Arandela A 18 x 22 x 1.5 C	CU 2	
	Arandela A 20 x 24 x 1.5 C	CU 1	
	Arandela A 22 x 28 x 1.5 C	CU 4	
	Arandela A 24 x 30 x 2 C	CU 1	
	Arandela A 8 x 12 x 1.5 A	AL 14	
	Arandela A 10 x 14 x 1.5 A	AL 2	
	Arandela A 22 x 27 x 1.5 A	AL 2	
	Anillo de goma G 41 x 50 x 3	GS 1	
	Anillo A 30 x 35 x 1 PL	PLAST	
	Anillo A 45 x 50 x 1.5 PL	PLAST 6	
	Anillo A 38 x 43 x 1.4 PL	PLAST 12	
	Anillo G 116 x 3.5	GS 1	
	Guarnición goma G 23 x 32 x 5	GS 6	
	Anillo de goma G 22 x 28 x 3	GS 2	
	Anillo de goma G 19 x 28 x 7	GS 1	
	Anillo G 95 x 100 x 3.5	GS 1	
	Anillo G 15 x 20 x 3	GS 6	
	Anillo G 28 x 32 x 3.8	GS 6	
	Anillo G 24 x 32 x 5	GS 2	
	Anillo G 24 x 30 x 3	GS 2	
	Anillo G 71 x 78 x 4	GS 1	
	Anillo G 46 x 55 x 4.5	GS 1	

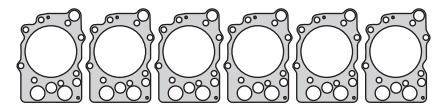

880308



880410



880036

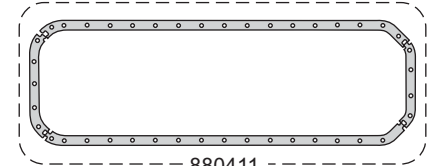

880411



880015

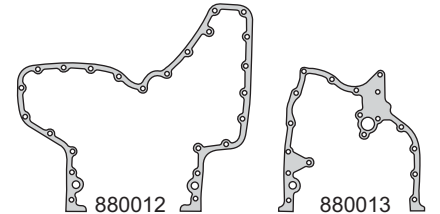

880012

880013

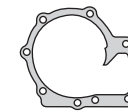

880314

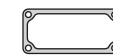

880117

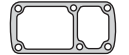

880319

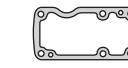

880419

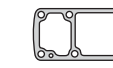

880431

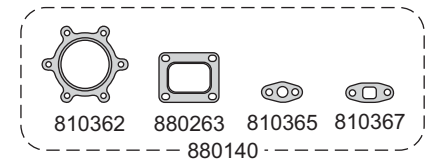

810362

880263

810365

810367

880140



880741



880039



880046



880240

G 19 x 28 x 7

G 22 x 28 x 3



G 79 x 86 x 4.5



A 14 x 24 x 2 C



A 12 x 20 x 1.5 C

A 10 x 16 x 1.5 C



A 8 x 12 x 1.5 A

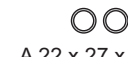

A 22 x 27 x 1.5 A



A 18 x 22 x 1.5 C

VOLVO



Motor/Engine **Cm³** **HP** **Ø**

TD 121G/120GA **11950** **295/360** **130.2**
121F **11950** **328/385** **130.2**
(OHV) 12V

Volvo: N12 1980/89

DIESEL



Nº OE	Descripción/Description	Mat.	Ref.
	Anillo G 28 x 34 x 4.6	GS 1	
	Anillo G 25 x 29 x 3	GS 1	
	Anillo G 41 x 57 x 3	GS 1	
	O´ring G 86 x 3	GS 1	
	O´ring G 55 x 3	GS 2	
	O´ring G 60 x 3	GS 1	
	O´ring G 22 x 3	GS 1	
	O´ring G 24 x 2.5	GS 2	
	O´ring G 19 x 3	GS 1	
	O´ring G 34 x 3	GS 3	
	Kit de retenes completo		R880000
	Retén bancada 155 x 180 x 15	V 1	R880011V
	Retén distribución 85.72 x 114.33 x 13	V 1	R880012V
	Retén árbol de levas 30 x 50 x 7.5	V 1	R340312V

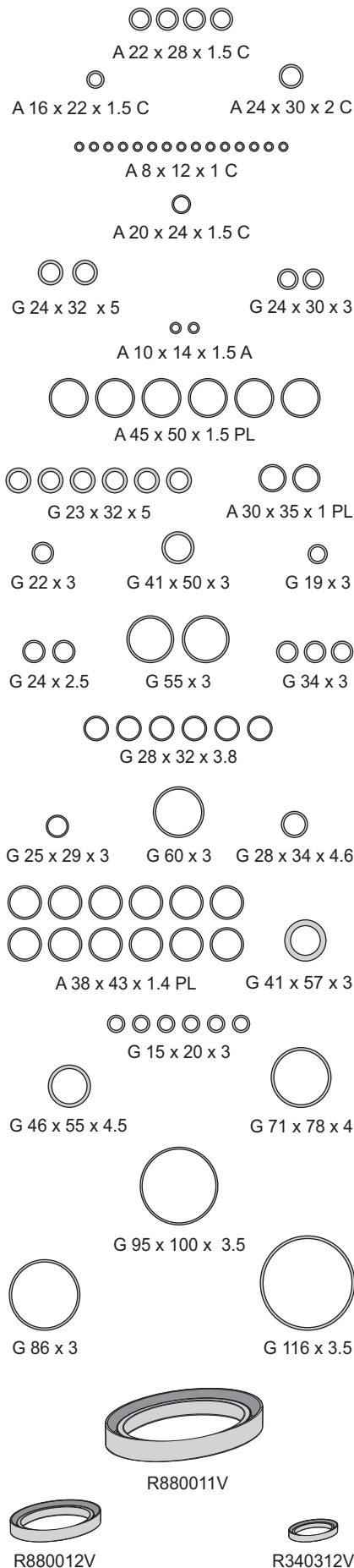

VOLVO



Motor/Engine	Cm³	HP	Ø
EDC	9600		120.6
DIESEL			

Volvo: NL10 1998/...



Nº OE	Descripción/Description	Mat.	Ref.
	Jgo. de juntas para motor		880500-R
270.789	Junta tapa cilindros Ø 136.5 ± 1.40	ACG 6	880008
423145.2	Junta tapa válvulas	GS 6	880010
479.264	Jgo. junta para cárter (4)	NB 1	880311
468.116	Delantera de distribución	NB 1	880012
468.557	Placa de distribución	NB 1	880013
423.127	Bomba de agua	NB 1	880214
479.107	Jgo. múltiple escape (6)	NFT 1	880015
424.618	Junta admisión	NFT 1	880017
424694.8	Junta tapa de válvulas	GS 6	880031
	Guarnición goma grafitada	GFT 6	880233
	Lateral tapa de válvulas	GS 3	880036
	Guarnición goma (verde claro)	GS 6	880039
	Kit de turbina (Bipartida) (4)	VS 1	880040
	Guarnición goma	GS 1	880241
	Anillo G 16 x 22 x 3	GS 6	880542
	Kit de arandelas (85)	VS 1	880547
	Kit de borracha (89)	VS 1	880548
	Turbina turbo	AC 1	810362
	Base turbo	AC 1	810363
	Entrada de aceite a turbo	NB 1	810365
	Entrada turbo	NB 1	810367
	Anillo múltiple escape G 75 x 81.8 x 4.5	GS 6	
	Arandela A 8 x 12 x 1 C	CU 27	
	Arandela A 10 x 16 x 1 C	CU 1	
	Arandela A 10 x 16 x 1.5 C	CU 1	
	Arandela A 12 x 20 x 1.5 C	CU 6	
	Arandela A 14 x 24 x 2 C	CU 20	
	Arandela A 16 x 22 x 1.5 C	CU 1	
	Arandela A 18 x 22 x 1.5 C	CU	
	Arandela A 18 x 27 x 2 A	AL 2	
	Arandela A 20 x 24 x 1.5 C	CU 1	
	Arandela A 22 x 28 x 2 C	CU	
	Arandela A 24 x 31 x 1.8 C	CU	
	Arandela A 22 x 27 x 1.5 A	AL 2	
	Arandela A 8 x 15 x 1.5 C	CU 24	
	Anillo de goma G 41 x 50 x 3	GS 1	
	Anillo A 45 x 50 x 1.4 PL	PLAST 6	
	Anillo A 38 x 43 x 1.5 PL	PLAST 12	
	Anillo A 30 x 35 x 1 PL	PLAST 1	
	Anillo G 116 x 3.5	GS 1	
	Guarnición goma G 23 x 32 x 5	GS 6	
	Anillo de goma G 22 x 28 x 3	GS 2	
	Anillo de goma G 19 x 28 x 7	GS 1	
	Anillo G 95 x 100 x 3.5	GS 1	
	Anillo G 15 x 20 x 3	GS 6	
	Anillo G 24 x 32 x 5	GS 2	
	Anillo G 71 x 78 x 4	GS 1	
	Anillo G 28 x 34 x 4.6	GS 1	
	Anillo G 25 x 29 x 3	GS 1	
	Anillo G 41 x 57 x 3	GS 1	
	O´ring G 86 x 3	GS 1	
	O´ring G 55 x 3	GS 2	

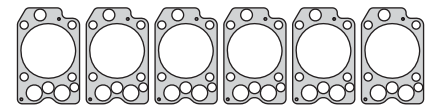

880008

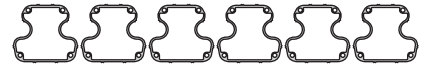

880010



880031



880036

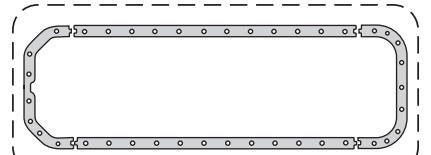

880311



880015

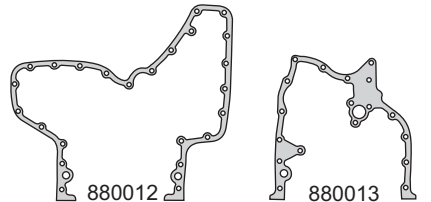

880012

880013

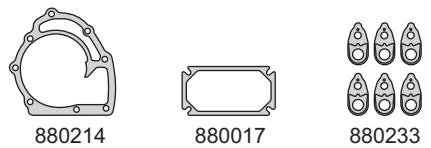

880214

880017

880233

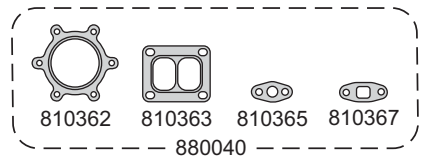

810362

810363

810365

810367

880040



880542

880039



880241

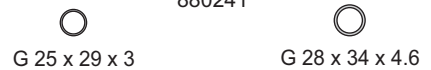

G 25 x 29 x 3

G 28 x 34 x 4.6



G 75 x 81.8 x 4.5

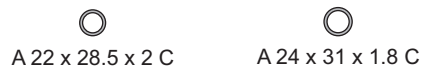

A 22 x 28.5 x 2 C

A 24 x 31 x 1.8 C



A 14 x 24 x 2 C



A 22 x 27 x 1.5 A

A 18 x 27 x 2 A



A 8 x 15 x 1.5 C

VOLVO



Motor/Engine	Cm³	HP	Ø
TD 102F/102FS (OHV) 12V	9600	234/317	120.6
DIESEL			

Volvo: NL10 1989/97



Nº OE	Descripción/Description	Mat.	Ref.
	Jgo. de juntas para motor		880600-R
270.789	Junta tapa cilindros Ø 136.5 ± 1.40	ACG 6	880008
424693.0	Junta tapa válvulas	GS 6	880010
479.264	Jgo. junta para cárter (4)	NB 1	880311
468.116	Delantera de distribución	NB 1	880012
468.557	Placa de distribución	NB 1	880013
423.127	Bomba de agua	NB 1	880214
479.107	Jgo. múltiple escape (6)	NFT 1	880015
424.618	Junta admisión	NFT 1	880017
424694.8	Junta tapa de válvulas	GS 6	880031
	Guarnición goma grafitada	GFT 6	880233
	Lateral tapa de válvulas	GS 3	880036
	Guarnición goma (verde claro)	GS 6	880639
	Kit turbina (Bipartida) (4)	VS 1	880040
	Guarnición goma	GS 1	880241
	Pico metálico	AL 1	880342
	Anillo G 76 x 82 x 4.5	GS 1	880742
	Anillo G 18 x 23 x 3	GS 1	880046
	Kit de arandelas (101)	VS 1	880647
	Kit de gomas (88)	VS 1	880648
	Turbina turbo	AC 1	810362
	Base turbo	AC 1	810363
	Entrada aceite a turbo	NB 1	810365
	Entrada turbo	NB 1	810367
	Anillo múltiple de escape G 75 x 81.8 x 4.5	GS 6	
	Arandela A 8 x 12 x 1 C	CU 28	
	Arandela A 10 x 16 x 1.5 C	CU 6	
	Arandela A 12 x 20 x 1.5 C	CU 5	
	Arandela A 14 x 24 x 2 C	CU 24	
	Arandela A 16 x 22 x 1.5 C	CU 2	
	Arandela A 18 x 22 x 1.5 C	CU 5	
	Arandela A 19 x 27 x 2 A	AL 2	
	Arandela A 20 x 24 x 1.5 C	CU	
	Arandela A 22 x 28 x 2 C	CU	
	Arandela A 24 x 30 x 1.5 C	CU 1	
	Arandela A 10 x 14 x 1.5 A	AL 2	
	Arandela A 22 x 26 x 1.5 C	CU 2	
	Arandela A 8 x 15 x 1.5 C	CU 24	
	Anillo de goma G 41 x 50 x 3	GS 1	
	Anillo A 45 x 50 x 1.5 PL	PLAST 6	
	Anillo A 30 x 35 x 1 PL	PLAST 2	
	Anillo A 38 x 43 x 1.4 PL	PLAST 12	
	Anillo G 116 x 3.5	GS 1	
	Guarnición goma G 23 x 32 x 5	GS 6	
	Anillo de goma G 22 x 28 x 3	GS 2	
	Anillo de goma G 19 x 28 x 7	GS 1	
	Anillo G 95 x 100 x 3.5	GS 1	
	Anillo G 15 x 20 x 3	GS 6	
	Anillo G 24 x 32 x 5	GS 2	
	Anillo G 28 x 34 x 4.6	GS 1	
	Anillo G 25 x 29 x 3	GS 1	
	Anillo G 41 x 57 x 3	GS 1	
	Anillo G 30 x 38 x 16.6	GS 1	

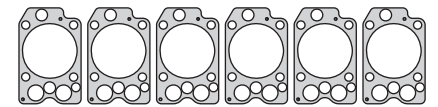

880008

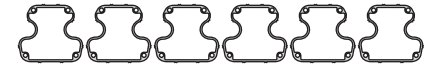

880010



880031



880012

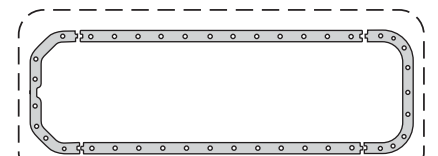

880013



880214

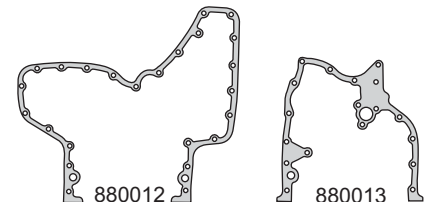

880015

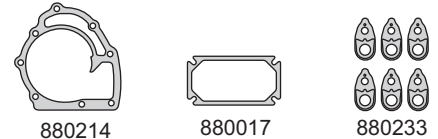

880214

880017

880233



880639

880241

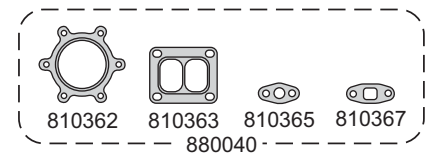

810362

810363

810365

810367

880040



880342

880742

880046



G 75 x 81.8 x 4.5



A 22 x 28 x 2 C

A 19 x 27 x 2 A

A 18 x 22 x 1.5 C

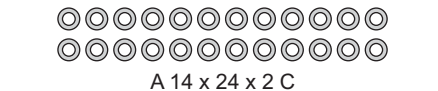

A 14 x 24 x 2 C



A 10 x 16 x 1.5 C

A 16 x 22 x 1.5 C

A 22 x 26 x 1.5 C

VOLVO



Motor/Engine	Cm³	HP	Ø
EDC	11950		120.6
DIESEL			

Volvo: NL12 1997/...



Nº OE	Descripción/Description	Mat.	Ref.
	Jgo. de juntas para motor		880700-R
270.548	Junta tapa cilindros Ø 147.5 ± 1.40	ACG 6	880308
	Jgo. tornillos tapa cilindros (HAS21038)		B880400
424692.2	Junta tapa de válvulas	GS 6	880410
478.505	Jgo. junta para cárter (4)	NB 1	880411
468.116	Delantera distribución	NB 1	880012
468.557	Placa de distribución	NB 1	880013
	Bomba de agua	NB 1	880314
479.107	Jgo. múltiple escape (6)	NFT 1	880015
424.618	Junta admisión	NFT 1	880017
	Junta válvula termostato	CB 1	880419
	Lateral tapa de válvulas	GS 3	880036
	Guarnición goma (verde claro)	GS 6	880039
	Kit de turbina (un agujero) (4)	VS	880140
	Guarnición goma	GS 1	880741
	Anillo G 16 x 22 x 3	GS	880542
	Kit de arandelas (70)	VS 1	880747
	Kit de gomas (82)	VS 1	880748
	Turbina turbo	AC 1	810362
	Base turbo	AC	880263
	Entrada aceite a turbo	NB 1	810365
	Entrada turbo	NB 1	810367
	Anillo múltiple de escape G 79 x 86 x 4.5	GS 6	
	Arandela A 8 x 12 x 1 C	CU 25	
	Arandela A 10 x 16 x 1.5 C	CU 5	
	Arandela A 12 x 20 x 1.5 C	CU 1	
	Arandela A 14 x 24 x 2 C	CU 21	
	Arandela A 16 x 22 x 1.5 C	CU 4	
	Arandela A 18 x 22 x 1.5 C	CU 2	
	Arandela A 19 x 27 x 2 C	CU	
	Arandela A 20 x 24 x 1.5 C	CU 2	
	Arandela A 22 x 28 x 2 C	CU 2	
	Arandela A 24 x 30 x 2 C	CU 2	
	Arandela A 8 x 13 x 1.5 A	AL	
	Arandela A 10 x 14 x 1.5 A	AL 4	
	Arandela A 22 x 27 x 1.5 A	AL 2	
	Anillo de goma G 41 x 50 x 3	GS 1	
	Anillo A 45 x 50 x 1.4 PL	PLAST 6	
	Anillo A 38 x 43 x 1.5 PL	PLAST 12	
	Anillo G 116 x 3.5	GS 1	
	Guarnición goma G 26.5 x 32 x 3	GS 6	
	Anillo de goma G 22 x 28 x 3	GS 2	
	Anillo de goma G 19 x 28 x 7	GS 1	
	Anillo G 95 x 100 x 3.5	GS 1	
	Anillo G 15 x 20 x 3	GS 6	
	Anillo G 28 x 32 x 3.8	GS 6	
	Anillo G 24 x 32 x 5	GS 2	
	Anillo G 24 x 30 x 3	GS 2	
	Anillo G 71 x 78 x 4	GS 1	
	Anillo G 28 x 34 x 4.6	GS 1	
	Anillo G 25 x 29 x 3	GS 2	
	Anillo G 41 x 57 x 3	GS 1	
	O´ring G 86 x 3	GS 1	

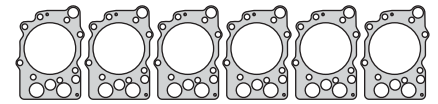

880308



880410



880036

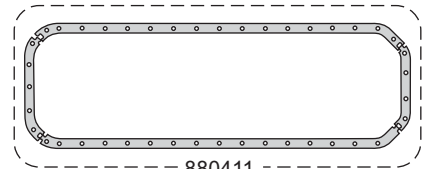

880411



880015

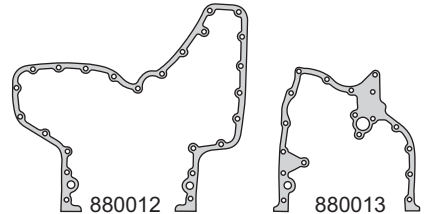

880012

880013

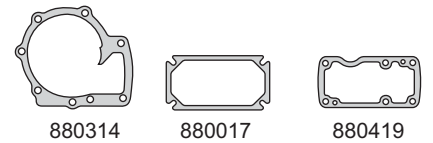

880314

880017

880419

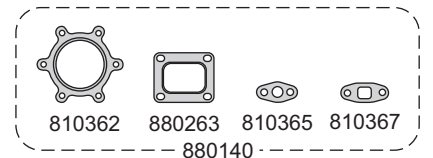

810362

880263

810365

810367

880140



880039

880741

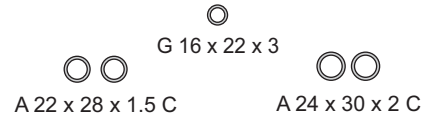

G 16 x 22 x 3

A 22 x 28 x 1.5 C

A 24 x 30 x 2 C

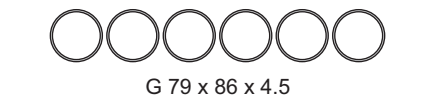

G 79 x 86 x 4.5



A 18 x 22 x 1.5 C

A 22 x 27 x 1.5 A

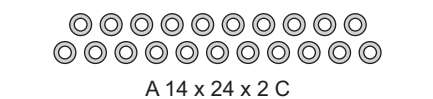

A 14 x 24 x 2 C

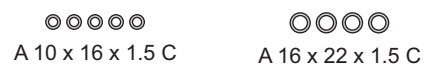

A 10 x 16 x 1.5 C

A 16 x 22 x 1.5 C

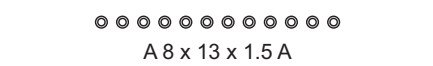

A 8 x 13 x 1.5 A



A 12 x 20 x 1.5 C

A 19 x 27 x 2 C

VOLVO**taranto**

Motor/Engine	Cm³	HP	Ø
TD 122FS (OHV) 12V	11950	396	130.2

Volvo: NL12 1989/96

DIESEL



Nº OE	Descripción/Description	Mat.	Ref.
	Jgo. de juntas para motor		880800-R
270.548	Junta tapa cilindros Ø 147.5 ± 1.40	ACG	6 880308
	Jgo. tornillos tapa cilindros (HAS21038)		B880400
424692.2	Junta tapa válvulas	GS	6 880410
478.505	Jgo. junta para cárter (4)	NB	1 880411
468.116	Delantera de distribución	NB	1 880012
468.557	Placa de distribución	NB	1 880013
	Bomba de agua	NB	1 880314
479.107	Jgo. múltiple escape (6)	NFT	1 880015
424.618	Junta admisión	NFT	1 880017
423.352	Junta válvula termostato	CB	1 880419
	Lateral tapa de válvulas	GS	3 880036
	Guarnición goma (verde claro)	GS	6 880039
	Kit de turbina (un agujero) (4)	VS	880140
	Anillo de fieltro	FIE	1 880240
	Guarnición goma	GS	1 880741
	Anillo G 16 x 22 x 3	GS	1 880542
	Kit de arandelas (74)	VS	1 880847
	Kit de gomas (93)	VS	1 880848
	Turbina turbo	AC	1 810362
	Base turbo	AC	880263
	Entrada aceite a turbo	NB	1 810365
	Entrada turbo	NB	1 810367
	Anillo múltiple de escape G 79 x 86 x 4.5	GS	6
	Arandela A 8 x 12 x 1 C	CU	15
	Arandela A 10 x 16 x 1.5 C	CU	5
	Arandela A 12 x 20 x 1.5 C	CU	4
	Arandela A 14 x 24 x 2 C	CU	21
	Arandela A 16 x 22 x 1.5 C	CU	1
	Arandela A 18 x 22 x 1.5 C	CU	2
	Arandela A 19 x 27 x 2 A	AL	1
	Arandela A 20 x 24 x 1.5 C	CU	1
	Arandela A 22 x 28 x 1.5 C	CU	5
	Arandela A 24 x 30 x 2 C	CU	1
	Arandela A 8 x 12 x 1.5 A	AL	14
	Arandela A 10 x 14 x 1.5 A	AL	2
	Arandela A 22 x 27 x 1.5 A	AL	2
	Anillo de goma G 41 x 50 x 3	GS	
	Anillo A 45 x 50 x 1.5 PL	PLAST	6
	Anillo A 38 x 43 x 1.4 PL	PLAST	12
	Anillo G 116 x 3.5	V	1
	Guarnición goma G 23 x 32 x 5	GS	6
	Anillo de goma G 22 x 28 x 3	GS	2
	Anillo de goma G 19 x 28 x 7	GS	1
	Anillo G 95 x 100 x 3.5	GS	1
	Anillo G 15 x 20 x 3	GS	6
	Anillo G 28 x 32 x 3.8	GS	6
	Anillo G 24 x 32 x 5	GS	2
	Anillo G 24 x 30 x 3	GS	2
	Anillo G 71 x 78 x 4	GS	1
	Anillo G 46 x 55 x 4.5	GS	1
	Anillo G 28 x 34 x 4.6	GS	1
	Anillo G 25 x 29 x 3	GS	1

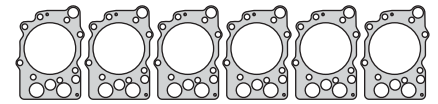

880308



880410



880036

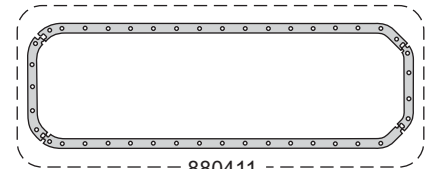

880411



880015

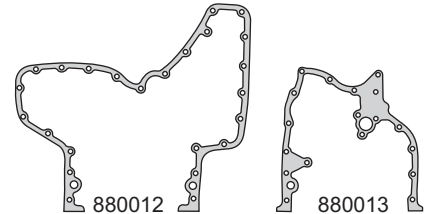

880012

880013

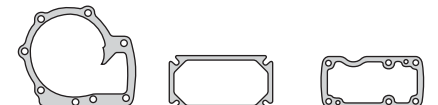

880314

880017

880419

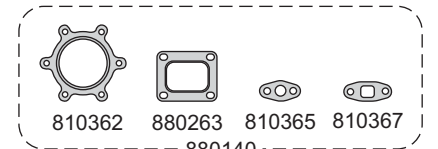

810362

880263

810365

810367

880140



880039

880741



880542

880240

G 22 x 3

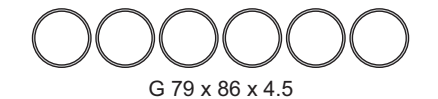

G 79 x 86 x 4.5



A 10 x 16 x 1.5 C

A 16 x 22 x 1.5 C

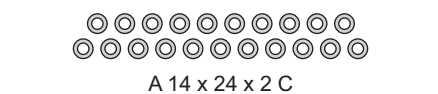

A 14 x 24 x 2 C



A 19 x 27 x 2 A



A 12 x 20 x 1.5 C

A 22 x 28 x 1.5 C



G 28 x 32 x 3.8

VOLVO



Motor/Engine **Cm³** **HP** **Ø**

TD 122FS **11950** **396** **130.2**
(OHV) 12V

Volvo: NL12 1989/96

DIESEL



Nº OE	Descripción/Description	Mat.	Ref.
	Anillo G 41 x 57 x 3	GS 2	
	Anillo G 12 x 20 x 5	GS 6	
	O´ring G 86 x 3	GS 1	
	O´ring G 55 x 3	GS 2	
	O´ring G 60 x 3	GS 1	
	O´ring G 34 x 3	GS 3	
	O´ring G 22 x 3	GS 1	
	O´ring G 24 x 2.5	GS 2	
	O´ring G 19 x 3	GS 2	
	Kit de retenes completo		R880000
	Retén bancada 155 x 180 x 15	V 1	R880011V
	Retén distribución 85.72 x 114.33 x 13	V 1	R880012V
	Retén árbol de levas 30 x 50 x 7.5	V 1	R340312V

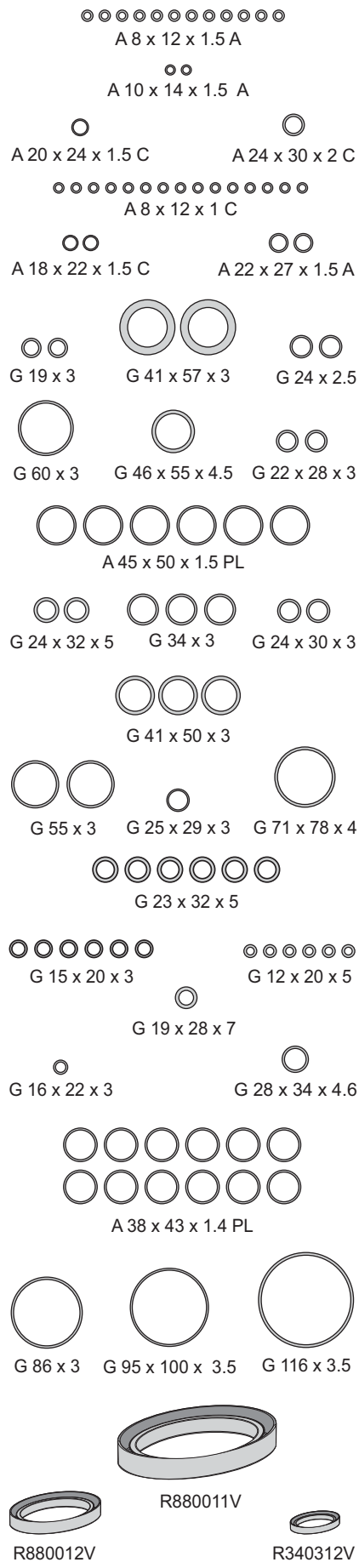



Sellador Líquido (caucho de silicona)

- ▶ Creado para aplicaciones de gran fuerza de torsión.
- ▶ Resistencia al aceite a los combustibles, aceites, lubricantes, anticongelantes y gases.
- ▶ Resiste golpes y vibraciones.
- ▶ No recomendado para sellar tapas de cilindros.

Kit de llaves especiales HAK12-38 / HAK639512-111

- ▶ El Kit HAK 2-38 contiene todos los tipos y medidas de herramientas necesarios para el trabajo sobre vehículos de última generación. Los Tubos con Punta de Alta Resistencia son fabricados en acero Cromo Vanadio con doble cromado y moletado para mejorar el agarre. Encastre de 12.7mm. Con espacio para bola de retención.
- ▶ El Kit HAK639512-111 contiene 111 Tubos y llaves SmarDriv encastre de 1/4", 3/8" y 1/2". Forjados en acero especial, niquelados y cromados anticorrosión.



Torquímetro - Goniómetro

- ▶ HTORQ-110 / HTORQ-210 / HTORQ-350
Instrumento de medición de torque.
Escala de apriete simple para facilitar el uso.
- ▶ HGONIOMETRO / HGONIOMETRO-M
Diseñado especialmente para facilitar el apriete angular de los tornillos de tapa de cilindro.



Sistemas de Embrague

- ▶ Suavidad de acople en arranques y cambios de velocidades.
- ▶ Transmisión de fuerza garantizada. Mayor confort.
- ▶ Óptima resistencia térmica. El mejor cambio.





Rua Jair Afonso Inácio 820 (CEP 05136-040)
Jd. Santo Elias
SÃO PAULO - BRASIL
Tel: (55-11) 3901-9090
Fax: (55-11) 3903-6888
e-mail: taranto@taranto.com.br



Mario Bravo 641 (B1868BMM)
Avellaneda
BUENOS AIRES - ARGENTINA
Tel: (54-11) 4135-9000
Fax: (54-11) 4135-9001
e-mail: gaskets@taranto.com.ar



TARANTO MEXICANA, SA de CV
Privada Santa Ana 36 Mz C, Bodega C
Parque Industrial Lerma
52000 Lerma Edo.Mex.
Tel: (52-728) 28-54-145
email: juntas@taranto.com.mx

www.taranto.com.ar

