

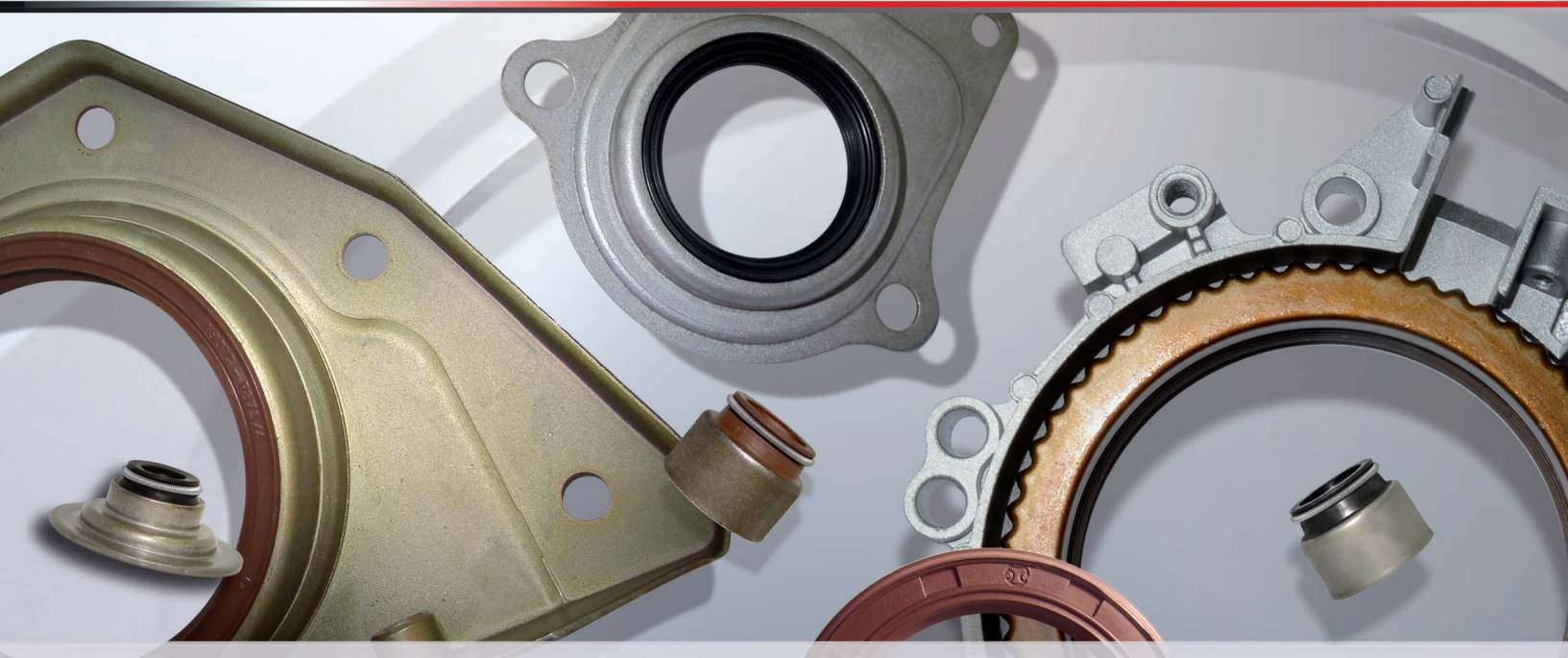

taranto



CATALOGO RETENES 2022



COMO UTILIZAR ESTE CATALOGO

TARANTO actualiza su tecnología en la fabricación de productos para satisfacer las necesidades de la industria automotriz. En este catálogo 2022 se presenta la línea completa de productos, incluyendo los nuevos modelos.

CONTENIDO

✓ Catálogo de Retenes ordenados por Aplicación	Pág. 02	✓ Retenes Radiales ordenados Rueda por Ø Eje	Pág. 152
✓ Descripción Materiales	Pág. 143	✓ Retenes Radiales ordenados Transmisión por Ø Eje	Pág. 152
✓ Composición Kit de Retenes	Pág. 144	✓ Retenes Guía de Válvulas ordenadas por Ø Eje	Pág. 154
✓ Retenes Radiales ordenados por Ø Eje	Pág. 147	✓ Porta retenes ordenado por Código	Pág. 160

GUIA PARA EL USUARIO





Código Taranto		Descripción de Producto						Tipo	Cilindrada	Juego de Motor que aplica		
Código Code	Cant. Qty	Descripción Descrição Descripción		DE [mm]	DA [mm]	H [mm]	A [mm]	Aplicación Aplicação Application	Cm³ Cm³	Motor Motor Engine	Jgo. Juntas Set Gaskets	
R290210P	1		GUÍA VÁLVULAS R290210P/1	5.97	11.39	11.98		RGV	Lumina, Cavalier 1987/97 SS10 1997/99	2190cc.	LN2 (OHV) 8V	290200-R
R241911P	1		BANCADA	76	92	10		GALGRI	Lumina, Cavalier 1994/97	2190cc.	LM3 8V	290300-R

Tipo de Pieza	Medidas	Marca, Aplicación	Motor
Guía Visual	[DE] Ø de Eje [DA] Ø de Alojamiento [H] Altura [A] Ala	Detalles del vehículo Años de aplicación	Tipo de Motor

INICE ORDENADO POR MARCAS

ACURA	02	DI TELLA	39	KUBOTA	78	ROVER	119
AGRALE	02	DODGE	19	LADA	78	SCANIA	122
ALFA ROMEO	02	DYNAPAC	39	LANCIA	79	SEAT	122
ASIA MOTORS	03	FIAT	39	LAND ROVER	82	SKODA	125
AUDI	04	FIAT IVECO	52	LEYLAND	82	SSANGYOUNG	125
BEDFORD	06	FIAT TRACTOR	53	MASSEY FERGUSON	95	SUBARU	126
BMW	06	FORD	53	MAXION INTERNACIONAL	82	SUZUKI	126
CHERY	06	FORD PESADOS	69	MAZDA	83	TATA	127
CHEVROLET	07	GM - CHEVROLET	07	MERCEDES BENZ	85	TOYOTA	127
CHRYSLER	19	HONDA	72	MINI	88	VALMET	130
CIMARRON	26	HYUNDAI	73	MITSUBISHI	88	VAUXHALL	07
CITROËN	26	IKA	75	MWM	91	VM-BORGWARD	131
CUMMINS	34	INDENOR	75	NISAN	92	VOLKSWAGEN	131
DACIA	34	ISUZU	76	OPEL	07	VOLVO	140
DAEWOO	35	JEEP	19	PERKINS	95	WILLYS	141
DAF	37	JOHN DEERE	77	PEUGEOT	99	YUE YING	141
DAIHATSU	37	KIA	77	RASTROJERO	109		
DEUTZ	38	KOMATSU	78	RENAULT	110		





SIMBOLOS

Descripción de Producto	Simbolos	Descripción de Producto	Simbolos
Kit retenes completo		Retén distribución	
Juego retén de válvulas		Retenes Radiales	
Retén bancada		Porta retén bancada	









CATALOGO DE RETENES

CATALOGO DE RETENTORES - OIL SEAL CATALOG









ACURA

Código Code	Cant. Qty	Descripción Descrição Descrição	DE [mm]	DA [mm]	H [mm]	A [mm]		Aplicación Aplicação Application	Cm³ Cm³	Motor Motor Engine	Jgo. Juntas Set Gaskets
R250211P R250211N	1	 BANCADA	80	100	10		GALGHI	EL 2000/... Integra 1986/89 Integra VTEC 1992/93 Integra 1993/01 Integra GS/RS/LS 1995/95 CL VTEC 1997/98	1396cc. 1590cc. 1678cc. 1797cc. 1834cc. 2156cc.	D14Z1/Z2 (SOHC) 16V D16A1 (DOHC) 16V B17A1 (DOHC) 16V F18C1/C2 (DOHC) 16V B18B1 (DOHC) 16V F22B8 (SOHC) 16V	863000-R MLS 860500-R 863300-R MLS 863300-R MLS 864000-R MLS 860900-R
R860810P	1	 GUÍA VÁLVULAS (16) R860810P/1	5	11	10		RGV	CL VTEC 1997/98	2156cc.	F22B8 (SOHC) 16V	860900-R
R250211P R250211N	1	 BANCADA	80	100	10		GALGHI				
R240411P R240411P/1 R240411V	1	 BANCADA	80	98	10		G1ALGRI	CL VTEC 1997/98 Legend 1991/96	2997cc. 3206cc.	J30A1 (SOHC) 24V V6 C32A1 (SOHC) V6 24V	864800-R MLS 864900-R















AGRALE

R330510V	1	 GUÍA VÁLVULAS (12) R310810V/1	7	10.9	9.5		RGV	Agrale TD, Micro/Buses 6000, Furgovan 2000/...	2796cc.	MWM 4.07 CA DIESEL	330500-R
R330511V	1	 BANCADA	91	111	10		G1ALGRI				
R250811P R250811V R250811N	1	 DISTRIBUCIÓN	64	80	8		G1ALGHD				
R310411P R310411V	1	 BANCADA	110	130	13		GALGHI	Camión TX 1600 1983/...	2942cc.	D229-3 (SOHC) 6V DIESEL	330800-R
R310412P R310412V	1	 DISTRIBUCIÓN	78	100	13		GALGHD				
R310410V	1	 GUÍA VÁLVULAS (8) R310410V/1	9	13.4	11		RGV	7000/7500/8500 8500/9200	4300cc. 4800cc.	4.10 X10 - 4.10T/TCA 4.12TCE (OHV) 8V DIESEL	330400-R 331200-R MLS
R330411V	1	 BANCADA	130	160	12		G1ALGRI				
R310412P R310412V	1	 DISTRIBUCIÓN	78	100	13		GALGHD				









ALFA ROMEO

R260610V R260610VM/1 R260610VM/2 R260610VM/3	1	 GUÍA VÁLVULAS (16) GRANEL (200) GRANEL (200) GRANEL (1000)	7	9.8	10		RGV	145/146/155/156 Twin Spark 1996/... 145/146 Twin Spark 1996/... 156 Twin Spark 1997/... 145 Twin Spark 1996/... 145/146/156 Twin Spark GTV Twin Spark 1998/00 Spider Twin Spark 1998/00	1598cc. 1598cc.	676.01 (DOHC) 16V 321.02 - 676.01 (DOHC) 16V 671.06 /99 (DOHC) 16V 322.01 (DOHC) 16V	270600-R 271800-R 270600-R 271800-R
R260111P R260111V	1	 BANCADA	74	90	10		G1ALGRI		1747cc. 1747cc		
R260112P R260112V	1	 DISTRIBUCIÓN	30	43	8		G1ALGHD				
R270612V	1	 DISTRIBUCIÓN	55	68	8		GALGHD				
R260113P R260113P/1 R260113V	1	 ÁRBOL DE LEVAS	30	42	7		GALGHD				
R270614V	1	 ÁRBOL DE LEVAS AUXILIAR	30	44	8		GALGHI				
R270615V	1	 ÁRBOL DE LEVAS AUXILIAR	31	41	7		GALGHD				
PR270911V	1	 PORTA BANCADA	93				PORTA	145/146 Twin Spark 1996/... 156 Twin Spark 1997/... GTV Twin Spark 1998/00 Spider Twin Spark 1998/00	1598cc. 1747cc.	321.02 - 676.01 322.01 (DOHC) 16V	271800-R

ALFA ROMEO

Código Code	Cant. Qty	Descripción Descrição Descrição	DE [mm]	DA [mm]	H [mm]	A [mm]		Aplicación Aplicação Application	Cm³ Cm³	Motor Motor Engine	Jgo. Juntas Set Gaskets				
R291010V	1	 GUÍA VÁLVULAS (16) R291010V/1	5	7.8	15.5	23	RGV	159 2005/...	1796cc.	939A4 (DOHC) 16V	291000-R MLS				
PR291011T	1	 PORTA BANCADA	79				PORTA								
R230512P R230512P/1 R230512V	1	 DISTRIBUCIÓN	32	42	7		G1ALGHD								
R240013P R240013P/1 R240013V	2	 ÁRBOL DE LEVAS	35	48	7		GALGHD								
R250410V R250410VM/1 R250410VM/2 R250410VM/3	1	 GUÍA VÁLVULAS (8) A GRANEL (200) A GRANEL (200) A GRANEL (1000)	8	10.8	10		RGV	156 TD 1997/00, 145 TD 146 TD 1999/...	1910cc.	323.02 (SOHC) 8V DIESEL	252101-R				
R252012V	1	 DISTRIBUCIÓN	31	41	7		G1ALGHD								
R260113P R260113P/1 R260113V	1	 ÁRBOL DE LEVAS	30	42	7		GALGHD								
R260400	1	 KIT DE RETENES					JUEGO					146 TD 1994/99, 155 TD 1993/97	1929cc.	675.01 - 336.01 (SOHC) 8V DIESEL	260401-R (270000)
R250410V R250410VM/1 R250410VM/2 R250410VM/3	1	 GUÍA VÁLVULAS (8) A GRANEL (200) A GRANEL (200) A GRANEL (1000)	8	10.8	10		RGV								
R260111P R260111V	1	 BANCADA	74	90	10		G1ALGRI								
R260112P R260112V	1	 DISTRIBUCIÓN	30	43	8		G1ALGHD								
R250413P R250413P/1	2	 ÁRBOL DE LEVAS	30	52	7		GALGRD								
R500411P	1	 BANCADA	90	120	12		G1ALGHI	75TD 1984/92 75 TD 1989/92, 90TD 1984/97 155TD 1993/97 164TD 1987/92, 1992/98	1995cc. 2393cc. 2499cc.	VM80A VM81A VM84A - VM08B/VM07B VM31B/VM32B (OHV) 8V DIESEL	500401				
R500412P	1	 DISTRIBUCIÓN	56	80	10		GAHD								



ASIA MOTORS

R950110P	1	 GUÍA VÁLVULAS (6) R950110P/1	7	12	15		RGV	Towner 1993/...	843cc.	CD (SOHC) 6V	900700-R
R950011P	1	 BANCADA	58	74	9.5		GALGHI				
R950012N R950012P	1	 DISTRIBUCIÓN	32	48	7		GALGHD				
R900900	1	 KIT DE RETENES					JUEGO	Roesta 1993/...	2184cc.	R2 8V DIESEL	900900-R
R900910P	1	 GUÍA VÁLVULAS (8) R900910P/1	7	13.9	14.5		RGV				
R460211V	1	 BANCADA	90	110	7		GALGRI				
R900912P	1	 DISTRIBUCIÓN	34	48	7		GALGHD				
R900913P	1	 ÁRBOL DE LEVAS	30	44	7		GALGHD				

















CATALOGO DE RETENES

CATALOGO DE RETENTORES - OIL SEAL CATALOG





















ASIA MOTORS

Código Code	Cant. Qty	Descripción Descrição Descrição	DE [mm]	DA [mm]	H [mm]	A [mm]		Aplicación Aplicação Application	Cm³ Cm³	Motor Motor Engine	Jgo. Juntas Set Gaskets
R900810P	1	 GUÍA VÁLVULAS (8) R900810P/1	7	12.4	13		RGV	Topic, Hi-Topic 1993/...	2701cc.	SS (OHV) 8V DIESEL	900800-R.
R900811S	1	 BANCADA	101.57	125	13		GALGHI				
R900812P	1	 DISTRIBUCIÓN	51	70	11		GALGHD				

AUDI

R220400	1	 KIT DE RETENES						80 D/TD 1981/85	1588cc.	CR/JK/CY/JR (SOHC) 8V DIESEL	230101-R				
R220410V	1	 GUÍA VÁLVULAS (8) R250410V/1	8	10.8	10		RGV								
R220411P R220411P/1 R220411V R220411VF	1	 BANCADA	85	105	12		GALGRI								
R230113P R230113P/1 R230113V	3	 ÁRBOL DE LEVAS Y DISTRIBUCIÓN	32	47	10		GALG-BI	4000, 80, 4E, 100 Fox 1979/83, Coupe 1980/81 4000 1981/83	1588cc. 1715cc.	YH/YP/YT/YK/YW/YS WT 79HP Ø79.5	220400-R				
R220400	1	 KIT DE RETENES													
R220410V	1	 GUÍA VÁLVULAS (8) R250410V/1	8	10.8	10		RGV								
R220411P R220411P/1 R220411V R220411VF	1	 BANCADA	85	105	12		GALGRI								
R220412P R220412P/1 R220412V	1	 DISTRIBUCIÓN	32	47	10		GALGHD								
R230113P R230113P/1 R230113V	3	 ÁRBOL DE LEVAS Y DISTRIBUCIÓN	32	47	10		GALG-BI								
R220455N	1	 RUEDA TRASERA	40	52	7.5		E-GALG								
R230210P R230210V	1	 GUÍA VÁLVULAS (8) R260610V/1	7	9.8	10		RGV					80 1993/95	1595cc.	ADA/ABM (SOHC) 8V	230300-R 230300-R MLS
R220411P R220411P/1 R220411V R220411VF	1	 BANCADA	85	105	12		GALGRI								
R230113P R230113P/1 R230113V	3	 ÁRBOL DE LEVAS Y DISTRIBUCIÓN	32	47	10		GALG-BI								
R230510P R230510V R230510VM/1 R230510VM/2 R230510VM/3 R230510VM/4	1	 GUÍA VÁLVULAS (8) GUÍA VÁLVULAS (8) A GRANEL (200) A GRANEL (200) A GRANEL (1000) A GRANEL (600)	6	8.8	9.5		RGV	A3 FSI 2003/...	1598cc.	BAG/BLP/BLF (DOHC) 16V	233300-R MLS				
PR233311T	1	 PORTA BANCADA	84				PORTA								
R230113P R230113P/1 R230113V	2	 ÁRBOL DE LEVAS	32	47	10		GALG-BI								







AUDI

Código Code	Cant. Qty	Descripción Descrição Descrição	DE [mm]	DA [mm]	H [mm]	A [mm]		Aplicación Aplicação Application	Cm³ Cm³	Motor Motor Engine	Jgo. Juntas Set Gaskets
R221710V	1	 GUÍA VÁLVULAS (20) R230510V/1	6	8.8	9.5		RGV	A3 Turbo 1996/..., A6 1997/... A3/A3 Quattro 1998/... A4/A6 Turbo 1994/..., Cabrio 1997/..., A6 Quattro 1999/...	1715cc. 1715cc.	AJP/AGU/AQA/AJQ/APP (DOHC) 20V AEB/AJL/ANB AFY/ADR (DOHC) 20V	221700-R 221800-R
PR221711V PR221711VF	1	 PORTA BANCADA	85				PORTA				
R220411P R220411P/1 R220411V R220411VF	1	 BANCADA	85	105	12		GALGRI				
R230113P R230113P/1 R230113V	2	 ÁRBOL DE LEVAS	32	47	10		GALG-BI				
R240013P R240013P/1 R240013V	1	 ÁRBOL DE LEVAS	35	48	7		GALGHD				
R220400	1	 KIT DE RETENES					JUEGO	A4 D/TDI 1994/96-1997/00 A6 TDI 1994/96, CabrioTDI 1995/96, 80TDI 1991/94	1896cc.	1Z/AFF/AHH/AFN/AVG AHU (SOHC) 8V DIESEL	230901-R
R220410V	1	 GUÍA VÁLVULAS (8) R250410V/1	8	10.8	10		RGV				
R220411P R220411P/1 R220411V R220411VF	1	 BANCADA	85	105	12		GALGRI				
PR230211V PR230211VF	1	 PORTA BANCADA	32	47	10		GALG-BI				
R230113P R230113P/1 R230113V	3	 ÁRBOL DE LEVAS Y DISTRIBUCIÓN	32	47	10		GALG-BI				
R230210P R230210V	1	 GUÍA VÁLVULAS (8) R260610V/1	7	9.8	10		RGV	A3 TDI 1996/99	1896cc.	AGR (SOHC) 8V DIESEL	223401-R
R230113P R230113P/1 R230113V	1	 ÁRBOL DE LEVAS	32	47	10		GALG-BI				
R240013P R240013P/1 R240013V	1	 DISTRIBUCIÓN	35	48	7		GALGHD				
R230210P R230210V	1	 GUÍA VÁLVULAS (8) R260610V/1	7	9.8	10		RGV	A4 TDI 2000/... - 2004/... A6 TDI 2001/...	1896cc.	ATJ/AVF/AWX/BKE (SOHC) 8V DIESEL	223501-R
PR230211V PR230211VF	1	 PORTA BANCADA	85				PORTA				
R230113P R230113P/1 R230113V	1	 ÁRBOL DE LEVAS	32	47	10		GALG-BI				
R240013P R240013P/1 R240013V	1	 DISTRIBUCIÓN	35	48	7		GALGHD				
R220410V	1	 GUÍA VÁLVULAS (8) R250410V/1	8	10.8	10		RGV	80 Quattro, 100 1993/95, 80 1991/95, 100 1993/94 80 Quattro, Coupe 1990/93, 100 1990/93	1894cc. 1894cc.	ABK/ABT/AAE (SOHC) 8V AAD/ABK/AAE (SOHC) 8V	222500 222600
R230113P R230113P/1 R230113V	1	 ÁRBOL DE LEVAS	32	47	10		GALG-BI				
R221110V	1	 GUÍA VÁLVULAS R250410V/1 (10)	8	10.8	10		RGV	80/80 Quattro, Coupe, 90/100 100/200, Coupe 90/90 Quattro 1984/91	1994cc. 2226cc.	JS/HP/SK/KP KZ/KU/HY/KV (SOHC) 10V	222200-R







CATALOGO DE RETENES

CATALOGO DE RETENTORES - OIL SEAL CATALOG





AUDI

Código Code	Cant. Qty	Descripción Descrição Descrição	DE [mm]	DA [mm]	H [mm]	A [mm]		Aplicación Aplicação Aplicacion	Cm³ Cm³	Motor Motor Engine	Jgo. Juntas Set Gaskets
R220411P R220411P/1 R220411V R220411VF	1	 BANCADA	85	105	12		GALGRI	80/80 Quattro, Coupe 1983/86 90/100 1984/88 100/200, Coupe 90/90 Quattro 1984/91	1994cc. 2226cc.	JS/HP/SK/KP (SOHC) 10V KZ/KU/HY/KV (SOHC) 10V	222200-R
R240013P R240013P/1 R240013V	1	 DISTRIBUCIÓN	35	48	7		GALGHD				
R230113P R230113P/1 R230113V	2	 ÁRBOL DE LEVAS	32	47	10		GALG-BI				
R230113P R230113P/1 R230113V	1	 ÁRBOL DE LEVAS	32	47	10		GALG-BI	100, 200 Avant, 100 Avant Coupe, Cabriolet 1985/...	2309cc.	NF (SOHC) 10V	222700
R221110V	1	 GUÍA VÁLVULAS R250410V/1 (10)	8	10.8	10		RGV	80/90 1985/94, Cabrio Coupe 1990/95, A6 1994/... Coupe Quattro 1985/95	2309cc.	AAR/NG (SOHC) 10V	222800
R230113P R230113P/1 R230113V	1	 ÁRBOL DE LEVAS	32	47	10		GALG-BI	80 Quattro 1991/94 90 Quattro 1987/91			

BEDFORD

R210010P	1	 GUÍA VÁLVULAS (8) R300010P/1	7.9	15.5	12.5		RGV	C14 - J17/J27/J37 1962/64	3285cc.	200D DIESEL	210800-R
R210011N	1	 BANCADA	118	143	13		GARI				
R210012N	1	 DISTRIBUCIÓN	49.2	65.09	12.7		GALGHD				
R210000 R210000N	1	 KIT DE RETENES					JUEGO	J6 1961/71 C50 Turbo 1971/79 J6 1956/61 350H, C60, 714 1971/79	4927cc. 4927cc. 4927cc. 5755cc.	300D DIESEL 300DX DIESEL 300D DIESEL 350D/CD600 DIESEL	210000-R 210200-R 210300-R 210100-R
R300010P R300010PN/1	1	 GUÍA VÁLVULAS (12) A GRANEL (144)	7.9	15.5	12.5		RGV				
R210011N	1	 BANCADA	118	143	13		GARI				
R210012N	1	 DISTRIBUCIÓN	49.2	65.09	12.7		GALGHD				







BMW

R950210P	1	 GUÍA VÁLVULAS (12) R260610V/1	7	9.8	10		RGV	320, 520 1977/82 520i 1982/90, 1987/90, 320i 1982/93 - 1988/91 323i 1977/82 323i 1982/86	1990cc. 1990cc.	M20 (SOHC) 12V M20 (206KA) - 206EE (SOHC) 12V M20 (SOHC) 12V M20 (236EE) (SOHC) 12V	950200-R 980000-R
R550611P R550611V	1	 BANCADA	90	110	13		GALGRI		2315cc. 2315cc.		950200-R 980000-R
R950212P R950212V	1	 DISTRIBUCIÓN	48	65	10		GAHD				
R452113V	1	 ÁRBOL DE LEVAS	38	50	6		GALGHD				
R950212P R950212V	1	 DISTRIBUCIÓN	48	65	10		GAHD	324 D, 524 D 1985/90 324 TD, 524 TD 1982/93 325 TD, 525 TDS 1990/92 725 TDS 1995/..., 32 T5DS 525 TDS, 325/525 TD 1994/...	2443cc. 2498cc. 2498cc.	M21 (246D/DA) M21 (246TB/TA) M51 (256T1/T1-L) M51 (256T1)/T1-L) (SOHC) 12V DIESEL	980501-R 980201-R 981201-R















CHERY

R950011P	1	 BANCADA	58	74	9.5		GALGHI	QQ 2003/... QQ3, IQ, Sweet	796cc. 1097cc.	SQR 372 F (DOHC) 12V SQR 472 F (DOHC) 16V	993000-R 993100-R MLS
R320913V	1	 DISTRIBUCIÓN	38	52		6	GALGHD				

CHERY

Código Code	Cant. Qty	Descripción Descrição Descrição	DE [mm]	DA [mm]	H [mm]	A [mm]		Aplicación Aplicação Application	Cm³ Cm³	Motor Motor Engine	Jgo. Juntas Set Gaskets
R910613P	1	 ÁRBOL DE LEVAS	32	46	6		GALGHD	QQ 2003/... QQ3, IQ, Sweet	796cc. 1097cc.	SQR 372 F (DOHC) 12V SQR 472 F (DOHC) 16V	993000-R 993100-R MLS
R340312V	2	 DISTRIBUCIÓN	30	50	7.5		GALGRD	Face 2011/...	1297cc.	473 H (DOHC) 16V	993400-R
R550613P R550613P/1 R550613V	1	 ÁRBOL DE LEVAS	35	47	7		GAHD				
R460211-1V	1	 BANCADA	90	110	10		GALGRI	Tiggo 2010/...	1971cc.	Acteco S9R 484F (DOHC) 16V	993200-R MLS
R340312V	2	 DISTRIBUCIÓN	30	50	7.5		GALGRD				
R550613P R550613P/1 R550613V	1	 ÁRBOL DE LEVAS	35	47	7		GAHD				



















CHEVROLET / OPEL / GM / VAUXHALL

R282510P	1	 GUÍA VÁLVULAS (8) R940010P/1	5	9	9.5		RGV	Spark 2003/06, Aveo 2006/...	995cc.	B10S (SOHC) 8V	282500-R
R940011S	1	 BANCADA	60	80	8		GALGHI				
R282513P	1	 DISTRIBUCIÓN Y ÁRBOL DE LEVAS	32	47	7						
R240400	1	 KIT DE RETENES					JUEGO	Corsa 1.0 EFI, B10 NZ 1994/... Celta 2000/... Celta, Classic, Corsa 2003/...	996cc. 999cc. 999cc.	OHC MPFI (SOHC) 8V MPFI VHC	240900-R 241200-R 243300-R MLS
R240210P R240210V R240210VM/1 R240210VM/2 R240210VM/3	1	 GUÍA VÁLVULAS (8) GUÍA VÁLVULAS (8) A GRANEL (200) A GRANEL (200) A GRANEL (1000)	7	11.1	10		RGV				
R240411P R240411P/1 R240411V	1	 BANCADA	80	98	10		G1ALGRI				
R240415P R240415P/1 R240415V	1	 DISTRIBUCIÓN Y BOMBA DE ACEITE	26	42	8		G1ALGHD				
R240013P R240013P/1 R240013V	1	 ÁRBOL DE LEVAS	35	48	7		GALGHD				
R240949N	1	 EJE PIÑÓN	21	32	7.5		G1LGHD	Corsa 1.0 EFI, B10 NZ 1994/... Corsa B 1993/97	996cc. 1196cc.	OHC C12NZ - 12NZ - X12SZ	240900-R
R240960N	1	 SEMIEJE DIFERENCIAL	35	54	10/15		G1ALG-BI				
R244010V	1	 GUÍA VÁLVULAS (8) R230510P/1	6	8.8	9.5		RGV	Prisma, Onix	999cc.	SPE/4	244200-R MLS
R240411P R240411P/1 R240411V	1	 BANCADA	80	98	10		G1ALGRI				
R240415P R240415P/1 R240415V	1	 DISTRIBUCIÓN Y BOMBA DE ACEITE	26	42	8		G1ALGHD				
R240013P R240013P/1 R240013V	1	 ÁRBOL DE LEVAS	35	48	7		GALGHD				





















CATALOGO DE RETENES

CATALOGO DE RETENTORES - OIL SEAL CATALOG

CHEVROLET / OPEL / GM / VAUXHALL

Código Code	Cant. Qty	Descripción Descrição Descrição	DE [mm]	DA [mm]	H [mm]	A [mm]		Aplicación Aplicação Application	Cm³ Cm³	Motor Motor Engine	Jgo. Juntas Set Gaskets
R280600	1	 KIT DE RETENES					JUEGO	Corsa 1998/...	999cc.	MPFI (DOHC) 16V	280500-R
R280610V	1	 GUÍA VÁLVULAS (16) R230510V/1	6	8.8	9.5		RGV				
R240411P R240411P/1 R240411V	1	 BANCADA	80	98	10		G1ALGRI				
R240013P R240013P/1 R240013V	2	 ÁRBOL DE LEVAS	35	48	7		GALGHD				
R240415P R240415P/1 R240415V	1	 DISTRIBUCIÓN Y BOMBA DE ACEITE	26	42	8		G1ALGHD				
R240210P R240210V R240210VM/1 R240210VM/2 R240210VM/3	1	 GUÍA VÁLVULAS (8) GUÍA VÁLVULAS (8) A GRANEL (200) A GRANEL (200) A GRANEL (1000)	7	11.1	10		RGV	Corsa A 1990/93, Kadett E 1986/91, Nova 1985/... Kadett D, Kadett E 1979/86, Cavalier, Astra 1980/85	1196cc. 1297cc.	12NV - 12ST 13N/SB	241100 241300
R240013P R240013P/1 R240013V	1	 ÁRBOL DE LEVAS	35	48	7		GALGHD				
R240400	1	 KIT DE RETENES						Corsa B 1993/97 Corsa 1.4 EFI Celta MPFI 2004/...	1196cc. 1389cc. 1389cc.	C12NZ - 12NZ - X12SZ C14 NV/NZ (SOHC) 8V C14E Familia I	240900-R 240400-R 241000-R
R240210P R240210V R240210VM/1 R240210VM/2 R240210VM/3	1	 GUÍA VÁLVULAS (8) GUÍA VÁLVULAS (8) A GRANEL (200) A GRANEL (200) A GRANEL (1000)	7	11.1	10		RGV				
R240411P R240411P/1 R240411V	1	 BANCADA	80	98	10		G1ALGRI				
R240013P R240013P/1 R240013V	1	 ÁRBOL DE LEVAS	35	48	7		GALGHD				
R240415P R240415P/1 R240415V	1	 DISTRIBUCIÓN Y BOMBA DE ACEITE	26	42	8		G1ALGHD				
R240411P R240411P/1 R240411V	1	 BANCADA	80	98	10		G1ALGRI	Aveo 2008/..., Aveo, Volt 2011/..., Cruze 2011/..., 2013/...	1362cc. 1398cc.	LUV - ECOTEC (DOHC) 16V	291400-R MLS
R240455N	1	 RUEDA TRASERA	40	52	8.5		E-GALG	Corsa 1.4 EFI	1389cc.	C14 NV/NZ (SOHC) 8V	240400-R
R244010V	1	 GUÍA VÁLVULAS (8) R230510P/1	6	8.8	9.5		RGV	Corsa 1.4 Econoflex, Classic, Agile, Celta 2006/2009 - 09/... Prisma, Onix	1389cc. 1389cc.	X14SE/Y14NE (SOHC) 8V SPE/4	244000-R 244300-R
R240411P R240411P/1 R240411V	1	 BANCADA	80	98	10		G1ALGRI				
R240415P R240415P/1 R240415V	1	 DISTRIBUCIÓN Y BOMBA DE ACEITE	26	42	8		G1ALGHD				
R240013P R240013P/1 R240013V	1	 ÁRBOL DE LEVAS	35	48	7		GALGHD				



















CHEVROLET / OPEL / GM / VAUXHALL

Código Code	Cant. Qty	Descripción Descrição Descrição	DE [mm]	DA [mm]	H [mm]	A [mm]		Aplicación Aplicação Application	Cm³ Cm³	Motor Motor Engine	Jgo. Juntas Set Gaskets
R280610V	1	 GUÍA VÁLVULAS (16) R230510V/1	6	8.8	9.5		RGV	Corsa 2002/04	1389cc.	Z14XE - Ecotec (DOHC) 16V	282300-R
R240411P R240411P/1 R240411V	1	 BANCADA	80	98	10		G1ALGRI				
R240013P R240013P/1 R240013V	2	 ÁRBOL DE LEVAS	35	48	7		GALGHD				
R240415P R240415P/1 R240415V	1	 DISTRIBUCIÓN Y BOMBA DE ACEITE	26	42	8		G1ALGHD				
R200800	1	 KIT DE RETENES					JUEGO	Chevette 1973/89 Chevette 1973/89	1393cc. 1599cc.	GMC 85 GMC 98	200800-R
R200810P	1	 GUÍA VÁLVULAS (8)	8	13.8	12.8		RGV	Aveo 2009/...	1399cc.	F14D4 (DOHC) 16V	291000-R MLS
R200811P	1	 BANCADA	75.9	95	11.3		GALGH				
R200859N	1	 RUEDA DELANTERA INTERIOR	38	52	8.5/2.5		ESP-GALG				
R450412P R450412N	2	 DISTRIBUCIÓN	45	60	10		GALGHD				
R291010V	1	 GUÍA VÁLVULAS (16) R291010V/1	5	7.8	15.5	23	RGV				
PR291011T	1	 PORTA BANCADA	79				PORTA				
R230512P R230512P/1 R230512V	1	 DISTRIBUCIÓN	32	42	7		G1ALGHD	Monza, Kadett 1981/86	1598cc.	CN16 - 16SH	240300-R
R240013P R240013P/1 R240013V	2	 ÁRBOL DE LEVAS	35	48	7		GALGHD				
R240010P R240010V	1	 GUÍA VÁLVULAS (8) R430010V/1	8	12	9.5	15.2	RGV				
R240311P R240311V	1	 BANCADA	85.9	104	11		GALGRI				
R240012P R240012V	1	 DISTRIBUCIÓN	31	50	8		GALGHD	Corsa, Ascona C 1986/88 Astra, Vectra A 1991/97 Corsa A GSI, Nova 1987/93 Kadett E, Cavalier 1986/9 Corsa, Vectra, Kadett 1999/...	1598cc.	C16LZ/NZ/SV E16ASE - X16SZ 16NZ/SV (SOHC) 8V C1.6 SE - X16 SZR 8V	240400-R 242300-R
R240013P R240013P/1 R240013V	1	 ÁRBOL DE LEVAS	35	48	7		GALGHD				
R240400	1	 KIT DE RETENES					JUEGO				
R240210P R240210V R240210VM/1 R240210VM/2 R240210VM/3	1	 GUÍA VÁLVULAS (8) GUÍA VÁLVULAS (8) A GRANEL (200) A GRANEL (200) A GRANEL (1000)	7	11.1	10		RGV				
R240411P R240411P/1 R240411V	1	 BANCADA	80	98	10		G1ALGRI				





















CATALOGO DE RETENES

CATALOGO DE RETENTORES - OIL SEAL CATALOG

CHEVROLET / OPEL / GM / VAUXHALL

Código Code	Cant. Qty	Descripción Descrição Descrição	DE [mm]	DA [mm]	H [mm]	A [mm]		Aplicación Aplicação Application	Cm³ Cm³	Motor Motor Engine	Jgo. Juntas Set Gaskets
R240013P R240013P/1 R240013V	1	 ÁRBOL DE LEVAS	35	48	7		GALGHD	Corsa, Ascona C 1986/88 Astra, Vectra A 1991/97 Corsa A GSI, Nova 1987/93 Kadett E, Cavalier 1986/9 Corsa, Vectra, Kadett 1999/...	1598cc.	C16LZ/NZ/SV E16ASE - X16SZ 16NZ/SV (SOHC) 8V	240400-R
R240415P R240415P/1 R240415V	1	 DISTRIBUCIÓN Y BOMBA DE ACEITE	26	42	8		G1ALGHD		1598cc.	C1.6 SE - X16 SZR 8V	242300-R
R240455N	1	 RUEDA TRASERA	40	52	8.5		E-GALG				
R280600	1	 KIT DE RETENES					JUEGO	Corsa, Opel, Tigra, Astra Vectra 1993/...	1598cc.	C16XE - C16XEL (DOHC) 16V	280600-R
R280610V	1	 GUÍA VÁLVULAS (16) R230510V/1	6	8.8	9.5		RGV				
R240411P R240411P/1 R240411V	1	 BANCADA	80	98	10		G1ALGRI				
R240013P R240013P/1 R240013V	2	 ÁRBOL DE LEVAS	35	48	7		GALGHD				
R240415P R240415P/1 R240415V	1	 DISTRIBUCIÓN Y BOMBA DE ACEITE	26	42	8		G1ALGHD				
R570910V R570910VM/2 R570910VM/3	1	 GUÍA VÁLVULAS (16) A GRANEL (80) A GRANEL (140)	5.5	11	16.5	28	RGV	Nubira 2003/05 Aveo MPI 2004/... Pontiac G3 2008/...	1598cc.	F16 D3 (DOHC) 16V	290100-R
R240411P R240411P/1 R240411V	1	 BANCADA	80	98	10		G1ALGRI				
R260113P R260113P/1 R260113V	1	 DISTRIBUCIÓN	30	42	7		GALGHD				
R300612P R300612V R300612N	2	 ÁRBOL DE LEVAS	42	56	7		GAHD				
R230510P R230510V R230510VM/1 R230510VM/2 R230510VM/3 R230510VM/4	1	 GUÍA VÁLVULAS (16) GUÍA VÁLVULAS (16) A GRANEL (200) A GRANEL (200) A GRANEL (1000) A GRANEL (600)	6	8.8	9.5		RGV	Corsa, Astra G DTI, Corsa C DI, Combo Tour TD 2000/...	1686cc.	Y17 DT/DTL (DOHC) 16V DIESEL	242501-R
R280211V	1	 BANCADA	87	100	8.5		GALGRI				
R242512P	1	 DISTRIBUCIÓN	54	82	11.45						
R242513V	1	 ÁRBOL DE LEVAS	38	50	8						
R452113V	1	 ÁRBOL DE LEVAS	38	50	6		GALGHD				
R280215P R280215V R280215N	1	 BOMBA DEPRESORA	17.5	32	6		GALGHD				
R280210V	1	 GUÍA VÁLVULAS (8) R280210V/1	5.8	11.4	10.4		RGV	Corsa D, Combo D 1997/... Vectra TD 1991/96, Astra TD 1994/97	1686cc.	4EE1 - 4EE1T DIESEL	280201-R





















CHEVROLET / OPEL / GM / VAUXHALL

Código Code	Cant. Qty	Descripción Descrição Descrição	DE [mm]	DA [mm]	H [mm]	A [mm]		Aplicación Aplicação Application	Cm³ Cm³	Motor Motor Engine	Jgo. Juntas Set Gaskets
R280211V	1	 BANCADA	87	100	8.5		GALGRI	Corsa D, Combo D 1997/... Vectra TD 1991/96, Astra TD 1994/97	1686cc.	4EE1 - 4EE1T DIESEL	280201-R
R280212P R280212V	2	 DISTRIBUCIÓN	40	52	6		GALGHD				
R280215P R280215V R280215N	1	 BOMBA DEPRESORA	17.5	32	6		GALGHD				
R240010P R240010V	1	 GUÍA VÁLVULAS (8) R430010V/1	8	12	9.5	15.2	RGV	Astra 1991/94, Vectra A 1989/95, Astra Max 1990/... Belmont 1989/91 Astra TD 1994/97, Astra GTD 1998/00 Motor 14555260 08/1994	1699cc.	17D/DR (SOHC) 8V DIESEL	241601-R
R240211P R240211V	1	 BANCADA	90	104	11		GALGRI				
R240013P R240013P/1 R240013V	1	 DISTRIBUCIÓN	35	48	7		GALGHD				
R470013P R470013P/1 R470013V	1	 ÁRBOL DE LEVAS	35	50	7		GALG-BI				
R240210P R240210V R240210VM/1 R240210VM/2 R240210VM/3	1	 GUÍA VÁLVULAS (8) GUÍA VÁLVULAS (8) A GRANEL (200) A GRANEL (200) A GRANEL (1000)	7	11.1	10		RGV	Astra TD, Astra F TD 1994/97	1700cc.	17DTL DIESEL	241701-R
R240411P R240411P/1 R240411V	1	 BANCADA	80	98	10		G1ALGRI				
R240415P R240415P/1 R240415V	1	 DISTRIBUCIÓN	26	42	8		G1ALGHD				
R470013P R470013P/1 R470013V	1	 DISTRIBUCIÓN	35	50	7		GALG-BI				
R240013P R240013P/1 R240013V	1	 ÁRBOL DE LEVAS	35	48	7		GALGHD				
R280610V	1	 GUÍA VÁLVULAS (16) R230510V/1	6	8.8	9.5		RGV				
R240411P R240411P/1 R240411V	1	 BANCADA	80	98	10		G1ALGRI				
R550413P R550413N	1	 DISTRIBUCIÓN	30	42	8		GAHI				
R240013P R240013P/1 R240013V	2	 ÁRBOL DE LEVAS	35	48	7		GALGHD				
R220110P	1	 GUÍA VÁLVULAS (8) R300310P/1	7.9	15.5	12.5		RGV	Opel K180 1974/79	1790cc.	K180	200200-R
R200011-1S	1	 BANCADA (2 MITADES)	64	78	12		2 PARTES				
R200011-2S	1	 BANCADA REFORMA EXPANSIBLE	64	78	12		EXPAN				
R200011P	1	 BANCADA (2 MITADES)	64	78	12		2 PARTES				
R200012N R200012P	1	 DISTRIBUCIÓN	44.47	61.19	9.57		G1LGHD				























CATALOGO DE RETENES

CATALOGO DE RETENTORES - OIL SEAL CATALOG

CHEVROLET / OPEL / GM / VAUXHALL

Código Code	Cant. Qty	Descripción Descrição Descrição	DE [mm]	DA [mm]	H [mm]	A [mm]		Aplicación Aplicação Application	Cm³ Cm³	Motor Motor Engine	Jgo. Juntas Set Gaskets
R240300	1	 KIT DE RETENES					JUEGO	Monza 1.8 SLE/SEE Kadett, Rekord 1983/...	1796cc.	C18N S/E	240000-R
R240010P R240010V	1	 GUÍA VÁLVULAS (8) R430010V/1	8	12	9.5	15.2	RGV				
R240311P R240311V	1	 BANCADA	85.9	104	11		GALGRI				
R240012P R240012V	1	 DISTRIBUCIÓN	31	50	8		GALGHD				
R240013P R240013P/1 R240013V	1	 ÁRBOL DE LEVAS	35	48	7		GALGHD				
R240048N	1	 SELECTOR CAJA VELOCIDAD	13	26	7		GALG				
R240200	1	 KIT DE RETENES					JUEGO	Monza 1996/..., Astra 1991/... Kadett, Ascona 1986/91 Vectra 1988/95, Blazer Monza, Kadett 1986/91 Astra 1991/97, Vectra 1989/95 Astra MPFI 1999/...	1796cc.	C18NE FII	240200-R
R240210P R240210V R240210VM/1 R240210VM/2 R240210VM/3	1	 GUÍA VÁLVULAS (8) GUÍA VÁLVULAS (8) A GRANEL (200) A GRANEL (200) A GRANEL (1000)	7	11.1	10		RGV		1796cc.	C18NE/NV - C18NZ	280000-R
R240211P R240211V	1	 BANCADA	90	104	11		GALGRI		1796cc.	MPFI 8V 110HP Ø84.8	291200-R
R240012P R240012V	1	 DISTRIBUCIÓN	31	50	8		GALGHD				
R240013P R240013P/1 R240013V	1	 ÁRBOL DE LEVAS	35	48	7		GALGHD				
R242210V	1	 GUÍA VÁLVULAS (8) R230510V/1	6	8.8	9.5		RGV	Corsa, Meriva 2003	1796cc.	GM Powertrain	242200-R
R240210P R240210V R240210VM/1 R240210VM/2 R240210VM/3	1	 GUÍA VÁLVULAS (8) GUÍA VÁLVULAS (8) A GRANEL (200) A GRANEL (200) A GRANEL (1000)	7	11.1	10		RGV				
R240411P R240411P/1 R240411V	1	 BANCADA	80	98	10		G1ALGRI				
R240415P R240415P/1 R240415V	1	 DISTRIBUCIÓN	26	42	8		G1ALGHD				
R240013P R240013P/1 R240013V	1	 ÁRBOL DE LEVAS	35	48	7		GALGHD				
R244010V	1	 GUÍA VÁLVULAS (8) R230510V/1	6	8.8	9.5		RGV	Spin, Cobalt 2012/... Spin, Cobalt 2017/...	1796cc. 1796cc.	N18XFN SPE/4	244100-R MLS 244500-R MLS
R240411P R240411P/1 R240411V	1	 BANCADA	80	98	10		G1ALGRI				
R240013P R240013P/1 R240013V	1	 ÁRBOL DE LEVAS	35	48	7		GALGHD				
R240415P R240415P/1 R240415V	1	 DISTRIBUCIÓN	26	42	8		G1ALGHD				





















CHEVROLET / OPEL / GM / VAUXHALL

Código Code	Cant. Qty	Descripción Descrição Descrição	DE [mm]	DA [mm]	H [mm]	A [mm]		Aplicación Aplicação Application	Cm³ Cm³	Motor Motor Engine	Jgo. Juntas Set Gaskets				
R281610V	1	 GUÍA VÁLVULAS (16) R271210V/1	5	7.8	8		RGV	Astra 2000/03	1796cc.	Z18XE ECOTEC (DOHC) 16V	281600-R				
R240411P R240411P/1 R240411V	1	 BANCADA	80	98	10		G1ALGRI								
R240013P R240013P/1 R240013V	2	 ÁRBOL DE LEVAS	35	48	7		GALGHD								
R550615P R550615V R550615N	1	 AUXILIAR	30	40	7		GAHD								
R291010V	1	 GUÍA VÁLVULAS (16) R291010V/1	5	7.8	15.5	23	RGV	Astra H 2004/..., Signum Vectra C, Zafira B 2005/..., Insignia, Cruze 2008/...	1796cc.	Z18XER - A18XER F18D4 (DOHC) 16	291000-R MLS				
PR291011T	1	 PORTA BANCADA	79				PORTA								
R230512P R230512P/1 R230512V	1	 DISTRIBUCIÓN	32	42	7		G1ALGHD								
R240013P R240013P/1 R240013V	2	 ÁRBOL DE LEVAS	35	48	7		GALGHD								
R460213P R460213V	1	 ÁRBOL DE LEVAS	36	50	8		GALGHD	Epica, Optra 2006/11, Lacetti Nubira, Captiva, Tosca 2007/..., Cruze 2009/..., Antara 2006/10	1991cc.	Z20S - Z20DM (SOHC) 16V	291101-R				
R280610V	1	 GUÍA VÁLVULAS (16) R230510V/1	6	8.8	9.5		RGV	Astra, Vectra, Omega, Zafira Vectra, Zafira, Omega, Frontera, Sintra	1995cc. 2171cc.	X20 DTL-DTH X22 DTH (SOHC) 16V DIESEL	290701-R				
R290711V	1	 BANCADA	99	114	11		GALGRI								
R450412P R450412N	1	 DISTRIBUCIÓN	45	60	10		GALGHD								
R270612V	1	 DISTRIBUCIÓN	55	68	8		GALGHD								
R470810V	1	 GUÍA VÁLVULAS (8)	6	10	21.5		RGV					Tracker 2001/04	1997cc.	(SOHC) 8V DIESEL	470801-R
R460211V	1	 BANCADA	90	110	7		GALGRI								
R460212P R460212V	1	 DISTRIBUCIÓN	42	62	7		GALGHD								
R470813V	1	 ÁRBOL DE LEVAS	27	47	7		GALGHD								
R240200	1	 KIT DE RETENES					JUEGO	Kadett, Ascona 1986/91 Vectra 1988/95	1998cc.	C20NE	240200-R				
R240210P R240210V R240210VM/1 R240210VM/2 R240210VM/3	1	 GUÍA VÁLVULAS (8) GUÍA VÁLVULAS (8) A GRANEL (200) A GRANEL (200) A GRANEL (1000)	7	11.1	10		RGV	Kadett, Ascona 1986/91 Vectra 1988/95	1998cc.	C20NE	240200-R				
R240211P R240211V	1	 BANCADA	90	104	11		GALGRI								
R240012P R240012V	1	 DISTRIBUCIÓN	31	50	8		GALGHD								
R240013P R240013P/1 R240013V	1	 ÁRBOL DE LEVAS	35	48	7		GALGHD								

CATALOGO DE RETENES

CATALOGO DE RETENTORES - OIL SEAL CATALOG





















CHEVROLET / OPEL / GM / VAUXHALL

Código Code	Cant. Qty	Descripción Descrição Descrição	DE [mm]	DA [mm]	H [mm]	A [mm]		Aplicación Aplicação Aplicacion	Cm³ Cm³	Motor Motor Engine	Jgo. Juntas Set Gaskets
R240210P R240210V R240210VM/1 R240210VM/2 R240210VM/3	1	 GUÍA VÁLVULAS (8) GUÍA VÁLVULAS (8) A GRANEL (200) A GRANEL (200) A GRANEL (1000)	7	11.1	10		RGV	Omega, Vectra 1992/98 Frontera 1991/95, Calibra, Cavalier, Kadett 1986/91 Astra 1991/96, Omega A 1986/94	1998cc.	OHC MPFI (SOHC) 8V C20NE/SEH/SER/NEF (SOHC) 8V	241500-RMX
R240211P R240211V	1	 BANCADA	90	104	11		GALGRI				
R240012P R240012V	1	 DISTRIBUCIÓN	31	50	8		GALGHD				
R240013P R240013P/1 R240013V	1	 ÁRBOL DE LEVAS	35	48	7		GALGHD				
R241515V	1	 AUXILIAR	55	70	8		GALGHI				
R280700	1	 KIT DE RETENES					JUEGO	Astra 1995/..., Omega B Calibra 1994/...	1998cc.	X20XEV (DOHC) 16V	280700-R
R280610V	1	 GUÍA VÁLVULAS (16) R230510V/1	6	8.8	9.5		RGV	Vectra, Astra, Calibra Zafira 1994/..., Astra 1998/... Astra 1995/98, Optra, Zafira 1998/...	1998cc. 1998cc.	X20 XEV (DOHC) 16V X20 XEV (DOHC) 16V	290800-R 281900-R
R240211P R240211V	1	 BANCADA	90	104	11		GALGRI				
R240012P R240012V	1	 DISTRIBUCIÓN	31	50	8		GALGHD				
R240013P R240013P/1 R240013V	2	 ÁRBOL DE LEVAS	35	48	7		GALGHD				
R240210P R240210V R240210VM/1 R240210VM/2 R240210VM/3	1	 GUÍA VÁLVULAS (8) GUÍA VÁLVULAS (8) A GRANEL (200) A GRANEL (200) A GRANEL (1000)	7	11.1	10		RGV	Vectra 1994/96, Calibra 1989/97, Kadett E 1987/91, Calibra Turbo 1992/97 Vectra Turbo 1993/95	1998cc. 1998cc.	C20XE - C20LET (DOHC) 16V	290900-R
R240013P R240013P/1 R240013V	1	 ÁRBOL DE LEVAS	35	48	7		GALGHD				
R240211P R240211V	1	 BANCADA	90	104	11		GALGRI	Cobalt 2008/10 Astra 2012/...	1998cc.	LNf - Ecotec I4 (DOHC) 16V	291800-R MLS
R240200	1	 KIT DE RETENES					JUEGO	Astra, Vectra 1997/... Astra, Vectra 1997/...	2000cc. 2200cc.	MPFI (SOHC) 8V MPFI (SOHC) 8V	241400-R 241400-R
R240210P R240210V R240210VM/1 R240210VM/2 R240210VM/3	1	 GUÍA VÁLVULAS (8) GUÍA VÁLVULAS (8) A GRANEL (200) A GRANEL (200) A GRANEL (1000)	7	11.1	10		RGV				
R240211P R240211V	1	 BANCADA	90	104	11		GALGRI				
R240012P R240012V	1	 DISTRIBUCIÓN	31	50	8		GALGHD				
R240013P R240013P/1 R240013V	1	 ÁRBOL DE LEVAS	35	48	7		GALGHD				
R241911P	1	 BANCADA	76	92	10		GALGRI	Cavalier 1998/03	2190cc.	LN2 (OHV) 8V	281800-R
R200012N R200012P	1	 DISTRIBUCIÓN	44.47	61.19	9.57		G1LGHD				

CATALOGO DE RETENES

CATALOGO DE RETENTORES - OIL SEAL CATALOG

CHEVROLET / OPEL / GM / VAUXHALL

Código Code	Cant. Qty	Descripción Descrição Descrição	DE [mm]	DA [mm]	H [mm]	A [mm]		Aplicación Aplicação Aplicacion	Cm³ Cm³	Motor Motor Engine	Jgo. Juntas Set Gaskets
R290210P	1	 GUÍA VÁLVULAS R290210P/1	5.97	11.39	11.98		RGV	Lumina, Cavalier 1987/97 SS10 1997/99 Lumina, Cavalier 1994/97	2190cc. 2190cc.	LN2 (OHV) 8V LM3 8V	290200-R 290300-R
R241911P	1	 BANCADA	76	92	10		GALGRI				
R200012N R200012P	1	 DISTRIBUCIÓN	44.47	61.19	9.57		G1LGHD				
R240210P R240210V R240210VM/1 R240210VM/2 R240210VM/3	1	 GUÍA VÁLVULAS (8) GUÍA VÁLVULAS (8) A GRANEL (200) A GRANEL (200) A GRANEL (1000)	7	11.1	10		RGV	S10, Blazer, Omega 1994/...	2198cc.	MPFI/EFI (OHC) 8V	242000-R
R240211P R240211V	1	 BANCADA	90	104	11		GALGRI				
R240013P R240013P/1 R240013V	1	 ÁRBOL DE LEVAS	35	48	7		GALGHD				
R240211P R240211V	1	 BANCADA	90	104	11		GALGRI	Cavalier, Malibu, HHR, Astra Zafira, Vectra, Pontiac Sunfire Grand Am 2000/03	2198cc.	Z22SE - L61 (DOHC) 16V	282100-R
R280700	1	 KIT DE RETENES					JUEGO	Vectra 1998/..., Sintra 1996/99 Astra 2004/..., S10 2005/... Vectra 2006/...	2198cc. 2405cc.	X22 XE (DOHC) 16V Powertrain	290800-R 243400-R MLS
R280610V	1	 GUÍA VÁLVULAS (16) R230510V/1	6	8.8	9.5		RGV				
R240211P R240211V	1	 BANCADA	90	104	11		GALGRI				
R240012P R240012V	1	 DISTRIBUCIÓN	31	50	8		GALGHD				
R240013P R240013P/1 R240013V	2	 ÁRBOL DE LEVAS	35	48	7		GALGHD				
R240200	1	 KIT DE RETENES					JUEGO	Blazer, S10	2405cc.	C24SE (SOHC) 8V	244400-R
R240210P R240210V R240210VM/1 R240210VM/2 R240210VM/3	1	 GUÍA VÁLVULAS (8) GUÍA VÁLVULAS (8) A GRANEL (200) A GRANEL (200) A GRANEL (1000)	7	11.1	10		RGV				
R240211P R240211V	1	 BANCADA	90	104	11		GALGRI				
R240012P R240012V	1	 DISTRIBUCIÓN	31	50	8		GALGHD				
R240013P R240013P/1 R240013V	1	 ÁRBOL DE LEVAS	35	48	7		GALGHD				
R240711P R240711N	1	 BANCADA	95	118	8.5		GALGHI	Luv, Pick Up 1986/92 Campo .../1992 Brava 1990/94	2254cc.	4ZD1 (SOHC) 8V	280400-R
R260312P R260312P/1 R260312V R260312N	1	 DISTRIBUCIÓN	40	56	7		G1ALGHD				
R240713P R240713N	1	 ÁRBOL DE LEVAS	30	45	8		GALGHD				
R280415N	1	 BOMBA DE ACEITE	25	40	8		GALG-BI				

CATALOGO DE RETENES

CATALOGO DE RETENTORES - OIL SEAL CATALOG

























CHEVROLET / OPEL / GM / VAUXHALL

Código Code	Cant. Qty	Descripción Descrição Descripción	DE [mm]	DA [mm]	H [mm]	A [mm]		Aplicación Aplicação Aplicacion	Cm³ Cm³	Motor Motor Engine	Jgo. Juntas Set Gaskets
R240211P R240211V	1	 BANCADA	90	104	11		GALGRI	Captiva 2008/...	2384c.	LE5 (DOHC) 16V	290000-R MLS
R200410N	1	 GUÍA VÁLVULAS (8) R200610N/1	7.27	10.94	2		RGV	Opala 153 1969/73 Opala A10 80/84/610 1976/... Opala, C10, A10 1974/... Comodoro, Caravan, A10 1980/84	2475c. 2475cc.	GM 153 GM 151	240100 240800
R200311P	1	 BANCADA	112.5	130	11		G1ALGRI				
R200012N R200012P	1	 DISTRIBUCIÓN	44.47	61.19	9.57		G1LGHD				
R950212P R950212V	1	 DISTRIBUCIÓN	48	65	10		GAHD				
R240710P	1	 GUÍA VÁLVULAS (8) R240710P/1	8	12	14		RGV	Pick Up Luv	2499cc.	4JA1 (OHV) 8V	240700-R
R240711P R240711N	1	 BANCADA	95	118	8.5		GALGHI				
R240712N	1	 DISTRIBUCIÓN	50	65	10						
R240713N R240713P	1	 ÁRBOL DE LEVAS	30	45	8		GALGHD				
R250412P R250412N	1	 ÁRBOL DE LEVAS	40	56	7		GALGRD				
R550612P R550612V	1	 DISTRIBUCIÓN	50	68	10		GALGRD				
R520310P	1	 GUÍA VÁLVULAS (8) R520310P/1	7	11.4	98		RGV	Frontera A TD 1995/98	2499cc.	VM41B	520301-R
R310411P R310411V	1	 BANCADA	110	130	13		GALGHI				
R520312V	1	 DISTRIBUCIÓN	52	68	9.5		GALGHD				
R242910P	1	 GUÍA VÁLVULAS (8) R242110P/1	7.5	14	12.5		RGV	Pontiac Vin E 1988/92	2500cc.	L4 - 151	242900-RMX
R200811P	1	 BANCADA	75.9	95	11.13		GALGH				
R200012N R200012P	1	 DISTRIBUCIÓN	44.47	61.19	9.57		G1LGHD				
R430010V R430010VM/1 R430010VM/2	1	 GUÍA VÁLVULAS (8) A GRANEL (200) A GRANEL (200)	8	12	9.5	15.2	RGV	Blazer TDI, S10TDI 1995/...	2507cc.	200-300 TDI DIESEL	430001-R
PR430011V PR430011VF	1	 PORTA BANCADA	99.45				PORTA				
R430012V	1	 DISTRIBUCIÓN	57	71	9		GALGRD				
R430013V	1	 ÁRBOL DE LEVAS	46.7	62	9		GALGHD				
R430015N	1	 GUARDAPOLVO CORREA DISTRIB.	57.5	74	8		GASRLG				
430058	2	 EMPAQUETADURA CIGÜEÑAL									
R280610V	1	 GUÍA VÁLVULAS (16) R230510V/1	6	8.8	9.5		RGV	S10, Trail Blazer 2013/...	2776cc.	VM - CTDI DIESEL	291301-R

CATALOGO DE RETENES

CATALOGO DE RETENTORES - OIL SEAL CATALOG

CHEVROLET / OPEL / GM / VAUXHALL

Código Code	Cant. Qty	Descripción Descrição Descrição	DE [mm]	DA [mm]	H [mm]	A [mm]		Aplicación Aplicação Application	Cm³ Cm³	Motor Motor Engine	Jgo. Juntas Set Gaskets
R330510V	1	 GUÍA VÁLVULAS (12) R310810V/1	7	10.9	9.5		RGV	S10 TD, Blazer TD 2000/... Blazer, S10 2000/...	2796cc. 2796cc:	Sprint 4.07 CA DIESEL Sprint 4,07 TCA Common Rail (SOHC) 12V DIESEL	330500-R 331100-R MLS
R330511V	1	 BANCADA	91	111	10		G1ALGRI				
R250811P R250811V R250811N	1	 DISTRIBUCIÓN	64	80	8		G1ALGHD				
R241910P	1	 GUÍA VÁLVULAS (12) R241910P/1	7.4	11.68	16		RGV	Cutlass, Century, Eurosport Cavalier 1989/94	2800cc. 3100cc.	172 V6 2da. Generación Cabeza de Aluminio	241900-RMX
R241911P	1	 BANCADA	76	92	10		GALGRI				
R200012N R200012P	1	 DISTRIBUCIÓN	44.47	61.19	9.57		G1LGHD				
R242110P	1	 GUÍA VÁLVULAS (12) R241910P/1	7.5	14	12.5		RGV	Citation, Celebrity, Century 1982/86	2800cc.	172 V6 12V Carburados	242800-R
R241911P	1	 BANCADA	76	92	10		GALGRI				
R200012N R200012P	1	 DISTRIBUCIÓN	44.47	61.19	9.57		G1LGHD				
R241911P	1	 BANCADA	76	92	10		GALGRI	Malibu 2000/03 Malibu 1997/99 Venture 1997/99	3136cc. 3136cc. 3350cc.	LG8 (OHV) V6 8V LG8 (OHV) V6 12V LA1 (OHV) V6 12V	281700-R 282200-R 282600-R 282000-R
R200012N R200012P	1	 DISTRIBUCIÓN	44.47	61.19	9.57		G1LGHD				
R200010P	1	 GUÍA VÁLVULAS (12)	7.9	17	12.3		RGV	400 1964/72 Super 1964/69, RS Malibu Pick Up Chevy 1969/79	3185cc. 3769cc. 4047cc.	194 230 250	200000-R
R200011P	1	 BANCADA (2 MITADES)	64	78	12		2 PARTES				
R200011-1S	1	 BANCADA (2 MITADES)	64	78	12		2 PARTES				
R200011-2S	1	 BANCADA REFORMA EXPANSIBLE	64	78	12		EXPAN				
R200012N R200012P	1	 DISTRIBUCIÓN	44.47	61.19	9.57		G1LGHD				
R200051N	1	 DIRECTA DE CAJA	31.68	44.45	6.35		G1HD				
200158	1	 EMPAQUETADURA BANCADA (2)					JUEGO				
R200012N R200012P	1	 DISTRIBUCIÓN	44.47	61.19	9.57		G1LGHD	Chevrolet 3 1/2 Chevrolet 3 9/16 1939/53	3540cc. 3674cc.	216 - 224 - 235	200900-R
200158	1	 EMPAQUETADURA BANCADA (2)					JUEGO				
R200610N	1	 GUÍA VÁLVULAS (12)	7.27	10.94	2		RGV	Apache C10 3.9/16 Camión 4400 1957/... Bel Air, Impala 1953/62	3851cc.	235	200400-R
R200012N R200012P	1	 DISTRIBUCIÓN	44.47	61.19	9.57		G1LGHD				
200658	1	 EMPAQUETADURA BANCADA (2)					JUEGO				
R300310P R300310PN/1	1	 GUÍA VÁLVULAS (12) A GRANEL (200)	7.9	15.5	12.5		RGV	D20 D10/20/40 Aspirado Turbo	3860cc. 3860cc.	Q20B4 (OHV) 8V Q20B4.236 (OHV) 8V DIESEL	401000-R 410600-R

CATALOGO DE RETENES

CATALOGO DE RETENTORES - OIL SEAL CATALOG













CHEVROLET / OPEL / GM / VAUXHALL

Código Code	Cant. Qty	Descripción Descrição Descrição	DE [mm]	DA [mm]	H [mm]	A [mm]		Aplicación Aplicação Application	Cm³ Cm³	Motor Motor Engine	Jgo. Juntas Set Gaskets	
R400211P R400211V	1	 BANCADA	133.35	158.75	11/13		GALGRI	D20 D10/20/40 Aspirado Turbo	3860cc. 3860cc.	Q20B4 (OHV) 8V Q20B4.236 (OHV) 8V DIESEL	401000-R 410600-R	
R400012N R400012P R400012V	1	 DISTRIBUCIÓN	60.32	79.36	9.5		GALGHD					
R280310P	1	 GUÍA VÁLVULAS (8) R400210P/1	9.1	12.3	15.1		RGV	D20/D40, Pick Up D20	3900cc.	Maxion S4 DIESEL	280300-R	
R300310P R300310PN/1	1	 GUÍA VÁLVULAS (8) A GRANEL (200)	7.9	15.5	12.5		RGV					
R400211P R400211V	1	 BANCADA	133.35	158.75	11/13		GALGRI	Pick Up C10 1989/...	4097cc.	250	200300-R	
R400012N R400012P R400012V	1	 DISTRIBUCIÓN	60.32	79.36	9.5		GALGHD					
R200010P	1	 GUÍA VÁLVULAS (12) R200010P/1	7.9	17	12.3		RGV	Pick Up C10 1989/...	4097cc.	250	200300-R	
R200610N	1	 GUÍA VÁLVULAS (12) R200610N/1	7.27	10.94	2		RGV					
R200311P	1	 BANCADA	112.5	130	11		G1ALGRI	Silverado, Pick Up 7B 1980/... Cheyenne 1979/81	4097cc.	250	200500	
R200011-1S	1	 BANCADA (2 MITADES)	64	78	12		2 PARTES					
R200011-2S	1	 BANCADA REFORMA EXPANSIBLE	64	78	12		EXPAN	R200012N R200012P	44.47	61.19	9.57	G1LGHD
R200012N R200012P	1	 DISTRIBUCIÓN	44.47	61.19	9.57		G1LGHD					
200658	1	 EMPAQUETADURA BANCADA (2)					JUEGO	R200010P	44.47	61.19	9.57	G1LGHD
R200010P	1	 GUÍA VÁLVULAS (12) R200010P/1	7.9	17	12.3		RGV					
R200012N R200012P	1	 DISTRIBUCIÓN	44.47	61.19	9.57		G1LGHD	R200311P	112.5	130	11	G1ALGRI
R200311P	1	 BANCADA	112.5	130	11		G1ALGRI					
R330610V	1	 GUÍA VÁLVULAS (18) R310810V/1	6	10.6	9.5		RGV	GM Silverado 3500HD 1997/... Grand Blazer 1998/...	4200cc.	Sprint 6.07 TD Turbo Intercooler (SOHC) 18V DIESEL	330600-R	
R330511V	1	 BANCADA	91	111	10		G1ALGRI					
R250811P R250811V R250811N	1	 DISTRIBUCIÓN	64	80	8		G1ALGHD	Camión 3 3/4 6500 1954/62 C10, C 14, C60 BR 1969/...	4277cc.	261	200600-R	
R200610N	1	 GUÍA VÁLVULAS (12) R200610N/1	7.27	10.94	2		RGV					
R200012N R200012P	1	 DISTRIBUCIÓN	44.47	61.19	9.57		G1LGHD	R290611S	91.5	114.8	12.5	G1ALGHD
200658	1	 EMPAQUETADURA BANCADA (2)					JUEGO					
R290611S	1	 BANCADA	91.5	114.8	12.5		G1ALGHD	Capriche, Impala, Regal, Blazer MPFI 1996/98	4294cc.	262 V6	290600-R	
R200012N R200012P	1	 DISTRIBUCIÓN	44.47	61.19	9.57		G1LGHD					













CATALOGO DE RETENES

CATALOGO DE RETENTORES - OIL SEAL CATALOG

CHEVROLET / OPEL / GM / VAUXHALL

Código Code	Cant. Qty	Descripción Descrição Descrição	DE [mm]	DA [mm]	H [mm]	A [mm]		Aplicación Aplicação Aplicacion	Cm³ Cm³	Motor Motor Engine	Jgo. Juntas Set Gaskets
R242110P	1	 GUÍA VÁLVULAS (12) R242110P/1	7.5	14	12.5		RGV	Pick Up 1988/93 Pick Up 1986/92	4300cc. 4300cc.	262 V6 12V 262 TK V6 12V	242100-RMX 242700-RMX
R200012N R200012P	1	 DISTRIBUCIÓN	44.47	61.19	9.57		G1LGHD				
R280110P	1	 GUÍA VÁLVULAS (16) R280110P/1	8.68	14.27	17.19		RGV	283/302/307/327 Carburador 327, 350 No Corvette, 350 Pick Up y Medianos 283/307/327 Camiónes 1967/...	5735cc.	C350 V8 Ø101.6	280100-R
R280111P	1	 BANCADA	95	115	12		GALGRI				
R200011-1S	1	 BANCADA (2 MITADES)	64	78	12		2 PARTES				
R200012N R200012P	1	 DISTRIBUCIÓN	44.47	61.19	9.57		G1LGHD				
R281110P	1	 GUÍA VÁLVULAS (16) R280110P/1	8	14	12.9		RGV	Truck 1996/01, Vortec Vin R	5735cc.	C350 V8	281100-RMX
R200012N R200012P	1	 DISTRIBUCIÓN	44.47	61.19	9.57		G1LGHD				
R410912N	1	 DISTRIBUCIÓN	50.9	69.8	9.5		GAHD	Brasil D60 - D70	5840cc.	6-357 Vehicular/Agrícola/Ind.	410900-R
400158	1	 EMPAQUETADURA BANCADA (2)					JUEGO				
R281110P	1	 GUÍA VÁLVULAS (16) R281110P/1	8	14	12.9		GAHD	Truck 1996/01, Vortec Vin R	5735cc.	C350 V8 Ø101.6	281100-RMX
R200012N R200012P	1	 DISTRIBUCIÓN	44.47	61.19	9.57		G1LGHD				

























CHRYSLER - DODGE - JEEP

R271210V R271210VM/2	1	 GUÍA VÁLVULAS (8) A GRANEL (200)	5	7.8	8		RGV	Rapid Promaster 2017/20	1368cc.	Fire Evo 8V	271900-R MLS
PR271911VF	1	 PORTA BANCADA	74				PORTA				
R270713V R270713P R270713P/1	1	 ÁRBOL DE LEVAS	40	55	7		G1ALGHD				
R270515V	1	 BOMBA DE ACEITE	27	37	7		G1ALGHD				
R220100	1	 KIT DE RETENES					JUEGO				
R220200	1	 KIT DE RETENES					JUEGO	D1500, GT90, GT100 Paikan 1971/... D1800 - Paikan 1971/...	1498cc. 1798cc.	Hillman Hillman	220100-R 220100-R
R220110P	1	 GUÍA VÁLVULAS (8) R300310P/1	7.9	15.5	12.5		RGV				
R220210P	1	 GUÍA VÁLVULAS (8) R220210P/1	7.9	14.8	9.2		RGV				
R220111N R220111P	1	 BANCADA	76.2	95.22	9.32		GARI				
R220112P R220112N	1	 DISTRIBUCIÓN	44.45	63.5	9.52		GAHD				
R220150N	1	 SALIDA CAJA VELOCIDAD	34.92	56	10.7		GALGRI				
R220158N	1	 RUEDA DELANTERA	44.45	53.97	4.57		GA				
220131	2	 BASTÓN CIERRE BANCADA									

CATALOGO DE RETENES

CATALOGO DE RETENTORES - OIL SEAL CATALOG























CHRYSLER - DODGE - JEEP

Código Code	Cant. Qty	Descripción Descrição Descrição	DE [mm]	DA [mm]	H [mm]	A [mm]		Aplicación Aplicação Application	Cm³ Cm³	Motor Motor Engine	Jgo. Juntas Set Gaskets
R272010P	1	 GUÍA VÁLVULAS (8) R272010P/1	6	11	18.3		RGV	Renegade	1598cc.	E.torq Evo	273700-R MLS
R330511V	1	 BANCADA	91	111	10		G1ALGRI				
R230412P	1	 DISTRIBUCIÓN	32	45	6.5		GALGRD				
R270713P R270713P/1 R270713V	1	 ÁRBOL DE LEVAS	40	55	13		G1ALGHD				
R230410P	1	 GUÍA VÁLVULAS (16) R230410P/1	6	10.9	18		RGV	Neón 1997/99 Neón, Cirrus, Stratus, Voyager 1996/01	1796cc. 1996cc.	122 CID (SOHC) 16V ECB/420H (SOHC) 16V	230400-R
R330511V	1	 BANCADA	91	111	10		G1ALGRI				
R230412P	1	 DISTRIBUCIÓN	32	45	6.5		GALGRD				
R240013P R240013P/1 R240013V	1	 ÁRBOL DE LEVAS	35	48	7		GALGHD				
R460300	1	 KIT DE RETENES					JUEGO	Jeep JPX	1905cc.	XUD9 (SOHC) 8V DIESEL	460301-R
R460210V	1	 GUÍA VÁLVULAS (8) R250410V/1	8	10.8	10		RGV				
R460211V	1	 BANCADA	90	110	7		GALGRI				
R460212P R460212V	1	 DISTRIBUCIÓN	42	62	7		GALGHD				
R470013P R470013P/1 R470013V	1	 ÁRBOL DE LEVAS	35	50	7		GALG-BI				
460235	2	 BASTÓN CIERRE BANCADA									
R253010V	1	 GUÍA VÁLVULAS (16) R253010V/1	5	10	15.5	23.48	RGV	Jeep Renegade 2015/...	1956cc.	Multijet TD (DOHC) 16V DIESEL	253001-R
PR270911V	1	 PORTA BANCADA	93				PORTA				
R250255N	1	 DISTRIBUCIÓN	30	45	8		GA				
R550600	1	 KIT DE RETENES					JUEGO	Wrangler 1983/86	1995cc.	J5R (SOHC) 8V	550600-R
R550610P	1	 GUÍA VÁLVULAS (16) R250410V/1	8	10.8	10		RGV				
R550610T	1	 GUÍA VÁLVULAS (16) R450010T/1	8	10.8	10		RGV				
R550611P R550611V	1	 BANCADA	90	110	13		GALGRI				
R550612P R550612V	1	 DISTRIBUCIÓN	50	68	10		GALGRD				
R550613P R550613P/1 R550613V	1	 ÁRBOL DE LEVAS	35	47	7		GAHD				
R550614V	1	 AUXILIAR BOMBA DE NAFTA	8.1	14.3	4.2		U'RING				

CATALOGO DE RETENES

CATALOGO DE RETENTORES - OIL SEAL CATALOG





CHRYSLER - DODGE - JEEP

Código Code	Cant. Qty	Descripción Descrição Descrição	DE [mm]	DA [mm]	H [mm]	A [mm]		Aplicación Aplicação Application	Cm³ Cm³	Motor Motor Engine	Jgo. Juntas Set Gaskets				
R550615P R550615V R550615N	1	 AUXILIAR	30	40	7		GAHD	Wangler 1983/86	1995cc.	J5R (SOHC) 8V	550600-R				
R550648N	1	 CAJA DE VELOCIDAD	16	22.8	4.8		GA								
R550655N	1	 RUEDA TRASERA	60	70	9.1		ESP								
R550660N	1	 CAJA DE VELOCIDAD	26	42	8/17		EGALG								
550658	1	 EMPAQUETADURA BANCADA (4)					JUEGO								
R230410P	1	 GUÍA VÁLVULAS (16) R230410V/1	6	10.9	18	26.9	RGV	Neón, Sebring, Avenger 1995/...	1996cc.	4A20 (DOHC) 16V	230800-R				
R330511V	1	 BANCADA	91	111	10		G1ALGRI								
R230412P	1	 DISTRIBUCIÓN	32	45	6.5		GALGRD								
R240013P R240013P/1 R240013V	1	 ÁRBOL DE LEVAS	35	48	7		GALGHD								
R521010P	1	 GUÍA VÁLVULAS (16) R272010P/1	6	11	18.3		RGV								
R330511V	1	 BANCADA	91	111	10		G1ALGRI	Neon 2000/05 PT Crusier 2002/05	1996cc. 1996cc.	ECB (SOHC) 16V ECC (DOHC) 16V	521000-R 521100-R MLS				
R230412P	1	 DISTRIBUCIÓN	32	45	6.5		GALGRD								
R240013P R240013P/1 R240013V	2	 ÁRBOL DE LEVAS	35	48	7		GALGHD								
R550600	1	 KIT DE RETENES					JUEGO								
R550610P	1	 GUÍA VÁLVULAS (16) R250410V/1	8	10.8	10		RGV								
R550610T	1	 GUÍA VÁLVULAS (16) R450010T/1	8	10.8	10		RGV	Jeep Wagoneer TD 1984/95 Comanche TD 1986/88	2068cc.	852/J8S (SOHC) 8V	560001-R				
R550611P R550611V	1	 BANCADA	90	110	13		GALGRI								
R550612P R550612V	1	 DISTRIBUCIÓN	50	68	10		GALGRD								
R550613P R550613P/1 R550613V	1	 ÁRBOL DE LEVAS	35	47	7		GAHD								
R550615P R550615V R550615N	1	 AUXILIAR	30	40	7		GAHD								
550658	1	 EMPAQUETADURA BANCADA (4)					JUEGO								
R520210P	1	 GUÍA VÁLVULAS (8) (R300310P/1)	7.9	15.5	12.5		RGV					Lebaron, Spirit, Shadow Voyager, Phantom Caravan, Daytona 1982/98	2213cc.	135 (EDR) (SOHC) 8V	520200-R
R330511V	1	 BANCADA	91	111	10		G1ALGRI								

























CATALOGO DE RETENES

CATALOGO DE RETENTORES - OIL SEAL CATALOG

CHRYSLER - DODGE - JEEP

Código Code	Cant. Qty	Descripción Descrição Descrição	DE [mm]	DA [mm]	H [mm]	A [mm]		Aplicación Aplicação Application	Cm³ Cm³	Motor Motor Engine	Jgo. Juntas Set Gaskets
R520212P	3	 ÁRBOL DE LEVAS AUXILIAR	35	52	8		GALGHD	Lebaron, Spirit, Shadow Voyager, Phantom Caravan, Daytona 1982/98	2213cc.	135 (EDR) (SOHC) 8V	520200-R
R300051N	1	 DIRECTA CAJA DE VELOCIDAD	28.58	41.2	6.2		G1HD	Lebaron, Daytona Turbo 1982/98	2213cc.	135 (EDR) (SOHC) 8V	521200-R
R520811P	1	 BANCADA	80	96	9		GALGRI	Pick Up Power Ram 50 TD 1983/85	2346cc.	4D55T (SOHC) 8V DIESEL	910500-R
R950312P R950312S	1	 DISTRIBUCIÓN	44	60	7		GALGHD				
R470013P R470013P/1 R470013V	1	 DISTRIBUCIÓN	35	50	7		GALG-BI				
R250156N	1	 AUXILIAR	25	35	7		GA				
R521010P	1	 GUÍA VÁLVULAS (16) R272010P/1	6	11	18.3		RGV	Stratus, Cirrus, Voyager Plymouth Breeze, Caravan Grand Caravan, Grand Voyager 1995/00 PT Cruiser 2002/05	2429cc.	EDZ (DOHC) 16V	521400-R
R330511V	1	 BANCADA	91	111	10		G1ALGRI				
R230412P	1	 DISTRIBUCIÓN	32	45	6.5		GALGRD				
R240013P R240013P/1 R240013V	2	 ÁRBOL DE LEVAS	38	48	7		GALGHD				
R521010P	1	 GUÍA VÁLVULAS (16) R272010P/1	6	11	18.3		RGV	Stratus 2002/6	2429cc.	EDZ (DOHC) 16V	521500-R
R330511V	1	 BANCADA	91	111	10		G1ALGRI	Dakota, Pick Up, Jeep Cherokee, Comanche Wrangler, Renegade 1991/96	2464cc.	D150	510400-R
R240013P R240013P/1 R240013V	2	 DISTRIBUCIÓN	38	48	7		GALGHD				
R510410P	1	 GUÍA VÁLVULAS (8) R510410P/1	8	13.5	13		RGV				
R540012P R540012N	1	 DISTRIBUCIÓN	52.38	81.02	11		GALGHD	Jeep Continental 1954/74	2470cc.	4L - 151	540000-R
R540057	1	 PIÑÓN	39.68	80.29	7/16		ESP-RD				
540058	1	 EMPAQUETADURA BANCADA (2)					JUEGO				
R520310P	1	 GUÍA VÁLVULAS (8) R520310P/1	7	11.4	9.8		RGV	Dakota TD, Grand Voyager TD 1995/..., Jeep Cherokee Grand Cherokee TD 1997/...	2499cc.	VM425TD DIESEL	520301-R
R310411P R310411V	1	 BANCADA	110	130	13		GALGHI				
R520312V	1	 DISTRIBUCIÓN	52	68	9.5		GALGHD				
R500411P	1	 BANCADA	90	120	12		G1ALGHI	Voyager TD Grand Voyager TD 1992/94	2499cc.	HR425CLI (M00) (OHV) 8V DIESEL	500401
R500412P	1	 DISTRIBUCIÓN	56	80	10		GAHD				
R540210P	1	 GUÍA VÁLVULAS (12) R300310P/1	7.9	14	13.2		RGV	Rambler, Utilitario Gladiator, Jeep T80 1966/73 Rambler Gladiator 1966/73	2966cc.	OHC 181 4B 300/300S/38	540200-R
									2966cc.		OHC 181/230/300

CHRYSLER - DODGE - JEEP

Código Code	Cant. Qty	Descripción Descrição Descrição	DE [mm]	DA [mm]	H [mm]	A [mm]		Aplicación Aplicação Aplicacion	Cm³ Cm³	Motor Motor Engine	Jgo. Juntas Set Gaskets
R540012P R540012N	1	 BANCADA	52.38	81.02	11		GALGHD	Rambler, Utilitario Gladiator, Jeep T80 1966/73 Rambler Gladiator 1966/73	2966cc. 2966cc.	OHC 181 4B 300/300S/38 OHC 181/230/300	540200-R 540400-R
540058	1	 EMPAQUETADURA BANCADA (2)					JUEGO				
R520210P	1	 GUÍA VÁLVULAS (8) (R300310P/1)	7.9	15.5	12.5		RGV	Caravan, Grand Caravan Saratoga, Grand Voyager Voyager, Caravan, Lebaron Daytona 1986/95	2501cc.	EDM (K00) EDT (SOHC) 8V	520200-R
R330511V	1	 BANCADA	91	111	10		G1ALGRI	Voyager, Caravan, Saratoga Lebaron, Daytona 1989/...	2501cc.	153 (EDT) (SOHC) 8V	521200-R
R520212P	3	 ÁRBOL DE LEVAS AUXILIAR	35	52	8		GALGHD				
R300051N	1	 DIRECTA CAJA DE VELOCIDAD	28.58	41.2	6.2		G1HD				
R520811P	1	 BANCADA	80	96	9		GALGRI	Pick Up D50, Colt 1978/80 Pick Up 1982/...	2555cc. 2555cc.	4G54B (SOHC) 8V 4G54B (SOHC) 8V	964800-R 964900-R
R520812P	1	 DISTRIBUCIÓN	48	68	11		GALGHD				
R520810P	1	 GUÍA VÁLVULAS (8) GUÍA VÁLVULAS (4)	8 8	13 5	13.5 8		RGV	Pick Up, Lebaron, Caravan 1981/89	2555cc.	G54B (SOHC) 12V	520800-RMX
R520811P	1	 BANCADA	80	96	9		GALGRI				
R520812P	1	 DISTRIBUCIÓN	48	68	11		GALGHD				
R352410V	1	 GUÍA VÁLVULAS (20) R260610V/1	7	9.8	10		RGV	Grand Cherokee TD 2002/...	2685cc.	ENF (DOHC) 20V DIESEL	352401-R
PR351211T	1	 PORTA BANCADA	93				PORTA				
R351112V	1	 DISTRIBUCIÓN	45	67	8		GALGHD				
R300010P R300010PN/1	1	 GUÍA VÁLVULAS (12) A GRANEL (144)	7.9	15.5	12.5		RGV	Valiant I/II/III/IV D100 D2800, Polara, Coronado RT 1964/79	2788cc.	170 1	220000-R
R220012N	1	 DISTRIBUCIÓN	53.97	80.96	14.68		E-GARD				
R220013P	1	 ÁRBOL DE LEVAS	57.15	80.98	11.5		GALGRD				
220058	1	 EMPAQUETADURA BANCADA (2)					JUEGO				
R520410P	1	 GUÍA VÁLVULAS (10) R520310P/1	7	11.4	9.8		RGV	Jeep Cherokee Grand Cherokee Dakota, Caravan 2001/...	3100cc.	VM531TD DIESEL	520401-R
R310411P R310411V	1	 BANCADA	110	130	10		GALGHI				
R520312V	1	 DISTRIBUCIÓN	52	68	9.5		GALGHD				
R510010P	1	 GUÍA VÁLVULAS (12) R510010P/1	7.4	10.8	13.9		RGV	Caravan, Grand Caravan Imperial, Voyager, New Yorker Grand Voyager Town & Country 1990/99	3301cc.	201 (R00) (OHV) V6 12V	510000-R
R330511V	1	 BANCADA	91	111	10		G1ALGRI				
R510012P	1	 DISTRIBUCIÓN	28.5	41.25	6		GALGHD				
R400000 R400000-1	1	 KIT DE RETENES					JUEGO	D100/D200 1987/...	3336cc.	4.203-P4-192Z (OHV) 8V DIESEL	400000-R

























CATALOGO DE RETENES

CATALOGO DE RETENTORES - OIL SEAL CATALOG

CHRYSLER - DODGE - JEEP

Código Code	Cant. Qty	Descripción Descrição Descrição	DE [mm]	DA [mm]	H [mm]	A [mm]		Aplicación Aplicação Application	Cm³ Cm³	Motor Motor Engine	Jgo. Juntas Set Gaskets
R300310P R300310PN/1	1	 GUÍA VÁLVULAS (8) A GRANEL (200)	7.9	15.5	12.5		RGV	D100/D200 1987/...	3336cc.	4.203-P4-192Z (OHV) 8V DIESEL	40000-R
R400010P R400010P/1	1	 GUÍA VÁLVULAS (8) A GRANEL (200)	7.9	14	13.2		RGV				
R400211P R400211V	1	 BANCADA	133.35	158.75	11/13		GALGHD				
R400012P R400012V R400012N	1	 DISTRIBUCIÓN	60.32	79.36	9.5		GALGHD				
400158	1	 EMPAQUETADURA BANCADA (2)					JUEGO				
R330511V	1	 BANCADA	91	111	10		G1ALGRI	Concorde, New Yorker LHS	3518cc.	EGE (DOHC) V6 24V	52200-R
R300051N	1	 DIRECTA CAJA DE VELOCIDAD	28.58	41.2	6.2		G1HD				
R300010P R300010PN/1	1	 GUÍA VÁLVULAS (12) A GRANEL (144)	7.9	15.5	12.5		RGV	Valiant I/II/III/IV D100 Polara, Coronado, RT 1964/79	3687cc.	225	22000-R
R220012N	1	 DISTRIBUCIÓN	53.97	80.96	14.68		E-GARD				
R220013P	1	 ÁRBOL DE LEVAS	57.15	80.98	11.5		GALGRD				
220058	1	 EMPAQUETADURA CIGÜEÑAL (2)					JUEGO				
R540012P R540012N	1	 BANCADA	52.38	81.02	11		GALGHD	Estanciera, Baqueano Gladiator, Continental, Kaiser Carabela, Manhattan 1955/... Bergantín Super 1954/67	3705cc.	L226	540100-R
540058	1	 EMPAQUETADURA CIGÜEÑAL (2)					JUEGO				
R510010P	1	 GUÍA VÁLVULAS (12) R510010P/1	7.4	10.8	13.9		RGV	Caravan, Grand Caravan Voyager, Grand Voyager New Yorker, Imperial Town & Country 1991/99	3778cc.	231 (L00) (OHV) V6 12V	510100-R
R330511V	1	 BANCADA	91	111	10		G1ALGRI				
R510012P	1	 DISTRIBUCIÓN	28.5	41.25	6		GALGHD				
R330511V	1	 BANCADA	91	111	10		G1ALGRI	Voyager 2002/06 Pacífica 2004/07	3778cc.	EGH (OHV) V6 16V	521600-R
R5100012P	1	 DISTRIBUCIÓN	28.5	41.25	6		G1LGHD				
R510510P R510510V	1	 GUÍA VÁLVULAS (12)	8	13.48	17.2		G1ALGRI	Dakota Pick Up 1996/...	3908cc.	EHC (OHV) V6 12V	510500-R 510500
R510511P	1	 BANCADA					2 MITADES				
R510512P R510512V	1	 DISTRIBUCIÓN	55	81	15.8		G1LGHD				
R510512P R510512V	1	 DISTRIBUCIÓN	55	81	15.8		G1LGHD	Pick Up V6 1987/91	3910cc.	239 CID V6	520100-R
R510812P	1	 DISTRIBUCIÓN	45	57.15	9.5		GALGHD	Grand Cherokee Laredo, Cherokee Sport, Comanche, Wagoneer, Wrangler 1986/91 Grand Wagoneer 1984/88, Pick Up 1981/88, Scrambler 1981/86, Jeep CJ/DJ 1981/86 Wrangler, Jeep YJ 1986/90	3960cc.	240 - 242/L	220900
									4200cc.	258 AMC Jeep	510800-R
									4200cc.	258 AMC Jeep	510900-R









CHRYSLER - DODGE - JEEP

Código Code	Cant. Qty	Descripción Descrição Descrição	DE [mm]	DA [mm]	H [mm]	A [mm]		Aplicación Aplicação Application	Cm³ Cm³	Motor Motor Engine	Jgo. Juntas Set Gaskets
R400100	1	 KIT DE RETENES					JUEGO	DP 400/500 1964/...	5004cc.	6.305 Cadenero (SOHC) 12V DIESEL	400100-R
R400110P	1	 GUÍA VÁLVULAS (12) R40010P/1	7.9	12.75	12.8		RGV				
R540210P	1	 GUÍA VÁLVULAS (12) R300310P/1	7.9	14	13.2		RGV				
R400012P R400012V R400012N	1	 DISTRIBUCIÓN	60.32	79.36	9.5		GALGHD				
400158	1	 EMPAQUETADURA BANCADA (2)					JUEGO				
R310510V	1	 GUÍA VÁLVULAS (12) R310410V/1	9	13.4	11		RGV	Camión 1978/...	5100cc.	D225-6 DIESEL	440100-R
R310411P R310411V	1	 BANCADA	100	130	13		GALGHI				
R310412P R310412V	1	 DISTRIBUCIÓN	78	100	13		GALGHD				
R510210P	1	 GUÍA VÁLVULAS (12) R300310P/1	7.9	15.5	12.5		RGV	Barracuda, Super Bee 1970/74	5210cc.	318 LA V8	510200-R
R510512P R510512V	1	 DISTRIBUCIÓN	55	81	15.8		G1LGHD				
R510710P	1	 GUÍA VÁLVULAS (16) R510510P/1	8	13.48	17.2		RGV	Grand Cherokee 1993/...	5210cc.	318 (OHV) V8 16V	510700-R
R510512P R510512V	1	 DISTRIBUCIÓN	55	81	15.8		G1LGHD				
PR521911T	1	 PORTA BANCADA	98				PORTA	Ram 2500, Ram 3500 Ram Quad, Charger Jeep Comander, Sonora 300C, Grand Cherokee, Aspen	5645cc.	EZB - Hemi (OHV) V8 16V	521900-RMX
R400200-1	1	 KIT DE RETENES					JUEGO	DP 600/800 1968/... D600/800 1976/...	5798cc. 5798cc.	6.354-2 6.354-4 (OHV) 12V DIESEL	400200-R 400400-R
R400210P	1	 GUÍA VÁLVULAS (12) R400210P/1	9.1	12.3	15.1		G1LGHD				
R400211P R400211V	1	 BANCADA	133.35	158.75	11/13		G1LGHD				
R400012P R400012V R400012N	1	 DISTRIBUCIÓN	60.32	79.36	9.5		GALGHD				
R400213N	1	 ÁRBOL DE LEVAS	22.22	34.92	6.35		GA				
R400215N	1	 AUXILIAR	22.22	35.7	9.52		ESP-RD				
400158	1	 EMPAQUETADURA CIGÜEÑAL (2)					JUEGO				
R400210P	1	 GUÍA VÁLVULAS (12) R400210P/1	9.1	12.3	15.1		G1LGHD	DP 600/800	5798cc.	6.354-1 (OHV) 12V DIESEL	400900-R
R400012P R400012V R400012N	1	 DISTRIBUCIÓN	60.32	79.36	9.5		G1LGHD				
R400215N	1	 AUXILIAR	22.22	35.7	9.52		ESP-RD				
400158	1	 EMPAQUETADURA BANCADA (2)					JUEGO				

CATALOGO DE RETENES

CATALOGO DE RETENTORES - OIL SEAL CATALOG









CHRYSLER - DODGE - JEEP

Código Code	Cant. Qty	Descripción Descrição Descrição	DE [mm]	DA [mm]	H [mm]	A [mm]		Aplicación Aplicação Application	Cm³ Cm³	Motor Motor Engine	Jgo. Juntas Set Gaskets
R410912N	1	 DISTRIBUCIÓN	50.9	69.8	9.5		GAHD	P700D/ P900	5840cc.	6-357 Vehicular/Agrícola/Ind. DIESEL	410900-R
400158	1	 EMPAQUETADURA BANCADA (2)					JUEGO				
R870110P	1	 GUÍA VÁLVULAS (12) R870010P/1	8	12.7	9.5		RGV	Dodge Truck 359 1989/93 Ram 2007/...	5883cc.	6B (SOHC) 12V DIESEL	870100-R
R870011V R870011VF	1	 BANCADA	130	150	12/13		GALGRI				
R870012V R870012VF	1	 DISTRIBUCIÓN	63.5	79.5	9		G1ALGRD				
R520510P	1	 GUÍA VÁLVULAS (16) R520510P/1	8.49	13.69	14.4		RGV				
R510512P R510512V	1	 DISTRIBUCIÓN	55	81	15.8		GALGRI	Charger, Dart GTS, Le Baron Cordoba, Monaco, Super Bee Camiónes Ligeros D350/D600 1979/92	5899cc.	360 Con Carburador y T.B.I (OHV) V8 16V	520500-RMX
400158	1	 EMPAQUETADURA BANCADA (2)					JUEGO				























CIMARRON

R210010P	1	 GUÍA VÁLVULAS (8) R300010P/1	7.9	15.5	12.5		RGV	1986/... 1976/85 1979/85 1986/...	3283cc. 3285cc. 3840cc. 3840cc.	3300D DIESEL 3300D DIESEL 3800D DIESEL 3800D DIESEL	210500-R 210400-R 210600-R 210700-R
R210011N	1	 BANCADA	118	143	13		GARI				
R210012N	1	 DISTRIBUCIÓN	49.2	65.9	12.7		GALGHD				

CITROËN

R150000	1	 KIT DE RETENES					JUEGO	2CV, AZ, AZAM, AZN, AZU, AZUB 1966/68 2CV, AZL 1968/69	425cc.	A 79/0 (OHV) 4V	150000-R				
R150010P	1	 GUÍA VÁLVULAS (4) R250410V/1	8	10.8	10		RGV		425cc.	A 79/1 (OHV) 4V	150100-R				
R150010T	1	 GUÍA VÁLVULAS (4) R450010T/1	8	10.8	10		RGV	3CV 1969/78 Ami 8, Mehari, Dyane, 3CV	602cc. 602cc.	M28/0 - M28/1 (OHV) 4V M28/0 - M28/1 (OHV) 4V	150200-R 150300-R				
R150011N	1	 BANCADA	48	65	10		GALGHI								
R150012N	1	 DISTRIBUCIÓN	30	42.04	8		GALGHD								
R150211N	1	 BANCADA	55.95	69.1	10	70.7	GAHI								
R150012N	1	 DISTRIBUCIÓN	30	42.04	8		GALGHD								
R460710V R460710P	1	 GUÍA VÁLVULAS (8) R260610V/1	7	9.8	10		RGV					C15 1988/..., AX 10 1986/... Saxo 1996/...	954cc.	TU9 - TU9M (SOHC) 8V	451500-R
R220411P R220411P/1 R220411V R220411VF	1	 BANCADA	85	105	12		GALGRI								











CITROËN

Código Code	Cant. Qty	Descripción Descrição Descrição	DE [mm]	DA [mm]	H [mm]	A [mm]		Aplicación Aplicação Aplicacion	Cm³ Cm³	Motor Motor Engine	Jgo. Juntas Set Gaskets
R460712V	1	 DISTRIBUCIÓN	42	66	8		GALGHD	C15 1988/..., AX 10 1986/... Saxo 1996/...	954cc.	TU9 - TU9M (SOHC) 8V	451500-R
R460213P R460213V	1	 ÁRBOL DE LEVAS	36	50	8		GALGHD				
PR472111T	1	 PORTA BANCADA	85				PORTA	C4 Cactus 2014/... C4 Grand Picasso 2014/... C3 Picasso, DS3, DS4 2015/... C4 Picasso 2016/...	1199cc.	EB2DTS (HNY) EB2DT (HNZ) (DOHC) 12V	472100-R MLS
R460710V R460710P	1	 GUÍA VÁLVULAS (8) R260610V/1	7	9.8	10		RGV	Saxo, Berlingo, ZX 1996/... AX11 1986/97, BX 11 C15 1988/..., ZX 1991/98	1124cc. 1124cc.	TU1M (SOHC) 8V TU1M/MZ (SOHC) 8V (Motor c/block aluminio)	451500-R 451700-R
R220411P R220411P/1 R220411V R220411VF	1	 BANCADA	85	105	12		GALGRI				
R460712V	1	 DISTRIBUCIÓN	42	66	8		GALGHD				
R460213P R460213V	1	 ÁRBOL DE LEVAS	36	50	8		GALGHD				
R460700	1	 KIT DE RETENES					JUEGO	AX 11, BX 11, C15 1986/... ZX 1991/95 AX Sport 1987/91 C2/C3, C3 Pluriel 2002/... Berlingo 1997/... BX 14, C15 1988/... Saxo 1996/..., AX 14 AX GT 1986/..., ZX 1991/98 Berlingo, Xsara 1996/...	1124cc. 1294cc. 1360cc. 1360cc.	TU1M/MZ (SOHC) 8V TU24/M4A (SOHC) 8V TU3JP (KFW) (SOHC) 8V TU3-2 (K5A) (SOHC) 8V TU3MC/JP/A (SOHC) 8V	460700-R 460700-R 452200-R 452200-R 460700-R
R460710V R460710P	1	 GUÍA VÁLVULAS (8) R260610V/1	7	9.8	10		RGV				
R560111P R560111V	1	 BANCADA	85	105	8		GALGRI				
R460712V	1	 DISTRIBUCIÓN	42	66	8		GALGHD				
R460213P R460213V	1	 ÁRBOL DE LEVAS	36	50	8		GALGHD				
R460710V R460710P	1	 GUÍA VÁLVULAS (8) R260610V/1	7	9.8	10		RGV	AX14, BX14 1991/... ZX 1994/..., AX GT 1993/... C15 1991/...	1360cc.	TU3F-TU3FM- TU3F2C (SOHC) 8V (Motor con block de fundición gris)	451600-R
R560111P R560111V	1	 BANCADA	85	105	8		GALGRI				
R460712V	1	 DISTRIBUCIÓN	42	66	8		GALGHD				
R460213P R460213V	2	 ÁRBOL DE LEVAS	36	50	8		GALGHD				
R460710V R460710P	1	 GUÍA VÁLVULAS (8) R260610V/1	7	9.8	10		RGV	BX 14, C15 1988/... AX 14, AX GT 1986/... ZX 1991/98, Saxo, Berlingo Xsara 1996/...	1360cc.	TU3M/S/A/MC/JP (SOHC) 8V (Motor c/block aluminio)	451700-R
R220411P R220411P/1 R220411V R220411VF	1	 BANCADA	85	105	12		GALGRI				
R460712V	1	 DISTRIBUCIÓN	42	66	8		GALGHD				
R460213P R460213V	1	 ÁRBOL DE LEVAS	36	50	8		GALGHD				
R460710V R460710P	1	 GUÍA VÁLVULAS (8) R260610V/1	7	9.8	10		RGV	AX 14 1988/94	1360cc.	TUD3(K9A) (SOHC) 8V DIESEL	470400-R
R220411P R220411P/1 R220411V R220411VF	1	 BANCADA	85	105	12		GALGRI				
R460712V	1	 DISTRIBUCIÓN	42	66	8		GALGHD				























CATALOGO DE RETENES

CATALOGO DE RETENTORES - OIL SEAL CATALOG

CITROËN

Código Code	Cant. Qty	Descripción Descrição Descrição	DE [mm]	DA [mm]	H [mm]	A [mm]		Aplicación Aplicação Aplicacion	Cm³ Cm³	Motor Motor Engine	Jgo. Juntas Set Gaskets								
R460213P R460213S R460213V	1	 ÁRBOL DE LEVAS	36	50	8		GALGHD	AX 14 1988/94	1360cc.	TUD3(K9A) (SOHC) 8V DIESEL	470400-R								
R471710V	1	 GUÍA VÁLVULAS (16) R471710V/1	5	9	18	22.6	RGV	C3 Picasso, C3 2009/... DS3 2010/...	1397cc.	EP3 (8FS/8FP) EP3C (8F01) (DOHC) 16V	471700-R MLS								
R560111P R560111V	1	 BANCADA	85	105	8		GALGRI												
R302110V	1	 GUÍA VÁLVULAS (8) R302110V/1	6	9	17.5	23	RGV	C3/C2 HDI, Xsara HDI 2002/...	1398cc.	DV4TD (8HZ/8HX) (SOHC) 8V DIESEL	302101-R								
R560111P R560111V	1	 BANCADA	85	105	8		GALGRI												
R270713P R270713P/1 R270713V	1	 DISTRIBUCIÓN	40	55	7		G1ALGHD	R470813V	1	 ÁRBOL DE LEVAS	27	47	7		GALGHD				
R460700	1	 KIT DE RETENES					JUEGO									C3 2012/...	1499cc.	TU4M (SOHC) 8V	472200-R MLS
R460710V R460710P	1	 GUÍA VÁLVULAS (8) R260610V/1	7	9.8	10		RGV	R560111P R560111V	1	 BANCADA	85	105	8		GALGRI				
R460712V	1	 DISTRIBUCIÓN	42	66	8		GALGHD												
R460213P R460213V	1	 ÁRBOL DE LEVAS	36	50	8		GALGHD	R460700	1	 KIT DE RETENES					JUEGO	AX 15 1994/97, Saxo 1996/...	1527cc.	TUD5 (VJY) (SOHC) 8V DIESEL	470300-R
R460710V R460710P	1	 GUÍA VÁLVULAS (8) R260610V/1	7	9.8	10		RGV												
R560111P R560111V	1	 BANCADA	85	105	8		GALGRI	R460712V	1	 DISTRIBUCIÓN	42	66	8		GALGHD				
R460213P R460213V	1	 ÁRBOL DE LEVAS	36	50	8		GALGHD												
R471310V	1	 GUÍA VÁLVULAS (16) R471310V/1	5.5	9.5	13.8	18.1	RGV	Xsara, Picasso TD 1999/... C4/C5 TD 2004/...	1560cc.	DV6TED4(9HY/Z) (DOHC) 16V DIESEL	471301-R								
R560111P R560111V	1	 BANCADA	85	105	8		GALGRI												
R270713P R270713P/1 R270713V	1	 DISTRIBUCIÓN	40	55	7		G1ALGHD	R470813V	1	 ÁRBOL DE LEVAS	27	47	7		GALGHD				
R450010P	1	 GUÍA VÁLVULAS (8) R250410V/1	8	10.8	10		RGV									BX 16 1982/93, BX 15 1987/91 Visa 1985/90, ZX 1991/97	1580cc.	XU5 (SOHC) 8V Ø83	451200
R450010T	1	 GUÍA VÁLVULAS (8) R450010T/1	8	10.8	10		RGV												
R460213P R460213V	1	 ÁRBOL DE LEVAS	36	50	8		GALGHD												

























CITROËN

Código Code	Cant. Qty	Descripción Descrição Descrição	DE [mm]	DA [mm]	H [mm]	A [mm]		Aplicación Aplicação Application	Cm³ Cm³	Motor Motor Engine	Jgo. Juntas Set Gaskets
R230510P R230510V R230510VM/1 R230510VM/2 R230510VM/3 R230510VM/4	1	 GUÍA VÁLVULAS (16) GUÍA VÁLVULAS (16) A GRANEL (200) A GRANEL (200) A GRANEL (1000) A GRANEL (600)	6	8	9.5		RGV	Berlingo, C3 Pluriel 2000/... Xsara 2000/... C2, C3 2002/... - 2004/...	1587cc.	TU5JP4 (NFU/N6A) (DOHC) 16V	452100-R MLS
R560111P R560111V	1	 BANCADA	85	105	8		GALGRI				
R470012V	1	 DISTRIBUCIÓN	64	88	6		GALGRI				
R452113V	1	 ÁRBOL DE LEVAS	38	50	6		GALGHD				
460235	2	 BASTÓN CIERRE BANCADA									
R460710V R460710P	1	 GUÍA VÁLVULAS (8) R260610V/1	7	9.8	10		RGV	ZX, Saxo 1996/... Xsara 1997/...	1587cc.	TU5JP (SOHC) 8V	470501-R
R560111P R560111V	1	 BANCADA	85	105	8		GALGRI				
R460712V	1	 DISTRIBUCIÓN	42	66	8		GALGHD				
R460213P R460213V	1	 ÁRBOL DE LEVAS	36	50	8		GALGHD				
R471710V	1	 GUÍA VÁLVULAS (16) R471710V/1	5	9	18	22.6	RGV	C4/C4 Coupe, C4/C3 Picasso 2008/..., Berlingo, C3 2009/... C4, C4 Grand Picasso, C4 Picasso 2008/... C5, C5 Tourer 2009/... DS3 2010/...	1598cc. 1598cc.	EP6 (5FW/5FS) EP6C 5F01 (DOHC) 16V EP6DT (5FX/5FR) EP6CDT (5F04) (DOHC) 16V	471700-R MLS 471800-R MLS
R560111P R560111V	1	 BANCADA	85	105	8		GALGRI				
R302110V	1	 GUÍA VÁLVULAS (8) R302110V/1	6	23	17.5	23	RGV	C3 HDI, DS3 HDI 2009/...	1560cc.	DV6C - DV6DTE } (SOHC) 8V DIESEL	472301-R
R560111P R560111V	1	 BANCADA	85	105	8		GALGRI				
R270713P R270713P/1 R270713V	1	 DISTRIBUCIÓN	40	55	7		G1ALGHD				
R470813V	1	 ÁRBOL DE LEVAS	27	47	7		GALGHD				
R460200	1	 KIT DE RETENES					JUEGO	Xantia 1997/01, Xsara 1997/... Berlingo 1997/...	1761cc. 1761cc.	XU7JP/JP (SOHC) 8V XU7JB (SOHC) 8V	460100-R 461100-R
R460210V	1	 GUÍA VÁLVULAS (8) R250410V/1	8	10.8	10		RGV				
R460211V	1	 BANCADA	90	110	7		GALGRI				
R460212P R460212V	1	 DISTRIBUCIÓN	42	62	7		GALGHD				
R460213P R460213V	1	 ÁRBOL DE LEVAS	36	50	8		GALGHD				
460235	2	 BASTÓN CIERRE BANCADA									
R460800	1	 KIT DE RETENES					JUEGO	Xsara 1997/..., Xantia 1995/96 Xantia 1997/2001, ZX 1997/98	1761cc.	XU7JP4 (DOHC) 16V	460800-R
R460810V	1	 GUÍA VÁLVULAS (16) R460810V/1	7	17	18		RGV				





















CATALOGO DE RETENES

CATALOGO DE RETENTORES - OIL SEAL CATALOG

CITROËN

Código Code	Cant. Qty	Descripción Descrição Descripción	DE [mm]	DA [mm]	H [mm]	A [mm]		Aplicación Aplicação Application	Cm³ Cm³	Motor Motor Engine	Jgo. Juntas Set Gaskets
R460211V	1	 BANCADA	90	110	7		GALGRI	Xsara 1997/..., Xantia 1995/96 Xantia 1997/2001, ZX 1997/98	1761cc.	XU7JP4 (DOHC) 16V	460800-R
R460212P R460212V	1	 DISTRIBUCIÓN	42	62	7		GALGHD				
R460213P R460213V	2	 ÁRBOL DE LEVAS	36	50	8		GALGHD				
460235	2	 BASTÓN CIERRE BANCADA									
R460300	1	 KIT DE RETENES					JUEGO	BX 17 TD 1988/94	1769cc.	XUD7TE (SOHC) 8V DIESEL XUD7 (161A/A9A) (SOHC) 8V DIESEL DW8 (WJZ/WJY) (SOHC) 8V DIESEL	460301-R (470700) 460301-R (470900) 470601-R
R460210V	1	 GUÍA VÁLVULAS (8) R250410V/1	8	10.8	10		RGV	C15 1994/..., Berlingo 1996/99 Xsara 1997/..., ZX 1991/94 Berlingo, Jumpy 1998/...	1769cc.		
R460211V	1	 BANCADA	90	110	7		GALGRI	Xsara 1998/..., C5, Xsara Jumpy 2000/...	1868cc.		
R460212P R460212V	1	 DISTRIBUCIÓN	42	62	7		GALGHD				
R470013P R470013P/1 R470013V	1	 ÁRBOL DE LEVAS	35	50	7		GALG-BI				
460235	2	 BASTÓN CIERRE BANCADA									
R450010P	1	 GUÍA VÁLVULAS (8) R250410V/1	8	10.8	10		RGV	BX 19 1984/93	1905cc.	XU9 (SOHC) 8V	451200
R450010T	1	 GUÍA VÁLVULAS (8) R450010T/1	8	10.8	10		RGV				
R460213P R460213V	1	 ÁRBOL DE LEVAS	36	50	8		GALGHD				
R460200	1	 KIT DE RETENES					JUEGO	BX19 1984/93 BX19 GTI 1983/93	1905cc.	XU92C (SOHC) 8V	460200-R
R460210V	1	 GUÍA VÁLVULAS (8) R250410V/1	8	10.8	10		RGV				
R460211V	1	 BANCADA	90	110	7		GALGRI				
R460212P R460212V	1	 DISTRIBUCIÓN	42	62	7		GALGHD				
R460213P R460213V	1	 ÁRBOL DE LEVAS	36	50	8		GALGHD				
R460215N	1	 AUXILIAR DISTRIBUCIÓN	9.5	16	4		GALGSR				
R460255P	1	 PUENTE TRASERO	48.9	63	10.8 12.8		E-GALG-BI				
460235	2	 BASTÓN CIERRE BANCADA									
R460300	1	 KIT DE RETENES					JUEGO	Xantia 1993/98, Dispatch, Relay, Jumper, Jumpy 1995/99 Berlingo 1996/99 Xsara 1997/...	1905cc.	XUD9 (SOHC) 8V	460301-R 460300-R-1M 460300-R-2M 460300-R-3M 460301-R (460900)
R460210V	1	 GUÍA VÁLVULAS (8) R250410V/1	8	10.8	10		RGV	Xantia TD, ZX TD 1993/...	1905cc.	XUD9TE/TF (DHX) (SOHC) 8V DIESEL	
R460211V	1	 BANCADA	90	110	7		GALGRI	Dispatch TD, Jumper TD Jumpy TD 1995/...			
R460212P R460212V	1	 DISTRIBUCIÓN	42	62	7		GALGHD	Xsara TD 1997/...			







CITROËN

Código Code	Cant. Qty	Descripción Descripción Descrição	DE [mm]	DA [mm]	H [mm]	A [mm]		Aplicación Aplicação Aplicacion	Cm³ Cm³	Motor Motor Engine	Jgo. Juntas Set Gaskets			
R470013P R470013P/1 R470013V	1	 ÁRBOL DE LEVAS	35	50	7		GALG-BI	Xantia 1993/98, Dispatch, Relay, Jumper, Jumpy 1995/99 Berlingo 1996/99 Xsara 1997/...	1905cc.	XUD9 (SOHC) 8V	460301-R 460300-R-1M 460300-R-2M 460300-R-3M 460301-R (460900)			
460235	2	 BASTÓN CIERRE BANCADA						Xantia TD, ZX TD 1993/... Dispatch TD, Jumper TD Jumpy TD 1995/... Xsara TD 1997/...	1905cc.	XUD9TE/TF (DHX) (SOHC) 8V DIESEL				
R470810V	1	 GUÍA VÁLVULAS (16) R470810V/1	6	10	21.5	19.6	RGV	Xantia, Jumper, Xsara HDI 1998/..., Berlingo, Evasion Xsara Picasso, Dispatch Jumper HDI 1999/... Jumpy, Xsara, C5 HDI 2000/...	1997cc.	DW10TD/ATED DW10TD (RHV/RHY/RHX/RHZ) (SOHC) 8V DIESEL	470801-R			
R460211V	1	 BANCADA	90	110	7	GALGRI								
R460212P R460212V	1	 DISTRIBUCIÓN	42	62	7	GALGHD								
R470813V	1	 ÁRBOL DE LEVAS	27	47	7	GALGHD								
460235	2	 BASTÓN CIERRE BANCADA												
R460810V	1	 GUÍA VÁLVULAS (16) R460810V/1	7	17	18	19.6	RGV	Jumpy, Dispatch, Xsara Evasion 1998/... C5/C5 HPI 2001/... C8 2002/..., C4 2004/... Xsara Picasso	1997cc.	EW10J4(RFN-RLZ) (DOHC) 16V	471200-R MLS			
R460211V	1	 BANCADA	90	110	7	GALGRI								
R270713P R270713P/1 R270713V	1	 DISTRIBUCIÓN	40	55	7	G1ALGHD								
R460213P R460213V	2	 ÁRBOL DE LEVAS	36	50	8	GALGHD								
R452113V	1	 AUXILIAR	38	50	6	GALGHD								
R471410V	1	 GUÍA VÁLVULAS (16) R470810V/1	6	10	21.5	19.6	RGV	C4/C5 HDI 2004/... C4 Picasso, C8 HDI 2006/... C4 HDI FAP 2007/... Evasion HDI 2000/... C8 HDI, Jumpy HDI 2002/...	1997cc.	DW10BTED4 (RHR) (DOHC) 16V DIESEL	471401-R			
R460211V	1	 BANCADA	90	110	7	GALGRI	1997cc.		DW10ATED4 (RHW/RHM/RHT) (DOHC) 16V DIESEL	471501-R				
R460212P R460212V	1	 DISTRIBUCIÓN	42	62	7	GALGHD								
R470813V	1	 ÁRBOL DE LEVAS	27	47	7	GALGHD								
460235	2	 BASTÓN CIERRE BANCADA												
R460211V	1	 BANCADA	90	110	7	GALGRI	C5, C5 HDI, C5 Tourer HDI 2009/..., C4 Picasso C4 Grand Picasso 2010/...	1997cc.	DW10CTED4 (RH02/RHH) (DOHC) 16V DIESEL	471901-R				
R460212P R460212V	1	 DISTRIBUCIÓN	42	62	7	GALGHD								
R470813V	1	 ÁRBOL DE LEVAS	27	47	7	GALGHD								
R460810V	1	 GUÍA VÁLVULAS (16) R460810V/1	7	17	18	RGV					C4, C5 2005/..., C4 Grand Picasso 2006/... C4 Picasso, Jumpy III 2007/...	1997cc.	EW10A (RFJ/RFH) (DOHC) 16V	472000-R MLS
R460211V	1	 BANCADA	90	110	7	GALGRI								
R270713P R270713P/1 R270713V	1	 DISTRIBUCIÓN	40	55	7	G1ALGHD								

























CATALOGO DE RETENES

CATALOGO DE RETENTORES - OIL SEAL CATALOG

CITROËN

Código Code	Cant. Qty	Descripción Descrição Descrição	DE [mm]	DA [mm]	H [mm]	A [mm]		Aplicación Aplicação Aplicacion	Cm³ Cm³	Motor Motor Engine	Jgo. Juntas Set Gaskets
R460213P R460213V	2	 ÁRBOL DE LEVAS	36	50	8		GALGHD	C4, C5 2005/..., C4 Grand Picasso 2006/... C4 Picasso, Jumpy III 2007/...	1997cc.	EW10A (RFJ/RFH) (DOHC) 16V	472000-R MLS
R452113V	1	 AUXILIAR	38	50	6		GALGHD				
R450010P	1	 GUÍA VÁLVULAS (8) R250410V/1	8	10.8	10		RGV	XM 1989/94 - 1990/93	1998cc.	XU10M XU102C/XU10J2 (SOHC) 8V	451300
R450010T	1	 GUÍA VÁLVULAS (8) R450010T/1	8	10.8	10		RGV				
R460211V	1	 BANCADA	90	110	7		GALGRI				
R460212P R460212V	1	 DISTRIBUCIÓN	42	62	7		GALGHD				
R460213P R460213V	1	 ÁRBOL DE LEVAS	36	50	8		GALGHD				
R450010P	1	 GUÍA VÁLVULAS (8) R250410V/1	8	10.8	10		RGV				
R450010T	1	 GUÍA VÁLVULAS (8) R450010T/1	8	10.8	10		RGV	ZX 1992/96, Xantia 1993/98	1998cc.	XU10J2C (SOHC) 8V	451900-R
R460213P R460213V	1	 ÁRBOL DE LEVAS	36	50	8		GALGHD				
R460200	1	 KIT DE RETENES					JUEGO	ZX 1992/..., Xantia 1993/98	1998cc.	XU10J2C (SOHC) 8V	460600-R
R460210V	1	 GUÍA VÁLVULAS (8) R250410V/1	8	10.8	10		RGV				
R460211V	1	 BANCADA	90	110	7		GALGRI				
R460212P R460212V	1	 DISTRIBUCIÓN	42	62	7		GALGHD				
R460213P R460213V	1	 ÁRBOL DE LEVAS	36	50	8		GALGHD				
460235	2	 BASTÓN CIERRE BANCADA									
R460211V	1	 BANCADA	90	110	7		GALGRI	ZX 1992/97, Xantia 1993/95	1998cc.	XU10J4 (DOHC) 16V	470200-R
R460212P R460212V	1	 DISTRIBUCIÓN	42	62	7		GALGHD				
R460213P R460213V	2	 ÁRBOL DE LEVAS	36	50	8		GALGHD				
460235	2	 BASTÓN CIERRE BANCADA									
R460800	1	 KIT DE RETENES					JUEGO	Xantia 1995/01, Xsara 1998/00 Evasion, Synergie 1998/...	1998cc.	XU10J4R (RFV) (DOHC) 16V	471000-R
R460810V	1	 GUÍA VÁLVULAS (16) R460810V/1	7	17	18		RGV				
R460211V	1	 BANCADA	90	110	7		GALGRI				
R460212P R460212V	1	 DISTRIBUCIÓN	42	62	7		GALGHD				
R460213P R460213V	2	 ÁRBOL DE LEVAS	36	50	8		GALGHD				



CITROËN

Código Code	Cant. Qty	Descripción Descrição Descrição	DE [mm]	DA [mm]	H [mm]	A [mm]		Aplicación Aplicação Application	Cm³ Cm³	Motor Motor Engine	Jgo. Juntas Set Gaskets
460235	2	 BASTÓN CIERRE BANCADA						Xantia 1995/01, Xsara 1998/00 Evasion, Synergie 1998/...	1998cc.	XU10J4R (RFV) (DOHC) 16V	471000-R
R461510P	1	 GUÍA VÁLVULAS (12) R250410V/1	8	10.8	10		RGV	XM TD 1989/00 Xantia TD 1995/98 Dispatch TD, Evasion TD Jumper TD, Jumpy TD Synergie1996/99	2088cc.	DW12TED4 (4HX) DW12TED4 (4HW) (DOHC) 16V DIESEL	461501-R
R460211V	1	 BANCADA	90	110	7		GALGRI				
R460212P R460212V	1	 DISTRIBUCIÓN	42	62	7		GALGHD				
R470013P R470013P/1 R470013V	1	 ÁRBOL DE LEVAS	35	50	7		GALG-BI				
460235	2	 BASTÓN CIERRE BANCADA									
R471410P	1	 GUÍA VÁLVULAS (16) R470810V/1	6	10	21.5	19.6	RGV	C5 HDI 2001/... C8 HDI 2002/...	2179cc.	DW12TED4 (4HX) DW12TED4 (4HW) (DOHC) 16V DIESEL	471501-R
R460211V	1	 BANCADA	90	110	7		GALGRI				
R460212P R460212V	1	 DISTRIBUCIÓN	42	62	7		GALGHD				
R470813V	1	 ÁRBOL DE LEVAS	27	47	7		GALGHD				
460235	2	 BASTÓN CIERRE BANCADA									
R302010V	1	 GUÍA VÁLVULAS (16) R302010V/1	7	12	18.8	24.2	RGV	Jumper HDI 2006/...	2198cc.	4HU/4HV (P22DTE) (DOHC) 16V DIESEL	324801-R
PR302011T	1	 PORTA BANCADA	105				PORTA				
R470013P R470013P/1 R470013V	1	 ÁRBOL DE LEVAS	35	50	7		GALG-BI				
R452010V	1	 GUÍA VÁLVULAS (8) R452010V/1	7	9.8	10.2		RGV	Jumper TDI, Relay TDI 1997/...	2445cc.	DJ5TED (THX) (SOHC) 8V DIESEL	452000-R
R470011V	1	 BANCADA	98	120	7		GALGHI				
R470012V	1	 DISTRIBUCIÓN	64	88	6		GALGHD				
R470013P R470013P/1 R470013V	1	 ÁRBOL DE LEVAS	35	50	7		GALG-BI				
R452015V	1	 AUXILIAR	35	52	7		GALGHI				
R470000	1	 KIT DE RETENES					JUEGO	Jumper D/TD, XM TD Relay D/TD1994/97	2445cc.	DJ5 (T9A) - DK5ATE DJ5T(T8A/THZ) (SOHC) 12V DIESEL	470000-R
R470010P R470010V	1	 GUÍA VÁLVULAS (12) R260610V/1	7	9.8	10		RGV				
R470011V	1	 BANCADA	98	120	7		GALGHI				
R470012V	1	 DISTRIBUCIÓN	64	88	6		GALGHD				
R470013P R470013P/1 R470013V	1	 ÁRBOL DE LEVAS	35	50	7		GALG-BI				

CATALOGO DE RETENES

CATALOGO DE RETENTORES - OIL SEAL CATALOG

CITROËN

Código Code	Cant. Qty	Descripción Descrição Descrição	DE [mm]	DA [mm]	H [mm]	A [mm]		Aplicación Aplicação Application	Cm³ Cm³	Motor Motor Engine	Jgo. Juntas Set Gaskets
R470014V	1	 AUXILIAR	40	62	7		GALGHI	Jumper D/TD, XM TD Relay D/TD1994/97	2445cc.	DJ5 (T9A) - DK5ATE DJ5T(T8A/THZ) (SOHC) 12V DIESEL	470000-R
R470015V	1	 AUXILIAR	47.5	62	7		GALGHI				







CUMMINS

R870010P	1	 GUÍA VÁLVULAS (8) R870010P/1	8	12.7	14		RGV	Serie B	3900cc.	4B - 4BT - 4BTA DIESEL	870000-R
R870011V R870011VF	1	 BANCADA	130	150	12/13		GALGRI				
R870012V R870012VF	1	 DISTRIBUCIÓN	63.5	79.5	9		G1ALGRD				
R800811T	1	 BANCADA	130	155	12.5/16		G1ALGRI	Bus, Agrale, Euro III/IV Electrónico 2003/...	3920cc.	ISBe (OHV) 16V	870500-R 870501-R
R800812T	1	 DISTRIBUCIÓN	70	100	12.5/16		GALGHD				
R800810P	1	 GUÍA VÁLVULAS (24) R520810-1P (12) R520810-2P (12)	6 6.3	12.15 12.15	14.3 14.6		RGV	ISB 2004/...	5883cc.	ISBe 6 (OHV) 24V DIESEL	800800-R
R800811T	1	 BANCADA	130	155	12.5/16		G1ALGRI				
R800812T	1	 DISTRIBUCIÓN	70	100	12.5/16		GALGHD				
R870110P	1	 GUÍA VÁLVULAS (12) R870010P/1	8	12.7	9.5		RGV				
R870011V R870011VF	1	 BANCADA	130	150	12/16		GALGRI	Serie B	5900cc.	6B - 6BT - 6BTA (SOHC) 12V DIESEL	870100-R
R870012V R870012VF	1	 DISTRIBUCIÓN	63.5	79.5	9		G1ALGRD				
R870610V	1	 GUÍA VÁLVULAS (24) R870610V/1	8	13.6	19	33.7	RGV				
R870011V R870011VF	1	 BANCADA	130	150	12/16		GALGRI	Serie C 1832/2632	8270cc.	ISCe6 24V DIESEL	870600-R
R870212V R870212T	1	 DISTRIBUCIÓN	75	93	9/10		G1ALGRD				
R870210V	1	 GUÍA VÁLVULAS (16) R870210V/1	8.9	15.9	10	36.5	RGV				
R870011V R870011VF	1	 BANCADA	130	150	12/16		GALGRI	Serie C Bus, Camión, Agrícola	8300cc.	6C - 6CT - CTA (SOHC) 12V DIESEL	870200-R
R870212V R870212T	1	 DISTRIBUCIÓN	75	93	9/10		G1ALGRD				













DACIA

R550900	1	 KIT DE RETENES					JUEGO	TXL 1310/1410	1397cc.	TXL (SOHC) 8V	560200-R
R550910T	1	 GUÍA VÁLVULAS (8) R550910T/1	7	10.8	10		RGV				
R550910P R550910V R550910VM/1 R550910VM/2	1	 GUÍA VÁLVULAS (8) GUÍA VÁLVULAS (8) A GRANEL (200) A GRANEL (200)	7	10.8	10		RGV				
R550811P R550811PN/1 R550811V	1	 BANCADA	80	100	13		GARI				

DACIA

Código Code	Cant. Qty	Descripción Descrição Descrição	DE [mm]	DA [mm]	H [mm]	A [mm]		Aplicación Aplicação Aplicacion	Cm³ Cm³	Motor Motor Engine	Jgo. Juntas Set Gaskets
R550412N R550412P R550412P/1 R550412V	1	 DISTRIBUCIÓN	35	50	9		GALGHD	TXL 1310/1410	1397cc.	TXL (SOHC) 8V	560200-R
R560800	1	 KIT DE RETENES					JUEGO	Sandero 2008/... Logan 2004/...	1598cc.	K7M 710/718/810/814 (SOHC) 8V	571000-R MLS
R560810P R560810V	1	 GUÍA VÁLVULAS (8)	7	9.8	10		RGV				
R570011V	1	 BANCADA	80	100	8		GALGRI				
R550613P R550613P/1 R550613V	1	 DISTRIBUCIÓN	35	47	7		GAHD				
R260113P R260113P/1 R260113V	1	 ÁRBOL DE LEVAS	30	42	7		GALGHD				



















DAEWOO

R940010P	1	 GUÍA VÁLVULAS (6) R940010P/1	5	9	9.5		RGV	Matiz 1998/..., Tico 1996/... Damas 1981/... Spark 2003/06	796cc.	F8CV (SOHC) 6V	940000-R
R940011S	1	 BANCADA	60	80	8		GALGHI				
R230113P R230113P/1 R230113V	1	 DISTRIBUCIÓN Y ÁRBOL DE LEVAS	32	47	10		GALG-BI				
R282510P	1	 GUÍA VÁLVULAS (8) R940010P/1	5	9	9.5		RGV	Matiz 2003/06 Kalos 2002/...	995cc. 1148cc.	B10S (SOHC) 8V F12S3 (SOHC) 8V	282500-R
R940011S	1	 BANCADA	60	80	8		GALGHI				
R282513P	1	 DISTRIBUCIÓN Y ÁRBOL DE LEVAS	32	47	7						
R570910V R570910VM/2 R570910VM/3	1	 GUÍA VÁLVULAS (16)	5	11	16.5	28	RGV	Kalos 2004/... Nubira 2003/05 Lacetti 2004/...	1399cc. 1598cc.	F14 D3 (DOHC) 16V F16 D3 (DOHC) 16V	290100-R
R240411P R240411P/1 R240411V	1	 BANCADA	80	98	10		G1ALGRI				
R260113P R260113P/1 R260113V	1	 DISTRIBUCIÓN	30	42	7		GALGHD				
R300612P R300612V R300612N	2	 ÁRBOL DE LEVAS	42	56	13		GAHD				
R240400	1	 KIT DE RETENES					JUEGO	Cielo, Espero 1994/97 Lemans, Racer 1989/...	1498cc. 1598cc.	G15MF (SOHC) 8V OHC (SOHC) 8V	240400-R
R240210P R240210V R240210VM/1 R240210VM/2 R240210VM/3	1	 GUÍA VÁLVULAS (8) GUÍA VÁLVULAS (8) A GRANEL (200) A GRANEL (200) A GRANEL (1000)	7	11.1	10		RGV				
R240411P R240411P/1 R240411V	1	 BANCADA	80	98	10		G1ALGRI				





CATALOGO DE RETENES

CATALOGO DE RETENTORES - OIL SEAL CATALOG







DAEWOO

Código Code	Cant. Qty	Descripción Descrição Descrição	DE [mm]	DA [mm]	H [mm]	A [mm]		Aplicación Aplicação Aplicacion	Cm³ Cm³	Motor Motor Engine	Jgo. Juntas Set Gaskets
R240415P R240415P/1 R240415V	1	 DISTRIBUCIÓN	26	42	8		G1ALGHD	Cielo, Espero 1994/97 Lemans, Racer 1989/...	1498cc. 1598cc.	G15MF (SOHC) 8V OHC (SOHC) 8V	240400-R
R240013P R240013P/1 R240013V	1	 ÁRBOL DE LEVAS	35	48	7		GALGHD				
R240455N	1	 RUEDA TRASERA	40	52	8.5		E-GALG				
R240200	1	 KIT DE RETENES					JUEGO	Aranos, Espero, Prince 1993/97, Leganza 1997/...	1796cc.	C18LE (SOHC) 8V	940100-R
R240210P R240210V R240210VM/1 R240210VM/2 R240210VM/3	1	 GUÍA VÁLVULAS (8) GUÍA VÁLVULAS (8) A GRANEL (200) A GRANEL (200) A GRANEL (1000)	7	11.1	10		RGV				
R240211P R240211V	1	 BANCADA	90	104	11		GALGRI				
R240012P R240012V	1	 DISTRIBUCIÓN	31	50	8		G1LGHD				
R240013P R240013P/1 R240013V	1	 ÁRBOL DE LEVAS	35	48	7		GALGHD				
R460213P R460213V	1	 ÁRBOL DE LEVAS	36	50	8		GALGHD	Epica 2006/..., Captiva Toscana 2007/...	1991cc.	Z20S (SOHC) 16V DIESEL	291101-R
R240200	1	 KIT DE RETENES						Espero, Prince 1993/97 Leganza 1997/... Magnus 2001/... Espero, Lemans, Prince Leganza MPFI/TBI 1991/...	1998cc.	C20LE - C20NE (SOHC) 8V	940100-R
R240210P R240210V R240210VM/1 R240210VM/2 R240210VM/3	1	 GUÍA VÁLVULAS (8) GUÍA VÁLVULAS (8) A GRANEL (200) A GRANEL (200) A GRANEL (1000)	7	11.1	10		RGV				
R240211P R240211V	1	 BANCADA	90	104	11		2 GALGRI				
R240012P R240012V	1	 DISTRIBUCIÓN	31	50	8		G1LGHD				
R240013P R240013P/1 R240013V	1	 ÁRBOL DE LEVAS	35	48	7		GALGHD				
R240210P R240210V R240210VM/1 R240210VM/2 R240210VM/3	1	 GUÍA VÁLVULAS (8) GUÍA VÁLVULAS (8) A GRANEL (200) A GRANEL (200) A GRANEL (1000)	7	11.1	10		RGV	Lemans, Racer 1989/97 Aranos 1995/... Nubira II 1999/...	1998cc.	C20LE - C20NE (SOHC) 8V	241500-RMX
R240211P R240211V	1	 BANCADA	90	104	11		2 GALGRI				
R240012P R240012V	1	 DISTRIBUCIÓN	31	50	8		G1LGHD				
R240013P R240013P/1 R240013V	1	 ÁRBOL DE LEVAS	35	48	7		GALGHD				
R241515V	1	AUXILIAR	55	70	8		GALGHI				













DAEWOO

Código Code	Cant. Qty	Descripción Descrição Descrição	DE [mm]	DA [mm]	H [mm]	A [mm]		Aplicación Aplicação Application	Cm³ Cm³	Motor Motor Engine	Jgo. Juntas Set Gaskets
R280700	1	 KIT DE RETENES						Leganza, Nubira 1997/... Nubira II 1999/... Magnus 2001/... Leganza 1998/...	1998cc.	X20SED (DOHC) 16V	280700-R
R280610V	1	 GUÍA VÁLVULAS (16) R230510V/1	6	8.8	9.5		RGV		2198cc.	X20SED (DOHC) 16V	280700-R
R240211P R240211V	1	 BANCADA	90	104	11		2 GALGRI				
R240012P R240012V	1	 DISTRIBUCIÓN	31	50	8		GALGHD				
R240013P R240013P/1 R240013V	2	 ÁRBOL DE LEVAS	35	48	7		GALGHD				

DAF

R420610P	1	 GUÍA VÁLVULAS (8) R420610V/1	7.4	11.5	9		RGV	Va 200, VS 200 1986/...	1994cc.	TN44 DIESEL	420600-R
R420611P	1	 BANCADA	88.9	105	9.5		GARI				
R420612P	1	 DISTRIBUCIÓN	35	45	7		GALGHD				
R420613P	1	 ÁRBOL DE LEVAS AUXILIAR	40	52	7		GALGHD				
R420614P	1	 AUXILIAR	45	60	7		GALGHI				
R430110P	1	 GUÍA VÁLVULAS (8) R430110P/1 (4) R430110P/1 (2)	7.24 6.70	12.7 11.7	10.3 10.7		RGV	400 Furgon	2498cc.	BN52 DIESEL	









DAIHATSU

R950010P	1	 GUÍA VÁLVULAS (4) R950010P/1	7	12	15		RGV	55 Wide Cab, Max Cuore Cab Van 1977/...	547cc.	AB - 20/30 (SOHC) 4V	950000-R
R950011P	1	 BANCADA	58	74	95		GALGHI				
R950012N R950012P	1	 DISTRIBUCIÓN	32	48	7		GALGHD				
R910613P	1	 ÁRBOL DE LEVAS	32	46	6		GALGHD	Mira 1992/96, Coure 1984/95	659cc.	EF (DOHC) 6V	948000-R
R900912P	1	 DISTRIBUCIÓN	34	48	7		GALGHD	Hi-Jet 1986/89 Van 850 1991/...	843cc.	CD (SOHC) 6V	948100-R
R910613P	1	 ÁRBOL DE LEVAS	32	46	6		GALGHD				
R910613P	1	 ÁRBOL DE LEVAS	32	46	6		GALGHD	Mira 1992/96, Coure 1984/95 Coure 1986/99, Mira 1986/95	846cc. 846cc.	ED (DOHC) 6V ED10 (SOHC) 6V	948000-R 948200-R
R320913V	1	 DISTRIBUCIÓN	38	52	6		GALGHD	Move, Coure 1998/02 Sirion 2002/...	989cc.	EJ-DE (DOHC) 12V	948300-R MLS
R950110P	1	 GUÍA VÁLVULAS (6) R950010P/1	7	12	15		RGV	Charade 1981/...	993cc.	CB - CB 12/37 (SOHC) 6V	950100-R
R950011P	1	 BANCADA	58	74	95		GALGHI				
R950012N R950012P	2	 DISTRIBUCIÓN	32	48	7		GALGHD				
R900912P	1	 DISTRIBUCIÓN	34	48	7		GALGHD	Charade 1988/... Charade 1988/...	1295cc. 1295cc.	HC (SOHC) 16V HC (SOHC) 16V	948600-R 949000-R

















CATALOGO DE RETENES

CATALOGO DE RETENTORES - OIL SEAL CATALOG













DAIHATSU

Código Code	Cant. Qty	Descripción Descrição Descripción	DE [mm]	DA [mm]	H [mm]	A [mm]		Aplicación Aplicação Application	Cm³ Cm³	Motor Motor Engine	Jgo. Juntas Set Gaskets
R900912P	1	 DISTRIBUCIÓN	34	48	7		GALGHD	Charade 1988/...	1589cc.	HDE (SOHC) 16V	948600-R
R970010P	1	 GUÍA VÁLVULAS (8) R970010P/1	6	12.5	12		RGV	Charmant 1978/80 Delta Wide 1978/80	1588cc. 1700cc.	2T (OHV) 8V 13T (OHV) 8V	970000-R
R970011P R970011S	1	 BANCADA	75	100	13		GALGRI				
R970012P R970012N	1	 DISTRIBUCIÓN	38.5	58	11		GALGHD				
R450412-1P	1	 DISTRIBUCIÓN	42	60	8		GALGHD	Delta Wide 1983/88	1839cc.	1C (SOHC) 8V	920500-R
R460211V	1	 BANCADA	90	110	7		GALGRI	Delta Wide D/TD 1985/91	1975cc.	2C/2CT (SOHC) 8V DIESEL	920400-R
R450412-1P	1	 DISTRIBUCIÓN	42	60	8		GALGHD				
R570011V	1	 BANCADA	80	100	8		GALGRI	Rocky 1993/01	2237cc.	4Y (OHV) 8V	923500-R
R950711P	1	 DISTRIBUCIÓN	60	78	10		GALGRI				

DEUTZ

R650411P	1	 BANCADA	150	172	18.3		GAHI	Tractor A40	2660cc.	F2L 514 (SOHC) 4V DIESEL	650000
R650411P	1	 BANCADA	150	172	18.3		GAHI	Tractor 69/75 A46 1969/75	2908cc.	A - F2L 1114 DIESEL	650200-R
R650212S	1	 DISTRIBUCIÓN	110	140	16		GALGHD				
R660010P	1	 GUÍA VÁLVULAS (6) R650110P/1	7	19	12.5		RGV	Tractor 1978/81	3064cc.	B-F3L 913 DIESEL	660000-R
R650111P	1	 BANCADA	115	140	16		G1ALGHI				
R650112P	1	 DISTRIBUCIÓN	65	85	13		G1ALGHD				
R650212S	1	 DISTRIBUCIÓN	110	140	16		GALGHD	Tractor 74/78 A65 1969/75 Tractor A55 1959/69	3167cc. 3990cc.	A - F2L 2114 DIESEL F3L 514 (OHV) 6V DIESEL	650200 650300
R650411P	1	 BANCADA	150	172	18.3		GAHI				
R660110P	1	 GUÍA VÁLVULAS (8) R650110P/1	7	19	12.5		RGV	Tractor, Agrale 4-913 Turbo 4-913 1978/...	4086cc.	F4L 913 (OHV) 8V DIESEL	660100-R
R650111P	1	 BANCADA	115	140	16		G1ALGHI				
R650112P	1	 DISTRIBUCIÓN	65	85	13		G1ALGHD				
R650212S	1	 DISTRIBUCIÓN	110	140	16		GALGHD	Tractor A65 1969/78	4363cc. 4750cc.	A-F3L 1114 A-F3L 2114 DIESEL	650600
R650411P	1	 BANCADA	150	172	18.3		GAHI				
R660210P	1	 GUÍA VÁLVULAS (10) R650110P/1	7	19	12.5		RGV	Tractor 1978/...	5106cc.	B-F5L 913 DIESEL	660200-R
R650111P	1	 BANCADA	115	140	16		G1ALGHI				
R650112P	1	 DISTRIBUCIÓN	65	85	13		G1ALGHD				

DEUTZ

Código Code	Cant. Qty	Descripción Descripción Decripción	DE [mm]	DA [mm]	H [mm]	A [mm]		Aplicación Aplicação Aplicacion	Cm³ Cm³	Motor Motor Engine	Jgo. Juntas Set Gaskets
R650411P	1	 BANCADA	150	172	18.3		GAHI	Tractor 470 1959/69	5320cc.	F4L 514 (OHV) 8V DIESEL	650400
R650212S	1	 DISTRIBUCIÓN	110	140	16		GALGHD	Tractor A85 1969/78 Tractor A85 1969/78	5817cc. 6333cc.	A-F4L 1114 A-F4L 2114 DIESEL	650700
R650411P	1	 BANCADA	150	172	18.3		GAHI				
R650110P	1	 GUÍA VÁLVULAS (12) R650110P/1	7	19	12.5		RGV	DD1000, DD9000 Camión Tractor 1978/81	6128cc.	F6L 913 (OHV) 12V DIESEL	650100-R
R650111P	1	 BANCADA	115	140	16		G1ALGHI				
R650112P	1	 DISTRIBUCIÓN	65	85	13		G1ALGHD				
R650411P	1	 BANCADA	150	172	18.3		GAHI	Tractor A110 1959/69	7980cc.	F6L 514 (OHV) 12V DIESEL	650500
R650212S	1	 DISTRIBUCIÓN	110	140	16		GALGHD	Tractor, A130, A144 1969/78 Bus Turbo	8725cc. 9500cc.	A-F6L 1114 (OHV) 12V DIESEL B-F6L 2114 (OHV) 12V DIESEL	650800 650800
R650411P	1	 BANCADA	150	172	18.3		GAHI	Tractor, A130, A144 1969/78 Bus Turbo			
R650411P	1	 BANCADA	150	172	18.3		GAHI	200 D16, 200 D19, 200 D2M 200 RS, 210 EV 120 Tractor 5020 1969/77	11309cc.	F8L - 413 V8 16V DIESEL	650900-R
R650912P	1	 DISTRIBUCIÓN	100	120	15		GALGHD				
R650912P	1	 DISTRIBUCIÓN	100	120	15		GALGHD	Estacionarios 0302 6472 AY 0148-00, 0301 7177 UY 0147-00, Vehicular, Camion Bus, 0302 6545 AY 0148-00 0301 7177 UY 0147-00	11309cc.	F8L - 413F V8 16V DIESEL	651000-R







DI TELLA

R220110P	1	 GUÍA VÁLVULAS (8) R300310P/1	7.9	15.5	12.5		RGV	Morris, Riley, Traveller 1500 Pick Up, Argenta 1500 1960/66	1489cc.		210900
R210912N	1	 DISTRIBUCIÓN	39.68	58.73	9.46		GALGRD	Magnette 1622, Morris 1650 Magnette 1960/66	1622cc.		

DYNAPAC

R310411P R310411V	1	 BANCADA	110	130	13		GALGHI	Cilindro Vibratorio CHF 44 1983/...	2942cc.	D229-3 (SOHC) 6V DIESEL	330800-R
R310412P R310412V	1	 DISTRIBUCIÓN	78	100	13		GALGHD				























FIAT

R250100	1	 KIT DE RETENES					KIT	600 (E.R.D), 770 Coupe, 800 Spider 1962/76	767cc.	100D - 170R (OHV) 8V	250100-R
R250110P R250110PN/1	1	 GUÍA VÁLVULAS (8) A GRANEL (200)	7	11.8	10.2		RGV				
R250111P R250111P/1 R250111V R250111N	1	 BANCADA	64	80	8		G1ALGHI				
R250112P R250112N	1	 DISTRIBUCIÓN	42	56	7		ESP-G1				
R250148N	1	 LEVA INTERIOR PALANCA CAMBIO	14	24	7		ESP				
R250151N	1	 CAJA DE VELOCIDAD	28	47	8		GAHD				























CATALOGO DE RETENES

CATALOGO DE RETENTORES - OIL SEAL CATALOG

FIAT

Código Code	Cant. Qty	Descripción Descrição Descrição	DE [mm]	DA [mm]	H [mm]	A [mm]		Aplicación Aplicação Application	Cm³ Cm³	Motor Motor Engine	Jgo. Juntas Set Gaskets
R250155N	1	 RUEDA TRASERA	38	52	10		G1	600 (E.R.D), 770 Coupe, 800 Spider 1962/76	767cc.	100D - 170R (OHV) 8V	250100-R
R250156N	1	 INTERIOR PALIER	25	35	7		GA				
R250158N	1	 RUEDA DELANTERA	35	52	8.8		G1				
R250800		 KIT DE RETENES					KIT	133, Berlina de Lujo 1977/82, 850, 850 Van 1965/76 Uno 45 1974/.... 127 Especial 1983/88	843cc.	100R - 100G (OHV) 8V	250800-R
R250810P	1	 GUÍA VÁLVULAS (8) R550410P/1	7	9.7	10.2		RGV		903cc.	146A (OHV) 8V	
R250811P R250811V R250811N	1	 BANCADA	64	80	8		G1ALGHD				
R250112P R250112N	1	 DISTRIBUCIÓN	42	56	7		ESP-G1				
R260000	1	 KIT DE RETENES					KIT	Palio 1.0 ED/EDX MPI 96 Uno Mille, Palio, Siena 1983/...	994cc.	ED/EDX MPI (SOHC) 8V 146B (SOHC) 8V	270200-R 260700-R
R250410V R250410VM/1 R250410VM/2 R250410VM/3	1	 GUÍA VÁLVULAS (8) A GRANEL (200) A GRANEL (200) A GRANEL (1000)	8	10.8	10		RGV		994cc.		
R260011P	1	 BANCADA	70	85	8		G1ALGHI				
R250412N R250412P	1	 DISTRIBUCIÓN	40	56	7		GALGRD				
R250413P R250413P/1	2	 ÁRBOL DE LEVAS	30	52	7		GALGRD				
R270510P R270510V	1	 GUÍA VÁLVULAS (8) R260610V/1	7	9.8	10		RGV	Uno 1994/00 Panda 1986/...., Uno 1989/95 Uno 1998/...	994cc.	146A2 (SOHC) 8V 156A2/A3 (SOHC) 8V	251000
R260113P R260113P/1 R260113V	1	 ÁRBOL DE LEVAS	30	42	7		GALGHD		999cc.		
R270510P R270510V	1	 GUÍA VÁLVULAS (8) R260610V/1	7	9.8	10		RGV		999cc.		
R270511V	1	 BANCADA	74	88	8		G1ALGRI				
PR270511V	1	 PORTA BANCADA	74				PORTA				
R260113P R260113P/1 R260113V	1	 ÁRBOL DE LEVAS	30	42	7		GALGHD				
R270515V	1	 BOMBA DE ACEITE	27	37	7		G1ALGHD				
R270710V	1	 GUÍA VÁLVULAS (16) R230510V/1	6	8.8	9.5		RGV	Palio, Siena, Palio Weekend Palio Novo, Novo Siena, Doble	999cc.	Fire 1714130 DOHC) 16V	270700-R
PR270711V	1	 PORTA BANCADA	74				PORTA				
R270713P R270713P/1 R270713V	1	 ÁRBOL DE LEVAS	40	55	7		G1ALGHD				
R270515V	1	 BOMBA DE ACEITE	27	37	7		G1ALGHD				























FIAT

Código Code	Cant. Qty	Descripción Descrição Descripción	DE [mm]	DA [mm]	H [mm]	A [mm]		Aplicación Aplicação Application	Cm³ Cm³	Motor Motor Engine	Jgo. Juntas Set Gaskets
R271210V R271210VM/2	1	 GUÍA VÁLVULAS (8) A GRANEL (200)	5	7.8	8		RGV	Palio, Siena Generación III Uno Fase II 2010/...	999cc.	Fire EVO (SOHC) 8V	272200-R MLS
PR271911VF	1	 PORTA BANCADA	74				PORTA				
R272213V	1	 ÁRBOL DE LEVAS	31	55	7		G1ALGHD				
R270515V	1	 BOMBA DE ACEITE	27	37	7		G1ALGHD				
R272910V	1	 GUÍA VÁLVULAS (6) R272910V/1	5	8.85	18.25	23.45	RGV	Argo, Mobi, Uno 2018/...	999cc.	Firefly (SOHC) 6V	272900-R MLS
R520811V	1	 BANCADA	80	96	9		GALGRI				
R260000	1	 KIT DE RETENES					KIT	147, Oggi, Panorama, Uno Premio Trend	1049cc.	127AB 206 (OHV) 8V	260500-R
R250410V R250410VM/1 R250410VM/2 R250410VM/3	1	 GUÍA VÁLVULAS (8) A GRANEL (200) A GRANEL (200) A GRANEL (1000)	8	10.8	10		RGV				
R260011P	1	 BANCADA	70	85	8		G1ALGHI				
R250412N R250412P	1	 DISTRIBUCIÓN	40	56	7		GALGRD				
R250413P R250413P/1	2	 ÁRBOL DE LEVAS	30	52	7		GALGRD				
R250111P R250111P/1 R250111V R250111N	1	 BANCADA	64	80	8		G1ALGHI	1100/103 1961/64	1089cc.		250000-R
R250012N	1	 DISTRIBUCIÓN	40	60	10		GAHD				
R250050N	1	 CAJA DE VELOCIDAD	32	56	10		GALGHI				
R270510P R270510V	1	 GUÍA VÁLVULAS (8) R260610V/1	7	9.8	10		RGV	Panda 1995/96, Palio 2001/...	1108cc.	176B2 - 178B9 (SOHC) 8V	251000
R260113P R260113P/1 R260113V	1	 ÁRBOL DE LEVAS	30	42	7		GALGHD				
R250400	1	 KIT DE RETENES					KIT	128, 147, Spazio, Brio Ritmo 60, Strada 60 1971/...	1116cc.	128A (SOHC) 8V	250400-R
R250410V R250410VM/1 R250410VM/2 R250410VM/3	1	 GUÍA VÁLVULAS (8) A GRANEL (200) A GRANEL (200) A GRANEL (1000)	8	10.8	10		RGV				
R250111P R250111P/1 R250111V R250111N	1	 BANCADA	64	80	8		G1ALGHI				
R250412N R250412P	1	 DISTRIBUCIÓN	40	56	7		GALGRD				
R250413P R250413P/1	2	 ÁRBOL DE LEVAS	30	52	7		GALGRD				
R250448N	1	 SELECTOR CAJA DE VELOCIDAD	16	24.6	9/20		ESP				











CATALOGO DE RETENES

CATALOGO DE RETENTORES - OIL SEAL CATALOG

FIAT

Código Code	Cant. Qty	Descripción Descrição Descrição	DE [mm]	DA [mm]	H [mm]	A [mm]		Aplicación Aplicação Application	Cm³ Cm³	Motor Motor Engine	Jgo. Juntas Set Gaskets
R250451N	1	 CAJA DE VELOCIDAD	22	40	7/8.5		G2LGHD	128, 147, Spazio, Brio Ritmo 60, Strada 60 1971/...	1116cc.	128A (SOHC) 8V	250400-R
R250455N	1	 RUEDA TRASERA	42	56	7		GA				
R250457P	1	 DIFERENCIAL SEMI-ÁRBOL	23	37	13.5		ESP				
R270510P R270510V	1	 GUÍA VÁLVULAS (8) R260610V/1	7	9.8	10		RGV	Punto 60 Cabrio 1995/99 Palio 75, Siena 1996/...	1242cc.	176B4/176B1/176A7 178B5 (SOHC) 8V	251700
R260113P R260113P/1 R260113V	1	 ÁRBOL DE LEVAS	30	42	7		GALGHD	Punto 60, Punto Selecta 1993/99		Inyeccion Monopunto y Multipunto	
R271210V R271210VM/2	1	 GUÍA VÁLVULAS (8) A GRANEL (200)	5	7.8	8		RGV	Fire 1.3, Fiorino, 500 2007/...	1242cc. 1242cc.	350 A1 (SOHC) 8V Fire (SOHC) 8V	2719000-R 273600-R MLS
PR271911VF	1	 PORTA BANCADA	74				PORTA				
R270713P R270713P/1 R270713V	1	 ÁRBOL DE LEVAS	40	55	7		G1ALGHD				
R270515V	1	 BOMBA DE ACEITE	27	37	7		G1ALGHD				
R270710V	1	 GUÍA VÁLVULAS (16) R230510V/1	6	8.8	9.5		RGV	Palio, Siena, Palio Weekend Palio Novo, Novo Siena, Doblo Palio 2002/..., Siena 2005/... Punto 2003/..., Idea, Stilo 2004/..., Doblo 2010/...	1242cc.	Fire 188.A5 (DOHC) 16V	270700-R
PR270711V	1	 PORTA BANCADA	74				PORTA		1242cc.	178D7 (DOHC) 16V	272500-R MLS
R270713P R270713P/1 R270713V	2	 ÁRBOL DE LEVAS	40	55	7		G1ALGHD				
R270515V	1	 BOMBA DE ACEITE	27	37	7		G1ALGHD				
R271511V R271511VF	1	 BANCADA	78	100	9		RGV	Punto ELX JTD 2003/...	1248cc.	188A9 (DOHC) 16V DIESEL	271500-R MLS
R460213P R460213V	1	 DISTRIBUCIÓN	36	50	8		GALGHD	Strada Trekking Fase III JTD 2010/...			
R250400	1	 KIT DE RETENES					KIT	128, Europa, 147, Spazio 1971/81	1290cc.	128A1 (SOHC) 8V	250500-R
R250410V R250410VM/1 R250410VM/2 R250410VM/3	1	 GUÍA VÁLVULAS (8) A GRANEL (200) A GRANEL (200) A GRANEL (1000)	8	10.8	10		RGV	Regata 70, Ritmo Strada 65, Uno 70, Iva, TV 147 Sorpasso Fiorino 1982/...	1301cc.	138B2 (SOHC) 8V	250500-R
R250111P R250111P/1 R250111V R250111N	1	 BANCADA	64	80	8		G1ALGHI				
R250412N R250412P	1	 DISTRIBUCIÓN	40	56	7		GALGRD				
R250413P R250413P/1	1	 ÁRBOL DE LEVAS	30	52	7		GALGRD				
R260000	1	 KIT DE RETENES					KIT	147, Oggi, Panorama, Uno Premio Trend	1300cc.	127AB 2C (OHV) 8V	260500-R
R250410V R250410VM/1 R250410VM/2 R250410VM/3	1	 GUÍA VÁLVULAS (8) A GRANEL (200) A GRANEL (200) A GRANEL (1000)	8	10.8	10		RGV				























FIAT

Código Code	Cant. Qty	Descripción Descrição Descrição	DE [mm]	DA [mm]	H [mm]	A [mm]		Aplicación Aplicação Application	Cm³ Cm³	Motor Motor Engine	Jgo. Juntas Set Gaskets
R260011P	1	 BANCADA	70	85	8		G1ALGRI	147, Oggi, Panorama, Uno Premio Trend	1300cc.	127AB 2C (OHV) 8V	260500-R
R250412N R250412P	1	 DISTRIBUCIÓN	40	56	7		GALGRD				
R250413P R250413P/1	2	 ÁRBOL DE LEVAS	30	52	7		GALGRD				
R270510P R270510V	1	 GUÍA VÁLVULAS (8) R260610V/1	7	9.8	10		RGV	Uno, Palio, Siena, Mille Fire	1300cc.	Fire MPI (SOHC) 8V	270500-R
R270511V	1	 BANCADA	74	88	8		G1ALGRI				
PR270511V	1	 PORTA BANCADA	74				PORTA				
R260113P R260113P/1 R260113V	1	 ÁRBOL DE LEVAS	30	42	7		GALGHD				
R270515V	1	 BOMBA DE ACEITE	27	37	7		G1ALGHD				
R260000	1	 KIT DE RETENES					KIT				
R250410V R250410VM/1 R250410VM/2 R250410VM/3	1	 GUÍA VÁLVULAS (8) A GRANEL (200) A GRANEL (200) A GRANEL (1000)	8	10.8	10		RGV				
R260011P	1	 BANCADA	70	85	8		G1ALGHI				
R250412N R250412P	1	 DISTRIBUCIÓN	40	56	7		GALGRD				
R250413P R250413P/1	2	 ÁRBOL DE LEVAS	30	52	7		GALGRD				
R273010V	1	 GUÍA VÁLVULAS (8) R272910V/1	5	8.85	18.25	23.45	RGV	Argo, Cronos 2018/...	1332cc.	Firefly (SOHC) 8V	273000-R
R520811V	1	 BANCADA	86	96	9		GALGRI				
R460700	1	 KIT DE RETENES					JUEGO	Qubo, Fiorino Qubo	1360cc.	(SOHC) 8V	452200-R
R460710V R460710P	1	 GUÍA VÁLVULAS (8) R260610V/1	7	9.8	10		RGV				
R560111P R560111V	1	 BANCADA	85	105	8		GALGRI				
R460712V	1	 DISTRIBUCIÓN	42	66	8		GALGHD				
R460213P R460213V	1	 ÁRBOL DE LEVAS	36	50	8		GALGHD				
R271210V R271210VM/2	1	 GUÍA VÁLVULAS (8) A GRANEL (200)	5	7.8	8		RGV				
PR270511V	1	 PORTA BANCADA	74				PORTA				
R260113P R260113P/1 R260113V	1	 ÁRBOL DE LEVAS	30	42	7		GALGHD				
R270515V	1	 BOMBA DE ACEITE	27	37	7		G1ALGHD				





















CATALOGO DE RETENES

CATALOGO DE RETENTORES - OIL SEAL CATALOG

FIAT

Código Code	Cant. Qty	Descripción Descrição Descrição	DE [mm]	DA [mm]	H [mm]	A [mm]		Aplicación Aplicação Aplicacion	Cm³ Cm³	Motor Motor Engine	Jgo. Juntas Set Gaskets
R271210V R271210VM/2	1	 GUÍA VÁLVULAS (8)	5	7.8	8		RGV	Fire 1.4 ELX, Evo 2010/... Idea 2003/..., Palio Fase II/III 2007/13, Siena Generación III MPI 2002/..., Grande Punto 2005/..., Linea 2007/..., Strada Fase III Fiorino XMF 2016/18	1368cc.	169 A4 (SOHC) 8V	2719000-R
PR271911VF	1	 PORTA BANCADA	74				PORTA		1368cc.	169 A4 (SOHC) 8V	2719000-R
R270713P R270713P/1 R270713V	1	 ÁRBOL DE LEVAS	40	55	7		G1ALGHD	500, Punto, Bravo, Doblo Punto T-Jet 2009/... Palio 2002/..., Siena 2005/... Punto 2003/..., Idea, Stilo 2004/..., Doblo 2010/... 500L 2007/...	1368cc.	Fire Evo (SOHC) 8V	273600-R MLS
R270515V	1	 BOMBA DE ACEITE	27	37	7		G1ALGHD		1368cc.	Fire Evo (SOHC) 8V	273600-R MLS
R270710V	1	 GUÍA VÁLVULAS (16) R230510V/1	6	8.8	9.5		RGV		1368cc.	198A4/199A8/955A6/A8 (DOHC) 16V	272400-R MLS
PR270711V	1	 PORTA BANCADA	74				PORTA		1368cc.	Fire 183A1/192B2 (DOHC) 16V	272500-R MLS
R270713P R270713P/1 R270713V	2	 ÁRBOL DE LEVAS	40	55	7		G1ALGHD	Spazio, Duna, Tipo, Uno Vivace, Palio, Siena 1988/91 Fiorino 1993/95	1368cc.	Fire Evo (SOHC) 8V	273600-R MLS
R270515V	1	 BOMBA DE ACEITE	27	37	7		G1ALGHD		1368cc.	Fire Evo (SOHC) 8V	273600-R MLS
R260200	1	 KIT DE RETENES					KIT		1372cc.	160A1 - 146C1/5 159A2 7	260200-R
R250410V R250410VM/1 R250410VM/2 R250410VM/3	1	 GUÍA VÁLVULAS (8) A GRANEL (200) A GRANEL (200) A GRANEL (1000)	8	10.8	10		RGV		1372cc.	160A1 - 146C1/5 159A2 7	260200-R
R250111P R250111P/1 R250111V R250111N	1	 BANCADA	64	80	8		G1ALGHI	1500 Berlina, Familiar Multicarga 1963/69	1481cc.	115C (OHV) 8V	250200-R
R250412N R250412P	1	 DISTRIBUCIÓN	40	56	7		GALGRD		1481cc.	115C (OHV) 8V	250200-R
R250413P R250413P/1	2	 ÁRBOL DE LEVAS	30	52	7		GALGRD		1481cc.	115C (OHV) 8V	250200-R
R260251P	1	 CAJA DE VELOCIDAD	22.8	40	7/8.5		G2LGHD		1481cc.	115C (OHV) 8V	250200-R
R250110P R250110PN/1	1	 GUÍA VÁLVULAS (8) A GRANEL (200)	7	11.8	10.2		RGV		1481cc.	115C (OHV) 8V	250200-R
R250211P R250211N	1	 BANCADA	80	100	10		GALGHI		1481cc.	115C (OHV) 8V	250200-R
R250212N	1	 DISTRIBUCIÓN	45	65	10		E-GAHD		1481cc.	115C (OHV) 8V	250200-R
R250255N	1	 RUEDA TRASERA EXTERIOR	30	45	8		GA		1481cc.	115C (OHV) 8V	250200-R
R250256N	1	 RUEDA TRASERA INTERIOR	32.54	51.43	9.92		GA		1481cc.	115C (OHV) 8V	250200-R
R250257N	1	 PIÑÓN	36	68	10/13		GAHD		1481cc.	115C (OHV) 8V	250200-R
R250258N	1	 RUEDA DELANTERA	45	59	10		G1	1481cc.	115C (OHV) 8V	250200-R	
R260000	1	 KIT DE RETENES					KIT	Palio 1.5 EL MPI 96	1495cc.	EL MPI (SOHC) 8V	270200-R
R250410V R250410VM/1 R250410VM/2 R250410VM/3	1	 GUÍA VÁLVULAS (8) A GRANEL (200) A GRANEL (200) A GRANEL (1000)	8	10.8	10		RGV		1495cc.	EL MPI (SOHC) 8V	270200-R



















FIAT

Código Code	Cant. Qty	Descripción Descrição Description	DE [mm]	DA [mm]	H [mm]	A [mm]		Aplicación Aplicação Application	Cm³ Cm³	Motor Motor Engine	Jgo. Juntas Set Gaskets
R260011P	1	 BANCADA	70	85	8		G1ALGHI	Palio 1.5 EL MPI 96	1495cc.	EL MPI (SOHC) 8V	270200-R
R250412N R250412P	1	 DISTRIBUCIÓN	40	56	7		GALGRD				
R250413P R250413P/1	2	 ÁRBOL DE LEVAS	30	52	7		GALGRD				
R250400	1	 KIT DE RETENES					KIT	Ritmo Strada 75 Ritmo Strada 85 1978/82 128 Regatta 85, Ritmo 1986/90, Duna, Uno, Super Europa 1983/..., Elba, Premio, Fiorino	1498cc. 1498cc.	138A2-A4 (SOHC) 8V 138C3 (DOHC) 8V	250500-R 250600-R
R250410V R250410VM/1 R250410VM/2 R250410VM/3	1	 GUÍA VÁLVULAS (8) A GRANEL (200) A GRANEL (200) A GRANEL (1000)	8	10.8	10		RGV				
R250111P R250111P/1 R250111V R250111N	1	 BANCADA	64	80	8		G1ALGHI				
R250412N R250412P	1	 DISTRIBUCIÓN	40	56	7		GALGRD				
R250413P R250413P/1	1	 ÁRBOL DE LEVAS	30	52	7		GALGRD				
R250652N	1	 SEMIEJE PALIER	22	35	8		GALG	128 Regatta '85, Ritmo 1986/90, Duna, Uno, Super Europa 1983/..., Elba, Premio, Fiorino	1498cc.	138C3 (DOHC) 8V	250600-R
R250660-1P	1	 SEMIEJE DERECHO	29.8	50	10/13		G1ALGHD				
R250660P	1	 SEMIEJE IZQUIERDO	29.8	52	10/13		G1ALGHI				
R260200	1	 KIT DE RETENES					KIT	Duna, Uno, Regatta, Palio Siena, Premio, Elba, Tipo Fiorino 1988/...	1581cc.	Sevel 146C6 - 159A3 - 160A2 8 (SOHC) 8V	260300-R
R250410V R250410VM/1 R250410VM/2 R250410VM/3	1	 GUÍA VÁLVULAS (8) A GRANEL (200) A GRANEL (200) A GRANEL (1000)	8	10.8	10		RGV				
R250111P R250111P/1 R250111V R250111N	1	 BANCADA	64	80	8		G1ALGHI				
R250412N R250412P	1	 DISTRIBUCIÓN	40	56	7		GALGRD				
R250413P R250413P/1	2	 ÁRBOL DE LEVAS	30	52	7		GALGRD				
R260610V R260610VM/1 R260610VM/2 R260610VM/3	1	 GUÍA VÁLVULAS (16) A GRANEL (200) A GRANEL (200) A GRANEL (1000)	7	9.8	10		RGV	Palio, Siena, Tipo, Bravo Marea, Multipla 1999/...	1581cc.	182A4A6 - 186A3/A4 (DOHC) 16V	260900-R
PR260911V	1	 PORTA BANCADA	64	81.5	8		PORTA				
R260312P R260312P/1 R260312V R260312N	1	 DISTRIBUCIÓN	40	56	7		G1ALGHD				
R260113P R260113P/1 R260113V	1	 ÁRBOL DE LEVAS	30	42	7		GALGHD				
R260313P R260313P/1 R260313V R260313N	2	 ÁRBOL DE LEVAS	30	52	7		G1ALGHD				























CATALOGO DE RETENES

CATALOGO DE RETENTORES - OIL SEAL CATALOG

FIAT

Código Code	Cant. Qty	Descripción Descrição Descrição	DE [mm]	DA [mm]	H [mm]	A [mm]		Aplicación Aplicação Application	Cm³ Cm³	Motor Motor Engine	Jgo. Juntas Set Gaskets
R260914P R260914V	1	 AUXILIAR	30	47	7		G1ALGHD	Palio, Siena, Tipo, Bravo Marea, Multipla 1999/...	1581cc.	182A4A6 - 186A3/A4 (DOHC) 16V	260900-R
R260950P	1	 CAJA DE VELOCIDAD	63	69.5	11		ESP				
R260400	1	 KIT DE RETENES					KIT	Regata 100S 1985/...	1585cc.	149A (SOHC) 8V	250900-R
R250410V R250410VM/1 R250410VM/2 R250410VM/3	1	 GUÍA VÁLVULAS (8) A GRANEL (200) A GRANEL (200) A GRANEL (1000)	8	10.8	10		RGV				
R260111P R260111V	1	 BANCADA	74	90	10		G1ALGRI				
R260112P R260112V	1	 DISTRIBUCIÓN	30	43	8		G1ALGHD				
R250413P R250413P/1	2	 ÁRBOL DE LEVAS	30	52	7		GALGRD				
R260610V R260610VM/1 R260610VM/2 R260610VM/3	1	 GUÍA VÁLVULAS (16) A GRANEL (200) A GRANEL (200) A GRANEL (1000)	7	9.8	10		RGV	Palio, Siena, Marea Multipla 2001/...	1596cc.	182B6 - 178E7 (DOHC) 16V	261100-R MLS
PR260911V	1	 PORTA BANCADA	64	81.5	8		PORTA				
R260312P R260312P/1 R260312V R260312N	1	 DISTRIBUCIÓN	40	56	7		G1ALGHD				
R260113P R260113P/1 R260113V	1	 ÁRBOL DE LEVAS	30	42	7		GALGHD				
R260313P R260313P/1 R260313V R260313N	2	 ÁRBOL DE LEVAS	30	52	7		G1ALGHD				
R272010P	1	 GUÍA VÁLVULAS (16) R272010P/1	6	11	18.3		RGV	Idea Essence, Idea Sporting, Idea Adventure, Siena Fase III Essence, Strada Fase III/IV Palio Wend Fase III/IV Adventure 2010/... Punto Essence 2011/... Grand Siena 2012/... Idea 2011/16, Palio 2012/... Punto 2013/17, Strada 2013/... Tipo 2017/...	1598cc.	E.torQ 178D20.11 178D22.11 (SOHC) 16V	272000-R MLS
R330511V	1	 BANCADA	91	111	10		G1ALGRI				
R230412P	1	 DISTRIBUCIÓN	32	45	6.5		GALGRD		1598cc.	E.torq (SOHC) 16V	272600-R MLS
R270713P R270713P/1 R270713V	1	 ÁRBOL DE LEVAS	40	55	7		G1ALGHD		1598cc.	E.torq Evo	273500-R MLS
R250110P R250110PN/1	1	 GUÍA VÁLVULAS (8) A GRANEL (200)	7	11.8	10.2		RGV	1600 Berlina, Coupe 1969/72	1600cc.	115C (OHV) 8V	250200-R
R250211P R250211N	1	 BANCADA	80	100	10		GALGHI				
R250212N	1	 DISTRIBUCIÓN	45	65	10		E-GAHD				
R250255N	1	 RUEDA TRASERA EXTERIOR	30	45	8		GA				
R250256N	1	 RUEDA TRASERA INTERIOR	32.54	51.43	9.92		GA				





















FIAT

Código Code	Cant. Qty	Descripción Descrição Descrição	DE [mm]	DA [mm]	H [mm]	A [mm]		Aplicación Aplicação Aplicacion	Cm³ Cm³	Motor Motor Engine	Jgo. Juntas Set Gaskets
R250257N	1	 PIÑÓN	36	68	10/13		GAHD	1600 Berlina, Coupe 1969/72	1600cc.	115C (OHV) 8V	250200-R
R250258N	1	 RUEDA DELANTERA	45	59	10		G1				
R250700	1	 KIT DE RETENES					KIT	125 (Bialbero), Berlina Sport Multicarga Mirafiori 1972/74	1608cc.	125AB - 125A	250700-R
R250410V R250410VM/1 R250410VM/2 R250410VM/3	1	 GUÍA VÁLVULAS (8) A GRANEL (200) A GRANEL (200) A GRANEL (1000)	8	10.8	10		RGV				
R550411P R550411N	1	 BANCADA	70	90	10		GALGHI				
R250412N R250412P	1	 DISTRIBUCIÓN	40	56	7		GALGRD				
R250413P R250413P/1	1	 ÁRBOL DE LEVAS	30	52	7		GALGRD				
R250757N	1	 PIÑÓN DE LEVAS	46	78	10		G1LGHD				
R260400	1	 KIT DE RETENES					JUEGO	Duna, Uno, Regatta Fiorino 1985/... Fiorino, Uno, Tipo, Palio, Ducato D/TD	1697cc.	149B - 146B (SOHC) 8V	260401-R (260400) 260401-R (270000)
R250410V R250410VM/1 R250410VM/2 R250410VM/3	1	 GUÍA VÁLVULAS (8) A GRANEL (200) A GRANEL (200) A GRANEL (1000)	8	10.8	10		RGV		1697cc.	149B - 176A (SOHC) 8V DIESEL	
R260111P R260111V	1	 BANCADA	74	90	10		G1ALGRI				
R260112P R260112V	1	 DISTRIBUCIÓN	30	43	8		G1ALGHD				
R250413P R250413P/1	2	 ÁRBOL DE LEVAS	30	52	7		GALGRD				
R272010P	1	 GUÍA VÁLVULAS (16) R272010P/1	6	11	18.3		RGV	Punto, Idea, Linea 2011/.. Argo, Bravo 2011/16, Doblo 2010/..., Idea 2011/16 Linea 2009/16, Palio 2013/.. Punto 2013/17, Strada 2013/.. Argo, Cronos 2017/...	1747cc.	Fiat E-Torq (SOHC) 16V	272100-R MLS 272700-R MLS
R330511V	1	 BANCADA	91	111	10		G1ALGRI		1747cc.	E.torq Evo (SOHC) 16V	
R230412P	1	 DISTRIBUCIÓN	32	45	6.5		GALGRD				
R270713P R270713P/1 R270713V	1	 ÁRBOL DE LEVAS	40	55	7		G1ALGHD				
R260610V R260610VM/1 R260610VM/2 R260610VM/3	1	 GUÍA VÁLVULAS (16) A GRANEL (200) A GRANEL (200) A GRANEL (1000)	7	9.8	10		RGV	Marea 1996/... Brava, Bravo 1995/...	1747cc.	182A2 (DOHC) 16V	272300-R
PR270911V	1	 PORTA BANCADA	93				PORTA				
R260111P R260111V	1	 BANCADA	74	90	10		G1ALGRI				
R260112P R260112V	1	 DISTRIBUCIÓN	30	43	8		G1ALGHD				
R270612V	1	 DISTRIBUCIÓN	55	68	8		GALGHD				
R260113P R260113P/1 R260113V	1	 ÁRBOL DE LEVAS	30	42	7		GALGHD				





















CATALOGO DE RETENES

CATALOGO DE RETENTORES - OIL SEAL CATALOG

FIAT

Código Code	Cant. Qty	Descripción Descrição Descrição	DE [mm]	DA [mm]	H [mm]	A [mm]		Aplicación Aplicação Application	Cm³ Cm³	Motor Motor Engine	Jgo. Juntas Set Gaskets
R270614V	1	 ÁRBOL DE LEVAS AUXILIAR	30	44	8		GALGHI	Marea 1996/... Brava, Bravo 1995/...	1747cc.	182A2 (DOHC) 16V	272300-R
R270615V	1	 ÁRBOL DE LEVAS AUXILIAR	31	41	7		GALGHD				
R260400	1	 KIT DE RETENES					KIT	Tempra, Tipo 1992/95	1756cc.	835C (DOHC) 8V	260100-R
R250410V R250410VM/1 R250410VM/2 R250410VM/3	1	 GUÍA VÁLVULAS (8) A GRANEL (200) A GRANEL (200) A GRANEL (1000)	8	10.8	10		RGV				
R260111P R260111V	1	 BANCADA	74	90	10		G1ALGRI				
R260112P R260112V	1	 DISTRIBUCIÓN	30	43	8		G1ALGHD				
R250413P R250413P/1	1	 ÁRBOL DE LEVAS	30	52	7		GALGRD				
R280610V	1	 GUÍA VÁLVULAS (16) R230510V/1	6	8.8	9.5		RGV	Palio Fase II 2004/...	1781cc.	ALX (DOHC) 16V	241800-R MLS
R240411P R240411P/1 R240411V	1	 BANCADA	80	98	10		G1ALGRI				
R550413P R550413N	1	 DISTRIBUCIÓN	30	42	8		GAHI				
R240013P R240013P/1 R240013V	2	 ÁRBOL DE LEVAS	35	48	7		GALGHD				
R242210V	1	 GUÍA VÁLVULAS (8) R230510V/1	6	8.8	9.5		RGV	Stylo, Strada Working Adventure, Palio 2003	1796cc.	OHC 171190	242200-R
R240210P R240210V R240210VM/1 R240210VM/2 R240210VM/3	1	 GUÍA VÁLVULAS (8) GUÍA VÁLVULAS (8) A GRANEL (200) A GRANEL (200) A GRANEL (1000)	7	11.1	10		RGV				
R240411P R240411P/1 R240411V	1	 BANCADA	80	98	10		G1ALGRI				
R240013P R240013P/1 R240013V	1	 ÁRBOL DE LEVAS	35	48	7		GALGHD				
R240415P R240415P/1 R240415V	1	 DISTRIBUCIÓN	26	42	8		G1ALGHD				
R252310V	1	 GUÍA VÁLVULAS (8) R230510V/1	6	8.8	9.5		RGV	Palio, Stilo, Palio Flex, Strada Siena Flex 2003/... Idea Adventure HLX, G2/G3 2006/...	1796cc.	OHC-171190 - 17241C1 G2/G3	252300-R MLS
R240210P R240210V R240210VM/1 R240210VM/2 R240210VM/3	1	 GUÍA VÁLVULAS (8) GUÍA VÁLVULAS (8) A GRANEL (200) A GRANEL (200) A GRANEL (1000)	7	11.1	10		RGV				
R240411P R240411P/1 R240411V	1	 BANCADA	80	98	10		G1ALGRI				
R240013P R240013P/1 R240013V	1	 ÁRBOL DE LEVAS	35	48	7		GALGHD				























FIAT

Código Code	Cant. Qty	Descripción Descripción	DE [mm]	DA [mm]	H [mm]	A [mm]		Aplicación Aplicação Application	Cm³ Cm³	Motor Motor Engine	Jgo. Juntas Set Gaskets
R240415P R240415P/1 R240415V	1	 DISTRIBUCIÓN	26	42	8		G1ALGHD	Palio, Stilo, Palio Flex, Strada Siena Flex 2003/... Idea Adventura HLX, G2/G3 2006/...	1796cc.	OHC-171190 - 17241C1 G2/G3	252300-R MLS
R291010V	1	 GUÍA VÁLVULAS (16) R291010V/1	5	7.8	15.5	23	RGV	Croma 2005/...	1796cc.	939A4 (DOHC) 16V	291000-R MLS
PR291011T	1	 PORTA BANCADA	79				PORTA				
R230512P R230512P/1 R230512V	1	 DISTRIBUCIÓN	32	42	7		G1ALGHD				
R240013P R240013P/1 R240013V	2	 ÁRBOL DE LEVAS	35	48	7		GALGHD				
R260610V R260610VM/1 R260610VM/2 R260610VM/3	1	 GUÍA VÁLVULAS (16) A GRANEL (200) A GRANEL (200) A GRANEL (1000)	7	9.8	10		RGV	Linea 2008/15	1896cc.	310A4011 Torque 16V	272800-R
PR260911V	1	 PORTA BANCADA	64	81.5	8		PORTA				
R260312P R260312P/1 R260312V R260312N	1	 DISTRIBUCIÓN	40	56	7		G1ALGHD				
R260113P R260113P/1 R260113V	1	 ÁRBOL DE LEVAS	30	42	7		GALGHD				
R260313P R260313P/1 R260313V R260313N	2	 ÁRBOL DE LEVAS	30	52	7		G1ALGHD				
R460300	1	 KIT DE RETENES					JUEGO	Ducato TD 1994/... Scudo TD 1995/01	1905cc.c.	D8B/DHX (SOHC) 8V DIESEL	460301-R (460900)
R460210V	1	 GUÍA VÁLVULAS (8) R250410V/1	8	10.8	10		RGV				
R460211V	1	 BANCADA	90	110	7		GALGRI				
R460212P R460212V	1	 DISTRIBUCIÓN	42	62	7		GALGHD				
R470013P R470013P/1 R470013V	1	 ÁRBOL DE LEVAS	35	50	7		GALG-BI				
460235	2	 BASTÓN CIERRE BANCADA									
R250410V R250410VM/1 R250410VM/2 R250410VM/3	1	 GUÍA VÁLVULAS (8) A GRANEL (200) A GRANEL (200) A GRANEL (1000)	8	10.8	10		RGV	Brava, Bravo TD 1996/99 Marengo TD, Marea TD Brava, Bravo TD, Multipla TD Marea TD 1998/... Marea JTD 2000/02, Stilo JTD Idea JTD, Punto 2003/... Palio JTD 2002/..., Strada	1910cc. 1910cc. 1910cc.	182A8/A7 (SOHC) 8V 182 B4 (SOHC) 8V 186 A6 - 192 A1/3 188 B2 - 182 B9 (SOHC) 8V DIESEL	252001-R 252101-R 252401-R
R252012V	1	 DISTRIBUCIÓN	31	41	7		G1ALGHD				
R260113P R260113P/1 R260113V	1	 ÁRBOL DE LEVAS	30	42	7		GALGHD				
R260400	1	 KIT DE RETENES					KIT	Tipo, Tempra, Palio, Siena TD	1929cc.	160D - 280A1 (SOHC) 8V DIESEL	260401-R (270000)

























CATALOGO DE RETENES

CATALOGO DE RETENTORES - OIL SEAL CATALOG

FIAT

Código Code	Cant. Qty	Descripción Descrição Descrição	DE [mm]	DA [mm]	H [mm]	A [mm]		Aplicación Aplicação Aplicacion	Cm³ Cm³	Motor Motor Engine	Jgo. Juntas Set Gaskets
R250410V R250410VM/1 R250410VM/2 R250410VM/3	1	 GUÍA VÁLVULAS (8)	8	10.8	10		RGV	Tipo, Tempra, Palio, Siena TD	1929cc.	160D - 280A1 (SOHC) 8V DIESEL	260401-R (270000)
R260111P R260111V	1	 BANCADA	74	90	10		G1ALGRI				
R260112P R260112V	1	 DISTRIBUCIÓN	30	43	8		G1ALGHD				
R250413P R250413P/1	2	 ÁRBOL DE LEVAS	30	52	7		GALGRD				
R253010V	1	 GUÍA VÁLVULAS (16) R253010V/1	5	10	15.5	23.48	RGV	Toro 2016/...	1956cc.	Multijet TD (DOHC) 16V DIESEL	253001-R
PR270911V	1	 PORTA BANCADA	93				PORTA				
R250255N	1	 DISTRIBUCIÓN	30	45	8		GA				
R260400	1	 KIT DE RETENES					KIT	Regatta 2000, Bialbero Tempra 1989/...	1987cc.	154C (DOHC) 8V	260100-R
R250410V R250410VM/1 R250410VM/2 R250410VM/3	1	 GUÍA VÁLVULAS (8) A GRANEL (200) A GRANEL (200) A GRANEL (1000)	8	10.8	10		RGV	Tempra i.e., Tipo i.e., Cromia i.e. Cromia i.e Turbo 1992/95	1995cc.	154C4.046 - 159A6.046 834B.146 - ACT (DOHC) 8V	260800-R
R260111P R260111V	1	 BANCADA	74	90	10		G1ALGRI				
R260112P R260112V	1	 DISTRIBUCIÓN	30	43	8		G1ALGHD				
R250413P R250413P/1	2	 ÁRBOL DE LEVAS	30	52	7		GALGRD				
R260600	1	 KIT DE RETENES					KIT	Tempra 1992/... Tipo i.e. 1989/93 Cromia i.e 1993/... Coupe i.e, Turbo 1994/...	1995cc.	160A - 154E - 836A (DOHC) 16V	260600-R
R260610V R260610VM/1 R260610VM/2 R260610VM/3	1	 GUÍA VÁLVULAS (16) A GRANEL (200) A GRANEL (200) A GRANEL (1000)	7	9.8	10		RGV				
R260111P R260111V	1	 BANCADA	74	90	10		G1ALGRI				
R260112P R260112V	1	 DISTRIBUCIÓN	30	43	8		G1ALGHD				
R260113P R260113P/1 R260113V	2	 ÁRBOL DE LEVAS	30	42	7		GALGHD				
R260313P R260313P/1 R260313V R260313N	1	 ÁRBOL DE LEVAS	30	52	7		G1ALGHD				
R270910V	1	 GUÍA VÁLVULAS (20) R260610V/1	7	9.8	10		RGV	Marea 1996/98 - 1998/... Coupe 1996/01 Bravo 1995/98	1998cc.	182A1 - 182B3/B7 (DOHC) 20V	270900-R
PR270911V	1	 PORTA BANCADA	93				PORTA				
R270612V	1	 DISTRIBUCIÓN	55	68	8		GALGHD				
R260113P R260113P/1 R260113V	1	 ÁRBOL DE LEVAS	30	42	7		GALGHD				





FIAT

Código Code	Cant. Qty	Descripción Descrição Descripción	DE [mm]	DA [mm]	H [mm]	A [mm]		Aplicación Aplicação Aplicacion	Cm³ Cm³	Motor Motor Engine	Jgo. Juntas Set Gaskets
R270615V	1	 ÁRBOL DE LEVAS SECUNDARIO	31	41	7		GALGHD	Marea 1996/98 - 1998/... Coupe 1996/01, Bravo 1995/98	1998cc.	182A1 - 182B3/B7 (DOHC) 20V	270900-R
R270910V	1	 GUÍA VÁLVULAS (20) R260610V/1	7	9.8	10		RGV	Bravo, Coupe, Marea 1998/01	1998cc.	182B7 - 182B3 (DOHC) 20V	271300-R
R270612V	1	 DISTRIBUCIÓN	55	68	8		GALGHD				
R260113P R260113P/1 R260113V	1	 ÁRBOL DE LEVAS	30	42	7		GALGHD				
R270615V	1	 ÁRBOL DE LEVAS SECUNDARIO	31	41	7		GALGHD				
R461510P	1	 GUÍA VÁLVULAS (12) (R250410V/1)	8	10.8	10		RGV				
R460211V	1	 BANCADA	90	110	7		GALGRI	R460212P R460212V	2088cc.	XUD11ATE/L (P8C) (SOHC) 12V DIESEL	461501-R
R460212P R460212V	1	 DISTRIBUCIÓN	42	62	7		GALGHD				
R470013P R470013P/1 R470013V	1	 ÁRBOL DE LEVAS	35	50	7		GALG-BI				
460235	2	 BASTÓN CIERRE BANCADA									
R302010V	1	 GUÍA VÁLVULAS (16) R302010V/1	7	12	18.8	24.2	RGV	Ducato 2006/...	2198cc.	4HU (DOHC) 16V DIESEL	324801-R
PR302011T	1	 PORTA BANCADA	105				PORTA	R470013P R470013P/1 R470013V	2198cc.	4HU (DOHC) 16V DIESEL	324801-R
R470013P R470013P/1 R470013V	1	 ÁRBOL DE LEVAS	35	50	7		GALG-BI				
R270115V	1	 ÁRBOL DE LEVAS AUXILIAR	55	70	10		GALGHD				
R270100	1	 KIT DE RETENES					KIT	Nuovo Ducato 1989/94	2445cc.	8140.67	270400-R 270401-R 270100-R 270101-R
R270110P	1	 GUÍA VÁLVULAS (8) R430010V/1	8	12	9.5	15.2	RGV	Ducato TD 1990/94, Ducato TDS 1994/96 Ducato TDSE 1996/... Ducato 1994/...	2499cc.	8140.27 8140.47R 8140.47.X230 8140.67X230	270400-R 270401-R 252901-R
R270111V	1	 BANCADA	90	115	13		GALGHI	Ducato JTD 2006/09	2499cc.	8140.67X230	270400-R 270401-R 252901-R
PR270111V	1	 PORTA BANCADA	114				PORTA	Ducato 14/14D Ducato 18/18D 1998/...	2798cc.	8140.43S Euro III Common Rail 8140.63 (SOHC) 8V	251101-R
R270112P R270112V	1	 BANCADA	70	90	10		GALGHD	Ducato 14/14D Ducato 18/18D 1998/...	2799cc.	8140.43S Euro III Common Rail 8140.63 (SOHC) 8V	251101-R
PR270112V	1	 PORTA DISTRIBUCIÓN	70				PORTA				
R270113P R270113V	1	 ÁRBOL DE LEVAS	50	70	10		GALGRD				
R270115V	1	 ÁRBOL DE LEVAS AUXILIAR	55	70	10		GALGHD	Ducato 14TDS Ducato Maxi 18TDS 1996/...	2799cc.	8140.43 (SOHC) 8V DIESEL	270300-R 270301-R
R270100	1	 KIT DE RETENES					KIT				
R270110P	1	 GUÍA VÁLVULAS (8) R430010V/1	8	12/15.2	9.5		RGV				



















CATALOGO DE RETENES

CATALOGO DE RETENTORES - OIL SEAL CATALOG

FIAT

Código Code	Cant. Qty	Descripción Descrição Descrição	DE [mm]	DA [mm]	H [mm]	A [mm]		Aplicación Aplicação Application	Cm³ Cm³	Motor Motor Engine	Jgo. Juntas Set Gaskets
R270111V	1	 BANCADA	90	115	13		GALGHI	Ducato 14TDS Ducato Maxi 18TDS 1996/...	2799cc.	8140.43 (SOHC) 8V DIESEL	270300-R 270301-R
R270311V	1	 BANCADA	100	118	10		GALGHI				
R270112P R270112V	1	 DISTRIBUCIÓN	70	90	10		GALGHD				
R270113P R270113V	1	 ÁRBOL DE LEVAS	50	70	10		GALGRD				
R270115V	1	 ÁRBOL DE LEVAS AUXILIAR	55	70	10		GALGHD				







FIAT IVECO

R270100	1	 KIT DE RETENES					KIT	Daily Turbo 1990/...	2499cc.	8140.27S 8140.47/47S/47R	270100-R 270101-R 270400-R 270401-R 252901-R
R270110P	1	 GUÍA VÁLVULAS (8) R430010V/1	8	12	9.5	15.2	RGV	Daily 30.8 - 35.8 1996/...	2499cc.	8140.67F37 DIESEL	
R270111V	1	 BANCADA	90	115	13		GALGHI	Daily 35.13, 35.13 4x4 38.13, 40.13, 50.13, 60.13, 70.13 2005/10 Daily 30.8 - Daily 35.8 1996/...	2798cc.	8140.43S Euro III - Common Rail	251101-R
PR270111V	1	 PORTA BANCADA	114				PORTA		2799cc.	8140.63 (SOHC) 8V DIESEL	
R270112P R270112V	1	 BANCADA	70	90	10		GALGHD				
PR270112V	1	 PORTA DISTRIBUCIÓN	70				PORTA				
R270113P R270113V	1	 ÁRBOL DE LEVAS	50	70	10		GALGRD				
R270115V	1	 ÁRBOL DE LEVAS AUXILIAR	55	70	10		GALGHD				
R270110P	1	 GUÍA VÁLVULAS (8) R430010V/1	8	12	9.5	15.2	RGV	Turbo Daily 35.10 49.12 1996/... - 45.10 - 49.10 40.10 - Turbo Daily 49.12 60.12 Intercooler	2798cc.	8140.23 - 8140.43 (SOHC) 8V DIESEL	
PR270111V	1	 PORTA BANCADA	114				PORTA				
PR270112V	1	 PORTA DISTRIBUCIÓN	70				PORTA				
R270113P R270113V	1	 ÁRBOL DE LEVAS	50	70	10		GALGRD				
R270115V	1	 ÁRBOL DE LEVAS AUXILIAR	55	70	10		GALGHD				
R270115V	1	 ÁRBOL DE LEVAS AUXILIAR	55	70	10		GALGHD	Daily TD 1985/89 Daily TD 1987/89	2445cc. 2499cc.	8140.21 8140.27 (SOHC) 8V DIESEL	251400
R800311V	1	 BANCADA	114	135	13		G1ALGRI	Camión 150 N Turbo AU130 Eurocargo 150 E23/E20 Eurocargo 75/80/85/95/100 120/130/150/170 E15 Turbo 80/85/100/120/130/135/150 170 E18 Turbo 1991/..., 80/90 100/E21, 135/150/170/180/E23	5861cc. 5861cc.	8060.25 - 8060.45/45S 8060.25 - 8060.45/S (OHV) 12V DIESEL	800300-R 800600-R
R800312P R800312V	1	 DISTRIBUCIÓN	42	65	10		GALGHD				
R800810P	1	 GUÍA VÁLVULAS (24) R520810-1P (12) R520810-2P (12)	6 6.3	12.15 12.15	14.3 14.6		RGV	Eurocargo 80 E18/E21 90 E18/E21 Tector Commonrail Turbo Intercooler EDC 130 E18, 120 E24/E28, 150 E18 2004/...	5880cc.	170E22 - F4AE0681D TDI- EDC (OHV) 24V DIESEL	800800-R
R800811T	1	 BANCADA	130	155	12.5/16		G1ALGRI				
R800812T	1	 DISTRIBUCIÓN	70	100	12.5/16		GALGHD				







CATALOGO DE RETENES

CATALOGO DE RETENTORES - OIL SEAL CATALOG





FIAT IVECO

Código Code	Cant. Qty	Descripción Descripción Description	DE [mm]	DA [mm]	H [mm]	A [mm]		Aplicación Aplicação Application	Cm³ Cm³	Motor Motor Engine	Jgo. Juntas Set Gaskets
R800511P	1	 BANCADA	140	165	13		G1ALGRI	Camión Bus 341A, 221, 221H 619 NP 1965/66, 693 N/N1 T/T1 1965/68 Camión 619N1, 697N TB Bus 391, 691, 319N Bus 221A 1970/...	12883cc.	221 - 8210.01	800200-R
R800012P	1	 DISTRIBUCIÓN	70	90	15		G1LGHD		13798cc.	8210.02 (OHV) 12V DIESEL	800000-R 800001
R280415N	1	 ÁRBOL DE LEVAS	25	40	8		GALG-BI				
R800055N	1	 RUEDA TRASERA	180	200	12		G1ALG				
R800511P	1	 BANCADA	140	165	13		G1ALGRI	Euro Trakker, Euro Star Euro Tech 1989/..., 180E42 190E31/E42/E36 240E42/E36, 260E37/E42/E36 400E31/E37/E42, 410E37/E42 440E37/E42, 720E31, 380E31 1991/...	13798cc.	8210.42L LE2 8210.42K KE2 8210.22.800 (SOHC) 12V DIESEL	800500-R
R270112V R270112P	1	 DISTRIBUCIÓN	70	90	10		GALGHD				
R800513V	1	 ÁRBOL DE LEVAS	45	75	10		G1ALGHI				

FIAT TRACTOR

R700612N	1	 DISTRIBUCIÓN	55	72	10		GALGHD	Tractor U25 1957/62 Tractor 211R 1962/65	1135cc.	U25 - 211R - CD DIESEL	700600
R700912N	1	 DISTRIBUCIÓN	42	72	10		GALG	Tractor 411R/411T 431R 1959/85	2270cc.	615 DIESEL	700900
R310410V	1	 GUÍA VÁLVULAS (8) R310410V/1	9	13.4	11		RGV	850E Escavadora FB80	2977cc. 3922cc.	D225-4 DIESEL D229-4 (SOHC) 8V DIESEL	440000 310400-R
R310411V	1	 BANCADA	100	130	13		GALGHI				
R310412P R310412V	1	 DISTRIBUCIÓN	78	100	13		GALGHD				
R310458N	1	 RUEDA DELANTERA	58.95	76	9		G1SRLG	Escavadora FB80	3922cc.	D229-4 (SOHC) 8V DIESEL	310400-R
R310510V	1	 GUÍA VÁLVULAS (12) R310410V/1 (12)	9	13.4	11		RGV	Tractor AD7B, 980E, S90 Tractor S90, FE105, FA120 FE105B	5100cc. 5883cc.	D225-6 D229-6 Turbo DIESEL	440100-R 310500-R
R310411V	1	 BANCADA	110	130	13		GALGHI				
R310412P R310412V	1	 DISTRIBUCIÓN	78	100	13		GALGHD				
R700112N	1	 DISTRIBUCIÓN	64	85	12		GAHD	Tractor 1962/69	6872cc.	780 - R - AE DIESEL	700100
R700212N	1	 DISTRIBUCIÓN	75	100	17		GALGHD	Tractor - CP3 1972/80	7412cc.	840 - 900 - 1100 CP3 - 900E DIESEL	700200





















FORD

R310810P R310810V R310810VM/1 R310810VM/2	1	 GUÍA VÁLVULAS (8) GUÍA VÁLVULAS (8) A GRANEL (200) A GRANEL (200)	7	10.9	9.5		RGV	Escort Hobby 1.0 1993/... Escort 1.3 1983/...	997cc. 1300cc.	CHT/AE (SOHC) 8V	310700-R
R300711P	1	 BANCADA	82	105	12		GALGHI				
R550412N R550412P R550412P/1 R550412V	1	 DISTRIBUCIÓN	35	50	9		GALGHD				
R310760P	1	 SEMI-EJE	40	55	9		G1LG-BI				
R321710V	1	 GUÍA VÁLVULAS (12) R320710V/1	5	4	17	22.6	RGV	Ka 2016/... Fiesta 2016/...	997cc. 999cc.	Ti-VCT Eco Boost 12V Eco Boost (DOHC) 12V	321700-R MLS 325100-R MLS























CATALOGO DE RETENES

CATALOGO DE RETENTORES - OIL SEAL CATALOG

FORD

Código Code	Cant. Qty	Descripción Descrição Descrição	DE [mm]	DA [mm]	H [mm]	A [mm]		Aplicación Aplicação Aplicacion	Cm³ Cm³	Motor Motor Engine	Jgo. Juntas Set Gaskets
PR321711V	1	 PORTA BANCADA	80				PORTA	Ka 2016/... Fiesta 2016/...	997cc. 999cc.	Ti-VCT Eco Boost 12V Eco Boost (DOHC) 12V	321700-R MLS 325100-R MLS
R310800	1	 KIT DE RETENES					KIT	Ka 1997/99, Fiesta 1996/99 Fiesta 1988/95	999cc.	OHV (HCS) Endura	311000-R
R310810P R310810V R310810VM/1 R310810VM/2	1	 GUÍA VÁLVULAS (8) GUÍA VÁLVULAS (8) A GRANEL (200) A GRANEL (200)	7	10.9	9.5		RGV				
R300611P R300611V R300611N	1	 BANCADA	79.38	95.25	11.11		GAHI				
R310812P	1	 DISTRIBUCIÓN	36.51	52.48	8		GALGHD				
R340110V R340110VM/2 R340110VM/3	1	 GUÍA VÁLVULAS (12) A GRANEL (80) A GRANEL (480)	6	11.13	18	27	RGV	Fiesta, Ka 1999/...	999cc.	Zetec Rocam ZL (SOHC) 8V	340100-R
R340111V	1	 BANCADA	79.3	93	9						
PR340111T PR340111V PR340111VF	1	 PORTA BANCADA	79.3				PORTA				
R340112V R340112V/1	1	 DISTRIBUCIÓN	39.95	62	7.4		GALGHD				
R340115V R340115P R340115P/1	1	 BOMBA DE ACEITE	40	62	7.4		GALGHD				
R310800	1	 KIT DE RETENES					KIT	Fiesta 1988/95 Courier 1991/... (cárter de aluminio) Fiesta, Ka (cárter de acero) Escort, Fiesta, Courier, Ka 1995/... (cárter de aluminio)	1297cc.	OHV (HCS) Endura (SOHC) 8V	310800-R
R310810P R310810V R310810VM/1 R310810VM/2	1	 GUÍA VÁLVULAS (8) GUÍA VÁLVULAS (8) A GRANEL (200) A GRANEL (200)	7	10.9	9.5		RGV		1299cc.		
R300611P R300611V R300611N	1	 BANCADA	79.38	95.25	11.11		GAHI				
R310812P	1	 DISTRIBUCIÓN	36.51	52.48	8		GALGHD				
R310810P R310810V R310810VM/1 R310810VM/2	1	 GUÍA VÁLVULAS (8) GUÍA VÁLVULAS (8) A GRANEL (200) A GRANEL (200)	7	10.9	9.5		RGV	Corcel 1971/77 Corcel II 1978/83 Belina, Coupe GT 1.4 BR	1300cc.	CHT	320600-R
R300711P	1	 BANCADA	82	105	12		GALGHI		1400cc.	CHT	
R550412N R550412P R550412P/1 R550412V	1	 DISTRIBUCIÓN	35	50	9		GALGHD				
R320910V	1	 GUÍA VÁLVULAS (16) R320910V/1	6	10.8	15.9		RGV	Fiesta SE, Courier Puma 1996/... Fiesta VI 2008/... B-Max 2012/... Fusion 2002/... - 2010/...	1388cc.	Zetec SE 16V	320900-R
PR320911T	1	 PORTA BANCADA	80				PORTA		1388cc.	FXJA/FXJB/FXJC RTJA/RTJB - RTJC SPJA/SPJC - SPJD (DOHC) 16V	321400-R MLS
R320912V	1	 DISTRIBUCIÓN	33	47	5		GALGHD				
R320913V	2	 ÁRBOL DE LEVAS	38	52	6		GALGHD				





















FORD

Código Code	Cant. Qty	Descripción Descrição Descrição	DE [mm]	DA [mm]	H [mm]	A [mm]		Aplicación Aplicação Aplicacion	Cm³ Cm³	Motor Motor Engine	Jgo. Juntas Set Gaskets
R301010V	1	 GUÍA VÁLVULAS (8) R301010V/1	8	14.08	16.05		RGV	Escort 1986/98 Orion 1986/94	1392cc.	HL14G/CFI/EFI (OHV) 8V	301000
R300612P R300612V R300612N	1	 DISTRIBUCIÓN	42	56	7		GAHD				
R302110V	1	 GUÍA VÁLVULAS (8) R302110V/1	6	9	17.5	23	RGV				
R560111P R560111V	1	 BANCADA	85	105	8		GALGRI	Fiesta, Eco Sport TD 2003/... Duratorq TDCI	1398cc.	F6JA - F6JB (SOHC) 8V DIESEL	302101-R
R270713P R270713P/1 R270713V	1	 DISTRIBUCIÓN	40	55	7		G1ALGHD				
R470813V	1	 ÁRBOL DE LEVAS	27	47	7		GALGHD				
R320910V	1	 GUÍA VÁLVULAS (16) R320910V/1	6	10.8	15.9		RGV				
PR320911T	1	 PORTA BANCADA	80				PORTA	Ka 2016/... Fiesta, Fusión 2003/... Focus 2004/..., C-Max 2007/...	1499cc. 1596cc.	Sigma L4 Sigma HWDA/HWDB - FYJA	321600-R MLS 321600-R MLS
R320912V	1	 DISTRIBUCIÓN	33	47	5		GALGHD				
R320913V	2	 ÁRBOL DE LEVAS	38	52	6		GALGHD				
R320910V	1	 GUÍA VÁLVULAS (16)	6	10.8	15.9		RGV				
PR320911T	1	 PORTA BANCADA	80				PORTA	Ka 2016/ Fiesta 2010, Focus 2013	1499cc. 1596cc.	Sigma Sigma (DOHC) 16V	324600-R MLS 324600-R MLS
R320912V	1	 DISTRIBUCIÓN	33	47	5		GALGHD				
R320913V	2	 ÁRBOL DE LEVAS	38	52	6		GALGHD				
R300700	1	 KIT DE RETENES					KIT				
R310810P R310810V R310810VM/1 R310810VM/2	1	 GUÍA VÁLVULAS (8) GUÍA VÁLVULAS (8) A GRANEL (200) A GRANEL (200)	7	10.9	9.5		RGV				
R300711P	1	 BANCADA	82	105	12		GALGHI				
R470013P R470013P/1 R470013V	1	 ÁRBOL DE LEVAS	35	50	7		GALG-BI				
R300748N	1	 SELECTOR CAJA DE VELOCIDAD	15.5	28	6/15		ESP				
R300749N	1	 EJE PILOTO	17	28	7/10		GALGHD				
R300751P	1	 CAJA DE VELOCIDAD	21.5	40	7		GAHD				
R300755N	1	 RUEDA TRASERA	38	58	7		GA-BI				
R300759N	1	 RUEDA DELANTERA INTERNA	55	70	6/10		ESP				























CATALOGO DE RETENES

CATALOGO DE RETENTORES - OIL SEAL CATALOG

FORD

Código Code	Cant. Qty	Descripción Descrição Descrição	DE [mm]	DA [mm]	H [mm]	A [mm]		Aplicación Aplicação Aplicacion	Cm³ Cm³	Motor Motor Engine	Jgo. Juntas Set Gaskets
R310810P R310810V R310810VM/1 R310810VM/2	1	 GUÍA VÁLVULAS (8) GUÍA VÁLVULAS (8) A GRANEL (200) A GRANEL (200)	7	10.9	9.5		RGV	Corcel II 1979/83, Belina II Pampa 1982/83 Del Rey 1981/83 Scala 1983/...	1555cc.	CHT	310600-R 310600
R300711P	1	 BANCADA	82	105	12		GALGHI				
R550412N R550412P R550412P/1 R550412V	1	 DISTRIBUCIÓN	35	50	9		GALGHD				
R310658N	1	 RUEDA DELANTERA	46	65.5	7/8.5		G1LG-BI				
R471310V	1	 GUÍA VÁLVULAS (16) R471310V/1	5.5	9.5	13.8	18.1	RGV	Focus C-Max TDCI 2003/... Fusion TDCI 2004/...	1560cc.	G8DA - Duratorq (DOHC) 16V DIESEL	471301-R
R560111P R560111V	1	 BANCADA	85	105	8		GALGRI				
R270713P R270713P/1 R270713V	1	 DISTRIBUCIÓN	40	55	7		G1ALGHD				
R470813V	1	 ÁRBOL DE LEVAS	27	47	7		GALGHD				
R301110P	1	 GUÍA VÁLVULAS (8) R322410P/1 (8)	7	11.6	8.8		RGV	Fiesta i, Orion i 1989/92 Escort, Escort XR3 1980/85 Fiesta XR2 1984/85 Escort, Orion, Escort XR3i 1985/90	1597cc.	CHV (HL16CFI) CVH (H16G/MFI) CVH (HL16H) CVH (HL16I) CVH (HL16G/H) (OHV) 8V	301100-R
R320311V	1	 BANCADA	88	108	10		GALGRI				
R300312N R300312P	1	 DISTRIBUCIÓN	43.41	56.02	9.3		ESP G1LGHD				
R470013P R470013P/1 R470013V	1	 ÁRBOL DE LEVAS	35	50	7		GALG-BI				
R300610P R300610V	1	 GUÍA VÁLVULAS (8) R430010V/1	8	12	9.5	15.2	RGV	Sierra 1.6L 1984/...	1597cc.	OHC	300600-R
R300611P R300611V	1	 BANCADA	79.38	95.25	11.11		GAHI				
R300612P R300612V R300612N	3	 DISTRIBUCIÓN	42	56	7		GAHD				
R320300	1	 KIT DE RETENES					KIT	Mondeo 1993/... Escort, Orion 1992/... Fiesta 1994/95	1597cc. 1597cc.	ZETEC (DOHC) 16V ZETEC (DOHC) 16V	301200-R 301400-R
R320310V R320310VM/2 R320310VM/3	1	 GUÍA VÁLVULAS (16) A GRANEL (80) A GRANEL (480)	6	11.75	20.7	24	RGV				
R320311V	1	 BANCADA	88	108	10		GALGRI				
R470013P R470013P/1 R470013V	1	 DISTRIBUCIÓN	35	50	7		GALG-BI				
R320313P R320313V	2	 ÁRBOL DE LEVAS	42	53	7		GALGHD				
R340110V R340110VM/2 R340110VM/3	1	 GUÍA VÁLVULAS (8) A GRANEL (80) A GRANEL (480)	6	11.13	18	27	RGV	Ka 1997/..., Fiesta 1999/... Escort, Eco Sport, Focus Courier 2003/...	1598cc.	Zetec Rocam ZL (SOHC) 8V	340200-R





















FORD

Código Code	Cant. Qty	Descripción Descrição Descrição	DE [mm]	DA [mm]	H [mm]	A [mm]		Aplicación Aplicação Application	Cm³ Cm³	Motor Motor Engine	Jgo. Juntas Set Gaskets			
R340210V	1	 GUÍA VÁLVULAS (8) R340210V/1	6	11.13	18		RGV	Ka 1997/..., Fiesta 1999/... Escort, Eco Sport, Focus Courier 2003/...	1598cc.	Zetec Rocam ZL (SOHC) 8V	340200-R			
R340111V	1	 BANCADA	79.3	93	9									
PR340111T PR340111V PR340111VF	1	 PORTA BANCADA	79.3			PORTA								
R340112V R340112V/1	1	 DISTRIBUCIÓN	39.95	62	7.4	GALGHD								
R340115V R340115P R340115P/1	1	 BOMBA DE ACEITE	40	62	7.4	GALGHD								
R320000	1	 KIT DE RETENES					KIT	Pick Up, Sierra TD 1988/91 Escort, Fiesta, Orion D 1989/92 Courier, Fiesta, Orion, Pick Up, Sierra, Escort TD Orion, Mondeo TD 1992/94	1753cc.	D1.8T/TI - D18NA DIESEL	320001-R			
R320010V	1	 GUÍA VÁLVULAS (8) R320010V/1	8	12	12	RGV								
R300611P R300611V	1	 BANCADA	79.38	95.25	11.11	GAHI								
PR320011V	1	 PORTA BANCADA	79		16	PORTA								
R320012P R320012V	1	 DISTRIBUCIÓN	66.67	89.3	10	GALGRD								
R320013P R320013V	1	 ÁRBOL DE LEVAS	28	38	7	GALGHD								
PR320015V	1	 PORTA AUXILIAR	40			PORTA								
R320055N	1	 RUEDA TRASERA	40	55	6.5	G1SRLG								
R320010V	1	 GUÍA VÁLVULAS (8) R320010V/1	8	12	12	RGV	Focus TD di 1998/... Fiesta TD di 2000/... Focus TD ci 2001/... Focus di 1999/...					1753cc.	Lynx (C9DC) Duratorq - BHDA/BHDB (SOHC) 8V- DIESEL	340301-R
PR320011V	1	 PORTA BANCADA	79			PORTA								
R340312V	1	 DISTRIBUCIÓN	30	50	7.5	GALGRD								
R320013P R320013V	1	 ÁRBOL DE LEVAS	28	38	7	GALGHD								
PR340314P	1	 PORTA BOMBA INYECTORA	80			PORTA								
R220400	1	 KIT DE RETENES						Del Rey, Belina 1989/91 Escort, Scala, Pampa 1989/... Verona 1990/96, Royale Versailles 1991/96	1781cc.	AP (SOHC) 8V	220600-R			
R220410V	1	 GUÍA VÁLVULAS (8) R250410V/1	8	10.8	10	RGV								
R220411P R220411P/1 R220411V R220411VF	1	 BANCADA	85	105	12	GALGRI								
R230113P R230113P/1 R230113V	3	 ÁRBOL DE LEVAS Y DISTRIBUCIÓN	32	47	10	GALG-BI								
R220649P	1	 EJE PILOTO	20	35	7/10.5	GAHD								























CATALOGO DE RETENES

CATALOGO DE RETENTORES - OIL SEAL CATALOG

FORD

Código Code	Cant. Qty	Descripción Descrição Descrição	DE [mm]	DA [mm]	H [mm]	A [mm]		Aplicación Aplicação Application	Cm³ Cm³	Motor Motor Engine	Jgo. Juntas Set Gaskets
R320310V R320310VM/2 R320310VM/3	1	 GUÍA VÁLVULAS (16) A GRANEL (80) A GRANEL (480)	6	11.75	20.7	24	RGV	Focus 1998/...	1796cc.	ZETEC E EYDB/C/D/E/F/G/H/J/L	301500-R
R320311V	1	 BANCADA	88	108	10	GALGRI					
R550412N R550412P R550412P/1 R550412V	1	 DISTRIBUCIÓN	35	50	9	GALGHD					
R320313P R320313V	2	 ÁRBOL DE LEVAS	42	53	7	GALGHD					
R320300	1	 KIT DE RETENES				KIT					
R320310V R320310VM/2 R320310VM/3	1	 GUÍA VÁLVULAS (16) A GRANEL (80) A GRANEL (480)	6	11.75	20.7	24	RGV	Escort, Orion, Fiesta XR2 Fiesta, Escort RX3i 1992/... Mondeo 1993/...	1796cc.	ZETEC-E SFI EYDB/C/D/E/F/G/H/J/L ZETEC	303300-R
R320311V	1	 BANCADA	88	108	10	GALGRI					
R470013P R470013P/1 R470013V	1	 DISTRIBUCIÓN	35	50	7	GALG-BI					
R320313P R320313V	2	 ÁRBOL DE LEVAS	42	53	7	GALGHD					
R322210P	1	 GUÍA VÁLVULAS (8) R322210P/1	8	12.5	12	RGV	Courier 1972/82 Courier 1972/82	1800cc. 1900cc.		110 121	322200-RMX
R970311P R970311S	1	 BANCADA	80	105	13	GALGHI					
R900012P R900012N	1	 DISTRIBUCIÓN	48	70	9	GALGHD					
R220400	1	 KIT DE RETENES					JUEGO	Galaxy, Versailles, Verona, Escort 1992/96	1894cc.	Audi 827	230001-R
R220410V	1	 GUÍA VÁLVULAS (8) R250410V/1	8	10.8	10	RGV					
R220411P R220411P/1 R220411V R220411VF	1	 BANCADA	85	105	12	GALGRI					
R230113P R230113P/1 R230113V	3	 ÁRBOL DE LEVAS Y DISTRIBUCIÓN	32	47	10	GALG-BI					
R220400	1	 KIT DE RETENES						Galaxy TDI 1995/... - 1997/...	1896cc.	VW19N (1Z/AHU) VW19P (AFN) (SOHC) 8V DIESEL	230901-R
R220410V	1	 GUÍA VÁLVULAS (8) R250410V/1	8	10.8	10	RGV					
PR230211T PR230211V PR2302141VF	1	 PORTA BANCADA	85				PORTA				
R220411P R220411P/1 R220411V R220411VF	1	 BANCADA	85	105	12	GALGRI					
R230113P R230113P/1 R230113V	3	 ÁRBOL DE LEVAS Y DISTRIBUCIÓN	32	47	10	GALG-BI					





















FORD

Código Code	Cant. Qty	Descripción Descrição Descrição	DE [mm]	DA [mm]	H [mm]	A [mm]		Aplicación Aplicação Application	Cm³ Cm³	Motor Motor Engine	Jgo. Juntas Set Gaskets
R230210P R230210V	1	 GUÍA VÁLVULAS (8) R260610V/1	7	9.8	10		RGV	Galaxy TDI 2000/...	1896cc.	AUY (SOHC) 8V DIESEL	223501-R
PR230211T PR230211V PR230211VF	1	 PORTA BANCADA	85				PORTA				
R240013P R240013P/1 R240013V	1	 DISTRIBUCIÓN	35	48	7		GALGHD				
R230113P R230113P/1 R230113V	1	 ÁRBOL DE LEVAS	32	47	10		GALG-BI				
R320300	1	 KIT DE RETENES					JUEGO	Focus, Cougar 1999/02 Maverich 2000/...	1989cc.	YF - EDDB/EDBB EDBC/EDBD	302900-R
R320310V R320310VM/2 R320310VM/3	1	 GUÍA VÁLVULAS (16) A GRANEL (80) A GRANEL (480)	6	11.75	20.7	24	RGV	Escort Mondeo 1993/01 Contour 1994/...	1989cc. 1989cc. 1989cc.	ZETEC ZETEC ZETEC (DOHC) 16V	320500-R 321500-R 340800-R
R320311V	1	 BANCADA	88	108	10		GALGRI				
R470013P R470013P/1 R470013V	1	 DISTRIBUCIÓN	35	50	7		GALG-BI				
R320313P R320313V	2	 ÁRBOL DE LEVAS	42	53	7		GALGHD				
R300300	1	 KIT DE RETENES					JUEGO	Taurus L, GXL, Ghia 1974/...	1990cc.	OHC (SOHC) 8V	300300-R
R300310P R300310PN/1	1	 GUÍA VÁLVULAS (8) A GRANEL (200)	7.9	15.5	12.5		RGV				
R300311P	1	 BANCADA	92	108	9.8		GAHI				
R300411P R300411N	1	 BANCADA	91.5	106.5	5.5		ESP-GARI				
R300312N R300312P	3	 DISTRIBUCIÓN	43.41	56.02	9.3		ESP G1LGHD				
R300347N	1	 VELOCÍMETRO	7.9	16	6		GA				
R300350N	1	 CAJA DE VELOCIDAD	35	49.7	12.7		G1LGHI				
R300351N	1	 CAJA DE VELOCIDAD	28	40	8		GALGHD				
R300358N	1	 RUEDA DELANTERA	40	55	8		GALG				
R300310P R300310PN/1	1	 GUÍA VÁLVULAS (8) A GRANEL (200)	7.9	15.5	12.5		RGV	Ranger, Pinto, Taurus, Sierra Capri, Granada 1974/86	1993cc.	L4 122 (SOHC) 8V	303600-R
R300312N R300312P	3	 DISTRIBUCIÓN	43.41	56.02	9.3		ESP G1LGHD				
R302010V	1	 GUÍA VÁLVULAS (16) R302010V/1	7	12	18.8	24.2	RGV	Mondeo TDCI 2000/02 - 02/... Mondeo III DI 2002/02 Transit TDI-TDCI 2000/02 - 2002/... Transit DI 2000/02	1998cc.	HJBA/B/C - F3FA - F1FA - ABFA D3FA - D5BA - D6BA (DOHC) Duratorq	303201-R
PR302011T	1	 PORTA BANCADA	105				PORTA				
R470013P R470013P/1 R470013V	1	 ÁRBOL DE LEVAS	35	50	7		GALG-BI				

























CATALOGO DE RETENES

CATALOGO DE RETENTORES - OIL SEAL CATALOG

FORD

Código Code	Cant. Qty	Descripción Descrição Descrição	DE [mm]	DA [mm]	H [mm]	A [mm]		Aplicación Aplicação Application	Cm³ Cm³	Motor Motor Engine	Jgo. Juntas Set Gaskets
R320300	1	 KIT DE RETENES					JUEGO	Contour 1996/98 Mystique 1994/95 Escort ZX2 1998/...	1998cc.	4L 121 P.C.D. VIN "3" ZETEC (DOHC) 16V	324300-R
R320310V R320310VM/2 R320310VM/3	1	 GUÍA VÁLVULAS (16) A GRANEL (80) A GRANEL (480)	6	11.75	20.7		RGV				
R320311V	1	 BANCADA	88	108	10		GALGRI				
R470013P R470013P/1 R470013V	1	 DISTRIBUCIÓN	35	50	7		GALG-BI				
R320313P R320313V	2	 ÁRBOL DE LEVAS	42	53	7		GALGHD				
R471410V	1	 GUÍA VÁLVULAS (16) R470810V/1	6	10	21.5	19.6	RGV	C-Max 2003/..., Focus Galaxy, S-Max 2006/... Mondeo, C-Max, Focus 2007/... Focus C-Max TDCI 2003/...	1998cc.	TDCI DURATORQ (20DD0X)	471401-R
R460211V	1	 BANCADA	90	100	7		GALGRI		1998cc.	G6DA/G6DC (DOHC) 16V DIESEL	471501-R
R460212P R460212V	1	 DISTRIBUCIÓN	42	62	7		GALG-BI				
R470813V	1	 ÁRBOL DE LEVAS	27	47	7		GALGHD				
460235	2	 BASTÓN CIERRE BANCADA									
R302210V	1	 GUÍA VÁLVULAS (16) R322210V/1	5.5	11	18	25	RGV	Mondeo, Ranger 2001/..., Eco Sport 2003/..., Focus Focus 2011... Mondeo 2013/... Ranger 2001/04, Fusion	1999cc.	CJBA - Duratec HE/EFI	302200-R 302400-R 303400-R MLS
PR302211T	1	 PORTA BANCADA	88				PORTA		1999cc.	MGDA Duratec	
R302212V	1	 DISTRIBUCIÓN	37	50	8		GALGHD		2261cc.	Duratec (DOHC) 16V	302200-R 302400-R
R322210P	1	 GUÍA VÁLVULAS (8) R302210V/1	8	12.5	12		RGV	Courier 1972/82	2000cc.	123	322200-RMX
R970311P R970311S	1	 BANCADA	80	105	13		GALGHI				
R900012P R900012N	1	 DISTRIBUCIÓN	48	70	9		GALGHD				
R302010V	1	 GUÍA VÁLVULAS (8) R302010V/1	7	12	18.8	24.2	RGV	Ranger XL 4X2 / 4X4 Transit TDCi 2006/...	2198cc.	Puma TDCi (DOHC) 16V DIESEL	324801-R
PR302011T	1	 PORTA BANCADA	105				PORTA				
R470013P R470013P/1 R470013V	1	 ÁRBOL DE LEVAS	35	50	7		GALG-BI				
R340610P	1	 GUÍA VÁLVULAS (8) R340610P/1	7.2	12.4	14.5		RGV	Mustang, Ranger 1993/94 Ranger 1995/97, Pick Up 1989/...	2298cc.	F140L (SOHC)	340600-R
R300311P	1	 BANCADA	92	108	9.8		GAHI				
R300312N R300312P	3	 DISTRIBUCIÓN	43.41	56.02	9.3		ESP G1LGHD				
R300400	1	 KIT DE RETENES					KIT	Taurus, Sierra, XR4 Falcon 1974/..., GXL/GT SP/Ghia, Maverick 1975/79 Mustang 1980/...	2299cc.	OHC	300400-R
R300310P R300310PN/1	1	 GUÍA VÁLVULAS (8) A GRANEL (200)	7.9	15.5	12.5		RGV				

FORD

Código Code	Cant. Qty	Descripción Descrição Descrição	DE [mm]	DA [mm]	H [mm]	A [mm]		Aplicación Aplicação Application	Cm³ Cm³	Motor Motor Engine	Jgo. Juntas Set Gaskets
R300311P	1	 BANCADA	92	108	9.8		GAHI	Taunus, Sierra, XR4 Falcon 1974/..., GXL/GT SP/Ghia, Maverick 1975/79 Mustang 1980/...	2299cc.	OHC	300400-R
R300411P R300411N	1	 REFORMA BANCADA	91.5	106.5	9.5		ESP-GARI				
R300312N R300312P	3	 DISTRIBUCIÓN	43.41	56.02	9.3		ESP G1LGHD				
R300455N	1	 RUEDA DELANTERA Y TRASERA	50	65	9		ESP-G1				
R301810P	1	 GUÍA VÁLVULAS (8) R242110P/1	7.5	14	12.5		RGV	Ghia 1991/..., Topaz 1989/94 Topaz, GS/GLX 1984/88	2300cc. 2300cc.	140 F.I 140 Carburado	301700-RMX 301800-RMX
R320311V	1	 BANCADA	88	108	10		GALGRI				
R300310P R300310PN/1	1	 GUÍA VÁLVULAS (8) A GRANDEL (200)	7.9	15.5	12.5		RGV				
R300312N R300312P	3	 DISTRIBUCIÓN	43.41	56.02	9.3		ESP G1LGHD	Ranger, Pinto, Taunus, Sierra Capri, Granada 1974/86	2302cc.	L4 140 (SOHC) 8V	303600-R
R520811P	1	 BANCADA	80	96	9		GALGRI				
R950312P R950312S	1	 DISTRIBUCIÓN	44	60	7		GALGHD	Bronco II TD Ranger 2WD 1985/...	2346cc.	4D55T (SOHC) 8V DIESEL	910500-R
R470013P R470013P/1 R470013V	1	 ÁRBOL DE LEVAS	35	50	7		GALG-BI				
R250156N	1	 AUXILIAR	25	35	7		GA				
R302010V	1	 GUÍA VÁLVULAS (8) R302010V/1	7	12	18.8	24.2	RGV	Transit TD 2000/... Transit TD 2009/11	2402cc.	Duratorq (DOHC) 16V DIESEL	302001-R
PR302011T	1	 PORTA BANCADA	105				PORTA				
R470013P R470013P/1 R470013V	1	 ÁRBOL DE LEVAS	35	50	7		GALG-BI				
R302510V	1	 GUÍA VÁLVULAS (24) R302510V/1	6	12.4	18.7	25.3	RGV	Mystique, Contour 1995/00 Mondeo 1994/00 Mondeo III 2000/...	2475cc. 2495cc.	Duratec - LCB (DOHC) V6 24V	302500-R
R300311P	1	 BANCADA	92	108	9.8		GAHI				
R340712P	1	 DISTRIBUCIÓN	47	63.40	8.8		GALGHD				
R302510V	1	 GUÍA VÁLVULAS (24) R302510V/1	6	12.4	18.7	25.3	RGV	Mondeo III 2002/...	2495cc.	AJ25 - LDBE (DOHC) V6 24V	303500-R
R302511V	1	 BANCADA	92	107.58	9.5		G1ARI				
R340712P	1	 DISTRIBUCIÓN	47	63.40	8.8		GALGHD				
R302210V	1	 GUÍA VÁLVULAS (16) R322210V/1	5.5	11	18	25	RGV				
PR302211T	1	 PORTA BANCADA	88				PORTA	Ranger 2011/...	2495cc.	GBVAF/GBVAL/GBVAK (DOHC) 16V	303800-R MLS
R302212V	1	 DISTRIBUCIÓN	37	50	8		GALGHD				























CATALOGO DE RETENES

CATALOGO DE RETENTORES - OIL SEAL CATALOG

FORD

Código Code	Cant. Qty	Descripción Descrição Descrição	DE [mm]	DA [mm]	H [mm]	A [mm]		Aplicación Aplicação Application	Cm³ Cm³	Motor Motor Engine	Jgo. Juntas Set Gaskets
R330310P	1	 GUÍA VÁLVULAS (8) R330310P/1	8	15.45	23.2	29	RGV	Transit, Transit D/DI 1985/99	2496cc.	4EB/BC/CA/FB 4HC/EA (SOHC) 8V DIESEL	330300-R
R330311V	1	 BANCADA	79.3	99	9.8		GALGHI				
R330312V	1	 DISTRIBUCIÓN	66.67	85.7	10		GALGRD				
R330313V	1	 ÁRBOL DE LEVAS	47.6	66.7	11.3		GALGRD				
R500411P	1	 BANCADA	90	120	12		G1ALGHI	Scorpio TDI, Granada TDI 1993/94, Falcon 1988/...	2499cc.	SCB (OHV) 8V DIESEL	500401
R500412P	1	 DISTRIBUCIÓN	56	80	10		GAHD				
R520310P	1	 GUÍA VÁLVULAS (8) R520310V/1	7	11.4	9.8		RGV	Scorpio TDI SCC/SCD 1994/98	2499cc.	SCC/SCD DIESEL	520301-R
R310411P R310411V	1	 BANCADA	110	130	13		GALGHI				
R520312V	1	 DISTRIBUCIÓN	52	68	9.5		GALGHD				
R340610P	1	 GUÍA VÁLVULAS (8) R340610P/1	7.2	12.4	14.5		RGV	Pick Up, Ranger 1997/...	2500cc.	EFI - NA14 (SOHC)	302300-R
R300611P R300611V	1	 BANCADA	79.38	95.25	11.11		GAHI				
R300312N R300312P	2	 DISTRIBUCIÓN	43.41	56.02	9.3		ESP G1LGHD				
R430010V R430010VM/1 R430010VM/2	1	 GUÍA VÁLVULAS (8) A GRANEL (200) A GRANEL (200)	8	12	9.5	15.2	RGV	Ranger TDI 1995/... Ranger TD BR 2000-2002/....	2507cc. 2758cc.	200-300 TDI Power Stroke DIESEL	430001-R 430001-R (430600)
PR430011V PR430011VF	1	 PORTA BANCADA	99.45				PORTA				
R430012V	1	 DISTRIBUCIÓN	57	71	9		GALGRD				
R430013V	1	 ÁRBOL DE LEVAS	46.7	62	9		GALGHD				
R430015N	1	 GUARDAPOLVO CORREA DISTRIB.	57.5	74	8		GASRLG				
430058	2	 EMPAQUETADURA CIGÜEÑAL									
R324711V	1	 BANCADA	98	110	9.5			Focus, C-Max, S-Max, Mondeo Kuga 2005/... - 2007/...	2522cc.	Duratec (25KDDTD) Duratec-VCT (25KDDTD) (DOHC) 20V	324700-R MLS
R324713V	1	 ÁRBOL DE LEVAS	51	65	7						
R302510V	1	 GUÍA VÁLVULAS (24) R302510V/1	6	12.4	18.7	25.3	RGV	Mondeo II 1994/00	2544cc.	Duratec SEA (DOHC) 24V	303000-R
R302511V	1	 BANCADA	92	107.58	9.5		G1ARI				
R340712P	1	 DISTRIBUCIÓN	47	63.40	8.8		GALGHD				
R300900	1	 KIT DE RETENES					JUEGO	Falcon 4B, STD, De Luxe Futura, Rural 1962/68	2798cc.	170 4B	300900-R
R300010P R300010PN/1	1	 GUÍA VÁLVULAS (12) A GRANEL (144)	7.9	15.5	12.5		RGV				

























FORD

Código Code	Cant. Qty	Descripción Descrição Descripción	DE [mm]	DA [mm]	H [mm]	A [mm]		Aplicación Aplicação Application	Cm³ Cm³	Motor Motor Engine	Jgo. Juntas Set Gaskets
R300010-1P	1	 GUÍA VÁLVULAS (12) R300010-1P/1	7	19.5	17.5		RGV	Falcon 4B, STD, De Luxe Futura, Rural 1962/68	2798cc.	170 4B	300900-R
R300911N R300911P R300911S	1	 BANCADA	85.7	100	5.5		E-GARI				
R300911-1S	1	 REFORMA BANCADA	86	100	5.5		EXPAN				
R300012N R300012P	1	 DISTRIBUCIÓN	44.45	60.3	11.11		G1AHD				
300058	1	 EMPAQUETADURA BANCADA (2)					JUEGO				
R230710V	1	 GUÍA VÁLVULAS (12) R260610V/1	7	9.8	10		RGV	Galaxy 1995/00	2792cc.	VV28 (DOHC) V6 12V	230700-R
R220411P R220411P/1 R220411V R220411VF	1	 BANCADA	85	105	12		GALGRI				
R240013P R240013P/1 R240013V	1	 DISTRIBUCIÓN	35	48	7		GALGHD				
R322410P	1	 GUÍA VÁLVULAS (12) R322410P/1	7	11.6	8.8		RGV				
R320111V	1	 BANCADA	60.45	76.18	10		GALGHI				
R300612P R300612V R300612N	1	 DISTRIBUCIÓN	42	56	7		GAHD				
R430810V	1	 GUÍA VÁLVULAS (16) R430810V/1	6	12	20	24.5	RGV				
PR430011V PR430011VF	1	 PORTA BANCADA	99.45				PORTA				
R400012N R400012P R400012V	1	 DISTRIBUCIÓN	60.32	79.36	9.5		GALGHD				
R310910P	1	 GUÍA VÁLVULAS (12) R430010V/1	8	12	9.5	15.1	RGV				
R320111V	1	 BANCADA	60.45	76.18	10		GALGHI				
R300612P R300612V R300612N	1	 DISTRIBUCIÓN	42	56	7		GAHD				
R302510V	1	 GUÍA VÁLVULAS (24) R302510V/1	6	12.4	18.7	25.3	RGV				
R300311P	1	 BANCADA	92	108	9.8		GAHI				
R340712P	1	 DISTRIBUCIÓN	47	63.4	8.8		GALGHD				
R302510V	1	 GUÍA VÁLVULAS (24) R302510V/1	6	12.4	18.7	25.3	RGV				
R302511V	1	 BANCADA	92	107.58	9.5		G1ARI				
R340712P	1	 DISTRIBUCIÓN	47	63.4	8.8		GALGHD				

























CATALOGO DE RETENES

CATALOGO DE RETENTORES - OIL SEAL CATALOG

FORD

Código Code	Cant. Qty	Descripción Descrição Descripción	DE [mm]	DA [mm]	H [mm]	A [mm]		Aplicación Aplicação Application	Cm³ Cm³	Motor Motor Engine	Jgo. Juntas Set Gaskets
R300311P	1	 BANCADA	92	108	9.8		GAHI	Ranger 1996/01	2968cc.	Vulcan (OHV) V6 12V	323700-R
R340512V	1	 DISTRIBUCIÓN	47.62	65.07	7.95		G1LGH				
R300000	1	 KIT DE RETENES					JUEGO	Falcon, F100, Fairlane 1969/... Falcon, F100, Fairlane 1969/... Falcon, F100, Fairlane 1969/...	3052cc. 3075cc. 3618cc.	187 - 7B (OHV) 12V 188 - 7B (OHV) 12V 221 - 7B (OHV) 12V	300000-R
R300010P R300010PN/1	1	 GUÍA VÁLVULAS (12) A GRANEL (144)	7.9	15.5	12.5		RGV				
R300010-1P	1	 GUÍA VÁLVULAS (12) R300010-1P/1	7	19.5	17.5		RGV				
R300011P	1	 BANCADA	85.7	102.62	9.73		GAHI				
R300911N R300911P R300911S	1	 BANCADA	85.7	100	5.5		E-GARI				
R300012N R300012P	1	 DISTRIBUCIÓN	44.45	60.3	11.11		G1AHD				
R300048N	1	 SELECTOR CAJA DE VELOCIDAD	15.7	23.81	4.76		GASR				
R300050N	1	 CAJA DE VELOCIDAD	38.1	60.3	12.5/19		ESP-RI				
R300051N	1	 CAJA DE VELOCIDAD	28.58	41.2	6.2		G1HD				
R300057N	1	 DIFERENCIAL (PIÑÓN)	39.68	80.29	7/16		ESP-RD				
300058	1	 EMPAQUETADURA BANCADA (2)					JUEGO				
R300900	1	 KIT DE RETENES					JUEGO	Falcon 4B, STD, De Luxe Futura, Rural 1962/68	3052cc.	187 4B	300900-R
R300010P R300010PN/1	1	 GUÍA VÁLVULAS (12) A GRANEL (144)	7.9	15.5	12.5		RGV				
R300010-1P	1	 GUÍA VÁLVULAS (12) R300010-1P/1	7	19.5	17.5		RGV				
R300911N R300911P R300911S	1	 BANCADA	85.7	100	5.5		E-GARI				
R300911-1S	1	 REFORMA BANCADA	86	100	5.5		EXPAN				
R300012N R300012P	1	 DISTRIBUCIÓN	44.45	60.3	11.11		G1AHD				
300058	1	 EMPAQUETADURA BANCADA (2)					JUEGO				
R324910V	1	 GUÍA VÁLVULAS (20) R302010V/1	7	12	18.8	24.2	RGV	Ranger XLS/XLT 4x2 4x4 TDCi 2013/...	3198cc.	Puma TDCi i5 eTGV (DOHC) 20V DIESEL	324901-R
PR302011T	1	 PORTA BANCADA	105				PORTA				
R400000	1	 KIT DE RETENES					JUEGO	F100, Falcon 1970/... F100	3336cc. 3336cc.	4.203-P4-192Z (OHV) 8V DIESEL 4.203 Potenciado (OHV) 8V DIESEL	400000-R 410000-R
R400000-1	1	 KIT DE RETENES					JUEGO				



FORD

Código Code	Cant. Qty	Descripción Descrição Descrição	DE [mm]	DA [mm]	H [mm]	A [mm]		Aplicación Aplicação Application	Cm³ Cm³	Motor Motor Engine	Jgo. Juntas Set Gaskets
R300310P R300310PN/1	1	 GUÍA VÁLVULAS (8) BLISTER (200)	7.9	15.5	12.5		RGV	F100, Falcon 1970/...	3336cc.	4.203-P4-192Z (OHV) 8V DIESEL	400000-R
R400010P R400010P/1	1	 GUÍA VÁLVULAS (8) BLISTER (200)	7.9	14	13.2		RGV	F100	3336cc.	4.203 Potenciado (OHV) 8V DIESEL	410000-R
R400211P R400211V	1	 BANCADA	133.35	158.75	11.13		GALGRI				
R400012N R400012P R400012V	1	 DISTRIBUCIÓN	60.32	79.36	9.5		GALGHD				
400158	1	 EMPAQUETADURA BANCADA (2)					JUEGO				
R300000	1	 KIT DE RETENES					KIT	Falcon SP, Sprint 1973/... Falcon, Pick Up 1989/...	3618cc. 3618cc.	221 Sprint 7B (OHV) 12V Max Econo	300100-R 310000-R 310002-R
R300010P R300010PN/1	1	 GUÍA VÁLVULAS (12) A GRANEL (144)	7.9	15.5	12.5		RGV				
R300010-1P	1	 GUÍA VÁLVULAS (12) R300010-1P/1	7	19.5	17.5		RGV				
R300011P	1	 BANCADA	85.7	102.62	9.73		GAHI				
R300911N R300911P R300911S	1	 BANCADA	85.7	100	5.5		E-GARI				
R300012N R300012P	1	 DISTRIBUCIÓN	44.45	60.3	11.11		G1AHD				
300058	1	 EMPAQUETADURA BANCADA (2)					JUEGO				
R322310P	1	 GUÍA VÁLVULAS (12) R322310P/1	8	12	13.3		RGV	Cougar Super Cargado Thunderbird 1988/93	3797cc.	232 (OHV) V6 12V	322300-RMX
R300311P	1	 BANCADA	92	108	9.8		GAHI				
R340412P	1	 DISTRIBUCIÓN	47	65	15	80	E-G1LGHD				
R322310P	1	 GUÍA VÁLVULAS (12) R322310P/1	8	12	13.3		RGV	Windstar 1995/96	3797cc.	232 (OHV) V6 12V	323200-R
R300311P	1	 BANCADA	92	108	9.8		GAHI				
R340512V	1	 DISTRIBUCIÓN	47.62	65.07	7.95		G1LGHD				
R300311P	1	 BANCADA	92	108	9.8		GAHI	Windstar 1997/98 Windstar 1998/... Windstar 1999/00 Windstar 2001/03	3797cc. 3797cc. 3797cc. 3797cc.	Essex (OHV) V6 Essex (OHV) V6 12V Essex (OHV) V6 12V Essex (OHV) V6 12V	323300-R 323900-R 324000-R 324100-R
R340412P	1	 DISTRIBUCIÓN	47	65	15	80	E-G1LGHD				
R320210P	1	 GUÍA VÁLVULAS (12) R320210P/1	8.68	12.6	16		RGV	V6 3.8 (USA) Mustang Taurus, Sable, Thunderbird Cougar 1985/87	3811cc.	232 (OHV) V6 12	301900-RMX
R300311P	1	 BANCADA	92	108	9.8		GAHI	V6 3.8 (USA) Mustang Taurus, Sable, Thunderbird Cougar	3811cc.	230 (232) V6	320200
R340412P	1	 DISTRIBUCIÓN	47	65	15	80	E-G1LGHD				
R870010P	1	 GUÍA VÁLVULAS (8) R870010P/1	8	12.7	14		RGV	F100 1998/...	3900cc.	4B - 4BT - 4BTA DIESEL	870000-R

























CATALOGO DE RETENES

CATALOGO DE RETENTORES - OIL SEAL CATALOG

FORD

Código Code	Cant. Qty	Descripción Descrição Descrição	DE [mm]	DA [mm]	H [mm]	A [mm]		Aplicación Aplicação Application	Cm³ Cm³	Motor Motor Engine	Jgo. Juntas Set Gaskets
R870011V R870011VF	1	 BANCADA	130	150	12/13		GALGRI	F100 1998/...	3900cc.	4B - 4BT - 4BTA DIESEL	870000-R
R870012V R870012VF	1	 DISTRIBUCIÓN	63.5	79.5	9		G1ALGRD				
R800811T	1	 BANCADA	130	155	12.5/16		G1ALGRI	F100 2006/... Common Rail	3920cc.	ISBe (OHV) 16V DIESEL	870500-R 870501-R
R800812T	1	 DISTRIBUCIÓN	70	100	12.5/16		GALGHD				
R310410V	1	 GUÍA VÁLVULAS (8) R310410V/1	9	13.4	11		RGV	F100 1993/95 F1000 1994/96	3922cc.	D229-4 (SOHC) 8V DIESEL	310400-R
R310411P R310411V	1	 BANCADA	110	130	13		GALGHI				
R310412P R310412V	1	 DISTRIBUCIÓN	78	100	13		GALGHD				
R310458N	1	 RUEDA DELANTERA	58.95	76	9		G1SRLG				
R310910P	1	 GUÍA VÁLVULAS (12) R430010V/1	8	12	9.5	15.1	RGV	Explorer, Ranger Navajo 1991/..., Bronco II 1990/91	3996cc.	244 CID (SOHC) V6 12V	320100-R
R320111V	1	 BANCADA	60.45	76.18	10		GALGHI				
R300612P R300612V R300612N	1	 DISTRIBUCIÓN	42	56	7		GAHD				
R300311P	1	 BANCADA	92	108	9.8		GAHI	Econoline, F150 1997/98	4195cc.	Essex (OHV) V6 12V	324400-R
R340412P	1	 DISTRIBUCIÓN	47	65	15	80	E-G1LGHD				
R330610V	1	 GUÍA VÁLVULAS (18) R310810V/1	6	10.6	9.5		RGV	F100 GMC Turbo 1999/...	4200cc.	Sprint 6.07 TD Turbo Intercooler (SOHC) 18V DIESEL	330600-R
R330511V	1	 BANCADA	91	111	10		G1ALGRI				
R250811P R250811V R250811N	1	 DISTRIBUCIÓN	64	80	8		G1ALGHD				
R320710P	1	 GUÍA VÁLVULAS (16) R320710P/1	8.73	19.4	19.48		RGV	Galaxy 500, Fairlane, Falcon Maverich, Mustang, F150, F250, Grand Marquis 1965/84	4300cc.	260 (OHV) V8 16V	321800-RMX
R300210P	1	 GUÍA VÁLVULAS (16) R300310P/1	7.9	15.5	12.5		RGV	F100, F350, F600 Fairlane 1961/70	4458cc.	272 V8 F1	300200-R
R300212N R300212P	1	 DISTRIBUCIÓN	47.65	65.05	11.83		G1AHD				
R300255N	1	 PALIER	33.33	57.15	12.7		G2				
R300258-1N	1	 RUEDA DELANTERA	49.22	63.62	7.26		ESP				
R300258N	1	 RUEDA DELANTERA	50.8	66.6	6.5		G1SRLG				
300258	1	 EMPAQUETADURA BANCADA (2)					JUEGO				
R302510V	1	 GUÍA VÁLVULAS (24) R302510V/1	6	12.4	18.7	25.3	RGV	E-Series - F-Series Expedition, Triton1997/99 E-Series - F-Series Triton 2000/03	4600cc. 4600cc.	Triton 281 (SOHC) V8 16V Triton 281 (SOHC) V8 16V	322500-R 322600-R























FORD

Código Code	Cant. Qty	Descripción Descrição Descrição	DE [mm]	DA [mm]	H [mm]	A [mm]		Aplicación Aplicação Aplicacion	Cm³ Cm³	Motor Motor Engine	Jgo. Juntas Set Gaskets
R300311P	1	 BANCADA	92	108	9.8		GAHI	E-Series - F-Series Expedition, Triton1997/99	4600cc.	Triton 281 (SOHC) V8 16V	322500-R
R340712P	1	 DISTRIBUCIÓN	47	63.40	8.8		GALGHD	E-Series - F-Series Triton 2000/03	4600cc.	Triton 281 (SOHC) V8 16V	322600-R
R300311P	1	 BANCADA	92	108	9.8		GAHI	E-Series - Mustang Grand Marquis, Crown Victoria Pick Up F250 1997/99	4600cc.	Triton 281 (SOHC) V8 16V	302700-RMX
R340712P	1	 DISTRIBUCIÓN	47	63.40	8.8		GALGHD	E-Series - Mustang Grand Marquis, Crown Victoria Pick Up F250 1997/99	4600cc.	Triton 281 (SOHC) V8 16V	302800-RMX
R340710P	1	 GUÍA VÁLVULAS (16) R340710P/1	6.5	15.3	20.55	28	RGV	Town Car 1991/95 Grand Marquis 1993/95 LTD Crown, Victoria 1992/...	4600cc.	281 CID (SOHC) 8V	340700-RMX
R300311P	1	 BANCADA	92	108	9.8		GAHI	Cougar, Thunderbird 1994/95			
R340712P	1	 DISTRIBUCIÓN	47	63.40	8.8		GALGHD				
R300210P	1	 GUÍA VÁLVULAS (16) R300310P/1	7.9	15.5	12.5		RGV	F100, F350, F600, Fairlane 1961/70	4785cc.	292 V8 F	300200-R
R300212N R300212P	1	 DISTRIBUCIÓN	47.65	65.05	11.83		G1AHD				
R300255N	1	 PALIER	33.33	57.15	12.7		G2				
R300258-1N	1	 RUEDA DELANTERA	49.22	63.62	7.26		ESP				
R300258N	1	 RUEDA DELANTERA	50.8	66.6	6.5		G1SRLG				
300258	1	 EMPAQUETADURA BANCADA (2)					JUEGO				
R300210P	1	 GUÍA VÁLVULAS (16) R300310P/1	7.9	15.5	12.5		RGV	F100/350/600, Fairlane 1/8 LTD 500, Fase II 1969/76	4785cc.	V8 FII	300500-R
R300212N R300212P	1	 DISTRIBUCIÓN	47.65	65.05	11.83		G1AHD				
300258	1	 EMPAQUETADURA BANCADA (2)					JUEGO				
R320710P	1	 GUÍA VÁLVULAS (16) R320710V/1	8.73	19.4	19.48		RGV	Galaxy 500, Fairlane, Falcon, Maverich, Mustang, F150 F250, Grand Marquis 1965/84	4800cc.	289 (OHV) V8 16V	321800-RMX
R340910P	1	 GUÍA VÁLVULAS (12) R340910P/1	7.7	17	14.2		RGV	F100, F150 1991/...	4900cc.	300 CID Inyección (OHV) 12V	340900-R
R340911P	1	 BANCADA	95	114.5	11		GALGRI				
R300212N R300212P	1	 DISTRIBUCIÓN	47.65	65.05	11.83		G1AHD				
R340910P	1	 GUÍA VÁLVULAS (12) R340910P/1	7.7	17	14.2		RGV	Econoline, Delivery 1980/... Bronco 1980/92	4917cc.	300 CID (OHV) 12V	310200-R
R340911P	1	 BANCADA	95	114.5	11		GALGRI				
R300212N R300212P	1	 DISTRIBUCIÓN	47.65	65.05	11.83		G1AHD				
R310252N	1	 RUEDA TRASERA	47.7	73.1	12.7		ESP				
R310256N	1	 PALIER	38.1	63.55	12.7		GA				

CATALOGO DE RETENES

CATALOGO DE RETENTORES - OIL SEAL CATALOG



FORD

Código Code	Cant. Qty	Descripción Descrição Decripción	DE [mm]	DA [mm]	H [mm]	A [mm]		Aplicación Aplicação Aplicacion	Cm³ Cm³	Motor Motor Engine	Jgo. Juntas Set Gaskets
200658	1	 EMPAQUETADURA BANCADA (2)					JUEGO	Ranger 1989/... Galaxy, Maverick 1976/83	4942cc.	F302 (SOHC) V8 16V	310100
R300212N R300212P	1	 DISTRIBUCIÓN	47.65	65.05	11.83		G1AHD	Cougar, Continental, Granada Fairmont, Thunderbird F250/F350, Mustang	5000cc. 5000cc.	F302 V8 F351W (OHV) V8 16V	320700 321200-R
R340510P	1	 GUÍA VÁLVULAS (16) R242110P/1	7.5	14	12.5		RGV	Cougar, Thunderbird, F200/F350 1991/95	5000cc.	302 (OHV) V8 16V	321900-RMX
R300311P	1	 BANCADA	92	108	9.8		GAHI				
R320710P	1	 GUÍA VÁLVULAS (16) R320710P/1	8.73	19.4	19.48		RGV	Galaxy 500, Fairlane, Falcon Maverich, Mustang, F150 F250, Grand Marquis 1965/84 Grand Marquis, Galaxy, Camiones, Mustang, F250/F350/FB600 1969/84	5000cc. 5000cc.	302 (OHV) V8 16V 351 (OHV) V8 16V	321800-RMX 322100-RMX
R400110P	1	 GUÍA VÁLVULAS (12) R400110P/1	7.9	12.75	12.8		RGV	F100 1974/...	5004cc.	6PF - 305	400300-R
R540210P	1	 GUÍA VÁLVULAS (12) R300310P/1	7.9	14	13.2		RGV				
R400211P R400211V	1	 BANCADA	133.35	158.75	11/13		GALGRI				
R400012N R400012P R400012V	1	 DISTRIBUCIÓN	60.32	79.36	9.5		GALGHD				
400158	1	 EMPAQUETADURA BANCADA (2)					JUEGO				
R310310P	1	 GUÍA VÁLVULAS (12) R310310P/1	8.4	19.5	16.6		RGV	Fairlane 500, Galaxy 500 Monterey, Thunderbird Mustang 1960/71	5400cc.	390 CID V8	310300
R311110P	1	 GUÍA VÁLVULAS (8) R310310P/1	8.4	19.5	16.6		RGV	Galaxie, Mustang Torino 1964/78 V8 1964/72	5400cc. 5400cc.	330 V8 350 V8	311100-RMX 311200-R
R302510V	1	 GUÍA VÁLVULAS (24) R302510V/1	6	12.4	18.7	25.3	RGV	E-Series - F-Series Expedition, Triton1997/99 E-Series - F-Series Triton 2000/03	5408cc. 5408cc.	Triton 330 (SOHC) V8 16V Triton 330 (SOHC) V8 16V	322500-R 322600-R
R300311P	1	 BANCADA	92	108	9.8		GAHI				
R340712P	1	 DISTRIBUCIÓN	47	63.40	8.8		GALGHD				
R320710P	1	 GUÍA VÁLVULAS (16) R320710P/1	8.73	19.4	19.48		RGV	F250/F350/F600 Microbus (Chasis) 1984/91	5500cc. 5722cc.	335 (OHV) V8 16V 351 (OHV) V8 16V	322000-RMX
R340911P	1	 BANCADA	95	114.5	11		GALGRI				
R300311P	1	 BANCADA	92	108	9.8		GAHI	E-Series, F-Series Super Duty F-450 1997/99, Excursion E-Series, F-Series Super Duty F-450 2000/03, Excursion	6760cc. 6760cc.	Triton (SOHC) V10 20V Triton (SOHC) V10 20V	322700-R 322800-R
R340712P	1	 DISTRIBUCIÓN	47	63.40	8.8		GALGHD				
R320710P	1	 GUÍA VÁLVULAS (16) R320710P/1	8.73	19.4	19.48		RGV	F100/F250/F350 Econoline 250/350 1985/87	7500cc.	F460L V8	340400-R
R320712N	1	 DISTRIBUCIÓN	48	65	7.85		GALGHD				
300058	1	 EMPAQUETADURA BANCADA (2)					JUEGO				























CATALOGO DE RETENES

CATALOGO DE RETENTORES - OIL SEAL CATALOG

FORD

Código Code	Cant. Qty	Descripción Descrição Descrição	DE [mm]	DA [mm]	H [mm]	A [mm]		Aplicación Aplicação Aplicacion	Cm³ Cm³	Motor Motor Engine	Jgo. Juntas Set Gaskets
R340510P	1	 GUÍA VÁLVULAS (16) R242110P/1	7.5	14	12.5		RGV	Monterey, Torino, Cougar Continental, Mark III/IV/V 1988/94	7500cc.	460 CID V8	340500-R
R340512V	1	 DISTRIBUCIÓN	47.62	35,07	9.5		G1LGHD				

























FORD PESADO

R330011V	1	 BANCADA	122.20	140.8	12		GALGHI	Tractor 4600/4110/4140 4190/4200/4400/4410 1965/74 4610/4610H/4610SU 1981/90	3294cc.	BSD 332 - 333/H DIESEL	330000
330058	1	 EMPAQUETADURA CIGÜEÑAL (2)					JUEGO				
R870010P	1	 GUÍA VÁLVULAS (16) R870010P/1	8	12.7	14		RGV	F4000 2000/..., Cargo 915 Euro II	3900cc.	4B - 4BT - 4BTA DIESEL	870000-R
R870011V R870011VF	1	 BANCADA	130	150	12/13		GALGRI				
R870012V R870012VF	1	 DISTRIBUCIÓN	63.5	79.5	9		G1ALGRD				
R310410V	1	 GUÍA VÁLVULAS (8) R310410V/1	9	13.4	11		RGV				
R310411V	1	 BANCADA	110	130	13		GALGHI	F4000 1992/93 F2000 1980/... FB4000 1985/...	3922cc.	D229-4 (SOHC) 8V DIESEL	310400-R
R310412P R310412V	1	 DISTRIBUCIÓN	78	100	13		GALGHD				
R310458N	1	 RUEDA DELANTERA	58.95	76	9		G1SRLG				
R310410V	1	 GUÍA VÁLVULAS (8) R310410V/1	9	13.4	11		RGV	Camión F4000 1986/...	4156cc.	D226-4 (OHV) 8V DIESEL	320400-R 320400
R310411V	1	 BANCADA	110	130	13		GALGHI				
R310412P R310412V	1	 DISTRIBUCIÓN	78	100	13		GALGHD				
R330011V	1	 BANCADA	122.20	140.8	12		GALGHI				
330058	1	 EMPAQUETADURA BANCADA (2)					JUEGO	5610/5030/5110/5610/5900 6600/6700/7000/7100/7200	4196cc.	BSD 442 - 256	330100
R310410V	1	 GUÍA VÁLVULAS (8) R310410V/1	9	13.4	11		RGV				
R330411V	1	 BANCADA	130	160	12		G1ALGRI	Euro I/II/III	4300cc.	4.10 X10- 4.10T/TCA DIESEL	330400-R
R310412P R310412V	1	 DISTRIBUCIÓN	78	100	13		GALGHD				
R330011V	1	 BANCADA	122.20	140.8	12		GALGHI				
330058	1	 EMPAQUETADURA BANCADA (2)					JUEGO	6410/6610/6710/7600/7700 6810/7410/7610/7710 F2000/F4000, FB4000, Tractor 6600/6610	4385cc. 4392cc. 4393cc.	BSD 444 BSD 444T 268 DIESEL	330100
R400100	1	 KIT DE RETENES					JUEGO				
R400110P	1	 GUÍA VÁLVULAS (12) R400110P/1	7.9	12.75	12.8		RGV	F350/600	5004cc.	6.305 Cadenero (SOHC) 12V DIESEL	400100-R
R540210P	1	 GUÍA VÁLVULAS (12) R300310P/1	7.9	14	13.2		RGV				

























CATALOGO DE RETENES

CATALOGO DE RETENTORES - OIL SEAL CATALOG

FORD PESADO

Código Code	Cant. Qty	Descripción Descrição Descrição	DE [mm]	DA [mm]	H [mm]	A [mm]		Aplicación Aplicação Aplicacion	Cm³ Cm³	Motor Motor Engine	Jgo. Juntas Set Gaskets
R400012N R400012P R400012V	1	 DISTRIBUCIÓN	60.32	79.36	12.7		GALGHD	F350/600	5004cc.	6.305 Cadenero (SOHC) 12V DIESEL	400100-R
400158	1	 EMPAQUETADURA BANCADA (2)					JUEGO				
R400110P	1	 GUÍA VÁLVULAS (12) R400010P/1	7.9	12.75	12.8		RGV	F350/600 1974/... F600	5004cc. 5004cc.	6PF - 305 DIESEL 6PF - 305 Potenciado DIESEL	400300-R 410100-R
R540210P	1	 GUÍA VÁLVULAS (12) R300310P/1	7.9	14	13.2		RGV				
R400211P R400211V	1	 BANCADA	133.35	158.75	11/13		GALGRI				
R400012N R400012P R400012V	1	 DISTRIBUCIÓN	60.32	79.36	12.7		GALGHD				
400158	1	 EMPAQUETADURA BANCADA (2)					JUEGO				
R400200	1	 KIT DE RETENES					JUEGO	F600/700	5798cc.	6.354-2 (OHV) 12V DIESEL	400200-R
R400210P	1	 GUÍA VÁLVULAS (12) R400210P/1	9.1	12.3	15.1		RGV				
R400211P R400211V	1	 BANCADA	133.35	158.75	11/13		GALGRI				
R400012N R400012P R400012V	1	 DISTRIBUCIÓN	60.32	79.36	12.7		GALGHD				
R400213N	1	 DEPRESOR	22.22	34.92	6.35		GA				
R400215N	1	 AUXILIAR	22.22	35.70	9.52		ESP-RD				
400158	1	 EMPAQUETADURA BANCADA (2)					JUEGO				
R400200-1	1	 KIT DE RETENES					JUEGO	F7000 Camiónes Ford pesados y semi-pesados	5798cc.	6.354-4 (OHV) 12V DIESEL	400400-R
R400210P	1	 GUÍA VÁLVULAS (12) R400210P/1	9.1	12.3	15.1		RGV				
R400211P R400211V	1	 BANCADA	133.35	158.75	11/13		GALGRI				
R400012N R400012P R400012V	1	 DISTRIBUCIÓN	60.32	79.36	12.7		GALGHD				
R400213N	1	 DEPRESOR	22.22	34.92	6.35		GA				
R400215N	1	 AUXILIAR	22.22	35.70	9.52		ESP-RD				
R400210P	1	 GUÍA VÁLVULAS (12) R400210P/1	9.1	12.3	15.1		RGV	F600/700	5798cc.	6.354-1 (OHV) 12V DIESEL	400900-R
R400012N R400012P R400012V	1	 DISTRIBUCIÓN	60.32	79.36	12.7		GALGHD				
R400215N	1	 AUXILIAR	22.22	35.70	9.52		ESP-RD				
400158	1	 EMPAQUETADURA BANCADA (2)					JUEGO				

FORD PESADO

Código Code	Cant. Qty	Descripción Descrição Descrição	DE [mm]	DA [mm]	H [mm]	A [mm]		Aplicación Aplicação Aplicacion	Cm³ Cm³	Motor Motor Engine	Jgo. Juntas Set Gaskets
R540210P	1	 GUÍA VÁLVULAS (12) R300310P/1	7.9	14	13.2		RGV	F400/F600/F7000/F11000 F12000/F13000	5840cc.	6-358 Vehicular Agrícola- Industrial DIESEL	420000-R
R400211P R400211V	1	 BANCADA	133.35	158.75	11/13		GALGRI				
R400012N R400012P R400012V	1	 DISTRIBUCIÓN	60.32	79.36	12.7		GALGHD				
R410912N	1	 DISTRIBUCIÓN	50.9	69.8	9.5		GAHD	F600/F750/F1100/F6000 F7500/F11000	5840cc.	6-357 Vehicular Agrícola- Industrial DIESEL	410900-R
400158	1	 EMPAQUETADURA BANCADA (2)					GAHD				
R310510V	1	 GUÍA VÁLVULAS (12) R310410V/1	9	13.4	11		JUEGO	F14000/F4000 1994/96 Cargo, F12000/F14000 1985/...	5883cc.	D229-6 145HP Turbo DIESEL	310500-R
R310411P R310411V	1	 BANCADA	110	130	13		GALGHI				
R310412P R310412V	1	 DISTRIBUCIÓN	78	100	13		GALGHD				
R870110P	1	 GUÍA VÁLVULAS (12) R870010P/1	8	12.7	9.5		RGV	F14000 Turbo, F4000 1999/... Dodge Truck 359 1416 Euro I 1989/93	5900cc.	6B - 6BT - 6BTA (SOHC) 12V DIESEL	870100-R
R870011V R870011VF	1	 BANCADA	130	150	12/16		GALGRI				
R870012V R870012VF	1	 DISTRIBUCIÓN	63.5	79.5	9		G1ALGRD				
R311110P	1	 GUÍA VÁLVULAS (8) R310310P/1	8.4	19.5	16.6		RGV	Camión 1964/78	5900cc. 6400cc.	351 V8 391 V8	311100-RMX
R650110P	1	 GUÍA VÁLVULAS (12) R650110P/1	7	19	12.5		RGV	F7000 1978/81	6128cc.	F6L 913 (OHV) 12V DIESEL	650100-R
R650111P	1	 BANCADA	115	140	16		G1ALGHI				
R650112P	1	 DISTRIBUCIÓN	65	85	13		G1ALGHD				
R330710V	1	 GUÍA VÁLVULAS (12) R310410V/1	9	13.4	11		RGV	F14000 1995/98, Euro I/II	6450cc.	6.10 X10 - 6.10T/TCA DIESEL	330700-R
R330411V	1	 BANCADA	130	160	12		G1ALGRI				
R310412P R310412V	1	 DISTRIBUCIÓN	78	100	13		GALGHD				
R330011V	1	 BANCADA	122.20	140.80	12		GALGHI	7810/7910/8210/8530 1988/... 8630/8750/8830 1992/... Fase I-II - Cargo 6.6/7.8 Simples/Turbo	6572cc.	Fase I-II Cargo 6.6/7.8 Simples/Turbo DIESEL	330200-R
R330212P	1	 DISTRIBUCIÓN	66.70	88.8	11/12.5		G1ALGHD				
R870610V	1	 GUÍA VÁLVULAS (24) R870610V/1	8	13.6	19	33.7	RGV	2632-E/2932-E/4432 E/4532-E/5032-E CARGO 2003/...	8270cc.	ISCe6 24V	870600-R
R870011V R870011VF	1	 BANCADA	130	150	12/13		GALGRI				
R870212V R870212T	1	 DISTRIBUCIÓN	75	93	9/10		G1ALGRD				
R870210V	1	 GUÍA VÁLVULAS (16) R870210V/1	8.9	15.9	10	36.5	RGV	Cargo 1722/1730/2625 1998/..., F14000 1999/...	8300cc.	6C - 6CT - CTA (SOHC) 12V DIESEL	870200-R
R870011V R870011VF	1	 BANCADA	130	150	12/16		GALGRI				













CATALOGO DE RETENES

CATALOGO DE RETENTORES - OIL SEAL CATALOG















FORD PESADO

Código Code	Cant. Qty	Descripción Descrição Descrição	DE [mm]	DA [mm]	H [mm]	A [mm]		Aplicación Aplicação Aplicacion	Cm³ Cm³	Motor Motor Engine	Jgo. Juntas Set Gaskets
R870212V R870212T	1	 DISTRIBUCIÓN	75	93	9/10		G1ALGRD	Cargo 1722/1730/2625 1998/..., F14000 1999/...	8300cc.	6C - 6CT - CTA (SOHC) 12V DIESEL	870200-R





HONDA

R240411P R240411P/1 R240411V	1	 BANCADA	80	98	10		G1ALGRI	Fit BR 2003/..., City 2004/... Jazz 2005/...	1339cc.	I-DSI Twin Spark L13A3/A5 (SOHC) 8V	862300-R
R270713P R270713P/1 R270713V	1	 DISTRIBUCIÓN	40	55	7		G1ALGHD				
R250211P R250211N	1	 BANCADA	80	100	10		GALGHI	Civic CVCC 1987/90 CRX 1988/91 Civic 2000/... Civic VTEC-E 1995/97 Civic VTEC 1996/... Civic Aerodeck VTEC 1998/... Civic 1500 1984/89 CRX 1988/91 Civic VTEC 1992/96	1343cc. 1493cc. 1396cc. 1493cc.	D13B1/B2 (SOHC) 16V D15B6 (SOHC) 16V D14Z1/Z2 (SOHC) 16V D15Z3/Z6/Z8 (SOHC) 16V	860300-R 860300-R 863000-R MLS 863000-R MLS
R240411P R240411P/1 R240411V	1	 BANCADA	80	98	10		G1ALGRI	Fit VTEC 2007/... Jazz VTEC 2006/... City VTEC 2005/... City 2009/13 Fit, WT-V 2014/16	1496cc.	L15A1 - L15A6 (SOHC) 16V	862500-R
R270713P R270713P/1 R270713V	1	 DISTRIBUCIÓN	40	55	7		G1ALGHD		1496cc.	L15A8/Z3/Z9 (OHV) 16V	865100-R MLS
R250211P R250211N	1	 BANCADA	80	100	10		GALGHI	Civic Coupe VTEC 1994/95, Civic Del Sol VTEC, Civic VTEC 1991/97, CRX VTEC 1992/95 Civic CRX, Integra 1985/87 Civic CX/DX/LX/SI/HX/EX Civic del Sol - Civic coupe CRX - Civic VTEC-E 1996/... Civic CRX .../1992 Civic CRX VTEC Del Sol VTEC 1992/95 HR-V VTEC 1999/05 Civic V Aerodeck VTEC 1998/00 Civic 1996/... Civic VTEC 1999/02 Civic VTI VTEC, Civic del Sol VTEC CRX VT VTEC 1991/00 Accord 1984/85	1590cc. 1590cc. 1590cc. 1590cc. 1590cc. 1590cc. 1590cc. 1590cc. 1595cc. 1595cc.	D16Z6/Z7/Z9 (SOHC) 16V ZC1 - ZV (DOHC) 16V D16Y2/Y5/Y6/Y7/Y8 (SOHC) 16V D16A7 (SOHC) 16V D15Z6/Z7 (SOHC) 16V D16W5 (SOHC) 16V D16W4 (SOHC) 16V D16Y8 (SOHC) 16V B16A2 (DOHC) 16V B16A1/A2/A3 (DOHC) 16V EZ1 (SOHC) 12V	860400-R 860500-R 863000-R MLS 863200-R 863500-R MLS 863600-R MLS 863600-R MLS 863700-R MLS 861900-R MLS 863300-R MLS 863800-R
R860810P	1	 GUÍA VÁLVULAS (16) R860810P/1	5	11	10		RGV	Civic Coupe 2001/05	1668cc.	D17A8 (SOHC) 16V DIESEL	861600-R
R250211P R250211N	1	 BANCADA	80	100	10		GALGHI	Civic VTI VTEC 1997/00	1797cc.	B18C1 (DOHC) 16V	863300-R
R862710V	1	 GUÍA VÁLVULAS (16) R862710V/1	5.5	11	10		RGV	Civic Sedan, Coupe 2006/11 New Civic 2006/11 HR-V 2015/...	1799cc.	R18A1/A2 (SOHC) 16V	862700-R MLS
R240411P R240411P/1 R240411V	1	 BANCADA	80	98	10		G1ALGRI				
R250211P R250211N	1	 BANCADA	80	100	10		GALGHI	Accord 1984/85 Prelude 1984/85 Integra 1990/93 - 1994/95	1829cc. 1834cc.	ES/ET1 (SOHC) 12V B18A1 (DOHC) 16V	863800-R 864000-R MLS
R860810P	1	 GUÍA VÁLVULAS (16) R860810P/1	5	11	10		RGV	Accord 1993/... Accord VTEC 1999/...	1850cc. 1850cc.	F18A3 (SOHC) 16V F18B2/B3 (SOHC) 16V	860800-R 860900-R
R250211P R250211N	1	 BANCADA	80	100	10		GALGHI				

HONDA

Código Code	Cant. Qty	Descripción Descrição Descrição	DE [mm]	DA [mm]	H [mm]	A [mm]		Aplicación Aplicação Application	Cm³ Cm³	Motor Motor Engine	Jgo. Juntas Set Gaskets
R250211P R250211N	1	 BANCADA	80	100	10		GALGHI	Accord 1986/88 Prelude 1987 - Accord 1987/89 Prelude III 1987/92 Prelude III 1987/92 CR-V 1997/98, CR-V 1999/...	1955cc. 1958cc. 1958cc. 1973cc.	A20A1/A3 (SOHC) 12V B20A3/A4 (SOHC) 12V B20A5/7/9 (DOHC) 16V B20B2/B3 (DOHC) 16V B20Z1/3/9 (DOHC) 16V	864100-R 864200-R 864300-R 861400-R
R860210P	1	 GUÍA VÁLVULAS (8) R860210P/1	6	11.8	10.11		RGV	Civic TD 1997/99 Accord TD 1996/00	1994cc.	20T2R - 20T2N (SOHC) 8V	860201-R
R860810P	1	 GUÍA VÁLVULAS (16) R860810P/1	5	11	10		RGV	Accord 1993/...	1997cc.	F20Z1 - F20Z2 (SOHC) 16V	860800-R
R250211P R250211N	1	 BANCADA	80	100	10		GALGHI	Accord VTEC 1998/... Accord Coupe VTEC 1998/... Accord Aerodeck 1994/97	1997cc.	F20B3 - F20B5 - F20B6 (SOHC) 16V	860900-R
R862710V	1	 GUÍA VÁLVULAS (16) R862710V/1	5	11	10		RGV	CR-V 2002/06 Civic VI/VII VTEC 2003/... Integra VTEC 2002/...	1998cc.	K20A/A3 (I-VTEC) (DOHC) 16V	862800-R MLS
R240411P R240411P/1 R240411V	1	 BANCADA	80	98	10		G1ALGRI	Accord, Accord Tourer 2003/06 Stepwagon VTEC 2005/...	1998cc.	K20A6 (DOHC) 16V	862900-R MLS
R240411P R240411P/1 R240411V	1	 BANCADA	80	98	10		G1ALGRI	Stream VTEC 2001/... Civic Type-r VTEC 2001/05 Integra Type-r VTEC 2004/...	1998cc. 1998cc.	K20A1 (DOHC) 16V K20A2 (DOHC) 16V	864400-R MLS 864500-R MLS
R250211P R250211N	1	 BANCADA	80	100	10		GALGHI	Prelude 1990/92	2056cc.	B21A1 (DOHC) 16V	864700-R
R860810P	1	 GUÍA VÁLVULAS (16) R860810P/1	5	11	10		RGV	Prelude VTEC, Accord Wagon 1994/98, Accord Aerodeck Coupe, Wagon 1994/97 Prelude VTEC 1993/96 Accord 1991/98 Prelude VTEC 1997/... Prelude Type VTEC 1997/00	2156cc. 2157cc. 2157cc.	F22B1 - F22B4/B5/B8 (SOHC) 16V H22A1/A2 (DOHC) 16V H22A4/A6/A8 H22A5 (DOHC) 16V	860900-R 861200-R 861300-R
R250211P R250211N	1	 BANCADA	80	100	10		GALGHI	Accord Typer R 1998/... Accord, Prelude 1998/00	2157cc.	H22A4/A5/A7 (DOHC) 16V	861500-R
R860810P	1	 GUÍA VÁLVULAS (16) R860810P/1	5	11	10		RGV	Accord, Prelude 1992/96	2259cc.	H23A1/2/3 (DOHC) 16V	861000-R
R250211P R250211N	1	 BANCADA	80	100	10		GALGHI				
R862710V	1	 GUÍA VÁLVULAS (16) R862710V/1	5	11	10		RGV	CR-V EX/LX/SE VTEC, CR-V II VTEC 2002/06 CR-V III VTEC 2007/...	2354cc.	K24A1 (DOHC) 16V	862800-R MLS
R240411P R240411P/1 R240411V	1	 BANCADA	80	98	10		G1ALGRI				
R240411P R240411P/1 R240411V	1	 BANCADA	80	98	10		G1ALGRI	Accord VII Coupe VTEC 1998/00, Accord VTEC, Accord Coupe VTEC 1998/02 Legend 1991/96 Shuttle 2000/02 Odyssey 2000/... - 2002/04	2997cc. 3206cc. 3471cc.	J30A1/A2 (SOHC) 24V V6 C32A2 (SOHC) V6 24V J35A/A1/A2 (SOHC) 24V V6	864800-R MLS 864900-R 865000-R MLS























HYUNDAI

R990011P	1	 BANCADA	60	75	8		GALGHI	Atos 1993/97	800cc.	G4HB (SOHC) 8V	901300-R
R950512N R950512P	1	 DISTRIBUCIÓN	30	46	8		GALGHD				
R990011P	1	 BANCADA	60	75	8		GALGHI	Santro 1997/..., Atos 1998/... Atos 2003/..., Santro 2003/05 Atos 2006/10	999cc. 1086cc. 1086cc.	G4HC (SOHC) 12V G4HD (SOHC) 12V G4HG (SOHC) 12V	990000-R 990300-R 990500-R
R950512N R950512P	1	 DISTRIBUCIÓN	30	46	8		GALGHD				



CATALOGO DE RETENES

CATALOGO DE RETENTORES - OIL SEAL CATALOG















HYUNDAI

Código Code	Cant. Qty	Descripción Descrição Decripción	DE [mm]	DA [mm]	H [mm]	A [mm]		Aplicación Aplicação Aplicacion	Cm³ Cm³	Motor Motor Engine	Jgo. Juntas Set Gaskets
R470013P R470013P/1 R470013V	1	 ÁRBOL DE LEVAS	35	50	7		GALG-BI	Santro 1997/..., Atos 1998/... Atos 2003/..., Santro 2003/05 Atos 2006/10	999cc. 1086cc. 1086cc.	G4HC (SOHC) 12V G4HD (SOHC) 12V G4HG (SOHC) 12V	990000-R 990300-R 990500-R
R950311P	1	 BANCADA	72	96	9		GALGRI	Verna 2000/02	1495cc.	G4EK (SOHC) 12V	990400-R
R470013P R470013P/1 R470013V	1	 DISTRIBUCIÓN	35	50	7		GALG-BI				
R240013P R240013P/1 R240013V	1	 ÁRBOL DE LEVAS	35	48	7		GALGHD				
R950311P	1	 BANCADA	72	96	9		GALGRI	Excel, Pony 1986/95	1468cc.	G4AJ/G4J (SOHC) 8V	991400-R
R950512N R950512P	1	 DISTRIBUCIÓN	30	46	8		GALGHD				
R950311P	1	 BANCADA	72	96	9		GALGRI	Accent, Elantra 1999/... Coupe 1992/95 Accent 1996/...	1495cc. 1495cc.	G4K -G4EK - G4E (SOHC) 12V G4K (DOHC) 16V	991500-R MLS 991600-R MLS
R520811P	1	 BANCADA	80	96	9		GALGRI	Lantra 1990/95 Elantra, Lantra 1993/95 Sonata 1988/96	1595cc. 1595cc. 1795cc.	G4CR (DOHC) 16V G4CR (DOHC) 16V G4M (SOHC) 8V	991700-R 991800-R 992200-R
R950312P R950312S	1	 DISTRIBUCIÓN	44	60	7		GALGHD	Elantra, Lantra 1993/95 Elantra, Lantra 1993/95	1836cc. 1836cc.	G4CN (DOHC) 16V G4CN (DOHC) 16V	991700-R 991800-R
R460300	1	 KIT DE RETENES					JUEGO	Lantra 1998/..	1905cc.	XUD9 (SOHC) 8V DIESEL	460301-R 460300-R-1M 460300-R-2M 460300-R-3M
R460210V	1	 GUÍA VÁLVULAS (8) R250410V/1	8	10.8	10		RGV				
R460211V	1	 BANCADA	90	110	7		GALGRI				
R460212P R460212V	1	 DISTRIBUCIÓN	42	62	7		GALGHD				
R470013P R470013P/1 R470013V	1	 ÁRBOL DE LEVAS	35	50	7		GALG-BI				
460235	2	 BASTÓN CIERRE BANCADA									
R981312P	1	 BANCADA	32	45	6			Tucson TCI 2005/09 Sonata TCI 2005/09	1991cc.	D4EA (SOHC) 16V DIESEL	992400-R MLS
R460213P R460213V	1	 ÁRBOL DE LEVAS	36	50	8		GALGHD	Tucson TCI 2004/... Trajet CRDI, Elantra CRDI Santa Fe CRDI 2000/05	1995cc.	D4EA (SOHC) 16V DIESEL	911501-R
R950312P R950312S	1	 DISTRIBUCIÓN	44	60	7		GALGHD	Trajet 2000/04 Santa Fe 2000/05 Sonata 2001/04	1997cc.	G4JP (DOHC) 16V	992600-R MLS
R520811P	1	 BANCADA	80	96	9		GALGRI	Sonata 1994/99 Sonata 1989/93, H100 1993/..., H1 1997/00	1997cc. 2351cc.	G4CP (DOHC) 16V G4CS (SOHC) 8V	992500-R 992700-R
R950312P R950312S	1	 DISTRIBUCIÓN	44	60	7		GALGHD				
R520811P	1	 BANCADA	80	96	9		GALGRI	H100 D/TD 1996/98, 1998/..., H1 - H1 TD 1997/... H1 1997/..., H100D 1998/...	2476cc. 2607cc.	D4BA/BAX D4BH/BF D4BB (SOHC) 8V DIESEL	910500-R
R950312P R950312S	1	 DISTRIBUCIÓN	44	60	7		GALGHD				



HYUNDAI

Código Code	Cant. Qty	Descripción Descrição Descrição	DE [mm]	DA [mm]	H [mm]	A [mm]		Aplicación Aplicação Aplicación	Cm³ Cm³	Motor Motor Engine	Jgo. Juntas Set Gaskets
R470013P R470013P/1 R470013V	1	 DISTRIBUCIÓN	35	50	7		GALG-BI	H100 D/TD 1996/98, 1998/..., H1 - H1 TD 1997/..., H1 1997/..., H100D 1998/...	2476cc. 2607cc.	D4BA/BAX D4BH/BF D4BB (SOHC) 8V DIESEL	910500-R
R250156N	1	 AUXILIAR	25	35	7		GA				
R550413P R550413N	3	 DISTRIBUCIÓN	30	42	8		GAHI	Santa Fe GL/GLS/FX 2001/06 Sonata GL/GLS/LX 2001/05 2005/..., Coupe 2001/07 Santa Fe GLS 2005/..., Santa Fe 2005/10 Sonata, Galloper 1999/... Veracruz, Genesis 2008/...	2656cc. 2656cc. 2972cc. 3778cc.	G6BA (DOHC) 24V G6EA (DOHC) V6 24V G6CT (DOHC) V6 24V G6DA (DOHC) V6 24V	991000-R MLS 991100-R MLS 995000-R 990900-R MLS

IKA

R540012P R540012N	1	 DISTRIBUCIÓN	52.38	81.02	11		GALGHD	Jeep Continental Bergantin 1954/74	2470cc.	4L - 151 80HP Ø84.14	540000-R
R540057N	1	 PIÑÓN	39.68	80.29	7/16		ESP-RD				
540058	1	 EMPAQUETADURA BANCADA (2)					JUEGO				
R540210P	1	 GUÍA VÁLVULAS (12) R300310P/1	7.9	14	13.2		RGV	Torino, Rambler, Utilitario Gladiator, Jeep T80 1966/73	2966cc.	OHC 181 4B 300/300S/38	540200-R
R540012P R540012N	1	 BANCADA	52.38	81.02	11		GALGHD				
540058	1	 EMPAQUETADURA BANCADA (2)					JUEGO				
R540210P	1	 GUÍA VÁLVULAS (12) R300310P/1	7.9	14	13.2		RGV	Rambler Gladiator Torino Tornado 300SL 1966/73	2966cc.	OHC 181/230/300	540400-R
R540012P R540012N	1	 BANCADA	52.38	81.02	11		GALGHD				
540058	1	 EMPAQUETADURA BANCADA (2)					JUEGO				
R540012P R540012N	1	 BANCADA	52.38	81.02	11		GALGHD	Estanciera, Baqueano Gladiator, Continental, Kaiser Carabela, Manhattan 1955/... Bergantin Super 1954/67	3705cc.	L226	540100-R
540058	1	 EMPAQUETADURA BANCADA (2)					JUEGO				
R540210P	1	 GUÍA VÁLVULAS (12) R300310P/1	7.9	14	13.2		RGV	Torino 1973/...	3770cc.	OHC 7B 181/230/300/380	540300-R
R540012P R540012N	1	 BANCADA	52.38	81.02	11		GALGHD	Torino Tornado Reforma 1972/74	3770cc.	OHC 4B	540500-R
540058	1	 EMPAQUETADURA BANCADA (2)					JUEGO				

























INDENOR

R500200 R500200-1	1	 KIT DE RETENES					JUEGO	404, T4B, T5B, Rastrojero 1972/...	1948cc.	XD/XDP 4.88 DIESEL	500200-R
R460210V	1	 GUÍA VÁLVULAS (8) R250410V/1	8	10.8	10		RGV				
R500211-1S	1	 BANCADA REFORMA EXPANSIBLE	60	75	5		EXPAN				
R450012P R450012N	1	 DISTRIBUCIÓN	42	60	10		GALGHD				
R450412P R450412N	1	 DISTRIBUCIÓN	42	60	8		GALGHD				
500258	1	 EMPAQUETADURA BANCADA (2)					JUEGO				

CATALOGO DE RETENES

CATALOGO DE RETENTORES - OIL SEAL CATALOG









INDENOR

Código Code	Cant. Qty	Descripción Descrição Descrição	DE [mm]	DA [mm]	H [mm]	A [mm]		Aplicación Aplicação Application	Cm³ Cm³	Motor Motor Engine	Jgo. Juntas Set Gaskets
R450012P R450012N	1	 DISTRIBUCIÓN	42	60	10		GALGHD	504 1980/..., J7/J9 1980/87	2112cc.	XD-XDP 4.90	500600-R
R450400 R450400-1 R450400-2	1	 KIT DE RETENES						XD2 504D 1976/93 505D 1979/82, 505TD 1981/... 604TD 1978/83, J7D1977/..., J9D 1980/...	2304cc	XD2 - XD2P (OHV) 8V	450701-R 450700-R-1M 450700-R-2M 450700-R-3M 450700-R-4M
R460210V	1	 GUÍA VÁLVULAS (8) R250410V/1	8	10.8	10		RGV	XD3 504 1987/..., 505 1982/93, J9 1986/94	2498cc	XD3 - X3DP (OHV) 8V DIESEL	
R450411-1S	1	 BANCADA REFORMA EXPANSIBLE	64	80	5		EXPAN				
R450412P R450412N	1	 DISTRIBUCIÓN	42	60	8		GALGHD				
R450412-1P	1	 DISTRIBUCIÓN	42	60	8		GALGHD				
R450412-2P	1	 DISTRIBUCIÓN	45	60	8		GALGHD				
450435	2	 BASTÓN CIERRE BANCADA									
450758	1	 EMPAQUETADURA BANCADA (2)					JUEGO				
R461510V	1	 GUÍA VÁLVULAS (12) R250410V/1	8	10.8	10		RGV	Pick Up, Camiónes Livianos 1976/...	3168cc.	XDP 6.90	500300-R
R450012P R450012N	1	 DISTRIBUCIÓN	42	60	10		GALGHD				
500258	1	 EMPAQUETADURA BANCADA (2)					JUEGO				
ISUZU											
R280210V	1	 GUÍA VÁLVULAS (8) R280210V/1	5.8	11.4	10.4		RGV	I- Mark 1987/... Gemini 1987/..., I-Mark Gemini TD 1988/...	1468cc. 1488cc.	4EC1 4EC1- T4EC1 (SOHC) 8V DIESEL	242600
R280211V	1	 BANCADA	87	100	8.5		GALGRI				
R280212P R280212V	2	 DISTRIBUCIÓN	40	52	6		GALGHD				
R860810P	1	 GUÍA VÁLVULAS (16) R860810P/1	5	11	10		RGV	Oasis 1995/97	2156cc.	RJ1 (SOHC) 16V	860900-R
R250211P R250211N	1	 BANCADA	80	100	10		GALGHI				
R240711P R240711N	1	 BANCADA	95	118	8.5		GALGHI	Luv, Pick Up, Trooper II 1986/95, Impulse	2254cc.	4ZD1 (SOHC) 8V	280400-R
R260312P R260312P/1 R260312V R260312N	1	 DISTRIBUCIÓN	40	56	7		G1ALGHD				
R240713P R240713N	1	 ÁRBOL DE LEVAS	30	45	8		GALGHD				
R280415N	1	 BOMBA DE ACEITE	25	40	8		GALG-BI				
R240710P	1	 GUÍA VÁLVULAS (8) R240710P/1	8	12	14		RGV	Trooper 1988/92 Trooper, Trooper TD 1988/92	2499cc. 2771cc.	4JA1 4JB1 - 4JB1T DIESEL	240700-R
R240711P R240711N	1	 BANCADA	95	118	8.5		GALGHI				
R240712N	1	 DISTRIBUCIÓN	50	65	10						







CATALOGO DE RETENES

CATALOGO DE RETENTORES - OIL SEAL CATALOG

ISUZU

Código Code	Cant. Qty	Descripción Descripción	DE [mm]	DA [mm]	H [mm]	A [mm]		Aplicación Aplicação Aplicacion	Cm³ Cm³	Motor Motor Engine	Jgo. Juntas Set Gaskets
R240713P R240713N	1	 ÁRBOL DE LEVAS	30	45	8		GALGHD	Trooper 1988/92 Trooper, Trooper TD 1988/92	2499cc. 2771cc.	4JA1 4JB1 - 4JB1T DIESEL	240700-R
R250412P R250412N	1	 ÁRBOL DE LEVAS	40	56	7		GALGRD				
R550612P R550612V	1	 DISTRIBUCIÓN	50	68	10		GALGRD				
R250412P R250412N	1	 ÁRBOL DE LEVAS	40	56	7		GALGRD	Tropper, Tropper TD 1988/92	2771cc.	4JB1-T (OHV) 8V DIESEL	930500-R
R240710P	1	 GUÍA VÁLVULAS (8) R240710P/	8	12	14		RGV	Tropper D/TD, Campo D/TD 1991/...	3059cc.	4JG2 - 4JG2T (SOHC) 8V DIESEL	930300-R
R550612P R550612V	1	 DISTRIBUCIÓN	50	68	10		GALGHD				
R250412P R250412N	1	 ÁRBOL DE LEVAS	40	56	7		GALGRD				
R930110P	1	 GUÍA VÁLVULAS (8) R930110P/1	9	14	17		RGV	ELF 250 (TLD/KT) 1982/... ELF 350 (KS/BE) 1984/... ELF 350 (NPR) ELF 250 (NKR) 1984/...	3268cc.	4BC2 - 4BD1 (OHV) 8V DIESEL	930100-R
R930111S	1	 BANCADA	100	135	15	140	GALGHI				

JOHN DEERE

R850011P	1	 BANCADA	120.65	146.07	12.7		GALGRIC/pista	1030/1035/1520/1530/204/302 1973/...	2696cc.	3164D	850000-R 850001-R 850100-R 850101-R
R850012N R850012P	1	 DISTRIBUCIÓN	57.15	76.20	9.5		GALGHD	Tractor Equipos Viales 2120/2030/2035/2270/2280 2340, JD310/401/440/450/480 1974/..., 2130/2135/1640 1840/2140/JD4400/540B 550/555 1980/...	3590cc. 3918cc.	4239 D/T 4239 D/T DIESEL	
R850011P	1	 BANCADA	120.65	146.07	12.7		GALGRI	Motores Agrícolas e Industriales 3420, J10, 4420, 570	4500cc. 4976cc.	4540TJ31 - 4045DJ31 303	850701-R 850701 850300-R 850300-R 850200-R 850201-R
R850012N R850012P	1	 DISTRIBUCIÓN	57.15	76.20	9.5		GALGHD	Tractor Motoniveladora 1972/... Tractor Motoniveladora 6329D 3120/3130/3135/2840/630 730/JD303/444/540/570/482 6359D, 3140/3040/3640/4040 960/975/2940/3050/3350/3650 6505/6605/6615/7500, Power Tech, MUM, Power Tech, Gen Set Tractor Motoniveladora 6329D 3120/3130/3135/2840/630 730/JD303/444/540/570 482/6359D, 3140/3040/3640 4040/960/975/2940/3050 3350/3650 3350/3550/6500/6600/7500 Cosechadora 1075 1991/...	5393cc. 5395cc. 5395cc. 5877cc.	329 6.329D 6068TJ31/32 6068TJ61 - 6068HJ63 6.359D	850601-R 850601 850200-R 850201-R
R850511P	1	 BANCADA	101.60	127	7.94		GALGHI	730, Tractor 375 1960/74	6156cc.	DIESEL	850500-R
R850512P	1	 DISTRIBUCIÓN	57.15	76.2	9.5		GALGHD				















KIA

R990011P	1	 BANCADA	60	75	8		GALGHI	Picanto 2004/12	1086cc.	G4HG (SOHC) 12V	911200-R MLS
R950512P R950512N	1	 DISTRIBUCIÓN	30	46	8		GALGHD				
R460213P R460213V	1	 ÁRBOL DE LEVAS	36	50	8		GALGHD	Carens II CRDI 2002/06	1995cc.	D4EA (SOHC) 16V DIESEL	911501-R

CATALOGO DE RETENES

CATALOGO DE RETENTORES - OIL SEAL CATALOG

KIA

Código Code	Cant. Qty	Descripción Descrição Descrição	DE [mm]	DA [mm]	H [mm]	A [mm]		Aplicación Aplicação Aplicacion	Cm³ Cm³	Motor Motor Engine	Jgo. Juntas Set Gaskets
R900900	1	 KIT DE RETENES					JUEGO	Sportage TD 1996/... Besta 1992/97	1998cc. 2184cc.	RF R2 DIESEL	910100-R 900900-R
R900910P	1	 GUÍA VÁLVULAS (8) R900910P/1	7	13.9	14.5		RGV				
R460211V	1	 BANCADA	90	110	7		GALGRI				
R900912P	1	 DISTRIBUCIÓN	34	48	7		GALGHD				
R900913P	1	 ÁRBOL DE LEVAS	30	44	7		GALGHD				
R520811P	1	 BANCADA	80	96	9		GALGRI	Pregio, K2500 2001/05 Bongo 2006/...	2476cc.	D4BH (SOHC) 8V DIESEL	910700-R
R950312P R950312S	1	 DISTRIBUCIÓN	44	60	7		GALGHD				
R470013P R470013P/1 R470013V	1	 ÁRBOL DE LEVAS	35	50	7		GALG-BI				
R550413P R550413N	3	 DISTRIBUCIÓN	30	42	8		GAHI	Optima LX/SE/EX 2002/06 Magentis 2002/07	2656cc.	G6BA (DOHC) 24V	991000-R MLS
R900811S	1	 BANCADA	101.57	125	13		GALGHI	Besta 1993/...	2700cc.	VN 81HP Ø96	910000
R900812P	1	 DISTRIBUCIÓN	51	70	11		GALGHD				
R970310P	1	 GUÍA VÁLVULAS (8) R970310P/1	8	14	13.5		RGV	Besta GS, Besta GS Grand 2000/...	2956cc.	JTA (SOHC) 8V	911000-R MLS
R900811S	1	 BANCADA	101.57	125	13		GALGHI				
R900812P	1	 DISTRIBUCIÓN	51	70	11		GALGHD				
R550413P R550413N	4	 ÁRBOL DE LEVAS	30	42	8		GAHI	Amanti, Opirus 2003/... Sorento 2003/06 Mohave, Sorento 2007/...	3497cc. 3778cc.	6GCU (DOHC) V6 24V G6DA (DOHC) V6 24V	911400-R 990900-R MLS





KOMATSU

R850012N R850012P	1	 ÁRBOL DE LEVAS	57.15	76.2	9.5		GALGHD	Tractor, Autoelevador	4330cc.	4D105-5 DIESEL	760600-R
----------------------	---	----------------------------------------------------------------------------------------------------	-------	------	-----	--	--------	-----------------------	---------	-------------------	----------

KUBOTA

R550613P R550613P/1 R550613V	1	 DISTRIBUCIÓN	35	47	7		GAHD	Maquinaria Agrícola D722	719cc.	3D66 6V DIESEL	770000-R
------------------------------------	---	--------------------------------------------------------------------------------------------------	----	----	---	--	------	--------------------------	--------	-------------------	----------







LADA

R250410V R250410VM/1 R250410VM/2 R250410VM/3	1	 GUÍA VÁLVULAS (8) A GRANEL (200) A GRANEL (200) A GRANEL (1000)	8	10.8	10		RGV	2101/2102/2105 1970/... 2103/2105/2107 1972/... 2106/2107/2121, Niva 2121 1976/..., Aleko 2141 1990/... Vaz 21213, Niva 21213 1994/...	1198cc. 1452cc. 1568cc.	OHC OHC BA3	970600-R 970600-R 970500-R
R550411N R550411P	1	 BANCADA	70	90	10		GALGHI		1690cc.	17LTBI (SOHC) 8V	970700-R
R260312P R260312P/1 R260312V R260312N	1	 DISTRIBUCIÓN	40	56	7		G1ALGHD				
R460300	1	 KIT DE RETENES					JUEGO	Niva 2121, Aleko 1990/...	1905cc.	XUD9 (SOHC) 8V DIESEL	460301-R 460300-R-1M 460300-R-2M 460300-R-3M













CATALOGO DE RETENES

CATALOGO DE RETENTORES - OIL SEAL CATALOG

LADA

Código Code	Cant. Qty	Descripción Descrição Descrição	DE [mm]	DA [mm]	H [mm]	A [mm]		Aplicación Aplicação Application	Cm³ Cm³	Motor Motor Engine	Jgo. Juntas Set Gaskets
R460210V	1	 GUÍA VÁLVULAS (8) R250410V/1	8	10.8	10		RGV	Niva 2121, Aleko 1990/...	1905cc.	XUD9 (SOHC) 8V DIESEL	460301-R 460300-R-1M 460300-R-2M 460300-R-3M
R460211V	1	 BANCADA	90	110	7		GALGRI				
R460212P R460212V	1	 DISTRIBUCIÓN	42	62	7		GALGHD				
R470013P R470013P/1 R470013V	1	 ÁRBOL DE LEVAS	35	50	7		GALG-BI				
460235	1	BASTÓN CIERRE BANCADA									
R240210P R240210V R240210VM/1 R240210VM/2 R240210VM/3	1	 GUÍA VÁLVULAS (8) GUÍA VÁLVULAS (8) A GRANEL (200) A GRANEL (200) A GRANEL (1000)	7	11.1	10		RGV	110 GTi 1996/...	1998cc.	C20XE (DOHC) 16V	290900-R
R240013P R240013P/1 R240013V	1	 ÁRBOL DE LEVAS	35	48	7		GALGHD				





















LANCIA

R270510P R270510V	1	 GUÍA VÁLVULAS (8) R260610V/1	7	9.8	10		RGV	Ypsilon 1996/00	1242cc.	840A3	251700
R260113P R260113P/1 R260113V	1	 ÁRBOL DE LEVAS	30	42	7		GALGHD				
R270710V	1	 GUÍA VÁLVULAS (16) R230510V/1	6	8.8	9.5		RGV	Ypsilon 2000/... Ypsilon 2003/... Ypsilon 2003/...	1242cc. 1242cc. 1368cc.	Fire 188.A5 (DOHC) 16V 178D7 (DOHC) 16V 183A1/192B2 (DOHC) 16V	270700-R 272500-R MLS 272500-R MLS
PR270711V	1	 PORTA BANCADA	74				PORTA				
R270713P R270713P/1 R270713V	2	 ÁRBOL DE LEVAS	40	55	7		G1ALGHD				
R270715P	1	 BOMBA DE ACEITE	27	37	7		G1ALGHD				
R250400	1	 KIT DE RETENES					JUEGO				
R250410V R250410VM/1 R250410VM/2 R250410VM/3	1	 GUÍA VÁLVULAS (8) A GRANEL (200) A GRANEL (200) A GRANEL (1000)	8	10.8	10		RGV	Prisma 1983/... Delta 1986/92 Prisma, Delta 1978/81	1301cc. 1498cc.	831B (SOHC) 8V 80HP (SOHC) 8V	250500-R 250500-R
R250111P R250111P/1 R250111V R250111N	1	 BANCADA	64	80	8		G1ALGHI				
R250412N R250412P	1	 DISTRIBUCIÓN	40	56	7		GALGRD				
R250413P R250413P/1	1	 ÁRBOL DE LEVAS	30	52	7		GALGRD				
R271210V R271210VM/2	1	 GUÍA VÁLVULAS (8) A GRANEL (200)	5	7.8	8		RGV	Musa 2004/...	1368cc.	169 A4.000	2719000-R MLS
PR271911VF	1	 PORTA BANCADA	74				PORTA				

























CATALOGO DE RETENES

CATALOGO DE RETENTORES - OIL SEAL CATALOG

LANCIA

Código Code	Cant. Qty	Descripción Descrição Descrição	DE [mm]	DA [mm]	H [mm]	A [mm]		Aplicación Aplicação Application	Cm³ Cm³	Motor Motor Engine	Jgo. Juntas Set Gaskets
R270713P R270713P/1 R270713V	1	 ÁRBOL DE LEVAS	40	55	7		G1ALGHD	Musa 2004/...	1368cc.	169 A4.000	2719000-R MLS
R270515V	1	 BOMBA DE ACEITE	27	37	7		G1ALGHD				
R250400	1	 KIT DE RETENES					KIT	Delta, Prisma 1986/...	1498cc.	831B1 (DOHC) 8V	250600-R
R250410V R250410VM/1 R250410VM/2 R250410VM/3	1	 GUÍA VÁLVULAS (8) A GRANEL (200) A GRANEL (200) A GRANEL (1000)	8	10.8	10		RGV				
R250111P R250111P/1 R250111V R250111N	1	 BANCADA	64	80	8		G1ALGHI				
R250412N R250412P	1	 DISTRIBUCIÓN	40	56	7		GALGRD				
R250413P R250413P/1	1	 ÁRBOL DE LEVAS	30	52	7		GALGRD				
R250652N	1	 SEMEJE PALIER	22	35	8		GALG				
R250660-1P	1	 SEMEJE DERECHO	29.8	50	10/13.5		G1ALGHI				
R250660P	1	 SEMEJE IZQUIERDO	29.8	52	10/13.5		G1ALGH				
R260200	1	 KIT DE RETENES					KIT	Dedra 1989/93	1581cc.	835A	260300-R
R250410V R250410VM/1 R250410VM/2 R250410VM/3	1	 GUÍA VÁLVULAS (8) A GRANEL (200) A GRANEL (200) A GRANEL (1000)	8	10.8	10		RGV				
R250111P R250111P/1 R250111V R250111N	1	 BANCADA	64	80	8		G1ALGHI				
R250412N R250412P	1	 DISTRIBUCIÓN	40	56	7		GALGRD				
R250413P R250413P/1	2	 ÁRBOL DE LEVAS	30	52	7		GALGRD				
R260610V R260610VM/1 R260610VM/2 R260610VM/3	1	 GUÍA VÁLVULAS (16) A GRANEL (200) A GRANEL (200) A GRANEL (1000)	7	9.8	10		RGV	Delta, Dedra, Lybra 1996/...	1581cc.	182A4 - 182A6 (DOHC) 16V	260900-R
PR260911V	1	 PORTA BANCADA	64	81.5	8		PORTA				
R260312P R260312P/1 R260312V R260312N	1	 DISTRIBUCIÓN	40	56	7		G1ALGHD				
R260113P R260113P/1 R260113V	1	 ÁRBOL DE LEVAS	30	42	7		GALGHD				
R260313P R260313P/1 R260313V R260313N	2	 ÁRBOL DE LEVAS	30	52	7		G1ALGHD				







LANCIA

Código Code	Cant. Qty	Descripción Descrição Descrição	DE [mm]	DA [mm]	H [mm]	A [mm]		Aplicación Aplicação Aplicacion	Cm³ Cm³	Motor Motor Engine	Jgo. Juntas Set Gaskets
R260914P R260914V	1	 AUXILIAR	30	47	7		G1ALGHD	Delta, Dedra, Lybra 1996/...	1581cc.	182A4 - 182A6 (DOHC) 16V	260900-R
R260950P	1	 CAJA DE VELOCIDAD	63	69.5	11		ESP				
R260400	1	 KIT DE RETENES					KIT	Delta, Dedra 1993/99 Thema, Delta Turbo 1987/94	1756cc. 1995cc.	835C - 836A 831C - 834B (DOHC) 8V	260100-R
R250410V R250410VM/1 R250410VM/2 R250410VM/3	1	 GUÍA VÁLVULAS (8) A GRANEL (200) A GRANEL (200) A GRANEL (1000)	8	10.8	10		RGV				
R260111P R260111V	1	 BANCADA	74	90	10		G1ALGRI				
R260112P R260112V	1	 DISTRIBUCIÓN	30	43	8		G1ALGHD				
R250413P R250413P/1	2	 ÁRBOL DE LEVAS	30	52	7		GALGRD				
R260400	1	 KIT DE RETENES					JUEGO	Prisma 1986/91 Delta, Dedra TD 1994/99	1929cc. 1929cc.	831D (SOHC) 8V DIESEL 160D (SOHC) 8V DIESEL	260401-R 260401-R (270000)
R250410V R250410VM/1 R250410VM/2 R250410VM/3	1	 GUÍA VÁLVULAS (8) A GRANEL (200) A GRANEL (200) A GRANEL (1000)	8	10.8	10		RGV				
R260111P R260111V	1	 BANCADA	74	90	10		G1ALGRI				
R260112P R260112V	1	 DISTRIBUCIÓN	30	43	8		G1ALGHD				
R250413P R250413P/1	2	 ÁRBOL DE LEVAS	30	52	7		GALGRD				
R471410V	1	 GUÍA VÁLVULAS (16) (R470810V/1)	6	10	21.5	19.6	RGV	Phedra JTD Zeta JTD 2000/... Phedra JTD 2002/...	1997cc. 2179cc.	DW10JATED4 (RHW) DW10JATED4 (RHM) DW12TED4 (4HW) (DOHC) 16V DIESEL	471501-R
R460211V	1	 BANCADA	90	110	7		GALGRI				
R460212P R460212V	1	 DISTRIBUCIÓN	42	62	7		GALGHD				
R470813V	1	 ÁRBOL DE LEVAS	27	47	7		GALGHD				
460235	2	 BASTÓN CIERRE BANCADA									
R270910V	1	 GUÍA VÁLVULAS (20) R260610V/1	7	9.8	10		RGV	Kappa 1994/01 - 1996/02	1998cc.	838A1/A6 - 182B7 (DOHC) 20V	270900-R
PR270911V	1	 PORTA BANCADA	93				PORTA				
R270612V	1	 DISTRIBUCIÓN	55	68	8		GALGHD				
R260113P R260113P/1 R260113V	1	 ÁRBOL DE LEVAS	30	42	7		GALGHD				
R270615V	1	 ÁRBOL DE LEVAS SECUNDARIO	31	41	7		GALGHD				
R270910V	1	 GUÍA VÁLVULAS (20) R260610V/1	7	9.8	10		RGV	Kappa 1994/01	1998cc.	838A1 (DOHC) 20V	271300-R
R270612V	1	 DISTRIBUCIÓN	55	68	8		GALGHD				



CATALOGO DE RETENES

CATALOGO DE RETENTORES - OIL SEAL CATALOG





LANCIA

Código Code	Cant. Qty	Descripción Descrição Descrição	DE [mm]	DA [mm]	H [mm]	A [mm]		Aplicación Aplicação Aplicacion	Cm³ Cm³	Motor Motor Engine	Jgo. Juntas Set Gaskets
R260113P R260113P/1 R260113V	1	 ÁRBOL DE LEVAS	30	42	7		GALGHD	Kappa 1994/01	1998cc.	838A1 (DOHC) 20V	271300-R
R270615V	1	 ÁRBOL DE LEVAS SECUNDARIO	31	41	7		GALGHD				
R461510P	1	 GUÍA VÁLVULAS (12) R250410V/1	8	10.8	10		RGV	Zeta TD 1996/00	2088cc.	P8C (SOHC) 12V	461501-R
R460211V	1	 BANCADA	90	110	7		GALGRI				
R460212P R460212V	1	 DISTRIBUCIÓN	42	62	7		GALGHD				
R470013P R470013P/1 R470013V	1	 ÁRBOL DE LEVAS	35	50	7		GALG-BI				
460235	2	 BASTÓN CIERRE BANCADA									







LAND ROVER

R430110P	1	 GUÍA VÁLVULAS (8) R430110P/1 (4) R430110P/1 (2)	7.24 6.70	12.7 11.7	10.3 10.7		RGV	90D, 110D 1984/90 90TD, 110TD 1986/88	2494cc.	12J-19J DIESEL	
R430110P	1	 GUÍA VÁLVULAS (8) R430110P/1 (4) R430110P/1 (2)	7.24 6.70	12.7 11.7	10.3 10.7		RGV	Defender, 90, 110	2495cc.	17H	









LEYLAND

R420610P	1	 GUÍA VÁLVULAS (8) R420610P/1	7.4	11.5	9		RGV	Sherpa 185/200/215/220 230/240/250/255 1986/94	1994cc.	Prima 65 DIESEL	420600-R
R420611P	1	 BANCADA	88.9	105	9.5		GARI				
R420612P	1	 DISTRIBUCIÓN	35	45	7		GALGHD				
R420613P	1	 ÁRBOL DE LEVAS	40	52	7		GALGHD				
R420614P	1	 ÁRBOL DE LEVAS	45	60	7		GALGHI				















MAXION INTERNATIONAL

R430010V R430010VM/1 R430010VM/2	1	 GUÍA VÁLVULAS (8) A GRANEL (200) A GRANEL (200)	8	12	9.5	15.2	RGV	Range Rover TDI, Discovery TDI, Defender TDI 1990/94 - 1994/98 Sprinter TDI 1997/... Ranger TDI 1995/..., Blazer TDI, S10TDI 1995/... Ranger TD BR 2000-2002/....	2495cc.	200/300 TDI DIESEL	430001-R
PR430011V PR430011VF	1	 PORTA BANCADA	99.45				PORTA		2507cc.	TDI DIESEL	430001-R
R430012V	1	 DISTRIBUCIÓN	57	71	9		GALGRD		2758cc.	Power Stroke DIESEL	430001-R (430600)
R430013V	1	 ÁRBOL DE LEVAS	46.7	62	9		GALGHD				
R430015N	1	 GUARDAPOLVO CORREA DISTRIB.	57.5	74	8		GASRLG				
430058	2	 EMPAQUETADURA CIGÜEÑAL									
R430810V	1	 GUÍA VÁLVULAS (16) R430810V/1	6	12	20	24.5	RGV	Ranger 3.0I, 4 x 4 Full BR Intercooler 2005/8	2798cc.	NGD 3.0 E (SOHC) 16V DIESEL	430801-R

MAXION INTERNATIONAL

Código Code	Cant. Qty	Descripción Descrição Descrição	DE [mm]	DA [mm]	H [mm]	A [mm]		Aplicación Aplicação Application	Cm³ Cm³	Motor Motor Engine	Jgo. Juntas Set Gaskets
PR430011V PR430011VF	1	 PORTA BANCADA	99.45				PORTA	Ranger 3.0l, 4 x 4 Full BR Intercooler 2005/8	2798cc.	NGD 3.0 E (SOHC) 16V DIESEL	430801-R
R400012P R400012V R400012N	1	 DISTRIBUCIÓN	60.32	79.36	9.5		GALGHD				
R300310P R300310PN/1	1	 GUÍA VÁLVULAS (8) A GRANEL (200)	7.9	15.5	12.5		RGV	GM D10, F350, VW6.80 Case 550	3860cc.	4.236 (OHV) 8V DIESEL	410600-R
R400211P R400211V	1	 BANCADA	133.35	158.75	11/13		GALGRI				
R400012N R400012P R400012V	1	 DISTRIBUCIÓN	60.32	79.36	9.5		GALGHD				
R280310P	1	 GUÍA VÁLVULAS (8) R400210P/1	9.1	12.3	15.1		RGV				
R300310P R300310PN/1	1	 GUÍA VÁLVULAS (8) A GRANEL (200)	7.9	15.5	12.5		RGV	GM D20/D40, Pick Up D20 MF290/292/610/620	3990cc. 4100cc.	Maxion S4 P4000-4000T DIESEL	280300-R 401100-R
R400211P R400211V	1	 BANCADA	133.35	158.75	11/13		GALGRI				
R400012N R400012P R400012V	1	 DISTRIBUCIÓN	60.32	79.36	9.5		GALGHD				

MAZDA

R971511P	1	 BANCADA	70	80	11			323 1981/89 323 1980/87, Familia 1983/84	1296cc. 1490cc.	E3 (SOHC) 8V E5 (SOHC) 8V	972000
R971512P	1	 DISTRIBUCIÓN	40	55	8		GALGHD				
R970310P	1	 GUÍA VÁLVULAS (8) R970310V/1	8	14	13.5		RGV	818 1972/77 616/626, Capella 1971/77 Capella, Pick Up 1978/... 626 1979/83, E1600 1982/84 B1600, 808 1972/77	1490cc. 1586cc.	NA (SOHC) 8V NA (SOHC) 8V	970300-R 970300
R970311P	1	 BANCADA	80	105	13		GALGHI				
R900012P R900012N	1	 DISTRIBUCIÓN	48	70	9		GALGHD				
R970312N	1	 DISTRIBUCIÓN	48	70	12		GALGHD				
R970311P	1	 BANCADA	80	105	13		GALGHI	929 1974/78, 121, Capella Cosmo, Luce, 616 1975/78	1769cc.	VC (SOHC) 8V	972600-R
R971810P	1	 GUÍA VÁLVULAS (8) R971810V/1	8	13.76	14.55		RGV	626, Capella, E1800 1982/87	1789cc.	F8 (SOHC) 8V	971800-RMX
R900912P	1	 DISTRIBUCIÓN	34	48	7		GALGHD				
R900913P	1	 ÁRBOL DE LEVAS	30	44	7		GALGHD	Anfini M6, Cronos 1991/... MX-3 1992/99	1845cc.	K8 (DOHC) V6 24V	973000-R
R520812P	1	 DISTRIBUCIÓN	48	68	11		GALGHD	Pick Up 1971/...	1985cc.	VA (OHV) 8V	973100-R
R970311P	1	 BANCADA	80	105	13		GALGHI	626, 929, B2000, Capella Cosmo 1978/80	1970cc.	MA (SOHC) 8V	972700-R
R900913P	1	 ÁRBOL DE LEVAS	30	44	7		GALGHD	Xedos 6 1991/97, Afini Cronos 1994/97, 323 1994/99	1995cc.	KF (DOHC) V6 24V	973300-R MLS
R900900	1	 KIT DE RETENES					JUEGO	626TD 1993/97, 323D 1998/...	1998cc.	RF - CX 8V DIESEL	910100-R

CATALOGO DE RETENES

CATALOGO DE RETENTORES - OIL SEAL CATALOG



MAZDA

Código Code	Cant. Qty	Descripción Descrição Descrição	DE [mm]	DA [mm]	H [mm]	A [mm]		Aplicación Aplicação Application	Cm³ Cm³	Motor Motor Engine	Jgo. Juntas Set Gaskets
R900910P	1	 GUÍA VÁLVULAS (8) R900910P/1	7	13.9	14.5		RGV	626TD 1993/97, 323D 1998/...	1998cc.	RF - CX 8V DIESEL	910100-R 900900-R
R460211V	1	 BANCADA	90	110	7		GALGRI				
R900912P	1	 DISTRIBUCIÓN	34	48	7		GALGHD				
R900913P	1	 ÁRBOL DE LEVAS	30	44	7		GALGHD				
R971810P	1	 GUÍA VÁLVULAS (8) R971810V/1	6.98	13.76	14.55		RGV	626, Capella, E2000 1982/87 B2000 1985/88 - 1991/96	1998cc.	FE (SOHC) 8V	971800-RMX
R900912P	1	 DISTRIBUCIÓN	34	48	7		GALGHD				
R900912P	1	 DISTRIBUCIÓN	34	48	7		GALGHD	626 1986/92 - 929 1987/... 926, 929 1986/...	1998cc. 1998cc.	FE (SOHC) 12V FE (SOHC) 12V	973400-R 973600-R
R900912P	1	 DISTRIBUCIÓN	34	48	7		GALGHD	323D 1998/...	1998cc.	RF (SOHC) 8V DIESEL	973500-R MLS
R900913P	1	 ÁRBOL DE LEVAS	30	44	7		GALGHD				
R900913P	1	 ÁRBOL DE LEVAS	30	44	7		GALGHD				
R900913P	1	 ÁRBOL DE LEVAS	30	44	7		GALGHD	626TD 1993/97, 323D 1998/...	1998cc.	RF - CX 8V	910100-R
R302010V	1	 GUÍA VÁLVULAS (16) R302010V/1	5.5	11	18	25	RGV	Mazda 6 2002/... Mazda 6 2002/... Mazda 3 2003/...	1999cc. 1999cc.	LF (DOHC) 16V LF (DOHC) 16V	302200-R 302400-R
PR302211T	1	 PORTA BANCADA	88				PORTA				
R302212V	1	 ÁRBOL DE LEVAS	37	50	8		GALGHD				
R900900	1	 KIT DE RETENES					JUEGO	E 2200 1984/86, B 2200 1985/87	2184cc.	R2 DIESEL	900900-R
R900910P	1	 GUÍA VÁLVULAS (8) R900910P/1	7	13.9	14.5		RGV				
R460211V	1	 BANCADA	90	110	7		GALGRI				
R900912P	1	 DISTRIBUCIÓN	34	48	7		GALGHD				
R900913P	1	 ÁRBOL DE LEVAS	30	44	7		GALGHD				
R900912P	2	 DISTRIBUCIÓN	34	48	7		GALGHD				
R900811S	1	 BANCADA	101.57	125	13		GALGHI	Pick Up, B2200, Luce 1979/...	2209cc.	S2 (SOHC) 8V DIESEL	973700-R
R302010V	1	 GUÍA VÁLVULAS (16) R302010V/1	5.5	11	18	25	RGV	Mazda 6 - MPV 2002/...	2261cc.	L3 (DOHC) 16V	302200-R
PR302211T	1	 PORTA BANCADA	88				PORTA				
R302212V	1	 ÁRBOL DE LEVAS	37	50	8		GALGHD				
R900811S	1	 BANCADA	101.57	125	13		GALGHI	Camión, Pick Up T2500 Autoelevador Yale 1980/... Pick Up, Camión T3000 1985/... Autoelevador Yale 1984/...	2522cc.	XA/XB/S5/WE5 8V DIESEL HA/WEF 8V DIESEL	971100-R
R900812P	1	 DISTRIBUCIÓN	51	70	11		GALGHD		2977cc.		971200-R

MAZDA

Código Code	Cant. Qty	Descripción Descripción	DE [mm]	DA [mm]	H [mm]	A [mm]		Aplicación Aplicação Application	Cm³ Cm³	Motor Motor Engine	Jgo. Juntas Set Gaskets
R900811S	1	 BANCADA	101.57	125	13		GALGHI	Truck T3000 1981/84 Truck E3000 1978/81 Truck T3500 1984/... Truck T3500 1984/...	2977cc. 2977cc. 3455cc. 3455cc.	HA 8V DIESEL HA 8V DIESEL SL (OHV) 8V DIESEL SL-T (OHV) 8V DIESEL	974100-R 974200-R 974300-R 974400-R MLS









MERCEDES BENZ

R351111V	1	 BANCADA	93	114	13		GALGHI	190E 1990/93	1797cc.	MB102.910/919 (SOHC) 8V	351700-R
R351112V	1	 DISTRIBUCIÓN	45	67	8		GALGHD	190 1982/84, 190E 1985/93 200 1984/93 E200D, C200D, 200D/TD 1984/93	1996cc. 1997cc.	MB102.921/962/922 (SOHC) 8V MB601.911/912/913 (SOHC) 8V	351700-R 360500-R
R360112P	1	 DISTRIBUCIÓN	45	74.5	12 14.5	79.5	E-RD	L307/200D/N1300/MB90 L307/MB100/L406D/L408D 0309D/306D/306DG/200D L206/D61	1988cc.	OM 615 (SOHC) 8V	351600-R
360158	1	 EMPAQUETADURA CIGÜEÑAL									
R351210V	1	 GUÍA VÁLVULAS (16) R260610V/1	7	9.8	10		RGV	E200, C220 CDI 2002/... CLC200/220 CDI 2005/... Viano CDI 2003/... C220 CDI 2004/...	2148cc.	OM 646.951 646.962/963 646.966/963/982/983 (DOHC) 16V	353201-R
PR351211T	1	 PORTA BANCADA	93				PORTA	Sprinter 413 CDI 2000/... C200 CDI 1998/... Vito 108/110/112 CDI, Sprinter 208/211/213 CDI	2151cc.	OM 611 CDI 611.960/961 611.980 (DOHC) 16V	351201-R
R351112V	1	 DISTRIBUCIÓN	45	67	8		GALGHD				
R351111V	1	 BANCADA	93	114	13		GALGHI	190D 1984/...	2197cc.	MB601.921 (SOHC) 8V	360500-R
R351112V	1	 DISTRIBUCIÓN	45	67	8		GALGHD				
R360112P	1	 DISTRIBUCIÓN	45	74.5	12 14.5	79.5	E-RD	240D/TD 1973/..., 207/307 407/507/510D, L406/407DG 0309D 1977/... 240GD 1976/87, MB100/200 300/400/180D/150/170	2404cc.	OM 616.912/934/960 916/940/961/963 (SOHC) 8V	360100-R
360158	1	 EMPAQUETADURA BANCADA (2)					JUEGO				
R430010V R430010VM/1 R430010VM/2	1	 GUÍA VÁLVULAS (8) A GRANEL (200) A GRANEL (200)	8	12	9.5	15.2	RGV	Sprinter TDI 1997/...	2495cc.	Maxion	430001-R
PR430011V PR430011VF	1	 PORTA BANCADA	99.5				PORTA				
R430012V	1	 DISTRIBUCIÓN	57	71	9		GALGRD				
R430013V	1	 ÁRBOL DE LEVAS	46.7	62	9		GALGHD				
R430015N	1	 GUARDAPOLVO CORREA DISTRIB.	57.5	74	8		GASRLG				
430058	2	 EMPAQUETADURA CIGÜEÑAL									
R352410V	1	 GUÍA VÁLVULAS (20) R260610V/1	7	9.8	10		RGV	E270 CDI, ML270 CDI CLK270CDI, C270 CDI/G270 CDI, Sprinter CDI 1999/... - 2002/... C30 CDI AMG 2002/...	2685cc.	OM612.961/962/963 965/967/981 (DOHC) 20V	352401-R
PR351211T	1	 PORTA BANCADA	93				PORTA		2950cc.	OM 612.990 (DOHC) 20V	352401-R
R351112V	1	 DISTRIBUCIÓN	45	67	8		GALGHD				
R230710V	1	 GUÍA VÁLVULAS (12) R260610V/1	7	9.8	10		RGV	V280 1998/...	2792cc.	MB140.900 (DOHC) V6 12V	230700-R
R220411P R220411P/1 R220411V R220411VF	1	 BANCADA	85	105	12		GALGRI				

























CATALOGO DE RETENES

CATALOGO DE RETENTORES - OIL SEAL CATALOG

MERCEDES BENZ

Código Code	Cant. Qty	Descripción Descrição Descrição	DE [mm]	DA [mm]	H [mm]	A [mm]		Aplicación Aplicação Application	Cm³ Cm³	Motor Motor Engine	Jgo. Juntas Set Gaskets
R240013P R240013P/1 R240013V	1	 DISTRIBUCIÓN	35	48	7		GALGHD	V280 1998/...	2792cc.	MB140.900 (DOHC) V6 12V	230700-R
R351110V	1	 GUÍA VÁLVULAS (5) GUÍA VÁLVULAS (5)	7.1 8.1	11.65 11.65	10.6 10.6		RGV	Sprinter T1N 1995/99 290 TD, E290 GTD 1994/... 210D/310D/410D/G290 290GD 1992/...	2874cc. 2874cc.	OM 602.980/982/983 (SOHC) 10V MB602.940/942/947 (SOHC) 10V	351100-R 351300-R
R351111V	1	 BANCADA	93	114	13		GALGHI				
R351112V	1	 DISTRIBUCIÓN	45	67	8		GALGHD				
R351155V	1	 RUEDA TRASERA	95	115	13		GALG-BI				
R351111V	1	 BANCADA	93	114	13		GALGHI	300 Turbo 1985/93 E300 Turbo 1993/96 300GD 1989/93	2996cc.	OM603.931/950/960 963 (SOHC) 12V	351500-R
R351112V	1	 DISTRIBUCIÓN	45	67	8		GALGHD				
R360112P	1	 DISTRIBUCIÓN	45	74.5	12 14.5	79.5	E-RD	300 GD, 300 GD (4 x 4) 209D/309D/ 409D/240D 300D/CD/TD 1974/89	2998cc.	OM 617.910/913/931 932 (SOHC) 10V DIESEL	351800-R
360158	1	 EMPAQUETADURA BANCADA (2)					JUEGO				
R350110P	1	 GUÍA VÁLVULAS (8) R350110P/1	9	15.04	15.4		RGV	MB L608 D/Unimog 1966/... 711D/811D/609D/614D/709D 809D, OM364 Aspirado 1987/...	3786cc. 3971cc.	OM 314 (OHV) 8V OM 364 (OHV) 8V DIESEL	350100-R 350800-R
R350212S	1	 DISTRIBUCIÓN	65	90	15		G1LGHD				
350458	1	 EMPAQUETADURA BANCADA (2)					JUEGO				
R351010V	1	 GUÍA VÁLVULAS (12) R430010V/1	8	12	9.5	15.2	RGV	Vario 614/814/815/810 Atego 712/714/715/717/812 814/815/817/917/1017/1214 1215/1217/1317/1517	4250cc.	OM 904 LA OM 904 LA IMO Electronico (OHV) 12V DIESEL	351000-R
R351012P R351012VF	1	 DISTRIBUCIÓN	78	104	11		GASRRD C/F				
R350212S	1	 DISTRIBUCIÓN	65	90	15		G1LGHD	MB 3500, L3250/L3500 1949/52	4580cc.	L911 OM311/312 DIESEL	350000-R
350458	1	 EMPAQUETADURA BANCADA (2)					JUEGO				
R350210P	1	 GUÍA VÁLVULAS (6) GUÍA VÁLVULAS (6)	9 9.9	15.04 15.04	15.4 15.4		RGV	MB 1112/1114/0140/L1112 L1514 1957/...	5100cc.	OM 321 (SOHC) 12V DIESEL	350200-R
R350210-2P	1	 GUÍA VÁLVULAS (12) R350110-1P/1	9	15	15		RGV				
R350212S	1	 DISTRIBUCIÓN	65	90	15		G1LGHD				
R350255N	1	 RUEDA TRASERA	110	140	13		G2LG				
R350258N	1	 RUEDA DELANTERA	95	130	13		G2LG				
350458	1	 EMPAQUETADURA BANCADA (2)					JUEGO				
R350210-2P	1	 GUÍA VÁLVULAS (12) R350110-1P/1	9	15	15		RGV	MB 1114, 0140 1972/... OM 352 Turbinado 1981/... OM 352 Aspirado 1981/...	5675cc.	OM 352 (OHV) 12V DIESEL	350300-R 350301-R
R350211-1S	1	 BANCADA	90	106	7.5		EXPAN				
R350212S	1	 DISTRIBUCIÓN	65	90	15		G1LGHD				







MERCEDES BENZ

Código Code	Cant. Qty	Descripción Descrição Descrição	DE [mm]	DA [mm]	H [mm]	A [mm]		Aplicación Aplicação Aplicacion	Cm³ Cm³	Motor Motor Engine	Jgo. Juntas Set Gaskets
R350315N	1	 BOMBA INYECTORA	26	45	10		G1	MB 1114, 0140 1972/... OM 352 Turbinado 1981/... OM 352 Aspirado 1981/...	5675cc.	OM 352 (OHV) 12V DIESEL	350300-R 350301-R
350358	1	 EMPAQUETADURA BANCADA (2)					JUEGO				
350458	1	 EMPAQUETADURA BANCADA (2)					JUEGO				
R350210-2P	1	 GUÍA VÁLVULAS (12) R350110-1P/1	9	15	15		RGV	MB 1517 Turbo 0170, L911 L1518 1978/...	5675cc.	OM 352A (OHV) 12V DIESEL	350400-R 350401-R
R350211-1S	1	 BANCADA	90	106	7.5		EXPAN				
R350212S	1	 DISTRIBUCIÓN	65	90	15		G1LGHD				
R350455N	1	 RUEDA TRASERA	120	145	15		G2LG				
R350458N	1	 RUEDA DELANTERA	100	120	13		G2LG				
350458	1	 EMPAQUETADURA BANCADA (2)						JUEGO			
R350210P	1	 GUÍA VÁLVULAS (6) GUÍA VÁLVULAS (6)	9 9.9	15.04 15.04	15.4 15.4		RGV	MB 1518 desde 1991/... Motor Híbrido. (Con junta tapa lateral de goma)	5765cc.	OM 352 OM 352A Turbo (OHV) 12V DIESEL	352200-R
R350212S	1	 DISTRIBUCIÓN	65	90	15		G1LGHD				
350458	1	 EMPAQUETADURA BANCADA (2)					JUEGO				
R350210P	1	 GUÍA VÁLVULAS (6) GUÍA VÁLVULAS (6)	9 9.9	15.04 15.04	15.4 15.4		RGV	OH1215/1315/1316/1319 1320/1420/1615 Aspirado Turbo 1620 OHL1621/OS1318 L1915/1314/1318/1365 2018/3611R/2214/2217	5957cc.	OM 366 1 OM 366A/LA Euro Ecológico DIESEL	350900-R 350901-R
R350212S	1	 DISTRIBUCIÓN	65	90	15		G1LGHD				
R350958N	1	 RUEDA TRASERA	100	125	12		G1A-BI				
350458	1	 EMPAQUETADURA BANCADA (2)						JUEGO			
R352010V	1	 GUÍA VÁLVULAS (8) R430010V/1	8	12	9.5	15.2	RGV	Atego 925/1225/1228/1325 1328/1525/1528/1823/1828 2523/2528/2628 1998/...	6370cc.	OM906 LA Electrónico OM906.911/919/920 921/922/923 (OHV) 18V DIESEL	352000-R
R351012P R351012VF	1	 DISTRIBUCIÓN	78	104	11		GASRRD C/F				
R350610P	1	 GUÍA VÁLVULAS (20) R350110P/1	9	15.04	15.4		RGV	MB 1521/1526 1985/87	9650cc.	OM 355-5 (OHV) 20V DIESEL	350600-R
R350612S	1	 DISTRIBUCIÓN	75	100	12		G1LGHDI				
R360011V	1	 BANCADA	120	140	13		G1ALGRI	1630/1632/1633, MB485.980 MB489.960/961 MB475.907/950 MB954/976/979/982/984 986/989/991/994/997/998	9973cc.	OM449A/LA HLA 5 cilindros (OHV) 10V DIESEL	360000-R 360001-R
R360012V	1	 DISTRIBUCIÓN	105	130	12		G1ALGRD				
R360057N	1	 PIÑÓN DIFERENCIAL INTERIOR	68	85	16		GALG				
R360410P	1	 GUÍA VÁLVULAS (24) R350110P/1	9	15.04	15.4		RGV	0371, Bus 1926 1985/...	11580cc.	OM 355-6 DIESEL	360400-R
R350612S	1	 DISTRIBUCIÓN	75	100	12		G1LGHDI				

CATALOGO DE RETENES

CATALOGO DE RETENTORES - OIL SEAL CATALOG















MERCEDES BENZ

Código Code	Cant. Qty	Descripción Descrição Descrição	DE [mm]	DA [mm]	H [mm]	A [mm]		Aplicación Aplicação Aplicacion	Cm³ Cm³	Motor Motor Engine	Jgo. Juntas Set Gaskets
350458	1	 EMPAQUETADURA BANCADA (2)					JUEGO	0371, Bus 1926 1985/...	11580cc.	OM 355-6 DIESEL	360400-R
R360010P R360010V	1	 GUÍA VÁLVULAS (12) R360010V/1	12	16	15.7		RGV	O372/O400/L1395/1939/1941 1973/...	11967cc.	OM 447-6 (OHV) 12V DIESEL	360300-R 360301-R
R360011V	1	 BANCADA	120	140	13		G1ALGRI				
R360012V	1	 DISTRIBUCIÓN	105	130	12		G1ALGRD				
R360811V	1	 BANCADA	113	140	12		GALGRI	OM457LA/LAIII/HLA/HLA III, OM457.933/938/940/944/949, OM458.960/970/980/938CAM, O400BUS Camión LS1938, LK/LS/L2638, Axor 2035/40/44 2540/44, 2640/44, 3340/44 4140/44	11967cc.	OM457 Electrónico 252 - 456PS (OHV) 24V DIESEL	360800-R
R360812V	1	 DISTRIBUCIÓN	100	130	11		GALGRD				

























MINI

R981310P	1	 GUÍA VÁLVULAS (16) R981310P/1	6	11.4	18		RGV	One Coupe (Mini R50) Cooper Coupe (Mini R50) 2000/01	1598cc.	W10B16A	981300-R
R981312P	1	 DISTRIBUCIÓN	32	45	6						

MITSUBISHI

R950710P	1	 GUÍA VÁLVULAS (4) R950710P/1	7	12	11		RGV	L100, Minicab 1977/83	550cc.	2G 23	950700
R950711P	1	 BANCADA	60	78	10		GALGHI				
R950712N	1	 DISTRIBUCIÓN	35	50	8						
R990011P	1	 BANCADA	60	75	8		GALGHI	Varica 1100 1988/...	1062cc.	4G82 (SOHC) 8V	962300-R
R950310P	1	 GUÍA VÁLVULAS (8) R950310P/1	8	12.9	13.75		RGV	Lancer 1977/78 Lancer, Celeste 1977/... L300 1980/81	1238cc. 1439cc.	4G36 (SOHC) 8V 4G33 (SOHC) 8V	950300-R 950300-R
R950311P	1	 BANCADA	72	96	9		GALGRI				
R950312P R950312S	1	 DISTRIBUCIÓN	44	60	7		GALGHD				
R910613P	1	 ÁRBOL DE LEVAS	32	46	6		GALGHD				
R950311P	1	 BANCADA	72	96	9		GALGRI	Colt, Lancer 1977/... Mirage 1979/83 Colt, Lancer, Mirage 1990/96 Colt 1978/86, Lancer 1978/84	1244cc.	4G11B (SOHC) 8V	961900-R
R950512P R950512N	1	 DISTRIBUCIÓN	30	46	8		GALGHD		1299cc.	4G13 (SOHC) 12V	962900-R
R950311P	1	 BANCADA	72	96	9		GALGRI	Galant 1969/70 - Colt 1969/71	1289cc.	4G30 (SOHC) 8V	962400-R
R950512P R950512N	1	 DISTRIBUCIÓN	30	46	8		GALGHD	Colt, Carisma 2001/04 Lancer 2001/08	1299cc.	4G13 (SOHC) 16V	962500-R MLS
R950311P	1	 BANCADA	72	96	9		GALGRI	Colt 1978/86, Lancer 1978/84 Tredia 1983/84	1414cc.	4G12B (SOHC) 8V	962700-R
R950512P R950512N	1	 DISTRIBUCIÓN	30	46	8		GALGHD				
R950311P	1	 BANCADA	72	96	9		GALGRI	Galant, Lancer, Colt 1970/75	1439cc.	4G33 (SOHC) 8V	962400-R

MITSUBISHI

Código Code	Cant. Qty	Descripción Descrição Descripción	DE [mm]	DA [mm]	H [mm]	A [mm]		Aplicación Aplicação Aplicacion	Cm³ Cm³	Motor Motor Engine	Jgo. Juntas Set Gaskets
R950311P	1	 BANCADA	72	96	9		GALGRI	Colt, Lancer, Mirage 1991/95 Proton 1990/... Lancer, Mirage 1993/...	1468cc. 1468cc.	4G15/4G15B (SOHC) 12V 4G15B (SOHC) 12V	962900-R 963000-R
R950512P R950512N	1	 DISTRIBUCIÓN	30	46	8		GALGHD				
R950512P R950512N	1	 DISTRIBUCIÓN	30	46	8		GALGHD	Lancer, Mirage 1993/... Lancer 1998/..., Space Star 1998/06	1468cc. 1584cc.	4G15B (SOHC) 12V 4G18 (SOHC) 16V	963000-R 963200-R MLS
R520811P	1	 BANCADA	80	96	9		GALGRI	Mirage 1991/92, Colt, Lancer 1988/89	1596cc.	4G61 (DOHC) 16V	963300-R
R950312P R950312S	1	 DISTRIBUCIÓN	44	60	7		GALGHD	Lancer, Mirage Turbo 1988/...	1596cc.	4G61T (DOHC) 16V	963300-R
R950310P	1	 GUÍA VÁLVULAS (8) R950310P/1	8	12.9	13.75		RGV	L200, Celeste A144 Lancer A174, Galant A161 1979/81	1597cc.	G32B (SOHC) 8V	950800
R950311P	1	 BANCADA	72	96	9		GALGRI				
R950312P R950312S	1	 DISTRIBUCIÓN	44	60	7		GALGHD				
R470013P R470013P/1 R470013V	1	 ÁRBOL DE LEVAS	35	50	7		GALG-BI				
R950312P R950312S	1	 DISTRIBUCIÓN	44	60	7		GALGHD	Lancer, Colt 1983/90 Mirage 1983/...	1795cc.	4D65 (SOHC) 8V DIESEL	961700-R
R520811P	1	 BANCADA	80	96	9		GALGRI	Galant, Eterna, Lancer Delica, Cordia 1980/84 Eterna, Sava 1989/...	1795cc. 1836cc.	4G62B (SOHC) 8V 4G67 (DOHC) 16V	963400-R 963600-R
R950312P R950312S	1	 DISTRIBUCIÓN	44	60	7		GALGHD	Colt, Lancer 1989/1992			
R520811P	1	 BANCADA	80	96	9		GALGRI	Galant, Colt 1975/77	1855cc.	4G15B/G51B (SOHC) 8V	963700-R
R520812P	1	 DISTRIBUCIÓN	48	68	11		GALGHD				
R560600	1	 KIT DE RETENES					KIT	Carisma TD 1997/...	1870cc.	F8QT (SOHC) 8V DIESEL	580901-R
R560110P R560110V	1	 GUÍA VÁLVULAS (8) R250410V/1	8	10.8	10		RGV				
R560111P R560111V	1	 BANCADA	85	105	8		GALGRI				
R550612P R550612V	1	 DISTRIBUCIÓN	50	68	10		GALGRD				
R560113P R560113P/1 R560113V	1	 ÁRBOL DE LEVAS	25	42	7		GALGHD				
R560114P R560114V	1	 AUXILIAR	25	45	7		GALGHI				
550658	1	 CIERRE BANCADA (4)					JUEGO				
R520811P	1	 BANCADA	80	96	9		GALGRI	Celeste, Sigma 1975/78 Galant, Colt 1976/78 Challenger, Sapporo 1977/78	1995cc.	4G52/G52B (SOHC) 8V	963700-R
R520812P	1	 DISTRIBUCIÓN	48	68	11		GALGHD				
R520811P	1	 BANCADA	80	96	9		GALGRI	Sapporo, Super Touring, Super Saloon, Galant L200 L300 1980/93	1997cc.	G63B (SOHC) 8V	950600

CATALOGO DE RETENES

CATALOGO DE RETENTORES - OIL SEAL CATALOG













MITSUBISHI

Código Code	Cant. Qty	Descripción Descrição Descripción	DE [mm]	DA [mm]	H [mm]	A [mm]		Aplicación Aplicação Aplicacion	Cm³ Cm³	Motor Motor Engine	Jgo. Juntas Set Gaskets
R950611P	1	 BANCADA	80	96	9		GALGRI	Sapporo, Super Touring, Super Saloon, Galant L200 L300 1980/93	1997cc.	G63B (SOHC) 8V	950600
R950312P R950312S	1	 DISTRIBUCIÓN	44	60	7		GALGHD				
R470013P R470013P/1 R470013V	1	 DISTRIBUCIÓN	35	50	7		GALG-BI				
R520811P	1	 BANCADA	80	96	9		GALGRI	Eterna, Sava, Colt, Mirage 1989/..., Galant 1987/92 Eclipse 1989/92	1997cc.	4G63/4G63BK/4G63T (DOHC) 16V	964000-R
R950312P R950312S	1	 DISTRIBUCIÓN	44	60	7		GALGHD				
R950312P R950312S	1	 DISTRIBUCIÓN	44	60	7		GALGHD	Galant, Freeca 1998/..., Space Runner GDI 1999/...	1997cc.	4G63 (SOHC) 16V	963800-R MLS
								Galant, Freeca 1998/..., Outlander, Lancer 2003/...	1997cc.	4G63 (DOHC) 16V	963900-R MLS
								Tractor, Autoelevador	1997cc.	4G63 (SOHC) 8V	964100-R
R950312P R950312S	1	 DISTRIBUCIÓN	44	60	7		GALGHD	Lancer D/TD 1992/97 Galant D/TD 1992/...	1998cc.	4D68/T (SOHC) 8V DIESEL	961300-R
R270111V	1	 BANCADA	90	115	13		GALGHI	Tractor, Canter	2084cc.	4DQ5 8V	964200-R
R520811P	1	 BANCADA	80	96	9		GALGRI	Canter, L200, L300, Montero Pajero 1982/86 Pajero, Montero 1986/... Canter T35 1987/98, L 200 1987/...	2346cc.	4D55T (SOHC) 8V DIESEL	910500-R
R950312P R950312S	1	 DISTRIBUCIÓN	44	60	7		GALGHD		2476cc.		
R470013P R470013P/1 R470013V	1	 DISTRIBUCIÓN	35	50	7		GALG-BI				
R250156N	1	 AUXILIAR	25	35	7		GA				
R520811P	1	 BANCADA	80	96	9		GALGRI	Galant, Wagon 1985/92 L200, L300 1989/... Pick Up 1990/92	2350cc.	4G64B (SOHC) 8V	964500-R
R950312P R950312S	1	 DISTRIBUCIÓN	44	60	7		GALGHD				
R950312P R950312S	1	 DISTRIBUCIÓN	44	60	7		GALGHD	Galant 1993/... Fortis, Zinger, Fuzion 2005/07	2350cc. 2351cc.	4G64BK (DOHC) 16V 4G64 (SOHC) 16V	964400-R 964600-R MLS
R520811P	1	 BANCADA	80	96	9		GALGRI	L200, Pajero, Montero Nativa 2001/...	2476cc.	4D56T (SOHC) 8V DIESEL	910700-R
R950312P R950312S	1	 DISTRIBUCIÓN	44	60	7		GALGHD				
R470013P R470013P/1 R470013V	1	 DISTRIBUCIÓN	35	50	7		GALG-BI				
R270111V	1	 BANCADA	90	115	13		GALGHI	Tractor, Autoelevador	2477cc.	S4E 8V DIESEL	964700-R
R520811P	1	 BANCADA	80	96	9		GALGRI	Sapporo, Galant, Eterna Colt 1978/80, Galant 1982/...	2555cc.	4G54B (SOHC) 8V 4G54B (SOHC) 8V	964800-R 964900-R
R520812P	1	 DISTRIBUCIÓN	48	68	11		GALGHD				
R900012P R900012N	1	 DISTRIBUCIÓN	48	70	9		GALGHD	Canter Serie FB3 1985/93 Truck 2.8 Serie FB308 1985/89	2659cc. 2800cc.	4DR51 (SOHC) 8V DIESEL	965100-R MLS
R270111V	1	 BANCADA	90	115	13		GALGHI	Tractor, Autoelevador Tractor, Autoelevador Tractor, Autoelevador Tractor, Autoelevador	2960cc. 3331cc. 3900cc. 4996cc.	S4E2 8V DIESEL S4S 8V DIESEL S6E 12V DIESEL S6S 12V DIESEL	965200-R 965300-R MLS 965400-R 965700-R MLS

CATALOGO DE RETENES

CATALOGO DE RETENTORES - OIL SEAL CATALOG



MWM

Código Code	Cant. Qty	Descripción Descrição Descrição	DE [mm]	DA [mm]	H [mm]	A [mm]		Aplicación Aplicação Aplicacion	Cm³ Cm³	Motor Motor Engine	Jgo. Juntas Set Gaskets	
R310411P R310411V	1	 BANCADA	110	130	13		GALGHI	Tractor 65ID, Valmet 62ID 1970/76	2550cc.	D225-3 DIESEL	320800-R 320800	
R310412P R310412V	1	 DISTRIBUCIÓN	78	100	13		GALGHD					
R330510V	1	 GUÍA VÁLVULAS (12) R310810V/1	7	10.9	9.5		RGV	Agrale TD, Micro, Buses 2000/... Blazer, S10 2000/..., LT TDI Electronico 2002/06	2796cc.	MWM 4.07 CA DIESEL	330500-R	
R330511V	1	 BANCADA	91	111	10		G1ALGRI		2796cc.		Sprint 4,07 TCA Common Rail (SOHC) 12V DIESEL	331100-R MLS
R250811P R250811V R250811N	1	 DISTRIBUCIÓN	64	80	8		G1ALGHD					
R310411P R310411V	1	 BANCADA	110	130	13		GALGHI	Camión TX 1600 1983/... Autoelevador, E300 Tractor 68 1983/... Cilindro Vibratorio CHF 44 1983/...	2942cc.	D229-3 (SOHC) 6V DIESEL	330800-R	
R310412P R310412V	1	 DISTRIBUCIÓN	78	100	13		GALGHD					
R310410V	1	 GUÍA VÁLVULAS (8) R310410V/1	9	13.4	11		RGV	850E Tractor 85ID 1970/76 F100 1993/95, F1000 1994/96 F4000 1992/93, F2000 1980/... FB4000 1985/... Escavadora FB80	2977cc.	D225-4 DIESEL D225-4 DIESEL D229-4 (SOHC) 8V DIESEL	440000 440000 310400-R	
R310411P R310411V	1	 BANCADA	110	130	13		GALGHI		3400cc.		440000	
R310412P R310412V	1	 DISTRIBUCIÓN	78	100	13		GALGHD		3922cc.		310400-R	
R310458N	1	 RUEDA DELANTERA	58.95	76	9		G1SRLG	F100, F1000, F4000 1992/96 F2000 1980/..., FB4000 1985/... Escavadora FB80	3922cc.	D229-4 (SOHC) 8V DIESEL	310400-R	
R310410V	1	 GUÍA VÁLVULAS (8) R310410V/1	9	13.4	11		RGV	Tractor 86-ID Camión F4000 1986/... Tractor 85 1986/...	4156cc.	D226-4 (OHV) 8V DIESEL	320400-R 320400	
R310411P R310411V	1	 BANCADA	110	130	13		GALGHI					
R310412P R310412V	1	 DISTRIBUCIÓN	78	100	13		GALGHD					
R330610V	1	 GUÍA VÁLVULAS (18) R310810V/1	6	10.6	9.5		RGV	GM Silverado 3500HD 1997/..., Grand Blazer 1998/... F100 GMC Turbo 1999/...	4200cc.	Sprint 6.07 TD Turbo Intercooler (SOHC) 18V DIESEL	330600-R	
R330511V	1	 BANCADA	91	111	10		G1ALGRI					
R250811P R250811V R250811N	1	 DISTRIBUCIÓN	64	80	8		G1ALGHD					
R310410V	1	 GUÍA VÁLVULAS (8) R310410V/1	9	13.4	11		RGV	7000/7500/8500 - Euro I/II/III 7100/8120/8140/8150/13150 Agrale 8500/9200 Constellation 13.180E/15.180E	4300cc.	4.10 X10 - 4.10T/TCA DIESEL 4.12TCE (OHV) 8V Common Rail DIESEL	330400-R	
R330411V	1	 BANCADA	130	160	12		G1ALGRI		4800cc.		331200-R MLS	
R310412P R310412V	1	 DISTRIBUCIÓN	78	100	13		GALGHD					
R310510V	1	 GUÍA VÁLVULAS (12) R310410V/1	9	13.4	11		RGV	Camión 1978/... Tractor AD7B, 980E, S90 Tractor Valmet 110 ID F14000/F4000 1994/96 Cargo, F12000/14000 1985/... Tractor S90, FE105, FA120 FE105B	5100cc.	D225-6 DIESEL	440100	
R310411P R310411V	1	 BANCADA	110	130	13		GALGHI		5883cc.		D229-6 Turbo DIESEL	310500-R
R310412P R310412V	1	 DISTRIBUCIÓN	78	100	13		GALGHD					
R330710V	1	 GUÍA VÁLVULAS (12) R310410V/1	9	13.4	11		RGV	13180/15180/16210 F14000 1995/98, Euro I/II 26.260E/31.260E/17.260EOT 17.210EOD, VM210/260/310	6450cc. 7118cc.	6.10 X10 - 6.10T/TCA DIESEL 6.12 TCE (OHV) 12V Common Rail DIESEL	330700-R 331300-R MLS	

CATALOGO DE RETENES

CATALOGO DE RETENTORES - OIL SEAL CATALOG







MWM

Código Code	Cant. Qty	Descripción Descrição Descrição	DE [mm]	DA [mm]	H [mm]	A [mm]		Aplicación Aplicação Application	Cm³ Cm³	Motor Motor Engine	Jgo. Juntas Set Gaskets
R330411V	1	 BANCADA	130	160	12		G1ALGRI	13180/15180/16210 F14000 1995/98, Euro I/II 26.260E/31.260E/17.260EOT 17.210EOD, VM210/260/310	6450cc. 7118cc.	6.10 X10 - 6.10T/TCA DIESEL 6.12 TCE (OHV) 12V Common Rail DIESEL	330700-R 331300-R MLS
R310412P R310412V	1	 DISTRIBUCIÓN	78	100	13		GALGHD				

NISSAN

R581710V	1	 GUÍA VÁLVULAS (16) R581710V/1	5	8.2	7.85		RGV	March 2012/...	1149cc.	D4F Hi-Flex	581700-R MLS
R570511V	1	 BANCADA	70	86	8		GALGHI				
R570512V	1	 DISTRIBUCIÓN	32	44	6		GALGHD				
R580013V	1	 ÁRBOL DE LEVAS	28	47	5.5		GALGHD				
R902111P	1	 BANCADA	84	104	11		GALGRI	Sunny 1990/..., Sentra 1993/... Sunny 1990/95 Almera 1995/00, Sunny 1995/...	1295cc. 1392cc. 1392cc.	GA13DS (DOHC) 16V GA14DS (DOHC) 16V GA14DE (DOHC) 16V	901600-R 901700-R 904100-R
R420613P	1	 DISTRIBUCIÓN	40	52	7		GALGHD				
R902610P	1	 GUÍA VÁLVULAS (8) R902610P/1	8	14	20		RGV	Datsun Sedan, Estaquitas Guayin, Pick Up 1970/84	1483cc.	J15 (OHV) 8V	902600-RMX
R340112V R340112V/1	1	 DISTRIBUCIÓN	39.95	62	7.4		GALGHD				
R920010P	1	 GUÍA VÁLVULAS (8) R920010V/1	7	12	12		RGV	Samuray, Sedan, Ninja Guayin 1984/94 Sentra, Tsuru 1984/94	1487cc. 1597cc.	E15 (SOHC) 8V E16 (SOHC) 8V	920000-R 920000-R
R250211P R250211N	1	 BANCADA	80	100	10		GALGHI				
R920012P	1	 DISTRIBUCIÓN	36	49	7		GALGD				
R920013P	1	 ÁRBOL DE LEVAS	40	55	9		GALGHD				
R920014P	1	 AUXILIAR	32	50	8		GALGHD				
R460700	1	 KIT DE RETENES					JUEGO	Micra 1997/...	1527cc.	TUD5 (VJZ) (SOHC) 8V DIESEL	470300-R
R460710V R460710P	1	 GUÍA VÁLVULAS (8) R260610V/1	7	9.8	10		RGV				
R560111P R560111V	1	 BANCADA	85	105	8		GALGRI				
R460712V	1	 DISTRIBUCIÓN	42	66	8		GALGHD				
R460213P R460213V	1	 ÁRBOL DE LEVAS	36	50	8		GALGHD				
R902610P	1	 GUÍA VÁLVULAS (8) R902610P/1	8	14	20		RGV	Datsun Sedan, Estaquitas Guayin, Pick Up 1970/84	1567cc.	J16 (OHV) 8V	902600-RMX
R340112V R340112V/1	1	 DISTRIBUCIÓN	39.95	62	7.4		GALGHD				
R902110P	1	 GUÍA VÁLVULAS (16) R902110V/1	5	9.4	10.9		RGV	Sentra 1991/94, Tsubame Tsuru, Vanette Cargo 1993/97 Tsuru, Sentra 1997/06	1597cc. 1597cc.	GA16DE/DNE (DOHC) 16V GA16DNE (DOHC) 16V	902100-RMX 902900-R
R902111P	1	 BANCADA	84	104	11		GALGRI				









NISSAN

Código Code	Cant. Qty	Descripción Descrição Descripción	DE [mm]	DA [mm]	H [mm]	A [mm]		Aplicación Aplicação Aplicacion	Cm³ Cm³	Motor Motor Engine	Jgo. Juntas Set Gaskets
R420613P	1	 DISTRIBUCIÓN	40	52	7		GALGHD	Sentra 1991/94, Tsubame Tsuru, Vanette Cargo 1993/97 Tsuru, Sentra 1997/06	1597cc.	GA16DE/DNE (DOHC) 16V GA16DNE (DOHC) 16V	902100-RMX 902900-R
R902115P	4	 AUXILIAR	26	49	9.5/11		ESP		1597cc.		
R420613P	1	 DISTRIBUCIÓN	40	52	7		GALGHD	Sunny, Sentra, Primera 2000/... Sunny, Bluebird 1998/... Almera, Pulsar 2000/...	1597cc.	QG16DE (DOHC) 16V QG18DE (DOHC) 16V	903700-R MLS 903800-R MLS
R902110P	1	 GUÍA VÁLVULAS (16) R902110V/1	5	9.4	10.9		RGV		Tiida 2007/08, Liviana 2007/...		
R903411V	1	 BANCADA	84	117	8.5		GALGRI	Pick Up, Sacura, Estaquitas Ichi Van 1981/93 Samurai Guayin 1982/84	1800cc.	J18 8V Ø80.5	902200-R
R902512P	1	 DISTRIBUCIÓN	46	58	7		GALGHD				
R902210P	1	 GUÍA VÁLVULAS (8) R902210P/1	8	11.9	13.7		RGV				
R340112V R340112V/1	1	 DISTRIBUCIÓN	39.95	62	7.4		GALGHD	Bluebird Serie U13 1993/...	1838cc.	SR18DE (DOHC) 16V	904500-R
R902512P	1	 DISTRIBUCIÓN	46	58	7		GALGHD				
R900010P	1	 GUÍA VÁLVULAS (8) R900010V/1	7	10.7	12		RGV	Bluebird, Vanette 1980/84	1952cc.	LD20 (SOHC) 8V	900000-R
R550811P R550811PN/1 R550811V	1	 BANCADA	80	100	13		GARI				
R900012P R900012N	1	 DISTRIBUCIÓN	48	70	9		GALGHD				
R902111P	1	 BANCADA	84	104	11		GALGRI	Primera, Pulsar, Sunny 1991/96, Almera 1995/98	1974cc.	CD20 (SOHC) 8V DIESEL	904800-R MLS
R420613P	2	 DISTRIBUCIÓN	40	52	7		GALGHD				
R902111P	1	 BANCADA	84	104	11		GALGRI	Bluebird 1983/...	1974cc.	CD20 (SOHC) 8V	904700-R
R900912P	1	 DISTRIBUCIÓN	34	48	7		GALGHD				
R250211P R250211N	1	 BANCADA	80	100	10		GALGHI	Cedric 1979/83 Laurel 1985/...	1991cc. 1998cc.	SD20 (OHV) 8V RB20E (SOHC) 12V	905000-R 905200-R
R250211P R250211N	1	 BANCADA	80	100	10		GALGHI	Datsun Truck 1989/99 Atlas 1990/99 Caravan 1990/99	1998cc.	NA20 (SOHC) 8V	905100-R
R900012P R900012N	1	 DISTRIBUCIÓN	48	70	9		GALGHD	Cabstar, Homer, Clipper Pick UP 720, Cedric 1979/82	2164cc.	SD22 (OHV) 8V	905000-R
R250211P R250211N	1	 BANCADA	80	100	10		GALGHI				
R420613P	1	 DISTRIBUCIÓN	40	52	7		GALGHD	Vanette Cargo 1995/... Serena 1994/...	2283cc.	LD23 (SOHC) 8V	905500-R MLS
R902510P	1	 GUÍA VÁLVULAS (12) R902510-1P/1 (8) R902510-1P/2 (4)	6 7	10.7 11.8	11.9 12		RGV	Ichi Van 1991/94, Pick Up Terrano II, Van 1989/...	2389cc.	KA24E - KA24S (SOHC) 12V	902500-RMX
R250211P R250211N	1	 BANCADA	80	100	10		GALGHI				
R902512P	1	 DISTRIBUCIÓN	46	58	7		GALGHD				

























CATALOGO DE RETENES

CATALOGO DE RETENTORES - OIL SEAL CATALOG

NISSAN

Código Code	Cant. Qty	Descripción Descrição Descripción	DE [mm]	DA [mm]	H [mm]	A [mm]		Aplicación Aplicação Aplicacion	Cm³ Cm³	Motor Motor Engine	Jgo. Juntas Set Gaskets
R902310P	1	 GUÍA VÁLVULAS (8) R902310P/1	7	11	12.5		RGV	Vanette, Urvan, Chocolate 1987/...	2389cc.	Z24I (SOHC) 8V	902300-R
R902311P R902311S	1	 BANCADA	80	100	13		GALGHI				
R900012P R900012N	1	 DISTRIBUCIÓN	48	70	9		GALGHD				
R903610P	1	 GUÍA VÁLVULAS (16) R902510-1P/1	6	10.7	11.9		RGV	Urvan, Urvan 2000/03 King-Cab 2001/... X-Terra, Frontier, Altima 2000/01	2389cc.	KA24DE (DOHC) 16V	903600-R
R250211P R250211N	1	 BANCADA	80	100	10		GALGHI				
R902512P	1	 DISTRIBUCIÓN	46	58	7		GALGHD				
R900012P R900012N	1	 DISTRIBUCIÓN	48	70	9		GALGHD	Skyline, Blue Bird, Datsun 810 1977/83	2393cc.	L24E (SOHC) 12V	905700-R
R250211P R250211N	1	 BANCADA	80	100	10		GALGHI	Skyline 1985/...	2428cc.	RB24S (SOHC) 12V	905800-R
R900012P R900012N	1	 DISTRIBUCIÓN	48	70	9		GALGHD	Tractor, Autoelevador	2472cc.	H25 (DOHC) 8V	905900-R
R581810V	1	 GUÍA VÁLVULAS (16) R581810V/1	5	8.5	9.5		RGV	Primastar 2002/... Interstar 2002/...	2484cc. 2499cc.	G9U-730 DIESEL G9U-720/724/750/754 (DOHC) 16V DIESEL	581800-R 581800-R
R581811V	1	 BANCADA	93	108	7		GALGRI				
R581812V	1	 DISTRIBUCIÓN	60	75	7		GALGRD				
R581813V	1	 AUXILIAR DISTRIBUCIÓN	70	85	7		GALGRD				
R260113P R260113P/1 R260113V	1	 ÁRBOL DE LEVAS	30	42	7		GALGHD				
R900012P R900012N	1	 DISTRIBUCIÓN	48	70	9		GALGHD	Laurel, Cedric, Fairlady 1975/80, 280 Z 1979/80 Patrol 1980/...	2753cc.	L28S - L28E/L28ES (SOHC) 12V	906100-R
R900110P	1	 GUÍA VÁLVULAS (12) R900010P/1	7	10.7	12		RGV	Laurel, Cedric, Maxime, 810 280C 1980/...	2793cc.	LD28 (SOHC) 12V	900100-R
R550811P R550811PN/1 R550811V	1	 BANCADA	80	100	13		GARI				
R900012P R900012N	1	 DISTRIBUCIÓN	48	70	9		GALGHD				
R330510V	1	 GUÍA VÁLVULAS (12) R310810V/1	7	10.9	9.5		RGV	Frontier, X Terra 2003/06 Frontier TD Xterra Electrónico 2007/...	2796cc. 2796cc.	Sprint 4.07 CA DIESEL VW28TI (SOHC) 12V DIESEL	330500-R 331100-R MLS
R250811P R250811V R250811N	1	 DISTRIBUCIÓN	64	80	8		G1ALGHD				
R330511V	1	 BANCADA	91	111	10		G1ALGRI				
R250211P R250211N	1	 BANCADA	80	100	10		GALGHI	Laurel, Gloria 1985/89	2826cc.	RD28T (SOHC) 12V DIESEL	906200-R
R250211P R250211N	1	 BANCADA	80	100	10		GALGHI	Skyline, Patrol 1989/93	2962cc.	RB30S (SOHC) 12V	905800-R























PERKINS - MASSEY FERGUSON

Código Code	Cant. Qty	Descripción Descrição Descrição	DE [mm]	DA [mm]	H [mm]	A [mm]		Aplicación Aplicação Application	Cm³ Cm³	Motor Motor Engine	Jgo. Juntas Set Gaskets
R420610P	1	 GUÍA VÁLVULAS (8) R420610P/1	7.4	11.5	9		RGV	4.20 Marino D/TD 1986/..	1994cc.	Prima 65/80T DIESEL	420600-R
R420611P	1	 BANCADA	88.9	105	9.5		GARI				
R420612P	1	 DISTRIBUCIÓN	35	45	7		GALGHD				
R420613P	1	 ÁRBOL DE LEVAS TRASERO	40	52	7		GALGHD				
R420614P	1	 ÁRBOL DE LEVAS TRASERO	45	60	7		GALGHI				
R420410P	1	 GUÍA VÁLVULAS (6) R420410P/1	8.58	11.9	11.5		RGV	MF50/50X/55X/135/200/235 250, MF 135/515 MF50/50X/55X/135/200/235 250, MF 135/515	2360cc.	3.152 (OHV) 6V DIESEL	420400-R
R420112N	1	 DISTRIBUCIÓN	57.3	76.2	12.7		GALGRI				
R400213N	1	 ÁRBOL DE LEVAS	22.22	34.92	6.35		GA				
400158	1	 EMPAQUETADURA CIGÜEÑAL (2)					JUEGO				
R400510P	1	 GUÍA VÁLVULAS (6) R400010V/1	7.9	14	13.2		RGV	Tractor Viñatero MF50 Tractor, MF50X/55X MF135/200/235/250	2362cc. 2502cc.	P3 - 152 DIESEL P3 - 152 DIESEL	400500-R 410200-R
R400610P	1	 GUÍA VÁLVULAS (6) R300310V/1	7.9	15.5	12.5		RGV				
R400211P R400211V	1	 BANCADA	133.35	158.75	11/13		GALGRI				
R400012N R400012P R400012V	1	 DISTRIBUCIÓN	60.32	79.36	9.5		GALGHD				
400158	1	 EMPAQUETADURA CIGÜEÑAL (2)					JUEGO				
R300310P R300310PN/1	1	 GUÍA VÁLVULAS (8) BLISTER (200)	7.9	15.5	12.5		RGV				
R400010P R400010P/1	1	 GUÍA VÁLVULAS (8) BLISTER (200)	7.9	14	13.2		RGV				
R400211P R400211V	1	 BANCADA	133.35	158.75	11/13		GALGRI				
R420112N	1	 DISTRIBUCIÓN	57.3	76.2	12.7		GALGHD				
400158	1	 EMPAQUETADURA CIGÜEÑAL (2)					JUEGO				
R400000-1	1	 KIT DE RETENES					KIT	Tractor MF65X, MF40B/65 155/158/165/260/155/164C CBC1000 Pick Up, Camiónes livianos Tractor M165, 265 F100 Potenciado	3330cc.	D4.203/AD4.203 DIESEL	410500-R
R300310P R300310PN/1	1	 GUÍA VÁLVULAS (8) BLISTER (200)	7.9	15.5	12.5		RGV		3330cc. 3336cc. 3336cc.	T 4.33 Turbo DIESEL MF165 - 265 DIESEL 4.203 Potenciado (OHV) 8V DIESEL	410800-R 400700-R 410000-R
R400010P R400010P/1	1	 GUÍA VÁLVULAS (8) BLISTER (200)	7.9	14	13.2		RGV		3336cc.	MF265 Potenciado DIESEL	410300-R
R400211P R400211V	1	 BANCADA	133.35	158.75	11.13		GALGRI				
R400012N R400012P R400012V	1	 DISTRIBUCIÓN	60.32	79.36	9.5		GALGHD				
400158	1	 EMPAQUETADURA CIGÜEÑAL (2)					JUEGO				























CATALOGO DE RETENES

CATALOGO DE RETENTORES - OIL SEAL CATALOG

PERKINS - MASSEY FERGUSON

Código Code	Cant. Qty	Descripción Descrição Descrição	DE [mm]	DA [mm]	H [mm]	A [mm]		Aplicación Aplicação Aplicacion	Cm³ Cm³	Motor Motor Engine	Jgo. Juntas Set Gaskets
R400000	1	 KIT DE RETENES					KIT	D100/D200 1987/... F100, Falcon 1970/...	3336cc.	4.203-P4-192Z (OHV) 8V DIESEL	400000-R
R400000-1	1	 KIT DE RETENES					KIT				
R300310P R300310PN/1	1	 GUÍA VÁLVULAS (8) BLISTER (200)	7.9	15.5	12.5		RGV				
R400010P R400010P/1	1	 GUÍA VÁLVULAS (8) BLISTER (200)	7.9	14	13.2		RGV				
R400211P R400211V	1	 BANCADA	133.35	158.75	11/13		GALGRI				
R400012N R400012P R400012V	1	 DISTRIBUCIÓN	60.32	79.36	9.5		GALGHD				
400158	1	 EMPAQUETADURA BANCADA (2)					JUEGO				
R410510P	1	 GUÍA VÁLVULAS (8) R420410P/1	8.58	11.9	11.5		RGV	Tractor 8 BR	3336cc.	4.203 - 8 BR DIESEL	420100-R
R420112N	1	 DISTRIBUCIÓN	57.3	76.2	12.7		GALGHD				
R400213N	1	 ÁRBOL DE LEVAS	22.22	34.92	6.35		GA				
400158	1	 EMPAQUETADURA BANCADA (2)					JUEGO				
R300310P R300310PN/1	1	 GUÍA VÁLVULAS (8) BLISTER (200)	7.9	15.5	12.5		RGV				
R400211P R400211V	1	 BANCADA	133.35	158.75	11/13		GALGRI	D20 GM D10, F350, VW6.80 Case 550, GM D10/20/40 Case 580H	3860cc. 3860cc. 3860cc.	Q20B4 (OHV) 8V DIESEL 4.236 (OHV) 8V DIESEL Aspirado Turbo 4.236 (OHV) 8 DIESEL	401000-R 410600-R 420200-R
R400012N R400012P R400012V	1	 DISTRIBUCIÓN	60.32	79.36	9.5		GALGHD				
R280310P	1	 GUÍA VÁLVULAS (8) R400210P/1	9.1	12.3	15.1		RGV				
R400211P R400211V	1	 BANCADA	133.35	158.75	11/13		GALGRI	Phaser 90, Phaser 110T Phaser 120 Ti, 4.40, T4.40 C4.40, MF6130/6140/6150	3993cc.	1004.4 - 1004.4T/TW (OHV) 8V DIESEL	401500-R
R400012N R400012P R400012V	1	 DISTRIBUCIÓN	60.32	79.36	9.5		GALGHD				
R300310P R300310PN/1	1	 GUÍA VÁLVULAS (8) BLISTER (200)	7.9	15.5	12.5		RGV				
R400211P R400211V	1	 BANCADA	133.35	158.75	11/13		GALGRI	MF220, F290, Tractor MF85X Case 580H	4070cc. 4070cc.	4.248 (OHV) 8V DIESEL 4.248 (OHV) 8V DIESEL	410600-R 420200-R
R400012N R400012P R400012V	1	 DISTRIBUCIÓN	60.32	79.36	9.5		GALGHD				
R280310P	1	 GUÍA VÁLVULAS (8) R400210P/1	9.1	12.3	15.1		RGV				
R300310P R300310PN/1	1	 GUÍA VÁLVULAS (8) BLISTER (200)	7.9	15.5	12.5		RGV	Agrícola, Case 580H, MF85 MF270/275/285/290 MF220/220A, Hyster H110	4070cc.	A4 - 248 DIESEL	410700-R
R400211P R400211V	1	 BANCADA	133.35	158.75	11/13		GALGRI				























PERKINS - MASSEY FERGUSON

Código Code	Cant. Qty	Descripción Descrição Descrição	DE [mm]	DA [mm]	H [mm]	A [mm]		Aplicación Aplicação Application	Cm³ Cm³	Motor Motor Engine	Jgo. Juntas Set Gaskets
R400012N R400012P R400012V	1	 DISTRIBUCIÓN	60.32	79.36	9.5		GALGHD	Agrícola, Case 580H, MF85 MF270/275/285/290 MF220/220A, Hyster H110	4070cc.	A4 - 248 DIESEL	410700-R
400158	1	 EMPAQUETADURA BANCADA (2)					JUEGO				
R280310P	1	 GUÍA VÁLVULAS (8) R400210P/1	9.1	12.3	15.1		RGV	MF290/292/610/620	4100cc.	P4000-4000T DIESEL	401100-R
R300310P R300310PN/1	1	 GUÍA VÁLVULAS (8) BLISTER (200)	7.9	15.5	12.5		RGV				
R400211P R400211V	1	 BANCADA	133.35	158.75	11/13		GALGRI	Tractor 85 1986/...	4156cc.	D226-4 (OHV) 8 DIESEL	320400-R 320400
R400012N R400012P R400012V	1	 DISTRIBUCIÓN	60.32	79.36	9.5		GALGHD				
R310410V	1	 GUÍA VÁLVULAS (8) R310410V/1	9	13.4	11		RGV				
R310411P R310411V	1	 BANCADA	110	130	13		GALGHI	R310412P R310412V	4156cc.	D226-4 (OHV) 8 DIESEL	320400-R 320400
R310412P R310412V	1	 DISTRIBUCIÓN	78	100	13		GALGHD				
R400100	1	 KIT DE RETENES					KIT	DP 400/500 1964/... F350/600	5004cc.	6.305 Cadenero (SOHC) 12V DIESEL	400100-R
R400110P	1	 GUÍA VÁLVULAS (12) R400010P/1	7.9	12.75	12.8		RGV				
R540210P	1	 GUÍA VÁLVULAS (12) R300310P/1	7.9	14	13.2		RGV	R400012N R400012P R400012V	5004cc.	6.305 Cadenero (SOHC) 12V DIESEL	400100-R
400158	1	 EMPAQUETADURA BANCADA (2)					JUEGO				
R400110P	1	 GUÍA VÁLVULAS (12) R400010P/1	7.9	12.75	12.8		RGV	F100/F350/600 1974/...	5004cc.	6PF - 305 DIESEL	400300-R
R540210P	1	 GUÍA VÁLVULAS (12) R300310P/1	7.9	14	13.2		RGV				
R400211P R400211V	1	 BANCADA	133.35	158.75	11/13		GALGRI	Tractor - PF F600	5004cc. 5004cc.	6PF - MF1175 DIESEL 6PF - 305 Potenciado DIESEL	400600-R 410100-R
R400012N R400012P R400012V	1	 DISTRIBUCIÓN	60.32	79.36	9.5		GALGHD				
400158	1	 EMPAQUETADURA BANCADA (2)					JUEGO				
R400110P	1	 GUÍA VÁLVULAS (12) R400010P/1	7.9	12.75	12.8		RGV	Tractor - PF F600	5004cc. 5004cc.	6PF - MF1175 DIESEL 6PF - 305 Potenciado DIESEL	400600-R 410100-R
R540210P	1	 GUÍA VÁLVULAS (12) R300310P/1	7.9	14	13.2		RGV				
R400211P R400211V	1	 BANCADA	133.35	158.75	11/13		GALGRI	Tractor - PF F600	5004cc. 5004cc.	6PF - MF1175 DIESEL 6PF - 305 Potenciado DIESEL	400600-R 410100-R
R400012N R400012P R400012V	1	 DISTRIBUCIÓN	60.32	79.36	9.5		GALGHD				
400158	1	 EMPAQUETADURA BANCADA (2)					JUEGO				







CATALOGO DE RETENES

CATALOGO DE RETENTORES - OIL SEAL CATALOG















PERKINS - MASSEY FERGUSON

Código Code	Cant. Qty	Descripción Descrição Descrição	DE [mm]	DA [mm]	H [mm]	A [mm]		Aplicación Aplicação Application	Cm³ Cm³	Motor Motor Engine	Jgo. Juntas Set Gaskets
R400200 R400200-1	1	 KIT DE RETENES					JUEGO	DP 600/800 1968/...F600/700 Tractor 1095/1098/1195/1215	5798cc.	6.354-2 (OHV) 12 DIESEL 6.354-2 (OHV) 12V DIESEL	400200-R 400800-R
R400210P	1	 GUÍA VÁLVULAS (12) R400210P/1	9.1	12.3	15.1		G1LGHD				
R400211P R400211V	1	 BANCADA	133.35	158.75	11/13		GALGRI				
R400012N R400012P R400012V	1	 DISTRIBUCIÓN	60.32	79.36	9.5		GALGHD				
R400213N	1	 DEPRESOR	22.22	34.92	6.35		GA				
R400215N	1	 AUXILIAR	22.22	35.7	9.52		ESP-RD				
400158	1	 EMPAQUETADURA BANCADA (2)					JUEGO				
R400210P	1	 GUÍA VÁLVULAS (12) R400210P/1	9.1	12.3	15.1		RGV	DP 600/800 - F600/700	5798cc.	6.354-1 (OHV) 12V DIESEL	400900-R
R400012N R400012P R400012V	1	 DISTRIBUCIÓN	60.32	79.36	9.5		GALGHD				
R400215N	1	 AUXILIAR	22.22	35.7	9.52		ESP-RD				
400158	1	 EMPAQUETADURA BANCADA (2)					JUEGO				
R401710P	1	 GUÍA VÁLVULAS (12) R300310V/1	7.9	15.5	12.5		RGV				
R400211P R400211V	1	 BANCADA	133.35	158.75	11/13		GALGRI	1095/1098/1195/1215 1970/... Tractores, Estancieros Grúas, Rodantes	5798cc.	6.354-2 Turbo (OHV) 12V DIESEL	401700-R
R400012N R400012P R400012V	1	 DISTRIBUCIÓN	60.32	79.36	9.5		GALGHD				
R400215N	1	 AUXILIAR	22.22	35.7	9.52		ESP-RD				
400158	1	 EMPAQUETADURA BANCADA (2)					JUEGO				
R400200-1	1	 KIT DE RETENES					JUEGO				
R400210P	1	 GUÍA VÁLVULAS (12) R400210P/1	9.1	12.3	15.1		G1LGHD	D600/800 1976/... F7000 Camiónes Ford pesados y semi-pesados Tractor MF1215/1218	5798cc.	6.354-4 (OHV) 12V DIESEL T6.354-4 (OHV) 12V DIESEL	400400-R 410400-R
R400211P R400211V	1	 BANCADA	133.35	158.75	11/13		GALGRI				
R400012N R400012P R400012V	1	 DISTRIBUCIÓN	60.32	79.36	9.5		GALGHD				
R400215N	1	 AUXILIAR	22.22	35.7	9.52		ESP-RD				
R410912N	1	 DISTRIBUCIÓN	50.9	69.80	9.5		GAHD				
400158	1	 EMPAQUETADURA BANCADA (2)					JUEGO	MF3366	5840cc.	6-357 Vehicular Agrícola - Industrial DIESEL	410900-R

PERKINS - MASSEY FERGUSON

Código Code	Cant. Qty	Descripción Descrição Descrição	DE [mm]	DA [mm]	H [mm]	A [mm]		Aplicación Aplicação Application	Cm³ Cm³	Motor Motor Engine	Jgo. Juntas Set Gaskets
R540210P	1	 GUÍA VÁLVULAS (12) R300310P/1	7.9	14	13.2		RGV	MF400 - F400/F600/F7000 F11000/F12000/F13000	5840cc.	6-358 Veh - Agrícola - Industrial DIESEL	420000-R
R400211P R400211V	1	 BANCADA	133.35	158.75	11/13		GALGRI				
R400012N R400012P R400012V	1	 DISTRIBUCIÓN	60.32	79.36	9.5		GALGHD				
R400210P	1	 GUÍA VÁLVULAS (12) R400210P/1	9.1	12.3	15.1		G1LGHD	Phaser 125, MF396/399/630 640/3085/6160/6170 Phaser 160Ti, MF660/3114 3125/3625/3635/3655/6189 6190/8110/8120/8130 Phaser 180Ti, C,60/6,60 1989/..., MF399 1994/...	5985cc.	1006.6/C/T/TW (OHV) 12V DIESEL	401600-R
R400211P R400211V	1	 BANCADA	133.35	158.75	11/13		GALGRI				
R400012N R400012P R400012V	1	 DISTRIBUCIÓN	60.32	79.36	9.5		GALGHD				

























PEUGEOT

R460710V R460710P	1	 GUÍA VÁLVULAS (8) R260610V/1	7	9.8	10		RGV	205 1987/93, 106 1991/... 106, 306, Partner 1996/...	954cc. 1124cc.	TU9/M/MZ/K TU1M (SOHC) 8V	451500-R				
R220411P R220411P/1 R220411V R220411VF	1	 BANCADA	85	105	12		GALGRI								
R460712V	1	 DISTRIBUCIÓN	42	66	8		GALGHD								
R460213P R460213V	1	 ÁRBOL DE LEVAS	36	50	8		GALGHD								
R581010V	1	 GUÍA VÁLVULAS (16) R581010V/1	5.5	10.9	15.5	23	RGV								
R581710V	1	 GUÍA VÁLVULAS (16) R581710V/1	5	8.2	7.85		RGV	206 2000/...	999cc.	D4D (DOHC) 16V	581000-R 581000-R MLS				
R570511V	1	 BANCADA	70	86	8		GALGHI								
R570512V	1	 DISTRIBUCIÓN	32	44	6		GALGHD								
R580013V	1	 ÁRBOL DE LEVAS	28	47	5.5		GALGHD								
R460710V R460710P	1	 GUÍA VÁLVULAS (8) R260610V/1	7	9.8	10		RGV					106 1991/..., 306 1993/97 205 1987/96, 309 1990/93	1124cc.	TU1/K/Z/M (SOHC) 8V (Motor con block de aluminio)	451700-R
R220411P R220411P/1 R220411V R220411VF	1	 BANCADA	85	105	12		GALGRI								
R460712V	1	 DISTRIBUCIÓN	42	66	8		GALGHD								
R460213P R460213V	1	 ÁRBOL DE LEVAS	36	50	8		GALGHD								
R460700	1	 KIT DE RETENES					JUEGO								
R460710V R460710P	1	 GUÍA VÁLVULAS (8) R260610V/1	7	9.8	10		RGV	106 1991/..., 306 1993/97 205 1987/96, 309 1990/93 205 Rallye 1988/93	1124cc. 1294cc.	TU1M/K/Z (SOHC) 8V TU24 (SOHC) 8V	460700-R				
R560111P R560111V	1	 BANCADA	85	105	8		GALGRI								

























CATALOGO DE RETENES

CATALOGO DE RETENTORES - OIL SEAL CATALOG

PEUGEOT

Código Code	Cant. Qty	Descripción Descrição Descrição	DE [mm]	DA [mm]	H [mm]	A [mm]		Aplicación Aplicação Aplicacion	Cm³ Cm³	Motor Motor Engine	Jgo. Juntas Set Gaskets
R460712V	1	 DISTRIBUCIÓN	42	66	8		GALGHD	106 1991/..., 306 1993/97 205 1987/96, 309 1990/93 205 Rallye 1988/93	1124cc. 1294cc.	TU1M/K/Z (SOHC) 8V TU24 (SOHC) 8V	460700-R
R460213P R460213V	1	 ÁRBOL DE LEVAS	36	50	8		GALGHD				
PR472111T	1	 PORTA BANCADA	85				PORTA	208 2012/..., 108 2014/... 2008, 3008, 5008 2013/... Partner 2016/...	1199cc.	EB2DTS (HNY) EB2DT (HNZ) (DOHC) 12V	472100-R MLS
R450000	1	 KIT DE RETENES					JUEGO	403/7 1959/66	1290cc.	7CV	450900-R
R450010P	1	 GUÍA VÁLVULAS (8) R250410V/1	8	10.8	10		RGV				
R450010T	1	 GUÍA VÁLVULAS (8) R450010T/1	8	10.8	10		RGV				
R450012P	1	 DISTRIBUCIÓN	42	60	10		GALGHD				
450035	2	 BASTÓN CIERRE BANCADA									
R460710V R460710P	1	 GUÍA VÁLVULAS (8) R260610V/1	7	9.8	10		RGV	106 1991/96, 309 1992/93 405 1993/94, 205 1991/93	1360cc.	TU3F2 - TU3FM TU3J2/Z - TU3MC (SOHC) 8V (Motor con block de fundición gris)	451600-R
R560111P R560111V	1	 BANCADA	85	105	8		GALGRI				
R460712V	1	 DISTRIBUCIÓN	42	66	8		GALGHD				
R460213P R460213V	2	 ÁRBOL DE LEVAS	36	50	8		GALGHD				
R460710V R460710P	1	 GUÍA VÁLVULAS (8) R260610V/1	7	9.8	10		RGV	106 1991/..., 206 1998/... 306 1993/..., 405 1987/94 205 1987/96, 309 1988/93 Partner 1996/... 106 1992/95	1360cc. 1360cc.	TU3A/S/K/M/JP/MC (SOHC) 8V (Motor con block de aluminio) TUD3 50HP (SOHC) 8V	451700-R 470400-R
R220411P R220411P/1 R220411V R220411VF	1	 BANCADA	85	105	12		GALGRI				
R460712V	1	 DISTRIBUCIÓN	42	66	8		GALGHD				
R460213P R460213V	1	 ÁRBOL DE LEVAS	36	50	8		GALGHD				
R460700	1	 KIT DE RETENES					JUEGO	206, 307 2001/... Partner 2005/..., 207 Compact Partner 1996/..., 306 1993/... 106 1991/..., 205, 405 1987/96 309 1988/93, 206 1998/...	1360cc. 1360cc.	TU3JP (KFW/K6D) (SOHC) 8V TU3JP/S/M/MC/K/A TU3.2 (SOHC) 8V	452200-R 460700-R
R460710V R460710P	1	 GUÍA VÁLVULAS (8) R260610V/1	7	9.8	10		RGV				
R560111P R560111V	1	 BANCADA	85	105	8		GALGRI				
R460712V	1	 DISTRIBUCIÓN	42	66	8		GALGHD				
R460213P R460213V	1	 ÁRBOL DE LEVAS	36	50	8		GALGHD				
R460760P	1	 SEMIEJE	29.9	47	11.3		GALGRD C/FILTRO	Partner 1996/..., 306 1993/... 106 1991/..., 205, 405 1987/96 309 1988/93, 206 1998/...	1360cc.	TU3JP/S/M/MC/K/A TU3.2 (SOHC) 8V	460700-R
R460760-1P	1	 SEMIEJE	40	58	10		GALG-BI C/FILTRO				
R471710V	1	 GUÍA VÁLVULAS (16) R471710V/1	5	9	18	22.6	RGV	207, 207 SW, 308 308 SW 2007/...	1397cc.	EP3 (8FS) - EP3 (DOHC) 16V	471700-R MLS























PEUGEOT

Código Code	Cant. Qty	Descripción Descrição Descrição	DE [mm]	DA [mm]	H [mm]	A [mm]		Aplicación Aplicação Aplicacion	Cm³ Cm³	Motor Motor Engine	Jgo. Juntas Set Gaskets
R560111P R560111V	1	 BANCADA	85	105	8		GALGRI	207, 207 SW, 308 308 SW 2007/...	1397cc.	EP3 (8FS) - EP3 (DOHC) 16V	471700-R MLS
R302110V	1	 GUÍA VÁLVULAS (8) R302110V/1	6	9	17.5	23	RGV	TDI, 307 HDI 2001/...	1398cc.	DV4TD (8HZ/8HX) (SOHC) 8V DIESEL	302101-R
R560111P R560111V	1	 BANCADA	85	105	8		GALGRI	Partner, 308, 207 HDI 308 HDI 2009/... 3008 2009/..., 5008 2010/...	1560cc.	DV6C - DV6DTE (SOHC) 8V DIESEL	472301-R
R270713P R270713P/1 R270713V	1	 DISTRIBUCIÓN	40	55	7	G1ALGHD					
R470813V	1	 ÁRBOL DE LEVAS	27	47	7	GALGHD					
R471310V	1	 GUÍA VÁLVULAS (8) R471310V/1	5.5	9.5	13.8	18.1	RGV				
R560111P R560111V	1	 BANCADA	85	105	8		GALGRI				
R270713P R270713P/1 R270713V	1	 DISTRIBUCIÓN	40	55	7	G1ALGHD					
R470813V	1	 ÁRBOL DE LEVAS	27	47	7	GALGHD					
R450000	1	 KIT DE RETENES					JUEGO				
R450010P	1	 GUÍA VÁLVULAS (8) R250410V/1	8	10.8	10		RGV				
R450010T	1	 GUÍA VÁLVULAS (8) R450010T/1	8	10.8	10		RGV				
R450012P	1	 DISTRIBUCIÓN	42	60	10		GALGHD				
450035	1	 BASTÓN CIERRE BANCADA									
R460700	1	 KIT DE RETENES					JUEGO	208 2012/...	1499cc.	TU4M (SOHC) 8V	472200-R MLS
R460710V R460710P	1	 GUÍA VÁLVULAS (8) R260610V/1	7	9.8	10		RGV				
R560111P R560111V	1	 BANCADA	85	105	8		GALGRI				
R460712V	1	 DISTRIBUCIÓN	42	66	8		GALGHD				
R460213P R460213V	1	 ÁRBOL DE LEVAS	36	50	8		GALGHD				
R460700	1	 KIT DE RETENES					JUEGO	106 1994/...	1527cc.	TUD5 (VJZ) - DIESEL (SOHC) 8V	470300-R
R460710V R460710P	1	 GUÍA VÁLVULAS (8) R260610V/1	7	9.8	10		RGV				
R560111P R560111V	1	 BANCADA	85	105	8		GALGRI				
R460712V	1	 DISTRIBUCIÓN	42	66	8		GALGHD				
R460213P R460213V	1	 ÁRBOL DE LEVAS	36	50	8		GALGHD				

























CATALOGO DE RETENES

CATALOGO DE RETENTORES - OIL SEAL CATALOG

PEUGEOT

Código Code	Cant. Qty	Descripción Descrição Descrição	DE [mm]	DA [mm]	H [mm]	A [mm]		Aplicación Aplicação Application	Cm³ Cm³	Motor Motor Engine	Jgo. Juntas Set Gaskets
R450010P	1	 GUÍA VÁLVULAS (8) R250410V/1	8	10.8	10		RGV	305 1982/91, 205 1984/96 309 1985/93, 405 1987/95	1580cc.	XU5 (SOHC) 8V	451200
R460213P R460213V	1	 ÁRBOL DE LEVAS	36	50	8		GALGHD				
R230510P R230510V R230510VM/1 R230510VM/2 R230510VM/3 R230510VM/4	1	 GUÍA VÁLVULAS (16) GUÍA VÁLVULAS (16) A GRANEL (200) A GRANEL (200) A GRANEL (1000) A GRANEL (600)	6	8	9.5		RGV	206, 307, Partner 2000/... 207 SW, 207 Compact	1587cc.	TU5JP4 (NFU/N6A) (DOHC) 16V	452100-R MLS
R560111P R560111V	1	 BANCADA	85	105	8		GALGRI	106 1994/..., 306 1993/... 206 1998/...	1587cc.	TU5JP/J2 (SOHC) 8V	470501-R
R470012V	1	 DISTRIBUCIÓN	64	88	6		GALGRI				
R452113V	2	 ÁRBOL DE LEVAS	38	50	6		GALGHD				
460235	2	 BASTÓN CIERRE BANCADA									
R460710V R460710P	1	 GUÍA VÁLVULAS (8) R260610V/1	7	9.8	10		RGV	207, 207 SW, 308, 308 SW 2007/..., Partner 2008/... 3008, 5008 2009/... 207, 207 CC, 308, 308 SW 2007/..., 3008 2009/..., 508 508 SW, 5008, RCZ 2010/...	1598cc.	EP6/C (5FW/5F01) (DOHC) 16V	471700-R MLS
R560111P R560111V	1	 BANCADA	85	105	8		GALGRI				
R460712V	1	 DISTRIBUCIÓN	42	66	8		GALGHD				
R460213P R460213V	2	 ÁRBOL DE LEVAS	36	50	8		GALGHD				
R471710V	1	 GUÍA VÁLVULAS (16) R471710V/1	5	9	18	22.6	RGV				
R560111P R560111V	1	 BANCADA	85	105	8		GALGRI	1598cc.	EP6DT/CDT/DTS (5FX/5FR/5FV/5FT) (5F04/5FY) (DOHC) 16V	471800-R MLS	
R450000	1	 KIT DE RETENES					JUEGO	404 1962/80 504 GLS/GLSE 1969/80	1618cc. 1657cc.	XC7-XC7P (OHV) 8V XC7-XC6A (OHV) 8V	450000-R 450100-R
R450010P	1	 GUÍA VÁLVULAS (8) R250410V/1	8	10.8	10		RGV	306 1993/..., 405, 406 1992/... 406 1997/... Partner 1997/...	1761cc. 1761cc.	XU7JP-XU7JB (SOHC) 8V XU7JB (SOHC) 8V	460100-R 461100-R
R450010T	1	 GUÍA VÁLVULAS (8) R450010T/1	8	10.8	10		RGV				
R450012P R450012N	1	 DISTRIBUCIÓN	42	60	10		GALGHD				
R450055N	1	 RUEDA TRASERA PUENTE	45	62	12		GA				
R450055-1N	1	 PALIER	52	75	12		GA				
450035	2	 BASTÓN CIERRE BANCADA	52	75	12		JUEGO				
R460200	1	 KIT DE RETENES					JUEGO	306 1993/..., 405, 406 1992/... 406 1997/... Partner 1997/...	1761cc. 1761cc.	XU7JP-XU7JB (SOHC) 8V XU7JB (SOHC) 8V	460100-R 461100-R
R460210V	1	 GUÍA VÁLVULAS (8) R250410V/1	8	10.8	10		RGV				
R460211V	1	 BANCADA	90	110	7		GALGRI				



























PEUGEOT

Código Code	Cant. Qty	Descripción Descrição Descrição	DE [mm]	DA [mm]	H [mm]	A [mm]		Aplicación Aplicação Aplicacion	Cm³ Cm³	Motor Motor Engine	Jgo. Juntas Set Gaskets
R460212P R460212V	1	 DISTRIBUCIÓN	42	62	7		GALGHD	306 1993/..., 405, 406 1992/... 406 1997/... Partner 1997/...	1761cc. 1761cc.	XU7JP-XU7JB (SOHC) 8V XU7JB (SOHC) 8V	460100-R 461100-R
R460213P R460213V	1	 ÁRBOL DE LEVAS	36	50	8		GALGHD				
460235	2	 BASTÓN CIERRE BANCADA									
R460800	1	 KIT DE RETENES					JUEGO	306 1997/..., 406 1995/96 406 1997/...	1761cc.	XU7JP4 (DOHC) 16V	460800-R
R460810V	1	 GUÍA VÁLVULAS (16) R460810V/1	7	17	18		RGV				
R460211V	1	 BANCADA	90	110	7		GALGRI				
R460212P R460212V	1	 DISTRIBUCIÓN	42	62	7		GALGHD				
R460213P R460213V	2	 ÁRBOL DE LEVAS	36	50	8		GALGHD				
460235	2	 BASTÓN CIERRE BANCADA									
R460300	1	 KIT DE RETENES					JUEGO	205 TD 1990/96 405 TD 1988/94 309 TD 1990/93 205/309 1983/96, 306 1993/... Partner 1996/... 206, 306 1998/..., Expert, Partner 1999/...	1769cc. 1769cc. 1868cc.	XUD7T/TE (SOHC) 8V DIESEL XUD7 (SOHC) 8V DW8 (WJZ/WJY) (SOHC) 8V DIESEL	460301-R (470700) 460301-R (470900) 470601-R
R460210V	1	 GUÍA VÁLVULAS (8) R250410V/1	8	10.8	10		RGV				
R460211V	1	 BANCADA	90	110	7		GALGRI				
R460212P R460212V	1	 DISTRIBUCIÓN	42	62	7		GALGHD				
R470013P R470013P/1 R470013V	1	 ÁRBOL DE LEVAS	35	50	7		GALG-BI				
460235	2	 BASTÓN CIERRE BANCADA									
R450000	1	 KIT DE RETENES					KIT	504 XE/XL/XSE 1973/78	1796cc.	XC7 - XM7 (OHV) 8V	450200-R
R450010P	1	 GUÍA VÁLVULAS (8) R250410V/1	8	10.8	10		RGV				
R450010T	1	 GUÍA VÁLVULAS (8) R450010T/1	8	10.8	10		RGV				
R450012P R450012N	1	 DISTRIBUCIÓN	42	60	10		GALGHD				
450035	2	 BASTÓN CIERRE BANCADA									
R450010P	1	 GUÍA VÁLVULAS (8) R250410V/1	8	10.8	10		RGV	205, 309 1986/94, 305 1983/91 405 1987/93	1905cc.	XU9 (SOHC) 8V	451200
R460213P R460213V	1	 ÁRBOL DE LEVAS	36	50	8		GALGHD				
R460200	1	 KIT DE RETENES					JUEGO	306, 405, 309GT 305GTX 1986/93	1905cc.	XU92C (SOHC) 8V	460200-R
R460210V	1	 GUÍA VÁLVULAS (8) R250410V/1	8	10.8	10		RGV				
R460211V	1	 BANCADA	90	110	7		GALGRI				

























CATALOGO DE RETENES

CATALOGO DE RETENTORES - OIL SEAL CATALOG

PEUGEOT

Código Code	Cant. Qty	Descripción Descrição Descrição	DE [mm]	DA [mm]	H [mm]	A [mm]		Aplicación Aplicação Application	Cm³ Cm³	Motor Motor Engine	Jgo. Juntas Set Gaskets
R460212P R460212V	1	 DISTRIBUCIÓN	42	62	7		GALGHD	306, 405, 309GT 305GTX 1986/93	1905cc.	XU92C (SOHC) 8V	460200-R
R460213P R460213V	1	 ÁRBOL DE LEVAS	36	50	8		GALGHD				
R460215N	1	 AUXILIAR	9.5	16	4		GALGSR				
R460255P	1	 PUENTE TRASERO	48.9	63	10.8 12.8		E-GALG-BI				
460235	2	 BASTÓN CIERRE BANCADA									
R460300	1	 KIT DE RETENES					JUEGO	306 1993/99, 305, 309 1982/93 405 1988/95, 1995/..., 205, Express 1987/94 Boxer, Expert, Partner 1995/...	1905cc.	XUD9 (SOHC) 8V DIESEL	460301-R 460300-R-1M 460300-R-2M 460300-R-3M
R460210V	1	 GUÍA VÁLVULAS (8) R250410V/1	8	10.8	10		RGV				
R460211V	1	 BANCADA	90	110	7		GALGRI				
R460212P R460212V	1	 DISTRIBUCIÓN	42	62	7		GALGHD				
R470013P R470013P/1 R470013V	1	 ÁRBOL DE LEVAS	35	50	7		GALG-BI				
460235	2	 BASTÓN CIERRE BANCADA									
306 TD 1993/97 405 TD 1992/96 406 TD 1995/99, 806TD Expert TD, Boxer TD 1995/...											
R500200 R500200-1	1	 KIT DE RETENES					JUEGO	404, T4B, T5B Rastrojero 1972/...	1948cc.	XD/XDP 4.88 DIESEL	500200-R
R460210V	1	 GUÍA VÁLVULAS (8) R250410V/1	8	10.8	10		RGV				
R500211-1S	1	 BANCADA	60	75	5		EXP				
R450012P R450012N	1	 DISTRIBUCIÓN	42	60	10		GALGHD				
R450412P R450412N	1	 DISTRIBUCIÓN	42	60	10		GALGHD				
500258	1	 EMPAQUETADURA BANCADA (2)					JUEGO				
R450000	1	 KIT DE RETENES									
R450010P	1	 GUÍA VÁLVULAS (8) R250410V/1	8	10.8	10		RGV	504 TN/GES/XNA 1976/80	1971cc.	XN1 -XN2 (OHV) 8V	450300-R
R450010T	1	 GUÍA VÁLVULAS (8) R450010T/1	8	10.8	10		RGV				
R450012P R450012N	1	 DISTRIBUCIÓN	42	60	10		GALGHD				
R450348N	1	 SELECTOR CAJA VELOCIDAD	17	23	7		ESP				
R450350N	1	 CAJA VELOCIDAD	40	58	10		GAHI				
R450351P	1	 CAJA VELOCIDAD	32	50	10		GAHD				
R450355N	1	 RUEDA TRASERA PUENTE	53	79	10		ESP				
450035	2	 BASTÓN CIERRE BANCADA									

























PEUGEOT

Código Code	Cant. Qty	Descripción Descrição Descrição	DE [mm]	DA [mm]	H [mm]	A [mm]		Aplicación Aplicação Aplicacion	Cm³ Cm³	Motor Motor Engine	Jgo. Juntas Set Gaskets
R450000	1	 KIT DE RETENES						505, 9R, J9/J5 1980/92	1971cc.	GR/SR - XN1/XN2 (OHV) 8V	450500-R
R450010P	1	 GUÍA VÁLVULAS (8) R250410V/1	8	10.8	10		RGV	505 1983/86, 504 1970/84 604 1982/86 505 1987/...	1971cc.	XN2 - XN6 (OHV) 8V	450600-R
R450010T	1	 GUÍA VÁLVULAS (8) R450010T/1	8	10.8	10		RGV		1971cc.	XN1 - XNA - Gamma (OHV) 8V	450800-R
R450012P R450012N	1	 DISTRIBUCIÓN	42	60	10		GALGHD				
450035	2	 BASTÓN CIERRE BANCADA									
R450557P	1	 DIFERENCIAL PIÑÓN	28	45	8		GAHD	505, 9R, J9/J5 1980/92	1971cc.	GR/SR - XN1/XN2 (OHV) 8V	450500-R
R550610T	1	 GUÍA VÁLVULAS (8) R450010T/1	7	10.2	10		RGV	505 Inyección ZEJ 1979/...	1995cc.	ZEJ (SOHC) 8V	461200-R
R550611P R550611V	1	 BANCADA	90	110	13		GALGRI				
R550612P R550612V	1	 DISTRIBUCIÓN	50	68	10		GALGRD				
R550613P R550613P/1 R550613V	1	 ÁRBOL DE LEVAS	35	47	7		GAHD				
R550615P R550615V R550615N	1	 AUXILIAR	30	40	7		GAHD				
550658	1	 EMPAQUETADURA BANCADA (2)					JUEGO				
R470810V	1	 GUÍA VÁLVULAS (16) R470810V/1	6	10	21.5	19.6	RGV	306/406 HDI 1998/... 206/806 HDI, Boxer HDI Expert HDI - Partner HDI 1998/..., 307, 607 2000/...	1997cc.	DW10TD (RHY/RHV) DW10ATED(RHZ/RHS) (SOHC) 8V	470801-R
R460211V	1	 BANCADA	90	110	7		GALGRI				
R460212P R460212V	1	 DISTRIBUCIÓN	42	62	7		GALGHD				
R470813V	1	 ÁRBOL DE LEVAS	27	47	7		GALGHD				
460235	2	 BASTÓN CIERRE BANCADA									
R470810V	1	 GUÍA VÁLVULAS (16) R470810V/1	6	10	21.5	19.6	RGV	206/307/406/806/807 Expert 2000/..., 406 HPI 607 2001/..., 407 2004/...	1997cc.	EW10J4 (RFN-RLZ) (DOHC) 16V	471200-R MLS
R460211V	1	 BANCADA	90	110	7		GALGRI				
R270713P R270713P/1 R270713V	1	 DISTRIBUCIÓN	40	55	7		G1ALGHD				
R460213P R460213V	2	 ÁRBOL DE LEVAS	36	50	8		GALGHD				
R452113V	1	 AUXILIAR	38	50	6		GALGHD				
460235	2	 BASTÓN CIERRE BANCADA									
R471410V	1	 GUÍA VÁLVULAS (16) R470810V/1	6	10	21.5	19.6	RGV	307 HDI FAP, 407 2003/... Expert HDI, 807 2006/... 806 HDI, Expert HDI 1999/... 807 HDI 2000/...	1997cc.	DW10BTED4 (DOHC) 16V DIESEL	471401-R
									1997cc.	DW10ATED4 (DOHC) 16V DIESEL	471501-R

CATALOGO DE RETENES

CATALOGO DE RETENTORES - OIL SEAL CATALOG























PEUGEOT

Código Code	Cant. Qty	Descripción Descrição Descrição	DE [mm]	DA [mm]	H [mm]	A [mm]		Aplicación Aplicação Application	Cm³ Cm³	Motor Motor Engine	Jgo. Juntas Set Gaskets
R460211V	1	 BANCADA	90	110	7		GALGRI	307 HDI FAP, 407 2003/... Expert HDI, 807 2006/... 806 HDI, Expert HDI 1999/... 807 HDI 2000/...	1997cc.	DW10BTED4 (RHR/RHK) (DOHC) 16V DIESEL DW10ATED4 (RHW/RHT) (DOHC) 16V DIESEL	471401-R 471501-R
R460212P R460212V	1	 DISTRIBUCIÓN	42	60	7		GALGHD				
R470813V	1	 ÁRBOL DE LEVAS	27	47	7		GALGHD				
460235	2	 BASTÓN CIERRE BANCADA									
R460211V	1	 BANCADA	90	110	7		GALGRI	308 HDI -308 SW HDI 2007/... 308 CC HDI, 407 Coupe HDI 3008 HDI, 407 SW HDI 5008 HDI, Expert Tepee Expert 3 2009/... RCZ HDI 2010/...	1971cc.	DW10CTED4 (RH02/RHH) (DOHC) 16V DIESEL	471901-R
R460212P R460212V	1	 DISTRIBUCIÓN	42	60	7		GALGHD				
R470813V	1	 ÁRBOL DE LEVAS	27	47	7		GALGHD				
R460810V	1	 GUÍA VÁLVULAS (16) R460810V/1	7	17	18		RGV				
R460211V	1	 BANCADA	90	110	7		GALGRI	605 1989/98	1998cc.	XU10M - XU102C XU10J2 (SOHC) 8V	451300
R270713P R270713P/1 R270713V	1	 DISTRIBUCIÓN	40	55	7		G1ALGHD				
R460213P R460213V	2	 ÁRBOL DE LEVAS	36	50	8		GALGHD				
R452113V	1	 AUXILIAR	38	50	6		GALGHD				
R450010P	1	 GUÍA VÁLVULAS (8) R250410V/1	8	10.8	10		RGV				
R450010T	1	 GUÍA VÁLVULAS (8) R450010T/1	8	10.8	10		RGV				
R460211V	1	 BANCADA	90	110	7		GALGRI	405 1992/..., 306 1993/...	1998cc.	XU10J2C(RFX) (SOHC) 8V	451900-R
R460212P R460212V	1	 DISTRIBUCIÓN	42	60	7		GALGHD				
R460213P R460213V	1	 ÁRBOL DE LEVAS	36	50	8		GALGHD				
R450010P	1	 GUÍA VÁLVULAS (8) R250410V/1	8	10.8	10		RGV				
R450010T	1	 GUÍA VÁLVULAS (8) R450010T/1	8	10.8	10		RGV	406, 605, 806 Turbo 1996/... 405 1992/..., 306 1993/...	1998cc. 1998cc.	XU10J2TE (SOHC) 8V XU10J2C (SOHC) 8V	460400-R 460600-R
R460213P R460213V	1	 ÁRBOL DE LEVAS	36	50	8		GALGHD				
R460200	1	 KIT DE RETENES					JUEGO				
R460210V	1	 GUÍA VÁLVULAS (8) R250410V/1	8	10.8	10		RGV	406, 605, 806 Turbo 1996/... 405 1992/..., 306 1993/...	1998cc. 1998cc.	XU10J2TE (SOHC) 8V XU10J2C (SOHC) 8V	460400-R 460600-R
R460211V	1	 BANCADA	90	110	7		GALGRI				
R460212P R460212V	1	 DISTRIBUCIÓN	42	62	7		GALGHD				
R460213P R460213V	1	 ÁRBOL DE LEVAS	36	50	8		GALGHD				

CATALOGO DE RETENES

CATALOGO DE RETENTORES - OIL SEAL CATALOG

























PEUGEOT

Código Code	Cant. Qty	Descripción Descrição Descrição	DE [mm]	DA [mm]	H [mm]	A [mm]		Aplicación Aplicação Aplicacion	Cm³ Cm³	Motor Motor Engine	Jgo. Juntas Set Gaskets
460235	2	 BASTÓN CIERRE BANCADA						406, 605, 806 Turbo 1996/... 405 1992/..., 306 1993/...	1998cc. 1998cc.	XU10J2TE (SOHC) 8V XU10J2C (SOHC) 8V	460400-R 460600-R
R460211V	1	 BANCADA	90	110	7		GALGRI	405 MI, 405 TI Turbo 1992/95 306 1993/...	1998cc.	XU10J4 - XU10J4TE (DOHC) 16V	470200-R
R460212P R460212V	1	 DISTRIBUCIÓN	42	60	7		GALGHD				
R460213P R460213V	2	 ÁRBOL DE LEVAS	36	50	8		GALGHD				
460235	2	 BASTÓN CIERRE BANCADA									
R460800	1	 KIT DE RETENES					KIT	406, 605 1995/..., 306 1997/... 806 1998/01	1998cc.	XU10J4R XU10J4R (RFV) (DOHC) 16V	471000-R
R460810V	1	 GUÍA VÁLVULAS (16) R460810V/1	7	17	18		RGV	605 TD 1990/98 - 1995/98 406 TD 1995/... 806 TD 1996/...	2088cc.	XUD11ATE/BTE (SOHC) 12V DIESEL	461501-R
R460211V	1	 BANCADA	90	110	7		GALGRI				
R460212P R460212V	1	 DISTRIBUCIÓN	42	60	7		GALGHD				
R460213P R460213V	2	 ÁRBOL DE LEVAS	36	50	8		GALGHD				
460235	2	 BASTÓN CIERRE BANCADA									
R461510P	1	 GUÍA VÁLVULAS (12) (R250410V/1)	8	10.8	10		RGV				
R460211V	1	 BANCADA	90	110	7		GALGRI	504 1980/..., J7/J9 1980/87 Adaptables Pick Up	2112cc.	XD-XDP 4.90 DIESEL	500600-R
R460212P R460212V	1	 DISTRIBUCIÓN	42	62	7		GALGHD				
R470013P R470013P/1 R470013V	1	 ÁRBOL DE LEVAS	35	50	7		GALG-BI				
460235	2	 BASTÓN CIERRE BANCADA									
R550610P	1	 GUÍA VÁLVULAS (8) R250410V/1	7	10.2	10		RGV	505 GTI ZDJ 1982/91	2165cc.	ZDJ (SOHC) 8V	461200-R
R550610T	1	 GUÍA VÁLVULAS (8) R450010T/1	7	10.2	10		RGV	504 1980/..., J7/J9 1980/87 Adaptables Pick Up	2112cc.	XD-XDP 4.90 DIESEL	500600-R
R550611P R550611V	1	 BANCADA	90	110	13		GALGRI				
R550612P R550612V	1	 DISTRIBUCIÓN	50	68	10		GALGRD				
R550613P R550613P/1 R550613V	1	 ÁRBOL DE LEVAS	35	47	7		GAHD				
R550615P R550615V R550615N	1	 AUXILIAR	30	40	7		GAHD				
550658	1	 EMPAQUETADURA BANCADA (2)					JUEGO				

























CATALOGO DE RETENES

CATALOGO DE RETENTORES - OIL SEAL CATALOG

PEUGEOT

Código Code	Cant. Qty	Descripción Descrição Descrição	DE [mm]	DA [mm]	H [mm]	A [mm]		Aplicación Aplicação Application	Cm³ Cm³	Motor Motor Engine	Jgo. Juntas Set Gaskets				
R471410V	1	 GUÍA VÁLVULAS (16) R470810V/1	6	10	21.5	19.6	RGV	607 HDI, 406 HDI 2000/... 807 HDI 2002/...	2179cc.	DW12TED4 (4HX) (DOHC) 16V DIESEL	471501-R				
R460211V	1	 BANCADA	90	110	7		GALGRI								
R460212P R460212V	1	 DISTRIBUCIÓN	42	60	7		GALGHD								
R470813V	1	 ÁRBOL DE LEVAS	27	47	7		GALGHD								
460235	2	 BASTÓN CIERRE BANCADA													
R302010V	1	 GUÍA VÁLVULAS (16) R30200V/1	7	12	18.8	24.2	RGV	Boxer HDI 2006/...	2198cc.	4HU/4HV (P22DTE) (DOHC) 16V DIESEL	324801-R				
PR302011T	1	 PORTA BANCADA	105				PORTA								
R470013P R470013P/1 R470013V	1	 ÁRBOL DE LEVAS	35	50	7		GALG-BI								
R450400 R450400-1 R450400-2	1	 KIT DE RETENES					KIT								
R460210V	1	 GUÍA VÁLVULAS (8) R250410V/1	8	10.8	10		RGV	XD2 504D 1976/93 505D 1979/82, 505TD 1981/... 604TD 1978/83 J7D1977/..., J9D 1980/... XD3 504 1987/... 505 1982/93, J9 1986/94	2304cc. 2498cc.	XD2 - XD2P (OHV) 8V DIESEL XD3 - X3DP (OHV) 8V DIESEL	450701-R 450700-R-1M 450700-R-2M 450700-R-3M 450700-R-4M				
R450411-1S	1	 BANCADA	64	80	5		EXPAN								
R450412-1P	1	 DISTRIBUCIÓN	42	60	8		GALGHD								
R450412-2P	1	 DISTRIBUCIÓN	45	60	7		GALGHD								
R450412P R450412N	2	 DISTRIBUCIÓN	42	60	10		GALGHD								
450435	2	 BASTÓN CIERRE BANCADA													
450758	1	 EMPAQUETADURA BANCADA (2)					JUEGO								
R452010V	1	 GUÍA VÁLVULAS (8) R452010V/1	7	9.8	10		RGV					Boxer TDI 1997/...	2445cc.	DJ5TED (THX) (SOHC) 8V DIESEL	452000-R
R470011V	1	 BANCADA	98	120	7		GALGHI								
R470012V	1	 DISTRIBUCIÓN	64	88	6		GALGHD								
R470013P R470013P/1 R470013V	1	 ÁRBOL DE LEVAS	35	50	7		GALG-BI								
R452015V	1	 AUXILIAR	32	52	7		GALGHI								
R470000	1	 KIT DE RETENES					JUEGO								
R470010P R470010V	1	 GUÍA VÁLVULAS (12) R260610V/1	7	9.8	10		RGV								
R470011V	1	 BANCADA	98	120	7		GALGHI	Boxer D/TD 1994/... 605 TD 1995/99	2445cc.	DJ5 (T9A) - DK5ATE DJ5T(T8A/THZ) (SOHC) 12V DIESEL	470000-R				
R470010P R470010V	1	 GUÍA VÁLVULAS (12) R260610V/1	7	9.8	10		RGV								



PEUGEOT

Código Code	Cant. Qty	Descripción Descrição Descrição	DE [mm]	DA [mm]	H [mm]	A [mm]		Aplicación Aplicação Application	Cm³ Cm³	Motor Motor Engine	Jgo. Juntas Set Gaskets				
R470012V	1	 DISTRIBUCIÓN	64	88	6		GALGHD	Boxer D/TD 1994/... 605 TD 1995/99	2445cc.	DJ5 (T9A) - DK5ATE DJ5T(T8A/THZ) (SOHC) 12V DIESEL	470000-R				
R470013P R470013P/1 R470013V	1	 ÁRBOL DE LEVAS	35	50	7		GALG-BI								
R470014V	1	 ÁRBOL DE LEVAS TRASERO	40	62	7		GALGHI								
R470015V	1	 AUXILIAR TRASERO	47.5	62	7		GALGHI								
R270100	1	 KIT DE RETENES					KIT	Boxer TDI/HDI 2001/09	2798cc.	8140.43 Euro II 8140.43S Euro III Common Rail (SOHC) 8V DIESEL	252901-R				
R270110P	1	 GUÍA VÁLVULAS (8) R430010V/1	8	12	9.5	15.2	RGV								
R270111V	1	 BANCADA	90	115	13		GALGHI								
PR270111V	1	 PORTA BANCADA	114				PORTA								
R270112P R270112V	1	 DISTRIBUCIÓN	70	90	10		GALGHD								
PR270112V	1	 PORTA DISTRIBUCIÓN	70				PORTA								
R270113P R270113V	1	 ÁRBOL DE LEVAS	50	70	10		GALGRD								
R270115V	1	 ÁRBOL DE LEVAS AUXILIAR	55	70	10		GALGHD								
R461510P	1	 GUÍA VÁLVULAS (12) R250410V/1	8	10.8	10		RGV					Pick Up, Camiónes Livianos 1976/...	3168cc.	XDP 6.90 DIESEL	500300-R
R450012P R450012N	1	 DISTRIBUCIÓN	42	60	10		GALGHD								
500258	1	 EMPAQUETADURA BANCADA (2)					JUEGO								
RASTROJERO															
R500010P	1	 GUÍA VÁLVULAS (8) R300310V/1	7.9	15.5	12.5		RGV	Pick Up, NP6 1955/66 Pick Up, Kombi, Frontal NC62/NP66, P63/P64 C66/P67 1964/71	1758cc. 1797cc.	Borgward D4M Borgward D301 - E1D DIESEL	500000-R 500100-R				
R500012N	1	 DISTRIBUCIÓN	42	68	10/16		GALGHD								
500258	1	 EMPAQUETADURA BANCADA (2)					JUEGO								
R500200 R500200-1	1	 KIT DE RETENES						404, T4B, T5B, Rastrojero 1972/...	1948cc.	XD/XDP 4.88 DIESEL	500200-R				
R460210V	1	 GUÍA VÁLVULAS (8) R250410V/1	8	10.8	10		RGV								
R500211-1S	1	 BANCADA REFORMA EXPANSIBLE	60	75	5		EXPAN								
R450012N R450012P	2	 DISTRIBUCIÓN	42	60	10		GALGHD								
R450412P R450412N	2	 DISTRIBUCIÓN	45	60	10		GALGHD								
500258	1	 EMPAQUETADURA BANCADA (2)					JUEGO								





















CATALOGO DE RETENES

CATALOGO DE RETENTORES - OIL SEAL CATALOG























RASTROJERO

Código Code	Cant. Qty	Descripción Descrição Descrição	DE [mm]	DA [mm]	H [mm]	A [mm]		Aplicación Aplicação Aplicacion	Cm³ Cm³	Motor Motor Engine	Jgo. Juntas Set Gaskets
R450012P R450012N	1	 DISTRIBUCIÓN	42	60	10		GALGHD	504 1980/..., J7/J9 1980/87 Adaptables Pick Up	2112cc.	XD-XDP 4.90 DIESEL	500600-R
R461510P	1	 GUÍA VÁLVULAS (12) R250410V/1	8	10.8	10		RGV	Pick Up, Camiónes Livianos 1976/...	3168cc.	XDP 6.90 DIESEL	500300-R
R450012P R450012N	1	 DISTRIBUCIÓN	42	60	10		GALGHD				
500258	1	 EMPAQUETADURA BANCADA (2)					JUEGO				

RENAULT

R550012N	1	 DISTRIBUCIÓN	32	50	10		GALGHD	Gordini, Floride, Dauphine 4L - 4F 1960/64	845cc.	670-04/05	550000-R
R550051N	1	 DIRECTA DE CAJA	13	26	9		GALG				
R550055N	1	 RUEDA TRASERA	36	54	7		G1				
R550012N	1	 DISTRIBUCIÓN	32	50	10		GALGHD	R5 1973/84	845cc.	839.01 - 800.10 (OHV) 8V	560300-R
R571210V	1	 GUÍA VÁLVULAS (12) R940010V/1	5	9	9.5		RGV	Kwid 2017/... Sanderó II y Logan 2017/...	999cc. 999cc.	B4D (DOHC) 12V B4D 409 (DOHC) 12V	571200-R MLS 571400-R MLS
R420613P	1	 ÁRBOL DE LEVAS	40	52	7		GALGHD				
R581010V	1	 GUÍA VÁLVULAS (16) R581010V/1	5.5	10.9	15.5	23	RGV	Clio 2000/... - Kangoo 2003/... Clio II, Kangoo .../00, Twingo Clio II, Kangoo 2001/...	999cc. 1149cc.	D4D D4D 700/712/720 D4F 702/706/712 (DOHC) 16V	581000-R 581000-R MLS
R581710V	1	 GUÍA VÁLVULAS (16) R581710V/1	5	8.20	7.85		RGV				
R570511V	1	 BANCADA	70	86	8		GALGHI				
R570512V	1	 DISTRIBUCIÓN	32	44	6		GALGHD				
R580013V	1	 ÁRBOL DE LEVAS	28	47	5.5		GALGHD				
R581710V	1	 GUÍA VÁLVULAS (16) R581710V/1	5	8.20	7.85		RGV				
R570511V	1	 BANCADA	70	86	8		GALGHI				
R570512V	1	 DISTRIBUCIÓN	32	44	6		GALGHD	Clio II 2005/..., Sanderó Logan 2008/..., Twingo 2004/...	1149cc.	D4F 708/728	581700-R MLS
R580013V	1	 ÁRBOL DE LEVAS	28	47	5.5		GALGHD				
R570500	1	 KIT DE RETENES									
R570510V	1	 GUÍA VÁLVULAS (8) R570510V/1	6	10.9	20	28.2	RGV	Twingo 1996/..., Clio 1995/... Kangoo 1997/... D7D Twingo 2001/...	1149cc.	D7F - D7D 734/730/700/701/710 (SOHC) 8V	570500-R
R570511V	1	 BANCADA REFORMA EXPANSIBLE	70	86	8		GALGHI				
R570512V	1	 DISTRIBUCIÓN	32	44	6		GALGHD				
R260113P R260113P/1 R260113V	1	 ÁRBOL DE LEVAS	30	42	7		GALGHD				





















RENAULT

Código Code	Cant. Qty	Descripción Descrição Descrição	DE [mm]	DA [mm]	H [mm]	A [mm]		Aplicación Aplicação Application	Cm³ Cm³	Motor Motor Engine	Jgo. Juntas Set Gaskets
R560800	1	 KIT DE RETENES					JUEGO	Clio, R19 1990/98	1171cc.	E5F/E7F (SOHC) 8V	560800-R
R560810P R560810V	1	 GUÍA VÁLVULAS (8) R260610V/1	7	9.8	10		RGV				
R570011V	1	 BANCADA	80	100	8		GALGRI				
R550613P R550613P/1 R550613V	1	 DISTRIBUCIÓN	35	47	7		GAHD				
R260113P R260113P/1 R260113V	1	 ÁRBOL DE LEVAS	30	42	7		GALGHD				
R570000	1	 KIT DE RETENES					KIT	Twingo, Clio, Express 1992/...	1239cc.	C3G (OHV) 8V	570000-R
R550910P R550910V R550910VM/1 R550910VM/2	1	 GUÍA VÁLVULAS (8) GUÍA VÁLVULAS (8) GRANEL CAJA (200) GRANEL (200)	8	10.8	10		RGV				
R550910T		 GUÍA VÁLVULAS (8) R550910T/1	8	10.8	10		RGV				
R570011V	1	 BANCADA	80	110	8		GALGRI				
R550412N R550412P R550412P/1 R550412V	1	 DISTRIBUCIÓN	35	50	9		GALGHD				
R550400	1	 KIT DE RETENES					JUEGO	R12/R4L/4S/R6/R4 1970/... R12TS/R15 1972/75	1289cc.	688.01/10-810.88 (OHV) 8V	550400-R
R550410P R550410PN/1	1	 GUÍA VÁLVULAS (8) BLISTER (200)	7	9.25	10		RGV				
R550411N R550411P	1	 BANCADA	70	90	10		GALGHI				
R550811P R550811PN/1 R550811V	1	 BANCADA	80	100	13		GARI				
R550412N R550412P R550412P/1 R550412V	1	 DISTRIBUCIÓN	35	50	9		GALGHD				
R550413P R550413N	1	 ÁRBOL DE LEVAS	30	42	8		GAHI				
R550447N	1	 VELOCÍMETRO	8.4	16	6.5		GA				
R550450N	1	 EJE DE EMBRAGUE	17	28	7/13		GAHD				
R550451N	1	 CAJA VELOCIDAD	15	26	7		GALG				
R550455N	1	 RUEDA TRASERA	34	52	10.7		GA				
R550458N	1	 RUEDA DELANTERA INTERIOR	50.8	69.85	9.53		GA				
R550459N	1	 RUEDA DELANTERA EXTERIOR	46.43	69.78	12.3		GALG				





















CATALOGO DE RETENES

CATALOGO DE RETENORES - OIL SEAL CATALOG

RENAULT

Código Code	Cant. Qty	Descripción Descrição Descrição	DE [mm]	DA [mm]	H [mm]	A [mm]		Aplicación Aplicação Aplicacion	Cm³ Cm³	Motor Motor Engine	Jgo. Juntas Set Gaskets
R550460N	1	 SEMIEJE	36	54	8/11		E-GALG C/ FILTRO	R12/R4L/4S/R6/R4 1970/... R12TS/R15 1972/75	1289cc.	688.01/10-810.88 (OHV) 8V	550400-R
R560800	1	 KIT DE RETENES					JUEGO	E6J/E7J Clio, R19, Express 1990/95, Kangoo 2001/... Megane 1995/97 Sanderio 2008/... Logan 2004/...	1390cc.	E6J/E7J Energy (SOHC) 8V	560800-R
R560810P R560810V	1	 GUÍA VÁLVULAS (8) R260610V/1	7	9.8	10		RGV		1390cc.	K7J 710/714 (SOHC) 8V	571000-R MLS
R570011V	1	 BANCADA	80	100	8		GALGRI				
R550613P R550613P/1 R550613V	1	 DISTRIBUCIÓN	35	47	7		GAHD				
R260113P R260113P/1 R260113V	1	 ÁRBOL DE LEVAS	30	42	7		GALGHD				
R570900	1	 KIT DE RETENES					JUEGO	K4J - Clio II 2001/... Scenic 1999/... Megane II 2003/...	1390cc.	K4J (DOHC) 16V	570900-R 570900 MLS
R570910V R570910VM/2 R570910VM/3	1	 GUÍA VÁLVULAS (16) A GRANEL (80) A GRANEL (480)	5.5	11	16.5	28	RGV				
R570011V	1	 BANCADA	80	100	8		GALGRI				
R550613P R550613P/1 R550613V	1	 DISTRIBUCIÓN	35	47	7		GAHD				
R570913V/1 R570913V	2	 ÁRBOL DE LEVAS	28	42	5		GALGHD				
R550910P R550910V R550910VM/1 R550910VM/2	1	 GUÍA VÁLVULAS (8) GUÍA VÁLVULAS (8) A GRANEL (200) A GRANEL (200)	8	10.8	10		RGV	R12TS/R5TX 1976/80	1397cc.	847 (OHV) 8V	550500-R
R550910T	1	 GUÍA VÁLVULAS (8) R550910T/1	8	10.8	10		RGV				
R550411N R550411P	1	 BANCADA	70	90	10		GALGHI				
R550412N R550412P R550412P/1 R550412V	1	 DISTRIBUCIÓN	35	50	9		GALGHD				
R550413P R550413N	1	 ÁRBOL DE LEVAS	30	42	8		GAHI				
R550515P	1	 AUXILIAR	12.7	25.4	6.5		GAHI				
R550550N	1	 EJE DE EMBRAGUE	24	36	8/12		GAHD				
R550555N	1	 RUEDA TRASERA	48.7	58	8.5		ESP				
R550910P R550910V R550910VM/1 R550910VM/2	1	 GUÍA VÁLVULAS (8) GUÍA VÁLVULAS (8) GRANEL CAJA (200) GRANEL (200)	8	10.8	10		RGV	R9 1981/89, R11 1983/89 R19/R21 1988/93 Super Cinco 1985/93 R12/R18, Junior, Trafic 1982/...	1397cc.	C1J - C2J 60/67HP (OHV) 8V	550700-R
R550910T	1	 GUÍA VÁLVULAS (8) R550910T/1	8	10.8	10		RGV		1397cc.	847 (OHV) 8V	550800-R





















RENAULT

Código Code	Cant. Qty	Descripción Descrição Descrição	DE [mm]	DA [mm]	H [mm]	A [mm]		Aplicación Aplicação Aplicacion	Cm³ Cm³	Motor Motor Engine	Jgo. Juntas Set Gaskets
R550811P R550811PN/1 R550811V	1	 BANCADA	80	100	13		GARI	R9 1981/89, R11 1983/89 R19/R21 1988/93 Super Cinco 1985/93 R12/R18, Junior, Trafic 1982/...	1397cc. 1397cc.	C1J - C2J 60/67HP (OHV) 8V 847 (OHV) 8V	550700-R 550800-R
R550412N R550412P R550412P/1 R550412V	1	 DISTRIBUCIÓN	35	50	9		GALGHD				
R550413P R550413N	1	 ÁRBOL DE LEVAS	30	42	8		GAHI				
R581310V	1	 GUÍA VÁLVULAS (8) R230510V/1	6	8.8	9.5		RGV	Clio II DCI 2001/... Series 700/702/704/710, Kangoo DCI 2001/... Series 700/702, Megane DCI 2002/... Series 722/728/729/704/710	1461cc.	K9K DCI (SOHC) 8V DIESEL	581201-R
R570011V	1	 BANCADA	80	100	8		GALGRI	Symbol Megane II, Sanderio DCI Serie 794, Sanderio Stepway DCI, Symbol DCI, Logan 2006/...	1461cc.	K9K DCI (SOHC) 8V DIESEL	581301-R
R550613P R550613P/1 R550613V	1	 DISTRIBUCIÓN	35	47	7		GAHD				
R570913V/1 R570913V	1	 ÁRBOL DE LEVAS	28	42	5		GALGHD				
R550900	1	 KIT DE RETENES					JUEGO	R9/R11/R12/R18/R19 1988/... R19, Clio, Express 1996/98	1565cc. 1597cc.	C1L - C2L Carburador C3L Inyección	550900-R 560500-R
R550910P R550910V R550910VM/1 R550910VM/2	1	 GUÍA VÁLVULAS (8) GUÍA VÁLVULAS (8) A GRANEL (200) A GRANEL (200)	8	10.8	10		RGV				
R550910T	1	 GUÍA VÁLVULAS (8) R550910T/1	8	10.8	10		RGV				
R550811P R550811PN/1 R550811V	1	 BANCADA	80	100	13		GARI				
R550412N R550412P R550412P/1 R550412V	1	 DISTRIBUCIÓN	35	50	9		GALGHD				
R550413P R550413N	1	 ÁRBOL DE LEVAS	30	42	8		GAHI				
R560600	1	 KIT DE RETENES					JUEGO	Express 1987/96, Super Cinco 1988/96, R9, R11 1988/89	1595cc.	F8M 720/730/736/760 Iny. Indirecta (SOHC) 8V DIESEL	560601-R (580700)
R560110P R560110V	1	 GUÍA VÁLVULAS (8) R250410V/1	8	10.8	10		RGV				
R560111P R560111V	1	 BANCADA	85	105	8		GALGRI				
R550612P R550612V	1	 DISTRIBUCIÓN	50	68	10		GALGRD				
R560113P R560113P/1 R560113V	1	 ÁRBOL DE LEVAS	25	42	7		GALGHD				
R560800	1	 KIT DE RETENES					JUEGO	Megane Scenic RN Clio 1998/..., Clio II 1998/05 Sanderio 2007/..., Symbol Logan 2007/13, Sanderio 2007/14 Symbol 2009/12, Logan II 2014/19 Sanderio II 2015/19	1598cc. 1598cc.	K7M - 744 (SOHC) 8V K7M - Flex (SOHC) 8V	570200-R 571300-R MLS
R560810P R560810V	1	 GUÍA VÁLVULAS (8) R260610V/1	7	9.8	10		RGV				
R570011V	1	 BANCADA	80	100	8		GALGRI				

























CATALOGO DE RETENES

CATALOGO DE RETENTORES - OIL SEAL CATALOG

RENAULT

Código Code	Cant. Qty	Descripción Descrição Descrição	DE [mm]	DA [mm]	H [mm]	A [mm]		Aplicación Aplicação Aplicacion	Cm³ Cm³	Motor Motor Engine	Jgo. Juntas Set Gaskets
R550613P R550613P/1 R550613V	1	 DISTRIBUCIÓN	35	47	7		GAHD	Megane Scenic RN Clio 1998/..., Clio II 1998/05 Sanderó 2007/..., Symbol Logan 2007/13, Sanderó 2007/14 Symbol 2009/12, Logan II 2014/19 Sanderó II 2015/19	1598cc. 1598cc.	K7M - 744 (SOHC) 8V K7M - Flex (SOHC) 8V	570200-R 571300-R MLS
R260113P R260113P/1 R260113V	1	 ÁRBOL DE LEVAS	30	42	7		GALGHD				
R570900	1	 KIT DE RETENES					JUEGO	K4M -Clio, Scenic, Megane Symbol Laguna 1998/00 Logan 2007/..., Fluence, Duster, Logan, Sanderó Stepway, Kangoo 2015/..., Duster 2016/...	1598cc.	K4M (DOHC) 16V	570900-R 570900 MLS
R570910V R570910VM/2 R570910VM/3	1	 GUÍA VÁLVULAS (16) A GRANEL (80) A GRANEL (480)	5.5	11	16.5	28	RGV				
R570011V	1	 BANCADA	80	100	8		GALGRI				
R550613P R550613P/1 R550613V	1	 DISTRIBUCIÓN	35	47	7		GAHD				
R570913V/1 R570913V	2	 ÁRBOL DE LEVAS	28	42	5		GALGHD				
R560100	1	 KIT DE RETENES					JUEGO	R19 1989/95, R11 1986/89 Clio 1990/93, R21, Trafic Super Cinco 1986/94	1721cc.	F2N - F3N (SOHC) 8V	560100-R
R560110P R560110V	1	 GUÍA VÁLVULAS (16) R250410V/1	8	10.8	10		RGV				
R560111P R560111V	1	 BANCADA	85	105	8		GALGRI				
R550612P R550612V	1	 DISTRIBUCIÓN	50	68	10		GALGRD				
R560113P R560113P/1 R560113V	1	 ÁRBOL DE LEVAS	25	42	7		GALGHD				
R560114P R560114V	1	 AUXILIAR	22	45	7		GALGHI				
R550615P R550615V R550615N	1	 AUXILIAR	30	40	7		GAHD				
R570110V	1	 GUÍA VÁLVULAS (12) R260610V/1	7	9.8	10		RGV	Clio 1991/97, R19 1989/96	1764cc.	F7P 700/704 F7P 720/722 (DOHC) 16V	570100-R
R560111P R560111V	1	 BANCADA	85	105	8		GALGRI				
R550612P R550612V	1	 DISTRIBUCIÓN	50	68	10		GALGRD				
R560113P R560113P/1 R560113V	2	 ÁRBOL DE LEVAS	25	42	7		GALGHD				
R580410V	1	 GUÍA VÁLVULAS (16) R260610V/1	7	9.8	10		RGV	Clio 1991/97, R19 1989/96	1764cc.	F7P 700/704/720/722 (DOHC) 16V	580400
R560113P R560113P/1 R560113V	1	 ÁRBOL DE LEVAS	25	42	7		GALGHD				
R570910V R570910VM/2 R570910VM/3	1	 GUÍA VÁLVULAS (16) A GRANEL (80) A GRANEL (480)	5.5	11	16.5	28	RGV	Laguna 1998/..., Laguna, Scenic, Megane Kangoo 2001/...	1783cc.	F4P (DOHC) 16V	580000-R























RENAULT

Código Code	Cant. Qty	Descripción Descrição Descrição	DE [mm]	DA [mm]	H [mm]	A [mm]		Aplicación Aplicação Aplicacion	Cm³ Cm³	Motor Motor Engine	Jgo. Juntas Set Gaskets				
R560611P R560611V	1	 BANCADA	85	105	11		GALGRI	Laguna 1998/..., Laguna, Scenic, Megane Kangoo 2001/...	1783cc.	F4P (DOHC) 16V	580000-R				
R570412P R570412V	1	 DISTRIBUCIÓN	42	54	6		GALGHD								
R570612V	1	 DISTRIBUCIÓN	35	47	5.5		GALGHD								
R580013V	2	 ÁRBOL DE LEVAS	28	47	5.5		GALGHD								
R560110P R560110V	1	 GUÍA VÁLVULAS (16) R250410V/1	8	10.8	10		RGV	R19, Clio, Laguna 1991/98	1794cc.	F3P Inyección (SOHC) 8V	560400-R				
R560111P R560111V	1	 BANCADA	85	105	8		GALGRI								
R550612P R550612V	1	 DISTRIBUCIÓN	50	68	10		GALGRD								
R560113P R560113P/1 R560113V	1	 ÁRBOL DE LEVAS	25	42	7		GALGHD								
R560114P R560114V	1	 AUXILIAR	22	45	7		GALGHI								
550658	1	 CIERRE BANCADA (4)					JUEGO								
R560600	1	 KIT DE RETENES					JUEGO					R9, Express, Clio, Kangoo Trafic, Scenic, Megane R19 DT 1991/96, Megane DT 1996/97, Scenic DT 19986/...	1870cc.	F8Q (SOHC) 8V DIESEL	560601-R 580901-R
R560110P R560110V	1	 GUÍA VÁLVULAS (8) R250410V/1	8	10.8	10		RGV								
R560111P R560111V	1	 BANCADA	85	105	8		GALGRI								
R560611P R560611V	1	 BANCADA	85	105	11		GALGRI								
R550612P R550612V	1	 DISTRIBUCIÓN	50	68	10		GALGRD								
R560113P R560113P/1 R560113V	1	 ÁRBOL DE LEVAS	25	42	7		GALGHD								
R560114P R560114V	1	 AUXILIAR	22	45	7		GALGHI								
550658	1	 CIERRE BANCADA (4)					JUEGO								
R560700	1	 KIT DE RETENES					JUEGO	R9, Express, Clio, Kangoo Trafic, Scenic, Megane Clio II 630/632/662 Kangoo 630/632/662 1998/... Rodeo Trafic 600/606 1998/... Express 644/648 1997/... Scenic 1999/... Megane 1997/...	1870cc.	F8Q (SOHC) 8V DIESEL (cárter de aluminio) F8Q Iny. Indirecta (SOHC) 8V DIESEL	560701-R 560701-R (580100)				
R560110P R560110V	1	 GUÍA VÁLVULAS (8) R250410V/1	8	10.8	10		RGV								
R560111P R560111V	1	 BANCADA	85	105	8		GALGRI								
R570412P R570412V	1	 DISTRIBUCIÓN	42	54	6		GALGRD								
R560113P R560113P/1 R560113V	1	 ÁRBOL DE LEVAS	25	42	7		GALGHD								
R560114P R560114V	1	 AUXILIAR	22	45	7		GALGHI								
550658	1	 CIERRE BANCADA (4)					JUEGO								























CATALOGO DE RETENES

CATALOGO DE RETENORES - OIL SEAL CATALOG

RENAULT

Código Code	Cant. Qty	Descripción Descrição Descrição	DE [mm]	DA [mm]	H [mm]	A [mm]		Aplicación Aplicação Application	Cm³ Cm³	Motor Motor Engine	Jgo. Juntas Set Gaskets
R570300	1	 KIT DE RETENES					KIT	Megane DTI, RN, RT Laguna 716/730/734/750 Scenic 736, Espace 722 1999/..., Kangoo 2000/... Megane Coupe DTI 731 2000/...	1870cc.	F9Q Turbo (SOHC) 8V DIESEL	570301-R
R560810P R560810V	1	 GUÍA VÁLVULAS (8) R260610V/1	7	9.8	10	RGV					
R560111P R560111V	1	 BANCADA	85	105	8	GALGRI					
R570412P R570412V	1	 DISTRIBUCIÓN	42	54	6	GALGRD					
R560113P R560113P/1 R560113V	1	 ÁRBOL DE LEVAS	25	42	7	GALGHD					
R550615P R550615V R550615N	1	 AUXILIAR	30	40	7	GAHD					
R570351P	1	 CAJA VELOCIDAD	27.95	70	10	GALGHD					
550658	1	 CIERRE BANCADA (4)				JUEGO					
R570110V	1	 GUÍA VÁLVULAS (12) R260610V/1	7	9.8	10	RGV	Laguna 700/704 1994/99 Safrane 710/711 1996/99 Space 1996/...	1948cc.	N7Q (DOHC) 16V	570600-R	
R570611V	1	 BANCADA	98	110	7	GALGRI					
R570612V	1	 DISTRIBUCIÓN	35	47	5.5	GALGHD					
R570613P R570613V	1	 ÁRBOL DE LEVAS	45	57	6.5	GALGHD					
R570614P	1	 ÁRBOL DE LEVAS TRASERO	30	47	6	GAHI					
R550600	1	 KIT DE RETENES				KIT					Master 1981/93, R18, Fuego 1981/86, Trafic, R21/R25 1983/94, Espace 1984/97 R20 1977/84
R550610P	1	 GUÍA VÁLVULAS (8) R250410V/1	7.7	10.2	10	RGV					
R550610T	1	 GUÍA VÁLVULAS (8) R450010T/1	7.7	10.2	10	RGV					
R550611P R550611V	1	 BANCADA	90	110	13	GALGRI					
R550612P R550612V	1	 DISTRIBUCIÓN	50	68	10	GALGRD					
R550613P R550613P/1 R550613V	1	 ÁRBOL DE LEVAS	35	47	7	GAHD					
R550614P	1	 AUXILIAR BOMBA NAFTA	8.1	14.3	4.2	U'RING					
R550615P R550615V R550615N	1	 AUXILIAR	30	40	7	GAHD					
R550648N	1	 SELECTOR CAJA VELOCIDAD	16	22.8	4.8	GA					
R550655N	1	 RUEDA TRASERA	60	70	9.1	ESP					

























RENAULT

Código Code	Cant. Qty	Descripción Descrição Descrição	DE [mm]	DA [mm]	H [mm]	A [mm]		Aplicación Aplicação Application	Cm³ Cm³	Motor Motor Engine	Jgo. Juntas Set Gaskets				
R550660N	1	 TUERCA CON RETEN DE SEMIEJE	26	42	8/17		EGALG	Master 1981/93, R18, Fuego 1981/86, Trafic, R21/R25 1983/94, Espace 1984/97 R20 1977/84	1995cc.	829 - J5R/J6R/J7R	550600-R				
550658	1	 CIERRE BANCADA (4)					JUEGO								
R570110V	1	 GUÍA VÁLVULAS (12) R260610V/1	7	9.8	10		RGV	Clio, Clio Williams 1993/... Megane Coupe 1995/99 Spider Sport 1993/...	1998cc.	F7R 700/710/714 (DOHC) 16V	570100-R				
R560111P R560111V	1	 BANCADA	85	105	8		GALGRI								
R550612P R550612V	1	 DISTRIBUCIÓN	50	68	10		GALGRD								
R560113P R560113P/1 R560113V	2	 ÁRBOL DE LEVAS	25	42	7		GALGHD								
R570400	1	 KIT DE RETENES					JUEGO								
R560110P R560110V	1	 GUÍA VÁLVULAS (8) R250410V/1	8	10.8	10		RGV	Megane RT, Scenic Laguna RT, RXE	1998cc.	F3R 722/796/729 (SOHC) 8V	570400-R				
R560111P R560111V	1	 BANCADA	85	105	8		GALGRI								
R570412P R570412V	1	 DISTRIBUCIÓN	42	54	6		GALGRD								
R560113P R560113P/1 R560113V	1	 ÁRBOL DE LEVAS	25	42	7		GALGHD								
R560114P R560114V	1	 AUXILIAR	22	45	7		GALGHI								
R550615P R550615V R550615N	1	 AUXILIAR	30	40	7		GAHD								
550658	1	 CIERRE BANCADA (4)					JUEGO								
R570910V R570910VM/2 R570910VM/3	1	 GUÍA VÁLVULAS (16) A GRANEL (200) A GRANEL (480)	5.5	11	16.5	28	RGV					Megane, Scenic, Espace Grand Espace, Laguna Master, Trafic 1999/... Clio II Sport 2001/... Duster 2011/...	1783cc.	F4R (DOHC) 16V	580000-R
R560611P R560611V	1	 BANCADA	85	105	11		GALGRI								
R570412P R570412V	1	 DISTRIBUCIÓN	42	54	6		GALGHD								
R570612V	1	 DISTRIBUCIÓN	35	47	5.5		GALGHD								
R580013V	2	 ÁRBOL DE LEVAS	28	47	5.5		GALGHD								
R902110P	1	 GUÍA VÁLVULAS (8) R902210P/1	5	9.4	10.9		RGV	Fluence, Megan III 2001/...	1998cc.	M4R 714 (DOHC) 16V	582200-R MLS				
R903411V	1	 BANCADA	84	117	8.5		GALGRI								
R902512P	1	 DISTRIBUCIÓN	46	58	7		GALGHD								
R550600	1	 KIT DE RETENES					JUEGO	R18 1981/86, R21 1984/97 Trafic, Master 1981/97	2068cc.	121 (SOHC) 8V DIESEL	560001-R				



















CATALOGO DE RETENES

CATALOGO DE RETENTORES - OIL SEAL CATALOG





RENAULT

Código Code	Cant. Qty	Descripción Descrição Descrição	DE [mm]	DA [mm]	H [mm]	A [mm]		Aplicación Aplicação Application	Cm³ Cm³	Motor Motor Engine	Jgo. Juntas Set Gaskets				
R550610P	1	 GUÍA VÁLVULAS (8) R250410V/1	7.7	10.2	10		RGV	R18 1981/86, R21 1984/97 Trafic, Master 1981/97	2068cc.	121 (SOHC) 8V DIESEL	560001-R				
R550610T	1	 GUÍA VÁLVULAS (8) R450010T/1	7.7	10.2	10		RGV								
R550611P R550611V	1	 BANCADA	90	110	13		GALGRI								
R550612P R550612V	1	 DISTRIBUCIÓN	50	68	10		GALGRD								
R550613P R550613P/1 R550613V	1	 ÁRBOL DE LEVAS	35	47	7		GAHD								
R550615P R550615V R550615N	1	 AUXILIAR	30	40	7		GAHD								
550658	1	 CIERRE BANCADA (4)					JUEGO								
R550600	1	 KIT DE RETENES					JUEGO	R25 1984/92, R18 1985/... R21, Espace 1986/97 Trafic, Master 1989/..., Fuego	2165cc.	851 - J7T (SOHC) 8V	550600-R				
R550610P	1	 GUÍA VÁLVULAS (8) R250410V/1	7.7	10.2	10		RGV								
R550610T	1	 GUÍA VÁLVULAS (8) R450010T/1	7.7	10.2	10		RGV								
R550611P R550611V	1	 BANCADA	90	110	13		GALGRI								
R550612P R550612V	1	 DISTRIBUCIÓN	50	68	10		GALGRD								
R550613P R550613P/1 R550613V	1	 ÁRBOL DE LEVAS	35	47	7		GAHD								
R550614P	1	 AUXILIAR BOMBA NAFTA	8.1	14.3	4.2		U'RING								
R550615P R550615V R550615N	1	 AUXILIAR	30	40	7		GAHD								
R550648N	1	 SELECTOR CAJA VELOCIDAD	16	22.8	4.8		GA								
R550655N	1	 RUEDA TRASERA	60	70	9.1		ESP								
R550660N	1	 TUERCA CON RETEN DE SEMIEJE	26	42	8/17		EGALG								
550658	1	 CIERRE BANCADA (4)					JUEGO								
R270115V	1	 ÁRBOL DE LEVAS AUXILIAR	55	70	10		GALGHD					B90 1986/88	2445cc.	8140.21 (SOHC) 8V	251400
R581810V	1	 GUÍA VÁLVULAS (16) R581810V/1	5	8.5	9.5		RGV					Master 2001/... Trafic 2003/...	2463cc.	G9U 720/724/730/750/754 (DOHC) 16V DIESEL	581800-R
R581811V	1	 BANCADA	93	108	7		GALGRI								
R581812V	1	 DISTRIBUCIÓN	60	75	7		GALGRD								
R581813V	1	 AUXILIAR DISTRIBUCIÓN	70	85	7		GALGRD								

RENAULT

Código Code	Cant. Qty	Descripción Descrição Descrição	DE [mm]	DA [mm]	H [mm]	A [mm]		Aplicación Aplicação Application	Cm³ Cm³	Motor Motor Engine	Jgo. Juntas Set Gaskets
R260113P R260113P/1 R260113V	1	 ÁRBOL DE LEVAS	30	42	7		GALGHD	Master 2001/... Trafic 2003/...	2463cc.	G9U 720/724/730/750/754 (DOHC) 16V DIESEL	581800-R
R581410V	1	 GUÍA VÁLVULAS (12) R260610V/1	7	9.8	10		RGV	Koleos 4x2/4x4	2488cc.	2TR (DOHC) 16V	582100-R MLS
R902111P	1	 BANCADA	84	104	11		GALGRI				
R902512P	1	 DISTRIBUCIÓN	46	58	7		GALGHD				
R270100	1	 KIT DE RETENES					KIT	Master 1990/... - 1998/... Trafic 1990/...	2499cc.	S8U 742/748/770/772 758/780/782 (SOHC) 8V DIESEL	270400-R 270401-R
R270110P	1	 GUÍA VÁLVULAS (8) R430010V/1	8	12	9.5	15.2	RGV	Jumper HDI 2001/09	2798cc.	8140.43 Euro II 8140.43S Euro III Common Rail (SOHC) 8V DIESEL	252901-R
R270111V	1	 BANCADA	90	115	13		GALGHI				
PR270111V	1	 PORTA BANCADA	114				PORTA				
R270112P R270112V	1	 DISTRIBUCIÓN	70	90	10		GALGHD				
PR270112V	1	 PORTA DISTRIBUCIÓN	70				PORTA				
R270113P R270113V	1	 ÁRBOL DE LEVAS	50	70	10		GALGRD				
R270115V	1	 ÁRBOL DE LEVAS AUXILIAR	55	70	10		GALGHD				
R270100	1	 KIT DE RETENES					KIT	Master TD 1998/...	2799cc.	S9W 700/702 (SOHC) 8V DIESEL	270300-R 270301-R
R270110P	1	 GUÍA VÁLVULAS (8) R430010V/1	8	12	9.5	15.2	RGV				
R270111V	1	 BANCADA	90	115	13		GALGHI				
R270311V	1	 BANCADA	100	118	10		GALGHI				
R270112P R270112V	1	 DISTRIBUCIÓN	70	90	10		GALGHD				
R270113P R270113V	1	 ÁRBOL DE LEVAS	50	70	10		GALGRD				
R270115V	1	 ÁRBOL DE LEVAS AUXILIAR	55	70	10		GALGHD				



ROVER























R860010V	1	 GUÍA VÁLVULAS (8) R860010V/1	6	11.7	13.8		RGV	Metro, 111 1990/94 111 1995/98	1120cc.	11K2A/D (SOHC) 8V	860000-R
R860011P	1	 BANCADA	79	126	1.25		ESPHI	Metro, 114/214 1990/94 Metro, 114/214 1995/99	1396cc.	14K2A/D (SOHC) 8V	
R860012P	1	 DISTRIBUCIÓN	27	39.5	7		GALGHD				
R860013P R860013S	2	 ÁRBOL DE LEVAS	30	40	7		GA-B				
R460710V R460710P	1	 GUÍA VÁLVULAS (8) R260610V/1	7	9.8	10		RGV	114, Metro 1992/94	1361cc.	TUD3 (K9A) (SOHC) 8V DIESEL	470400-R

CATALOGO DE RETENES

CATALOGO DE RETENTORES - OIL SEAL CATALOG

ROVER





Código Code	Cant. Qty	Descripción Descrição Descrição	DE [mm]	DA [mm]	H [mm]	A [mm]		Aplicación Aplicação Application	Cm³ Cm³	Motor Motor Engine	Jgo. Juntas Set Gaskets
R220411P R220411P/1 R220411V R220411VF	1	 BANCADA	85	105	12		GALGRI	114, Metro 1992/94	1361cc.	TUD3 (K9A) (SOHC) 8V DIESEL	470400-R
R460712V	1	 DISTRIBUCIÓN	42	66	8		GALGHD				
R460213P R460213V	1	 ÁRBOL DE LEVAS	36	50	8		GALGHD				
R860110V	1	 GUÍA VÁLVULAS (16) R860110V/1	5	9.5	9.5		RGV	214/414 1995/99 25,45 1999/...	1396cc.	14K16 (DOHC) 16V	860100-R
R860011P	1	 BANCADA	79	126	1.25		ESPHI	216/416 1996/99, 25, 45 1999/...	1589cc.	K16 (DOHC) 16V	860100-R
R860012P	1	 DISTRIBUCIÓN	27	39.5	7		GALGHD				
R860013P R860013S	2	 ÁRBOL DE LEVAS	30	40	7		GA-B				
R460700	1	 KIT DE RETENES					JUEGO	115TD 1995/98	1527cc.	TUD5 (VJZ) (SOHC) 8V DIESEL	470300-R
R460710V R460710P	1	 GUÍA VÁLVULAS (8) R260610V/1	7	9.8	10		RGV				
R560111P R560111V	1	 BANCADA	85	105	8		GALGRI				
R460712V	1	 DISTRIBUCIÓN	42	66	8		GALGHD				
R460213P R460213V	1	 ÁRBOL DE LEVAS	36	50	8		GALGHD				
R250211P R250211N	1	 BANCADA	80	100	10		GALGHI	216/416 1989/92 216/416 1992/94	1590cc. 1590cc.	D16A7 (SOHC) 16V DIESEL D16A6 (SOHC) 16V DIESEL	860300-R 860400-R
R460300	1	 KIT DE RETENES					JUEGO	218 TD, 418 TD 1991/96 Tourer TD 1996/...	1769cc. 1905cc.	XUD7T/TE (SOHC) 8V DIESEL XUD9A (SOHC) 8V - DIESE	460301-R (470700) 460301-R 460300-R-1M 460300-R-2M 460300-R-3M
R460210V	1	 GUÍA VÁLVULAS (8) R250410V/1	8	10.8	10		RGV				
R460211V	1	 BANCADA	90	110	7		GALGRI				
R460212P R460212V	1	 DISTRIBUCIÓN	42	62	7		GALGHD				
R470013P R470013P/1 R470013V	1	 ÁRBOL DE LEVAS	35	50	7		GALG-BI				
460235	2	 BASTÓN CIERRE BANCADA									
R860110V	1	 GUÍA VÁLVULAS (16) R860110V/1	5	9.5	9.5		RGV	200 Vi 218 Coupe 1995/...	1796cc.	18K16 (DOHC) 16V	860100-R
R860011P	1	 BANCADA	79	126	1.25		ESPHI				
R860012P	1	 DISTRIBUCIÓN	27	39.5	7		GALGHD				
R860013P R860013S	2	 ÁRBOL DE LEVAS	30	40	7		GA-B				
R860810V	1	 GUÍA VÁLVULAS (16) R860810V/1	5	11	10		RGV	618 1996/99	1850cc.	F18A3 (SOHC) 16V	860800-R

ROVER												
Código Code	Cant. Qty	Descripción Descrição Descrição	DE [mm]	DA [mm]	H [mm]	A [mm]		Aplicación Aplicação Application	Cm³ Cm³	Motor Motor Engine	Jgo. Juntas Set Gaskets	
R250211P R250211N	1	 BANCADA	80	100	10		GALGHI	618 1996/99	1850cc.	F18A3 (SOHC) 16V	860800-R	
R420610P	1	 GUÍA VÁLVULAS (8) R420610P/1	7.4	11.5	9		RGV	Maestro D/TD 1986/95 Montego TD 1988/95	1994cc.	Prima 65/80T DIESEL	420600-R	
R420611P	1	 BANCADA	88.9	105	9.5		GARI					
R420612P	1	 DISTRIBUCIÓN	35	45	7		GALGHD					
R420613P	1	 ÁRBOL DE LEVAS	40	52	7		GALGHD					
R420614P	1	 AUXILIAR	45	60	7		GALGHI					
R860210P	1	 GUÍA VÁLVULAS (16) R890610P/1	6	11.7	9.5	31	RGV					Freelander TCIE 1997/00 620 1995/99, 420TD, 220TD 620TD 1995/99, 25TD, 45TD 1999/...
R890610P	1	 GUÍA VÁLVULAS (8) R860210P/1	6	11	10.1		RGV	820, 820i, 820Si 1986/90 Inyección Multipunto	1994cc.	20HD - M16 (DOHC) 16V	890600-R	
R860810P	1	 GUÍA VÁLVULAS (16) R860810P/1	5	11	10		RGV	620, 620 SI 1993/97 623 1993/97	1997cc. 2259cc	F20Z1 - F20Z2 (SOHC) 16V H23A3 (DOHC) 16V	860800-R 861000-R	
R250211P R250211N	1	 BANCADA	80	100	10		GALGHI	Range Rover TD 1986/89	2393cc.	VM492HT (OHV) 8V DIESEL	500401	
R500411P	1	 BANCADA	90	120	12		G1ALGHI					
R500412P	1	 DISTRIBUCIÓN	56	80	10		GAHD					
R430010V R430010VM/1 R430010VM/2	1	 GUÍA VÁLVULAS (8) A GRANEL (200) A GRANEL (200)	8	12	9.5	15.2	RGV	Range Rover TDI Discovery TDI, Defender TDI 1990/94 - 1994/98	2495cc.	200/300 TDI DIESEL	430001-R	
PR430011V PR430011VF	1	 PORTA BANCADA	99.45				PORTA					
R430012V	1	 DISTRIBUCIÓN	57	71	9		GALGRD					
R430013V	1	 ÁRBOL DE LEVAS	46.7	62	9		GALGHD					
R430015N	1	 GUARDAPOLVO CORREA DISTRIB.	57.5	74	8		GASRLG					
430058	2	 EMPAQUETADURA CIGÜEÑAL										
R950212P R950212V	1	 DISTRIBUCIÓN	48	65	10		GAHD	Range Rover Turbo 1994/02	2498cc.	D256TM (SOHC) 12V DIESEL	981201-R	
R520310P	1	 GUÍA VÁLVULAS (8) R520310V/1	7	11.4	9.8		RGV	825 TD 1996/99	2499cc.	VM425TD DIESEL	520301-R	
R310411P R310411V	1	 BANCADA	110	130	13		GALGHI					
R520312V	1	 DISTRIBUCIÓN	52	68	9.5		GALGHD					
R500411P	1	 BANCADA	90	120	12		G1ALGHI					Range Rover TD 1989/92
R500412P	1	 DISTRIBUCIÓN	56	80	10		GAHD					

















CATALOGO DE RETENES

CATALOGO DE RETENTORES - OIL SEAL CATALOG























SCANIA

Código Code	Cant. Qty	Descripción Descrição Descrição	DE [mm]	DA [mm]	H [mm]	A [mm]		Aplicación Aplicação Application	Cm³ Cm³	Motor Motor Engine	Jgo. Juntas Set Gaskets
R810111V	1	 BANCADA	130	160	15		GALGRI	Camión, Omnibús L75/76 L/LB/LBS110/L111/LB111 LS111/LT111/LBS111/LBT111 1974/... LB110/LBS110/L111/LS111 LT111/LBS111/LBT111/G112 L112/ R112/T112/P113 P113HK/R113/R113HK/T113 K113CBL/K113GLP/K113TLB K113TLP	11020cc.	D11/DS11 (OHV) 12V DIESEL	81000-R
R810012N	1	 AUXILIAR	35	62	7		GALG-BI		11020cc.	D11/DS11/DSC11 (OHV) 12V DIESEL	810100-R 810101-R
R810115V	1	 DISTRIBUCIÓN	80	100	12		G1LG-BI				
R810151V	1	 CAJA VELOCIDAD	55	75	9		G1LGHD				

SEAT

R250800		 KIT DE RETENES					JUEGO	Marbella 1989/94, 133 1974/78 850 1964/78, Panda 1980/... 127, Panda 45 1972/..., Ibiza Terra 1989/93	843cc.	08NCA (OHV) 8V	250800-R
R250810P	1	 GUÍA VÁLVULAS (8) R550410P/1	7	9.7	10.2		RGV		903cc.	08NCA/09NCA 164A (OHV) 8V	
R250811P R250811V R250811N	1	 BANCADA	64	80	8		G1ALGHD				
R250112P R250112N	1	 DISTRIBUCIÓN	42	56	7		ESP-G1				
R230210P R230210V	1	 GUÍA VÁLVULAS (8) R260610V/1	7	9.8	10		RGV	Ibiza, Cordoba 1996/...	999cc.	AER/ALL (SOHC) 8V	230600-R
R220411P R220411P/1 R220411V R220411VF	1	 BANCADA	85	105	12		GALGRI				
PR230211T PR230211V PR230211VF	1	 PORTA BANCADA	85				PORTA	Ibiza, Cordoba 1996/...	999cc.	AER/ALL (SOHC) 8V	230600-R
R230512P R230512P/1 R230512V	1	 DISTRIBUCIÓN	32	42	7		G1ALGHD				
R230113P R230113P/1 R230113V	2	 ÁRBOL DE LEVAS	32	47	10		GALG-BI				
R220410V	1	 GUÍA VÁLVULAS (8) R250410V/1	8	10.8	10		RGV	Ibiza 1993/94 Ibiza 1993/94 - 1993/99	1043cc. 1272cc.	AAU (SOHC) 8V 2G/AAV (SOHC) 8V	222000-R
R220411P R220411P/1 R220411V R220411VF	1	 BANCADA	85	105	12		GALGRI				
R230113P R230113P/1 R230113V	2	 ÁRBOL DE LEVAS	32	47	10		GALG-BI				
R230210P R230210V	1	 GUÍA VÁLVULAS (8) R260610V/1	7	9.8	10		RGV	Ibiza 2001/03, Cordoba 2001/05	1595cc.	APF/AKL/AEH/ANA ARM (SOHC) 8V	224300-R
PR221711V PR221711VF	1	 PORTA BANCADA	85				PORTA				
R230512P R230512P/1 R230512V	1	 DISTRIBUCIÓN	32	42	7		G1ALGHD				
R240013P R240013P/1 R240013V	1	 ÁRBOL DE LEVAS	35	48	7		GALGHD				



















SEAT

Código Code	Cant. Qty	Descripción Descrição Descrição	DE [mm]	DA [mm]	H [mm]	A [mm]		Aplicación Aplicação Application	Cm³ Cm³	Motor Motor Engine	Jgo. Juntas Set Gaskets
R224010V	1	 GUÍA VÁLVULAS (8) R230510V/1	6	8.8	9.5		RGV	Cordoba, Ibiza 2003/...	1598cc.	BAH (SOHC) 8V	224000-R 224000-R MLS
PR224011V	1	 PORTA BANCADA	85				PORTA				
R230512P R230512P/1 R230512V	1	 ÁRBOL DE LEVAS Y BOMBA DE ACEITE	32	42	7		G1ALGHD				
R230210P R230210V	1	 GUÍA VÁLVULAS (8) R260610V/1	7	9.8	10		RGV	Cordoba, Ibiza 1993/94	1598cc.	ABU (SOHC) 8V	223300
R230113P R230113P/1 R230113V	1	 ÁRBOL DE LEVAS	32	42	7		GALG-BI				
R250110P R250110PN/1	1	 GUÍA VÁLVULAS (8) A GRANEL (200)	7	11.8	10.2		RGV	1500 1963/71	1600cc.	115C (OHV) 8V	250200-R
R250211P R250211N	1	 BANCADA	80	100	10		GALGHI				
R250212N	1	 DISTRIBUCIÓN	45	65	10		E-GAHD				
R250255N	1	 RUEDA TRASERA EXTERIOR	30	45	8		GA				
R250256N	1	 RUEDA TRASERA INTERIOR	32.54	51.43	9.92		GA				
R250257N	1	 PIÑÓN	36	68	10/13		GAHD				
R250258N	1	 RUEDA DELANTERA	45	59	10		G1				
R220410V	1	 GUÍA VÁLVULAS (8) R250410V/1	8	10.8	10		RGV	Cordoba, Toledo, Ibiza 1994/97	1781cc.	ABS - ADZ (SOHC) 8V	221600
R230113P R230113P/1 R230113V	3	 ÁRBOL DE LEVAS Y DISTRIBUCIÓN	32	47	10		GALG-BI				
R221710V	1	 GUÍA VÁLVULAS (20) R230510V/1	6	8.8	9.5		RGV	Alhambra Turbo 1998/... Leon Turbo 1998/...	1781cc.	AJH/AJQ/APP Turbo 20V	221700-R
PR221711V PR221711VF	1	 PORTA BANCADA	85				PORTA				
R220411P R220411P/1 R220411V R220411VF	1	 BANCADA	85	105	12		GALGRI				
R230113P R230113P/1 R230113V	2	 ÁRBOL DE LEVAS	32	47	10		GALG-BI				
R240013P R240013P/1 R240013V	1	 ÁRBOL DE LEVAS	35	48	7		GALGHD				
R223810V	1	 GUÍA VÁLVULAS (16) R260610V/1	7	9.8	10		RGV	Cordoba, Ibiza 1994/97 Toledo GTI 1991/94	1781cc.	ADL - KR - PL (DOHC) 16V	223800
R230113P R230113P/1 R230113V	1	 ÁRBOL DE LEVAS	32	47	10		GALG-BI				
R230210P R230210V	1	 GUÍA VÁLVULAS (8) R260610V/1	7	9.8	10		RGV	Ibiza, Cordoba, Toledo 1993/94	1781cc.	ABS (SOHC) 8V	230300-R 230300-R MLS





CATALOGO DE RETENES

CATALOGO DE RETENTORES - OIL SEAL CATALOG





SEAT

Código Code	Cant. Qty	Descripción Descrição Descrição	DE [mm]	DA [mm]	H [mm]	A [mm]		Aplicación Aplicação Application	Cm³ Cm³	Motor Motor Engine	Jgo. Juntas Set Gaskets
R220411P R220411P/1 R220411V R220411VF	1	 BANCADA	85	105	12		GALGRI	Ibiza, Cordoba, Toledo 1993/94	1781cc.	ABS (SOHC) 8V	230300-R 230300-R MLS
R230113P R230113P/1 R230113V	1	 DISTRIBUCIÓN Y ÁRBOL DE LEVAS	32	47	10		GALG-BI				
R230210P R230210V	1	 GUÍA VÁLVULAS (8) R260610V/1	7	9.8	10		RGV	Alhambra TDI 2000/...	1896cc.	AUY (SOHC) 8V DIESEL	223501-R
PR230211T PR230211V PR230211VF	1	 PORTA BANCADA	85				PORTA				
R240013P R240013P/1 R240013V	1	 DISTRIBUCIÓN	35	48	7		GALGHD				
R230113P R230113P/1 R230113V	1	 ÁRBOL DE LEVAS	32	47	10		GALG-BI				
R230200	1	 KIT DE RETENES					JUEGO	Ibiza D/TD, Cordoba 1996/99 Toledo 1997/99	1896cc.	1Y - AAZ (SOHC) 8V DIESEL	230201-R
R220410V	1	 GUÍA VÁLVULAS (8) R250410V/1	8	10.8	10		RGV				
R230210P R230210V	1	 GUÍA VÁLVULAS (8) R260610V/1	7	9.8	10		RGV				
R220411P R220411P/1 R220411V R220411VF	1	 BANCADA	85	105	12		GALGRI				
PR230211T PR230211V PR230211VF	1	 PORTA BANCADA	85				PORTA				
R230113P R230113P/1 R230113V	3	 ÁRBOL DE LEVAS Y DISTRIBUCIÓN	32	47	10		GALG-BI				
R220400	1	 KIT DE RETENES					JUEGO	Ibiza SDI/TDI Cordoba SDI/TDI 1996/... Toledo TDI 1994/96 Inca SDI 1995/96 Alhambra TDI 1996/...	1896cc.	1Z - AFN - AHU - AEU (SOHC) 8V DIESEL	230901-R
R220410V	1	 GUÍA VÁLVULAS (8) R250410V/1	8	10.8	10		RGV				
R220411P R220411P/1 R220411V R220411VF	1	 BANCADA	85	105	12		GALGRI				
PR230211T PR230211V PR230211VF	1	 PORTA BANCADA	85				PORTA				
R230113P R230113P/1 R230113V	1	 ÁRBOL DE LEVAS	32	47	10		GALG-BI				
R220410V	1	 GUÍA VÁLVULAS (8) R250410V/1	8	10.8	10		RGV	Toledo, Ibiza, Cordoba 1991/94	1984cc.	2E (SOHC) 8V	223900
R230113P R230113P/1 R230113V	1	 ÁRBOL DE LEVAS	32	47	10		GALG-BI				





SEAT

Código Code	Cant. Qty	Descripción Descrição Descrição	DE [mm]	DA [mm]	H [mm]	A [mm]		Aplicación Aplicação Aplicacion	Cm³ Cm³	Motor Motor Engine	Jgo. Juntas Set Gaskets
R260610V R260610VM/1 R260610VM/2 R260610VM/3	1	 GUÍA VÁLVULAS (16) CAJA GRANEL (200) CAJA GRANEL (200) A GRANEL (1000)	8	10.8	10		RGV	Toledo 16V 1994/99, Ibiza Cordoba 1996/99 Hasta Motor 031251 Cordoba, Ibiza, Toledo 1993/99	1985cc. 1985cc.	ABF (DOHC) 16V ABF (DOHC) 16V	221900-R 222100-R
R220411P R220411P/1 R220411V R220411VF	1	 BANCADA	85	105	12		GALGRI				
R230113P R230113P/1 R230113V	3	 ÁRBOL DE LEVAS Y DISTRIBUCIÓN	32	47	10		GALG-BI				
R360112P	1	 DISTRIBUCIÓN	45	74.5	12/14.5	79.5	E-RD	131/132	1988cc.	OM 615 55HP (SOHC) 8V DIESEL	351600-R
360158	1	 EMPAQUETADURA CIGÜEÑAL									

SKODA

R230510P R230510V R230510VM/1 R230510VM/2 R230510VM/3 R230510VM/4	1	 GUÍA VÁLVULAS (8) GUÍA VÁLVULAS (8) A GRANEL (200) A GRANEL (200) A GRANEL (1000) A GRANEL (600)	6	8.8	9.5		RGV	Octavia 2004/...	1598cc.	BLF (DOHC) 16V	233300-R MLS
PR233311T	1	 PORTA BANCADA	84				PORTA				
R230113P R230113P/1 R230113V	2	 ÁRBOL DE LEVAS Y DISTRIBUCIÓN	32	47	10		GALG-BI				
R230210P R230210V	1	 GUÍA VÁLVULAS (8) R260610V/1	7	9.8	10		RGV	Octavia TDI 1996/...	1896cc.	AGR - AGP - AHF (SOHC) 8V DIESEL	223401-R
R240013P R240013P/1 R240013V	1	 DISTRIBUCIÓN	35	48	7		GALGHD				
R230113P R230113P/1 R230113V	1	 ÁRBOL DE LEVAS	32	47	10		GALG-BI				
R230210P R230210V	1	 GUÍA VÁLVULAS (8) R260610V/1	7	9.8	10		RGV	Octavia 1999/04	1984cc.	APK/AQY/AZH (SOHC) 8V	231100-R MLS
R220412P R220412V	1	 BANCADA	32	47	10		GALGHD				
R240013P R240013P/1 R240013V	1	 DISTRIBUCIÓN	35	48	7		GALGHD				







SSANGYOUNG

R450400 R450400-1 R450400-2	1	 KIT DE RETENES					JUEGO	Korando Family 1993/97	2498cc.	X3DP (OHV) 8V DIESEL	450701-R 450700-R-1M 450700-R-2M 450700-R-3M 450700-R-4M
R460210V	1	 GUÍA VÁLVULAS (8) R250410V/1	8	10.8	10		RGV				
R450411-1S	1	 BANCADA	64	80	5		EXPAN				
R450412-1P	1	 DISTRIBUCIÓN	42	60	8		GALGHD				
R450412-2P	1	 DISTRIBUCIÓN	45	60	7		GALGHD				





CATALOGO DE RETENES

CATALOGO DE RETENTORES - OIL SEAL CATALOG









SSANGYOUNG

Código Code	Cant. Qty	Descripción Descrição Descrição	DE [mm]	DA [mm]	H [mm]	A [mm]		Aplicación Aplicação Aplicacion	Cm³ Cm³	Motor Motor Engine	Jgo. Juntas Set Gaskets
R450412P R450412N	2	 DISTRIBUCIÓN	42	60	10		GALGHD	Korando Family 1993/97	2498cc.	X3DP (OHV) 8V DIESEL	450701-R 450700-R-1M 450700-R-2M 450700-R-3M 450700-R-4M
450435	2	 BASTÓN CIERRE BANCADA									
450758	1	 EMPAQUETADURA CIGÜEÑAL (2)					JUEGO				
R351110V	1	 GUÍA VÁLVULAS (5) GUÍA VÁLVULAS (5)	7.1 8.1	11.65 11.65	10.6 10.6		RGV	Korando KJ TDI Musso MJ TDI 1997/... Korando KJ 1996/... Musso MJ 1995/...	2874cc.	OM 662 (SOHC) 10V DIESEL MB602 (SOHC) 10V DIESEL	351100-R 351300-R
R351111V	1	 BANCADA	93	114	13		GALGHI		2874cc.		
R351112V	1	 DISTRIBUCIÓN	45	67	8		GALGHD				
R351155V	1	 RUEDA TRASERA	95	115	13		GALG-BI				

SUBARU

R950510P	1	 GUÍA VÁLVULAS (4) R950510P/1	7	12	13		RGV	K87/K87L, EK23/EK24 KF1/KT1 1981/...	544cc.	EK 23/24 4V	950500-R
R950511P R950511S	1	 BANCADA	57	77	10		GALGHI				
R950512P R950512N	1	 DISTRIBUCIÓN	30	46	8		GALGHD				
R950512P R950512N	1	 DISTRIBUCIÓN	30	46	8		GALGHD	Justy, Libero, Sumo 1984/... Justy 1987/93, Libero, Sumo 1990/97	997cc. 1189cc.	EF10 (SOHC) 6V EF12 (SOHC) 9V	951000-R 951100-R

















SUZUKI

R940011S	1	 BANCADA	60	80	8		GALGHI	Cervo, Alto, Carry, Carol 1988/90 Alto 1990/94 - 1998/00 Cervo 1990/98, Jimny 1995/98 Alto 1980/84 Jimny, Light Truck 1978/... ST100 1983/..., Samurai Jimny 1982/91, Super Carry 1985/99	547cc.	F5B (SOHC) 12V	916000-R
									657cc.	F6A (SOHC) 12V	916000-R
									795cc.	F8B - AB51 (SOHC) 6V	916100-R
									797cc.	F8A (SOHC) 8V	916200-R
									970cc.	F10A (SOHC) 8V	916300-R
R550613P R550613P/1 R550613V	1	 DISTRIBUCIÓN	35	47	7		GAHD	Wagon R 1997/00	996cc.	K10A (DOHC) 16V	916500-R MLS
R240400	1	 KIT DE RETENES					JUEGO	Fun 2002/...	999cc.	MPFI (SOHC) 8V	241200-R
R240210P R240210V R240210VM/1 R240210VM/2 R240210VM/3	1	 GUÍA VÁLVULAS (8) GUÍA VÁLVULAS (8) A GRANEL (200) A GRANEL (200) A GRANEL (1000)	7	11.1	10		RGV				
R240411P R240411P/1 R240411V	1	 BANCADA	80	98	10		G1ALGRI				
R240013P R240013P/1 R240013V	1	 ÁRBOL DE LEVAS	35	48	7		GALGHD				
R240415P R240415P/1 R240415V	1	 DISTRIBUCIÓN Y BOMBA DE ACEITE	26	42	8		G1ALGHD				
R240455N	1	 RUEDA TRASERA	40	52	8.5		E-GALG				







CATALOGO DE RETENES

CATALOGO DE RETENTORES - OIL SEAL CATALOG

SUZUKI

Código Code	Cant. Qty	Descripción Descrição Descrição	DE [mm]	DA [mm]	H [mm]	A [mm]		Aplicación Aplicação Application	Cm³ Cm³	Motor Motor Engine	Jgo. Juntas Set Gaskets
R460300	1	 KIT DE RETENES					JUEGO	Vitara 1995/96	1905cc.	XUD9 (SOHC) 8V DIESEL	460301-R 460300-R-1M 460300-R-2M 460300-R-3M 460301-R (460900)
R460210V	1	 GUÍA VÁLVULAS (8) R250410V/1	8	10.8	10		RGV	Vitara TD 1996/...	1905cc.	XUD9 TE (SOHC) 8V DIESEL	
R460211V	1	 BANCADA	90	110	7		GALGRI				
R460212P R460212V	1	 DISTRIBUCIÓN	42	62	7		GALGHD				
R470013P R470013P/1 R470013V	1	 ÁRBOL DE LEVAS	35	50	7		GALG-BI				
460235	2	 BASTÓN CIERRE BANCADA									
R470810V	1	 GUÍA VÁLVULAS (16) R470810V/1	6	10	21.5	19.6	RGV	Vitara HDI Grand Vitara HDI 2000/...	1997cc.	RHZ (SOHC) 8V DIESEL	470801-R
R460211V	1	 BANCADA	90	110	7		GALGRI				
R460212P R460212V	1	 DISTRIBUCIÓN	42	62	7		GALGHD				
R470813V	1	 ÁRBOL DE LEVAS	27	47	7		GALGHD				
460235	2	 BASTÓN CIERRE BANCADA									
R900900	1	 KIT DE RETENES					JUEGO	Vitara TD 1996/...	1998cc.	RF 8V DIESEL	910100-R
R900910P	1	 GUÍA VÁLVULAS (8) R900910P/1	7	13.9	14.5		RGV				
R460211V	1	 BANCADA	90	110	7		GALGRI				
R900912P	1	 DISTRIBUCIÓN	34	48	7		GALGHD				
R900913P	1	 ÁRBOL DE LEVAS	30	44	7		GALGHD				

TATA

R460300	1	 KIT DE RETENES					JUEGO	Sumo Telcoline TDI	1905cc.	4DL - NA 8V DIESEL	920701-R
R460210V	1	 GUÍA VÁLVULAS (8) R250410V/1	8	10.8	10		RGV				
R460211V	1	 BANCADA	90	110	7		GALGRI				
R460212P R460212V	1	 DISTRIBUCIÓN	42	62	7		GALGHD				
R470013P R470013P/1 R470013V	1	 ÁRBOL DE LEVAS	35	50	7		GALG-BI				
460235	2	 BASTÓN CIERRE BANCADA									











TOYOTA

R926610V	1	 GUÍA VÁLVULAS (16) R926610V/1 (8) R926610V/2 (8)	4.7 4.4	10.8 10.9	11.1 10		RGV	Etios Cross, Avanza Etios 2010/..., Yaris 2018/... Etios Liva 2012/...	1197cc. 1496cc.	3NR-FE 2NR-FE (DOHC) 16V DIESEL	926600-R MLS
----------	---	--------------------------------------------------------------------------------------------------------------------------------------------	------------	--------------	------------	--	-----	------------------------------------------------------------------------------	--------------------	---------------------------------------	--------------

























CATALOGO DE RETENES

CATALOGO DE RETENTORES - OIL SEAL CATALOG

TOYOTA

Código Code	Cant. Qty	Descripción Descrição Descrição	DE [mm]	DA [mm]	H [mm]	A [mm]		Aplicación Aplicação Aplicacion	Cm³ Cm³	Motor Motor Engine	Jgo. Juntas Set Gaskets
R926611V	1	 BANCADA	78	105	7.5			Etios Cross - Avanza Etios 2010/..., Yaris 2018/... Etios Liva 2012/...	1197cc. 1496cc.	3NR-FE 2NR-FE (DOHC) 16V DIESEL	926600-R MLS
R926612V	1	 DISTRIBUCIÓN	36	48	6						
R922810P	1	 GUÍA VÁLVULAS (16) R922810P/1 (8) R922810P/2 (8)	4.35 5.05	10.1 10.2	10.15 10		RGV	Corolla 1999/... Corolla 1999/..., Avensis 2000/..., Corolla Verso 2001/... Corolla 19997/98, Celica MR2 Spider 1999/05 Rav 4 2000/04, Corolla Verso 2001/..., Matrix 2003/08	1398cc. 1598cc	4ZZ-FE (DOHC) 16V 3ZZ-FE (DOHC) 16V 1ZZ-FE (DOHC) 16V	923300-R
R923311V	1	 BANCADA	76	94	8.5						
R923312V	1	 DISTRIBUCIÓN	38	50	8						
R910613P	1	 ÁRBOL DE LEVAS	32	46	6		GALGHD	Corolla 1992/99, Avensis 1997/00, Sprinter 1991/... Spacio 1998/99	1587cc. 1587cc.	4A-FE (DOHC) 16V 4A-FE (DOHC) 16V	922900-R 924900-R MLS
R970010P	1	 GUÍA VÁLVULAS (8) R970010P/1	6	12.5	12		RGV	Corolla, Corona, Carina Celica, Town Ace, Camry 1976/80	1588cc.	12TU/2TJ (OHV) 8V	970000-R
R970011P R970011S	1	 BANCADA	75	100	13		GALGRI				
R970012P R970012N	1	 DISTRIBUCIÓN	38.5	58	11		GALGHD				
R950410P	1	 GUÍA VÁLVULAS (8) R950410P/1	7	13.5	21		RGV	Corona 1970/74 Corona, Mark II 1968/70	1591cc. 1707cc.	7R (OHC) 8V 6R (OHC) 8V	950400-R
R950411S	1	 BANCADA	80	100	12		GALGHI				
R550811P R550811PN/1 R550811V	1	 BANCADA	80	100	13		GARI				
R500112N	1	 DISTRIBUCIÓN	45	68	10/16		GALGHD				
R950412N	1	 DISTRIBUCIÓN	45	68	12		GALG				
R910613P	1	 ÁRBOL DE LEVAS	32	46	6		GALGHD	Corolla 1992/97, Celica 1993/99, Corolla CE 1997/...	1762cc.	7A-FE (DOHC) 16V	924900-R MLS
R970010P	1	 GUÍA VÁLVULAS (8) R970010P/1	6	12.5	12		RGV	Carina, Celica, Corona Corolla, Cressida, Camry Town Ace 1978/80	1770cc.	3TEU/13TU (OHV) 8V	970000-R
R970011P R970011S	1	 BANCADA	75	100	13		GALGRI				
R970012P R970012N	1	 DISTRIBUCIÓN	38.5	58	11		GALGHD				
R450412-1P	1	 DISTRIBUCIÓN	42	60	8		GALGHD	Corolla, Lite-Ace, Town-Ace 1984/88, Camry TD, Vysta TE 1983/85	1839cc.	1CL - 1CTL (SOHC) 8V DIESEL	920500-R
R950410P	1	 GUÍA VÁLVULAS (8) R950410P/1	7	13.5	21		RGV	Corona, Mark II 1973/... Celica 1976/... Corona Mark II 1969/74 Celica, Hilux Pick Up 1970/... Corona, Cressida, Hi Lux Carina 1972/..., Celica, Mark II, Hi Ace 1976/...	1808cc. 1858cc. 1968cc.	16R (OHC) 8V 8R (OHC) 8V 18R (OHC) 8V	950400-R
R950411S	1	 BANCADA	80	100	12		GALGHI				
R550811P R550811PN/1 R550811V	1	 BANCADA	80	100	13		GARI				
R500112N	1	 DISTRIBUCIÓN	45	68	10/16		GALGHD				
R950412N	1	 DISTRIBUCIÓN	45	68	12		GALG				















TOYOTA

Código Code	Cant. Qty	Descripción Descrição Descrição	DE [mm]	DA [mm]	H [mm]	A [mm]		Aplicación Aplicação Application	Cm³ Cm³	Motor Motor Engine	Jgo. Juntas Set Gaskets
R460211V	1	 BANCADA	90	110	7		GALGRI	Town Ace D, Camry D 1989/... Camry TD 1985/91 Carina II D 1984/92	1975cc.	2C/2C-T/2C-TE (SOHC) 8V DIESEL	920400-R
R450412-1P	1	 DISTRIBUCIÓN	42	60	8		GALGHD	Carina E TD 1996/... Corona D, Lite Ace 1983/96			
R240411P R240411P/1 R240411V	1	 BANCADA	80	98	10		G1ALGRI	Hi-Ace, Toyo-Ace, Hi-Lux Crown, Chasser, Cressida Mark II 1977/85	2188cc.	L (SOHC) 8V DIESEL	921800-R
R922510P	1	 GUÍA VÁLVULAS (8) R922510P/1	8	13	10.4		RGV	Town-Ace 1985/90, Hi-Lux Van 1989/93, Lite-Ace 1992/95, Dyna 200 1995/...	2237cc.	4Y (OHV) 8V	923500-R
R570011V	1	 BANCADA	80	100	8		GALGRI				
R950711P	1	 BANCADA	60	78	10		GALGHI				
R922810P	1	 GUÍA VÁLVULAS (16) R922810P/1 (8) R922810P/2 (8)	4.35 5.05	10.1 10.2	10.15 10		RGV	Highlander 2000/... Camry 2002/..., Rav 4 Solara, Avensis, Verso 2003/...	2362cc.	2AZ-FE (DOHC)16V	922800-R MLS
R420611P	1	 BANCADA	88.9	105	9.5		GARI				
R250211P R250211N	1	 BANCADA	80	100	10		GALGHI	Celica, Corona, Pick Up Coaster, Hi-Lux 1982/84	2366cc.	22R/22REC (SOHC) 8V	925100-R
R922510P	1	 GUÍA VÁLVULAS (8) R922510P/1	8	13	10.4		RGV	Corona, Celica, Hi-Lux 4 Runner 1985/95	2366cc.	22R 97HP - 22REC (SOHC) 8V	923600-R
R250211P R250211N	1	 BANCADA	80	100	10		GALGHI	Celica, Hi-Lux, Corona 4 Runner 1980/84	2367cc.	22R/REC (OHC) 8V	922500-RMX
R910611N	1	 BANCADA	85	105	10		GAHI	Hi-Lux, Dyna, Toyo-Ace Mark II, Corona, Land Cruiser Hi-Ace, Cressida 1988/...	2446cc.	2L (SOHC) 8V DIESEL	910600-R
R910612N R910612S	1	 DISTRIBUCIÓN	42	60	7		GALGHD	Hi Lux, Hi Ace III/IV 1988/01 Chasser, Cresta, Mark II 1989/..., Crown 1989/96 Land Cruiser 1990/95	2446cc.	2L (SOHC) 8V DIESEL	926700-R MLS
R910613P	1	 ÁRBOL DE LEVAS	32	46	6		GALGHD				
R921910P	1	 GUÍA VÁLVULAS (8) R921910P/1	8	13.6	9.6		RGV	Hi-Ace, Toyo-Ace, Hi-Lux Crown, Chasser, Cresta Cressida, Dyane Land Cruiser 1982/88	2446cc.	2L (SOHC) 8V DIESEL	921900-R
R910611N	1	 BANCADA	85	105	10		GAHI				
R922310V	1	 GUÍA VÁLVULAS (16) R922310V/1	4.7	10.7	11.1		RGV	Hi-Lux 2001/..., Hi-Lux TD D4D 2005/..., Dyna 150TD 2001/..., Hi-Ace TD 2001/...	2494cc.	2KD - FTV (DOHC) 16V DIESEL	922400-R
R922311V	1	 BANCADA	95	115	9/14						
R922312P R922312V	1	 DISTRIBUCIÓN	50	68	9.5/12						
R922313P R922313V	1	 AUXILIAR	65	79	7						
R500411P	1	 BANCADA	90	120	12		G1ALGHI	Land Cruiser 70 TD 1987/89 Land Cruiser 250 TD 1990/93	2494cc. 2499cc.	VM66A VM84A (OHV) 8V DIESEL	500401
R500412P	1	 DISTRIBUCIÓN	56	80	10		GAHD				
R910611N	1	 BANCADA	85	105	10		GAHI	Hi Lux, Hi Ace, Toyo Ace Land Cruiser 1988/...	2779cc.	3L (SOHC) 8V DIESEL	920100-R
R910612N R910612S	2	 DISTRIBUCIÓN	42	60	7		GALGHD				



CATALOGO DE RETENES

CATALOGO DE RETENTORES - OIL SEAL CATALOG











TOYOTA

Código Code	Cant. Qty	Descripción Descrição Descrição	DE [mm]	DA [mm]	H [mm]	A [mm]		Aplicación Aplicação Aplicacion	Cm³ Cm³	Motor Motor Engine	Jgo. Juntas Set Gaskets
R910613P	1	 ÁRBOL DE LEVAS	32	46	6		GALGHD	Hi Lux, Hi Ace, Toyo Ace Land Cruiser 1988/...	2779cc.	3L (SOHC) 8V DIESEL	920100-R
R922211S	1	 BANCADA	95	115	9.5		GALGHI	Hi-Lux TD, 4 Runner TD Land Cruiser TD 1993/96	2982cc.	1KZ-T/TE (SOHC) 8V DIESEL	922200-R
R550612P R550612V	1	 DISTRIBUCIÓN	50	68	10		GALGRD				
R910613P	1	 ÁRBOL DE LEVAS	32	46	6		GALGHD				
R922310V	1	 GUÍA VÁLVULAS (16) R922310V/1	4.7	10.7	11.1		RGV	Hi-Lux TD, D4D 2005/... Land Cruiser 90 TD 2000/... Land Cruiser 120 TD 2002/...	2982cc.	1KD - FTV (DOHC) 16V DIESEL	922300-R
R922311V	1	 BANCADA	95	115	9/14						
R922312P R922312V	1	 DISTRIBUCIÓN	50	68	9.5/12						
R922313P R922313V	1	 AUXILIAR	65	79	7						
R922310V	1	 GUÍA VÁLVULAS (16) R922310V/1	4.7	10.7	11.1		RGV	Hi-Lux TD 2005/...	2982cc.	1KD-FTV (DOHC) 16V	925400-R
R922311V	1	 BANCADA	95	115	9/14						
R922313P R922313V	1	 AUXILIAR	65	79	7						
R910611N	1	 BANCADA	85	105	10		GAHI				
R910612N R910612S	2	 DISTRIBUCIÓN	42	60	7		GALGHD	Hi-Lux LN147/152/167/172 1997/..., Hi-Ace LH162/172/174/181 1998/00, Dyna 150 1998/...	2987cc.	5L (SOHC) 8V DIESEL	922100-R
R910613P	1	 ÁRBOL DE LEVAS	32	46	6		GALGHD				
R922311V	1	 BANCADA	95	115	9/14						
								Dyna D, Toyo-Ace D 1984/88 Toyo-Ace TD, Dyna TD Land Cruiser TD 1984/89 Dyna 200, Coaster 1988/...	3431cc.	13B - 13B-T (OHV) 8V DIESEL	925900-R
								Coaster TD, Dyna 200 TD 1999/...	3661cc.	14B/BT (OHV) 8V DIESEL	926100-R
									4104cc.	15B-FT (OHV) 16V DIESEL	926200-R











VALMET

R310411P R310411V	1	 BANCADA	110	130	13		GALGHI	Tractor 65ID, Valmet 62ID 1970/76	2550cc.	D225-3	320800-R 320800
R310412P R310412V	1	 DISTRIBUCIÓN	78	100	13		GALGHD				
R310410V	1	 GUÍA VÁLVULAS (8) R310410V/1	9	13.4	11		RGV	Tractor 85ID 1970/76 Tractor 86-ID	3400cc. 4156cc.	D225-4 D226-4 (OHV) 8V	440000 320400-R 320400
R310411P R310411V	1	 BANCADA	110	130	13		GALGHI				
R310412P R310412V	1	 DISTRIBUCIÓN	78	100	13		GALGHD				
R310510V	1	 GUÍA VÁLVULAS (12) R310410V/1	9	13.4	11		RGV	Tractor 110 ID	5100cc.	D225-6	440100-R
R310411P R310411V	1	 BANCADA	110	130	13		GALGHI				
R310412P R310412V	1	 DISTRIBUCIÓN	78	100	13		GALGHD				

VM-BORGWARD

Código Code	Cant. Qty	Descripción Descrição Descrição	DE [mm]	DA [mm]	H [mm]	A [mm]		Aplicación Aplicação Application	Cm³ Cm³	Motor Motor Engine	Jgo. Juntas Set Gaskets
R500411P	1	 BANCADA	90	120	12		G1ALGHI	75TD 1984/92 75 TD 1989/92, 90TD 1984/97 Range Rover TD 1986/89	1995cc. 2393cc.	VM80A (OHV) 8V VM81A - VM492HT (OHV) 8V	500401
R500412P	1	 DISTRIBUCIÓN	56	80	10		GAHD	Land Cruiser 70 TD 1987/89	2494cc.	VM66A (OHV) 8V DIESEL	
R520310P	1	 GUÍA VÁLVULAS (8) R520310V/1	7	11.4	9.8		RGV	Dakota TD, Grand Voyager TD 1995/..., Cherokee, Grand Cherokee TD 1997/..., 825 TD 1996/99	2499cc.	VM425TD - VM41B DIESEL	520301-R
R310411P R310411V	1	 BANCADA	110	130	13		GALGHI				
R520312V	1	 DISTRIBUCIÓN	52	68	9.5		GALGHD				
R500411P	1	 BANCADA	90	120	12		G1ALGHI	155TD 1993/97 164TD 1987/92 - 1992/98 Scorpio TDI, Granada TDI 1993/94, Falcon 1988/...	2499cc.	VM84A - VM08B/7B VM31B/VM32B SCB - HR924HR (OHV) 8V DIESEL	500401
R500412P	1	 DISTRIBUCIÓN	56	80	10		GAHD	Range Rover TD 1989/92 Land Cruiser 250 TD 1990/93			
R520410P	1	 GUÍA VÁLVULAS (10) (R520310P/1)	7	11.4	9.8		RGV	Jeep Cherokee Grand Cherokee, Dakota Caravan 2001/...	3100cc.	VM531TD DIESEL	520401-R
R310411P R310411V	1	 BANCADA	110	130	10		GALGHI				
R520312V	1	 DISTRIBUCIÓN	52	68	9.5		GALGHD				



















VOLKSWAGEN

R310810P R310810V R310810VM/1 R310810VM/2	1	 GUÍA VÁLVULAS (8) GUÍA VÁLVULAS (8) A GRANEL (200) A GRANEL (200)	7	10.9	9.5		RGV	Gol 1.0 1993/...	997cc.	CHT/AE (SOHC) 8V	310700-R
R300711P	1	 BANCADA	82	105	12		GALGHI				
R550412N R550412P R550412P/1 R550412V	1	 DISTRIBUCIÓN	35	50	9		GALGHD				
R310760P R310760N	1	 SEMI EJE	40	55	9		G1LG-BI				
R224010V	1	 GUÍA VÁLVULAS (8) (R230510P/1)	6	8.8	9.5		RGV	Fox 2003/... Gol, Voyage 2008/...	999cc.	AQZ - BJE (SOHC) 8V	224200 MLS
PR224011T	1	 PORTA BANCADA	85				PORTA				
R230512P R230512P/1 R230512V	1	 ÁRBOL DE LEVAS Y BOMBA DE ACEITE	32	42	7		G1ALGHD				
R230510P R230510V R230510VM/1 R230510VM/2 R230510VM/3 R230510VM/4	1	 GUÍA VÁLVULAS (8) GUÍA VÁLVULAS (8) A GRANEL (200) A GRANEL (200) A GRANEL (1000) A GRANEL (600)	6	8.8	9.5		RGV	Gol 1000, Saveiro 1998/... Parati 1997/...	999cc.	AT (DOHC) 16V	230500-R
R220411P R220411P/1 R220411V R220411VF	1	 BANCADA	85	105	12		GALGRI				
PR230211T PR230211V PR230211VF	1	 PORTA BANCADA	85				PORTA				

CATALOGO DE RETENES

CATALOGO DE RETENTORES - OIL SEAL CATALOG























VOLKSWAGEN

Código Code	Cant. Qty	Descripción Descrição Descripción	DE [mm]	DA [mm]	H [mm]	A [mm]		Aplicación Aplicação Aplicacion	Cm³ Cm³	Motor Motor Engine	Jgo. Juntas Set Gaskets
R230512P R230512P/1 R230512V	1	 DISTRIBUCIÓN	32	42	7		G1ALGHD	Gol 1000, Saveiro 1998/... Parati 1997/...	999cc.	AT (DOHC) 16V	230500-R
R230113P R230113P/1 R230113V	3	 ÁRBOL DE LEVAS	32	47	10		GALG-BI				
R230513V	3	 ÁRBOL DE LEVAS	32	47	10		GALGHD				
R230210P R230210V	1	 GUÍA VÁLVULAS (8) R260610V/1	7	9.8	10		RGV	Gol 1000, Saveiro Polo 1995/..., Parati 1997/...	999cc.	AER/ALL (SOHC) 8V	230600-R
R220411P R220411P/1 R220411V R220411VF	1	 BANCADA	85	105	12		GALGRI				
PR230211T PR230211V PR230211VF	1	 PORTA BANCADA	85				PORTA				
R230512P R230512P/1 R230512V	1	 DISTRIBUCIÓN	32	42	7		G1ALGHD				
R230113P R230113P/1 R230113V	2	 ÁRBOL DE LEVAS	32	47	10		GALG-BI				
R230210P R230210V	1	 GUÍA VÁLVULAS (8) R260610V/1	7	9.8	10		RGV	Gol Power 2002/...	999cc.	AT (SOHC) 8V	231200-R MLS
PR231211T	1	 PORTA BANCADA	85				PORTA				
R230512P R230512P/1 R230512V	2	 DISTRIBUCIÓN Y ÁRBOL DE LEVAS	32	42	7		G1ALGHD				
R230510P R230510V R230510VM/1 R230510VM/2 R230510VM/3 R230510VM/4	1	 GUÍA VÁLVULAS (8) GUÍA VÁLVULAS (8) A GRANEL (200) A GRANEL (200) A GRANEL (1000) A GRANEL (600)	6	8.8	9.5		RGV	Gol Power 2002/...	999cc.	AT (DOHC) 16V	231300-R MLS
PR231211T	1	 PORTA BANCADA	85				PORTA				
R230512P R230512P/1 R230512V	1	 DISTRIBUCIÓN	32	2	7		G1ALGHD				
R231313V	1	 ÁRBOL DE LEVAS	27	42	8		G1ALGHD				
R220410V	1	 GUÍA VÁLVULAS (8) R250410V/1	8	10.8	10		RGV	Golf, Jetta 1985/91 Polo 1985/92, 1990/94	1043cc. 1272cc.	HZ/AAK/ACM/AAU (SOHC) 8V UN/UN/2G/AAV (SOHC) 8V	222000-R 222000-R 222000-R
R220411P R220411P/1 R220411V R220411VF	1	 BANCADA	85	105	12		GALGRI	Golf, Jetta, Polo 1987/94 Golf, Vento 1991/94	1391cc.	ABD (SOHC) 8V	
R230113P R230113P/1 R230113V	2	 ÁRBOL DE LEVAS	32	47	10		GALG-BI				
R220311P	1	 BANCADA	70	90	10		GAHI	Kombi, Escarabajo, Fusca 1969/...	1285cc.	Air Cooler	220300-R

CATALOGO DE RETENES

CATALOGO DE RETENTORES - OIL SEAL CATALOG























VOLKSWAGEN

Código Code	Cant. Qty	Descripción Descrição Descrição	DE [mm]	DA [mm]	H [mm]	A [mm]		Aplicación Aplicação Application	Cm³ Cm³	Motor Motor Engine	Jgo. Juntas Set Gaskets
R220349N	1	 EJE PILOTO	22.1	40	12/17		GALGHD	Kombi, Escarabajo, Fusca 1969/...	1285cc.	Air Cooler	220300-R
R220355N	1	 RUEDA	44.5	62	11		GALG-BI				
R220356N	1	 RUEDA TRASERA	48	72	7/8.5		GALG				
R220359N	1	 RUEDA INTERIOR	40.1	52	9		ESP-GALG				
R224010V	1	 GUÍA VÁLVULAS (8) R230510V/1	6	8.8	9.5		RGV	Fox 2005/..., Polo 2003/... Gol Power, Kombi 2006/...	1390cc.	BKR/BLM (SOHC) 8V EA111 (SOHC) 8V	224000-R 224000-R MLS 232600-R MLS
PR224011T	1	 PORTA BANCADA	85				PORTA				
R230512P R230512P/1 R230512V	2	 ÁRBOL DE LEVAS Y BOMBA DE ACEITE	32	42	7		G1ALGHD				
R231410V	1	 GUÍA VÁLVULAS (20) R230510V/1	6	8.8	9.5		RGV	Golf TSI 2005/07, Jetta TSI Tiguan TSI 2006/...	1390cc.	BLG/BMY/BWK/CAVA (DOHC) 16V	233900-R MLS
PR233311T	1	 PORTA BANCADA	85				PORTA				
R230113P R230113P/1 R230113V	2	 ÁRBOL DE LEVAS	32	47	10		GALG-BI				
R220400	1	 KIT DE RETENES					JUEGO	Passat, Golf, Dasher (USA) Scirocco, Rabbit 1974/82 Passat LS 1974/...	1457cc.	ZC/YJ/FL/FB/FD/FH FK (SOHC) 8V	220800-R
R220410V	1	 GUÍA VÁLVULAS (8) R250410V/1	8	10.8	10		RGV				
R220411P R220411P/1 R220411V R220411VF	1	 BANCADA	85	105	12		GALGRI				
R230113P R230113P/1 R230113V	3	 DISTRIBUCIÓN Y ÁRBOL DE LEVAS	32	47	10		GALG-BI				
R220400	1	 KIT DE RETENES					JUEGO	Passat, Dasher (USA) 1975/80 Caddy, Jetta, Scirocco, Golf Gacel 1975/84 Golf, Rabbit, Passat, Scirocco Jetta, Santana 1979/83 Caribe, Atlantic 1977/84 Passat TS/LSE 1983/...	1457cc.	EH/GH/JB/FT/FV/YP	220400-R
R220410V	1	 GUÍA VÁLVULAS (8) R250410V/1	8	10.8	10		RGV				
R220411P R220411P/1 R220411V R220411VF	1	 BANCADA	85	105	12		GALGRI		1588cc.	FN/FP/FS/FT/FR/FV WP/EM/WV/WY/YN YS/YY	220400-R
R220412P R220412P/1 R220412V	1	 DISTRIBUCIÓN	32	47	10		GALGHD				
R230113P R230113P/1 R230113V	3	 DISTRIBUCIÓN Y ÁRBOL DE LEVAS	32	47	10		GALG-BI				
R220455N	1	 RUEDA TRASERA	40	52	7.5		GALG				
R220100	1	 KIT DE RETENES					JUEGO	1500 1982/...	1498cc.	Hillman	220100-R
R220110P	1	 GUÍA VÁLVULAS (8) R300310P/1	7.9	15.5	12.5		RGV				





















CATALOGO DE RETENES

CATALOGO DE RETENTORES - OIL SEAL CATALOG

VOLKSWAGEN

Código Code	Cant. Qty	Descripción Descrição Descrição	DE [mm]	DA [mm]	H [mm]	A [mm]		Aplicación Aplicação Aplicacion	Cm³ Cm³	Motor Motor Engine	Jgo. Juntas Set Gaskets				
R220111P R220111N	1	 BANCADA	76.2	95.22	9.32		GARI	1500 1982/...	1498cc.	Hillman	220100-R				
R220112N R220112P	1	 DISTRIBUCIÓN	44.45	63.5	9.52		GAHD								
R220150N	1	 SALIDA CAJA VELOCIDAD	39.42	56	10.7		GALGRI								
R220158N	1	 RUEDA DELANTERA	44.45	53.97	4.57		GA								
220131	2	 BASTÓN CIERRE BANCADA													
R300700	1	 KIT DE RETENES					JUEGO	Saveiro, Voyage, Logus 1989/...	1555cc.	CHT/AE (SOHC) 8V	300700-R				
R310810P R310810V R310810VM/1 R310810VM/2	1	 GUÍA VÁLVULAS (8) GUÍA VÁLVULAS (8) A GRANEL (200) A GRANEL (200)	7	10.9	9.5		RGV								
R300711P	1	 BANCADA	82	105	12		GALGHI								
R470013P R470013P/1 R470013V	1	 ÁRBOL DE LEVAS	35	50	7		GALG-BI								
R300748N	1	 SELECTOR CAJA DE VELOCIDAD	15.5	28	6/15		ESP								
R300749N	1	 EJE PILOTO	17	28	7/10		GALGHD								
R300751P	1	 CAJA VELOCIDAD	21.5	40	7		GA HD								
R300755N	1	 RUEDA TRASERA	38	58.5	7		GA-BI								
R300759N	1	 RUEDA DELANTERA INTERNA	55	70	6/10		ESP								
R220400	1	 KIT DE RETENES										Senda, Saveiro, Caddy Golf D/TD, Passat, Kombi Santana 1981/86	1588cc.	CR/JK/JP/JR/JF/JX CS/CY (SOHC) 8V	230101-R
R220410V	1	 GUÍA VÁLVULAS (8) R250410V/1	8	10.8	10		RGV								
R220411P R220411P/1 R220411V R220411VF	1	 BANCADA	85	105	12		GALGRI								
R230113P R230113P/1 R230113V	3	 DISTRIBUCIÓN Y ÁRBOL DE LEVAS	32	47	10		GALG-BI								
R300751P	1	 EJE PILOTO	20	35	7/10.5		GAHD	Gacel, Senda, Voyage, Gol Santana, Passat, Apollo Logus 1985/...	1595cc.	AP (SOHC) 8V	220600-R				
R230210P R230210V	1	 GUÍA VÁLVULAS (8) R260610V/1	7	9.8	10		RGV	Caddy, Polo 1995/97	1595cc.	1F (SOHC) 8V	230300-R 230300-R MLS				
R220411P R220411P/1 R220411V R220411VF	1	 BANCADA	85	105	12		GALGRI								
R230113P R230113P/1 R230113V	3	 DISTRIBUCIÓN Y ÁRBOL DE LEVAS	32	47	10		GALG-BI								





















VOLKSWAGEN

Código Code	Cant. Qty	Descripción Descrição Descrição	DE [mm]	DA [mm]	H [mm]	A [mm]		Aplicación Aplicação Aplicacion	Cm³ Cm³	Motor Motor Engine	Jgo. Juntas Set Gaskets
R230210P R230210V	1	 GUÍA VÁLVULAS (8) R260610V/1	7	9.8	10		RGV	Derby, Bora, Passat, Golf 1999/...	1595cc.	APF/AKL/AEH (SOHC) 8V	224300-R
PR221711V PR221711VF	1	 PORTA BANCADA	85				PORTA				
R230512P R230512P/1 R230512V	1	 DISTRIBUCIÓN	32	42	7		G1ALGHD				
R240013P R240013P/1 R240013V	1	 ÁRBOL DE LEVAS	35	48	7		GALGHD				
R230510P R230510V R230510VM/1 R230510VM/2 R230510VM/3 R230510VM/4	1	 GUÍA VÁLVULAS (8) GUÍA VÁLVULAS (8) A GRANEL (200) A GRANEL (200) A GRANEL (1000) A GRANEL (600)	6	8.8	9.5		RGV	Golf FSI, Touran FSI Passat FSI, Jetta FSI 2005/... Eos FSI, Polo, Crosspolo 2006/...	1598cc.	BTS/BLF (DOHC) 16V	233300-R MLS
PR233311T	1	 PORTA BANCADA	84				PORTA				
R230113P R230113P/1 R230113V	2	 ÁRBOL DE LEVAS	32	47	10		GALG-BI				
R224010V	1	 GUÍA VÁLVULAS (8) R230510V/1	6	8.8	9.5		RGV	Polo, Caddy 1997/01 Gol 2001/... ,Lupo 2004/09 Crossfox, Fox 2005/... Fox Route, Suran 2006/... Voyage, Gol Trend 2009/... Kombi, Spacefox 2006/... Saveiro, Voyage 2009/...	1598cc.	BAH/BLH/BJA/BPA (SOHC) 8V	224000-R 224000-R MLS
PR224011T	1	 PORTA BANCADA	85				PORTA				
R230512P R230512P/1 R230512V	2	 ÁRBOL DE LEVAS Y BOMBA DE ACEITE	32	42	7		G1ALGHD				
R230210P R230210V	1	 GUÍA VÁLVULAS (8) R260610V/1	7	9.8	10		RGV	Golf, Vento 1992/94	1598cc.	ABU (SOHC) 8V	223300
R230113P R230113P/1 R230113V	1	 ÁRBOL DE LEVAS	32	47	10		GALG-BI				
R220400	1	 KIT DE RETENES					JUEGO	Rabbit, Dasher (USA) 1980/84 Jetta 1981/84, Scirocco 1981/83, Quantum 1982/83 Caribe, Atlantic 1977/84	1714cc.	EN	220400-R
R220410V	1	 GUÍA VÁLVULAS (8) R250410V/1	8	10.8	10		RGV				
R220411P R220411P/1 R220411V R220411VF	1	 BANCADA	85	105	12		GALGRI				
R220412P R220412P/1 R220412V	1	 DISTRIBUCIÓN	32	42	7		GALGHD				
R230113P R230113P/1 R230113V	3	 DISTRIBUCIÓN Y ÁRBOL DE LEVAS	32	47	10		GALG-BI				
R220455N	1	 RUEDA TRASERA	40	52	7.5		E-GALG				
R220400	1	 KIT DE RETENES					JUEGO	Gacel, Senda, Voyage, Gol Santana, Passat, Apollo Logus 1984/... Transporter T4 1990/92	1781cc.	AP (SOHC) 8V	220600-R
R220410V	1	 GUÍA VÁLVULAS (8) R250410V/1	8	10.8	10		RGV		1781cc.	PD (SOHC) 8V	221400-R





















CATALOGO DE RETENES

CATALOGO DE RETENTORES - OIL SEAL CATALOG

VOLKSWAGEN

Código Code	Cant. Qty	Descripción Descrição Descrição	DE [mm]	DA [mm]	H [mm]	A [mm]		Aplicación Aplicação Aplicacion	Cm³ Cm³	Motor Motor Engine	Jgo. Juntas Set Gaskets
R220411P R220411P/1 R220411V R220411VF	1	 BANCADA	85	105	12		GALGRI	Gacel, Senda, Voyage, Gol Santana, Passat, Apollo Logus 1984/... Transporter T4 1990/92	1781cc. 1781cc.	AP (SOHC) 8V PD (SOHC) 8V	220600-R 221400-R
R230113P R230113P/1 R230113V	3	 DISTRIBUCIÓN Y ÁRBOL DE LEVAS	32	47	10		GALG-BI				
R220649P	1	 EJE PILOTO	20	35	7/10.5		GAHD	Gacel, Senda, Voyage, Gol Santana, Passat, Apollo Logus 1984/...	1781cc.	AP (SOHC) 8V	220600-R
R220410V	1	 GUÍA VÁLVULAS (8) R250410V/1	8	10.8	10		RGV	Vento 1992/97, Passat 1991/96	1781cc.	AAM - ABS - ADZ (SOHC) 8V	221600
R230113P R230113P/1 R230113V	3	 DISTRIBUCIÓN Y ÁRBOL DE LEVAS	32	47	10		GALG-BI				
R221710V	1	 GUÍA VÁLVULAS (20) R230510V/1	6	8.8	9.5		RGV	New Beetle, Passat Turbo 1999/..., Golf, Sharan Turbo 1997/..., Bora Turbo 2000/... Passat 1996/99 - 1999/... Passat Turbo 1996/98	1781cc. 1781cc.	AGU/ARZ/AJH/AVC AWU/AWC/ARG/APT AEB/ANB - AFY/ADR (DOHC) 20V	221700-R 221800-R
PR221711V PR221711VF	1	 PORTA BANCADA	85				PORTA				
R220411P R220411P/1 R220411V R220411VF	1	 BANCADA	85	105	12		GALGRI				
R230113P R230113P/1 R230113V	2	 ÁRBOL DE LEVAS	32	47	10		GALG-BI				
R240013P R240013P/1 R240013V	1	 ÁRBOL DE LEVAS	35	48	7		GALGHD				
R223810V	1	 GUÍA VÁLVULAS (16) R260610V/1	7	9.8	10		RGV	Golf 1989/91, Jetta 1986/87 Scirocco 1985/92, Passat Corrado 1990/92	1781cc.	KR (DOHC) 16V	223800
R230113P R230113P/1 R230113V	1	 ÁRBOL DE LEVAS	32	47	10		GALG-BI				
R230210P R230210V	1	 GUÍA VÁLVULAS (8) R260610V/1	7	9.8	10		RGV	Golf 1991/99 Golf GLA 1995/98 Vento 1992/97, Polo Classic Passat 1991/96, Jetta 1994/96 Gol MI, Parati, Saveiro Santana 1997/...	1781cc.	AAM/ABS/ADZ/ADD (SOHC) 8V	230300-R 230300-R MLS
R220411P R220411P/1 R220411V R220411VF	1	 BANCADA	85	105	12		GALGRI				
R230113P R230113P/1 R230113V	3	 DISTRIBUCIÓN Y ÁRBOL DE LEVAS	32	47	10		GALG-BI				
R220200	1	 KIT DE RETENES						1800 1982/...	1798cc.	Hillman	220100-R
R220210P	1	 GUÍA VÁLVULAS (8) R220210P/1	7.9	14.8	9.2		RGV				
R220111N R220111P	1	 BANCADA	76.2	95.22	9.32		GARI				
R220112N R220112P	1	 DISTRIBUCIÓN	44.45	63.5	9.52		GAHD				
R220150N	1	 SALIDA CAJA VELOCIDAD	39.42	56	10.7		GALGRI				



















VOLKSWAGEN

Código Code	Cant. Qty	Descripción Descrição Descrição	DE [mm]	DA [mm]	H [mm]	A [mm]		Aplicación Aplicação Application	Cm³ Cm³	Motor Motor Engine	Jgo. Juntas Set Gaskets
R220158N	1	 RUEDA DELANTERA	44.45	53.97	4.57		GA	1800 1982/...	1798cc.	Hillman	220100-R
220131	2	 BASTÓN CIERRE BANCADA									
R230210P R230210V	1	 GUÍA VÁLVULAS (8) R260610V/1	7	9.8	10		RGV	Golf, Jetta, Combi Panel 1992/99 (Motor Fuel Injection con sello válvula de 7 mm)	1800cc.	L4 F.I	231600-R
R220411P R220411P/1 R220411V R220411VF	1	 BANCADA	85	105	12		GALGRI				
R230113P R230113P/1 R230113V	3	 DISTRIBUCIÓN Y ÁRBOL DE LEVAS	32	47	10		GALG-BI				
R230200	1	 KIT DE RETENES					JUEGO	Passat TD 1994/96, Golf D/TD Vento D/TD 1995/98 Polo D, Caddy 1995/...	1896cc.	1Y - AAZ - AEY (SOHC) 8V DIESEL	230201-R
R220410V	1	 GUÍA VÁLVULAS (8) R250410V/1	8	10.8	10		RGV				
R230210P R230210V	1	 GUÍA VÁLVULAS (8) R260610V/1	7	9.8	10		RGV				
R220411P R220411P/1 R220411V R220411VF	1	 BANCADA	85	105	12		GALGRI				
PR230211T PR230211V PR2302141VF	1	 PORTA BANCADA	85				PORTA				
R230113P R230113P/1 R230113V	3	 DISTRIBUCIÓN Y ÁRBOL DE LEVAS	32	47	10		GALG-BI				
R220400	1	 KIT DE RETENES					JUEGO	Golf SDI/TDI 1993/95-1999/... Vento SDI/TDI 1993/95 Sharan TDI 1995/96, Passat TDI 1993/95-1995/... Polo TDI/SDI 1995/96 Caddy SDI 1995/...	1896cc.	AHU/AVG/AEY/1Z AFN/AHH (SOHC) 8V DIESEL	230901-R
R220410V	1	 GUÍA VÁLVULAS (8) R250410V/1	8	10.8	10		RGV				
R220411P R220411P/1 R220411V R220411VF	1	 BANCADA	85	105	12		GALGRI				
PR230211T PR230211V PR230211VF	1	 PORTA BANCADA	85				PORTA				
R230113P R230113P/1 R230113V	3	 DISTRIBUCIÓN Y ÁRBOL DE LEVAS	32	47	10		GALG-BI				
R230210P R230210V	1	 GUÍA VÁLVULAS (8) R260610V/1	7	9.8	10		RGV	Bora, Golf SDI/TDI 1997/...	1896cc.	ALH/AHF/AGR/AGP (SOHC) 8V DIESEL	223401-R
R240013P R240013P/1 R240013V	1	 DISTRIBUCIÓN	35	48	7		GALGHD				
R230113P R230113P/1 R230113V	1	 ÁRBOL DE LEVAS	32	47	10		GALG-BI				
R230210P R230210V	1	 GUÍA VÁLVULAS (8) R260610V/1	7	9.8	10		RGV	Passat TDI 1999/... Sharan TDI 2000/... Transporter TDI 2003/...	1896cc.	ATJ/AUY/AXB/AXC (SOHC) 8V DIESEL	223501-R



















CATALOGO DE RETENES

CATALOGO DE RETENTORES - OIL SEAL CATALOG

VOLKSWAGEN

Código Code	Cant. Qty	Descripción Descrição Descrição	DE [mm]	DA [mm]	H [mm]	A [mm]		Aplicación Aplicação Application	Cm³ Cm³	Motor Motor Engine	Jgo. Juntas Set Gaskets
PR230211T PR230211V PR230211VF	1	 PORTA BANCADA	85				PORTA	Passat TDI 1999/... Sharan TDI 2000/... Transporter TDI 2003/...	1896cc.	ATJ/AUY/AXB/AXC (SOHC) 8V DIESEL	223501-R
R240013P R240013P/1 R240013V	1	 DISTRIBUCIÓN	35	48	7		GALGHD				
R230113P R230113P/1 R230113V	1	 ÁRBOL DE LEVAS	32	47	10		GALG-BI				
R230510P R230510V R230510VM/1 R230510VM/2 R230510VM/3 R230510VM/4	1	 GUÍA VÁLVULAS (8) GUÍA VÁLVULAS (8) A GRANEL (200) A GRANEL (200) A GRANEL (1000) A GRANEL (600)	6	8.8	9.5		RGV	Pick Up Amarok TDI 2010/... Inyección directa Common Rail	1968cc.	CDBA - CDCA (DOHC) 16V	232401-R
PR232411T PR232411T-2	1	 PORTA BANCADA	85				PORTA				
R240013P R240013P/1 R240013V	1	 BOMBA DE ACEITE	35	48	7		GALGHD				
R230113P R230113P/1 R230113V	2	 ÁRBOL DE LEVAS Y DISTRIBUCIÓN	32	47	10		GALG-BI				
R220400	1	 KIT DE RETENES						Transporter T4 1990/03	1969cc.	AAC (SOHC) 8V	221400-R
R220410V	1	 GUÍA VÁLVULAS (8) R250410V/1	8	10.8	10		RGV	Carat, Quantum, Pointer, Gol, Golf, Santana 1989/...	1984cc.	Audi 827 (SOHC) 8V	230000-R
R220411P R220411P/1 R220411V R220411VF	1	 BANCADA	85	105	12		GALGRI				
R230113P R230113P/1 R230113V	3	 DISTRIBUCIÓN Y ÁRBOL DE LEVAS	32	47	10		GALG-BI				
R220410V	1	 GUÍA VÁLVULAS (8) R250410V/1	8	10.8	10		RGV	Golf GTI, Vento, Passat Corrado 1991/94	1984cc.	2E (SOHC) 8V	223900
R230113P R230113P/1 R230113V	1	 ÁRBOL DE LEVAS	32	47	10		GALG-BI				
R230210P R230210V	1	 GUÍA VÁLVULAS (8) R260610V/1	7	9.8	10		RGV	Golf, Passat 1992/96 Polo 1999/..., Golf Cabrio 1999/02 - Desde Motor 031252	1984cc.	ATU/AWF/AWG/ABA AKR (SOHC) 8V	221000-R
R220411P R220411P/1 R220411V R220411VF	1	 BANCADA	85	105	12		GALGRI	Golf 1994/01, Passat 1994/96 Santana 1998/...	1984cc.	AP (SOHC) 8V	233000-R
R230113P R230113P/1 R230113V	3	 DISTRIBUCIÓN Y ÁRBOL DE LEVAS	32	47	10		GALG-BI				
R230210P R230210V	1	 GUÍA VÁLVULAS (8) R260610V/1	7	9.8	10		RGV	Jetta 1998/02, Golf 1998/01 New Beetle, Bora 1998/...	1984cc.	AZH/APK/AQY/ATM (SOHC) 8V	231100-R MLS
R220412P R220412V	1	 DISTRIBUCIÓN	32	47	10		GALGHD	Sharan 2000/... Polo BR 2002/...	1985cc.	BBX	231100-R MLS
R240013P R240013P/1 R240013V	1	 ÁRBOL DE LEVAS	35	48	7		GALGHD				













VOLKSWAGEN

Código Code	Cant. Qty	Descripción Descrição Descrição	DE [mm]	DA [mm]	H [mm]	A [mm]		Aplicación Aplicação Application	Cm³ Cm³	Motor Motor Engine	Jgo. Juntas Set Gaskets
R260610V R260610VM/1 R260610VM/2 R260610VM/3	1	 GUÍA VÁLVULAS (16) CAJA PLASTICA (200) CAJA PLASTICA (200) A GRANEL (1000)	7	9.8	10		RGV	Golf, Passat 1992/96 Hasta Motor 031251 Golf, Passat, Passat Variant 1992/97	1985cc. 1985cc.	ABF (DOHC) 16V ABF (DOHC) 16V	221900-R 222100-R
R220411P R220411P/1 R220411V R220411VF	1	 BANCADA	85	105	12		GALGRI				
R230113P R230113P/1 R230113V	3	 DISTRIBUCIÓN Y ÁRBOL DE LEVAS	32	47	10		GALG-BI				
R221110V	1	 GUÍA VÁLVULAS (10) R250410V/1	8	10.8	10		RGV	Passat, Santana 1983/88 Passat, Quantum 1985/88	1994cc. 2226cc.	JS, HP (SOHC) 10V KV, HY (SOHC) 10V	222200-R
R220411P R220411P/1 R220411V R220411VF	1	 BANCADA	85	105	12		GALGRI				
R240013P R240013P/1 R240013V	1	 DISTRIBUCIÓN	35	48	7		GALGHD				
R230113P R230113P/1 R230113V	2	 ÁRBOL DE LEVAS	32	47	10		GALG-BI				
R570011V	1	 BANCADA	80	100	8		GALGRI	Taro 1989/94	2237cc.	4Y (OHV) 8V	923500-R
R950711P	1	 DISTRIBUCIÓN	60	78	10		GALGHI				
R221110V	1	 GUÍA VÁLVULAS (10) R250410V/1	8	10.8	10		RGV	Transporter T4 1992/99 Transporter Syncro 1992/98 Eurovan, Caravelle 1997/...	2370cc. 2459cc.	AAB/AJA (SOHC) 10V DIESEL AJT/AGX/ACV (SOHC) 10V DIESEL	221101-R 221501-R
R220411P R220411P/1 R220411V R220411VF	1	 BANCADA	85	105	12		GALGRI	Transporter Syncro TDI Transporter T4 1998/... Transporter T4 TDI 1995/99 LT SDI 1996/... Eurovan 2001/04	2461cc.	AET/APL/AVT/L5 (SOHC) 10V	231500-R
R240013P R240013P/1 R240013V	1	 DISTRIBUCIÓN	35	48	7		GALGHD				
R230113P R230113P/1 R230113V	2	 ÁRBOL DE LEVAS	32	47	10		GALG-BI				
R231410V	1	 GUÍA VÁLVULAS (20) R230510V/1	6	8.8	9.5		RGV	Bora, Vento 2005/09	2480cc.	L5 BGP/BGQ (DOHC) 20V	231400-R MLS
R220411P R220411P/1 R220411V R220411VF	1	 BANCADA	85	105	12		GALGRI				
PR231411V	1	 PORTA BANCADA	55				PORTA				
R230710V	1	 GUÍA VÁLVULAS (12) R260610V/1	7	9.8	10		RGV	Passat VR6 1991/96 Golf VR6, Vento VR6 1992/97 Jetta 1993/...	2792cc.	AAA (DOHC) V6 12V DIESEL	230700-R
R220411P R220411P/1 R220411V R220411VF	1	 BANCADA	85	105	12		GALGRI	Passat VR6 1994/96 Golf VR6 1994/97	2862cc.	ABV (DOHC) V6 12V DIESEL	230700-R
R240013P R240013P/1 R240013V	1	 DISTRIBUCIÓN	35	48	7		GALGHD				













CATALOGO DE RETENES

CATALOGO DE RETENTORES - OIL SEAL CATALOG

VOLKSWAGEN

Código Code	Cant. Qty	Descripción Descrição Descrição	DE [mm]	DA [mm]	H [mm]	A [mm]		Aplicación Aplicação Application	Cm³ Cm³	Motor Motor Engine	Jgo. Juntas Set Gaskets
R330510V	1	 GUÍA VÁLVULAS (12) R310810V/1	7	10.9	9.5		RGV	LT TDI 1997/... Electronico 2002/06 LT TDI Electrónico 2002/06	2796cc. 2796cc. 2796cc.	AGK/ATA DIESEL BCQ DIESEL BCQ DIESEL	330500-R 330500-R 331100-R
R330511V	1	 BANCADA	91	111	10		G1ALGRI				
R250811P R250811V R250811N	1	 DISTRIBUCIÓN	64	80	8		G1ALGHD				
R310410V	1	 GUÍA VÁLVULAS (8) R310410V/1	9	13.4	11		RGV	7100/8120/8140/8150/13150 Constellation 13.180E/15.180E	4300cc. 4800cc.	4.10 X10 - 4.10T/TCA DIESEL 4.12TCE Common Rail (OHV) 8V DIESEL	330400-R 331200-R MLS
R330411V	1	 BANCADA	130	160	12		G1ALGRI				
R310412P R310412V	1	 DISTRIBUCIÓN	78	100	13		GALGHD				
R330710V	1	 GUÍA VÁLVULAS (12) R310410V/1	9	13.4	11		RGV	13180/15180/16210 26.260E/31.260E 17.260EOT/17.210EOD	6450cc. 7118cc.	6.10 X10 - 6.10T/TCA DIESEL 6.12 TCE Common Rail (OHV) 12V DIESEL	330700-R 331300-R MLS
R330411V	1	 BANCADA	130	160	12		G1ALGRI				
R310412P R310412V	1	 DISTRIBUCIÓN	78	100	13		GALGHD				
R870610V	1	 GUÍA VÁLVULAS (24) R870610V/1	8	13.6	19	33.7	RGV	17220/17300/17310/18310 19320/26320/17250E/19320E 24250E - Bus 17260EOT 18320EOT 2003/...	8270cc.	ISCe6 24V DIESEL	870600-R
R870011V R870011VF	1	 BANCADA	130	150	12/13		GALGRI				
R870212V R870212T	1	 DISTRIBUCIÓN	75	93	9/10		G1ALGRD				















VOLVO

R320910V	1	 GUÍA VÁLVULAS (16) R320910V/1	6	10.8	15.9		RGV	C30, S40, V50 2005/...	1596cc.	B4164S3 (DOHC) 16V	321600-R MLS
PR320911T	1	 PORTA BANCADA	80				PORTA				
R320912V	1	 DISTRIBUCIÓN	33	47	5		GALGHD				
R320913V	2	 ÁRBOL DE LEVAS	38	52	6		GALGHD				
R570110V	1	 GUÍA VÁLVULAS (12) R260610V/1	7	9.8	10		RGV	S40/V40 1995/...	1731cc.	B4184S (DOHC) 16V	570600-R
R570611V	1	 BANCADA	98	110	7		GALGRI				
R570612V	1	 DISTRIBUCIÓN	35	47	6.5		GALGHD				
R570613P R570613V	1	 ÁRBOL DE LEVAS	45	57	6.5		GALGHD				
R570614P	1	 ÁRBOL DE LEVAS TRASERO	30	47	6		GAHI	S40/V40 1995/...	1731cc.	B4184S (DOHC) 16V	570600-R
R560600	1	 KIT DE RETENES					JUEGO	440TD, 460TD 1994/97 V40TD, S40TD 1996/99	1870cc.	D19T - D4192T (SOHC) 8V DIESEL	580901-R
R560110P R560110V	1	 GUÍA VÁLVULAS (8) R250410V/1	8	10.8	10		RGV				
R560111P R560111V	1	 BANCADA	85	105	8		GALGRI				

CATALOGO DE RETENES

CATALOGO DE RETENTORES - OIL SEAL CATALOG



VOLVO

Código Code	Cant. Qty	Descripción Descrição Descripción	DE [mm]	DA [mm]	H [mm]	A [mm]		Aplicación Aplicação Aplicacion	Cm³ Cm³	Motor Motor Engine	Jgo. Juntas Set Gaskets
R550612P R550612V	1	 DISTRIBUCIÓN	50	68	10		GALGRD	440TD, 460TD 1994/97 V40TD, S40TD 1996/99	1870cc.	D19T - D4192T (SOHC) 8V DIESEL	580901-R
R560113P R560113P/1 R560113V	1	 ÁRBOL DE LEVAS	25	42	7		GALGHD				
R560114P R560114V	1	 AUXILIAR	22	45	7		GALGHI				
550658	1	 CIERRE BANCADA (4)									
R570110V	1	 GUÍA VÁLVULAS (12) R260610V/1	7	9.8	10		RGV	S40/V40 1996/...	1948cc.	B4204S - B4204T (DOHC) 16V	570600-R
R570611V	1	 BANCADA	98	110	7		GALGRI				
R570612V	1	 DISTRIBUCIÓN	35	47	6.5		GALGHD				
R570613P R570613V	1	 ÁRBOL DE LEVAS	45	57	6.5		GALGHD				
R570614P	1	 ÁRBOL DE LEVAS TRASERO	30	47	6		GAHI				
R324711V	1	 BANCADA	98	100	9.5						
R324713V	1	 ÁRBOL DE LEVAS	51	65	7			S40, V50, C70, C30, S80 V70 2004/08 - 2007/...	2551cc.	B524T3 - B524T6 B524T7 - B524T8 (DOHC) 20V	324700-R MLS
R330710V	1	 GUÍA VÁLVULAS (12) R310410V/1	9	13.4	11		RGV				
R330411V	1	 BANCADA	130	160	12		G1ALGRI	VM210/260/310	7118cc.	6.12 TCE Common Rail (OHV) 12V DIESEL	331300-R MLS
R310412P R310412V	1	 DISTRIBUCIÓN	78	100	13		GALGHD				
R340312V	1	 DISTRIBUCIÓN	30	50	7.5		GALGRD				
								B58, B10M 1987/... B58 1980/85 N10 1980/85 N10 1985/89 NL10 1989/97 N12 1980/89 NL12 1997/... NL12 1989/96	9600cc. 9600cc. 9600cc. 9600cc. 9600cc. 11950cc. 11950cc. 11950cc.	THD 101 KC (OHV) 12V THD 100D (OHV) 12V TD 100A (OHV) 12V TD 100G /101G/101F (OHV) 12V TD 102F - 102FS (OHV) 12V TD 121G/120GA 121F (OHV) 12V EDC TD 122FS (OHV) 12V	880000-R 880100-R 880200-R 880300-R 880600-R 880400-R 880700-R 880800-R

WILLYS

R540912N	1	 DISTRIBUCIÓN	44.45	61.95	9.52		GAHD	Jeep, CPW Universal Rastrojero, 4, 63, 2WD/4WD 1940/74, Jeep Militar	2199cc.	CJ2A-CJ3A - DJ3A	540900 540900-R
----------	---	--------------------------------------------------------------------------------------------------	-------	-------	------	--	------	----------------------------------------------------------------------------	---------	------------------	--------------------

YUE YING

R930110P	1	 GUÍA VÁLVULAS (8) R930110P/1	9	14	17		RGV	1041, NJ 41029 1996/...	3268cc.	4BC2 - 4BD1 (OHV) 8V	930100-R
R930111S	1	 BANCADA	100	15	140		GALGHI				



taranto



Retenes Taranto. Un sello de garantía

El permanente desafío que presenta la evolución de los motores de combustión actuales para asegurar el sellado de sus componentes requiere del desarrollo y aplicación de tecnología moderna y eficiente en la fabricación de los retenes. La constante actividad de nuestro Departamento de Ingeniería, aplicada al desarrollo e investigación de nuevos materiales y componentes para lograr la mejor performance de nuestros productos, acompañada de la realización de ensayos de vida y exigentes pruebas específicas que garantizan el perfecto desempeño en los distintos medios funcionales y la utilización de modernas técnicas de diseño aplicada a la construcción de nuevos labios y perfiles hidrodinámicos, permite ofrecer al mercado productos que superan las necesidades de estanqueidad del motor.



1 - NUEVOS PERFILES

Facilita el montaje y asegura el agarre.

2 - POSICION PREFERENCIAL DEL LABIO

Permite trabajar el labio en posiciones no utilizadas del eje.

3 - MODERNOS DISEÑOS

Permite trabajar el labio en una parte del eje no utilizable hasta el momento.





RETENES - MATERIALES

RETENORES MATERIAIS / OIL SEALS - MATERIALS

MATERIALES MATERIAIS - MATERIALS	ASTM D1418	ISO 1629	TARANTO	TEMPERATURA Temperature
SILICONA Material para aplicaciones de baja y alta temperatura, muy usado en motores de elevada exigencia y en transmisiones automáticas. No recomendada para aceites EP (Extrema Presión). SILICONE Material para aplicação em baixas e altas temperaturas, muito usado em motores de elevada exigência. Não é recomendada para óleos EP (Extrema Pressão). SILICONE Material for low and high temperature applications, highly recommended for engines and automatic transmission. It should not be used for EP oils (Extreme Pressure).	VMQ	MVQ	S	-50° Ca + 180°C
NITRÍLICO Es el material más comúnmente utilizado en sellado para aplicaciones generales. Buena resistencia a la abrasión y a la acción de aceites y grasas minerales. NITRÍLICA É o material mais comumente utilizado em vedação para aplicações gerais. Tem boa resistência ao atrito e a ação de óleos e graxas minerais. NITRILE It is the most commonly used sealing material for general applications. Good resistance to abrasion and to mineral oils and greases.	NBR	NBR	N	-35° Ca + 110°C
POLIACRÍLICO Recomendado para aplicaciones en motor y especialmente en transmisión con aceites EP. Deformación permanente más elevada. POLIACRÍLICO Recomendado para aplicações em motores e especialmente em transmissões com óleo EP. Deformação permanente mais elevada. ACRYLIC (POLYACRYLATE) Highly recommended for engines and especially in transmission with EP oils. Higher permanent set.	ACM	ACM	P	-30° Ca + 150°C
FLUORELASTOMERO Compuesto para altas exigencias con mejor resistencia a altas temperaturas y ataques químicos. Ofrece duración en servicio muy superior, pero a costo más elevado. FLUORELASTÓMERO Composto para altas exigências com melhor resistência a altas temperaturas e ataques químicos. Oferece duração em serviço muito superior, porém a um custo mais elevado. FLUORELASTOMERS Compound for high demands with better resistance to high temperatures and chemical aggressions. It grants a better duration in service but at higher costs.	FKM	FKM	V	-30° Ca + 200°C
POLITETRAFLUORETILENO Usos de elevada temperatura, gran ataque químico y severas condiciones de fricción. POLITETRAFLUORETILENO Utilizado em ambientes com altas temperaturas e elevado ataque químico, e em condições severas de atrito. POLYTETRAFLUORETHYLENE High temperature uses, great chemical attack and severe friction conditions.	PTFE	PTFE	T	-80° Ca + 250°C
FLUORELASTOMERO / POLITETRAFLUORETILEO Compuesto especial desarrollado por Taranto (Viflón®) para altas exigencias de temperatura, ataque químico e importantes condiciones de fricción. Es la elección ideal entre el tipo V y el tipo T. FLUOROELASTOMER / POLITETRAFLUORETILENO Composto especial desenvolvido pela Taranto (Viflón®) para os requisitos de alta temperatura, gravura e importantes Condições por atrito. É a escolha ideal entre o tipo V e T -type FLUOROELASTOMER / POLYTETRAFLUOROETHYLENE Special compound developed by Taranto (Viflón®) or high temperature requirements, chemical attack and important conditions of friction. Is the ideal choice between the V type and T-type	FKM PTFE	FKM PTFE	VF	-30° Ca + 200°C



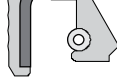

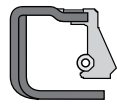
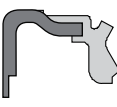
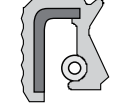
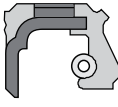
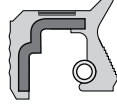
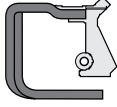
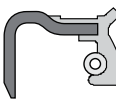

















































































DESCRIPCIÓN - TIPO DE RETENES RADIALES

DESCRIPÇÃO - TIPO DE RETENES RADIAIS | TYPES OIL SEAL - DESCRIPTION

GA	Goma armada Exterior borracha Rubber case	G1A	Exterior goma metal Exterior metal borracha Outer rubber metal	G1	Exterior metal Exterior metlico Outer metal			
G2	Blindado Blindado Armoured	RI	Roscado izquierdo Rosca izquierda Left threaded	RD	Roscado derecho Rosca derecha Right threaded			
SR	Sin resorte Sem mola Without sprint	LG	Labio guardapolvo Lábio guarda-pó Dust lip	HD	Hélice derecha Hélice direita Right helix			
HI	Hélice izquierda Hélice esquerda Left helix	ESP	Especial Especial Special	BI	Bidireccional Bidireccional Bi-directional			











































































KIT DE RETENES

KIT DE RETENTORES - OIL SEALS KIT

Código Code	Descripción Descrição Descrição 	Cant. Qty	DE [mm]	DA [mm]	H [mm]	A [mm]	Código Code	Descripción Descrição Descrição 	Cant. Qty	DE [mm]	DA [mm]	H [mm]	A [mm]
R150000	 R150010P (4)	1	8	10.8	10		R250400	 R250410V (8)	1	8	10.8	10	
	 R150011N	1	48	65	10			 R250111N	1	64	80	8	
	 R150012N	1	30	42.04	8			 R250412P	1	40	56	7	
R150200	 R150010P (4)	1	8	10.8	10		R250700	 R250410V (8)	1	8	10.8	10	
	 R150211N	1	55.95	69.2	10			 R550411P	1	70	90	10	
	 R150012N	1	30	42.04	8			 R250412P	1	40	56	7	
R200800	 R200810P (8)	1	8	13.8	12.8		R250800	 R250810P (8)	1	7	9.7	10.2	
	 R200811P	1	75.9	95	11.3			 R250412P	1	40	56	7	
	 R450412P	2	45	60	10.2			 R250413P	3	30	52	7	
R210000	 R300010P (12)	1	7.9	15.5	12.5		R260000	 R250410V (8)	1	8	10.8	10	
	 R210011N	1	118	143	13			 R260011P	1	70	85	8	
	 R210012N	1	49.2	65.09	12.7			 R250412P	1	40	56	7	
R210000N	 R300010P (12)	1	7.9	15.5	12.5		R260200	 R250410V (8)	1	8	10.8	10	
	 R210011N	1	118	143	13			 R260011P	1	70	85	8	
	 R210012N	1	49.2	65.09	12.7			 R250412P	1	40	56	7	
R220100	 R220110P (8)	1	7.9	15.5	12.5		R260400	 R250410V (8)	1	8	10.8	10	
	 R220111P	1	76.2	95.22	9.32			 R260111P	1	74	90	10	
	 R220112S	1	44.45	63.5	9.5			 R260112P	1	30	43	8	
R220200	 R220210P (8)	1	7.9	14.8	9.2		R260600	 R250413P	2	30	52	7	
	 R220111P	1	76.2	95.22	9.32			 R260610V (16)	1	7	9.8	10	
	 R220112P	1	44.45	63.5	9.5			 R260111P	1	74	90	10	
R220400	 R220410V (8)	1	8	10.8	10		R270100	 R260112P	1	30	43	8	
	 R220411V	1	85	105	12			 R260113P	2	30	42	7	
	 R230113P	3	32	47	10			 R270110P (8)	1	8	12/15.2	9.5	
R230200	 R230210V (8)	1	7	9.8	10		R280600	 R270111V	1	90	115	13	
	 R220411V	1	85	105	12			 R270112V	1	70	90	10	
	 R230113P	3	32	47	10			 R270113P	1	50	70	10	
R240200	 R240210V (8)	1	7	11.1	10		R280700	 R270115V	1	55	70	10	
	 R240211P	1	90	104	11			 R280610V (16)	1	6	8.8	9.5	
	 R240012P	1	31	50	8			 R240411V	1	85	105	12	
	 R240013P	1	35	48	7			 R240013P	2	35	48	7	
R240300	 R240010V (8)	1	8	12	9.5	15.2	R300000	 R240415V	1	26	42	8	
	 R240311V	1	85.9	104	11			 R280610V (16)	1	6	8.8	9.5	
	 R240012P	1	31	50	8			 R240211P	1	90	104	11	
	 R240013P	1	35	48	7			 R240012P	1	31	50	8	
R240400	 R240210V (8)	1	7	11.1	10		R280700	 R240013P	2	35	48	7	
	 R240411V	1	80	98	10			 R280610V (16)	1	6	8.8	9.5	
	 R240013P	1	35	48	7			 R240211P	1	90	104	11	
	 R240415V	1	26	42	8			 R240012P	1	31	50	8	
R250100	 R250110P (8)	1	7	11.8	10.2		R300000	 R250110P (8)	1	7.9	15.5	12.5	
	 R250111N	1	64	80	8			 R300010P (12)	1	7.9	15.5	12.5	
	 R250112P	1	42	56	7			 R300011P	1	85.7	102.62	9.73	























































KIT DE RETENES

KIT DE RETENTORES - OIL SEALS KIT

Código Code	Descripción Descrição Descrição 	Cant. Qty	DE [mm]	DA [mm]	H [mm]	A [mm]	Código Code	Descripción Descrição Descrição 	Cant. Qty	DE [mm]	DA [mm]	H [mm]	A [mm]
R300000	 R300012P	1	44.45	60.3	11.11		R400200-1	 R400210P (12)	1	9.1	12.3	15.1	
R300300	 R300310P (8)	1	7.9	15.5	12.5			 R400211V	1	133.35	158.75	11/13	
	 R300311P	1	92	108	9.8			 R400012P	1	60.32	79.36	11	
	 R300312P	3	43.41	56.02	9.3			R400215N	1	22.22	35.7	9.52	
R300400	 R300310P (8)	1	7.9	15.5	12.5		R450000	450035 (2)	1	-	JUEGO	-	
	 R300411N	1	91.5	106.5	5.5			 R450010P (8)	1	8	10.8	10	
	 R300312P	3	43.41	56.02	9.3			 R450012P	1	42	60	10	
R300700	 R310810V (8)	1	7	10.9	9.5		R450400	450758 (2)	1	-	JUEGO	-	
	 R300711P	1	82	105	12			 R460210V (8)	1	8	10.8	10	
	 R470013V	1	35	50	7			 R450412P	1	45	60	10.2	
R300900	 R300010P (12)	1	7.9	15.5	12.5		R450400-1	450758 (2)	1	-	JUEGO	-	
	 R300012P	1	44.45	60.3	11.11			 R460210V (8)	1	8	10.8	10	
	 R300911N	1	85.7	100	5.5			 R450412-1P	1	42	60	8	
R310800	 R310810V (8)	1	7	10.9	9.5		R450400-2	450758 (2)	1	-	JUEGO	-	
	 R300611V	1	79	95.25	11.11			 R460210V (8)	1	8	10.8	10	
	 R310812P	1	36.51	52.48	8			 R450412-2P	1	45	60	7	
R320000	 R320010V (8)	1	8	12	12		R460200	 R460210V (8)	1	8	10.8	10	
	 R300611V	1	79	95.25	11.11			 R460211V	1	90	110	7	
	 R320012P	1	66.67	89.3	10			 R460212V	1	42	62	7	
	 R320013P	1	28	38	7			 R460213V	1	36	50	8	
R320300	 R320310V (16)	1	6	11.75	20.7		R460300	 R460210V (8)	1	8	10.8	10	
	 R320311V	1	88	108	10			 R460211V	1	90	110	7	
	 R320313P	2	42	53	7			 R460212V	1	42	62	7	
	 R470013V	1	35	50	7			 R470013V	1	35	50	7	
R400000	400158 (2)	1	-	JUEGO	-		R460700	 R460710V (8)	1	7	9.8	10	
	 R300310P (8)	1	7.9	15.5	12.5			 R560111V	1	85	105	8	
	 R400010P (8)	1	7.9	14	13.2			 R460712V	1	42	66	8	
	 R400012P	1	60.32	79.36	11			 R460213P	1	36	50	8	
R400000-1	 R300310P (8)	1	7.9	15.5	12.5		R460800	 R460810V (16)	1	7	17	18	
	 R400010P (8)	1	7.9	14	13.2			 R460211V	1	90	110	7	
	 R400211P	1	133.35	158.75	11/13			 R460212V	1	42	62	7	
	 R400012P	1	60.32	79.36	11			 R460213V	2	36	50	8	
R400100	400158 (2)	1	-	JUEGO	-		R470000	 R470010V (12)	1	7	9.8	10	
	 R400010P (12)	1	7.9	14	13.2			 R470011V	1	98	120	7	
	 R400012P	1	60.32	79.36	11			 R470012V	1	64	88	6	
R400100-1	 R400010P (12)	1	7.9	14	13.2			 R470013V	1	35	50	7	
	 R400012P	1	60.32	79.36	11			R470014V	1	40	62	7	
	 R400211P	1	133.35	158.75	11/13			R470015V	1	47.5	62	7	
R400200	400158 (2)	1	-	JUEGO	-		R500200	500258 (2)	1	-	JUEGO	-	
	 R400210P (12)	1	9.1	12.3	15.1			 R460210V (8)	1	8	10.8	10	
	 R400012P	1	60.32	79.36	11			 R450412P	1	45	60	10.2	
	 R400215N	1	22.22	35.7	9.52		R500200-1	500258 (2)	1	-	JUEGO	-	

KIT DE RETENES

KIT DE RETENTORES - OIL SEALS KIT

Código Code	Descripción Descrição Decripción 	Cant. Qty	DE [mm]	DA [mm]	H [mm]	A [mm]	Código Code	Descripción Descrição Decripción 	Cant. Qty	DE [mm]	DA [mm]	H [mm]	A [mm]
R500200-1	 R460210V (8)	1	8	10.8	10		R570400	 R560113P	1	25	42	7	
	 R450012P	1	42	60	10			R560114P	1	22	45	7	
R550400	 R550410P (8)	1	7	9.25	10			R550615P	1	30	40	7	
	 R550411P	1	70	90	10		R570500	 R570510V (8)	1	6	10.9	20	
	 R550412P	1	35	50	9			 R570511V	1	70	86	8	
	 R550413P	1	30	42	8			 R570512V	1	32	44	6	
R550600	 R550610V (8)	1	7.7	10.2	10			 R260113V	1	30	42	7	
	 R550611V	1	90	110	13		R570900	 R570910V (16)	1	5.5	11	16.5	
	 R550612P	1	50	68	10			 R570011V	1	80	100	8	
	 R550613P	1	35	47	7			 R550613V	1	35	47	7	
	R550615P	1	30	40	7			 R570913V	2	28	42	5	
R550900	 R550910V (8)	1	7	10.8	10		R900900	 R900910P (8)	1	7	13.9	12.5	
	 R550811P	1	80	100	13			 R460211V	1	90	110	7	
	 R550412P	1	35	50	9			 R900912P	1	34	48	7	
	 R550413P	1	30	42	8			 R900913P	1	30	44	7	
R560100	 R560110V (8)	1	8	10.8	10								
	 R560111V	1	85	105	8								
	 R550612P	1	50	68	10								
	 R560113P	1	25	42	7								
	R560114P	1	22	45	7								
R560600	 R560110V (8)	1	8	10.8	10								
	 R560111V	1	85	105	8								
	 R550612P	1	50	68	10								
	 R560113P	1	25	42	7								
R560700	 R560110V (8)	1	8	10.8	10								
	 R560111V	1	85	105	8								
	 R570412V	1	42	54	6								
	 R560113P	1	25	42	7								
R560800	 R560810V (8)	1	7	9.8	10								
	 R570011V	1	80	100	8								
	 R260113P	1	30	42	7								
	 R550613P	1	35	47	7								
R570000	 R550910V (8)	1	7	10.8	10								
	 R570011V	1	80	100	8								
	 R550412P	1	35	50	9								
R570300	 R560810V (8)	1	7	9.8	10								
	 R560111V	1	85	105	8								
	 R570412V	1	42	54	6								
	 R560113P	1	25	42	7								
R570400	 R560110V (8)	1	8	10.8	10								
	 R560111V	1	85	105	8								
	 R570412V	1	42	54	6								

RETENES RADIALES

RETENORES RADIAIS - OIL SEAL

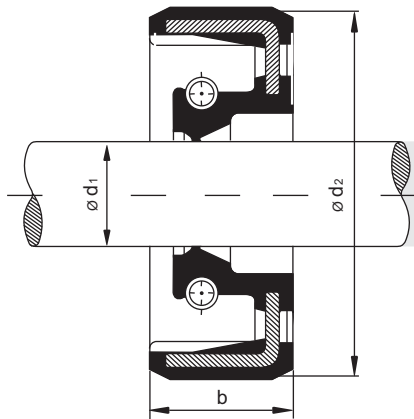

- Diámetro de Eje (d1)
- Altura (b)
- Alojamiento (d2)

- Diâmetro do eixo (d1)
- Altura (b)
- Alojamento (d2)

- Shaft diameter (d1)
- Height housing (b)
- Housing Bore (d2)

RETENES POR Ø DE EJE - RETENORES POR DIÂMETRO DO EIXO - DIAMETER HOLDERS OIL SEAL



REF	DE [mm]	DA [mm]	H [mm]	A [mm]	TIPO Type	MATERIAL						REF	DE [mm]	DA [mm]	H [mm]	A [mm]	TIPO Type	MATERIAL							
						N	S	P	V	T	VF							N	S	P	V	T	VF		
R300347	7.90	16.00	6		GA	•							R240415	26.00	42.00	8		G1ALGHD			•	•			
R550614	8.10	14.30	4.2		U'RING				•				R550660	26.00	42.00	8/17		EGALG	•						
R550447	8.40	16.00	6.5		GA	•							R350315	26.00	45.00	10		G1	•						
R460215	9.50	16.00	4		GALGSR	•							R902115	26.00	49.0	9.5/11		ESP			•				
R550515	12.70	25.40	6.5		GAHI			•					R270515	27.00	37.00	7		G1ALGHD					•		
R223543	13.00	21.90	5/6.5		ESP-GADUC						•		R860012	27.00	39.50	7		GALGHD			•				
R240048	13.00	26.00	7		GALG	•							R231313	27.00	42.00	8		G1ALGHD					•		
R550051	13.00	26.00	9		GALG	•							R470813	27.00	47.00	7		GALGHD						•	
R250148	14.00	24.00	7		ESP	•							R550951	27.95	56.00	10		GALGHD			•				
R550451	15.00	26.00	7		GALG	•							R570351	27.95	70.00	10		GALGHD			•				
R300748	15.50	28.00	6/15		ESP	•							R320013	28.00	38.00	7		GALGHD			•		•		
R300048	15.70	23.81	4.76		GASR	•							R300351	28.00	40.00	8		GALGHD	•						
R550648	16.00	22.80	4.8		GA	•							R570913	28.00	42.00	5		GALGHD						•	
R250448	16.00	24.60	9/20		ESP	•							R222313	28.00	42.00	7		GALGHI						•	
R450348	17.00	23.00	7		ESP	•							R450557	28.00	45.00	8		GAHD			•				
R300749	17.00	28.00	7/10		GALGHD	•							R580013	28.00	47.00	5.5		GALGHD						•	
R550450	17.00	28.00	7/13		GAHD	•							R250151	28.00	47.00	8		GAHD	•						
R280215	17.50	32.00	6		GALGHD	•		•	•				R510012	28.50	41.25	6		GALGHD			•				
R220649	20.00	35.00	7/10.5		GAHD			•					R300051	28.58	41.20	6.2		G1HD	•						
R240949	21.00	32.00	7.5		G1LGHD	•							R250660-1	29.80	50.00	10/13.5		G1ALGHD			•				
R300751	21.50	40.00	7		GAHD			•					R250660	29.80	52.00	10/13.5		G1ALGHI			•				
R250652	22.00	35.00	8		GALG	•							R200849	29.90	45.00	7		G1HD			•				
R250451	22.00	40.00	7/8.5		G2LGHD	•							R460760	29.90	47.00	11.3		GALGRD c/f*			•				
R560114	22.00	45.00	7		GALGHI			•	•				R550615	30.00	40.00	7		GAHD	•		•	•			
R220349	22.10	40.00	12/17		GALGHD	•							R860013	30.00	40.00	7		GA-B		•	•				
R400213	22.22	34.92	6.35		GA	•							R260113	30.00	42.00	7		GALGHD			•	•			
R400215	22.22	35.70	9.52		ESP-RD	•							R550413	30.00	42.00	8		GAHI	•		•				
R260251	22.80	40.00	7/8.5		G2LGHD			•					R150012	30.00	42.04	8		GALGHD	•						
R250457	23.00	37.00	13.5		ESP			•					R260112	30.00	43.00	8		G1ALGHD			•	•			
R550550	24.00	36.00	8/12		GAHD	•							R900913	30.00	44.00	7		GALGHD			•				
R250156	25.00	35.00	7		GA	•							R270614	30.00	44.00	8		GALGHI					•		
R280415	25.00	40.00	8		GALG-BI	•							R240713	30.00	45.00	8		GALGHD	•		•				
R560113	25.00	42.00	7		GALGHD			•	•				R250255	30.00	45.00	8		GA	•						

c/f Con Feltro
Con feltro/With Felt

RETENES RADIALES

RETENORES RADIAIS - OIL SEAL

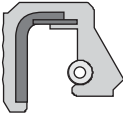
RETENES POR Ø DE EJE - RETENORES POR DIÂMETRO DO EIXO - DIAMETER HOLDERS OIL SEAL



REF		DE [mm]	DA [mm]	H [mm]	A [mm]	TIPO Type	MATERIAL							REF		DE [mm]	DA [mm]	H [mm]	A [mm]	TIPO Type	MATERIAL					
							N	S	P	V	T	VF									N	S	P	V	T	VF
R950512		30.00	46.00	8		GALGHD	•	•						R250158		35.00	52.00	10/15		G1	•					
R570614		30.00	47.00	6		GAHI		•						R240960		35.00	54.00	7		G1ALG-BI	•					
R260914		30.00	47.00	7		G1ALGHD		•	•					R810012		35.00	62.00	6		GALG-BI	•					
R340312		30.00	50.00	7.5		GALGRD				•				R926612		36.00	48.00	7					•			
R250413		30.00	52.00	7		GALGRD		•						R920012		36.00	49.00	8		GALGD		•				
R260313		30.00	52.00	7		G1ALGHD	•	•	•					R460213		36.00	50.00	7		GALGHD		•	•			
R252012		31.00	41.00	7		G1ALGHD				•				R550055		36.00	54.00	8/11		G1	•					
R270615		31.00	41.00	7		GALGHD					•			R550460		36.00	54.00	10/13		E-GALG c/f	•					
R240012		31.00	50.00	8		GALGHD		•	•					R250257		36.00	68.00	8		GAHD	•					
R272213		31.00	55.00	7		G1ALGHD				•				R310812		36.51	52.48			GALGHD			•			
R200051		31.68	44.45	6.35		G1HD	•							R230513		37.00	47.00	10		GALGHD				•		
R230512		32.00	42.00	7		G1ALGHD		•	•					R520912		37.00	50.00	6		GALGHD		•				
R570512		32.00	44.00	6		GALGHD				•				R302212		37.00	50.00	8		GALGHD					•	
R981312		32.00	45.00	6				•						R230413		38.00	48.00	8		GALGHD	•					
R230412		32.00	45.00	6.5		GALGRD		•						R452113		38.00	50.00	6		GALGHD					•	
R910613		32.00	46.00	6		GALGHD		•						R242513		38.00	50.00	8		-					•	
R282513		32.00	47.00	7				•						R290912		38.00	50.00	8		G1ALGHD					•	
R220412		32.00	47.00	10		GALGHD			•	•				R320913		38.00	52.00	6		GALGHD					•	
R230113		32.00	47.00	10		GALG-BI		•	•					R250155		38.00	52.00	10		G1	•					
R230513		32.0	47.00	10		GALGHD				•				R200859		38.00	52.00	8.5/2.5		ESP-GALG	•					
R950012		32.00	48.00	7		GALGHD	•	•						R300755		38.00	58.50	7		GA-BI	•					
R920014		32.00	50.00	8		GALGHD		•						R300050		38.10	60.30	12.5/19		ESP-RI	•					
R450351		32.00	50.00	10		GAHD		•						R310256		38.10	63.55	12.7		GA	•					
R550012		32.00	50.00	10		GALGHD	•							R970012		38.50	58.00	11		GALGHD	•		•			
R452015		32.00	52.00	7		GALGHI				•				R210912		39.68	58.73	9.46		GALGRD	•					
R250050		32.00	56.00	10		GALGHI	•							R300057		39.68	80.29	7/16		ESP-RD	•					
R250256		32.54	51.43	9.92		GA	•							R540057		39.68	80.29	7/16		ESP-RD	•					
R320912		33.00	47.00	5		GALGHD				•				R340112		39.95	62.00	7.4		GALGHD					•	
R300255		33.33	57.15	12.7		G2	•							R280212		40.00	52.00	6		GALGHD			•	•		
R900912		34.00	48.00	7		GALGHD			•					R420613		40.00	52.00	7		GALGHD					•	
R550455		34.00	52.00	7.5		GA	•							R902112		40.00	52.00	7		GALGHD					•	
R220150		34.92	56.00	10.7		GALGRI	•							R220455		40.00	52.00	7.5		GALG	•					
R420612		35.00	45.00	7		GALGHD		•						R240455		40.00	52.00	8.5		E-GALG	•					
R570612		35.00	47.00	5.5		GALGHD				•				R320055		40.00	55.00	6.5		G1SRLG	•					
R550613		35.00	47.00	7		GAHD		•	•					R270713		40.00	55.00	7		G1ALGHD			•	•		
R240013		35.00	48.00	7		GALGHD		•	•					R300358		40.00	55.00	8		GALG	•					
R300350		35.00	49.70	12.7		G1LGRI	•							R971512		40.00	55.00	8		GALGHD			•			
R470013		35.00	50.00	7		GALG-BI		•	•					R310760		40.00	55.00	9		G1LG-BI	•		•			
R520915		35.00	50.00	8		GALG	•							R920013		40.00	55.00	9		GALGHD					•	
R910513		35.00	50.00	8		GALGHD		•						R250412		40.00	56.00	7		GALGRD	•		•			
R950712		35.00	50.00	8			•							R260312		40.00	56.00	7		G1ALGHD	•		•	•		
R550412		35.00	50.00	9		GALGHD	•	•	•					R450350		40.00	58.00	10		GAHI	•					
R520212		35.00	52.00	8		GALGHD		•						R460760-1		40.00	58.00	10		GALG-BI c/f					•	

cf Con Feltro
Con feltro/With Felt

RETENES RADIALES

RETENTORES RADIAIS - OIL SEAL

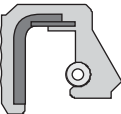
RETENES POR Ø DE EJE - RETENTORES POR DIÂMETRO DO EIXO - DIAMETER HOLDERS OIL SEAL











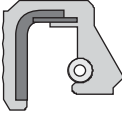

REF		DE [mm]	DA [mm]	H [mm]	A [mm]	TIPO Type	MATERIAL							REF		DE [mm]	DA [mm]	H [mm]	A [mm]	TIPO Type	MATERIAL						
							N	S	P	V	T	VF									N	S	P	V	T	VF	
R250012		40.00	60.00	10		GAHD	●							R301712		45.00	63.8	10.8	77.6	G1ALGHD		●					
R470014		40.00	62.00	7		GALGHI					●			R360112		45.00	74.5	12/14.5	79.5	E-RD			●				
R340115		40.00	62.00	7.4		GALGHD			●	●				R272030		45.70	23.30	10.5		ESP			●				
PR320015		40.00	-	-		PORTA					●			R902512		46.00	58.00	7		GALGHD			●				
R220359		40.10	52.00	9		ESP-GALG	●							R310658		46.00	65.50	7/8.5		G1LG-BI	●						
R320313		42.00	53.00	7		GALGHD			●	●				R250757		46.00	78.00	10		G1LGHD	●						
R570412		42.00	54.00	6		GALGHD			●	●				R550459		46.43	69.78	12.3		GALG	●						
R250112		42.00	56.00	7		ESP-G1	●		●					R430013		46.70	62.00	9		GALGHD					●		
R250455		42.00	56.00	7		GA	●							R340712		47.00	63.40	8.8		GALGHD			●				
R300612		42.00	56.00	7		GAHD	●		●	●				R340412		47.00	65	15	80	E-G1LGHD			●				
R910612		42.00	60.00	7		GALGHD	●	●						R470015		47.50	62.00	7		GALGHI					●		
R450412-1		42.00	60.00	8		GALGHD			●					R330313		47.60	66.70	11.3		GALGRD					●		
R450012		42.00	60.00	10		GALGHD	●		●					R340512		47.62	65.07	7.95		G1LGHD					●		
R460212		42.00	62.00	7		GALGHD			●	●				R302715		47.63	63.50	8.5/12.3		GALGHD					●		
R800312		42.00	65.00	10		GALGHD			●	●				R300212		47.65	65.05	11.83		G1AHD	●		●				
R460712		42.00	66.00	8		GALGHD				●				R310252		47.70	73.10	12.7		ESP	●						
R500012		42.00	68.00	10/16		GALGHD	●							R320712		48.00	65.00	7.85		GALGHD	●						
R700912		42.00	72.00	10		GALG	●							R150011		48.00	65.00	10		GALGHI	●						
R300312		43.41	56.02	9.3		ESP-G1LGHD	●		●					R950212		48.00	65.00	10		GAHD			●	●			
R910512		44.00	60.00	7		GALGHI	●							R520812		48.00	68.00	11		GALGHD			●				
R950312		44.00	60.00	7		GALGHD		●	●					R900012		48.00	70.00	9		GALGHD	●		●				
R220158		44.45	53.97	4.67		GA	●							R902312		48.00	70.00	9		GALGHD		●					
R510412		44.45	57.15	9.5		GALGHD			●					R970312		48.00	70.00	12		GALGHD	●						
R300012		44.45	60.30	11.11		G1AHD	●		●					R220356		48.00	72.00	7/8.5		GALG	●						
R540912		44.45	61.95	9.52		GAHD	●							R550555		48.70	58.00	8.5		ESP	●						
R220112		44.45	63.50	9.52		GAHD	●		●					R460255		48.90	63.00	10.8/12.8		E-GALG-BI			●				
R200012		44.47	61.19	9.57		G1LGHD	●		●					R210012		49.20	65.09	12.7		GALGHD	●						
R220355		44.50	62.00	11		GALG-BI	●							R300258-1		49.22	63.62	7.26		ESP	●						
R570613		45.00	57.00	6.5		GALGHD			●	●				R300455		50.00	65.00	9		ESP-G1	●						
R510812		45.00	57.15	9.5		GALGHD			●					R240712		50.00	65.00	10		-	●						
R250258		45.00	59.00	10		G1	●							R550612		50.00	68.00	10		GALGRD			●	●			
R420614		45.00	60.00	7		GALGHI			●					R922312		50.00	68.00	9.5/12					●				
R450412-2		45.00	60.00	7		GALGHD			●					R270113		50.00	70.00	10		GALGRD			●	●			
R450158		45.00	60.00	10		GA	●							R300258		50.80	66.60	6.5		G1SRLG	●						
R450412		45.00	60.00	10		GALGHD	●		●					R550458		50.80	69.85	9.53		GA	●						
R450055		45.00	62.00	12		GA	●							R410912		50.90	69.80	9.5		GAHD	●						
R220358		45.00	65.00	8		GALG	●							R900812		51.00	70.00	11		GALGHD			●				
R250212		45.00	65.00	10		E-GAHD	●							R324713		51.00	65.00	7						●			
R351112		45.00	67.00	8		GALGHD				●				R520312		52.00	68.00	9.5		GALGHD					●		
R922512		45.00	68.00	7		-		●	●					R450055-1		52.00	75.00	12		GA	●						
R950412		45.00	68.00	12		GALG	●							R540012		52.38	81.02	11		GALGHD	●						
R500112		45.00	68.00	10/16		GALGHD	●							R450355		53.00	79.00	10		ESP	●						
R800513		45.00	75.00	10		G1ALGHI				●				R220012		53.97	80.96	14.68		E-GARD	●						

cf Con Feltro
Con feltro/With Felt

RETENES RADIALES

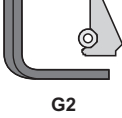

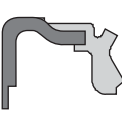
RETENTORES RADIAIS - OIL SEAL

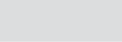
RETENES POR Ø DE EJE - RETENTORES POR DIÂMETER DO EIXO - DIAMETER HOLDERS OIL SEAL

REF		DE [mm]	DA [mm]	H [mm]	A [mm]	TIPO Type	MATERIAL							REF		DE [mm]	DA [mm]	H [mm]	A [mm]	TIPO Type	MATERIAL																							
							N	S	P	V	T	VF									N	S	P	V	T	VF																		
R242512		54.00	82.00	11.45		-									R330312	66.67	85.70	10		GALGRD																								
R270612		55.00	68.00	8		GALGHD									R320012	66.67	89.30	10		GALGRD																								
R241515		55.00	70.00	8		GALGHI									R330212	66.70	88.80	11/12.5		G1ALGHD																								
R270115		55.00	70.00	10		GALGHD									R350957	68.00	85.00	10		GALGHD																								
R300759		55.00	70.00	6/10		ESP									R360057	68.00	85.00	10		GALG																								
R700612		55.00	72.00	10		GALGHD									R581813	70.00	85.00	7		GALGRD																								
R810151		55.00	75.00	9		G1LGHD									R260011	70.00	85.00	8		G1ALGHI																								
R510512		55.00	81.00	15.8		G1LGHD									R570511	70.00	86.00	8		GALGHI																								
PR231411		55.00	-	-		PORTA									R971511	70.00	88.00	11		-																								
R150211		55.95	69.1	10	70.7	GAHI									R220311	70.00	90.00	10		GAHI																								
R500412		56.00	80.00	10		GAHD									R270112	70.00	90.00	10		GALGHD																								
R430012		57.00	71.00	9		GALGRD									R550411	70.00	90.00	10		GALGHI																								
R950511		57.00	77.00	10		GALGHI									R800012	70.00	90.00	15		G1LGHD																								
R850012		57.15	76.20	9.5		GALGHD									PR270112	70.00	-	-		PORTA																								
R850512		57.15	76.20	9.5		GALGHD									R800812	70.00	100.00	12.5/16																										
R220013		57.15	80.98	11.5		GALGRD									R950311	72.00	96.00	9		GALGRI																								
R420112		57.30	76.20	12.7		GALGHD									R270511	74.00	88.00	8		G1ALGRI																								
R430015		57.50	74.00	8		GASRLG									R260111	74.00	90.00	10		G1ALGRI																								
R950011		58.00	74.00	9.5		GALGHI									PR270511	74.00	-	-		PORTA																								
R310458		58.95	76.00	9		G1SRLG									PR270711	74.00	-	-		PORTA																								
R550655		60.00	70.00	9.1		ESP									PR271911	74.00	-	-		PORTA																								
R500211-1		60.00	75.00	5		EXPAN									R870212	75.00	93.00	9/10		G1ALGRD																								
R581812		60.00	75.00	7		GALGRD									R350858	75.00	95.00	13		GALG																								
R990011		60.00	75.00	8		GALGHI									R350612	75.00	100.00	12		G1LGHDI																								
R950711		60.00	78.00	10		GALGHI									R970011	75.00	100.00	13		GALGRI																								
R940011		60.00	80.00	8		GALGHI									R700212	75.00	100.00	17		GALGHD																								
R330012		60.30	82.50	11		G1HD									R200811	75.90	95.00	11.3		GALGH																								
R400012		60.32	79.36	9.5		GALGHD									R241911	76.00	92.00	10		GALGRI																								
R320111		60.45	76.18	10		GALGHI									R220111	76.20	95.22	9.32		GARI																								
R260950		63.00	69.50	11		ESP									R510411	76.20	95.25	9.5		GALGHD																								
R870012		63.50	79.50	9		G1ALGRD									R271511	78.00	100.00	9		GALGSRRI																								
R200011		64.00	78.00	12		2 PARTES									R460511	78.00	100.00	10		G1ALGHI																								
R200011-1		64.00	78.00	12		2 PARTES									R310412	78.00	100.00	13		GALGHD																								
R200011-2		64.00	78.00	12		EXPAN									R351012	78.00	104.00	11		GASRRD <i>cf</i>																								
R450411-1		64.00	80.00	5		EXPAN									R926611	78.00	105.0	7.5		-																								
R250111		64.00	80.00	8		G1ALGHI									R860011	79.00	126.00	1.25		ESPFI																								
R250811		64.00	80.00	8		G1ALGHD									PR320011	79.00	-	16		PORTA																								
R700112		64.00	85.00	12		GAHD									PR291011	79.00	-	-		PORTA																								
R470012		64.00	88.00	6		GALGHD									R330311	79.30	99.00	9.8		GALGHI																								
PR260911		64.00	81.50	8		PORTA									R340111	79.30	93.00	9																										
R922313		65.00	79.00	7																																								

RETENES RADIALES RETENTORES RADIAIS - OIL SEAL

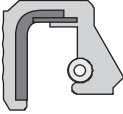
RETENES POR Ø DE EJE - RETENTORES POR DIÂMETRO DO EIXO - DIAMETER HOLDERS OIL SEAL

REF		DE [mm]	DA [mm]	H [mm]	A [mm]	TIPO Type	MATERIAL							REF		DE [mm]	DA [mm]	H [mm]	A [mm]	TIPO Type	MATERIAL						
							N	S	P	V	T	VF									N	S	P	V	T	VF	
R910511		80.00	96.00	9		GALGHI	•							R460211		90.00	110.00	7		GALGRI			•				
R950611		80.00	96.00	9		GALGRI		•						R971811		90.00	110.00	8.5		-		•					
R240411		80.00	98.00	10		G1ALGRI			•	•				R460211-1		90.00	110.00	10		GALGRI				•			
R570011		80.00	100.00	8		GALGRI				•				R550611		90.00	110.00	13		GALGRI			•	•			
R250211		80.00	100.00	10		GALGHI	•		•					R270111		90.00	115.00	13		GALGHI					•		
R810115		80.00	100.00	12		G1LG-BI					•			R500411		90.00	120.00	12		G1ALGHI			•				
R950411		80.00	100.00	12		GALGHI		•						PR370011		90.00	-	-		PORTA						•	
R550811		80.00	100.00	13		GARI			•	•				R520911		91.00	111.00	9		GALGHI		•					
R902311		80.00	100.00	13		GALGHI		•	•					R330511		91.00	111.00	10		G1ALGRI					•		
R970311		80.00	105.00	13		GALGHI		•	•					R300411		91.50	106.50	5.5		ESP-GARI	•		•				
PR320911		80.00	-	-		PORTA						•		R290611		91.50	114.80	12.5					•				
PR321711		80.00	-	-		PORTA						•		R321811		92.00	106.00	5		2 PARTES			•				
PR340314		80.00	-	-		PORTA			•					R302511		92.00	107.58	9.5		G1ARI						•	
R300711		82.00	105.00	12		GALGHI			•					R300311		92.00	108.00	9.8		GAHI			•				
R902111		84.00	104.00	11		GALGRI			•					R581811		93.00	108.00	7		GALGRI					•		
R903411		84.00	117.00	8.5		GALGRI					•			R351111		93.00	114.00	13		GALGHI				•			
PR233311		84.00	-	-		PORTA						•		PR270911		93.00	-	-		PORTA					•		
PR901511		84.00	-	-		PORTA						•		PR351211		93.00	-	-		PORTA						•	
R560111		85.00	105.00	8		GALGRI			•	•				R321111		95.00	114.50	9.5		GALGHI		•					
R910611		85.00	105.00	10		GAHI	•							R340911		95.00	114.50	11		GALGRI			•				
R560611		85.00	105.00	11		GALGRI				•		•		R922211		95.00	115.00	9.5		GALGHI		•					
R220411		85.00	105.00	12		GALGRI			•	•		•		R280111		95.00	115.00	12		GALGRI			•				
PR221711		85.00	-	-		PORTA					•		•	R351155		95.00	115.00	13		GALG-BI	•						
PR230211		85.00	-	-		PORTA					•	•		R242111		95.00	115.00	12.5		GALGHI	•						
PR231211		85.00	-	-		PORTA						•		R240711		95.00	118.00	8.5		GALGHI	•		•				
PR907611		85.00	-	-		PORTA			•					R350258		95.00	130.00	13		G2LG	•						
PR224011		85.00	-	-		PORTA						•		R570611		98.00	110.00	7		GALGRI					•		
PR231211		85.00	-	-		PORTA						•		R324711		98.00	110.00	9.5							•		
PR232411		85.00	-	-		PORTA						•		R470011		98.00	120.00	7		GALGHI					•		
PR232411-2		85.00	-	-		PORTA						•		PR521911		98.00	-	-		PORTA						•	
PR232911		85.00	164/152	10.5		PORTA					•			R290711		99.00	114.00	11		GALGRI					•		
PR472111		85.00	-	-		PORTA						•		PR430011		99.45	-	-		PORTA					•	•	
R300911		85.70	100.00	5.5		E-GARI	•	•	•					R270311		100.00	118.00	10		GALGHI					•		
R300011		85.70	102.62	9.73		GAHI			•					R350458		100.00	120.00	13		G2LG	•						
R240311		85.90	104.00	11		GALGRI			•	•				R650912		100.00	120.00	15		GALGHD			•				
R300911-1		86.00	100.00	5.5		EXPAN		•						R350958		100.00	125.00	12		G1A-BI	•						
R280211		87.00	100.00	8.5		GALGRI					•			R360812		100.00	130.00	11		GALGRD					•		
R320311		88.00	108.00	10		GALGRI					•			R930111		100.00	135.00	15	140	GALGHI		•					
R301711		88.00	108.00	11		GAHI					•			R900811		101.57	125.00	13		GALGHI		•					
PR302211		88.00	-	-		PORTA						•		R850511		101.60	127.00	7.94		GALGHI			•				
R420611		88.90	105.00	9.5		GARI			•					R360012		105.00	130.00	12		G1ALGRD					•		
R240211		90.00	104.00	11		GALGRI			•	•				PR302011		105.00	-	-		PORTA						•	
R350211-1		90.00	106.00	7.5		EXPAN	•							R310411		110.00	130.00	13		GALGHI			•	•			

c/f Con Feltro
Con feltro/With Felt

RETENES RADIALES

RETENORES RADIAIS - OIL SEAL

RETENES POR Ø DE EJE - RETENORES POR DIÂMETRO DO EIXO - DIAMETER HOLDERS OIL SEAL

REF		DE [mm]	DA [mm]	H [mm]	A [mm]	TIPO Type	MATERIAL								
							N	S	P	V	T	VF			
R350255		110.00	140.00	13		G2LG	●								
R650212		110.00	140.00	16		GALGHD		●							
R200311		112.50	130.00	11		G1ALGRI			●						
R360811		113.00	140.00	12		GALGRI				●					
R800311		114.00	135.00	13		G1ALGRI				●					
PR270111		114.00	-	-		PORTA				●					
PR291611		115.00				PORTA				●					
R351011		115.00	140.00	13		G1ASRR1 c/f			●						
R650111		115.00	140.00	16		G1ALGHI			●						
R210011		118.00	143.00	13		GARI	●								
R360011		120.00	140.00	13		G1ALGRI				●					
R350455		120.00	145.00	15		G2LG	●								
R850011		120.65	146.07	12.7		GALGRI c/pista			●						
R330011		122.20	140.80	12		GALGHI				●					
R350955		125.00	150.00	15		G2LG-BI	●								
R870011		130.00	150.00	12/13		GALGRI				●			●		
R800811		130.00	155.00	12.5/16										●	
R330411		130.00	160.00	12		G1ALGRI				●					
R810111		130.00	160.00	15		GALGRI				●					
R400211		133.35	158.75	11/13		GALGRI			●	●					
R800511		140.00	165.00	13		G1ALGRI				●					
R650411		150.00	172.00	18.3		GAHI				●					
R800055		180.00	200.00	12		G1ALG	●								
R510511						2 MITADES				●					

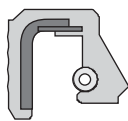

GA



GALG



G1A



G1ALG

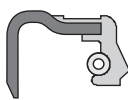

G1

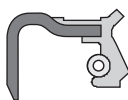

G1LG

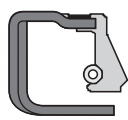

G2



G1SRLG

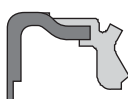

G2LG



GALGR/D

c/f Con Fielro
Con feltro/With Felt

REF		DE [mm]	DA [mm]	H [mm]	A [mm]	TIPO Type	MATERIAL								
							N	S	P	V	T	VF			
R310256		38.10	63.55	12.7		GA	●								
R220455		40.00	52.00	7.5		GALG	●								
R240455		40.00	52.00	8.5		E-GALG	●								
R320055		40.00	55.00	6.5		G1SRLG	●								
R300358		40.00	55.00	8		GALG	●								
R310760		40.00	55.00	9		G1LG-BI	●								
R460760-1		40.00	58.00	10		GALG-BI c/f			●						
R220359		40.10	52.00	9		ESP-GALG	●								
R250455		42.00	56.00	7		GA	●								
R220158		44.45	53.97	4.57		GA	●								
R220355		44.50	62.00	11		GALG-BI	●								
R250258		45.00	59.00	10		G1	●								
R450158		45.00	60.00	10		GA	●								
R450055		45.00	62.00	12		GA	●								
R220358		45.00	65.00	8		GALG	●								
R310658		46.00	65.50	7/8.5		G1LG-BI	●								
R550459		46.43	69.78	12.3		GALG	●								
R310252		47.70	73.10	12.7		ESP	●								
R220356		48.00	72.00	7/8.5		GALG	●								
R550555		48.70	58.00	8.5		ESP	●								
R460255		48.90	63.00	10/12.8		GALG				●					
R300258-1		49.22	63.62	7.26		ESP	●								
R300455		50.00	65.00	9		ESP-G1	●								
R300258		50.80	66.60	6.5		G1SRLG	●								
R550458		50.80	69.85	9.53		GA	●								
R450055-1		52.00	75.00	12		GA	●								
R450355		53.00	79.00	10		ESP	●								
R300759		55.00	70.00	6/10		ESP	●								
R310458		58.95	76.00	9		G1SRLG	●								
R550655		60.00	70.00	9.1		ESP	●								
R350858		75.00	95.00	13		GALG	●								
R351155		95.00	115.00	13		GALG-BI	●								
R350258		95.00	130.00	13		G2LG	●								
R350458		100.00	120.00	13		G2LG	●								
R350958		100.00	125.00	12		G1A-BI	●								
R350255		110.00	140.00	13		G2LG	●								
R350455		120.00	145.00	15		G2LG	●								
R350955		125.00	150.00	15		G2LG-BI	●								
R800055		180.00	200.00	12		G1ALG	●								

RETENES DE TRANSMISIÓN - TRANSMISSÃO - TRANSMISSION

R300347		7.90	16.00	6		GA	●								
R550447		8.40	16.00	6.5		GA	●								
R240048		13.00	26.00	7		GALG	●								

RETENES RADIALES

RETENORES RADIAIS - OIL SEAL

RETENES POR Ø DE EJE - RETENORES POR DIÂMETRO DO EIXO - DIAMETER HOLDERS OIL SEAL

REF		DE [mm]	DA [mm]	H [mm]	A [mm]	TIPO Type	MATERIAL									
							N	S	P	V	T	VF				
R550051		13.00	26.00	9		GALG	●									
R250148		14.00	24.00	7		ESP	●									
R550451		15.00	26.00	7		GALG	●									
R300748		15.50	28.00	6/15		ESP	●									
R300048		15.70	23.81	4.76		GA SR	●									
R550648		16.00	22.80	4.8		GA	●									
R250448		16.00	24.60	9/20		ESP	●									
R450348		17.00	23.00	7		ESP	●									
R300749		17.00	28.00	7/10		GALGHD	●									
R550450		17.00	28.00	7/13		GAHD	●									
R220649		20.00	35.00	7/10.5		GAHD			●							
R240949		21.00	32.00	7.5		G1LGHD	●									
R300751		21.50	40.00	7		GAHD			●							
R250451		22.00	40.00	7/8.5		G2LGHD	●									
R200349		22.10	40.00	12/17		GALGHD	●									
R260251		22.80	40.00	7/8.5		G2LGHD			●							
R250457		23.00	37.00	13.5		ESP			●							
R550550		24.00	36.00	8/12		GAHD	●									
R550951		27.95	56.00	10		GALGHD			●							
R570351		27.95	70.00	10		GALGHD			●							
R250151		28.00	47.00	8		GAHD	●									
R300351		28.00	40.00	8		GALGHD	●									
R450557		28.00	45.00	8		GAHD			●							
R300051		28.58	41.20	6.2		G1HD	●									
R200849		29.90	45.00	7		G1HD			●							
R200051		31.68	44.45	6.35		G1HD	●									
R250050		32.00	56.00	10		GALGHI	●									
R450351		32.00	50.00	10		GAHD			●							
R220150		34.92	56.00	10.7		GALGRI	●									
R300350		35.00	49.70	12.7		G1LGRI	●									
R250257		36.00	68.00	10/13		GAHD	●									
R300050		38.10	60.30	12.5/19		ESP-RI	●		●							
R300057		39.68	80.29	7/16		ESP-RD	●									
R450350		40.00	58.00	10		GAHI	●		●							
R250757		46.00	78.00	10		G1LGHD	●									
R260950		63.00	69.50	11		ESP			●							
R350957		68.00	85.00	10		GALGHD				●						
R360057		68.00	85.00	16		GALG	●									

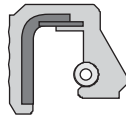

GA



GALG

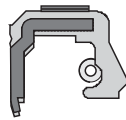

G1A



G1ALG

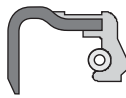

G1

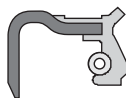

G1LG

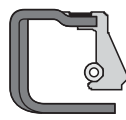

G2

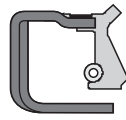

G2LG

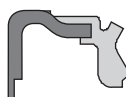

G1SRLG

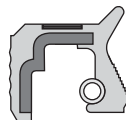

GALGR/D

cf Con Fieltro
Con feltro/With Felt

EL MISMO RETEN FABRICADO EN DISTINTOS CAUCHOS

Aconsejamos el uso prioritario de los materiales recomendados en las aplicaciones y referencias originales de nuestro catálogo.

Con el propósito de ofrecer un mejor servicio atendiendo las preferencias de diferentes mercados y clientes, algunos retenes de nuestro catálogo se fabrican también en materiales alternativos.

Si el material recomendado no se ajusta a sus necesidades, le sugerimos que consulten la lista de retenes TARANTO, clasificados por dimensiones, para verificar si la misma pieza puede ser suministrada en otro caucho.

O MESMO RETENTOR FABRICADO EM DIFERENTES MATERIAIS

Recomendamos o uso prioritário dos compostos indicados nas aplicações e referências originais do nosso catálogo.

Com o intuito de oferecer melhor serviço atendendo as preferências de diferentes mercados e clientes, alguns retentores de nosso catálogo são fabricados em materiais alternativos.

Se o material recomendado não se ajusta a suas necessidades sugerimos que consultem a lista de retentores TARANTO, classificados por dimensões para verificar se a mesma peça pode ser fornecida em outra borracha.

THE SAME OIL SEAL MANUFACTURED IN VARIOUS RUBBERS

It is suggested, as a priority, the use of the materials recommended in the applications and original references (OEM) of our catalogue.

However in order to offer a better service and to assist the preferences of different markets and customers some oil seals of our catalogue are also manufactured with alternative materials.

If the recommended material does not meet your requirements, you should consult TARANTO oil seal list classified by dimensions, to confirm if the same piece can be supplied in another rubber.

DISEÑO

La constante mejora de nuestros retenes produjo cambios en el diseño tales como:

- Ⓐ **Modificación de diseño externo:**
Facilita el montaje y asegura el agarre.
- Ⓑ **Labios desplazados:**
Permiten trabajar el labio en una parte del eje no utilizada hasta el momento.
- Ⓒ **Diseño de labio:**
Se potenció el uso de la rosca como sello hidrodinámico.

PROJETO

A constante melhora de nossos retentores produziu mudanças de projeto como:

- Ⓐ **Modificação de desenho externo:**
Facilita a montagem e assegura o alojamento.
- Ⓑ **Lábios deslocados:**
Permite que o lábio trabalhe em uma parte do eixo ainda não utilizada.
- Ⓒ **Desenho do lábio:**
Aumentou a utilização da rosca como vedação hidrodinâmica.

DESING

The steady improvement of our oil seals produced changes in desing such as:



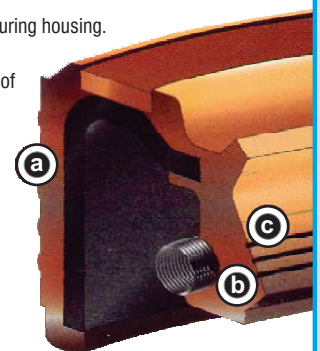































- Ⓐ **Changes in external design:**
Making assembly easier and ensuring housing.
- Ⓑ **Displaced Lips:**
Allowing the lip to work in a part of shaft not used so far.
- Ⓒ **Lip Design:**
The use of thread as hydrodynamic seal was potentialized.













































































GUÍA DE VÁLVULAS

HASTE DE VÁLVULAS - VALVE SEALS

FORD

Imagen Picture	REF		Equivalente Equivalent	Q	DE [mm]	DA [mm]	H [mm]	A [mm]	Imagen Picture	REF		Equivalente Equivalent	Q	DE [mm]	DA [mm]	H [mm]	A [mm]
	R150010P		R250410V/1	4	8	10.8	10			R230710V		R260610V/1	12	7	9.8	10	
	R150010T		R450010T/1	4	8	10.8	10			R231410V		R230510V/1	20	6	8.8	9.5	
	R200010P		R200010P/1	12	7.9	17	12.3			R240010V R240010P		R430010V/1 R430010V/1	8 8	8	12	9.5	15.2
	R200410N		R200610N/1	8	7.27	10.94	2			R240210V R240210P R240210VM/1 R240210VM/2 R240210VM/3		R240210V/1 R240210V/1 R240210V/1 R240210V/1 R240210V/1	8 8 200 200 1000	7	11.1	10	
	R200610N		R200610N/1	12	7.27	10.94	2			R240710P		R240710P/1	8	8	12	14	
	R210010P		R300010P/1	8	7.9	15.5	12.5			R241910P		R241910P/1	12	7.4	11.68	16	
	R220110P		R300310P/1	8	7.9	15.5	12.5			R242110P		R242110P/1	12	7.5	14	12.5	
	R220210P		R220210P/1	8	7.9	14.8	9.2			R242210V		R230510P/1	8	6	8.8	9.5	
	R220410V		R250410V/1	8	8	10.8	10			R242910V		R242110P/1	8	7.5	14	12.5	
	R221110V		R250410V/1	10	8	10.8	10			R244010V		R230510P/1	8	6	8.8	9.5	
	R221710V		R230510V/1	20	6	8.8	9.5			R250110P R250110PN/1		R250110P/1 R250110P/1	8 200	7	11.8	10.2	
	R223810V		R260610V/1	16	7	9.8	10			R250410V R250410VM/1 R250410VM/2 R250410VM/3		R250410V/1 R250410V/1 R250410V/1 R250410V/1	8 200 200 1000	8	10.8	10	
	R224010V		R230510V/1	8	6	8.8	9.5			R250810P		R550410P/1	8	7	9.7	10.2	
	R230210V R230210P		R260610V/1 R260610V/1	8 8	7	9.8	10			R252310V		R230510V/1	8	6	8.8	9.5	
	R230410P		R230410P/1	16	6	10.9	18	26.9		R253010V		R253010V/1	8	5	10	15.5	23.48
	R230510V R230510P R230510VM/1 R230510VM/2 R230510VM/3 R230510VM/4		R230510V/1 R230510V/1 R230510V/1 R230510V/1 R230510V/1 R230510V/1	16 16 200 200 1000 600	6	8.8	9.5			R260610V R260610VM/1 R260610VM/2 R260610VM/3		R260610V/1 R260610V/1 R260610V/1 R260610V/1	16 200 200 1000	7	9.8	10	
										R270110P		R430010V/1	8	8	12	9.5	15.2







































FORD

Imagen Picture	REF		Equivalente Equivalent	Q	DE [mm]	DA [mm]	H [mm]	A [mm]	Imagen Picture	REF		Equivalente Equivalent	Q	DE [mm]	DA [mm]	H [mm]	A [mm]
	R270510V R270510P		R260610V/1 R260610V/1	8 8	7	9.8	10			R291010V		R291010V/1	16	5	7.8	15.5	23
	R270710V		R230510V/1	16	6	8.8	9.5			R300010P R300010PN/1		R300010P/1 R300010P/1	12 144	7.9	15.5	12.5	
	R270910V		R260610V/1	20	7	9.8	10			R300010-1P		R300010-1P/1	12	7	19.5	17.5	
	R271210V R271210VM/2		R271210V/1 R271210V/1	8 200	5	7.8	8			R300210P		R300310P/1	16	7.9	15.5	12.5	
	R272010P		R272010P/1	16	6	11	18.3			R300310P R300310PN/1		R300310P/1 R300310P/1	8 200	7.9	15.5	12.5	
	R272910V		R272910V/1	6	5	8.85	18.25			R300610V R300610P		R430010V/1 R430010V/1	8 8	8	12	9.5	15.2
	R273010V		R272910V/1	8	5	8.85	18.25	23.45		R301010V		R301010V/1	8	8	14.08	16.5	
	R280110P		R280110P/1	16	8.68	14.27	17.19	23.45		R301110V		R322410P/1	8	7	11.6	8.8	
	R280210V		R280210V/1	8	5.8	11.4	10.4			R301810V		R242110P/1	8	7.5	14	12.5	
	R280310P		R400210P/1	8	9.1	12.3	15.1			R302010V		R302010V/1	16	7	12	18.8	24.2
	R280410V		R280410V/1	8	7	10.7	14.5			R302110V		R302110V/1	8	6	9	17.5	23
	R280610V		R230510V/1	16	6	8.8	9.5			R302210V		R302210V/1	8	5.5	11	18	25
	R281110P		R281110P/1	16	8	14	12.9			R302510V		R302510V/1	24	6	12.4	18.7	25.3
	R281610V		R271210V/1	8	5	7.8	8			R310310P		R310310P/1	16	8.4	19.5	16.6	
	R282510P		R940010P/1	8	5	9	9.5			R310410V		R310410V/1	8	9	13.4	11	
	R290010P		R290010V/1	16	6	10	16	25		R310510V		R310410V/1	12	9	13.4	11	
	R290210P		R290210P/1	8	5.97	11.39	11.98			R310810V R310810P R310810VM/1 R310810VM/2		R310810V/1 R310810V/1 R310810V/1 R310810V/1	8 8 200 200	7	10.9	9.5	
	R290610P		R290610P/1	12	8.58	14	17			R310910P		R430010V/1	12	8	12	9.5	15.2

GUÍA DE VÁLVULAS

HASTE DE VÁLVULAS - VALVE SEALS







































FORD

Imagen Picture	REF		Equivalente Equivalent	Q	DE [mm]	DA [mm]	H [mm]	A [mm]	Imagen Picture	REF		Equivalente Equivalent	Q	DE [mm]	DA [mm]	H [mm]	A [mm]
	R311110P		R310310P/1	8	8.4	19.5	16.6			R340610P		R340610P/1	8	7.2	12.4	14.5	
	R320010V		R320010V/1	8	8	12	12			R340710P		R340710P/1	16	6.05	15.30	20.55	28
	R320210P		R320210P/1	12	8.68	12.6	16			R340910P		R340910P/1	12	7.7	17	14.2	
	R320310V R320310VM/2 R320310VM/3		R320310V/1 R320310V/1 R320310V/1	16 80 480	6	11.75	20.7	24		R350110P		R350110P/1	8	9	15.04	15.4	
	R320710P		R320710P/1	16	8.73	19.4	19.48			R350210P		R350110P/1 R350110-1P/1	6 6	9 9.9	15.04 15.04	15.4 15.4	
	R320910V		R320910V/1	16	6	10.8	15.9			R350210-2P		R350110-1P/1	12	9	15	15	
	R321710V		R321710V/1	12	5	9.4	17	22.6		R350610P		R350110P/1	20	9	15.04	15.4	
	R322210P		R322210P/1	8	8	12.5	12			R351010V		R430010V/1	12	8	12	9.5	15.2
	R322310P		R322310P/1	12	8	12	13.3			R351110V		R351110-1V/1 R351110-2V/1	5 5	7.1 8.1	11.65 11.65	10.6 10.6	
	R322410P		R322410P/1	12	7	11.6	8.8			R351210V		R260610V/1	16	7	9.8	10	
	R324910V		R302010V/1	20	7	12	18.8	24.2		R352010V		R430010V/1	18	8	12	9.5	15.2
	R330310P		R330310P/1	8	8	15.45	23.2	29		R352410V		R260610V/1	20	7	9.8	10	
	R330510V		R310810V/1	12	7	10.9	9.5			R360010V R360010P		R360010V/1 R360010P/1	12 12	12	16	15.7	
	R330610V		R310810V/1	18	6	10.6	9.5			R360410P		R350110P/1	24	9	15.04	15.4	
	R330710V		R310410V/1	12	9	13.4	11			R400010P R400010PN/1		R400010P/1 R400010P/1	8 200	7.9	14	13.2	
	R340110V R340110VM/2 R340110VM/3		R340110V/1 R340110V/1 R340110V/1	8 80 480	6	11.3	18	27		R400110P		R400010P/1	12	7.9	12.75	12.8	
	R340210V		R340210V/1	8	6	11.3	18	27		R400210P		R400210P/1	12	9.1	12.3	15.1	
	R340510P		R242110P/1	16	7.5	14	12.5			R400510P		R400010P/1	6	7.9	14	13.2	

GUÍA DE VÁLVULAS

HASTE DE VÁLVULAS - VALVE SEALS







































FORD

Imagen Picture	REF	 Equivalente Equivalent	Q	DE [mm]	DA [mm]	H [mm]	A [mm]	Imagen Picture	REF	 Equivalente Equivalent	Q	DE [mm]	DA [mm]	H [mm]	A [mm]
	R400610P	R300310P/1	6	7.9	15.5	12.5			R470810V	R470810V/1	8	6	10	21.5	19.6
	R401710P	R300310P/1	12	7.9	15.5	12.5			R471310V	R471310V/1	16	5.5	9.5	13.8	18.1
	R400610P	R400010P/1	6	7.9	14	13.2			R471410V	R470810V/1	16	6	10	21.5	19.6
	R410510P	R420410P/1	8	8.58	11.9	11.5			R471710V	R471710V/1	16	5	9	18	22.6
	R410910N	R410910N/1	12	7.57	15.6	18.9			R500010P	R300310P/1	8	7.9	15.5	12.5	
	R420410P	R420410P/1 R420410P/4	6 8	8.58	11.9	11.5			R510010P	R510010P/1	12	7.4	10.8	13.9	
	R420610P	R420610P/1	8	7.4	11.5	9			R510210P	R300310P/1	12	7.9	15.5	12.5	
	R430010V R430010VM/1 R430010VM/2	R430010V/1 R430010V/1 R430010V/1	8 200 200	8	12	9.5	15.2		R510410P	R510410P/1	8	8	13.5	13	
	R430110P	R430110P/1 R430110P/2	4 4	7.24 6.70	12.70 11.70	10.30 10.70			R510510V R510510P	R510510V/1 R510510P/1	12 12	8	13.48	17.2	
	R430810V	R430810V/1	16	6	12	20	24.5		R510710V	R510510V/1	16 16	8	13.48	17.2	
	R450010P	R250410V/1	8	8	10.8	10			R520210P	R300310P/1	8	7.9	15.5	12.5	
	R450010T	R450010T/1	8	8	10.8	10			R520310P	R520310P/1	8	7	11.4	9.8	
	R452010V	R452010V/1	8	7	9.8	10.2			R520410P	R520310P/1	10	7	11.4	9.8	
	R460210V	R250410V/1	8	8	10.8	10			R520510P	R520510P/1	16	8.49	13.69	14.4	
	R460710V R460710P	R260610V/1 R260610V/1	8 8	7	9.8	10			R520810P	R520810-1P/1 R520810-2P/1	8 4	8 8	13 5	13.5 8	
	R460810V	R460810V/1	16	7	17	18			R521010P	R272010P/1	16	6	11	18.3	
	R461510P	R250410V/1	12	8	10.8	10			R521710V	R521710V/1	16	7	12	18.15	31.2
	R470010V	R260610V/1	12	7	9.8	10			R521810V	R521710V/1	12	7	12	18.15	31.2





































GUÍA DE VÁLVULAS

HASTE DE VÁLVULAS - VALVE SEALS

FORD

Imagen Picture	REF	 Equivalente Equivalent	Q	DE [mm]	DA [mm]	H [mm]	A [mm]	Imagen Picture	REF	 Equivalente Equivalent	Q	DE [mm]	DA [mm]	H [mm]	A [mm]
	R540210P	R300310P/1	12	7.9	14	13.2			R650110P	R650110P/1	12	7	19	12.5	
	R550410P R550410PN/1	R550410P/1 R550410P/1	8 200	7	9.25	10			R660010P	R650110P/1	6	7	19	12.5	
	R550610T	R450010T/1	8	8	10.8	10			R660110P	R650110P/1	8	7	19	12.5	
	R550610P	R250410V/1	8	8	10.8	10			R660210P	R650110P/1	8	7	19	12.5	
	R550910T	R550910T/1	8	7	10.8	10			R800810P	R520810-1P/1 R520810-2P/1	12 12	6 6.3	12.15 12.15	14.3 14.6	
	R550910V R550910P R550910VM/1 R550910VM/2	R550910V/1 R550910V/1 R550910V/1 R550910V/1	8 8 200 200	7	10.8	10			R860010V	R860010V/1	8	6	11.7	13.80	
	R560110V R560110P	R250410V/1 R250410V/1	8 8	8	10.8	10			R860110V	R860110V/1	16	5	9.5	9.5	
	R560810V R560810P	R260610V/1 R260610V/1	8 8	7	9.8	10			R860210P	R860210P/1	8	6	11.8	10.1	
	R570110V	R260610V/1	12	7	9.8	10			R860610V	R860610V/1	8	7	11.9	12.5	
	R570510V	R570510V/1	8	6	10.9	20	28.2		R860710V	R860610V/1	12	7	11.9	12.5	
	R570910V R570910VM/2 R570910VM/3	R570910V/1 R570910V/1 R570910V/1	16 80 480	5.5	11	16.5	28		R860810P	R860810P/1	16	5	11	10	
	R571210V	R940010/1	12	5	9	9.5			R862710V	R862710V/1	16	5.5	11	10	
	R580410V	R260610V/1	16	7	9.8	10			R870010P	R870010P/1	8	8	12.7	14	
	R581010V	R581010V/1	16	5.5	10.9	15.5	23		R870110P	R870010P/1	12	8	12.7	9.5	
	R581310V	R230510V/1	16	5	10.7	15.5			R870210V	R870210V/1	12	8.9	15.9	10	36.5
	R581410V	R260610V/1	12	7	9.8	10			R870510V	R800810V/1 R800810V/2	8 8	6 6.3	12.15 12.15	14.3 14.6	
	R571210V								R870610V	R870610V/1	24	8	13.6	19	33.7
	R581710V	R581710V/1	16	5	8.20	7.85			R890610P	R890610P/1	16	6	11.7	9.5	31
	R581810V	R581810V/1	16	5	8.5	9.5									

FORD

Imagen Picture	REF		Equivalente Equivalent	Q	DE [mm]	DA [mm]	H [mm]	A [mm]	Imagen Picture	REF		Equivalente Equivalent	Q	DE [mm]	DA [mm]	H [mm]	A [mm]
	R900010P		R900010P/1	8	7	10.7	12			R930110P		R930110P/1	8	9	14	17	
	R900110P		R900010P/1	12	7	10.7	12			R940010P		R940010P/1	6	5	9	9.5	
	R900810P		R900810P/1	8	7	12.4	13			R950010P		R950010P/1	4	7	12	15	
	R900910P		R900910P/1	8	7	13.9	14.5			R950110P		R950010P/1	6	7	12	15	
	R902110P		R902110P/1	16	5	9.4	10.9			R950210P		R260610V/1	12	7	9.8	10	
	R902210P		R902210P/1	8	8	11.9	13.7			R950310P		R950310P/1	8	8	12.9	13.75	
	R902310P		R902310P/1	8	7	11	12.5			R950410P		R950410P/1	8	7	13.5	21	
	R902510P		R902510-1P/1 R902510-2P/1	8 4	6 7	10.7 11.8	11.9 12			R950510P		R950510P/1	4	7	12	13	
	R902610P		R902610-1P/1 R902610-2P/1	4 4	8	14	20			R950710P		R950710P/1	4	7	12	11	
	R903610P		R902510-1P/1	8	6	10.7	11.9			R951010P		R951010P/1	6	5.4	11.8	12	
	R910510P		R910510P/1	8	7	13	13			R951110P		R951010P/1	9	5.4	11.8	12	
	R912210P		R912210P/1	8	7.5	14	13			R960010P		R960010P/1	24	6	10.8	10.6	
	R920010P		R920010P/1	8	7	12	12			R970010P		R970010P/1	8	6	12.5	12	
	R921910P		R921910P/1	8	8	13.6	9.6			R970310P		R970310P/1	8	8	14	13.5	
	R922310V		R922310P/1	4.7	10.7	11.1	9.6			R971810P		R971810P/1	8	7	13.76	14.55	
	R922510P		R922510P/1	8	8	13	10.4			R981310P		R981310P/1	16	6	11.4	18	
	R922810P		R922810P/1 R922810P/2	8 8	4.35 5.05	10.1 10.2	10.15 10										
	R926610P		R926610V/1 R926610V/2	8 8	4.7 4.4	10.8 10.9	11.1 10										

PORTA RETENES

PORTA RETENTORES - CRANKSHFT SEAL





RETENES POR Ø DE EJE - RETENTORES POR DIÂMETRO DO EIXO - DIAMETER HOLDERS OIL SEAL

	Código Code	Descripción Descrição Descrição	Aplicación Aplicação Application	Cm³ Cm³	Motor Motor Engine
	PR221711V PR221711T PR221711VF	PORTA RETEN BANCADA 	AUDI A3 Turbo 1996/..., A3, A3 Quattro, A6 1997/... SEAT Alhambra Turbo 1998/..., Leon Turbo 1998/... VOLKSWAGEN Golf, Sharan 1997/..., Bora 2000/... New Beetle, Passat Turbo 1999/...	1781cc. 1781cc. 1781cc.	AJP/AGU/AQA/AJQ/APP AJH/AJQ/APP Turbo 20V AGU/ARZ/AJH/AVC/AWU/AWC ARG/APT
	PR224011T	PORTA RETEN BANCADA 	SEAT Cordoba, Ibiza 2003/... VOLKSWAGEN Fox 2005/..., Polo 2003/05 Polo, Caddy 1997/01, Gol 2001/..., Lupo 2004/09 Fox 2005/..., Fox Route, Suran 2006/... Fox 2003/... Gol Power	1998cc. 1390cc. 1598cc. 999cc. 1390cc.	BAH (SOHC) 8V BKR/BLM (SOHC) 8V BAH/ BLH/BJA/BPA (SOHC) 8V AQZ - BJE 8V EA111 (SOHC) 8V
	PR230211V PR230211VF	PORTA RETEN BANCADA 	SEAT Ibiza D/TD, Cordoba 1996/99, Toledo 1997/99 VOLKSWAGEN Passat TD 1994/96, Golf D/TD Vento D/TD 1995/98, Polo D, Caddy 1995/...	1896cc. 1896cc.	1Y/AAZ 1Y/AAZ/AEY
	PR231211T	PORTA RETEN BANCADA 	VOLKSWAGEN Gol Power 2002/..., Suran Voyage, Fox, Gol Trend	999cc. 1598cc.	AT (SOHC) 8V BKR/BLM/BAH/BJA/BLH/BPA
	PR231411V	PORTA RETEN BANCADA 	VOLKSWAGEN Bora, Vento 2005/09	2480cc.	L5 BGP/BGQ
	PR232411T	PORTA RETEN BANCADA 	VOLKSWAGEN Pick Up Amarok TDI 2010/... Inyección directa Common Rail	1968cc.	CDBA - CDCA
	PR232411T-2		VOLKSWAGEN Pick Up Amarok TDI 2010/... Inyección directa Common Rail	1968cc.	CDBA - CDCA
	PR232911V	PORTA RETEN BANCADA 	AUDI TT TFSI - A3 FSI 2007/... AUDI TT TFSI 2006/... A3/4/5 2008/... Q5/A4 2009/... SEAT Leon - Toledo TSI SKODA Octavia TSI 2007/... VOLKSWAGEN Passat TSI 2007/... VOLKSWAGEN Golf, Eos, Tiguan, Passat FSI 2007/...	1798cc. 1984cc. 1798cc. 1798cc. 1798cc. 1984cc.	BYT/BZB/CDA CCTA/CDNB/CDNC/CAEB/CBFA CDA BZB/CDA BZB/CDA/CDA CBFA/CCTA/CCZA/CBFA/CAWB
	PR233311T	PORTA RETEN BANCADA 	AUDI A3 FSI 2003/... SKODA Octavia 2004/... VOLKSWAGEN Golf FSI, Touran FSI, Passat FSI Jetta FSI 2005/..., Eos FSI, Polo, Crosspolo 2006/...	1598cc. 1598cc. 1598cc.	BAG/BLP/BLF (DOHC) 16V BLF (DOHC) 16V BTS/BLF (DOHC) 16V
	PR260911V	PORTA RETEN BANCADA 	FIAT Palio, Siena, Tipo 1.6, Bravo, Marea, Multipla LANCIA Delta, Dedra, Lybra 1996/...	1581cc. 1581cc.	182A4/A6 - 186A3/A4 16V 182A4 - 182A6
	PR270111V	PORTA RETEN BANCADA 	FIAT Nuovo Ducato 1989/94 FIAT Ducato TD 1990/94, Ducato TDS 1994/96 Ducato TDSE 1996/..., Ducato 1994/... FIAT Ducato 14, Ducato 18 Maxi, Ducato 14/18D 98/... IVECO Daily Turbo 1990/..., 30.8 - 35.8 1996/... RENAULT Master 1990/..., 1998/... - Trafic 1990/...	2445cc. 2499cc. 2499cc. 2799cc. 2499cc. 2499cc.	8140.67 8140.27 - 8140.47R 1 8140.67X230 8140.63 Iny. Indirecta 8140.27S - 8140.47/S/R - 67F37 S8U

PORTA RETENES

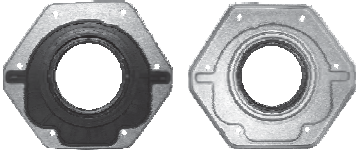
PORTA RETENTORES - CRANKSHFT SEAL

RETENES POR Ø DE EJE - RETENTORES POR DIÂMETRO DO EIXO - DIAMETER HOLDERS OIL SEAL

	Código Code	Descripción Descrição Descrição	Aplicación Aplicação Application	Cm³ Cm³	Motor Motor Engine
	PR270112V	PORTA RETEN DISTRIBUCION	FIAT Nuovo Ducato 1989/94 FIAT Ducato TD 1990/94, Ducato TDS 1994/96 Ducato TDSE 1996/..., Ducato 1994/... FIAT Ducato 14, Ducato 18 Maxi, Ducato 14/18D 98/... IVECO Daily Turbo 1990/... IVECO Daily 30.8 - 35.8 1996/... RENAULT Master 1990/... 1998/..., Trafic 1990/... IVECO Daily 30.8, Daily 35.8 1996/... IVECO Turbo Daily 35.10 - 49.12 1996/...	2445cc. 2499cc. 2499cc. 2799cc. 2499cc. 2499cc. 2499cc. 2799cc. 2799cc.	8140.67 8140.27 - 8140.47R 1 8140.67X230 8140.63 Iny. Indirecta 8140.27S - 8140.47S/R 8140.67F37 S8U 8140.63 Iny. Indirecta 8140.23 - 8140.43
	PR270511V	PORTA RETEN BANCADA	FIAT Uno, Palio, Siena, Mille Fire FIAT Uno, Palio, Siena, Mille Fire FIAT Palio - Siena - Strada	999cc. 1300cc. 1368cc.	Fire 8V MPI 50HP Ø70 Fire 8V MPI 75HP Ø70.8 Fire 8V 80/81HP Ø72
	PR270711V	PORTA RETEN BANCADA	FIAT Palio, Siena, Palio Weekend, Palio Novo Novo Siena, Doblo LANCIA Ypsilon 2000/...	999cc. 1242cc. 1242cc.	Fire 1714130 (DOHC) 16V Fire 188.A5 (DOHC) 16V Fire 188.A5 (DOHC) 16V
	PR270911V	PORTA RETEN BANCADA	FIAT Marea, Bravo 1996/98 - 1998/..., Coupe 1996/01 LANCIA Kappa 1994/01 - 1996/02	1998cc. 1998cc.	182A1 - 182B3/B7 838A1 - 838A6 - 182B7
	PR271911VF	PORTA RETEN BANCADA	FIAT Fire 1.3, Fiorino, 500 2007/... Fire 1.4 ELX, Evo 2010/..., Idea 2003/... Palio Fase II/III 2007/13, Siena Gen. III MPI 2002/... Grande Punto 2005/..., Linea 2007/..., Strada Fase III LANCIA Musa 2004/...	1242cc. 1368cc. 1368cc.	350 A1.000 169 A4.000 169 A4.000
	PR291011T	PORTA RETEN BANCADA	CHEVROLET Aveo 2009/... CHEVROLET Cruze 2008/... OPEL Astra H 2004/..., Signum, Vectra C 2006/..., Zafira B 2005/..., Insignia 2008/... FIAT Cromia 2005/... ALFA ROMEO 159 2005/...	1399cc. 1796cc. 1796cc. 1796cc. 1796cc.	F14D4 (DOHC) 16V F18D4 (DOHC) 16V Z18XER - A18XER (DOHC) 16V 939A4 (DOHC) 16V 939A4 (DOHC) 16V
	PR291611V	PORTA RETEN BANCADA	CHEVROLET Captiva 2010/18	2997cc.	LF1, LFW V6 24V Inyección Directa
	PR302011T	PORTA RETEN BANCADA	FORD Transit TD 2000/... Mondeo TDCI 2000/02 - 2002/... Mondeo III DI 2002/02, Transit TDI-TDCI 2000/02 - 2002/... Transit DI 2000/02	2402cc. 1998cc.	Duratorq (DOHC) 16V HJBA/B/C - F3FA - F1FA ABFA - D3FA - D5BA D6BA (DOHC) Duratorq
	PR302211T	PORTA RETEN BANCADA	FORD Mondeo, Ranger 2001/..., Eco Sport 2003/... Mondeo 2000/..., Eco Sport 2003/..., Ranger 2001/... MAZDA 6 2002/..., 3 2003/... FORD Maverick 2003/... MAZDA 6 - MPV 2002/...	1999cc. 1999cc. 2261cc. 2261cc.	CJBA 145HP - Duratec HE 143H (DOHC) 16V Ø87.5 LF (DOHC) 16V 105/141HP Ø87. 154HP Ø87.5 L3 (DOHC) 16V 104/166HP Ø87.
	PR320011V	PORTA RETEN BANCADA	FORD Fiesta, Courier, Escort, Mondeo, Orion D Sierra TD, Mondeo TD 1991/..., Escort TDI 1994/...	1753cc.	D1.8 T/TI 60/75/90HP Ø82.5

PORTA RETENES

PORTA RETENTORES - CRANKSHFT SEAL

RETENES POR Ø DE EJE - RETENTORES POR DIÂMETRO DO EIXO - DIAMETER HOLDERS OIL SEAL

	Código Code	Descripción Descrição Descrição	Aplicación Aplicação Application	Cm³ Cm³	Motor Motor Engine
	PR320015V	PORTA RETEN AUXILIAR 	FORD Fiesta, Courier, Escort, Mondeo, Orion D Sierra TD, Mondeo TD 1991/..., Escort TDI 1994/... Focus TD di 1998/..., Fiesta TD di 2000/... Focus TD di 2001/..., Focus di 1999/...	1753cc. 1753cc.	D1.8 T/TI 60/75/90HP Ø82.5 Lynx (C9DC) 75/90HP Duratorq 115HP BHDA/BHDB 75HP Ø82.5
	PR320911T	PORTA RETEN BANCADA 	FORD Fiesta SE, Courier, Puma 1996/... FORD Focus, Fiesta Sport 1998/...	1388cc. 1596cc.	Zetec SE 16V 90/75HP Ø76 Zetec SE 16V 101/103HP Ø79
	PR340111V PR340111T PR340111VF	PORTA RETEN BANCADA 	FORD Ka 1999/... FORD Ka 1997/..., Fiesta 1999/..., Escort Eco Sport 2003/...	999cc. 1598cc.	Zetec Rocam ZL 65HP Ø68.69 Zetec Rocam ZL 95HP Ø82
	PR340314P	PORTA RETEN BOMBA INYECTORA 	FORD Focus TD di 1998/..., Fiesta TD di 2000/... Focus TD di 2001/..., Focus di 1999/...	1753cc. 1753cc.	Lynx (C9DC) 75/90HP Ø82.5 Duratorq 115HP Ø82.5 BHDA/BHDB 75HP Ø82.5
	PR351211T	PORTA RETEN BANCADA 	MERCEDES BENZ Sprinter 413 CDI 411/413/313 611/981 - C200-CDI 611.961/960 1998/... Vito 108/110/112 CDI, Sprinter 208/211/213 CDI 611.980	2151cc.	OM 611 - CDI 611.960/961 100/125HP 611.980 100/112HP Ø88 Iny. Directa
	PR370011T	PORTA RETEN BANCADA 	MERCEDES BENZ Clase A 140 1997/... Clase A 160 1997/..., Vaneo 2001/...	1397cc. 1598cc.	M166.940 82/102HP Ø80 M166.961 82/102HP Ø80
	PR430011V PR430011VF	PORTA RETEN BANCADA 	MERCEDES BENZ Sprinter TDI 1997/... ROVER Range Rover, Discovery, Defender TDI FORD Ranger TDI 1995/... GM CHEVROLET Blazer TDI, S10TDI 1995/... FORD Ranger TD BR 2000-2002/... Ranger 3.0l - 4 x 4 - Full BR Intercooler	2495cc. 2495cc. 2507cc. 2507cc. 2758cc. 3000cc.	95HP Ø90.5 200/300 TDI 112HP Ø90.5 95HP Ø90.7 95HP Ø90.7 Power Stroke 135HP Ø93 Maxion TD (SOHC) Ø96
	PR472111T	PORTA RETEN BANCADA 	CITROËN C1 II 2014/... PEUGEOT 208 2012/..., 108 2014/...	1199cc. 1199cc.	EB2DTS (HNY) 72HP Ø75 EB2DTS (HNY) 72HP Ø75
	PR901511V	PORTA RETEN BANCADA 	NISSAN Pathfinder, Cefiro, Qx4 2000/01	3498cc.	VQ35DE (DOHC) V6 24V 220HP Ø95.5
	PR521911T	PORTA RETEN BANCADA 	CHRYSLER Ram 2500, Ram 3500, Ram Quad, Charger, Jeep Comander, Sonora, 300C, Grand Cherokee, Aspen	5645cc.	V8 Hemi 345HP Ø99,5
	PR907611P	PORTA RETEN BANCADA 	NISSAN Patrol, Safari 1988/..., Safari Pick Up 1999/...	4169cc.	TD42 (OHV) 12V 161HP Ø96