



# TRINITER

SUSPENSION Y DIRECCION



2024

COMPONENTES DE SUSPENSION,  
DIRECCION Y TRANSMISION

## COMPONENTES DE SUSPENSIÓN Y DIRECCIÓN

SUSPENSÃO E DIREÇÃO / STEERING COMPONENTS

### COMO UTILIZAR ESTE CATALOGO

- TRINTER actualiza su tecnología en la fabricación de productos para satisfacer las necesidades de la industria automotriz. En este catálogo 2024 se presenta la línea completa de productos de Suspensión y Dirección, incluyendo los nuevos modelos.

### COMO USAR ESTE CATÁLOGO / HOW TO USE THIS CATALOG

A TRINTER atualiza sua tecnologia na fabricação de produtos para atender as necessidades da indústria automotiva. Este catálogo 2024 apresenta a linha completa de produtos de Suspensão e Direção, incluindo os novos modelos.



TRINTER updates its technology in product manufacturing to meet the needs of the automotive industry. This catalog 2024 presents the complete line of Suspension and Steering products, including the new models.

### CONTENIDO / CONTENTS

SUSPENSIÓN / SUSPENSÃO / SUSPENSION		DIRECCIÓN / DIREÇÃO / STEERING		TRANSMISIÓN / TRANSMISSÃO / TRANSMISSION	
<input checked="" type="checkbox"/>	<b>Bieletas de Suspensión</b> Bieletas de Suspensão / Link Stabilizers	01	<input checked="" type="checkbox"/>	<b>Extremos de Dirección</b> Terminais de Direção / Steering System	62
<input checked="" type="checkbox"/>	<b>Rótulas de Suspensión</b> Pivôs de Suspensão / Ball Joint Suspension	19	<input checked="" type="checkbox"/>	<b>Articulación Axial</b> Articulações Axiais / Axial Joints	79
<input checked="" type="checkbox"/>	<b>Parrillas y Brazos de Suspensión</b> Bandejas e Braços / Trays and Arms	33	<input checked="" type="checkbox"/>	<b>Barras de Dirección</b> Barras de Direção / Steering Bars	86
<input checked="" type="checkbox"/>	<b>Cazoletas de Suspensión</b> Coxims / Strut Mounting	40	<input checked="" type="checkbox"/>	<b>Cajas de Dirección</b> Caixas de Direção / Steering Gear	88
<input checked="" type="checkbox"/>	<b>Bujes de Suspensión</b> Buchas de Suspensão / Suspension Bushing	48		<input checked="" type="checkbox"/>	<b>Maza de Rueda</b> Cubos De Roda / Wheel Huld
<input checked="" type="checkbox"/>	<b>Soportes de Escape</b> Suporte de escape / Exhaust pipe support	59		<input checked="" type="checkbox"/>	<b>Homocineticas</b> Homocineticas / C.V. Joints
				<input checked="" type="checkbox"/>	<b>Puntas de Eje</b> Ponta de Eixo / Stub Axles

### GUÍA PARA EL USUARIO

#### GUIA DE USUARIO / USER GUIDE

Detalle Terminal y Aplicación	Año de aplicación	Componente de Suspensión y Dirección	Detalle Dimensional	Codificación TRINTER	Imagen del producto
<b>VOLKSWAGEN</b>					
	<b>Año</b> Ano   Year	<b>Descripción Sistema</b> Descrição   Decription	<b>Medidas</b> Medidas   Measures	<b>Código</b> Código   Code	<b>Imagen</b> Imagem   Image
VENTO GOLF V	2006/... 2003/...	DELANTERA DERECHA SIN RÓTULA	R RR B 12mm	PS231400D	
Detalle - Terminal e aplicativo Detail - Terminal and Application	Ano Year	Componente Suspensão e Direção Component Suspension and Steering	Detalle Dimensional Dimensional Detail	Codificação Coding	Imagem do Produto Product image

## COMPONENTES DE SUSPENSIÓN Y DIRECCIÓN

SUSPENSÃO E DIREÇÃO / STEERING COMPONENTS

### DESCRIPCIÓN DE LOS CÓDIGOS - MEDIDAS Y POSICIÓN

DESCRIÇÃO DOS CÓDIGOS (MEDIDAS E POSIÇÃO) / DESCRIPTION OF THE CODES (MEASUREMENTS AND POSITION)

#### SISTEMA DE SUSPENSIÓN

#### SISTEMA DE SUSPENÇÃO / SUSPENSION SYSTEM

##### BIELETAS DE SUSPENSIÓN Bieletas de Suspensão / Link Stabilizers

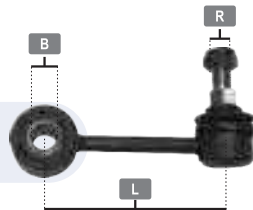

ABREVIATURAS / ABBREVIATIONS

- L** Largo / Comprimento / Length
- R** Rosca / Fio / Thread
- B** Ø Buje / Cubo / bushing

##### RÓTULA DE SUSPENSIÓN Pivôs de Suspensão / Ball Joint Suspension



ABREVIATURAS / ABBREVIATIONS

- DC** Ø de Cono / Cone
- DB** Ø de Base / Base
- RLM** Rosca lado Maza / Maza side thread

##### PARRILLAS Y BRAZOS DE SUSPENSIÓN Bandejas E Braços Suspensão / Trays and Arms

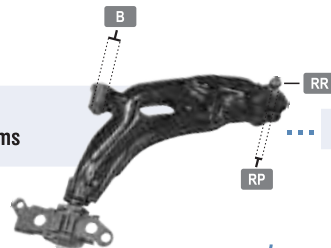

ABREVIATURAS / ABBREVIATIONS

- RR** Perno de rótula / ball stud
- RP** Rosca del perno rótula  
Ball joint bolt thread
- B** Ø Buje / Cubo / bushing

##### CAZOLETAS DE SUSPENSIÓN Coxims / Strut Mounting



ABREVIATURAS / ABBREVIATIONS



##### BUJES DE SUSPENSIÓN Buchas de Suspensão / Suspension Bushing

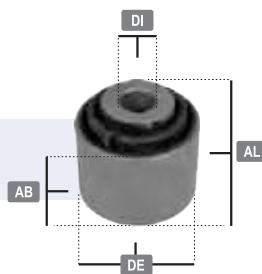

ABREVIATURAS / ABBREVIATIONS

- AL** Altura / Height
- AB** Altura Buje / Hub Height
- DE** Ø Exterior / Outside
- DI** Ø Interior / Inside

##### SOPORTES DE ESCAPE Suporte de escape / Exhaust pipe support



ABREVIATURAS / ABBREVIATIONS

- AL** Altura / Height
- L** Largo / Comprimento / Length
- AN** Ancho / Broad



## COMPONENTES DE SUSPENSIÓN Y DIRECCIÓN

SUSPENSÃO E DIREÇÃO / STEERING COMPONENTS

### DESCRIPCIÓN DE LOS CÓDIGOS - MEDIDAS Y POSICIÓN

DESCRIÇÃO DOS CÓDIGOS (MEDIDAS E POSIÇÃO) / DESCRIPTION OF THE CODES (MEASUREMENTS AND POSITION)

#### SISTEMA DE DIRECCIÓN

#### SISTEMA DE DIREÇÃO / STEERING SYSTEM

##### EXTREMO DE DIRECCIÓN Terminais de Direção / Steering System

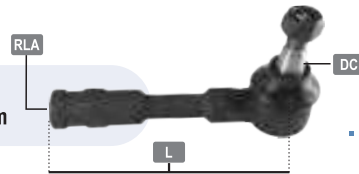

... ABREVIATURAS / ABBREVIATIONS

- L** Largo / Comprimento / Length
- DC** Ø Cono / Cone
- RLA** Rosca lado axial / Axial side thread

##### ARTICULACIÓN AXIAL Articulações Axiais / Axial Joints

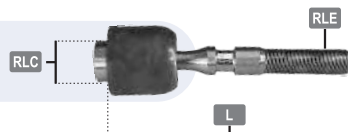

... ABREVIATURAS / ABBREVIATIONS

- L** Largo / Comprimento / Length
- RLC** Rosca lado cremallera  
Ball joint bolt thread
- RLE** Rosca lado extremo  
End side thread

##### BARRAS DE DIRECCIÓN Barras de Direção / Direction bars



... ABREVIATURAS / ABBREVIATIONS

- L** Largo  
Comprimento / Length
- DC** Ø Cono / Cone
- RA** Rosca de acople  
Rosca de acoplamento  
Coupling thread

#### CAJAS DE DIRECCIÓN / Caixas de Direção / Steering Gear

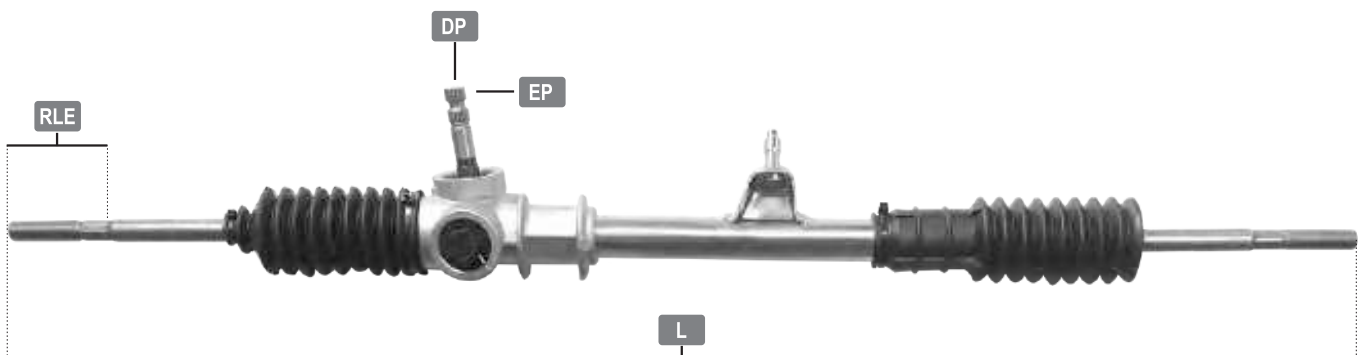

- L** Largo  
Comprimento / Length
- DC** Ø Cono  
Cone
- RLE** Rosca lado externo  
External side thread
- EP** Estrías piñón  
Sprocket splines
- DP** Ø Piñón  
Pinion
- RLA** Rosca lado articulación axial  
Axial joint side thread



## COMPONENTES DE SUSPENSIÓN Y DIRECCIÓN

SUSPENSÃO E DIREÇÃO / STEERING COMPONENTS

### DESCRIPCIÓN DE LOS CÓDIGOS - MEDIDAS Y POSICIÓN

DESCRIÇÃO DOS CÓDIGOS (MEDIDAS E POSIÇÃO) / DESCRIPTION OF THE CODES (MEASUREMENTS AND POSITION)

### SISTEMA DE TRANSMISIÓN

SISTEMA DE TRANSMISSÃO / TRANSMISSION SYSTEM

#### MAZA DE RUEDA Cubos De Roda / Wheel Huld

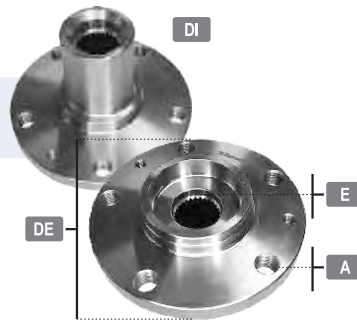

#### ABREVIATURAS / ABBREVIATIONS

- A** Agujeros / Furos / Holes
- E** Ø Estrias / Stretch marks
- DI** Ø Interior / Inside
- DE** Ø Exterior / Outside

#### HOMOCINETICAS Homocineticas / C.V. Joints

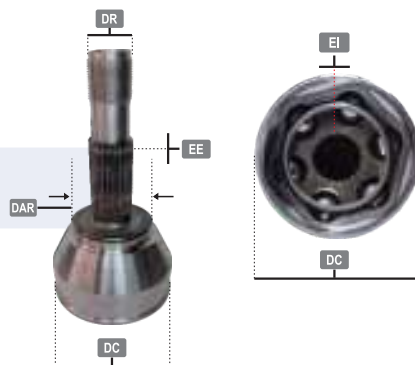

#### ABREVIATURAS ABBREVIATIONS

- EI** Estrias Interiores  
Estrias internas / Inner Teeh
- EE** Estrias Exteriores  
Estrias externas / Outer Teeh
- DR** Ø Rosca / Ø thread
- DC** Ø Copa / Copo / Cup
- DAR** Ø Asiento del Retén  
Assento Retentor / Retainer Seat

#### PUNTAS DE EJE Ponta de Eixo / Stub Axles



#### ABREVIATURAS / ABBREVIATIONS

- L** Largo / Comprimento / Length
- DB** Largo / Comprimento / Length

- Juntas para Motor
- Retenes
- Elementos De Fijación
- Sistemas De Embrague
- Balancines Y Botadores
- Bobinas De Ignición
- Bombas De Aceite
- Pastas Sellantes
- Herramientas De Instalación
- Bieletas de Suspensión
- Rótulas de Suspensión
- Brazos y Parrillas
- Cazoletas
- Bujes de Suspensión
- Soportes de Escape
- Articulaciones Axiales
- Extremos de Dirección
- Barras de Dirección
- Cajas de Dirección
- Mazas de Rueda
- Juntas Homocinéticas
- Puntas de Eje













DESCUBRI TODO  
NUESTRO CATALOGO

[www.taranto.com.ar](http://www.taranto.com.ar)











**BIELETAS DE SUSPENSIÓN**

BIELETAS DE SUSPENSÃO / LINK STABILIZERS

ALFA ROMEO					
	Año Ano   Year	Descripción Sistema Descrição   Decripción	Medidas Medidas   Measures	Código Código   Code	Imagen Imagem   Image
147	2002/10	DELANTERA	L 125mm	BE252615	
156	1998/07		R M10 x 1.5 mm		
GT	2005/11		B		
147	2002/10	TRASERA	L 180mm	BE252617	
156	1998/07		R M10 x 1.5 mm		
GT	2005/11		B		
AUDI					
A1	2011/13	DELANTERA	L 270mm	BE233915	
			R M10 x 1.5 mm		
			B		
A3	2003/...	DELANTERA	L 335mm	BE233215	
Q3	2012/...		R M12 x 1.5 mm		
TT	TT 2006/...		B		
A3	1996/03	DELANTERA DERECHA	L 334mm	BE221715D	
QUATRO	1999/...		R M12 x 1.5 mm		
S3	1999/...		B		
TT	1999/...				
A3	1996/03	DELANTERA IZQUIERDA	L 334mm	BE221715I	
QUATRO	1999/...		R M12 x 1.5 mm		
S3	1999/...		B		
TT	1999/...				
A4	2000/...	DELANTERA	L 318mm	BE223015	
			R M12 x 1.5 mm		
			B		
CHERY					
TIGGO	2008/...	DELANTERA	L 285mm	BE993215	
			R M10 x 1.5 mm		
			B		
CHEVROLET					
ASTRA	1998/...	DELANTERA	L 300mm	BE290815	
ZAFIRA	2002/...		R M12 x 1.5 mm		
			B		
AVEO	2009/...	DELANTERA	L 265mm	BE290115	
			R M10 x 1.25 mm		
			B		

**BIELETAS DE SUSPENSIÓN**

BIELETAS DE SUSPENSÃO / LINK STABILIZERS













CHEVROLET					
	Año Ano   Year	Descripción Sistema Descrição   Descrição	Medidas Medidas   Measures	Código Código   Code	Imagen Imagen   Image
CAPTIVA	2006/...	DELANTERA DERECHA	L 290mm R M12 x 1.5 mm B	BE290015D	
CAPTIVA	2006/...	DELANTERA IZQUIERDA	L 200mm R M12 x 1.5 mm B	BE290015I	
CAPTIVA	2006/...	TRASERA	L 167mm R M10 x 1.5 mm B	BE290017	
CORSA II MERIVA VECTRA	2002/... 2002/... 1997/...	DELANTERA	L 245mm R M12 x 1.5 mm B	BE240415	
ONIX PRISMA SONIC SPIN COBALT VOLT	2013/... 2013/... 2012/... 2011/... 2011/... 2011/...	DELANTERA	L 300mm R M12 x 1.5 mm B	BE244315	
S10 TRAILBLAZER	2013/... 2013/...	DELANTERA IZQUIERDA	L 160mm R M10 x 1.5 mm B	BE291315I	
S10 TRAILBLAZER	2013/... 2013/...	DELANTERA DERECHA	L 160mm R M12 x 1.5 mm B	BE291315D	
SPARK	2010/...	DELANTERA	L 235mm R M10 x 1.5 mm B	BE282515	
CHRYSLER - DODGE					
CARAVAN NEON	1996/00 1996/00	DELANTERA	L 320mm R M12 x 1.5 mm B	BE510015	
JOURNEY RT JOURNEY SXT	2009/... 2009/...	TRASERA	L 80mm R M12 x 1.5 mm B	BE523017	



**BIELETAS DE SUSPENSIÓN**











BIELETAS DE SUSPENSÃO / LINK STABILIZERS

**CITROËN**

	<b>Año</b> Ano   Year	<b>Descripción Sistema</b> Descrição   Descrição	<b>Medidas</b> Medidas   Measures	<b>Código</b> Código   Code	<b>Imagen</b> Imagem   Image
BERLINGO ZX XSARA	1995/... 1991/... 1997/...	DELANTERA	L 300mm R M10 x 1.5 mm B	<b>BE470615</b>	
C3 C3 PICASSO DS3 DS4	2002/10 2009/... 2010/... 2010/...	DELANTERA	L 335mm R M10 x 1.5 mm B	<b>BE452115</b>	
C4	2004/...	DELANTERA	L 335mm R M10 x 1.5 mm B	<b>BE471715</b>	
C4 PICASSO C4 GRAND PICASSO	2008/... 2008/...	DELANTERA	L 334mm R M10 x 1.5 mm B	<b>BE471915</b>	
C5 XANTIA	2002/05 1993/...	DELANTERA	L 320mm R M12 x 1.75 mm B	<b>BE471815</b>	
C5 C6	2008/... 2006/...	DELANTERA DERECHA	L 200mm R M12 x 1.75 mm M16 x 1.5 mm B	<b>BE452215D</b>	
C5 C6	2008/... 2006/...	DELANTERA IZQUIERDA	L 200mm R M12 x 1.75 mm M16 x 1.5 mm B	<b>BE452215I</b>	
C5 C6	2002/07 2006/09	TRASERA	L 141mm R M10 x 1.5 mm B	<b>BE471317</b>	
JUMPER FURGON	2005/10	DELANTERA	L 112 mm R B	<b>BE252815</b>	
JUMPER 1.4K JUMPER 1.8K	2006/... 2006/...	TRASERA	L 100mm R M10 x 1.25 mm B	<b>BE252817</b>	
JUMPY GII	2007/16	DELANTERA	L 263mm R M12 x 1.5 mm B	<b>BE472015-1</b>	











**BIELETAS DE SUSPENSIÓN**

BIELETAS DE SUSPENSÃO / LINK STABILIZERS

CITROËN					
	Año Ano   Year	Descripción Sistema Descrição   Descrição	Medidas Medidas   Measures	Código Código   Code	Imagen Imagem   Image
XANTIA AX SAXO	1996/... 1996/...	DELANTERA	L 323mm R M10 x 1.5 mm	BE470515	
XANTIA SAXO	1996/... 1996/...	DELANTERA	L 326mm R M12 x 1.75 mm B	BE451515	
FIAT					
IDEA PALIO GENERACION III PALIO WEEKEND STRADA GENERACION II - III	2004/... 2003/... 2003/... 2003/...	DELANTERA IZQUIERDA	L 220mm R M10 x 1.5 mm B	BE252515I	
IDEA PALIO GENERACION III PALIO WEEKEND STRADA GENERACION II - III	2004/... 2003/... 2003/... 2003/...	DELANTERA IZQUIERDA	L 220mm R M10 x 1.5 mm B	BE252515D	
DUCATO	2006/10	DELANTERA	L 112 mm R B	BE252815	
DUCATO 1.4K DUCATO 1.8K	2006/... 2006/...	TRASERA	L 100mm R M10 x 1.25 mm B	BE252817	
TORO	2016/...	DELANTERA	L 283mm R M12 x 1.5 mm B	BE253015	
MAREA TEMPRA	1993/00 1992/98	DELANTERA	L 275mm R M10 x 1.5 mm B	BE260915	
IDEA LINEA PALIO FASE I PALIO FASE II STRADA ADVENTURA STRADA WORKING	2005/10 2009/11 2001/05 2005/10 2005/10 2002/05	DELANTERA DERECHA	L 222.5 mm R B	BE270515D	
IDEA LINEA PALIO FASE I PALIO FASE II STRADA ADVENTURA STRADA WORKING	2005/10 2009/11 2001/05 2005/10 2005/10 2002/05	DELANTERA IZQUIERDA	L 222.5 mm R B	BE270515I	

**BIELETAS DE SUSPENSIÓN**











BIELETAS DE SUSPENSÃO / LINK STABILIZERS

FIAT					
	Año Ano   Year	Descripción Sistema Descrição   Descrição	Medidas Medidas   Measures	Código Código   Code	Imagen Imagen   Image
BRAVA	1995/02	DELANTERA	L 112mm	BE270915	
BRAVO	1995/02		R M10 x 1,25mm		
MAREA	1997/...		B 12mm		
TIPO	1987/00				
NUEVO UNO WAY	2011/...	DELANTERA	L 311mm	BE271215	
UNO SPORTING	2011/...		R M10 x 1.5 mm		
GRAND SIENA	2011/...		B		
PALIO ESSENCE	2012/...				
PUNTO	2007/...	DELANTERA	L 290mm	BE271715	
LINEA	2007/...		R M10 x 1.25 mm		
STILO	2007/...		B		
QUBO	2007/...				
PUNTO	2007/...	DELANTERA	L 301mm	BE271915	
			R M10 x 1.5 mm		
			B		
500	2007/...	DELANTERA	L 286mm	BE272015	
BRAVO	2013/...		R M10 x 1,25mm		
			B		
STILO	2001/08	DELANTERA	L 290mm	BE252315	
BRAVO	2007/...		R M10 x 1.25 mm		
			B		
DOBLO	2010/...	DELANTERA	L 297mm	BE272415	
DOBLO CARGO	2012/...		R M10 x 1.5 mm		
			B		
FIAT IVECO					
DAILY	1999/05	DELANTERA DERECHA	L 50mm	BE252915D	
			R M12 x 1,5mm		
			B		
DAILY	1999/05	DELANTERA IZQUIERDA	L 50mm	BE252915I	
			R M12 x 1,5mm		
			B		
FORD					
GALAXY	1995/...	DELANTERA	L 205mm	BE230015	
			R M12 x 1.5 mm		
			B		















**BIELETAS DE SUSPENSIÓN**

BIELETAS DE SUSPENSÃO / LINK STABILIZERS

FORD					
	Año Ano   Year	Descripción Sistema Descrição   Decripción	Medidas Medidas   Measures	Código Código   Code	Imagen Imagen   Image
FIESTA	1994/...	DELANTERA	L 245mm	BE301415	
FOCUS	1999/08		R M10 x 1.5 mm		
COURIER	1994/...		B		
ESCORT	1994/...				
KA	1997/...				
MONDEO	1993/...				
ORION	1994/...				
MONDEO	1997/98	TRASERA	L 255mm	BE301417	
			R M10 x 1.5 mm		
			B		
FOCUS II	2008/...	TRASERA	L 76mm	BE302217	
			R M10 x 1.5 mm		
			B		
KA	2009/...	DELANTERA	L 288mm	BE310815	
			R M10 x 1.5 mm		
			B		
ESCORT	1998/...	DELANTERA	L 239mm	BE320015	
ORION	1994/...		R M10 x 1,5mm		
COURIER	.../2002		B		
FIESTA	.../2002				
KA	1996/08				
ECOSPORT	2012/...	DELANTERA	L 251mm	BE321615	
FIESTA GENERACION IV	2011/...		R M10 x 1.5 mm		
FIESTA KINETIC DESIGN	2011/...		B		
KA	2016/...				
FOCUS II	2008/...	DELANTERA	L 298mm	BE324715	
KUGA	2010/...		R M10 x 1.5 mm		
			B		
RANGER	2013/...	DELANTERA DERECHA	L 230mm	BE324815D	
			R M12 x 1,5mm		
			B		
RANGER	2013/...	DELANTERA IZQUIERDA	L 230mm	BE324815I	
			R M12 x 1,5mm		
			B		
TRANSIT	2014/...	DELANTERA	L 290mm	BE325115	
TURNEO CUSTOM 2.2 TCDI	2012/...		R M12 x 1,5mm		
			B		













**BIELETAS DE SUSPENSIÓN**

BIELETAS DE SUSPENSÃO / LINK STABILIZERS

FORD					
	Año Ano   Year	Descripción Sistema Descrição   Descrição	Medidas Medidas   Measures	Código Código   Code	Imagen Imagen   Image
TRANSIT CONNECT	2014/...	DELANTERA	L 295mm R M12 x 1,5mm B	BE330315	
TRANSIT	2000/...	TRASERA	L 347mm R M12 x 1,75mm B 12mm	BE330317	
FIESTA MAX ECOSPORT	2003/... 2003/...	DELANTERA	L 284mm R M10 x 1,5 mm B	BE340115	
MONDEO GENERACION IV GALAXY FOCUS S-MAX KUGA 4x4	2007/14 2006/15 2010/14 2006/... 2009/14	DELANTERA	L 300mm R M10 x 1,5 mm B	BE471515-1	
TRANSIT FURGON BUS 2.2 TDCI	2012/18 2012/18	DELANTERA	L 335mm R M12 x 1,5mm B	BE906915	
HONDA					
CR-V 2.0 CR-V 2.4	1997/02 2006/12	DELANTERA	L 318mm R M12 x 1,5mm B	BE223015	
CR-V	1995/02	TRASERA DERECHA	L 125mm R M10 x 1,5mm B	BE861417D	
CR-V	1995/02	TRASERA IZQUIERDA	L 125mm R M10 x 1,5mm B	BE861417I	
FIT	2003/09	DELANTERA IZQUIERDA	L 301mm R M10 x 1,5mm B	BE862315I	
FIT	2003/09	DELANTERA DERECHA	L 301mm R M10 x 1,5mm B	BE862315D	
FIT	2003/09	DELANTERA DERECHA	L 300mm R M10 x 1,5mm B	BE862315-1D	

**BIELETAS DE SUSPENSIÓN**













BIELETAS DE SUSPENSÃO / LINK STABILIZERS

HONDA					
	Año Ano   Year	Descripción Sistema Descrição   Descrição	Medidas Medidas   Measures	Código Código   Code	Imagen Imagem   Image
FIT	2003/09	DELANTERA DERECHA	L 300mm R M10 x 1,5mm B	BE862315-1I	
CR-Z NEW FIT CITY	2010/... 2009/... 2009/...	DELANTERA	L 325mm R M10 x 1,5mm B	BE862515	
NEW CIVIC	2006/12	DELANTERA	L 226mm R M10 x 1,5mm B	BE862715	
NEW CIVIC	2006/12	DELANTERA DERECHA	L 72mm R M10 x 1,5mm B	BE862715D	
NEW CIVIC	2006/12	DELANTERA IZQUIERDA	L 72mm R M10 x 1,5mm B	BE862715I	
NEW CIVIC	2006/12	TRASERA DERECHA	L 74mm R M10 x 1,5mm B	BE862717D	
NEW CIVIC	2006/12	TRASERA IZQUIERDA	L 74mm R M10 x 1,5mm B	BE862717I	
CR-V	2006/...	DELANTERA	L 318mm R M12 x 1,5mm B	BE862815	
HYUNDAI					
i30 VELOSTER	2007/... 2011/...	DELANTERA	L 244mm R M12 x 1,5mm B	BE990715	
i30 VELOSTER	2007/... 2011/...	TRASERA	L 170mm R M12 x 1,5mm B	BE990717	
TUCSON	2005/11	DELANTERA	L 237mm R M12 x 1,5mm B	BE991015	





**BIELETAS DE SUSPENSIÓN**

BIELETAS DE SUSPENSÃO / LINK STABILIZERS

HYUNDAI					
	Año Ano   Year	Descripción Sistema Descrição   Descrição	Medidas Medidas   Measures	Código Código   Code	Imagen Imagen   Image
TUCSON	2005/11	TRASERA	L 219mm R M12 x 1,5mm B	BE991017	
SANTA FE	2006/...	TRASERA	L 99mm R M12 x 1,5mm B	BE991117	
SANTA FE VERA CRUZ	2006/... 2009/11	DELANTERA IZQUIERDA	L 341mm R M12 x 1,5mm B	BE992315I	
SANTA FE VERA CRUZ	2006/... 2009/11	DELANTERA DERECHA	L 341mm R M12 x 1,5mm B	BE992315D	
TUCSON	2009/15	DELANTERA	L 266mm R M12 x 1,5mm B	BE992415	
TUCSON	2009/15	TRASERA	L 140mm R M12 x 1,5mm B	BE992417	
H-1	2007/...	DELANTERA IZQUIERDA	L 273mm R M12 x 1,5mm B	BE992715I	
H-1	2007/...	DELANTERA DERECHA	L 273mm R M12 x 1,5mm B	BE992715D	
KIA					
SPORTAGE	2010/15	DELANTERA	L 265mm R M12 x 1,5mm B	BE910115	
SPORTAGE	2010/15	TRASERA	L 140mm R M12 x 1,5mm B	BE910117	
CERATO	2009/...	DELANTERA	L 244mm R M12 x 1,5mm B	BE990715	













**BIELETAS DE SUSPENSIÓN**

BIELETAS DE SUSPENSÃO / LINK STABILIZERS

KIA					
	Año Ano   Year	Descripción Sistema Descrição   Descrição	Medidas Medidas   Measures	Código Código   Code	Imagen Imagem   Image
SPORTAGE	2005/...	DELANTERA	L 237mm R M12 x 1,5mm B	BE991015	
SANTA FE VERA CRUZ SPORTAGE	2006/... 2005/... 2005/...	TRASERA	L 219mm R M12 x 1,5mm B	BE991017	
SORENTO	2009/13	DELANTERA IZQUIERDA	L 341mm R M12 x 1,5mm B	BE992315I	
SORENTO	2009/13	DELANTERA DERECHA	L 341mm R M12 x 1,5mm B	BE992315D	
SPORTAGE	2010/15	DELANTERA	L 266mm R M12 x 1,5mm B	BE992415	
SPORTAGE	2010/15	TRASERA	L 140mm R M12 x 1,5mm B	BE992417	
LAND ROVER					
DISCOVERY	1994/02	DELANTERA	L 244mm R M12 x 1,5mm B	BE430015-3	
RANGE ROVER DISCOVERY II	1994/02	DELANTERA	L 97mm R M12 x 1,5mm B	BE430015-2	
MERCEDES BENZ					
SPRINTER (W901-W902-W903)	1995/96	DELANTERA DERECHA	L 115mm R B 12.5mm (2)	BE351215D	
SPRINTER (W901-W902-W903)	1995/96	DELANTERA IZQUIERDA	L 115mm R B 12.5mm (2)	BE351215I	
CLASE A160 CLASE A190	1999/06 1999/06	DELANTERA	L 219mm R M10 x 1,5mm B	BE370015	













**BIELETAS DE SUSPENSIÓN**

BIELETAS DE SUSPENSÃO / LINK STABILIZERS

MERCEDES BENZ					
	Año Ano   Year	Descripción Sistema Descrição   Descrição	Medidas Medidas   Measures	Código Código   Code	Imagen Imagem   Image
CLASE A160 CLASE A190	1999/06 1999/06	DELANTERA	L 244mm R M10 x 1,5mm B	BE370015-1	
CLASE C (W204)	2007/...	DELANTERA IZQUIERDA	L 306mm R M10 x 1,5mm B	BE370115I	
CLASE C (W204)	2007/...	DELANTERA DERECHA	L 306mm R M10 x 1,5mm B	BE370115D	
SPRINTER	2007/09	DELANTERA DERECHA	L 137mm R M12 x 1,5mm B	BE430015-1D	
SPRINTER	2007/09	DELANTERA IZQUIERDA	L 137mm R M12 x 1,5mm B	BE430015-1I	
SPRINTER	1995/06	DELANTERA DERECHA	L 130mm R M10 x 1,5mm B	BE430015D	
SPRINTER	1995/06	DELANTERA IZQUIERDA	L 130mm R M10 x 1,5mm B	BE430015I	
MINI					
MINI COOPER S	2000/...	DELANTERA	L 331mm R M10 x 1,5mm B	BE981315	
MITSUBISHI					
L200 TRITON 4x4	2008/14	DELANTERA IZQUIERDA	L 67mm R M12 x 1,5mm B	BE961215I	
L200 TRITON 4x4	2008/14	DELANTERA DERECHA	L 67mm R M12x 1,5mm B	BE961215D	
NISSAN					
FRONTIER D22B 4X2 X-TERRA 4X4	2003/09 2003/09	DELANTERA	L 230mm R M10 x 1,5mm B	BE330515	













**BIELETAS DE SUSPENSIÓN**

BIELETAS DE SUSPENSÃO / LINK STABILIZERS

NISSAN					
	Año Ano   Year	Descripción Sistema Descrição   Descrição	Medidas Medidas   Measures	Código Código   Code	Imagen Imagem   Image
TIIDA MARCH VERSA NOTE KICKS	2007/... 2011/... 2012/... 2015/... 2017/...	DELANTERA	L 255mm R M10 x 1,5mm B	BE581215	
PATHFINDER	1996/05	DELANTERA	L 190mm R M12 x 1,5mm B	BE901415	
SENTRA	2011/15	DELANTERA	L 294mm R M12 x 1,5mm B	BE903415	
FRONTIER D40T FRONTIER D23	2010/15 2015/...	DELANTERA DERECHA	L 65mm R M12 x 1,5mm B	BE904015D	
FRONTIER D40T FRONTIER D23	2010/15 2015/...	DELANTERA IZQUIERDA	L 65mm R M12 x 1,5mm B	BE904015I	
FRONTIER	2015/18	DELANTERA	L 335mm R M12 x 1,5mm B	BE906915	
FRONTIER	2011/...	DELANTERA	L 303mm R M12 x 1,5mm B	BE906915-1	
FRONTIER D23	2015/...	TRASERA	L 210mm R M12 x 1,5mm B	BE906917	
PEUGEOT					
BOXER FURGON	2006/10	DELANTERA	L 112 mm R B	BE252815	
BOXER III 1.4 k BOXER III 1.8 K	2006/... 2006/...	TRASERA	L 100mm R M10 x 1,5mm B	BE324817	
405	1991/...	DELANTERA	L 165mm R B 12mm (2)	BE450215	













**BIELETAS DE SUSPENSIÓN**

BIELETAS DE SUSPENSÃO / LINK STABILIZERS

PEUGEOT					
	Año Ano   Year	Descripción Sistema Descrição   Descrição	Medidas Medidas   Measures	Código Código   Code	Imagen Imagen   Image
106 406	1996/... 1997/...	DELANTERA	L 326mm R M12 x 1,75mm B	BE451515	
206 207	1998/... 2008/...	DELANTERA	L 335mm R M10 x 1,5mm B	BE452115	
407	2004/...	DELANTERA DERECHA	L 200mm R M12 x 1,75mm M16 x 1.5mm B	BE452215D	
407	2004/...	DELANTERA IZQUIERDA	L 200mm R M12 x 1,75mm M16 x 1.5mm B	BE452215I	
106	1991/94	DELANTERA	L 300mm R M10 x 1,5mm B	BE470415	
106	1996/...	DELANTERA	L 323mm R M10 x 1,5mm B	BE470515	
306 PARTNER	1993... 1996/...	DELANTERA	L 300mm R M10 x 1,5mm B	BE470615	
406	1997/03	TRASERA	L 160mm R M10 x 1,5mm B	BE471215-1	
407	2004/11	TRASERA	L 140mm R M10 x 1,5mm B	BE471217	
406	2000/04	DELANTERA	L 330mm R M12 x 1,5mm B	BE471515	
307 308 3008 5008	2000/... 2007/... 2009/... 2009/...	DELANTERA	L 335mm R M10 x 1,5mm B	BE471715	

**BIELETAS DE SUSPENSIÓN**













BIELETAS DE SUSPENSÃO / LINK STABILIZERS

PEUGEOT					
	Año Ano   Year	Descripción Sistema Descrição   Descrição	Medidas Medidas   Measures	Código Código   Code	Imagen Imagen   Image
406 607	1997/... 2000/...	DELANTERA	L 320mm R M12 x 1,75mm	BE471815	
EXPERT	2007/...	DELANTERA DERECHA	L 264mm R M12 x 1,5mm B	BE472015	
RENAULT					
R18	1980/93	DELANTERA	L 150mm R B 14/16mm	BE550600	
LAGUNA II TRAFIC	2002/... 2001/...	DELANTERA IZQUIERDA	L 279mm R M10 x 1,5mm B	BE560015	
TWINGO	1997/04	DELANTERA DERECHA	L 256mm R M10 x 1,5mm B	BE570015D	
TWINGO	1997/04	DELANTERA IZQUIERDA	L 256mm R M10 x 1,5mm B	BE570015I	
LAGUNA	1994/01	DELANTERA	L 367mm R M10 x 1,5mm B	BE570615	
MEGANE II SCENIC KANGOO	2005/... 2005/... 2005/...	DELANTERA	L 283mm R M10 x 1,5mm B	BE570915	
DUSTER 4x4	2010/...	TRASERA CORTA	L 400mm R B 16mm	BE570917-1	
DUSTER 4x4	2010/...	TRASERA DERECHA	L 425mm R B 16mm	BE570917-2D	
DUSTER 4x4	2010/...	TRASERA IZQUIERDA	L 425mm R B 16mm	BE570917-2I	













**BIELETAS DE SUSPENSIÓN**

BIELETAS DE SUSPENSÃO / LINK STABILIZERS

RENAULT					
	Año Ano   Year	Descripción Sistema Descrição   Descrição	Medidas Medidas   Measures	Código Código   Code	Imagen Imagen   Image
DUSTER	2011/...	DELANTERA	L 294mm	BE580015	
OROCH	2011/...		R M10 x 1,5mm		
CAPTUR	2016/...		B		
SANDERO	2007/...	DELANTERA	L 81mm	BE581315	
LOGAN	2007/...		R M8 x 1.25mm		
			B		
MASTER	1997/...	DELANTERA IZQUIERDA	L 133mm	BE581815I	
			R M10 x 1,25mm		
			B		
MEGANE II	2010/...	DELANTERA LARGA	L 292mm	BE581615	
MEGANE III	2010/...		R M10 x 1,5mm		
			B		
FLUENCE	2010/...	DELANTERA	L 264mm	BE581615-1	
MEGANE III	2010/...		R M10 x 1,5mm		
			B		
MASTER	1997/...	DELANTERA DERECHA	L 133mm	BE581815D	
			R M10 x 1,25mm		
			B		
MEGANE II	2010/...	DELANTERA	L 275mm	BE582215	
SCENIC	2009/...		R M10 x 1,5mm		
FLUENCE	2010/...		B		
GRAND SCENIC	2010/...				
KOLEOS	2008/...	DELANTERA DERECHA	L 300mm	BE582315D	
			R M12 x 1,25mm		
			B		
KOLEOS	2008/...	DELANTERA IZQUIERDA	L 300mm	BE582315I	
			R M12 x 1,25mm		
			B		
MASTER	2013/...	DELANTERA LARGA	L 330mm	BE582415	
			R M10 x 1,5mm		
			B		
ALASKAN	2020/...	DELANTERA DERECHA	L 65mm	BE904015D	
			R M12 x 1,5mm		
			B		

**BIELETAS DE SUSPENSIÓN**





BIELETAS DE SUSPENSÃO / LINK STABILIZERS

RENAULT					
	Año Ano   Year	Descripción Sistema Descrição   Descrição	Medidas Medidas   Measures	Código Código   Code	Imagen Imagem   Image
ALASKAN	2020/...	DELANTERA IZQUIERDA	L 65mm R M12 x 1,5mm B	BE904015I	
ALASKAN	2020/...	TRASERA	L 210mm R M12 x 1,5mm B	BE906917	
SEAT					
LEON TOLEDO	1999/... 1999/...	DELANTERA DERECHA	L 334mm R M12 x 1,5mm B	BE221715D	
LEON TOLEDO	1999/... 1999/...	DELANTERA IZQUIERDA	L 334mm R M12 x 1,5mm B	BE221715I	
ALHAMBRA	1995/12	DELANTERA	L 205mm R M12 x 1,5mm B	BE230015	
LEON TOLEDO		DELANTERA	L 3353mm R M12 x 1,5mm B	BE233215	
INCA LEON TERRA STD TOLEDO	1997/01 2001/11 1992/96 1991/09	DELANTERA	L 135mm R M12 x 1,5mm B	BE906915	
SUZUKI					
GRAND VITARA	2005/...	DELANTERA	L 300mm R M10 x 1,5mm B	BE917315	
SWIFT	2005/10	DELANTERA	L 300mm R M10 x 1,5mm B	BE916915	
TOYOTA					
HILUX PICK UP 4x2 SW4	2005/... 1996/02	DELANTERA	L 121mm R M12 x 1,25mm B	BE910615	

**BIELETAS DE SUSPENSIÓN**

BIELETAS DE SUSPENSÃO / LINK STABILIZERS

**TOYOTA**

	Año Ano   Year	Descripción Sistema Descrição   Descrição	Medidas Medidas   Measures	Código Código   Code	Imagen Imagem   Image
HILUX	2005/...	DELANTERA DERECHA	L 140mm R M12 x 1,25mm B	BE922415D	
HILUX	2005/...	DELANTERA IZQUIERDA	L 140mm R M12 x 1,25mm B	BE922415I	
COROLLA RAV 4	2008/... 2006/...	DELANTERA	L 360mm R M12 x 1,5mm B	BE922815	
COROLLA RAV 4	2002/... 2001/...	DELANTERA	L 285mm R M10 x 1,5mm B	BE923315	
AVENSIS COROLLA	2007/... 1997/01	DELANTERA	L 285mm R M12 x 1,5mm B	BE923315-1	
COROLLA CAMRY	1997/02 1992/01	DELANTERA	L 60mm R M10 x 1,5mm B	BE924015	
COROLLA	1992/97	TRASERA	L 104mm R M10 x 1,5mm B	BE924017	

**VOLKSWAGEN**

TRANSPORTER	1990/03	DELANTERA	L 110mm R B 14mm	BE221115	
TRANSPORTER	1990/03	DELANTERA	L 108mm R M12 x 1,5mm B 14mm	BE221515	
GOLF IV	1997/...	DELANTERA DERECHA	L 334mm R M12 x 1,5mm B	BE221715D	
GOLF IV	1997/...	DELANTERA IZQUIERDA	L 334mm R M12 x 1,5mm B	BE221715I	













**BIELETAS DE SUSPENSIÓN**

BIELETAS DE SUSPENSÃO / LINK STABILIZERS

VOLKSWAGEN					
	Año Ano   Year	Descripción Sistema Descrição   Descrição	Medidas Medidas   Measures	Código Código   Code	Imagen Imagen   Image
GOLF IV BORA NEW BEETLE	1997/... 1998/... 1998/...	DELANTERA	L 105mm R M10 x 1,5mm B 10mm	BE221715-1	
PASSAT VARIANT	2000/05 2000/05	DELANTERA IZQUIERDA	L 90mm R B 10mm	BE221815I	
PASSAT VARIANT	2000/05 2000/05	DELANTERA DERECHA	L 90mm R B 10mm	BE221815D	
GOL TREND VOYAGE SAVEIRO FOX, SURAN	2010/13 2010/13 2010/13 2004/10	DELANTERA	L 270mm R M10 x 1,5mm B	BE224015-1	
POLO	2001/05	DELANTERA DESPLAZADA	L 30mm R B 15mm	BE230215-1	
SHARAN	1999/...	DELANTERA	L 205mm R M12 x 1,5mm B	BE230015	
GOLF V PASSAT SCIROCCO TIGUAN VENTO	2003/08 2005/... 2012/... 2006/... 2006/...	DELANTERA	L 335mm R M12 x 1,5mm B	BE233215	
GOLF V PASSAT SCIROCCO TIGUAN VENTO	2003/08 2005/... 2012/... 2006/... 2006/...	TRASERA	L 95mm R M10 x 1,5mm B	BE233217	
CROSS UP GOLF V GOLF SCIROCCO TIGUAN VENTO VENTO	2016/18 2003/08 2002/11 2012/18, 20008/18 2000/... 2006/11	DELANTERA	L 335mm R M12 x 1,5mm B	BE906915	











**RÓTULAS DE SUSPENSIÓN**

PIVÔS DE SUSPENSÃO / BALL JOINT SUSPENSION

ALFA ROMEO					
	Año Ano   Year	Descripción Sistema Descrição   Descrição	Medidas Medidas   Measures	Código Código   Code	Imagen Imagen   Image
MITO	2009/21	RÓTULA DE SUSPENSIÓN DELANTERA INFERIOR	DC 16 (mm) DB RLM	R0271700	
AUDI					
A3	1997/01	RÓTULA DE SUSPENSIÓN	DC 15 (mm)	R0221700D	
A3	2000/05	DELANTERA INFERIOR DERECHA	DB RLM M12 x 1.5 (mm)		
A3	1997/01	RÓTULA DE SUSPENSIÓN	DC 15 (mm)	R0221700I	
A3	2000/05	DELANTERA INFERIOR IZQUIERDA	DB RLM M12 x 1.5 (mm)		
A1 SPORTBACK	2011/16	RÓTULA DE SUSPENSIÓN DELANTERA INFERIOR DERECHA	DC 15 (mm) DB RLM M12 x 1.5 (mm)	R0230100D	
A1 SPORTBACK	2011/16	RÓTULA DE SUSPENSIÓN DELANTERA INFERIOR IZQUIERDA	DC 15 (mm) DB RLM M12 x 1.5 (mm)	R0230100I	
A3	2006/08	RÓTULA DE SUSPENSIÓN	DC 15.5 (mm)	R0231400D	
A3 SPORTBACK	2005/08	DELANTERA INFERIOR	DB		
Q3	2012/15	DERECHA	RLM M12 x 1.5 (mm)		
A3	2006/08	RÓTULA DE SUSPENSIÓN	DC 15.5 (mm)	R0231400I	
A3 SPORTBACK	2005/08	DELANTERA INFERIOR	DB		
Q3	2012/15	IZQUIERDA	RLM M12 x 1.5 (mm)		
CHEVROLET					
C-10	1971/...	RÓTULA DE SUSPENSIÓN	DC 17.7 mm	R0200500	
C-30	1971/...	DELANTERA INFERIOR	DB RLM		
C-10	1988/93	RÓTULA DE SUSPENSIÓN DELANTERA INFERIOR	DC 18.5 (mm) DB 50 (mm) RLM	R0200600	
CORSA	1996/03	RÓTULA DE SUSPENSIÓN	DC 15 (mm)	R0240400	
CORSA CLASSIC	2002/10	DELANTERA INFERIOR	DB		
TIGRA	1998/01		RLM		
CELTA	2011/17	RÓTULA DE SUSPENSIÓN	DC 16 (mm)	R0240500	
CORSA CLASSIC	2009	DELANTERA INFERIOR	DB		
PRISMA	2011/13		RLM		

**RÓTULAS DE SUSPENSIÓN**

PIVÔS DE SUSPENSÃO / BALL JOINT SUSPENSION













CHEVROLET					
	Año Ano   Year	Descripción Sistema Descrição   Descrição	Medidas Medidas   Measures	Código Código   Code	Imagen Imagen   Image
LUV S-10	1992/99 2012/16	RÓTULA DE SUSPENSIÓN DELANTERA INFERIOR	DC 20.7 (mm) DB RLM	R0240700-1	
CORSA CORSA CORSA SEDAN CORSA PICK UP CORSA STATION	1994/96 1995/07 1995/07 1995/07 1995/07	RÓTULA DE SUSPENSIÓN DELANTERA INFERIOR	DC 15 (mm) DB RLM	R0240900	
CORSA II	2002/12	RÓTULA DE SUSPENSIÓN DELANTERA INFERIOR	DC 16 (mm) DB RLM	R0241800	
MERIVA	2004/10	RÓTULA DE SUSPENSIÓN DELANTERA INFERIOR	DC 16 (mm) DB RLM	R0242200	
AGILE	2009/21	RÓTULA DE SUSPENSIÓN DELANTERA INFERIOR	DC 15 (mm) DB RLM	R0244000	
LUV	1992/99	RÓTULA DE SUSPENSIÓN DELANTERA INFERIOR	DC 17.5 mm DB RLM	R0280494	
LUV	1992/99	RÓTULA DE SUSPENSIÓN DELANTERA SUPERIOR	DC 20.7 mm DB RLM	R0280495	
ASTRA ASTRA II VECTRA ZAFIRA	1998/03 2002/12 1998/06 2001/10	RÓTULA DE SUSPENSIÓN DELANTERA INFERIOR	DC 18mm DB RLM	R0290800	
AVEO	2008/15	RÓTULA DE SUSPENSIÓN DELANTERA INFERIOR	DC 15,3 (mm) DB RLM M12 x 1.25 (mm)	R0291000	
AVEO COBALT ONIX PRISMA II SONIC SPIN TRACKER 4X2	2008/15 2013/23 2013/23 2013/23 2012/16 2012/23 2013/17	RÓTULA DE SUSPENSIÓN DELANTERA INFERIOR	DC 18,1 (mm) DB RLM	R0291100	



**RÓTULAS DE SUSPENSIÓN**

PIVÔS DE SUSPENSÃO / BALL JOINT SUSPENSION

**CITROËN**

	<b>Año</b> Ano   Year	<b>Descripción Sistema</b> Descrição   Descrição	<b>Medidas</b> Medidas   Measures	<b>Código</b> Código   Code	<b>Imagen</b> Imagen   Image
JUMPER FURGON	1999/02	RÓTULA DE SUSPENSIÓN DELANTERA INFERIOR	DC 17 (mm) DB RLM M16 x 1.5 (mm)	R0270100	
JUMPER FURGON	1999/02	RÓTULA DE SUSPENSIÓN DELANTERA INFERIOR	DC 20 (mm) DB RLM M18 x 1.5 (mm)	R0270300	
AX SAXO	1991/98 2001/04	RÓTULA DE SUSPENSIÓN DELANTERA INFERIOR	DC 16 (mm) DB 37 (mm) RLM	R0451700	
JUMPER FURGON	2003/04	RÓTULA DE SUSPENSIÓN DELANTERA INFERIOR	DC 19 (mm) DB RLM	R0452000	
C3	2003/12	RÓTULA DE SUSPENSIÓN DELANTERA INFERIOR	DC 18 (mm) DB RLM	R0452100	
C4 LOUNGE C4 PICASSO DS5 DS4	2013/23 2009/15 2014/15 2012/15	RÓTULA DE SUSPENSIÓN DELANTERA INFERIOR	DC 15,7 (mm) DB M38 x 1.5 (mm) RLM M14 x 1.5 (mm)	R0452200	
C5 XANTIA	2002/07 1993/01	RÓTULA DE SUSPENSIÓN DELANTERA INFERIOR	DC 16 (mm) DB M39,7 x 1,5 (mm) RLM M14 x 1.5 (mm)	R0460300	
BERLINGO PARTNER XSARA XSARA PICASSO ZX	1998/23 1997/... 1998/23 1999/11 1993/99	RÓTULA DE SUSPENSIÓN DELANTERA INFERIOR	DC 18 (mm) DB RLM	R0461100	
JUMPER FURGON	2003/04	RÓTULA DE SUSPENSIÓN DELANTERA INFERIOR	DC 17 (mm) DB RLM	R0461300	
BERLINGO PARTNER XSARA ZX	1998/11 1996/... 1998/03 1993/98	RÓTULA DE SUSPENSIÓN DELANTERA INFERIOR	DC 16 (mm) DB RLM	R0470600	
C3 AICROSS C-ELYSEE DS3 C4 AICROSS 4X2 - 4X4	2017 2012 2009 /15 2017	RÓTULA DE SUSPENSIÓN DELANTERA INFERIOR	DC 18 (mm) DB RLM	R0471800	













**RÓTULAS DE SUSPENSIÓN**

PIVÔS DE SUSPENSÃO / BALL JOINT SUSPENSION

DACIA					
	Año Ano   Year	Descripción Sistema Descrição   Descrição	Medidas Medidas   Measures	Código Código   Code	Imagen Imagem   Image
TLX / PICKUP	1995/99	RÓTULA DE SUSPENSIÓN DELANTERA SUPERIOR	DC 16 (mm) DB RLM	R0550494	
TLX / PICKUP	1995/99	RÓTULA DE SUSPENSIÓN DELANTERA INFERIOR	DC 16 (mm) DB RLM	R0550495	
FIAT					
DUNA	1988/01	RÓTULA DE SUSPENSIÓN DELANTERA INFERIOR	DC 13 (mm)	R0260000	
DUNA WEEKEND	1988/00		DB		
FIORINO FURGON	2002/15		RLM		
FIORINO WORKING	1997/00				
FIORINO	1996/00				
UNO	1992/96				
UNO	2002/15				
PREMIO	1999/01				
PALIO WEEKEND	1997/01	RÓTULA DE SUSPENSIÓN DELANTERA INFERIOR	DC 13.2 (mm)	R0260900	
PALIO	1997/01		DB		
SIENA	1997/03		RLM		
STRADA	1999/02				
DUCATO	1992/01	RÓTULA DE SUSPENSIÓN DELANTERA INFERIOR	DC 17 (mm)	R0270100	
			DB		
			RLM M16 x 1.5 (mm)		
DUCATO	1992/01	RÓTULA DE SUSPENSIÓN DELANTERA INFERIOR	DC 20 (mm)	R0270300	
			DB		
			RLM M18 x 1.5 (mm)		
PALIO	1997/01	RÓTULA DE SUSPENSIÓN DELANTERA INFERIOR	DC 13.7 (mm)	R0270500	
PALIO WEEKEND	1997/01		DB		
SIENA	1997/03		RLM		
STRADA	1999/02				
FIORINO FURGON	2014/23	RÓTULA DE SUSPENSIÓN DELANTERA INFERIOR	DC 13.9 (mm)	R0270600	
GRAND SIENA	2012/23		DB		
MOBI	2016/23		RLM		
MOBI WAY	2017/23				
NUEVO UNO / WAY /SPORTING	2010/17				
PALIO	2001/10				
PALIO	2012/23				
PALIO ADVENTURE	2005/10				
PALIO BR	2012/15				
PALIO FASE II	2007/12				
PALIO FASE III	2010/17				
PALIO WEEKEND	2001/03				
PALIO WEEKEND	2005/11				



**RÓTULAS DE SUSPENSIÓN**

PIVÔS DE SUSPENSÃO / BALL JOINT SUSPENSION

FIAT					
	Año Ano   Year	Descripción Sistema Descrição   Descrição	Medidas Medidas   Measures	Código Código   Code	Imagen Imagen   Image
SIENA	2001/17	RÓTULA DE SUSPENSIÓN	DC 13.9 (mm)	R0270600	
STRADA ADVENTURE	2003/10	DELANTERA INFERIOR	DB		
STRADA WORKING	2002/23		RLM		
UNO WAY	2009/10				
LINEA	2009/18	RÓTULA DE SUSPENSIÓN	DC 16 (mm)	R0271700	
QUBO	2012/16	DELANTERA INFERIOR	DB		
PUNTO	2007/20		RLM		
DUCATO	1998/05	RÓTULA DE SUSPENSIÓN	DC 19 (mm)	R0452000	
		DELANTERA INFERIOR	DB		
			RLM		
DUCATO	1998/05	RÓTULA DE SUSPENSIÓN	DC 17 (mm)	R0461300	
		DELANTERA INFERIOR	DB		
			RLM		
FORD					
TAUNUS	1974/84	RÓTULA DE SUSPENSIÓN	DC 15 (mm)	R0300394	
		DELANTERA INFERIOR	DB		
			RLM M14 x 1.5 (mm)		
TRANSIT	1996/01	RÓTULA DE SUSPENSIÓN	DC 22.3 (mm)	R0302000	
		DELANTERA INFERIOR	DB		
			RLM		
F-100	1999/12	RÓTULA DE SUSPENSIÓN	DC 21 (mm)	R0310400	
F-150	1999/...	DELANTERA INFERIOR	DB		
			RLM		
COURIER VAN/PICK UP	1997/06	RÓTULA DE SUSPENSIÓN	DC 17,3 (mm)	R0310800	
FIESTA	1994/03	DELANTERA INFERIOR	DB		
KA	1997/08		RLM		
ECOSPORT	2003/13	RÓTULA DE SUSPENSIÓN	DC 16.4 (mm)	R0321600	
KA	2008/14	DELANTERA INFERIOR	DB		
FIESTA	2002/13		RLM		
FIESTA MAX	2002/13				
FOCUS	2000/03	RÓTULA DE SUSPENSIÓN	DC 17.3 (mm)	R0323100	
FOCUS	2005/10	DELANTERA INFERIOR	DB		
			RLM		
FOCUS	2008/14	RÓTULA DE SUSPENSIÓN	DC 15 (mm)	R0324700	
		DELANTERA INFERIOR	DB		
			RLM		











**RÓTULAS DE SUSPENSIÓN**

PIVÔS DE SUSPENSÃO / BALL JOINT SUSPENSION

<b>FORD</b>					
	<b>Año</b> Ano   Year	<b>Descripción Sistema</b> Descrição   Descripción	<b>Medidas</b> Medidas   Measures	<b>Código</b> Código   Code	<b>Imagen</b> Imagen   Image
F-100	1999/01	RÓTULA DE SUSPENSIÓN DELANTERA INFERIOR	DC 27 (mm)	<b>R0330000</b>	
F-4000 4X2/4X4	1999/11		DB 50 (mm)		
F-4000	1993/96		RLM		
F-100	1999/12	RÓTULA DE SUSPENSIÓN DELANTERA INFERIOR	DC 22.6 (mm)	<b>R0330600</b>	
			DB 50.2 (mm)		
			RLM		
ECOSPORT 2 4X2	2012/18	RÓTULA DE SUSPENSIÓN DELANTERA INFERIOR	DC 17.4 (mm)	<b>R0340200</b>	
ECOSPORT 2 4X4	2013/22		DB 39 (mm)		
FIESTA KINETIC	2010/22		RLM		
FOCUS II	2008/14	RÓTULA DE SUSPENSIÓN DELANTERA INFERIOR	DC 15 (mm)	<b>R0340400</b>	
			DB		
			RLM		
<b>HONDA</b>					
CIVIC SEDAN/COUPE	1996/01	RÓTULA DE SUSPENSIÓN DELANTERA INFERIOR	DC 16.4 (mm)	<b>R0860400</b>	
CR-V	1997/02		DB 40.1 (mm)		
			RLM		
FIT	2003/08	RÓTULA DE SUSPENSIÓN DELANTERA INFERIOR	DC 16 (mm)	<b>R0862300</b>	
			DB 35 (mm)		
			RLM		
<b>ISUZU</b>					
AMIGO	1992/02	RÓTULA DE SUSPENSIÓN DELANTERA INFERIOR	DC 20.7 (mm)	<b>R0240700-1</b>	
PICKUP	1993/99		DB		
TROOPER WAGON	1991/97		RLM		
PICK UP	1993/99	RÓTULA DE SUSPENSIÓN DELANTERA INFERIOR	DC 20.7 (mm)	<b>R0280494</b>	
TROOPER WAGON	1997/01		DB		
			RLM		
PICK UP	1993/99	RÓTULA DE SUSPENSIÓN DELANTERA SUPERIOR	DC 17.5 (mm)	<b>R0280495</b>	
TROOPER WAGON	1997/01		DB		
			RLM		
<b>IVECO</b>					
DAILY	1998/09	RÓTULA DE SUSPENSIÓN DELANTERA INFERIOR	DC 21 (mm)	<b>R0270800</b>	
DAILY I/II/III	1991/...		DB		
			RLM		











**RÓTULAS DE SUSPENSIÓN**

PIVÔS DE SUSPENSÃO / BALL JOINT SUSPENSION

KIA					
	Año Ano   Year	Descripción Sistema Descrição   Descrição	Medidas Medidas   Measures	Código Código   Code	Imagen Imagen   Image
BESTA	1996/00	RÓTULA DE SUSPENSIÓN DELANTERA INFERIOR	DC 19,7mm DB RLM	R0910094	
BESTA	1996/00	RÓTULA DE SUSPENSIÓN DELANTERA SUPERIOR	DC 17,8 (mm) DB RLM	R0910095	
MERCEDES BENZ					
SPRINTER	2000/...	RÓTULA DE SUSPENSIÓN DELANTERA INFERIOR	DC 23,6 (mm) DB 45,2 (mm) RLM M20 x 1,5 (mm)	R0351200	
SPRINTER II	2012/23	RÓTULA DE SUSPENSIÓN DELANTERA INFERIOR	DC 22 (mm) DB 45 (mm) RLM	R0352100	
PEUGEOT					
BOXER FURGON	1995/03	RÓTULA DE SUSPENSIÓN DELANTERA INFERIOR	DC 17 (mm) DB RLM M16 x 1,5 (mm)	R0270100	
BOXER FURGON BOXER COMBI	1995/03 1998/04	RÓTULA DE SUSPENSIÓN DELANTERA INFERIOR	DC 20 (mm) DB RLM M18 x 1,5 (mm)	R0270300	
504 504 PICK UP 505 505/GRAND TOUR	1983/00 1987/00 1983/96 1986/95	RÓTULA DE SUSPENSIÓN DELANTERA INFERIOR	DC 15mm DB M40 x 1,5 (mm) RLM M14 x 1,5 (mm)	R0450300	
106 106	1998/01 2000/04	RÓTULA DE SUSPENSIÓN DELANTERA INFERIOR	DC 16 (mm) DB 37 (mm) RLM	R0451700	
BOXER FURGON	1995/06	RÓTULA DE SUSPENSIÓN DELANTERA INFERIOR	DC 19 (mm) DB RLM	R0452000	
307 308 408 408 SPORT 3008 5008	2001/12 2009/15 2010/15 2011/17 2010/20 2012/21	RÓTULA DE SUSPENSIÓN DELANTERA INFERIOR	DC 15,7 (mm) DB M38 x 1,5 (mm) RLM M14 x 1,5 (mm)	R0452200	

**RÓTULAS DE SUSPENSIÓN**

PIVÔS DE SUSPENSÃO / BALL JOINT SUSPENSION

PEUGEOT					
	Año Ano   Year	Descripción Sistema Descrição   Descrição	Medidas Medidas   Measures	Código Código   Code	Imagen Imagen   Image
306 COUPE 306 CABRIO 306	1995/00 1997/02 1996/03	RÓTULA DE SUSPENSIÓN DELANTERA INFERIOR	DC 18 (mm) DB RLM	R0460100	
306 COUPE	1995/00	RÓTULA DE SUSPENSIÓN DELANTERA INFERIOR	DC 16 (mm) DB RLM	R0460100-1	
405/FAMILIAR 405	1991/97 1992/97	RÓTULA DE SUSPENSIÓN DELANTERA INFERIOR	DC 14,5 (mm) DB M37,7 x 1,5 (mm) RLM M12 x 1.25 (mm)	R0460200	
405 405 FAMILIAR 406 406 FAMILIAR	1991/03 1992/98 1996/04 1999/04	RÓTULA DE SUSPENSIÓN DELANTERA INFERIOR	DC 16 (mm) DB M39,7 x 1,5 (mm) RLM M14 x 1.5 (mm)	R0460300	
PARTNER	1998/03	RÓTULA DE SUSPENSIÓN DELANTERA INFERIOR	DC 18 (mm) DB RLM	R0461100	
BOXER FURGON	1995/06	RÓTULA DE SUSPENSIÓN DELANTERA INFERIOR	DC 17 (mm) DB RLM	R0461300	
PARTNER	1998/10	RÓTULA DE SUSPENSIÓN DELANTERA INFERIOR	DC 16 (mm) DB RLM	R0470600	
208 2008	2012/... 2012/...	RÓTULA DE SUSPENSIÓN DELANTERA INFERIOR	DC 18 (mm) DB RLM	R0471800	
RENAULT					
R12 SEDAN	1971/94 1996/...	RÓTULA DE SUSPENSIÓN DELANTERA INFERIOR	DC 16 (mm) DB RLM	R0550495	
R12 SEDAN	1971/94 1996/...	RÓTULA DE SUSPENSIÓN DELANTERA SUPERIOR	DC 16 (mm) DB RLM	R0550494	
4S R5 R6	1962/93 1973/85 1969/87	RÓTULA DE SUSPENSIÓN DELANTERA INFERIOR DERECHA	DC 12,5 (mm) DB RLM M12 x 1.5 (mm)	R0550594D	



**RÓTULAS DE SUSPENSIÓN**

PIVÔS DE SUSPENSÃO / BALL JOINT SUSPENSION

RENAULT					
	Año Ano   Year	Descripción Sistema Descrição   Descrição	Medidas Medidas   Measures	Código Código   Code	Imagen Imagen   Image
4S R5 R6	1962/93 1973/85 1969/87	RÓTULA DE SUSPENSIÓN DELANTERA INFERIOR IZQUIERDA	DC 12,5 (mm) DB RLM M12 x 1.5 (mm)	R0550594I	
4S R5 R6 RODEO	1970/84 1977/89 1970/84 1971/81	RÓTULA DE SUSPENSIÓN DELANTERA SUPERIOR	DC 11,4 (mm) DB RLM M10 x 1.25 (mm)	R0550595	
21 21 ALIZE 21 NEVADA	1990/97 1990/97 1990/97	RÓTULA DE SUSPENSIÓN DELANTERA INFERIOR	DC 18 (mm) DB RLM	R0550600-1	
R18 FUEGO	1983/99 1981/92	RÓTULA DE SUSPENSIÓN DELANTERA INFERIOR	DC 14,5 (mm) DB RLM M12 x 1.25 (mm)	R0550694	
R18 FUEGO	1983/99 1981/92	RÓTULA DE SUSPENSIÓN DELANTERA SUPERIOR	DC 14,5 (mm) DB RLM M12 x 1.25 (mm)	R0550695	
R9 R11	1987/03 1984/99	RÓTULA DE SUSPENSIÓN DELANTERA INFERIOR	DC 16 (mm) DB RLM	R0550900	
TRAFIC FURGON TRAFIC RODEO	1986/02 1986/99	RÓTULA DE SUSPENSIÓN DELANTERA INFERIOR	DC 17.6 (mm) DB RLM	R0560100	
LOGAN MEGANE II SANDERO SANDERO/STEPWAY SCENIC II	2007/14 2005/11 2009/15 2008/11 2001/11	RÓTULA DE SUSPENSIÓN DELANTERA INFERIOR	DC 18 (mm) DB 38,3 (mm) RLM	R0570900	
LOGAN MEGANE II SANDERO SANDERO/STEPWAY SCENIC II	2007/14 2005/11 2009/15 2008/11 2001/11	RÓTULA DE SUSPENSIÓN DELANTERA INFERIOR	DC 18 (mm) DB 38,6 (mm) RLM	R0570900-1	
CAPTUR DUSTER 4X2 (BR) DUSTER 4X4 (BR) DUSTER OROCH 4X2 DUSTER OROCH 4X4	2016/23 2011/22 2011/22 2016/23 2018/23	RÓTULA DE SUSPENSIÓN DELANTERA INFERIOR	DC 17 (mm) DB RLM	R0580000	













**RÓTULAS DE SUSPENSIÓN**

PIVÔS DE SUSPENSÃO / BALL JOINT SUSPENSION

RENAULT					
	Año Ano   Year	Descripción Sistema Descrição   Descrição	Medidas Medidas   Measures	Código Código   Code	Imagen Imagen   Image
EXPRESS KANGOO R19 CLIO I CLIO II TWINGO	1995/... 1997/00 1992/... 1995/98 1999/... 1995/...	RÓTULA DE SUSPENSIÓN DELANTERA INFERIOR	DC 16mm DB RLM	R0580100	
MASTER	2009/13	RÓTULA DE SUSPENSIÓN DELANTERA INFERIOR	DC 24 (mm) DB 43,4 (mm) RLM	R0581694	
MASTER MASTER FURGON CORTO	1999/09 1998/01	RÓTULA DE SUSPENSIÓN DELANTERA INFERIOR	DC 22 (mm) DB 43,5 (mm) RLM	R0581894	
MASTER MASTER FURGON CORTO	1999/09 1998/01	RÓTULA DE SUSPENSIÓN DELANTERA SUPERIOR	DC 16 (mm) DB 45,5 (mm) RLM M14 x 1.5 (mm)	R0581895	
MASTER	2010/22	RÓTULA DE SUSPENSIÓN DELANTERA INFERIOR	DC 14 (mm) DB 45 (mm) RLM	R0582400	
FLUENCE MEGANE III	2010/20 2011/20	RÓTULA DE SUSPENSIÓN DELANTERA INFERIOR	DC 17.2 (mm) DB RLM	R0582500	
SEAT					
TOLEDO	2000/05	RÓTULA DE SUSPENSIÓN DELANTERA INFERIOR DERECHA	DC 15 (mm) DB RLM M12 x 1.5 (mm)	R0221700D	
TOLEDO	2000/05	RÓTULA DE SUSPENSIÓN DELANTERA INFERIOR IZQUIERDA	DC 15 (mm) DB RLM M12 x 1.5 (mm)	R0221700I	
CORDOBA IBIZA	1994/00 1994/00	RÓTULA DE SUSPENSIÓN DELANTERA INFERIOR	DC 19mm DB RLM	R0230200	
LEON TOLEDO	2008/11 2008/09	RÓTULA DE SUSPENSIÓN DELANTERA INFERIOR DERECHA	DC 15,5mm DB RLM M12 x 1.5mm	R0231400D	

**RÓTULAS DE SUSPENSIÓN**

PIVÔS DE SUSPENSÃO / BALL JOINT SUSPENSION

SEAT					
	Año Ano   Year	Descripción Sistema Descrição   Descrição	Medidas Medidas   Measures	Código Código   Code	Imagen Imagen   Image
LEON TOLEDO	2008/11 2008/09	RÓTULA DE SUSPENSIÓN DELANTERA INFERIOR IZQUIERDA	DC 15,5mm DB RLM M12 x 1.5mm	R02314001	
SUZUKI					
FUN	2004/12	RÓTULA DE SUSPENSIÓN DELANTERA INFERIOR	DC 15 (mm) DB RLM	R0240400	
FUN	2003/07	RÓTULA DE SUSPENSIÓN DELANTERA INFERIOR	DC 16 (mm) DB RLM	R0240500	
TOYOTA					
HILUX	2005/16	RÓTULA DE SUSPENSIÓN DELANTERA INFERIOR	DC 16,7 (mm) DB 47,3 (mm) RLM	R0919694	
HILUX	2005/16	RÓTULA DE SUSPENSIÓN DELANTERA SUPERIOR	DC 15,2 (mm) DB 43,8 (mm) RLM	R0919695	
HILUX	1993/97	RÓTULA DE SUSPENSIÓN DELANTERA INFERIOR	DC 15 (mm) DB RLM	R0921900	
HILUX	1992/97	RÓTULA DE SUSPENSIÓN DELANTERA INFERIOR	DC 18 (mm) DB RLM	R0922394	
HILUX	1993/01	RÓTULA DE SUSPENSIÓN DELANTERA INFERIOR	DC 18,1 (mm) DB RLM	R0922494	
HILUX	1993/01	RÓTULA DE SUSPENSIÓN DELANTERA SUPERIOR	DC 16,95 (mm) DB RLM	R0922495	
COROLLA RAV	1998/02 2001/06	RÓTULA DE SUSPENSIÓN DELANTERA INFERIOR	DC 15 (mm) DB RLM	R0922800	
ETIOS ETIOS CROSS	2013/22 2014/22	RÓTULA DE SUSPENSIÓN DELANTERA INFERIOR	DC 13,4 (mm) DB 37 (mm) RLM	R0926600	











**RÓTULAS DE SUSPENSIÓN**

PIVÔS DE SUSPENSÃO / BALL JOINT SUSPENSION

VOLKSWAGEN					
	Año Ano   Year	Descripción Sistema Descrição   Descrição	Medidas Medidas   Measures	Código Código   Code	Imagen Imagen   Image
SENDA GOL SAVEIRO	1990/97 1993/95 1993/95	RÓTULA DE SUSPENSIÓN DELANTERA INFERIOR DERECHA	DC 15mm DB RLM	R0220600D	
SENDA GOL SAVEIRO	1990/97 1993/95 1993/95	RÓTULA DE SUSPENSIÓN DELANTERA INFERIOR IZQUIERDA	DC 15mm DB RLM	R0220600I	
GOL GOL COUNTRY SAVEIRO	1995/99 1996/99 1996/01	RÓTULA DE SUSPENSIÓN DELANTERA INFERIOR DERECHA HIDRÁULICA	DC 15 (mm) DB RLM	R0220601D	
GOL GOL COUNTRY SAVEIRO	1995/99 1996/99 1996/01	RÓTULA DE SUSPENSIÓN DELANTERA INFERIOR IZQUIERDA HIDRÁULICA	DC 15 (mm) DB RLM	R0220601I	
GOL GOL GOL COUNTRY SAVEIRO	1997/11 2011/23 1998/11 1998/01	RÓTULA DE SUSPENSIÓN DELANTERA INFERIOR MECÁNICA	DC 17 (mm) DB RLM	R0220602	
GOL GOL GOL COUNTRY GOL COUNTRY SAVEIRO	1997/09 2011/23 1998/09 2011/23 1998/01	RÓTULA DE SUSPENSIÓN DELANTERA INFERIOR DERECHA HIDRÁULICA	DC 17 (mm) DB RLM	R0220602D	
GOL GOL GOL COUNTRY GOL COUNTRY SAVEIRO	1997/09 2011/23 1998/09 2011/23 1998/01	RÓTULA DE SUSPENSIÓN DELANTERA INFERIOR IZQUIERDA HIDRÁULICA	DC 17 (mm) DB RLM	R0220602I	
TRANSPORTER FURGON	1996/04	RÓTULA DE SUSPENSIÓN DELANTERA INFERIOR	DC 20 (mm) DB RLM	R0221400	
EUROVAN TRANSPORTER	1990/03 1990/03	RÓTULA DE SUSPENSIÓN DELANTERA INFERIOR	DC 24,4 (mm) DB RLM	R0221400-1	
BORA GOLF GOLF GOLF CABRIO NEW BEETLE NEW BEETLE CABRIO	2000/16 2000/16 1996/02 1996/99 1999/10 2003/10	RÓTULA DE SUSPENSIÓN DELANTERA INFERIOR DERECHA	DC 15 (mm) DB RLM M12 x 1.5 (mm)	R0221700D	





## RÓTULAS DE SUSPENSIÓN

PIVÔS DE SUSPENSÃO / BALL JOINT SUSPENSION

VOLKSWAGEN					
	Año Ano   Year	Descripción Sistema Descrição   Descrição	Medidas Medidas   Measures	Código Código   Code	Imagen Imagen   Image
BORA	2000/16	RÓTULA DE SUSPENSIÓN	DC 15 (mm)	R0221700I	
GOLF	2000/16	DELANTERA INFERIOR	DB		
GOLF	1996/02	IZQUIERDA	RLM M12 x 1.5 (mm)		
GOLF CABRIO	1996/99				
NEW BEETLE	1999/10				
NEW BEETLE CABRIO	2003/10				
SHARAN	2001/11	RÓTULA DE SUSPENSIÓN	DC 15 (mm)	R0222900	
			DB		
			RLM		
FOX	2004/08	RÓTULA DE SUSPENSIÓN	DC 15 (mm)	R0224000D	
SURAN	2004/08	DELANTERA INFERIOR	DB		
		DERECHA	RLM M12 x 1.5 (mm)		
FOX	2004/08	RÓTULA DE SUSPENSIÓN	DC 15 (mm)	R0224000I	
SURAN	2004/08	DELANTERA INFERIOR	DB		
		IZQUIERDA	RLM M12 x 1.5 (mm)		
CROSSFOX	2005/16	RÓTULA DE SUSPENSIÓN	DC 15 (mm)	R0224001D	
		DELANTERA INFERIOR	DB		
		DERECHA	RLM M12 x 1.5(mm)		
CROSSFOX	2005/16	RÓTULA DE SUSPENSIÓN	DC 15 (mm)	R0224001I	
		DELANTERA INFERIOR	DB		
		IZQUIERDA	RLM M12 x 1.5 (mm)		
CARAT	1987/92	RÓTULA DE SUSPENSIÓN	DC 15 (mm)	R0230094	
QUANTUM	1986/96	DELANTERA INFERIOR	DB		
SANTANA	2002/07		RLM		
FOX	2008/22	RÓTULA DE SUSPENSIÓN	DC 15 (mm)	R0230100D	
GOL TREND	2008/23	DELANTERA INFERIOR	DB		
GOL TREND IMOTION	2019/21	DERECHA	RLM M12 x 1.5 (mm)		
SAVEIRO	2003/10				
SURAN	2006/22				
SURANCROSS	2011/23				
UP!	2014/23				
VOYAGE	2008/19				
FOX	2008/22	RÓTULA DE SUSPENSIÓN	DC 15 (mm)	R0230100I	
GOL TREND	2008/23	DELANTERA INFERIOR	DB		
GOL TREND IMOTION	2019/21	IZQUIERDA	RLM M12 x 1.5 (mm)		
SAVEIRO	2003/10				
SURAN	2006/22				
SURANCROSS	2011/23				
UP!	2014/23				
VOYAGE	2008/19				

**RÓTULAS DE SUSPENSIÓN**

PIVÔS DE SUSPENSÃO / BALL JOINT SUSPENSION

VOLKSWAGEN					
	Año Ano   Year	Descripción Sistema Descrição   Descrição	Medidas Medidas   Measures	Código Código   Code	Imagen Imagem   Image
CADDY	1995/99	RÓTULA DE SUSPENSIÓN	DC 19 (mm)	R0230200	
GOLF	1995/99	DELANTERA INFERIOR	DB		
GOLF CABRIO	1990/95		RLM		
PASSAT	1995/98				
POLO CLASSIC	1996/09				
GOLF	2003/04	RÓTULA DE SUSPENSIÓN	DC 15,5 (mm)	R0231400D	
GOLF VARIANT	1999/12	DELANTERA INFERIOR	DB		
GOLF VI	2011/14	DERECHA	RLM M12 x 1.5 (mm)		
GOLF VII	2015/23				
POLO	2018/23				
SAVEIRO CROSS	2015/23				
TIGUAN	2008/17				
VENTO	2006/11				
VENTO III	2019/22				
VENTO VARIANT	2006/11				
VIRTUS	2018/23				
GOLF	2003/04	RÓTULA DE SUSPENSIÓN	DC 15,5 (mm)	R0231400I	
GOLF VARIANT	1999/12	DELANTERA INFERIOR	DB		
GOLF VI	2011/14	IZQUIERDA	RLM M12 x 1.5 (mm)		
GOLF VII	2015/23				
POLO	2018/23				
SAVEIRO CROSS	2015/23				
TIGUAN	2008/17				
VENTO	2006/11				
VENTO III	2019/22				
VENTO VARIANT	2006/11				
VIRTUS	2018/23				
PASSAT	2006/11	RÓTULA DE SUSPENSIÓN	DC 15,4 (mm)	R0232700D	
CC	2006/16	DELANTERA INFERIOR	DB		
TIGUAN	2017/20	DERECHA	RLM		















**PARRILLAS Y BRAZOS DE SUSPENSIÓN**

BANDEJAS E BRAÇOS DE SUSPENSÃO /













CHEVROLET					
	Año Ano   Year	Descripción Sistema Descrição   Descrição	Medidas Medidas   Measures	Código Código   Code	Imagen Imagen   Image
ASTRA VECTRA ZAFIRA	1998/03 1998/03 2000/..	DELANTERA DERECHA CON RÓTULA	R 18mm RR B 12mm (2)	PS290800D	
ASTRA VECTRA ZAFIRA	1998/03 1998/03 2000/..	DELANTERA IZQUIERDA CON RÓTULA	R 18mm RR B 12mm (2)	PS290800I	
AVEO	2008/...	DELANTERA DERECHA CON RÓTULA	R 15mm RR M12 x 1.25mm B 12mm (2)	PS291000D	
AVEO	2008/...	DELANTERA IZQUIERDA CON RÓTULA	R 15mm RR M12 x 1.25mm B 12mm (2)	PS291000I	
CORSA	1998/10	DELANTERA DERECHA CON RÓTULA	R 15mm RR B 10mm	BS240400D	
CORSA	1998/10	DELANTERA IZQUIERDA CON RÓTULA	R 15mm RR B 10mm	BS240400I	
CORSA	2001/...	DELANTERA DERECHA CON RÓTULA	R 16mm RR B 12mm	PS240400D	
CORSA	2001/...	DELANTERA IZQUIERDA CON RÓTULA	R 16mm RR B 12mm	PS240400I	
VECTRA	2002/...	DELANTERA DERECHA CON RÓTULA	R 20mm RR B 12mm	PS290801D	
VECTRA	2002/...	DELANTERA IZQUIERDA CON RÓTULA	R 20mm RR B 12mm	PS290801I	
CITROËN					
C4	2000/...	DELANTERA DERECHA SIN RÓTULA	R RR B 14mm (2)	BS452200D	

**PARRILLAS Y BRAZOS DE SUSPENSIÓN**













BANDEJAS E BRAÇOS SUSPENSÃO / TRAYS AND ARMS

CITROËN					
	Año Ano   Year	Descripción Sistema Descrição   Descrição	Medidas Medidas   Measures	Código Código   Code	Imagen Imagem   Image
C4	2000/...	DELANTERA IZQUIERDA SIN RÓTULA	R RR B 14mm (2)	BS452200I	
BERLINGO XSARA XSARA PICASSO	2003/... 2000/05 2005/12	DELANTERA DERECHA	R RR B 12 mm (2)	PS460100D	
BERLINGO XSARA XSARA PICASSO	2003/... 2000/05 2005/12	DELANTERA IZQUIERDA	R RR B 12 mm (2)	PS460100I	
FIAT					
128	1971/84	DELANTERA CON RÓTULA	R 13mm RR M12 x 1.25mm B 8mm	BS250500	
128 EUROPA	1982/83	DELANTERA CON RÓTULA	R 13mm RR M12 x 1.25mm B 10mm	BS250600	
147 VIVACE	1993/...	DELANTERA CON RÓTULA	R 13mm RR M12 x 1.25mm B 10mm	BS260200	
DUNA UNO FIORINO	1988/... 1988/... 1988/...	DELANTERA CON RÓTULA	R 13mm RR M12 x 1.25mm B 10mm	BS260300	
PALIO WEEDKEND	1996/...	DELANTERA DERECHA CON RÓTULA	R 13mm RR M12 x 1.25mm B 12mm	PS270500-1D	
PALIO WEEDKEND	1996/...	DELANTERA IZQUIERDA CON RÓTULA	R 13mm RR M12 x 1.25mm B 12mm	PS270500-1I	
PALIO SIENA	1996/... 1996/...	DELANTERA DERECHA CON RÓTULA	R 13mm RR M12 x 1.25mm B 12mm	PS270500D	
PALIO SIENA	1996/... 1996/...	DELANTERA IZQUIERDA CON RÓTULA	R 13mm RR M12 x 1.25mm B 12mm	PS270500I	













**PARRILLAS Y BRAZOS DE SUSPENSIÓN**  
 BANDEJAS E BRAÇOS SUSPENSÃO / TRAYS AND ARMS

FORD					
	Año Ano   Year	Descripción Sistema Descrição   Descrição	Medidas Medidas   Measures	Código Código   Code	Imagen Imagen   Image
ESCORT	1988/93	DELANTERA DERECHA CON RÓTULA	R 17mm RR B 16.3mm	BS300700D	
ESCORT	1988/93	DELANTERA IZQUIERDA CON RÓTULA	R 17mm RR B 16.3mm	BS300700I	
ESCORT ORION	1995/... 1995/...	DELANTERA DERECHA CON RÓTULA	R 17mm RR B 12mm (2)	PS320300D	
ESCORT ORION	1995/... 1995/...	DELANTERA IZQUIERDA CON RÓTULA	R 17mm RR B 12mm (2)	PS320300I	
FIESTA	1996/02	DELANTERA DERECHA CON RÓTULA DIRECCIÓN HIDRÁULICA	R 16.5mm RR B 12mm (2)	PS310800D	
FIESTA	1996/02	DELANTERA IZQUIERDA CON RÓTULA DIRECCIÓN HIDRÁULICA	R 16.5mm RR B 12mm (2)	PS310800I	
FOCUS	1998/03	DELANTERA DERECHA CON RÓTULA	R 16.6mm RR B 13mm	PS303300D	
FOCUS	1998/03	DELANTERA IZQUIERDA CON RÓTULA	R 16.6mm RR B 13mm	PS303300I	
MONDEO	1996/00	DELANTERA DERECHA CON RÓTULA	R 18mm RR B 12mm	PS320500D	
MONDEO	1996/00	DELANTERA IZQUIERDA CON RÓTULA	R 18mm RR B 12mm	PS320500I	
RANGER	1998/...	DELANTERA SUPERIOR DERECHA CON RÓTULA	R 19.5mm RR B 14mm (2)	PS430895D	













**PARRILLAS Y BRAZOS DE SUSPENSIÓN**  
 BANDEJAS E BRAÇOS SUSPENSÃO / TRAYS AND ARMS

FORD					
	Año Ano   Year	Descripción Sistema Descrição   Descrição	Medidas Medidas   Measures	Código Código   Code	Imagen Imagen   Image
RANGER	1998/...	DELANTERA IZQUIERDA CON RÓTULA	R 19.5mm RR B 14mm (2)	PS430895I	
PEUGEOT					
205	1991/...	DELANTERA DERECHA CON RÓTULA	R 16mm RR B 10.5mm	BS460500D	
205	1991/...	DELANTERA IZQUIERDA CON RÓTULA	R 16mm RR B 10.5mm	BS460500I	
206 207	1998/... 2008/...	PARRILLA DELANTERA DERECHA CON RÓTULA	R 18mm RR B 14mm (2)	BS452100D	
206 207	1998/... 2008/...	PARRILLA DELANTERA IZQUIERDA CON RÓTULA	R 18mm RR B 14mm (2)	BS452100I	
PARTNER	1998/...	DELANTERA DERECHA	R RR B 12 mm (2)	PS460100D	
PARTNER	1998/...	DELANTERA IZQUIERDA	R RR B 12 mm (2)	PS460100I	
306	.../1999	DELANTERA DERECHA CON RÓTULA	R 16mm RR B 12mm	PS460100-1D	
306	.../1999	DELANTERA IZQUIERDA CON RÓTULA	R 16mm RR B 12mm	PS460100-1I	
306 PARTNER	1993/... 1996/...	DELANTERA DERECHA SIN RÓTULA	R RR B 12mm (2) Rosca Buje H8 x 1.25 mm.	PS461100D	
306 PARTNER	1993/... 1996/...	DELANTERA IZQUIERDA SIN RÓTULA	R RR B 12mm (2) Rosca Buje H8 x 1.25 mm.	PS461100I	

**PARRILLAS Y BRAZOS DE SUSPENSIÓN**  
 BANDEJAS E BRAÇOS SUSPENSÃO / TRAYS AND ARMS







PEUGEOT					
	Año Ano   Year	Descripción Sistema Descrição   Descrição	Medidas Medidas   Measures	Código Código   Code	Imagen Imagen   Image
307	2000/...	DELANTERA DERECHA SIN RÓTULA	R RR B 14mm (2)	BS452200D	
307	2000/...	DELANTERA IZQUIERDA SIN RÓTULA	R RR B 14mm (2)	BS452200I	
406	1997/...	DELANTERA DERECHA SIN RÓTULA	R RR B 14mm	BS460394D	
406	1997/...	DELANTERA IZQUIERDA SIN RÓTULA	R RR B 14mm	BS460394I	
BOXER	2002/...	DELANTERA DERECHA SIN RÓTULA	R RR B 18.3mm	BS270300D	
BOXER	2002/...	DELANTERA IZQUIERDA SIN RÓTULA	R RR B 18.3mm	BS270300I	
RENAULT					
R9 R11	1984/... 1984/...	DELANTERA DERECHA SIN RÓTULA	R RR B 12mm	PS550900D	
R9 R11	1984/... 1984/...	DELANTERA IZQUIERDA SIN RÓTULA	R RR B 12mm	PS550900I	
R12	1971/95	DELANTERA INFERIOR SIN RÓTULA	R RR B 14mm (2)	PS550400	
R12	1971/95	TRASERA SIN RÓTULA	R RR B 14mm (2)	PS550401	
CLIO II KANGOO R19 MEGANE	TODOS 1998/... 1988/95 1996/03	DELANTERA DERECHA CON RÓTULA PARA BUJE DE BARRA	R 16mm RR B 12mm (2)	PS560400D	

**PARRILLAS Y BRAZOS DE SUSPENSIÓN**  
 BANDEJAS E BRAÇOS SUSPENSÃO / TRAYS AND ARMS

RENAULT					
	Año Ano   Year	Descripción Sistema Descrição   Descripción	Medidas Medidas   Measures	Código Código   Code	Imagen Imagen   Image
CLIO II KANGOO R19 MEGANE	TODOS 1998/... 1988/95 1996/03	DELANTERA IZQUIERDA CON RÓTULA PARA BUJE DE BARRA	R 16mm RR B 12mm (2)	PS560400I	
CLIO	1990/98	DELANTERA DERECHA CON RÓTULA PARA BIELETA	R 16mm RR B 12mm (2)	PS560500D	
CLIO	1990/98	DELANTERA IZQUIERDA CON RÓTULA PARA BIELETA	R 16mm RR B 12mm (2)	PS560500I	
CLIO KANGOO	1998/... 1998/...	DELANTERA DERECHA CON RÓTULA PARA BIELETA	R 16mm RR B 12/16mm (2) Estriado	PS580100D	
CLIO KANGOO	1998/... 1998/...	DELANTERA IZQUIERDA CON RÓTULA PARA BIELETA	R 16mm RR B 12/16mm (2) Estriado	PS580100I	
EXPRESS	1995/...	DELANTERA DERECHA CON RÓTULA	R 16mm RR B 12mm (2)	PS560600D	
EXPRESS	1995/...	DELANTERA IZQUIERDA CON RÓTULA	R 16mm RR B 12mm (2)	PS560600I	
MEGANE II	2005/...	DELANTERA DERECHA CON RÓTULA	R 16mm RR B 12mm (2)	PS580000D	
MEGANE II	2005/...	DELANTERA IZQUIERDA CON RÓTULA	R 16mm RR B 12mm (2)	PS580000I	
MEGANE II	2005/...	DELANTERA DERECHA RÓTULA Ø18 CON RÓTULA	R 18mm RR B 12mm	PS580000-1D	
MEGANE II	2005/...	DELANTERA IZQUIERDA RÓTULA Ø18 CON RÓTULA	R 18mm RR B 12mm	PS580000-1I	

**PARRILLAS Y BRAZOS DE SUSPENSIÓN**

BANDEJAS E BRAÇOS SUSPENSÃO / TRAYS AND ARMS

VOLKSWAGEN					
	Año Ano   Year	Descripción Sistema Descrição   Descrição	Medidas Medidas   Measures	Código Código   Code	Imagen Imagem   Image
GOL	.../1994	DELANTERA DERECHA SIN RÓTULA	R RR B 10mm (2) Orificio de rótula 12 mm.	PS230000	
GOL	1995/...	DELANTERA DERECHA SIN RÓTULA	R RR B 10mm (2)	PS230000-1	
GOLF VENTO PASSAT SCIROCOO	2003/... 2006/... 2005/... 2012/...	TRASERA DERECHA	R RR B 12mm/14mm	BS231400D	
GOLF VENTO PASSAT SCIROCOO	2003/... 2006/... 2005/... 2012/...	TRASERA IZQUIERDA	R RR B 12mm/14mm	BS231400I	
VENTO GOLF V	2006/... 2003/...	DELANTERA DERECHA SIN RÓTULA	R RR B 12mm	PS231400D	
VENTO GOLF V	2006/... 2003/...	DELANTERA IZQUIERDA SIN RÓTULA	R RR B 12mm	PS231400I	



**CAZOLETAS**







STRUT MOUNTING / COXINS

AUDI					
	Año Ano   Year	Descripción Sistema Descrição   Descrição	Información Adicional Informação   Information	Código Código   Code	Imagen Imagem   Image
A3	1997/01	CAZOLETA DELANTERA	MATERIAL CAZOLETA: METAL MATERIAL BUJE: GOMA NO INCLUYE TORNILLOS	<b>CZ233115</b>	
A3	1997/01	CAZOLETA DELANTERA	MATERIAL CAZOLETA: METAL MATERIAL BUJE: GOMA NO INCLUYE TORNILLOS <b>INCLUYE CRAPODINA</b>	<b>CZ233115C</b>	
A3	2013/15	CAZOLETA DELANTERA	MATERIAL CAZOLETA: METAL MATERIAL BUJE: GOMA NO INCLUYE TORNILLOS	<b>CZ233215</b>	
A3 CABRIO	2015/16				
A3 SPORTBACK	2015/18				
CHERY					
TIGGO 4X2	2008/12	CAZOLETA DELANTERA	MATERIAL CAZOLETA: METAL MATERIAL BUJE: GOMA NO INCLUYE TORNILLOS	<b>CZ993215</b>	
TIGGO 4X4	2010/12				
CHEVROLET					
CORSA	1996/02	CAZOLETA DELANTERA	MATERIAL CAZOLETA: METAL MATERIAL BUJE: GOMA NO INCLUYE TORNILLOS	<b>CZ240415</b>	
CORSA CLASSIC	2002/10				
CORSA	1996/02	APOYA ESPIRAL DELANTERA	MATERIAL CAZOLETA: METAL MATERIAL BUJE: GOMA NO INCLUYE TORNILLOS	<b>CZ240415-1</b>	
CORSA CLASSIC	2002/10				
ASTRA	1998/03	CAZOLETA DELANTERA	MATERIAL CAZOLETA: METAL MATERIAL BUJE: GOMA NO INCLUYE TORNILLOS	<b>CZ244015</b>	
ASTRA	2002/12				
MERIVA	2004/13				
VECTRA SEDAN/GT	2006/12				
ZAFIRA	2001/10				
COBALT	2013/17	CAZOLETA DELANTERA	MATERIAL CAZOLETA: METAL MATERIAL BUJE: GOMA NO INCLUYE TORNILLOS	<b>CZ244115</b>	
S-10	2012/16				
ONIX	2013/16				
PRISMA II	2013/16				
COBALT	2013/23	CAZOLETA DELANTERA DERECHA	MATERIAL CAZOLETA: METAL MATERIAL BUJE: GOMA NO INCLUYE TORNILLOS	<b>CZ244517D</b>	
ONIX	2013/23				
ONIX JOY	2017/23				
ONIX ACTIV	2016/22				
JOY	2019/23				
PRISMA II	2013/23				
SONIC	2012/16				
SPIN	2013/23				



**CAZOLETAS**

STRUT MOUNTING / COXINS

**CHEVROLET**

	Año Ano   Year	Descripción Sistema Descrição   Descrição	Información Adicional Informação   Information	Código Código   Code	Imagen Imagem   Image
COBALT	2013/23	CAZOLETA DELANTERA IZQUIERDA	MATERIAL CAZOLETA: METAL MATERIAL BUJE: GOMA NO INCLUYE TORNILLOS	<b>CZ244517I</b>	
ONIX	2013/23				
ONIX JOY	2017/23				
ONIX ACTIV	2016/22				
JOY	2019/23				
PRISMA II	2013/23				
SONIC	2012/16				
SPIN	2013/23				
AVEO	2008/15	CAZOLETA DELANTERA	MATERIAL CAZOLETA: METAL MATERIAL BUJE: GOMA NO INCLUYE TORNILLOS	<b>CZ290115</b>	
AVEO	2008/15	CAZOLETA DELANTERA	MATERIAL CAZOLETA: METAL MATERIAL BUJE: GOMA NO INCLUYE TORNILLOS	<b>CZ290115-1</b>	
AVEO	2008/15	CAZOLETA TRASERA	MATERIAL CAZOLETA: METAL MATERIAL BUJE: GOMA NO INCLUYE TORNILLOS	<b>CZ290117</b>	
CRUZE	2010/17	CAZOLETA DELANTERA	MATERIAL CAZOLETA: METAL MATERIAL BUJE: GOMA NO INCLUYE TORNILLOS	<b>CZ291415C</b>	
TRACKER 4X2	2013/17				
TRACKER 4X4	2015/17				

**CITROEN**

C3 AIRCROSS	2008/16	CAZOLETA DELANTERA	MATERIAL CAZOLETA: METAL MATERIAL BUJE: GOMA NO INCLUYE TORNILLOS	<b>CZ452115</b>	
C3 PICASSO	2011/16				
C-ELYSEE	2016/17				
BERLINGO FURGON	1998 /10	CAZOLETA DELANTERA	MATERIAL CAZOLETA: METAL MATERIAL BUJE: GOMA NO INCLUYE TORNILLOS	<b>CZ470615</b>	
BERLINGO FURGON	2003/11				
BERLINGO MULTISPACE	1998/10				
C4	2007/14	CAZOLETA DELANTERA	MATERIAL CAZOLETA: METAL MATERIAL BUJE: GOMA NO INCLUYE TORNILLOS	<b>CZ471215</b>	
C4 LOUNGE	2013/17				
C4	2007/14	CAZOLETA TRASERA	MATERIAL CAZOLETA: METAL MATERIAL BUJE: GOMA NO INCLUYE TORNILLOS	<b>CZ471217</b>	
C3	2003/12	CAZOLETA DELANTERA	MATERIAL CAZOLETA: METAL MATERIAL BUJE: GOMA NO INCLUYE TORNILLOS	<b>CZ472215</b>	
C3 AIRCROSS	2008/13				
C3 PICASSO	2011/13				

**CAZOLETAS**

STRUT MOUNTING / COXINS

FIAT					
	Año Ano   Year	Descripción Sistema Descrição   Descrição	Información Adicional Informação   Information	Código Código   Code	Imagen Imagem   Image
IDEA	2005/18	CAZOLETA DELANTERA DERECHA	MATERIAL CAZOLETA: METAL MATERIAL BUJE: GOMA NO INCLUYE TORNILLOS	<b>CZ270515D</b>	
IDEA ADVENTURE	2010/11				
PALIO	1999/09				
PALIO WEEKEND	1997/11				
SIENA	1997/11				
STRADA	1999/02				
STRADA ADVENTURE	2003/11				
STRADA WORKING	2002/09				
IDEA	2005/18	CAZOLETA DELANTERA IZQUIERDA	MATERIAL CAZOLETA: METAL MATERIAL BUJE: GOMA NO INCLUYE TORNILLOS	<b>CZ270515I</b>	
IDEA ADVENTURE	2010/11				
PALIO	1999/09				
PALIO WEEKEND	1997/11				
SIENA	1997/11				
STRADA	1999/02				
STRADA ADVENTURE	2003/11				
STRADA WORKING	2002/09				
FORD					
MONDEO	1997/01	CAZOLETA TRASERA	MATERIAL CAZOLETA: METAL MATERIAL BUJE: GOMA NO INCLUYE TORNILLOS	<b>CZ303317</b>	
MONDEO RURAL	1994/01				
COURIER PICK UP	2005/11	CAZOLETA DELANTERA	MATERIAL CAZOLETA: METAL MATERIAL BUJE: GOMA NO INCLUYE TORNILLOS	<b>CZ320015</b>	
FIESTA	1994/03				
KA	1997/08				
KA	2008/14				
MONDEO	2007/14	CAZOLETA DELANTERA	MATERIAL CAZOLETA: METAL MATERIAL BUJE: GOMA NO INCLUYE TORNILLOS	<b>CZ320515</b>	
MONDEO	2001/07	CAZOLETA TRASERO	MATERIAL CAZOLETA: METAL MATERIAL BUJE: GOMA NO INCLUYE TORNILLOS	<b>CZ320517</b>	
FOCUS	2000/10	CAZOLETA DELANTERA	MATERIAL CAZOLETA: METAL MATERIAL BUJE: GOMA NO INCLUYE TORNILLOS	<b>CZ321615</b>	
FOCUS II	2008/14	CAZOLETA DELANTERA	MATERIAL CAZOLETA: METAL MATERIAL BUJE: GOMA NO INCLUYE TORNILLOS	<b>CZ324615</b>	
FOCUS II	2008/14	CAZOLETA TRASERA	MATERIAL CAZOLETA: METAL MATERIAL BUJE: GOMA NO INCLUYE TORNILLOS	<b>CZ324617</b>	

**CAZOLETAS**

STRUT MOUNTING / COXINS

FORD					
	Año Ano   Year	Descripción Sistema Descrição   Descrição	Información Adicional Informação   Information	Código Código   Code	Imagen Imagem   Image
ECOSPORT II 4X2	2012/18	CAZOLETA DELANTERA	MATERIAL CAZOLETA: METAL MATERIAL BUJE: GOMA NO INCLUYE TORNILLOS	<b>CZ325215</b>	
ECOSPORT II 4X2	2012/18	CAZOLETA DELANTERA	MATERIAL CAZOLETA: METAL MATERIAL BUJE: GOMA NO INCLUYE TORNILLOS INCLUYE CRAPODINA	<b>CZ325215C</b>	
ECOSPORT II 4X2 KA	2012/18 1997/14	CAZOLETA TRASERA	MATERIAL CAZOLETA: METAL MATERIAL BUJE: GOMA NO INCLUYE TORNILLOS	<b>CZ325217</b>	
TRANSIT	1996/01	CAZOLETA DELANTERA	MATERIAL CAZOLETA: METAL MATERIAL BUJE: GOMA NO INCLUYE TORNILLOS	<b>CZ330315</b>	
TRANSIT FURGON/BUS	2010/15	CAZOLETA DELANTERA	MATERIAL CAZOLETA: METAL MATERIAL BUJE: GOMA NO INCLUYE TORNILLOS	<b>CZ330315-1</b>	
ECOSPORT ECOSPORT II 4X2	2003/13 2012/18	CAZOLETA DELANTERA	MATERIAL CAZOLETA: METAL MATERIAL BUJE: GOMA NO INCLUYE TORNILLOS	<b>CZ340215</b>	
HONDA					
FIT	2003/08	CAZOLETA DELANTERA	MATERIAL CAZOLETA: METAL MATERIAL BUJE: GOMA NO INCLUYE TORNILLOS	<b>CZ865115</b>	
NISSAN					
MARCH VERSA	2012/15 2013/16	CAZOLETA DELANTERA	MATERIAL CAZOLETA: METAL MATERIAL BUJE: GOMA NO INCLUYE TORNILLOS INCLUYE CRAPODINA	<b>CZ903415C</b>	
TIIDA	2007/15	CAZOLETA DELANTERA DERECHA	MATERIAL CAZOLETA: METAL MATERIAL BUJE: GOMA NO INCLUYE TORNILLOS	<b>CZ903415D</b>	
TIIDA	2007/15	CAZOLETA DELANTERA IZQUIERDA	MATERIAL CAZOLETA: METAL MATERIAL BUJE: GOMA NO INCLUYE TORNILLOS	<b>CZ903415I</b>	
X-TRAIL	2008/16	CAZOLETA DELANTERA DERECHA	MATERIAL CAZOLETA: METAL MATERIAL BUJE: GOMA NO INCLUYE TORNILLOS	<b>CZ903515D</b>	

**CAZOLETAS**

STRUT MOUNTING / COXINS

NISSAN					
	Año Ano   Year	Descripción Sistema Descrição   Descrição	Información Adicional Informação   Information	Código Código   Code	Imagen Imagem   Image
X-TRAIL	2008/16	CAZOLETA DELANTERA IZQUIERDA	MATERIAL CAZOLETA: METAL MATERIAL BUJE: GOMA NO INCLUYE TORNILLOS	<b>CZ903515I</b>	
PEUGEOT					
505	1983/96	CAZOLETA DELANTERA	MATERIAL CAZOLETA: METAL MATERIAL BUJE: GOMA NO INCLUYE TORNILLOS	<b>CZ450315</b>	
505/GRAND TOUR	1986/95				
306 COUPE	1995/03	CAZOLETA DELANTERA	MATERIAL CAZOLETA: METAL MATERIAL BUJE: GOMA NO INCLUYE TORNILLOS	<b>CZ451915</b>	
208	2013/16	CAZOLETA DELANTERA	MATERIAL CAZOLETA: METAL MATERIAL BUJE: GOMA NO INCLUYE TORNILLOS	<b>CZ452115</b>	
206	2003/06	CAZOLETA DELANTERA	MATERIAL CAZOLETA: METAL MATERIAL BUJE: GOMA NO INCLUYE TORNILLOS	<b>CZ452115D</b>	
206 CABRIO COUPE	2001/09	DERECHA			
207 COMPACT	2008/17				
206	1999/13	CAZOLETA DELANTERA IZQUIERDA	MATERIAL CAZOLETA: METAL MATERIAL BUJE: GOMA NO INCLUYE TORNILLOS	<b>CZ452115I</b>	
PARTNER URBANA/FURGON	2002/10	CAZOLETA DELANTERA	MATERIAL CAZOLETA: METAL MATERIAL BUJE: GOMA NO INCLUYE TORNILLOS	<b>CZ470615</b>	
PARTNER PATAGONICA	1998/06				
PARTNER FURGON/PATAGONICA	1998/11				
308	2010/15	CAZOLETA DELANTERA	MATERIAL CAZOLETA: METAL MATERIAL BUJE: GOMA NO INCLUYE TORNILLOS	<b>CZ471215</b>	
308 SPORT	2013/17				
408	2010/15				
408 SPORT	2011/17				
307	2005/09	CAZOLETA TRASERA	MATERIAL CAZOLETA: METAL MATERIAL BUJE: GOMA NO INCLUYE TORNILLOS	<b>CZ471217</b>	
EXPERT HDI II	2008/11	CAZOLETA DELANTERA DERECHA	MATERIAL CAZOLETA: METAL MATERIAL BUJE: GOMA NO INCLUYE TORNILLOS	<b>CZ472015D</b>	
EXPERT HDI	2008/11	CAZOLETA DELANTERA IZQUIERDA	MATERIAL CAZOLETA: METAL MATERIAL BUJE: GOMA NO INCLUYE TORNILLOS	<b>CZ472015I</b>	

**CAZOLETAS**

STRUT MOUNTING / COXINS

RENAULT					
	Año Ano   Year	Descripción Sistema Descrição   Descrição	Información Adicional Informação   Information	Código Código   Code	Imagen Imagem   Image
CLIO II CLIO MIO WORK KANGOO SYMBOL	1999/11 2015/17 1999/14 2009/13	CAZOLETA DELANTERA	MATERIAL CAZOLETA: METAL MATERIAL BUJE: GOMA NO INCLUYE TORNILLOS	<b>CZ570915</b>	
CLIO II CLIO MIO WORK KANGOO SYMBOL	1999/11 2015/17 1999/14 2009/13	CAZOLETA DELANTERA	MATERIAL CAZOLETA: METAL MATERIAL BUJE: GOMA NO INCLUYE TORNILLOS INCLUYE CROPODINA	<b>CZ570915C</b>	
DUSTER 4X2 DUSTER 4X2 (BR) DUSTER 4X4 DUSTER 4X4 (BR) LOGAN SANDERO SANDERO/STEPWAY	2011/14 2011/17 2014/15 2011/17 2007/14 2009/15 2008/15	CAZOLETA DELANTERA	MATERIAL CAZOLETA: METAL MATERIAL BUJE: GOMA NO INCLUYE TORNILLOS	<b>CZ571115</b>	
DUSTER 4X2 DUSTER 4X2 (BR) DUSTER 4X4 DUSTER 4X4 (BR) LOGAN SANDERO SANDERO/STEPWAY	2011/14 2011/17 2014/15 2011/17 2007/14 2009/15 2008/15	CAZOLETA DELANTERA	MATERIAL CAZOLETA: METAL MATERIAL BUJE: GOMA NO INCLUYE TORNILLOS INCLUYE CROPODINA	<b>CZ571115C</b>	
MEGANE II MEGANE II GTOUR	2005/08 2005/11	CAZOLETA DELANTERA	MATERIAL CAZOLETA: METAL MATERIAL BUJE: GOMA NO INCLUYE TORNILLOS	<b>CZ580015</b>	
FLUENCE FLUENCE PH2 MEGANE III	2010/14 2014/17 2015/17	CAZOLETA DELANTERA	MATERIAL CAZOLETA: METAL MATERIAL BUJE: GOMA NO INCLUYE TORNILLOS	<b>CZ580015-1</b>	
KOLEOS 4X2 KOLEOS 4X4 KOLEOS PH3 4X2 KOLEOS PH3 4X4	2009/15 2009/13 2013/16 2013/16	CAZOLETA DELANTERA DERECHA	MATERIAL CAZOLETA: METAL MATERIAL BUJE: GOMA NO INCLUYE TORNILLOS	<b>CZ903515D</b>	
KOLEOS 4X2 KOLEOS 4X4 KOLEOS PH3 4X2 KOLEOS PH3 4X4	2009/15 2009/13 2013/16 2013/16	CAZOLETA DELANTERA IZQUIERDA	MATERIAL CAZOLETA: METAL MATERIAL BUJE: GOMA NO INCLUYE TORNILLOS	<b>CZ903515I</b>	
SEAT					
CORDOBA CORDOBA IBIZA IBIZA TOLEDO TOLEDO	1994/00 2003/11 1992/05 2010/11 1991/05 2008/09	CAZOLETA DELANTERA IZQUIERDA	MATERIAL CAZOLETA: METAL MATERIAL BUJE: GOMA NO INCLUYE TORNILLOS	<b>CZ230215</b>	



**CAZOLETAS**

STRUT MOUNTING / COXINS





SEAT					
	Año Ano   Year	Descripción Sistema Descrição   Descrição	Información Adicional Informação   Information	Código Código   Code	Imagen Imagem   Image
CORDOBA	1994/00	CAZOLETA DELANTERA	MATERIAL CAZOLETA: METAL	<b>CZ230215C</b>	
CORDOBA	2003/11		MATERIAL BUJE: GOMA		
IBIZA	1992/05		NO INCLUYE TORNILLOS		
IBIZA	2010/11		INCLUYE CRAPODINA		
TOLEDO	1991/05				
TOLEDO	2008/09				
SUZUKI					
FUN	2003/12	CAZOLETA DELANTERA	MATERIAL CAZOLETA: METAL MATERIAL BUJE: GOMA NO INCLUYE TORNILLOS	<b>CZ240415</b>	
TOYOTA					
HILUX	2005/16	CAZOLETA DELANTERA	MATERIAL CAZOLETA: METAL MATERIAL BUJE: GOMA NO INCLUYE TORNILLOS	<b>CZ922415</b>	
HILUX SW4	2005/16				
RAV 4 4X2	2005/13	CAZOLETA DELANTERA	MATERIAL CAZOLETA: METAL MATERIAL BUJE: GOMA NO INCLUYE TORNILLOS	<b>CZ922815</b>	
RAV 4 4X4	2005/13				
COROLLA	2002/08	CAZOLETA DELANTERA IZQUIERDA	MATERIAL CAZOLETA: METAL MATERIAL BUJE: GOMA NO INCLUYE TORNILLOS	<b>CZ923315</b>	
ETIOS	2013/16	CAZOLETA DELANTERA	MATERIAL CAZOLETA: METAL MATERIAL BUJE: GOMA NO INCLUYE TORNILLOS	<b>CZ926615</b>	
ETIOS CROSS	2013/16				
VOLKSWAGEN					
GOL	2002/09	CAZOLETA DELANTERA	MATERIAL CAZOLETA: METAL MATERIAL BUJE: GOMA NO INCLUYE TORNILLOS INCLUYE CRAPODIN	<b>CZ220615C</b>	
GOL COUNTRY	1998/09				
CROSSFOX	2005/16	CAZOLETA DELANTERA	MATERIAL CAZOLETA: METAL MATERIAL BUJE: GOMA NO INCLUYE TORNILLOS	<b>CZ224015</b>	
FOX	2003/15				
SURAN	2006/10				
GOL	1995/99	CAZOLETA DELANTERA	MATERIAL CAZOLETA: METAL MATERIAL BUJE: GOMA NO INCLUYE TORNILLOS INCLUYE CRAPODIN	<b>CZ230115C</b>	
GOL COUNTRY	1995/98				
SAVEIRO	1996/01				
SAVEIRO	2002/10				
CADDY	1998/10	CAZOLETA DELANTERA	MATERIAL CAZOLETA: METAL MATERIAL BUJE: GOMA NO INCLUYE TORNILLOS	<b>CZ230215</b>	
GOLF	1995/99				
GOLF CABRIO	1996/99				
POLO CLASSIC	2001/09				
POLO CLASSIC	1996/00				



**CAZOLETAS**

STRUT MOUNTING / COXINS

**VOLKSWAGEN**

	<b>Año</b> Ano   Year	<b>Descripción Sistema</b> Descrição   Descrição	<b>Información Adicional</b> Informação   Information	<b>Código</b> Código   Code	<b>Imagen</b> Imagem   Image
CADDY GOLF GOLF CABRIO POLO CLASSIC POLO CLASSIC	1998/10 1995/99 1996/99 2001/09 1996/00	CAZOLETA DELANTERA	MATERIAL CAZOLETA: METAL MATERIAL BUJE: GOMA NO INCLUYE TORNILLOS INCLUYE CRAPODINA	<b>CZ230215C</b>	
AMAROK	2009/17	CAZOLETA DELANTERA	MATERIAL CAZOLETA: METAL MATERIAL BUJE: GOMA NO INCLUYE TORNILLOS	<b>CZ232415</b>	
BORA GOL TREND IMOTION GOLF GOLF VARIANT NEW BEETLE SAVEIRO	2000/16 2008/17 1999/04 1999/12 1999/10 2010/15	CAZOLETA DELANTERA	MATERIAL CAZOLETA: METAL MATERIAL BUJE: GOMA NO INCLUYE TORNILLOS	<b>CZ233115</b>	
BORA GOL TREND IMOTION GOLF GOLF VARIANT NEW BEETLE SAVEIRO	2000/16 2008/17 1999/04 1999/12 1999/10 2010/15	CAZOLETA DELANTERA	MATERIAL CAZOLETA: METAL MATERIAL BUJE: GOMA NO INCLUYE TORNILLOS INCLUYE CRAPODINA	<b>CZ233115C</b>	

**BUJES DE SUSPENSION**

BUCHAS DE SUSPENSÃO / SUSPENSION BUSHING

AUDI					
	Año Ano   Year	Descripción Sistema Descrição   Descrição	Medidas Medidas   Measures	Código Código   Code	Imagen Imagem   Image
A3	2000/05	BUJE PARRILLA DELANTERA	AL 54.2 (mm) AB DE 35 (mm) DI 12 (mm)	BP230215	
A3 Q3	2011/... 2011/...	BUJE PARRILLA TRASERA	AL 50 (mm) AB 34 (mm) DE 72 - 63 (mm) DI 18.7 (mm)	BP224017	
BMW					
X5	2005/06	BUJE PARRILLA TRASERA	AL 54.2 (mm) AB DE 35 (mm) DI 12 (mm)	BP230215	
CHERY					
TIGGO TIGGO	2008/12 2015/18	BUJE BARRA ESTABILIZADORA DELANTERO CENTRAL Ø20 (mm)	AL 42.9 (mm) AB DE 42-45 (mm) DI 21.9 (mm)	BB993216	
CHEVROLET					
AGILE CORSA PRISMA	2009/17 2002/12 2010/22	BUJE PARRILLA DELANTERA	AL 70 (mm) AB 27 (mm) DE 18.3 c/ala 105.6 DI 12 (mm)	BP240415	
CELTA CHEVETTE CORSA CORSA	2011/2018 1977/1991 1994/07 2002/10	BUJE BARRA ESTABILIZADORA DELANTERA PUNTA Ø22 (mm)	AL AB DE DI 21.5 (mm)	BB240415	
CORSA VECTRA	2002/12 1993/06	BUJE BARRA ESTABILIZADORA DELANTERA CENTRAL Ø16 (mm)	AL 38.7 (mm) AB DE 33 (mm) DI 18 (mm)	BB241816-16	
ASTRA MERIVA VECTRA	2000/10 2003/13 2006/12	BUJE BARRA ESTABILIZADORA DELANTERA CENTRAL Ø17.5 (mm)	AL 39.4 (mm) AB DE 32.6 - 31.6 (mm) DI 18 (mm)	BB242216	

**BUJES DE SUSPENSION**

BUCHAS DE SUSPENSÃO / SUSPENSION BUSHING

CHEVROLET					
	Año Ano   Year	Descripción Sistema Descrição   Descrição	Medidas Medidas   Measures	Código Código   Code	Imagen Imagen   Image
CORSA TIGRA	1994/...	BUJE BARRA ESTABILIZADORA DELANTERO CENTRAL	AL AB DE DI 17 (mm)	BB242315	
AGILE MONTANA	2009/18 2011/18	BUJE AISLADOR BARRA ESTABILIZADORA DELANTERO	AL AB DE DI 21.7 (mm)	BB244015	
COBALT ONIX PRISMA II SPIN	2013/18 2013/18 2013/18 2013/18	BUJE PUNTA BARRA ESTABILIZADORA DELANTERO CENTRAL Ø18 para barra Ø21	AL 51.5 (mm) AB DE 25 (mm) DI 17.8 (mm)	BB244516	
SPARK SPARK	2008/10 2011/18	BUJE BARRA ESTABILIZADORA DELANTERO PUNTA Ø18 para barra Ø21	AL 33 (mm) AB DE DI 16 (mm)	BB282515	
CHEVY PICK UP CORSA MERIVA	2001/05 2003/10 2003/10	BUJE PARRILLA DELANTERA	AL 70 (mm) AB 27(mm) DE 60 - 48.3 (mm) DI 12 (mm)	BP244015	
COBALT ONIX PRISMA SPIN SONIC	2012/... 2012/... 2010/... 2012/... 2011/...	BUJE PARRILLA TRASERA	AL 66.3 (mm) AB 28.3(mm) DE 70.15 (mm) DI 14 (mm)	BP244517	
SPARK	2008/10	BUJE PARRILLA DELANTERA	AL 58.2 (mm) AB DE 29 (mm) DI 10.3 (mm)	BP282515	
BLAZER S10 SILVERADO	1996/... 1996/11 1996/...	BUJE PARRILLA SUPERIOR DELANTERA	AL 59 (mm) AB 51 (mm) DE 52 - 42 (mm) DI 12.2 (mm)	BP290615	
CITROEN					
C3 C4 CACTUS DS3	2009/... 2014/... 2009/15	BUJE PARRILLA DELANTERA	AL 48 (mm) AB 29.5 (mm) DE 31(mm) DI 18 (mm)	BP471715	

**BUJES DE SUSPENSION**

BUCHAS DE SUSPENSÃO / SUSPENSION BUSHING

CITROEN					
	Año Ano   Year	Descripción Sistema Descrição   Descrição	Medidas Medidas   Measures	Código Código   Code	Imagen Imagem   Image
C3	2010/16	BUJE PARRILLA TRASERA	AL 48 (mm)	BP471717	
C3 AIRCROSS	2008/18		AB 30 (mm)		
C-ELYSEE	2016/18		DE 73 - 57.5 (mm)		
		DI 18 (mm)			
DAEWOO					
TICO	1995/97	BUJE PARRILLA DELANTERA	AL 58.2 (mm)	BP282515	
			AB		
			DE 29 (mm)		
			DI 10.3 (mm)		
FIAT					
128	1987/...	BUJE TENSOR LADO ROTULA DELANTERO PUNTA	AL 23 (mm)	BT260315	
147	1987/...		AB		
DUNA	1987/...		DE		
EUROPA	1987/...		DI 14 (mm)		
SUPER EUROPA	1987/...				
FIORINO	1987/...				
UNO	1987/...				
DUNA	1996/...	BUJE BARRA ESTABILIZADORA DELANTERO PUNTA Barra Ø21 - Goma Ø22	AL	BB260315-22	
UNO	1997/00		AB		
		DE			
		DI 22 (mm)			
ARGO	2017/20	BUJE PARRILLA DELANTERA	AL 55 (mm)	BP270515	
DOBLO	2002/20		AB		
FIORINO	2014/20		DE 39.5 (mm)		
IDEA	2005/13		DI 41.7 - 30.2 (mm)		
PALIO	1996/17				
SIENA	1998/17				
NUEVO UNO	2010/20				
MOBI	2016/20				
UNO FIRE	2004/18	BUJE BARRA ESTABILIZADORA DELANTERO CENTRAL Barra Ø15 - Goma Ø14	AL	BB270516-15	
UNO CARGO	2002/05		AB		
		DE			
		DI 14 (mm)			
DUNA	1991/96	BUJE BARRA ESTABILIZADORA DELANTERO Barra Ø18 - Goma Ø17	AL	BB270516-18	
ELBA	1991/96		AB		
FIORINO	1991/96		DE		
PREMIO	1991/96		DI 17.8 (mm)		
UNO	1991/96				







**BUJES DE SUSPENSION**

BUCHAS DE SUSPENSÃO / SUSPENSION BUSHING

FORD					
	Año Ano   Year	Descripción Sistema Descrição   Descripción	Medidas Medidas   Measures	Código Código   Code	Imagen Imagem   Image
GALAXY	1991/96	BUJE PARRILLA TRASERA	AL 44.2 (mm) AB 31.7 (mm) DE 47 - 37.4 (mm) DI 10 (mm)	BP230017	
COURIER	1997/...	BUJE BARRA	AL	BB301016	
ESCORT	1993/95	ESTABILIZADORA	AB		
FIESTA	1994/03	DELANTERO CENTRAL	DE		
KA	1993/03	Ø16	DI 16 (mm)		
LOGUS	1993/96				
ORION	1996/...				
POINTER	1994/96				
VERONA	1993/96				
COURIER	1997/...	BUJE BARRA	AL	BB301016-17	
ESCORT	1993/95	ESTABILIZADORA	AB		
FIESTA	1994/03	DELANTERO CENTRAL	DE		
KA	1993/03	Reforma Ø17	DI 17 (mm)		
LOGUS	1993/96				
ORION	1996/...				
POINTER	1994/96				
VERONA	1993/96				
KA	1996/08	BUJE BARRA	AL	BB310816	
		ESTABILIZADORA	AB		
		DELANTERO CENTRAL	DE		
		Ø13	DI 13 (mm)		
ESCORT	1994/02	BUJE EJE TRASERO	AL 70 (mm)	BET310800	
FIESTA	1994/99	AMBOS LADOS	AB 55.5 (mm)		
KA	1997/99		DE 31.3 (mm)		
			DI 12 (mm)		
FOCUS	1999/...	BUJE PARRILLA TRASERA	AL 35 (mm) AB 28.5 (mm) DE 33 (mm) DI 12 (mm)	BP302217-T	
ECOSPORT	2003/...	BUJE PARRILLA	AL 55 (mm)	BP340116	
FIESTA	1994/99	DELANTERA CENTRAL	AB		
KA	1997/08		DE 25.7 (mm)		
			DI 12.4 (mm)		

**BUJES DE SUSPENSION**

BUCHAS DE SUSPENSÃO / SUSPENSION BUSHING

HONDA					
	Año Ano   Year	Descripción Sistema Descrição   Descrição	Medidas Medidas   Measures	Código Código   Code	Imagen Imagem   Image
CIVIC CR-V	1993/01 1993/01	BUJE BRAZO OSCILANTE DELANTERO INFERIOR	AL 61 (mm) AB DE 59 (mm) DI 18.4 (mm)	BC861115	
CIVIC CR-V	2001/06 2001/...	BUJE BRAZO OSCILANTE TRASERO SUPERIOR	AL 47 (mm) AB DE 42 (mm) DI 12.5 (mm)	BC861117	
CR-V	2007/...	BUJE BARRA ESTABILIZADORA CAP1919 TRASERA Ø19	AL 29 (mm) AB DE DI 19 (mm)	BB861417	
HYUNDAI					
TUCSON	2004/...	BUJE BRAZO OSCILANTE TRASERO	AL 47.9 (mm) AB DE 40.3 (mm) DI 12 (mm)	BC971317	
ELANTRA 2007/10 I30 2007/11	2007/10 2007/11	BUJE BRAZO OSCILANTE DELANTERO	AL 55 (mm) AB DE 38 (mm) DI 12 (mm)	BC990715	
KIA					
SPORTAGE	2004/...	BUJE BRAZO OSCILANTE TRASERO	AL 47.9 (mm) AB DE 40.3 (mm) DI 12 (mm)	BC971317	
SPORTAGE	2007/...	BUJE BRAZO OSCILANTE DELANTERO	AL 55 (mm) AB DE 38 (mm) DI 12 (mm)	BC990715	
NISSAN					
TIIDA	2007/18	BUJE DE CUNA / ARAÑA AMBOS LADOS	AL 85 (mm) AB DE 24 (mm) DI 16.8 (mm)	BC570900	

**BUJES DE SUSPENSION**

BUCHAS DE SUSPENSÃO / SUSPENSION BUSHING

NISSAN					
	Año Ano   Year	Descripción Sistema Descrição   Descrição	Medidas Medidas   Measures	Código Código   Code	Imagen Imagen   Image
SENTRA	2007/12	BUJE BARRA ESTABILIZADORA DELANTERO PUNTA	AL AB DE DI 23 (mm)	BB582115	
PEUGEOT					
208	2012/...	BUJE PARRILLA DELANTERA	AL 48 (mm)	BP471715	
208	2013/...		AB 29.5 (mm)		
			DE 31 (mm)		
			DI 18 (mm)		
208	2013/18	BUJE PARRILLA TRASERA	AL 48 (mm)	BP471717	
301	2016/18		AB 30 (mm)		
			DE 73 - 57.5 (mm)		
			DI 18 (mm)		
206	2007/...	BUJE PARRILLA DELANTERA CENTRAL BOMBITO Ø55 (mm)	AL 56 (mm)	BP472016	
207	2007/...		AB 32 (mm)		
307	2007/...		DE 29.5 (mm)		
3008	2007/...		DI 14 (mm)		
5008	2007/...				
PARTNER TEPEE	2008/...				
208	2002/18	BUJE PARRILLA TRASERA	AL 48 (mm)	BP472217	
208	2002/18		AB 30 (mm)		
301	2016/18		DE 25 (mm)		
			DI 18 (mm)		
RENAULT					
CLIO	1992/11	BUJE BARRA ESTABILIZADORA DELANTERO PUNTA	AL 62.2 (mm)	BB560415	
CLIO II	1999/08		AB		
CLIO WILLIAMS	1994/96		DE 42.3 - 30.7 (mm)		
EXPRESS	1995/02		DI 24 (mm)		
KANGOO	2000/...				
MEGANE	1998/00				
R19	1989/01				
MEGANE	1997/99	BUJE PARRILLA DELANTERA	AL 46 (mm)	BP560415	
R19	1993/01		AB 35.9 (mm)		
SCENIC	1998/01		DE 45.6 (mm)		
			DI 12 (mm)		



**BUJES DE SUSPENSION**

BUCHAS DE SUSPENSÃO / SUSPENSION BUSHING

RENAULT					
	Año Ano   Year	Descripción Sistema Descrição   Descrição	Medidas Medidas   Measures	Código Código   Code	Imagen Imagen   Image
CLIO	1991/00	BUJE BARRA	AL 41.6 (mm)	<b>BB560416</b>	
CLIO II	1998/08	ESTABILIZADORA	AB		
CLIO WILLIAMS	1994/96	DELANTERO CENTRAL	DE 47.8 - 35.5(mm)		
KANGOO	1999/18	Ø20 (mm)	DI 21 (mm)		
KANGOO II	2003/18				
R19	1989/01				
CLIO	2012/19	BUJE PARRILLA TRASERA	AL 53 (mm)	<b>BP560617</b>	
KANGOO	2008/...		AB 29 (mm)		
MEGANE	2003/09		DE 58.3 (mm)		
SCENIC	2003/09		DI 12.4 (mm)		
MEGANE	1999/11	BUJE DE CUNA / ARAÑA	AL 85 (mm)	<b>BC570900</b>	
			AB		
			DE 24 (mm)		
			DI 16.8 (mm)		
CAPTUR	2016/23	BUJE PARRILLA CENTRAL	AL 45 (mm)	<b>BP570916</b>	
DUSTER	2011/23		AB 29 (mm)		
KANGOO II	2007/23		DE 49.8 - 38 (mm)		
OROCH	2016/23		DI 14 (mm)		
DUSTER	2011/18	BUJE BARRA	AL 35.5 (mm)	<b>BB570916-2</b>	
DUSTER OROCH	2016/18	ESTABILIZADORA	AB		
		DELANTERO CENTRAL	DE 35.5 - 34.8 (mm)		
			DI 16 (mm)		
LOGAN	2007/18	BUJE BARRA	AL 35.4 (mm)	<b>BB571016</b>	
LOGAN II	2013/18	ESTABILIZADORA	AB		
SANDERO	2015/18	DELANTERO CENTRAL	DE 33.8 (mm)		
SANDERO STEPWAY	2008/18	Ø23 (mm)	DI 23.8 (mm)		
FLUENCE	2010/...	BUJE PARRILLA DELANTERA	AL 50.7 (mm)	<b>BP580015</b>	
MEGANE	2010/...		AB 31 (mm)		
			DE 35.6 (mm)		
			DI 18.3 (mm)		
FLUENCE	2010/...	BUJE PARRILLA TRASERA	AL 65 (mm)	<b>BP580017</b>	
MEGANE	2010/...		AB 35.5 (mm)		
			DE 28 - 33 (mm)		
			DI 14.2 (mm)		
CLIO II	1999/11	BUJE PARRILLA	AL 46 (mm)	<b>BP580115</b>	
KANGOO	1998/22	DELANTERO	AB 32.7 (mm)		
			DE 30.3 (mm)		
			DI 15 (mm)		

**BUJES DE SUSPENSION**

BUCHAS DE SUSPENSÃO / SUSPENSION BUSHING

RENAULT					
	Año Ano   Year	Descripción Sistema Descrição   Descrição	Medidas Medidas   Measures	Código Código   Code	Imagen Imagen   Image
CLIO MIO	2012/18	BUJE BARRA	AL 71.8 (mm)	BB580115	
CLIO II	2001/11	ESTABILIZADORA	AB 43.8 - 32.5 (mm)		
CLIO III	2001/09	DELANTERO PUNTA	DE		
KANGOO	2001/09	Ø24 (mm)	DI		
MEGANE	2005/11				
SCENIC	1998/09				
SEAT					
LEON	2004/...	BUJE PARRILLA TRASERA	AL 50 (mm)	BP224017	
TOLEDO	2004/...		AB 34 (mm)		
ALHAMBRA	2010/...		DE 63 - 72 (mm)		
			DI 18.7 (mm)		
CORDOBA	1994/11	BUJE PARRILLA DELANTERA	AL 54.2 (mm)	BP230215	
IBIZA	1992/11		AB		
IBIZA	1993/02	BUJE DE CUNA / ARAÑA DELANTERA INFERIOR	AL 60 (mm)	BC231415	
TOLEDO	1993/02		AB		
SUZUKI					
FUN	2003/12	BUJE BARRA ESTABILIZADORA DELANTERO PUNTA Ø22 (mm)	AL	BB240415	
			AB		
			DE		
			DI 21 (mm)		
TOYOTA					
SW4	1996/04	BUJE PARRILLA DELANTERA SUPERIOR	AL 54.5 (mm)	BP922415	
			AB 40 (mm)		
			DE 52.5 - 38.4 (mm)		
			DI 15 (mm)		
COROLLA	2009/18	BUJE BARRA ESTABILIZADORA DELANTERO CENTRAL	AL 41.2 (mm)	BB923316	
			AB		
			DE 41.7 - 44.3 (mm)		
			DI 24 (mm)		
RAV	2000/06	BUJE BARRA ESTABILIZADORA DELANTERO CENTRAL	AL 42.9 (mm)	BB993216	
			AB		
			DE 42 - 45 (mm)		
			DI 21.9 (mm)		

**BUJES DE SUSPENSION**

BUCHAS DE SUSPENSÃO / SUSPENSION BUSHING

TOYOTA					
	Año Ano   Year	Descripción Sistema Descrição   Descrição	Medidas Medidas   Measures	Código Código   Code	Imagen Imagen   Image
COROLLA	2001/08	BUJE PARRILLA DELANTERA	AL 60 (mm) AB 42.5 DE 34 - 38 (mm) DI 14.3 (mm)	BP923315	
RAV 4	1994/00	BUJE PARRILLA DELANTERA CENTRAL	AL 56.3 (mm) AB 52.8 (mm) DE 25.3 (mm) DI 14.3 (mm)	BP923316	
COROLLA	2002/08	BUJE BARRA ESTABILIZADORA DELANTERO CENTRAL Ø21 (mm)	AL AB DE DI 21 (mm)	BB923316-21	
COROLLA	1990/08	BUJE BARRA ESTABILIZADORA DELANTERO CENTRAL Ø22 (mm)	AL 42.8 (mm) AB DE 42 - 45 (mm) DI 22 (mm)	BB923316-22	
COROLLA	20010/08	BUJE PARRILLA DELANTERA PESTAÑA	AL 60 (mm) AB 30 (mm) DE 68.3 - 74 (mm) DI 14.7 (mm)	BP923317	
HILUX SW4	2015/19	BUJE BARRA ESTABILIZADORA DELANTERO CENTRAL	AL AB DE DI 32 (mm)	BB950416	
VOLVO					
S40	2008/10	BUJE PARRILLA TRASERA	AL 35(mm) AB 28.5 (mm) DE 33 (mm) DI 12 (mm)	BP302217-T	
VOLSWAGEN					
GACEL	1981/96	BUJE EJE TRASERO	AL 55 (mm)	BET220400	
GOL	1981/96		AB 35 (mm)		
GOL	2003/06		DE 45.3 - 54 (mm)		
PARATI	1982/95		DI 11.9 (mm)		
PARATI	1996/02				
POINTER	1997/02				
SAVEIRO	1981/96				
SAVEIRO	2003/06				
VOYAGE	1982/95				

**BUJES DE SUSPENSION**

BUCHAS DE SUSPENSÃO / SUSPENSION BUSHING

VOLKSWAGEN					
	Año Ano   Year	Descripción Sistema Descrição   Descrição	Medidas Medidas   Measures	Código Código   Code	Imagen Imagem   Image
GACEL 1981/95 GOL 1980/95 PARATI 82/86 QUANTUM 1985/96 SAVEIRO 1981/95 VOYAGE 1981/95 PASSAT 1981/95 SANTANA 1984/96	1981/95 1980/95 1982/86 1985/96 1981/95 1981/95 1981/95 1984/96	BUJE BARRA ESTABILIZADORA DELANTERO CENTRAL	AL 27 (mm) AB 15 (mm) DE 26 - 24.17 (mm) DI 10 (mm)	BB220416	
GACEL GOL PARATI QUANTUM SAVEIRO VOYAGE	1982/96 1982/96 1982/96 1982/96 1982/97 1982/96	BUJE BARRA ESTABILIZADORA DELANTERO CENTRAL Ø15 (mm)	AL AB DE DI 15.5 (mm)	BB220416-15	
CARAT 1987/92 GACEL 1983/94 GOL 1991/09 PASSAT 1983/84 PASSAT 2003/18 POINTER 1993/97 QUANTUM 1986/98 SAVEIRO 1990/01 SENDA 1989/97	1987/92 1983/94 1991/09 1983/84 2003/18 1993/97 1986/98 1990/01 1989/97	BUJE PARRILLA DELANTERA	AL 47 (mm) AB 44 (mm) DE 46.5 - 38 (mm) DI 10 (mm)	BP220417	
GOLF JETTA	1988/92 1988/92	BUJE BRAZO OSCILANTE TRASERO	AL 90 (mm) AB DE 44.5 (mm) DI 12 (mm)	BC222017	
FOX CROSS-FOX SURAN GOLF	2005/18 2005/18 2010/18 2015/17	BUJE PARRILLA DELANTERA	AL 54 (mm) AB DE 26.9 (mm) DI 12.2 (mm)	BP224015	
FOX GOL TREND SURAN UP VOYAGE	2003/18, 2008/18, 2007/18, 2014/18, 2016/18	BUJE BARRA ESTABILIZADORA DELANTERO CENTRAL Ø17 (mm)	AL 35.5 (mm) AB DE 35 - 37 (mm) DI 19 (mm)	BB224016-17	
PASSAT GOLF NEW BEETLE VENTO	2008/... 2008/... 2008/... 2008/...	BUJE PARRILLA TRASERA	AL 50 (mm) AB 34 (mm) DE 72 - 63 (mm) DI 18.7 (mm)	BP224017	

**BUJES DE SUSPENSION**

BUCHAS DE SUSPENSÃO / SUSPENSION BUSHING

VOLKSWAGEN					
	Año Ano   Year	Descripción Sistema Descrição   Descrição	Medidas Medidas   Measures	Código Código   Code	Imagen Imagem   Image
CACEL GOL SAVEIRO SENDA PARATI VOYAGER	1980/... 1980/14 1982/08 1981/... 1981/12 1981/95	BUJE BARRA ESTABILIZADORA PUNTA Ø15 (mm)	AL AB DE DI 15 (mm)	BB230015-15	
CARAT GOL QUANTUM	1987/92 1991/09 1986/98	BUJE PARRILLA TRASERA	AL 44.2 (mm) AB 31.7 (mm) DE 47 - 37.4 (mm) DI 10 (mm)	BP230017	
BORA CADY FOX GOL GOL TREND GOLF NEW BEETLE PASSAT POLO CLASSIC SAVEIRO SURAN VOYAGE	2000/18 1998/10 2003/18 2002/09 2008/18 1996/12 1999/10 2006/11 1996/09 2010/18 2010/18 2008/18	BUJE PARRILLA DELANTERA	AL 54.2 (mm) AB DE 35 (mm) DI 12 (mm)	BP230215	
BORA CADDY PASSAT POLO VENTO	1994/98 1994/98 1994/98 1997/08 1994/98	BUJE DE CUNA / ARAÑA DELANTERO INFERIOR	AL 60 (mm) AB DE 41 (mm) DI 17 (mm)	BC231415	
GOLF PASSAT SCIROCCO TIGUAN VENTO	2012/13 2011/... 2015/17 2008/... 2008/...	BUJE PARRILLA CENTRAL	AL 54 (mm) AB 33 (mm) DE 48 - 40 (mm) DI 12 (mm)	BP231416	
AMAROK	2010/21	BUJE PARRILLA INFERIOR	AL 60 (mm) AB DE 52 (mm) DI 14 (mm)	BP232415	

**SOPORTE DE ESCAPE**

SUPORTE DE ESCAPE / EXHAUST PIPE SUPPORT

CHEVROLET					
	Año Ano   Year	Descripción Sistema Descrição   Descrição	Medidas Medidas   Measures	Código Código   Code	Imagen Imagen   Image
ASTRA	1999/11	SOPORTE ESCAPE TRASERO	AN 54,7 (mm)	SE240217	
VECTRA	1997/05		AL 35,4 (mm)		
ZAFIRA	1999/09				
CORSA	1994/12	SOPORTE ESCAPE DELANTERO	AN 65 (mm)	SE240415	
CORSA A	1998/17		AL 45 (mm)		
CLASSIC	2004/16	SOPORTE ESCAPE TRASERO	AN 68,7 (mm)	SE240417	
CORSA	1994/03		AL 43,9 (mm)		
TIGRA	1998/98				
Kadett 1984/91	1984/91	SOPORTE ESCAPE CENTRAL	AN 73 (mm)	SE280216	
Calibra 1994/95	1994/95		AL 63,4 (mm)		
Corsa 1995/03	1995/03				
Omega	1993/98				
Suprema 1993/98	1993/98				
Vectra 1994/96	1994/96				
CORSA PICK UP	1995/03	SOPORTE ESCAPE TRASERO	AN 104,5 (mm)	SE280217	
CORSA	1995/12		AL 30 (mm)		
IPANEMA	1989/98				
KADETT	1989/98				
MONZA	1991/96				
FIAT					
147	1976/82	SOPORTE ESCAPE DELANTERO	AN 29,3 (mm)	SE250515	
FIORINO	1980/82		AL 71,4 (mm)		
147	1976/82	ANILLO SOPORTE ESCAPE DELANTERO	EX 66,5 (mm)	SE250515-1	
FIORINO	1980/82		IN 44,5 (mm)		
147	1976/82	SOPORTE ESCAPE TRASERO	AN 76,2 (mm)	SE250517	
FIORINO	1980/82		AL 29,3 (mm)		
ELBA	1986/96	SOPORTE ESCAPE CENTRAL	AN 85,3/42,8 (mm)	SE260316	
FIORINO	1984/96		AL 38,5 (mm)		
PREMIO	1985/94				
TEMPRA	1992/99				
TIPO	1994/95				
UNO	1984/1996				
UNO MILLE	1984/96				

**SOPORTE DE ESCAPE**

SUPORTE DE ESCAPE / EXHAUST PIPE SUPPORT



FIAT					
	Año Ano   Year	Descripción Sistema Descrição   Descrição	Medidas Medidas   Measures	Código Código   Code	Imagen Imagem   Image
ELBA	1986/96,	SOPORTE ESCAPE TRASERO	AN 60.4 (mm)	SE260317	
FIORINO	1988/13,		AL 44.7 (mm)		
PREMIO	1985/94,				
TEMPRA	1992/99,				
UNO	1984/96,				
UNO MILLE	1991/13				
DUCATO	1998/...	ANILLO SOPORTE ESCAPE DELANTERO	AN 76,2 (mm)	SE270015	
ELBA	1986/94		AL 29.3 (mm)		
FIORINO	1988/94				
PREMIO	1985/94				
TEMPRA	1992/99				
UNO	1984/96				
UNO MILLE	1991/96				
FORD					
ESCORT	1983/96	SOPORTE ESCAPE DELANTERO	AN 68.8 (mm)	SE300715	
VERONA	1990/92		AL 44.8 (mm)		
ESCORT	1983/96	SOPORTE ESCAPE TRASERO	AN 104.5 (mm)	SE300717	
VERONA	1990/92		AL 30 (mm)		
VOLKSWAGEN					
GOL	1980/98	SOPORTE ESCAPE TRASERO	AN 56.4 (mm)	SE220617	
PARATI	1981/12		AL 58.9 (mm)		
PASSAT	1981/89				
SAVEIRO	1981/98				
VOYAGE	1981/95				
GACEL	2004/...				
POINTER	2004/...				
QUANTUM	1985/01	SOPORTE ESCAPE TRASERO	AN 25.3 (mm)	SE230017	
SANTANA	1984/95		AL 20.53 (mm)		
GOL	1998/14	SOPORTE ESCAPE CENTRAL	AN 61.4 (mm)	SE230616	
PARATI	1998/12		AL 58.3 (mm)		
SAVEIRO	1999/08				
POINTER (Menos G5)	2003/...				
GOL	1996/98	SOPORTE ESCAPE TRASERO	AN 24.4 (mm)	SE230617	
PARATI	1997/98		AL 20 (mm)		



**SOPORTE DE ESCAPE**











SUPORTE DE ESCAPE / EXHAUST PIPE SUPPORT

**VOLKSWAGEN**

	<b>Año</b> Ano   Year	<b>Descripción Sistema</b> Descrição   Descrição	<b>Medidas</b> Medidas   Measures	<b>Código</b> Código   Code	<b>Imagen</b> Imagem   Image
APOLLO	1989/92	SOPORTE ESCAPE DELANTERO	<b>AN</b> 68.8 (mm) <b>AL</b> 44.8 (mm)	<b>SE300715</b>	
APOLLO	1989/92	SOPORTE ESCAPE TRASERO	<b>AN</b> 104.5 (mm) <b>AL</b> 30 (mm)	<b>SE300717</b>	











**EXTREMOS DE DIRECCIÓN**

TERMINAIS DE DIREÇÃO / STEERING SYSTEM

ALFA ROMEO					
	Año Ano   Year	Descripción Sistema Descrição   Descrição	Medidas Medidas   Measures	Código Código   Code	Imagen Imagen   Image
156 GT	1997/01 2003/10	EXTREMO DE DIRECCIÓN DERECHA	L 78 (mm) RLA H14 x 1,5 (mm) DC 12,6 (mm)	EX270600D	
156 GT	1997/01 2003/10	EXTREMO DE DIRECCIÓN IZQUIERDA	L 78 (mm) RLA H14 x 1,5 (mm) DC 12,6 (mm)	EX270600I	
MITO	2009/21	EXTREMO DE DIRECCIÓN DERECHA	L 113(mm) RLA H 14 x 1,5(mm) DC 12(mm)	EX271700D	
MITO	2009/21	EXTREMO DE DIRECCIÓN IZQUIERDA	L 113(mm) RLA H 14 x 1,5(mm) DC 12(mm)	EX271700I	
ASIA MOTORS					
TOPIC	1993/99	EXTREMO DE DIRECCIÓN	L 160 (mm) RLA H 14 x 1,5(mm) DC 14(mm)	EX910000	
AUDI					
A3	1997/05	EXTREMO DE DIRECCIÓN DELANTERO DERECHA	L 94(mm) RLA H 14 x 1,5(mm) DC 13,2(mm)	EX221700D	
A3	1997/05	EXTREMO DE DIRECCIÓN DELANTERO IZQUIERDA	L 94(mm) RLA H 14 x 1,5(mm) DC 13,2(mm)	EX221700I	
A4 AVANT A4 CABRIOLET A4 SEDAN A6 AVANT A6 SEDAN A8	1997/07 2003/05 1993/07 1994/00 1998/05 1995/05	EXTREMO DE DIRECCIÓN DELANTERO	L 160 (mm) RLA M 14 x 1,5(mm) DC 17.44(mm)	EX230900	
A3 A3 SPORTBACK	2006/08 2005/08	EXTREMO DE DIRECCIÓN DELANTERO DERECHA	L 95(mm) RLA H 16 x 1,5(mm) DC 13,5(mm)	EX231400D	
A3 A3 SPORTBACK	2006/08 2005/08	EXTREMO DE DIRECCIÓN DELANTERO IZQUIERDO	L 90 (mm) RLA M 16 x 1,5(mm) DC	EX231400I	









**EXTREMOS DE DIRECCIÓN**

TERMINAIS DE DIREÇÃO / STEERING SYSTEM

AUDI					
	Año Ano   Year	Descripción Sistema Descrição   Descrição	Medidas Medidas   Measures	Código Código   Code	Imagen Imagen   Image
Q7	2006/14	EXTREMO DE DIRECCIÓN DELANTERA DERECHA	L 90 (mm) RLA M16 x 1,5 (mm) DC	EX232400D	
Q7	2006/14	EXTREMO DE DIRECCIÓN DELANTERA IZQUIERDA	L 90 (mm) RLA M16 x 1,5 (mm) DC	EX232400DI	
A3	2006/08	EXTREMO DE DIRECCIÓN DELANTERA IZQUIERDA	L 95 (mm) RLA H16X1.5 (mm) DC 13.3 (mm)	EX233200D	
A3	2006/08	EXTREMO DE DIRECCIÓN DELANTERA IZQUIERDA	L 95 (mm) RLA H16X1.5 (mm) DC 13.3 (mm)	EX233200I	
CHEVROLET					
MERIVA	2004/13	EXTREMO DE DIRECCIÓN DELANTERA	L 100 (mm) RLA H14 x 1,5 (mm) DC 10.8 (mm)	EX240400	
LUV	1992/99	EXTREMO DE DIRECCIÓN DELANTERA EXTERIOR	L 74 (mm) RLA H14 x 1,5 (mm) DC 16 (mm)	EX240700E	
LUV	1992/99	EXTREMO DE DIRECCIÓN DELANTERA INTERIOR	L 74 (mm) RLA H14 x 1,5 (mm) DC 16 (mm)	EX240700I	
CORSA	1994/07	EXTREMO DE DIRECCIÓN DELANTERA	L 70 (mm)	EX240900	
CORSA SEDAN	1995/07		RLA H12 x 1,5 (mm)		
CORSA PICKUP	1995/07		DC 11 (mm)		
CORSA STATION WAGON	1995/07				
CELTA	2011/17	EXTREMO DE DIRECCIÓN DELANTERA	L 75 (mm)	EX241000	
CLASSIC	2010/21		RLA H14 x 1,5 (mm)		
CORSA	1996/03		DC 10,8 (mm)		
CORSA CLASSIC	2002/10				
CORSA COMBO / PICKUP	1998/03				
CORSA SEDAN	1996/03				
CORSA STATION WAGON	1996/03				
PRISMA	2011/13				
TIGRA	1998/03				
VECTRA	1996/06	EXTREMO DE DIRECCIÓN DELANTERA	L 75 (mm) RLA H14 x 1,5 (mm) DC 13,5 (mm)	EX241400	











**EXTREMOS DE DIRECCIÓN**

TERMINAIS DE DIREÇÃO / STEERING SYSTEM

CHEVROLET					
	Año Ano   Year	Descripción Sistema Descrição   Descrição	Medidas Medidas   Measures	Código Código   Code	Imagen Imagem   Image
BLAZER S-10	1997/10 1996/12	EXTREMO DE DIRECCIÓN EXTERIOR LARGO	L 216 (mm) RLA M11/16" x 18 (IZQ) DC 13.23	EX242000	
BLAZER S-10	1997/10 1996/12	EXTREMO DE DIRECCIÓN INTERIOR CORTO	L 116 (mm) RLA M11/16" x 18 (DER) DC 12.44	EX242000-1	
AGILE CORSA 2 SEDAN CORSA 2 HATCH	2009/21 2002/12 2002/12	EXTREMO DE DIRECCIÓN DELANTERO	L 92 (mm) RLA H14 x 1,5 (mm) DC 10.8 ((mm))	EX244000	
COBALT ONIX ONIX ACTIV ONIX JOY PRISMA II PRISMA II JOY SONIC SPIN SPIN ACTIV	2013/23 2013/23 2016/22 2017/23 2013/23 2017/23 2012/16 2012/23 2015/23	EXTREMO DE DIRECCIÓN DELANTERO	L 75 (mm) RLA H14 x 1,5 (mm) DC 13.5 (mm)	EX244100	
CAPTIVA	2007/12	EXTREMO DE DIRECCIÓN DELANTERO	L 75 (mm) RLA H14 x 1,5 (mm) DC 12,5 (mm)	EX290000	
CAPTIVA ASTRA ASTRA II VECTRA ZAFIRA	2007/12 1998/03 2002/12 2006/12 2001/10	EXTREMO DE DIRECCIÓN DELANTERO	L 135 (mm) RLA H14 x 1,5 (mm) DC 13,5 (mm)	EX290800	
AVEO KALOS	2008/15 2005/...	EXTREMO DE DIRECCIÓN DELANTERO DERECHA	L 190 (mm) RLA H12 x 1,5 (mm) DC 13,4 (mm)	EX291000D	
AVEO KALOS	2008/15 2005/...	EXTREMO DE DIRECCIÓN DELANTERO IZQUIERDA	L 190 (mm) RLA H12 x 1,5 (mm) DC 13,4 (mm)	EX291000I	
CITROËN					
BERLINGO FURGON BERLINGO MULTISPACE C15 FURGON XSARA XSARA PICASSO ZX	1998/22 1998/22 1993/02 1998/03 1999/11 1993/04	EXTREMO DE DIRECCIÓN DELANTERO	L 95(mm) RLA M 14 x 1,5(mm) DC 12,6(mm)	EX450300	











**EXTREMOS DE DIRECCIÓN**

TERMINAIS DE DIREÇÃO / STEERING SYSTEM

CITROEN					
	Año Ano   Year	Descripción Sistema Descrição   Descrição	Medidas Medidas   Measures	Código Código   Code	Imagen Imagen   Image
AX C4 SAXO XANTIA	1991/98 2007/14 2001/03 1993/01	EXTREMO DE DIRECCIÓN DELANTERA DERECHA	L 125(mm) RLA M 14 x 1,5(mm) DC 12,6(mm)	EX452100D	
AX C4 SAXO XANTIA	1991/98 2007/14 2001/03 1993/01	EXTREMO DE DIRECCIÓN DELANTERA IZQUIERDA	L 125(mm) RLA M 14 x 1,5(mm) DC 12,6(mm)	EX452100I	
C3	2003/12	EXTREMO DE DIRECCIÓN DELANTERA DERECHO	L 169,3(mm) RLA H 14 x 1,5(mm) DC 12(mm)	EX472100D	
C3	2003/12	EXTREMO DE DIRECCIÓN DELANTERA IZQUIERDO	L 169,3(mm) RLA H 14 x 1,5(mm) DC 12(mm)	EX472100I	
C4 Cactus	2014/...	EXTREMO DE DIRECCIÓN DELANTERA DERECHO	L 203 (mm) RLA M 14 x 1,5(mm) DC M 10 x 1.25 ((mm))	EX472200D	
C4 Cactus	2014/...	EXTREMO DE DIRECCIÓN DELANTERA DERECHO	L 203 (mm) RLA M 14 x 1,5(mm) DC M 10 x 1.25 ((mm))	EX472200I	
DACIA					
TLX / PICKUP	1995/99	EXTREMO DE DIRECCIÓN DELANTERA DERECHA	L 235(mm) RLA DC 12,2(mm)	EX550400D	
TLX / PICKUP	1995/99	EXTREMO DE DIRECCIÓN DELANTERA IZQUIERDA	L 235(mm) RLA DC 12,2(mm)	EX550400I	
DAEWOO					
MATIZ TICO	1995/97 1998/03	EXTREMO DE DIRECCIÓN	L 75(mm) RLA H 12 x 1,5(mm) DC 12,8(mm)	EX940000	
FIAT					
600	1964/82	EXTREMO DE DIRECCIÓN DELANTERO INTERIOR CORTO	L 75(mm) RLA M 14 x 1(mm) DC 12(mm)	EX250100	



**EXTREMOS DE DIRECCIÓN**

TERMINAIS DE DIREÇÃO / STEERING SYSTEM

FIAT					
	Año Ano   Year	Descripción Sistema Descrição   Descrição	Medidas Medidas   Measures	Código Código   Code	Imagen Imagen   Image
125 MULTICARGA 125 1500 1600	1969/77 1969/74 1967/74 1967/74	EXTREMO DE DIRECCIÓN DELANTERO CORTO	L 90(mm) RLA M 16 x 1(mm) DC 14,8(mm)	EX250200	
128	1983/91	EXTREMO DE DIRECCIÓN DELANTERO	L 223(mm) RLA H 14 x 1(mm) DC 12(mm)	EX250400	
128 EUROPA	1978/83	EXTREMO DE DIRECCIÓN DELANTERO	L 205(mm) RLA H 14 x 1(mm) DC 12(mm)	EX250500	
147 SPAZIO BRIO FIORINO/PICKUP	1983/84 1991/92 1987/91 1989/97	EXTREMO DE DIRECCIÓN DELANTERO	L 126(mm) RLA H 12 x 1,5(mm) DC 12(mm)	EX250600-1	
REGATTA REGATTA WEEKEND	1985/94 1985/95	EXTREMO DE DIRECCIÓN DELANTERO	L 120 (mm) RLA H 12 x 1,5(mm) DC 12(mm)	EX250900	
REGATTA WEEKEND REGATTA REGATTA DUCATO	1985/95 1985/94 1987/94 1998/05	EXTREMO DE DIRECCIÓN DELANTERO	L 122 (mm) RLA H 16 x 1,5(mm) DC 16.5 (mm)	EX252900	
DUCATO DUNA DUNA DUNA WEEKEND FIORINO FIORINO FURGON FIORINO FURGON FIORINO WORKING UNO UNO UNO CARGO	1992/01 1988/01 1991/01 1991/01 1996/00 1994/06 2005/15 1997/00 1992/04 2004/15 2002/16	EXTREMO DE DIRECCIÓN DELANTERO	L 80 (mm) RLA H18 x 1.5 (mm) DC 14.5 (mm)	EX260000	
REGATTA	1993/...	EXTREMO DE DIRECCIÓN DELANTERO	L 180(mm) RLA H 14 x 1,5(mm) DC 12(mm)	EX260100	
UNO DUNA FIORINO DUNA WEEKEND	1988/94 1988/01 1988/92 1988/95	EXTREMO DE DIRECCIÓN DELANTERO	L 160(mm) RLA H 12 x 1,5(mm) DC 12(mm)	EX260200	

**EXTREMOS DE DIRECCIÓN**









TERMINAIS DE DIREÇÃO / STEERING SYSTEM

FIAT					
	Año Ano   Year	Descripción Sistema Descrição   Descrição	Medidas Medidas   Measures	Código Código   Code	Imagen Imagem   Image
147 VIVACE FIORINO/PICKUP SPAZIO	1992/97 1989/98 1991/97	EXTREMO DE DIRECCIÓN DELANTERA	L 107(mm) RLA H 14 x 1,5(mm) DC 12(mm)	EX260200-1	
DUNA DUNA WEEKEND FIORINO FIORINO FURGON FIORINO WORKING PREMIO TEMPRA UNO UNO UNO CARGO	1988/01 1991/01 1996/00 1994/15 1997/00 1999/01 1994/98 1992/96 2002/15 2002/16	EXTREMO DE DIRECCIÓN DELANTERA	L 137(mm) RLA H 14 x 1,5(mm) DC 12(mm)	EX260300	
DUNA DUNA WEEKEND FIORINO FIORINO FURGON FIORINO FURGON FIORINO WORKING PREMIO TEMPRA UNO UNO UNO CARGO	1988/01 1991/01 1996/00 1994/06 2005/15 1997/00 1999/01 1994/98 1992/96 2002/15 2002/16	EXTREMO DE DIRECCIÓN DELANTERA	L 80(mm) RLA H 18 x 1,5(mm) DC 14,5(mm)	EX260301	
DUNA UNO UNO	1988/01 1994/01 2005/09	EXTREMO DE DIRECCIÓN TENSOR	L 80(mm) RLA H 16 x 1,5(mm) DC 14,5(mm)	EX260400	
147 BRIO SPAZIO BR	1983/86 1984/... 1984/...	EXTREMO DE DIRECCIÓN DELANTERA	L 190(mm) RLA H 14 x 1 (mm) DC 12(mm)	EX260500	
DUCATO SIENA	1992/01 2009/17	EXTREMO DE DIRECCIÓN DELANTERA	L 120(mm) RLA H 16 x 1,5(mm) DC 14,6(mm)	EX270100	
FIORINO FURGON GRAND SIENA MOBI NUEVO UNO PALIO PALIO (326) BR PALIO ADVENTURE	2014/23 2012/23 2016/23 2010/17 1997/10 2012/15 2005/10	EXTREMO DE DIRECCIÓN DELANTERA DERECHA	L 145(mm) RLA H 14 x 1,5(mm) DC 12(mm)	EX270500D	



**EXTREMOS DE DIRECCIÓN**

TERMINAIS DE DIREÇÃO / STEERING SYSTEM

FIAT					
	Año Ano   Year	Descripción Sistema Descrição   Descrição	Medidas Medidas   Measures	Código Código   Code	Imagen Imagem   Image
PALIO FASE II	2007/12	EXTREMO DE DIRECCIÓN	L 145(mm)	EX270500D	
PALIO FASE III	2010/22	DELANTERA DERECHA	RLA H 14 x 1,5(mm)		
PALIO RSTII	2008/09		DC 12(mm)		
PALIO WEEKEND	1997/11				
SIENA	1997/17				
STRADA	1999/02				
STRADA ADVENTURE	2005/23				
STRADA WORKING	2002/...				
UNO WAY	2009/10				
FIORINO FURGON	2014/23	EXTREMO DE DIRECCIÓN	L 145(mm)	EX270500I	
GRAND SIENA	2012/23	DELANTERA IZQUIERDA	RLA H 14 x 1,5(mm)		
MOBI	2016/23		DC 12(mm)		
NUEVO UNO	2010/17				
PALIO	1997/10				
PALIO (326) BR	2012/15				
PALIO ADVENTURE	2005/10				
PALIO FASE II	2007/12				
PALIO FASE III	2010/22				
PALIO RSTII	2008/09				
PALIO WEEKEND	1997/11				
SIENA	1997/17				
STRADA	1999/02				
STRADA ADVENTURE	2005/23				
STRADA WORKING	2002/...				
UNO WAY	2009/10				
QUBO	2012/16	EXTREMO DE DIRECCIÓN	L 113(mm)	EX271700D	
LINEA	2009/18	DELANTERA DERECHA	RLA H 14 x 1,5(mm)		
PUNTO	2007/20		DC 12(mm)		
QUBO	2012/16	EXTREMO DE DIRECCIÓN	L 113(mm)	EX271700I	
LINEA	2009/18	DELANTERA IZQUIERDA	RLA H 14 x 1,5(mm)		
PUNTO	2007/20		DC 12(mm)		
IDEA	2005/...	EXTREMO DE DIRECCIÓN	L 150(mm)	EX271900	
		DELANTERA	RLA H 14 x 1,5(mm)		
			DC 11,8(mm)		
FORD					
GALAXY	1991/...	EXTREMO DE DIRECCIÓN	L 75(mm)	EX230000	
		DELANTERA	RLA H 14 x 1,5(mm)		
			DC 10,8(mm)		
TAUNUS	1974/85	EXTREMO DE DIRECCIÓN	L 75(mm)	EX300300	
		DELANTERA	RLA H 14 x 2(mm)		
			DC 12,8(mm)		

**EXTREMOS DE DIRECCIÓN**

TERMINAIS DE DIREÇÃO / STEERING SYSTEM

FIAT					
	Año Ano   Year	Descripción Sistema Descrição   Descrição	Medidas Medidas   Measures	Código Código   Code	Imagen Imagen   Image
ESCORT ESCORT CABRIO/COUPE ORION	1994/02 1996/01 1993/98	EXTREMO DE DIRECCIÓN DELANTERA DERECHA	L 80(mm) RLA H 14 x 2(mm) DC 13.2(mm)	EX301400D	
ESCORT ESCORT CABRIO/COUPE ORION	1994/02 1996/01 1993/98	EXTREMO DE DIRECCIÓN DELANTERA IZQUIERDA	L 80(mm) RLA H 14 x 2(mm) DC 13.2(mm)	EX301400I	
F100	1984/85	EXTREMO DE DIRECCIÓN DELANTERA LARGO DERECHA	L 366(mm) RA M 7/8" x 18 DC 15,6(mm)	EX310000D	
COURIER VAN/PICK UP KA FIESTA	1997/06 1996/01 1994/03	EXTREMO DE DIRECCIÓN DELANTERA DERECHA	L 75(mm) RLA H 14 x 2(mm) DC 11,7(mm)	EX320000D	
COURIER VAN/PICK UP KA FIESTA	1997/06 1996/01 1994/03	EXTREMO DE DIRECCIÓN DELANTERA IZQUIERDA	L 75(mm) RLA H 14 x 2(mm) DC 11,7(mm)	EX320000I	
EXPLORER RANGER	1991/02 1997/12	EXTREMO DE DIRECCIÓN DELANTERA	L 120 (mm) RLA H 14 x 1.5 (mm) DC 14.86 (mm)	EX320100	
ECOSPORT2 4x2 ECOSPORT2 4x4 FIESTA KINETIC NEW FIESTA NOVO KA	2012/18 2013/22 2010/22 2010/13 2014/18	EXTREMO DE DIRECCIÓN DELANTERA DERECHO	L 94 (mm) RLA M14 x 1,5(mm) DC	EX324600D	
ECOSPORT2 4x2 ECOSPORT2 4x4 FIESTA KINETIC NEW FIESTA NOVO KA	2012/18 2013/22 2010/22 2010/13 2014/18	EXTREMO DE DIRECCIÓN DELANTERA IZQUIERDO	L 94 (mm) RLA M14 x 1,5(mm) DC	EX324600I	
TRANSIT	1996/01	EXTREMO DE DIRECCIÓN DELANTERA	L 100(mm) RLA H 16 x 1,5(mm) DC 18(mm)	EX330300	
ECOSPORT KA FIESTA FIESTA MAX	2003/13 2008/14 2002/13 2002/13	EXTREMO DE DIRECCIÓN DELANTERA DERECHA	L 95(mm) RLA H 14 x 1,5(mm) DC 11,8(mm)	EX340200D	
ECOSPORT KA FIESTA FIESTA MAX	2003/13 2008/14 2002/13 2002/13	EXTREMO DE DIRECCIÓN DELANTERA IZQUIERDA	L 95(mm) RLA H 14 x 1,5(mm) DC 11,8(mm)	EX340200I	

**EXTREMOS DE DIRECCIÓN**

TERMINAIS DE DIREÇÃO / STEERING SYSTEM

FORD					
	Año Ano   Year	Descripción Sistema Descrição   Descrição	Medidas Medidas   Measures	Código Código   Code	Imagen Imagen   Image
COURIER VAN/PICK UP	1997/00	EXTREMO DE DIRECCIÓN	L 70(mm)	EX340200-1	
FIESTA	1994/97	DELANTERA IZQUIERDA	RLA H 1/2 x 2.0(mm)		
KA	1997/08		DC 11,5(mm)		
FOCUS	2000/10	EXTREMO DE DIRECCIÓN DELANTERA DERECHA	L 80(mm)	EX340300D	
			RLA H 14 x 2(mm)		
			DC 13,3(mm)		
FOCUS	2000/10	EXTREMO DE DIRECCIÓN DELANTERA IZQUIERDA	L 80(mm)	EX340300I	
			RLA H 14 x 2(mm)		
			DC 13,3(mm)		
FOCUS I	2008/14	EXTREMO DE DIRECCIÓN DELANTERA DERECHA	L 100(mm)	EX340400D	
			RLA H 14 x 1,5(mm)		
			DC 12,5(mm)		
FOCUS I	2008/14	EXTREMO DE DIRECCIÓN DELANTERA IZQUIERDA	L 100(mm)	EX340400I	
			RLA H 14 x 1,5(mm)		
			DC 12,5(mm)		
F-100	1992/...	EXTREMO DE DIRECCIÓN	L 245 (mm)	EX340900D	
F-150	1992/...	DELANTERA LARGO	RA M 1" x 16		
F-1000	1992/...	DERECHA	DC 15,6(mm)		
F-100	1992/...	EXTREMO DE DIRECCIÓN	L 135 (mm)	EX340900I	
F-150	1992/...	DELANTERA CORTO	RA M 7/8" x 16		
F-1000	1992/...	IZQUIERDA	DC 15,6(mm)		
F-100	1999/12	EXTREMO DE DIRECCIÓN	L 184 (mm)	EX340901D	
F-150	1996/00	DELANTERA CORTO	RA M 1" x 16		
F-4000	1999/12	DERECHA	DC 15,6(mm)		
F-4000	1996/00				
F-100	1999/12	EXTREMO DE DIRECCIÓN	L 184 (mm)	EX340901I	
F-150	1996/00	DELANTERA CORTO	RA M 7/8" x 16		
F-4000	1999/12	IZQUIERDA	DC 15,6(mm)		
F-4000	1996/00				
IZUSU					
PICKUP	1993/99	EXTREMO DE DIRECCIÓN DELANTERA EXTERIOR	L 74 (mm)	EX240700E	
			RLA H14 x 1,5 (mm)		
			DC 16 (mm)		
PICKUP	1993/99	EXTREMO DE DIRECCIÓN DELANTERA INTERIOR	L 74 (mm)	EX240700I	
			RLA H14 x 1,5 (mm)		
			DC 16 (mm)		







**EXTREMOS DE DIRECCIÓN**

TERMINAIS DE DIREÇÃO / STEERING SYSTEM

IVECO					
	Año Ano   Year	Descripción Sistema Descrição   Descrição	Medidas Medidas   Measures	Código Código   Code	Imagen Imagen   Image
DAILY	1991/...	EXTREMO DE DIRECCIÓN DELANTERA	L 74(mm) RLA H 14 x 1,5(mm) DC 16(mm)	EX271100	
KIA					
BESTA	1990/...	EXTREMO DE DIRECCIÓN DELANTERA	L 160(mm) RLA H 14 x 1,5(mm) DC 14(mm)	EX910000	
LANCIA					
MUSA	2004/12	EXTREMO DE DIRECCIÓN DELANTERA	L 150(mm) RLA H 14 x 1,5(mm) DC 11,8(mm)	EX271900	
MERCEDES BENZ					
SPRINTER SPRINTER	1996/02 2002/14	EXTREMO DE DIRECCIÓN DELANTERA	L 75(mm) RLA H 16 x 1,5(mm) DC 18,1(mm)	EX351200	
SPRINTER II SPRINTER II	2012/16 2016/22	EXTREMO DE DIRECCIÓN DELANTERA	L 75(mm) RLA H 16 x 1,5(mm) DC 18,1(mm)	EX351200-1	
PEUGEOT					
BOXER FURGON	1992/06	EXTREMO DE DIRECCIÓN DELANTERO	L 122 (mm) RLA H 16 x 1,5(mm) DC 16,5 (mm)	EX252900	
BOXER FURGON BOXER COMBI BOXER FURGON BOXER COMBI	1995/04 1998/04 1995/04 1998/04	EXTREMO DE DIRECCIÓN DELANTERA	L 120(mm) RLA H 16 x 1,5 (mm) DC 14,6 (mm)	EX270100	
205 306 306 CABRIO 306 COUPE 504 505 PARTNER	1992/00 1996/02 1997/02 1995/99 1983/00 1983/96 1998/...	EXTREMO DE DIRECCIÓN DELANTERA	L 95(mm) RLA M 14 x 1,5 (mm) DC 12,6 (mm)	EX450300	
106 206 207 207 COMPACT 307 605 HOGGAR	1995/02 1999/09 2008/15 2008/17 2001/12 1992/97 2011/16	EXTREMO DE DIRECCIÓN DELANTERA DERECHA	L 125(mm) RLA M 14 x 1,5(mm) DC 12,6(mm)	EX452100D	













**EXTREMOS DE DIRECCIÓN**

TERMINAIS DE DIREÇÃO / STEERING SYSTEM

PEUGEOT					
	Año Ano   Year	Descripción Sistema Descrição   Descrição	Medidas Medidas   Measures	Código Código   Code	Imagen Imagem   Image
106	1995/02	EXTREMO DE DIRECCIÓN	L 125(mm)	EX452100I	
206	1999/09	DELANTERA IZQUIERDA	RLA M 14 x 1,5(mm)		
207	2008/15		DC 12,6(mm)		
207 COMPACT	2008/17				
307	2001/12				
605	1992/97				
HOGGAR	2011/16				
405	1991/03	EXTREMO DE DIRECCIÓN	L 230(mm)	EX460200D	
405/FAMILIAR	1991/98	DELANTERA DERECHA	RLA M 14 x 1,5(mm)		
			DC 12,2(mm)		
405	1991/03	EXTREMO DE DIRECCIÓN	L 230(mm)	EX460200I	
405/FAMILIAR	1991/98	DELANTERA IZQUIERDA	RLA M 14 x 1,5(mm)		
			DC 12,2(mm)		
806	1993/98	EXTREMO DE DIRECCIÓN	L 70(mm)	EX472000	
EXPERT	1999/06	DELANTERA	RLA M 14 x 1,5(mm)		
			DC 12,7(mm)		
208	2012/...	EXTREMO DE DIRECCIÓN	L 203(mm)	EX472200D	
2008	2013/...	DELANTERA DERECHA	RLA M 14 x 1,5(mm)		
			DC M10 x 1.25 (mm)		
208	2012/...	EXTREMO DE DIRECCIÓN	L 203(mm)	EX47220I	
2008	2013/...	DELANTERA IZQUIERDA	RLA M 14 x 1,5(mm)		
			DC M10 x 1.25 (mm)		
RENAULT					
R12	1983/99	EXTREMO DE DIRECCIÓN	L 235(mm)	EX550400D	
DACIA	1971/94	DELANTERA DERECHA	RLA		
SEDAN	1996/...		DC 12,2(mm)		
R12	1983/99	EXTREMO DE DIRECCIÓN	L 235(mm)	EX550400I	
DACIA	1971/94	DELANTERA IZQUIERDA	RLA		
SEDAN	1996/...		DC 12,2(mm)		
R4	1962/90	EXTREMO DE DIRECCIÓN	L 230(mm)	EX550500D	
R6	1969/80	DELANTERA DERECHA	RLA		
R5	1972/84		DC 10,7(mm)		
4S	1962/90				
R4	1962/90	EXTREMO DE DIRECCIÓN	L 230(mm)	EX550500I	
R6	1969/80	DELANTERA IZQUIERDA	RLA		
R5	1972/84		DC 10,7(mm)		
4S	1962/90				











**EXTREMOS DE DIRECCIÓN**

TERMINAIS DE DIREÇÃO / STEERING SYSTEM

RENAULT					
	Año Ano   Year	Descripción Sistema Descrição   Descrição	Medidas Medidas   Measures	Código Código   Code	Imagen Imagen   Image
R9 R11 R18 EXPRESS FUEGO	1987/92 1984/99 1983/95 1995/02 1981/92	EXTREMO DE DIRECCIÓN DELANTERO	L 95(mm) RLA M 14 x 1,5(mm) DC 12,2(mm)	EX550600	
R21 R21 NEVADA R21 ALIZE	1991/97 1990/97 1990/97	EXTREMO DE DIRECCIÓN DELANTERO	L 110(mm) RLA M 14 x 1,5(mm) DC 12,2(mm)	EX550600-1	
R19 BICUERPO R19 CABRIO / COUPE R19 TRICUERPO R9 TURQUIA	1993/01 1989/97 1989/01 1992/97	EXTREMO DE DIRECCIÓN DELANTERO DERECHA	L 110(mm) RLA M 14 x 1,5(mm) DC 12,2(mm)	EX560400D	
R19 BICUERPO R19 CABRIO / COUPE R19 TRICUERPO R9 TURQUIA	1993/01 1989/97 1989/01 1992/97	EXTREMO DE DIRECCIÓN DELANTERO IZQUIERDA	L 110(mm) RLA M 14 x 1,5(mm) DC 12,2(mm)	EX560400I	
TWINGO	1992/03	EXTREMO DE DIRECCIÓN DELANTERO DERECHA	L 110 (mm) RLA H 14 x 1,5 (mm) DC 12,2 (mm)	EX570000D	
TWINGO	1992/03	EXTREMO DE DIRECCIÓN DELANTERO IZQUIERDA	L 110 (mm) RLA H 14 x 1,5 (mm) DC 12,2 (mm)	EX570000I	
LAGUNA LAGUNA II	1996/01 1998/02	EXTREMO DE DIRECCIÓN DELANTERA DERECHA	L 180(mm) RLA H 14 x 1,5(mm) DC 12(mm)	EX570400D	
LAGUNA LAGUNA II	1996/01 1998/02	EXTREMO DE DIRECCIÓN DELANTERA IZQUIERDA	L 180(mm) RLA H 14 x 1,5(mm) DC 12(mm)	EX570400I	
LOGAN SANDERO/STEPWAY	2007/14 2008/15	EXTREMO DE DIRECCIÓN DELANTERA DERECHA	L 215(mm) RLA H 14 x 1,5(mm) DC 12(mm)	EX571000D	
LOGAN SANDERO/STEPWAY	2007/14 2008/15	EXTREMO DE DIRECCIÓN DELANTERA IZQUIERDA	L 215(mm) RLA H 14 x 1,5(mm) DC 12(mm)	EX571000I	
CLIO KANGOO MEGANE MEGANE CABRIO/COUPE SCENIC	1995/98 1998/01 1997/99 1997/00 1998/01	EXTREMO DE DIRECCIÓN DELANTERA DERECHA	L 130(mm) RLA H 14 x 1,5(mm) DC 12(mm)	EX580100D	

**EXTREMOS DE DIRECCIÓN**











TERMINAIS DE DIREÇÃO / STEERING SYSTEM

RENAULT					
	Año Ano   Year	Descripción Sistema Descrição   Descrição	Medidas Medidas   Measures	Código Código   Code	Imagen Imagem   Image
CLIO KANGOO MEGANE MEGANE CABRIO/COUPE SCENIC	1995/98 1998/01 1997/99 1997/00 1998/01	EXTREMO DE DIRECCIÓN DELANTERA IZQUIERDA	L 130(mm) RLA H 14 x 1,5(mm) DC 12(mm)	EX580100I	
CLIO II CLIO III KANGOO KANGOO II MEGANE II SCENIC SYMBOL	1999/11 2001/09 1999/22 2003/14 1997/09 1998/03 2009/13	EXTREMO DE DIRECCIÓN DERECHA	L 91,6(mm) RLA H 14 x 1,5(mm) DC 12(mm)	EX580200D	
CLIO II CLIO III KANGOO KANGOO II MEGANE II SCENIC SYMBOL	1999/11 2001/09 1999/22 2003/14 1997/09 1998/03 2009/13	EXTREMO DE DIRECCIÓN DELANTERA IZQUIERDA	L 91,6(mm) RLA H 14 x 1,5(mm) DC 12(mm)	EX580200I	
MEGANE II SCENIC II	2005/11 2001/11	EXTREMO DE DIRECCIÓN DELANTERA DERECHA	L 200(mm) RLA H 14 x 1,5(mm) DC 12(mm)	EX581300D	
MEGANE II SCENIC II	2005/11 2001/11	EXTREMO DE DIRECCIÓN DELANTERA IZQUIERDA	L 200(mm) RLA H 14 x 1,5(mm) DC 12(mm)	EX581300I	
SEAT					
TOLEDO	2000/05	EXTREMO DE DIRECCIÓN DELANTERO DERECHA	L 94(mm) RLA H 14 x 1,5(mm) DC 13,2(mm)	EX221700D	
TOLEDO	2000/05	EXTREMO DE DIRECCIÓN DELANTERO IZQUIERDA	L 94(mm) RLA H 14 x 1,5(mm) DC 13,2(mm)	EX221700I	
CORDOBA IBIZA	1994/00 1996/00	EXTREMO DE DIRECCIÓN DELANTERA DERECHA	L 80(mm) RLA H 14 x 1,5(mm) DC 12,8(mm)	EX230200D	
CORDOBA IBIZA	1994/00 1996/00	EXTREMO DE DIRECCIÓN DELANTERA IZQUIERDA	L 80(mm) RLA H 14 x 1,5(mm) DC 12,8(mm)	EX230200I	









**EXTREMOS DE DIRECCIÓN**

TERMINAIS DE DIREÇÃO / STEERING SYSTEM

SEAT					
	Año Ano   Year	Descripción Sistema Descrição   Descrição	Medidas Medidas   Measures	Código Código   Code	Imagen Imagen   Image
LEON TOLEDO	2008/11 2008/09	EXTREMO DE DIRECCIÓN DELANTERA DERECHA	L 95(mm) RLA H 16 x 1,5(mm) DC 13,5(mm)	EX231400D	
LEON TOLEDO	2008/11 2008/09	EXTREMO DE DIRECCIÓN DELANTERA IZQUIERDA	L 95(mm) RLA H 16 x 1,5(mm) DC 13,5(mm)	EX231400I	
LEON	2005/...	EXTREMO DE DIRECCIÓN DELANTERA DERECHA	L 95 (mm) RLA H 16 x 1,5(mm) DC 13.3 (mm)	EX233200D	
LEON	2005/....	EXTREMO DE DIRECCIÓN DELANTERA IZQUIERDA	L 95 (mm) RLA H 16 x 1,5(mm) DC 13.3 (mm)	EX233200I	
SUZUKI					
FUN	2003/12	EXTREMO DE DIRECCIÓN DELANTERA	L 75 (mm) RLA H14 x 1,5 (mm) DC 10,8 (mm)	EX241000	
TOYOTA					
HILUX	1989/97	DELANTERO EXTREMO CORTO ROSCA IZQUIERDA	L 90 (mm) RLA H 17 x 1,5(mm) DC 14.6 (mm)	EX910600I	
HILUX	1989/97	EXTREMO DE DIRECCIÓN LARGO ROSCA DERECHA	L 187 (mm) RLA H 17 x 1,5(mm) DC 14.6 (mm)	EX910600E	
HILUX HILUX SW4	1993/01 1996/00	EXTREMO DE DIRECCIÓN DELANTERO LARGO	L 228 (mm) RLA M 17 x 1,5(mm) DC 14.6 (mm)	EX923500	
COROLLA	2008/14	EXTREMO DE DIRECCIÓN DELANTERO	L 228 (mm) RLA M 17 x 1,5(mm) DC 14.6 (mm)	EX924000	
HILUX	2005/16	EXTREMO DE DIRECCIÓN DELANTERO	L 83.5 (mm) RLA H 15 x 1,5(mm) DC 15.2 (mm)	EX925400	

**EXTREMOS DE DIRECCIÓN**







TERMINAIS DE DIREÇÃO / STEERING SYSTEM

VOLKSWAGEN					
	Año Ano   Year	Descripción Sistema Descrição   Descrição	Medidas Medidas   Measures	Código Código   Code	Imagen Imagem   Image
GACEL	1983/94	EXTREMO DE DIRECCIÓN DELANTERA	L 100(mm)	EX220600	
GOL	1991/03		RLA H 14 x 1,5(mm)		
GOL COUNTRY	1995/09		DC 11(mm)		
GOL COUNTRY	1998/23				
GOL	1998/11				
SAVEIRO	1990/01				
SAVEIRO	2002/10				
SENDA	1989/97				
BORA	2000/16	EXTREMO DE DIRECCIÓN DELANTERA DERECHA	L 94(mm)	EX221700D	
GOLF	1996/02		RLA H 14 x 1,5(mm)		
GOLF CABRIO	1996/99		DC 13,2(mm)		
NEW BEETLE	1999/10				
BORA	2000/16	EXTREMO DE DIRECCIÓN DELANTERA IZQUIERDA	L 94(mm)	EX221700I	
GOLF	1996/02		RLA H 14 x 1,5(mm)		
GOLF CABRIO	1996/99		DC 13,2(mm)		
NEW BEETLE	1999/10				
CROSSFOX	2005/16	EXTREMO DE DIRECCIÓN DELANTERA DERECHA	L 94(mm)	EX224000D	
FOX	2003/22		RLA H 14 x 1,5(mm)		
GOL TREND	2008/23		DC 13,2(mm)		
GOL TREND IMOTION	2008/21				
POLO CLASSIC	2001/09				
SAVEIRO	2003/10				
SURAN	2006/22				
SURAN TRACK	2017/23				
SURANCROSS	2011/23				
UP!	2014/23				
VOYAGE	2008/19				
CROSSFOX	2005/16	EXTREMO DE DIRECCIÓN DELANTERA IZQUIERDA	L 94(mm)	EX224000I	
FOX	2003/22		RLA H 14 x 1,5(mm)		
GOL TREND	2008/23		DC 13,2(mm)		
GOL TREND IMOTION	2008/21				
POLO CLASSIC	2001/09				
SAVEIRO	2003/10				
SURAN	2006/22				
SURAN TRACK	2017/23				
SURANCROSS	2011/23				
UP!	2014/23				
VOYAGE	2008/19				
CARAT	1987/92	EXTREMO DE DIRECCIÓN DELANTERA	L 75(mm)	EX230000	
QUANTUM	1986/96		RLA H 14 x 1,5(mm)		
SANTANA	2002/07		DC 10,8(mm)		

**EXTREMOS DE DIRECCIÓN**





TERMINAIS DE DIREÇÃO / STEERING SYSTEM

**VOLKSWAGEN**

	<b>Año</b> Ano   Year	<b>Descripción Sistema</b> Descrição   Descrição	<b>Medidas</b> Medidas   Measures	<b>Código</b> Código   Code	<b>Imagen</b> Imagem   Image
GACEL GOL GOL GOL COUNTRY GOL COUNTRY SAVEIRO SENDA	1983/94 1991/11 2011/23 1995/11 2011/23 1991/10 1989/97	EXTREMO DE DIRECCIÓN DELANTERA	<b>L</b> 59(mm) <b>RLA</b> H 14 x 1,5(mm) <b>DC</b> 10,8(mm)	<b>EX230100</b>	
CADDY GOLF GOLF CABRIO POLO CLASSIC	1998/10 1995/99 1990/95 1996/01	EXTREMO DE DIRECCIÓN DELANTERA DERECHA	<b>L</b> 80(mm) <b>RLA</b> H 14 x 1,5(mm) <b>DC</b> 12,8(mm)	<b>EX230200D</b>	
CADDY GOLF GOLF CABRIO POLO CLASSIC	1998/10 1995/99 1990/95 1996/01	EXTREMO DE DIRECCIÓN DELANTERA IZQUIERDA	<b>L</b> 80(mm) <b>RLA</b> H 14 x 1,5(mm) <b>DC</b> 12,8(mm)	<b>EX230200I</b>	
PASSAT PASSAT VARIANT	1995/05 1998/05	EXTREMO DE DIRECCIÓN DELANTERO	<b>L</b> 160(mm) <b>RLA</b> M 14 x 1,5(mm) <b>DC</b> 17,44(mm)	<b>EX230900</b>	
CROSSFOX FOX GOL TREND GOL TREND IMOTION GOL TREND IMOTION POLO CLASSIC SAVEIRO SURAN SURAN TRACK SURANCROSS UP! VOYAGE	2005/16 2003/22 2008/23 2008/17 2019/21 2001/09 2003/10 2006/22 2017/23 2011/23 2014/23 2008/19	EXTREMO DE DIRECCIÓN DELANTERA DERECHA	<b>L</b> 94(mm) <b>RLA</b> H 14 x 1,5(mm) <b>DC</b> 12,61(mm)	<b>EX231100D</b>	
CROSSFOX FOX GOL TREND GOL TREND IMOTION GOL TREND IMOTION POLO CLASSIC SAVEIRO SURAN SURAN TRACK SURANCROSS UP! VOYAGE	2005/16 2003/22 2008/23 2008/17 2019/21 2001/09 2003/10 2006/22 2017/23 2011/23 2014/23 2008/19	EXTREMO DE DIRECCIÓN DELANTERA IZQUIERDA	<b>L</b> 94(mm) <b>RLA</b> H 14 x 1,5(mm) <b>DC</b> 12,61(mm)	<b>EX231100I</b>	











**EXTREMOS DE DIRECCIÓN**

TERMINAIS DE DIREÇÃO / STEERING SYSTEM

VOLKSWAGEN					
	Año Ano   Year	Descripción Sistema Descrição   Descrição	Medidas Medidas   Measures	Código Código   Code	Imagen Imagem   Image
GOLF VARIANT	1999/12	EXTREMO DE DIRECCIÓN	L 95(mm)	EX231400D	
GOLF	2003/04	DELANTERA DERECHA	RLA H 16 x 1,5(mm)		
PASSAT	2006/11		DC 13,5(mm)		
TIGUAN	2009/11				
VENTO	2006/11				
TIGUAN	2008/17				
GOLF VI	2011/23				
SCIROCCO	2012/17				
GOLF VARIANT	1999/12	EXTREMO DE DIRECCIÓN	L 95(mm)	EX231400I	
GOLF	2003/04	DELANTERA IZQUIERDA	RLA H 16 x 1,5(mm)		
PASSAT	2006/11		DC 13,5(mm)		
TIGUAN	2009/11				
VENTO	2006/11				
TIGUAN	2008/17				
GOLF VI	2011/23				
SCIROCCO	2012/17				
AMAROK	2009/17	EXTREMO DE DIRECCIÓN	L 90(mm)	EX232400D	
AMAROK 4X2	2017/23	DELANTERA DERECHA	RLA M 16 x 1,5(mm)		
AMAROK 4X4	2012/23		DC		
TOUAREG	2002/10				
AMAROK	2009/17	EXTREMO DE DIRECCIÓN	L 90(mm)	EX232400I	
AMAROK 4X2	2017/23	DELANTERA IZQUIERDA	RLA M 16 x 1,5(mm)		
AMAROK 4X4	2012/23		DC		
TOUAREG	2002/10				
PASSAT	2011/...	EXTREMO DE DIRECCIÓN	L 95(mm)	EX233200D	
SCIROCCO	2005/...	DELANTERA DERECHA	RLA H 16 x 1,5(mm)		
SHARAN	2005/...		DC 13.3 (mm)		
TIGUAN	2005/...				
VENTO	2011/...				
PASSAT	2011/...	EXTREMO DE DIRECCIÓN	L 95(mm)	EX233200I	
SCIROCCO	2005/...	DELANTERA IZQUIERDA	RLA H 16 x 1,5(mm)		
SHARAN	2005/...		DC 13.3 (mm)		
TIGUAN	2005/...				
VENTO	2011/...				
POINTER	1993/97	EXTREMO DE DIRECCIÓN	L 80(mm)	EX301400D	
		DELANTERA DERECHA	RLA H 14 x 2(mm)		
			DC 13.2(mm)		
POINTER	1993/97	EXTREMO DE DIRECCIÓN	L 80(mm)	EX301400I	
		DELANTERA IZQUIERDA	RLA H 14 x 2(mm)		
			DC 13.2(mm)		









**ARTICULACIÓN AXIAL**

ARTICULAÇÕES AXIAIS / AXIAL JOINTS

ALFA ROMEO					
	Año Ano   Year	Descripción Sistema Descrição   Descrição	Medidas Medidas   Measures	Código Código   Code	Imagen Imagen   Image
156 156 SPORTWAGON GT	1998/03 2001/03 2007/09	ARTICULACIÓN AXIAL DELANTERO	L 218 (mm) RLC M16 x 1,5 (mm) RLE M14 x 1,5 (mm)	AX270600	
MITO	2009/21	ARTICULACIÓN AXIAL DELANTERO	L 275 (mm) RLC M14 x 1,5 (mm) RLE M14 x 1,5 (mm)	AX340200	
AUDI					
A3	1997/05	ARTICULACIÓN AXIAL DELANTERO	L 340 (mm) RLC M16 x 1,5 (mm) RLE M14 x 1,5 (mm)	AX221700	
A3 A3 SPORTBACK	2006/08 2005/08	ARTICULACIÓN AXIAL DELANTERO	L 310 (mm) RLC M16 x 1,5 (mm) RLE M16 x 1,5 (mm)	AX231400	
CHEVROLET					
CORSA	1994/97	ARTICULACIÓN AXIAL DELANTERO	L 310 (mm) RLC H14 x 1,5 (mm) RLE M12 x 1,5 (mm)	AX240900	
CELTA TIGRA CORSA 2	2011/17 1998/01 2002/12	ARTICULACIÓN AXIAL DELANTERO	L 320 (mm) RLC H14 x 1,5 (mm) RLE M14 x 1,5 (mm)	AX241800	
CELTA CORSA CORSA CLASSIC PRISMA TIGRA	2001/... 1994/01 2002/... 2002/12 1997/	ARTICULACIÓN AXIAL DELANTERO	L 280 (mm) RLC M14 x 1,5 (mm) RLE M14 x 1,5 (mm)	AX243300	
ASTRA VECTRA SEDAN ZAFIRA	1998/10 2006/12 2001/10	ARTICULACIÓN AXIAL DELANTERO	L 285 (mm) RLC M18 x 1,5 (mm) RLE M14 x 1,5 (mm)	AX290800	
CITROËN					
BERLINGO FURGON BERLINGO MULTISPACE XSARA XSARA PICASSO ZX	1998/23 2002/23 1998/03 1999/12 1993/99	ARTICULACIÓN AXIAL DELANTERO	L 340 (mm) RLC M12 x 1 (mm) RLE H14 x 1,5 (mm)	AX470600	
C4	2007/14	ARTICULACIÓN AXIAL DELANTERO	L 340 (mm) RLC M14 x 1,5 (mm) RLE H14 x 1,5 (mm)	AX471200	











**ARTICULACIÓN AXIAL**

ARTICULAÇÕES AXIAIS / AXIAL JOINTS

CITROËN					
	Año Ano   Year	Descripción Sistema Descrição   Descrição	Medidas Medidas   Measures	Código Código   Code	Imagen Imagen   Image
C3 PICASSO	2013/...	ARTICULACIÓN AXIAL	L 225 (mm)	AX472200	
C-ELYSEÉ	2016/...	DELANTERO	RLC M12 x 1 (mm)		
			RLE M16 x 1,5 (mm)		
DAEWOO					
MATIZ	1998/03	ARTICULACIÓN AXIAL	L 252 (mm)	AX940000	
TICO	1995/97	DELANTERO	RLC M16 x 1 (mm)		
			RLE M12 x 1,5 (mm)		
FIAT					
128	1983/91	ARTICULACIÓN AXIAL	L 130 (mm)	AX250400	
UNO	1984/...	DELANTERO	RLC H14 x 1,5 (mm)		
PREMIO BRASIL	1984/...		RLE M14 x 1,0 (mm)		
REGATTA	1985/94	ARTICULACIÓN AXIAL	L 270 (mm)	AX250900	
REGATTA WEEKEND	1985/95	DELANTERO	RLC H14 x 1,5 (mm)		
			RLE M12 x 1,5 (mm)		
147	1983/84	ARTICULACIÓN AXIAL	L 190 (mm)	AX260200	
128 EUROPA / SUPER	1983/91	DELANTERO	RLC H14 x 1,5 (mm)		
BRIO	1987/91		RLE M12 x 1,5 (mm)		
DUNA	1988/01				
DUNA WEEKEND	1988/95				
FIORINO/PICKUP	1989/97				
SPAZIO	1991/92				
UNO	1988/94				
147 VIVACE	1992/97	ARTICULACIÓN AXIAL	L 215 (mm)	AX260300	
DUNA	1988/01	DELANTERO	RLC H14 x 1,5 (mm)		
DUNA WEEKEND	1999/01		RLE M14 x 1,5 (mm)		
FIORINO	1996/00				
FIORINO FURGON	2002/15				
PREMIO	1999/01				
SPAZIO	1991/97				
UNO	1991/15				
UNO CARGO	2002/16				
DUCATO	1992/01	ARTICULACIÓN AXIAL	L 318 (mm)		
DUCATO	1998/05	DELANTERO	RLC M16 x 1,5 (mm)		
			RLE M16 x 1,5 (mm)		
PALIO	1997/10	ARTICULACIÓN AXIAL	L 282 (mm)	AX270200	
PALIO FASE II	2007/12	DELANTERO	RLC M14 x 1,5 (mm)		
PALIO ADVENTURE	2005/10		RLE M14 x 1,5 (mm)		
PALIO WEEKEND	1997/10				
SIENA	1997/11				
STRADA	1999/02				
STRADA ADVENTURE	2005/11				

**ARTICULACIÓN AXIAL**











ARTICULAÇÕES AXIAIS / AXIAL JOINTS

FIAT					
	Año Ano   Year	Descripción Sistema Descrição   Descrição	Medidas Medidas   Measures	Código Código   Code	Imagen Imagem   Image
STRADA WORKING	2002/05	ARTICULACIÓN AXIAL DELANTERO	L 282 (mm) RLC M14 x 1,5 (mm) RLE M14 x 1,5 (mm)	AX270200	
PALIO	1997/10	ART. AXIAL HIDRÁULICA DELANTERO	L 285 (mm) RLC M14 x 1,5 (mm) RLE M14 x 1,5 (mm)	AX270500	
PALIO ADVENTURE	2005/10				
PALIO FASE II	2007/12				
PALIO WEEKEND	1997/03				
PALIO WEEKEND	2005/10				
SIENA	1997/11				
STRADA	1999/02				
STRADA ADVENTURE	2005/11				
STRADA WORKING	2002/05				
DUNA	1992/96	ART. AXIAL HIDRÁULICA DELANTERO	L 215 (mm) RLC H14 x 1,5 (mm) RLE M14 x 1,5 (mm)	AX270500-1	
FIORINO PICK-UP	1991/13				
UNO FIRE	2003/...				
IDEA	2005/...	ARTICULACIÓN AXIAL DELANTERO	L 258 (mm) RLC H14 x 1,5 (mm) RLE M14 x 2 (mm)	AX271900	
LINEA	2009/18	ARTICULACIÓN AXIAL DELANTERO	L 278 (mm) RLC M14 x 1,5 (mm) RLE M14 x 1,5 (mm)	AX340200	
PUNTO	2007/20				
FORD					
COURIER	1996/04	ARTICULACIÓN AXIAL DELANTERO	L 300 (mm) RLC M14 x 1,5 (mm) RLE M12 x 1,25 (mm)	AX310800	
COURIER PICK UP	1997/06				
FIESTA	1994/03				
ESCORT	1997/...				
ECOSPORT	2003/13	ARTICULACIÓN AXIAL DELANTERO	L 278 (mm) RLC M14 x 1,5 (mm) RLE M14 x 1,5 (mm)	AX340200	
FIESTA	2002/13				
FIESTA MAX	2002/13				
JEEP					
COMPASS	2006/16	ARTICULACIÓN AXIAL DELANTERO	L 305 (mm) RLC M14 x 1,5 (mm) RLE M14 x 1,5 (mm)	AX581700	
PATRIOT	2009/...				
KIA					
BESTA	1990/97	ARTICULACIÓN AXIAL DELANTERO	L 184 (mm) RLC M17 x 1 (mm) RLE M14 x 1,5 (mm)	AX910000	















**ARTICULACIÓN AXIAL**

ARTICULAÇÕES AXIAIS / AXIAL JOINTS

MAZDA					
	Año Ano   Year	Descripción Sistema Descrição   Descrição	Medidas Medidas   Measures	Código Código   Code	Imagen Imagen   Image
E2000	1984/88	ARTICULACIÓN AXIAL DELANTERO	L 184 (mm) RLC M17 x 1 (mm) RLE M14 x 1,5 (mm)	AX910000	
MERCEDES BENZ					
SPRINTER	1996/02	ARTICULACIÓN AXIAL DELANTERO	L 380 (mm) RLC M16 x 1,5 (mm) RLE M16 x 1,5 (mm)	AX351200	
SPRINTER	2002/14				
PEUGEOT					
BOXER FURGON	1995/06	ARTICULACIÓN AXIAL DELANTERO	L 318 (mm) RLC M16 x 1,5 (mm) RLE M16 x 1,5 (mm)	AX270100	
BOXER FURGON/COMBI	1998/04				
405/FAMILIAR	1991/98	ARTICULACIÓN AXIAL DELANTERO	L 185 (mm) RLC M12 x 1 (mm) RLE M14 x 1,5 (mm)	AX451900	
405	1992/03				
206	2001/09	ARTICULACIÓN AXIAL DELANTERO	L 301 (mm) RLC M14 x 1,5 (mm) RLE H14 x 1,5 (mm)	AX452100	
206	1999/13				
207	2008/15				
207 COMPACT	2008/17				
HOGGAR	2011/16				
306	1995/03	ARTICULACIÓN AXIAL DELANTERO	L 340 (mm) RLC M12 x 1 (mm) RLE H14 x 1,5 (mm)	AX470600	
306 CABRIO	1995/02				
306 COUPE	1995/00				
PARTNER FURGON	1998/23				
307	2001/12	ARTICULACIÓN AXIAL DELANTERO	L 340 (mm) RLC M14 x 1,5 (mm) RLE H14 x 1,5 (mm)	AX471200	
306	1998/03	ARTICULACIÓN AXIAL DELANTERO	L 353 (mm) RLC M12 x 1 (mm) RLE H14 x 1,5 (mm)	AX460700	
306 COUPE	1995/00				
306 CABRIO	1997/02				
208	2013/...	ARTICULACIÓN AXIAL DELANTERO	L 225 (mm) RLC M12 x 1 (mm) RLE M16 x 1,5 (mm)	AX472200	
2008	2016/...				
RENAULT					
SYMBOL	2009/...	ARTICULACIÓN AXIAL DELANTERO	L 280 (mm) RLC M14 x 1,5 (mm) RLE M14 x 1,5 (mm)	AX243300	











**ARTICULACIÓN AXIAL**

ARTICULAÇÕES AXIAIS / AXIAL JOINTS

RENAULT					
	Año Ano   Year	Descripción Sistema Descrição   Descrição	Medidas Medidas   Measures	Código Código   Code	Imagen Imagem   Image
R18 FUEGO	1983/99 1981/92	ARTICULACIÓN AXIAL DELANTERO	L 220 (mm) RLC M12 x 1 (mm) RLE H14 x 1,5 (mm)	AX550600	
R9 R11	1988/03 1984/99	ARTICULACIÓN AXIAL DELANTERO	L 280 (mm) RLC M12 x 1 (mm) RLE M14 x 1,5 (mm)	AX550700	
CLIO CLIO RSI CLIO FASE III CLIO WILLAMS	1991/00 1995/98 1996/98 1994/96	ARTICULACIÓN AXIAL DELANTERO	L 235 (mm) RLC M12 x 1 (mm) RLE H14 x 1,5 (mm)	AX560500	
SCENIC MEGANE MEGANE II	1998/03 1997/00 1997/09	ARTICULACIÓN AXIAL DELANTERO	L 260 (mm) RLC M12 x 1 (mm) RLE M14 x 1,5 (mm)	AX560800	
KANGOO LARGO SYMBOL	.../2007 2008/...	ARTICULACIÓN AXIAL DELANTERO	L 300 (mm) RLC M12 x 1 (mm) RLE M14 x 1,5 (mm)	AX570200	
LAGUNA LAGUNA II LAGUNA NEVADA	1994/99 1998/02 1996/98	ARTICULACIÓN AXIAL DELANTERO	L 265 (mm) RLC M12 x 1 (mm) RLE M14 x 1,5 (mm)	AX570400	
CLIO II CLIO III KANGOO KANGOO KANGOO II SYMBOL	1999/11 2001/09 1999/09 2013/22 2003/14 2009/13	ARTICULACIÓN AXIAL DELANTERO	L 305 (mm) RLC M12 x 1 (mm) RLE M14 x 1,5 (mm)	AX570500	
LAGUNA II	2003/09	ARTICULACIÓN AXIAL DELANTERO	L 218 (mm) RLC M12 x 1 (mm) RLE M14 x 1,5 (mm)	AX570600	
MEGANE II MEGANE II GTOUR SCENIC II	2005/08 2006/11 2001/11	ARTICULACIÓN AXIAL	L 216 (mm) RLC M14 x 1,5 (mm) RLE M14 x 1,5 (mm)	AX570900	
LOGAN SANDERO/STEPWAY	2007/14 2008/15	ARTICULACIÓN AXIAL DELANTERO	L 192 (mm) RLC M12 x 1 (mm) RLE M14 x 1,5 (mm)	AX571000	
KANGOO LOGAN SANDERO	2018/... 2014/... 2014/...	ARTICULACIÓN AXIAL DELANTERO	L 190 (mm) RLC M14 x 1,5 (mm) RLE M14 x 1,5 (mm)	AX571400	





**ARTICULACIÓN AXIAL**

ARTICULAÇÕES AXIAIS / AXIAL JOINTS

RENAULT					
	Año Ano   Year	Descripción Sistema Descrição   Descrição	Medidas Medidas   Measures	Código Código   Code	Imagen Imagem   Image
CAPTUR DUSTER OROCH	2017/... 2011/... 2016/...	ARTICULACIÓN AXIAL DELANTERO	L 205 (mm) RLC M16 x 1,5 (mm) RLE M14 x 1,5 (mm)	AX580000	
CLIO MIO	2014/...	ARTICULACIÓN AXIAL DELANTERO	L 305 (mm) RLC M14 x 1,5 (mm) RLE M14 x 1,5 (mm)	AX581700	
MASTER FURGON	1998/09	ARTICULACIÓN AXIAL DELANTERO	L 175 (mm) RLC M14 x 1,5 (mm) RLE M16 x 1,5 (mm)	AX581800	
SEAT					
LEON TOLEDO	2001/05 2000/05	ARTICULACIÓN AXIAL DELANTERO	L 340 (mm) RLC M16 x 1,5 (mm) RLE M14 x 1,5 (mm)	AX221700	
LEON TOLEDO	2008/11 2008/09	ARTICULACIÓN AXIAL DELANTERO	L 310 (mm) RLC M16 x 1,5 (mm) RLE M16 x 1,5 (mm)	AX231400	
SUZUKI					
FUN	2003/12	ARTICULACIÓN AXIAL DELANTERO	L 320 (mm) RLC H14 x 1.5 (mm) RLE M14 x 1.5 (mm)	AX241800	
TOYOTA					
HILUX HILUX SW4 RAV	2005/16 2005/14 2001/06	ARTICULACIÓN AXIAL DELANTERO	L 285 (mm) RLC M14 x 1.5 (mm) RLE M15 x 1.5 (mm)	AX922300-1	
VOLKSWAGEN					
BORA GOLF GOLF CABRIO NEW BEETLE NEW BEETLE CABRIO	2000/16 1996/02 1996/99 1999/10 2003/10	ARTICULACIÓN AXIAL DELANTERO	L 340 (mm) RLC M16 x 1,5 (mm) RLE M14 x 1,5 (mm)	AX221700	
CADDY GOLF DH	1998/... 1995/98	ARTICULACIÓN AXIAL DELANTERO	L 373 (mm) RLC M14 x 1,5 (mm) RLE M14 x 1,5 (mm)	AX221900	













**ARTICULACIÓN AXIAL**

ARTICULAÇÕES AXIAIS / AXIAL JOINTS

VOLKSWAGEN					
	Año Ano   Year	Descripción Sistema Descrição   Descrição	Medidas Medidas   Measures	Código Código   Code	Imagen Imagem   Image
CROSSFOX	2005/16	ARTICULACIÓN AXIAL DELANTERO	L 300 (mm)	AX224000	
FOX	2003/22		RLC M16 x 1,5 (mm)		
GOL TREND	2008/22		RLE M14 x 1,5 (mm)		
SURAN	2006/22				
SURAN TRACK	2017/22				
SURANCROSS	2011/22				
VOYAGE	2008/22				
BORA	2000/08	ARTICULACIÓN AXIAL DELANTERO	L 322 (mm)	AX231100	
GOLF	1999/07		RLC M16 x 1,5 (mm)		
NEW BEETLE	.../2006		RLE M14 x 1,5 (mm)		
POLO	1996/...				
GOLF VI	2011/14	ARTICULACIÓN AXIAL DELANTERO	L 310 (mm)	AX231400	
GOLF VII	2015/23		RLC M16 x 1,5 (mm)		
PASSAT	2006/16		RLE M16 x 1,5 (mm)		
SCIROCCO	2012/17				
SHARAN II	2010/16				
TIGUAN	2008/17				
VENTO	2006/11				
GOL TREND	2008/18	ARTICULACIÓN AXIAL DELANTERO	L 304 (mm)	AX233100	
SAVEIRO	2010/18		RLC M14 x 1,5 (mm)		
CROSSFOX	2003/...		RLE M14 x 1,5 (mm)		

**BARRAS DE DIRECCIÓN**



BARRAS DE DIREÇÃO / STEERING BARS

FORD					
	Año Ano   Year	Descripción Sistema Descrição   Descrição	Información Adicional Informação   Information	Código Código   Code	Imagen Imagem   Image
F100	1966/83	BARRA DE DIRECCIÓN CON OJAL	L 1019mm RA DC 15,6mm	BD300000	
F100	1966/92	BARRA DE DIRECCIÓN CORTA	L 154mm RA M 7/8" x 18 DC 15,6mm	BD300000C	
F100	1966/84	BARRA DE DIRECCIÓN LARGA	L 440mm RA M 7/8" x 18 DC 15,6mm	BD300000L	
F100	1985/92	BARRA DE DIRECCIÓN CORTA	L 450mm RA M 7/8" x 18 DC 15,6mm	BD310000C	
F100	1985/92	BARRA DE DIRECCIÓN LARGA CON OJAL	L 633mm RA M 7/8" x 18 DC 15,6mm	BD310000L	
F250 F350 F400	1978/... 1978/... 1978/...	BARRA DE DIRECCIÓN CON OJAL CENTRAL	L 1022 mm RA DC 15,6mm	BD321000	
F250 F350 F400	1978/... 1978/... 1978/...	BARRA DE DIRECCIÓN LARGA	L 435 mm RA M 7/8" x 18 DC 15,6mm	BD321000L	
F250 F350 F400	1978/... 1978/... 1978/...	BARRA DE DIRECCIÓN CORTA	L 128 mm RA M 7/8" x 18 DC 15,6mm	BD321000C	
F100 F150 F1000	1992/... 1992/... 1992/...	BARRA DE DIRECCIÓN CORTA	L 441 mm RA M 7/8" x 16 DC 15,6mm	BD340900C	
F100 F150 F1000	1992/... 1992/... 1992/...	BARRA DE DIRECCIÓN LARGA CON OJAL	L 724 mm RA M 1" x 16 DC 15,6mm	BD340900L	
F100	1999/...	BARRA DE DIRECCIÓN CORTA	L 410 mm RA M 7/8" x 16 DC 15,6mm	BD340901C	

**BARRAS DE DIRECCIÓN**







BARRAS DE DIREÇÃO / STEERING BARS

**BARRAS DE DIRECCIÓN**
**FORD**

	<b>Año</b> Ano   Year	<b>Descripción Sistema</b> Descrição   Descripción	<b>Medidas</b> Medidas   Measures	<b>Código</b> Código   Code	<b>Imagen</b> Imagem   Image						
F100	1999/...	BARRA DE DIRECCIÓN LARGA CON OJAL	<table border="1"> <tr> <td>L</td> <td>873 mm</td> </tr> <tr> <td>RA</td> <td>M 1" x 16</td> </tr> <tr> <td>DC</td> <td>15,6mm</td> </tr> </table>	L	873 mm	RA	M 1" x 16	DC	15,6mm	BD340901L	
L	873 mm										
RA	M 1" x 16										
DC	15,6mm										

**CAJAS DE DIRECCIÓN**



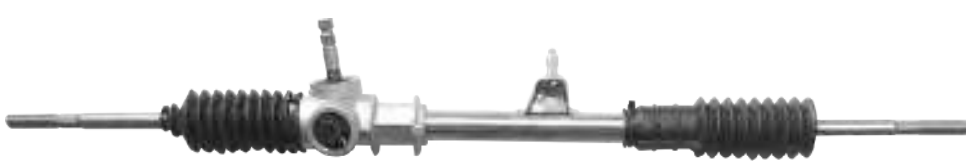



CAIXAS DE DIREÇÃO / STEERING GEAR

FIAT							
	Año Ano   Year	Descripción Sistema Descrição   Decripción	Código Código   Code	Medidas Medidas   Measures			
128 EUROPA	1971/78 1978/83	CAJA MECÁNICA	<b>CM250400</b>	L	RLE	DP	EP
				730 mm	M14 x 1.0 mm	14 mm	17
							
REGATTA	1986/93	CAJA MECÁNICA	<b>CM250900</b>	L	RLE	DP	EP
				1030 mm	M12 x 1.5 mm	14 mm	17
							
REGATTA	1993/...	CAJA MECÁNICA	<b>CM260100</b>	L	RLE	DP	EP
				920 mm	M14 x 1.5 mm	14 mm	17
							
128 SE 147 DUNA FIORINO UNO	1982/91 1988/92 1988/92 1988/92 1988/92	CAJA MECÁNICA	<b>CM260200</b>	L	RLE	DP	EP
				850 mm	M12 x 1.5 mm	14 mm	17
							
UNO DUNA	1993/96 1993/96	CAJA MECÁNICA SIN PERNO	<b>CM260300</b>	L	RLE	DP	EP
				900 mm	M14 x 1.5 mm	14 mm	17
							
UNO DUNA	1996/... 1996/...	CAJA MECÁNICA CON PERNO	<b>CM260300CP</b>	L	RLE	DP	EP
				900 mm	M14 x 1.5 mm	14 mm	17
							



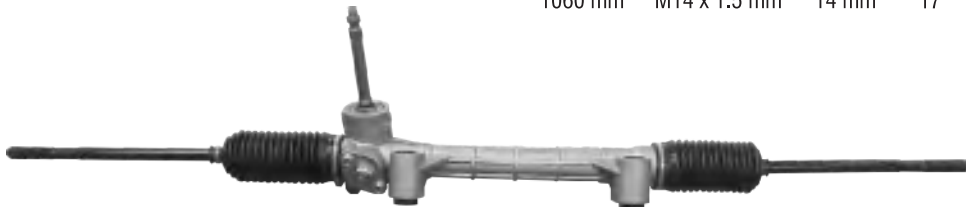



**CAJAS DE DIRECCIÓN**

CAIXAS DE DIREÇÃO / STEERING GEAR

FIAT							
	Año Ano   Year	Descripción Sistema Descrição   Decripción	Código Código   Code	Medidas Medidas   Measures			
DUCATO	1994/01	CAJA MECÁNICA	CM270100	L	RLE	DP	EP
				1407 mm	M16 x 1.5 mm	18 mm	
							
PALIO SIENA	1996/... 1996/...	CAJA MECÁNICA	CM270200	L	RLE	DP	EP
				1060 mm	M14 x 1.5 mm	14 mm	17
							
FORD							
TAUNUS	1974/84	CAJA MECÁNICA	CM300300	L	RLE	DP	EP
				1170 mm	M14 x 2.0 mm	14 mm	36
							
SIERRA	1982/93	CAJA MECÁNICA	CM300600	L	RLE	DP	EP
				1270 mm	M14 x 2.0 mm	14 mm	36
							
ESCORT	1988/94	CAJA MECÁNICA	CM300700	L	RLE	DP	EP
				1145 mm	M1/2" x 20	14 mm	17
							
ESCORT ORION	1995/00 1993/96	CAJA MECÁNICA	CM301000	L	RLE	DP	EP
				1230 mm	M14 x 2.0 mm	14 mm	
							





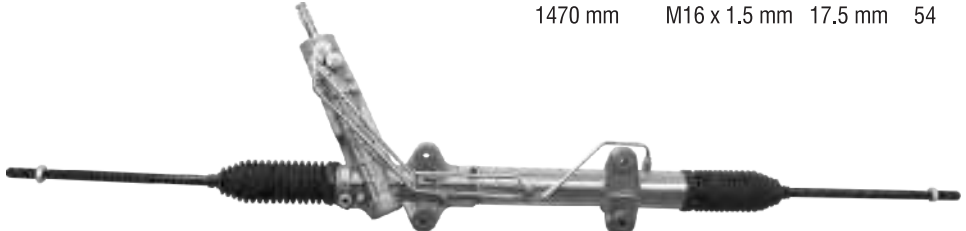
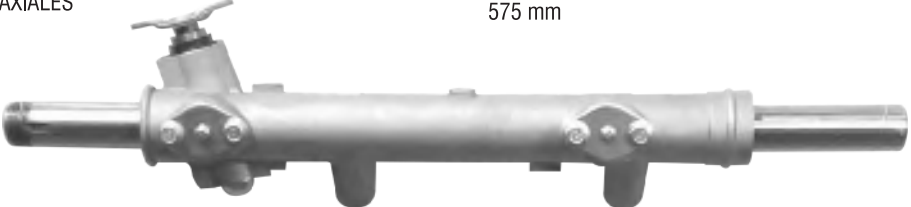

**CAJAS DE DIRECCIÓN**

CAIXAS DE DIREÇÃO / STEERING GEAR

FORD							
 Año Ano   Year	Descripción Sistema Descrição   Descrição	Código Código   Code	Medidas Medidas   Measures				
			L	RLE	DP	EP	
FIESTA KA	CAJA MECÁNICA	<b>CM310800</b>	1180 mm	M1/2" x 20	14 mm	36	
FIESTA COURIER KA	CAJA MECÁNICA	<b>CM320900</b>	1200 mm	M14 x 2.0 mm	15 mm		
TRANSIT	CAJA MECÁNICA	<b>CM330300</b>	1470 mm	M16 x 1.5 mm	17 mm	40	
RANGER	CAJA HIDRÁULICA	<b>CH430600</b>	1138 mm	M14 x 1.5 mm	18.6mm		
MERCEDES BENZ							
SPRINTER	CAJA HIDRÁULICA	<b>CH351200</b>	1470 mm	M16 x 1.5 mm	17.5 mm	54	
PEUGEOT							
504 1ª SERIE	CAJA MECÁNICA SIN AXIALES	<b>CM450300</b>	575 mm				







**CAJAS DE DIRECCIÓN**

CAIXAS DE DIREÇÃO / STEERING GEAR

PEUGEOT							
	Año Ano   Year	Descripción Sistema Descrição   Descrição	Código Código   Code	Medidas Medidas   Measures			
504 GR2	1982/...	CAJA MECÁNICA	<b>CM450301</b>	L	RLE	DP	EP
				1095 mm	H14 x 1.5 mm		
							
504 PICK UP 505	1981/... 1981/...	CAJA MECÁNICA	<b>CM450700</b>	L	RLE	DP	EP
				1139 mm	H14 x 1.5 mm		
							
205	1991/...	CAJA MECÁNICA	<b>CM460500</b>	L	RLE	DP	EP
				1120 mm	H14 x 1.5 mm	18.5 mm	
							
306 PARTNER BERLINGO	1995/03 1998/... 1998/...	CAJA MECÁNICA	<b>CM461100</b>	L	RLE	DP	EP
				1200 mm	H14 x 1.5 mm	18.5 mm	
							
RENAULT							
R12 DACIA	1975/... 1975/...	CAJA MECÁNICA CON MANCHÓN Y TERMINALES	<b>CM550400</b>	L	RLE	DP	EP
				595 mm			
							
R18	1978/79	CAJA MECÁNICA CON MANCHON Y FUELLES	<b>CM550401</b>	L	RLE	DP	EP
				605 mm			
							

**CAJAS DE DIRECCIÓN**

CAIXAS DE DIREÇÃO / STEERING GEAR

RENAULT							
	Año Ano   Year	Descripción Sistema Descrição   Descrição	Código Código   Code	Medidas Medidas   Measures			
R9 R11	.../1987 .../1987	CAJA MECÁNICA	<b>CM550600</b>	L	RLE	DP	EP
				1160 mm	H14 x 1.5 mm	17.2mm	40
							
R9 R11	1987/... 1987/...	CAJA MECÁNICA	<b>CM550601</b>	L	RLE	DP	EP
				1160 mm	H14 x 1.5 mm	17.2mm	40
							
R18 COUPE FUEGO	1980/93 1980/93	CAJA MECÁNICA	<b>CM550602</b>	L	RLE	DP	EP
				1030 mm	H14 x 1.5 mm	17.2mm	40
							
TRAFIC	1986/...	CAJA MECÁNICA	<b>CM550603</b>	L	RLE	DP	EP
				1222 mm	H14 x 1.5 mm	17.3 mm	40
							
R19	1992/...	CAJA MECÁNICA	<b>CM560400</b>	L	RLE	DP	EP
				1135 mm	H14 x 1.5 mm	18.5mm	
							
CLIO	1995/...	CAJA MECÁNICA	<b>CM560500</b>	L	RLE	DP	EP
				1090 mm	H14 x 1.5 mm	18.5 mm	
							

**CAJAS DE DIRECCIÓN**

CAIXAS DE DIREÇÃO / STEERING GEAR

**RENAULT**

Año Ano   Year	Descripción Sistema Descrição   Descrição	Código Código   Code	Medidas Medidas   Measures			
			L	RLE	DP	EP
CLIO	CAJA MECÁNICA	CM560501	1062 mm	M14 x 1.5 mm	18.5mm	



TWINGO	CAJA MECÁNICA	CM570000	1165 mm	M14 x 1.5 mm	18.5mm	
--------	---------------	----------	---------	--------------	--------	--



EXPRESS	CAJA MECÁNICA PERNO LARGO	CM580100	1085 mm	H14 x 1.5 mm	18.5mm	
---------	------------------------------	----------	---------	--------------	--------	--



KANGOO	CAJA MECÁNICA PRECAP LARGO	CM580101	1180 mm	M14 x 1.5 mm	18.5mm	
--------	-------------------------------	----------	---------	--------------	--------	--











**TOYOTA**

HILUX	CAJA HIDRÁULICA	CH920100	1290 mm	M15 x 1.5 mm	17.4mm	36
-------	-----------------	----------	---------	--------------	--------	----



**MAZAS DE RUEDA**









CUBOS DE RODA / WHEEL HULD

ALFA ROMEO					
	Año Ano   Year	Descripción Sistema Descrição   Descrição	Medidas Medidas   Measures	Código Código   Code	Imagen Imagem   Image
145	1994/02	MAZA DE RUEDA TRASERA	A 4 E - DI 30 mm DE 116 mm	MR272017	
145 155	1994/02 1992/98	MAZA DE RUEDA DELANTERA	A 4 E 25 DI 37 mm DE 116.5 mm	MR272415	
145 146 MITO	1996/02 1996/02 2009/...	MAZA DE RUEDA TRASERA CON RULEMAN CON ABS	A 4 E - DI 30 mm DE 117 mm	MR272417	
AUDI					
Q5 A7 A6	2008/17 2010/18 2012/18	MAZA RULEMAN DELANTERO	A 5 E DI 39 mm DE	MR223515	
A4	1999/...	MAZA DE RUEDA DELANTERA SIN RULEMAN	A 5 E 36 DI 40 mm DE 127 mm	MR230315	
A6	1997/...	MAZA DE RUEDA TRASERA CON RULEMAN CON ABS	A 5 E - DI 28 mm DE 131 mm	MR231417	
A3 RS3 Q2	2005/... 2018/... 2020/...	MAZA DE RUEDA DELANTERA C/ABS	A 5 E 36 DI 27 mm DE 135.5 mm	MR232415	
A1 A3 Q3 TT	2010/... 2003/13 2011/... 2006/14	MAZA DE RUEDA DELANTERA C/ABS	A 5 E 36 DI 40 mm DE 136 mm	MR233215	
CHEVROLET					
ASTRA KADETT MONZA VECTRA	1996/.. 1989/98 1991/98 1992/...	MAZA DE RUEDA DELANTERA SIN RULEMAN	A 4 E 33 DI 39 mm DE 120 mm	MR240215	

**MAZAS DE RUEDA**

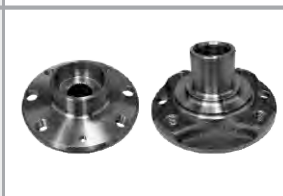
CUBOS DE RODA / WHEEL HULD











**CHEVROLET**

	<b>Año</b> Ano   Year	<b>Descripción Sistema</b> Descrição   Descrição	<b>Medidas</b> Medidas   Measures	<b>Código</b> Código   Code	<b>Imagen</b> Imagen   Image
ASTRA KADETT MONZA VECTRA	1996/.. 1989/98 1991/98 1992/...	MAZA DE RUEDA DELANTERA SIN RULEMAN	A 4 E 33 DI 39 mm DE 120 mm	<b>MR240215</b>	
ASTRA ASTRA ASTRA VECTRA ZAFIRA	2000/03 1998/12 2005/... 1998/06 2001/...	MAZA DE RUEDA TRASERA CON RULEMAN CON ABS	A 5 E - DI - DE 140 mm	<b>MR240217</b>	
AGILE CELTA CLASSIC CORSA MERIVA PRISMA	2009/... 2011/... 2010/... 1994/10 2003/... 2011/13	MAZA DE RUEDA DELANTERA SIN RULEMAN	A 4 E 22 DI 34 mm DE 120 mm	<b>MR240415</b>	
VECTRA CALIBRA	1993/05 1990/94	MAZA DE RUEDA DELANTERA	A 6 E 33 DI 47.7 mm DE 119.8 mm	<b>MR241415</b>	
CORSA CLASSIC MERIVA MONTANA	2002/10 2003/... 2004/...	MAZA DE RUEDA DELANTERA	A 6 E 22 DI - DE 121.8 mm	<b>MR241815</b>	
ASTRA MERIVA MONTANA VECTRA VECTRA VECTRA	1991/98 2003/... 2011/... 1992/98 1995/02 1998/...	MAZA DE RUEDA TRASERA CON RULEMAN CON ABS	A 4 E - DI - DE 136 mm	<b>MR241817</b>	
ASTRA VECTRA ZAFIRA	1995/11 1995/11 2001/10	MAZA DE RUEDA DELANTERA C/ABS	A 4 E 33 DI - DE 118.9 mm	<b>MR242315</b>	
ASTRA COMBO MERIVA MONTANA VECTRA VECTRA	1991/98 1998/... 2003/... 2011/... 1992/98 1998/...	MAZA DE RUEDA TRASERA CON RULEMAN	A 4 E - DI - DE 136 mm	<b>MR242517</b>	



**MAZAS DE RUEDA**







CUBOS DE RODA / WHEEL HULD

CHEVROLET					
	Año Ano   Year	Descripción Sistema Descrição   Descrição	Medidas Medidas   Measures	Código Código   Code	Imagen Imagem   Image
ASTRA	2000/03	MAZA DE RUEDA DELANTERA CON RULEMAN CON ABS	A 5	MR243415	
ASTRA	1998/12		E 33		
ASTRA	2005/...		DI 25 mm		
VECTRA	2002/...		DE 137 mm		
ZAFIRA	2001/...				
COBALT	2013/17	MAZA DE RUEDA TRASERA C/ABS	A 4	MR244117	
ONIX	2013/...		E		
PRISMA II	2011/16		DI		
SONIC	2012/18		DE 130 mm		
SPIN	2012/18				
COBALT	2017/20	MAZA DE RUEDA TRASERA CON RULEMAN CON ABS	A 4	MR244515	
ONIX	2016/19		E 25		
PRISMA	2016/19		DI 81		
SPIN	2016/...		DE 123 mm		
TRACKER	2014/19	MAZA DE RUEDA DELANTERA	A 5	MR282515	
			E 25		
			DI 40 mm		
			DE 136 mm		
CAPTIVA	2006/...	MAZA DE RUEDA TRASERA C/ABS	A 5	MR290017	
			E 30		
			DI		
			DE 150 mm		
ASTRA	2000/03	MAZA DE RUEDA TRASERA CON RULEMAN	A 5	MR290717	
ASTRA	1998/12		E -		
ASTRA	2005/...		DI -		
ZAFIRA	2001/...		DE 140 mm		
ASTRA	2000/03	MAZA DE RUEDA DELANTERA CON RULEMAN	A 4	MR290815	
ASTRA	1998/12		E 33		
VECTRA	1998/...		DI 30 mm		
			DE 119 mm		
CAPTIVA	2008/10	MAZA DE RUEDA DELANTERA C/ABS	A 5	MR291115	
			E 30		
			DI -		
			DE 150.8 mm		
CRUCE	2010/...	MAZA DE RUEDA DELANTERA C/ABS	A 5	MR291415	
			E 33		
			DI -		
			DE 135.5 mm		

**MAZAS DE RUEDA**

CUBOS DE RODA / WHEEL HULD

**CHEVROLET**









	<b>Año</b> Ano   Year	<b>Descripción Sistema</b> Descrição   Descripción	<b>Medidas</b> Medidas   Measures	<b>Código</b> Código   Code	<b>Imagen</b> Imagen   Image
CRUCE	2010/...	MAZA DE RUEDA TRASERA C/ABS	A 5 E - DI - DE 135.5 mm	MR291417	
CRUZE ASTRA	2015/... 2015/...	MAZA DE RUEDA DELANTERA C/ABS	A 5 E 33 DI DE 136 mm	MR291715	
CRUZE ASTRA	2015/... 2015/...	MAZA DE RUEDA TRASERA C/ABS	A 5 E DI DE 136 mm	MR291717	
S10 4x4 TRAILBLAZER 4x4	2017/19 2017/19	MAZA DE RUEDA DELANTERA C/ABS	A 6 E 33 DI DE 169.5 mm	MR291915-1	
BLAZER S-10 SILVERADO	2000/... 2000/12 2000/03	MAZA DE RUEDA DELANTERA CON RULEMAN CON ABS	A 5 E - DI 32 mm DE 145 mm	MR330515	
BLAZER S-10	1997/00 1995/01	MAZA DE RUEDA DELANTERA	A 5 E 27 DI 31.7 DE 144 mm	MR430015	

**CITROËN**

JUMPER	1999/...	MAZA DE RUEDA DELANTERA SIN RULEMAN	A 5 E 28 DI 50 mm DE 139 mm	MR270415	
C15 ZX	1993/04 1993/...	MAZA DE RUEDA TRASERA	A 4 E DI 32 DE 128 mm	MR450317	
BERLINGO XANTIA XSARA PICASSO ZX	2002/... 1993/01 1999/12	MAZA DE RUEDA TRASERA	A 4 E DI 32 DE 129 mm	MR451617	







**MAZAS DE RUEDA**

CUBOS DE RODA / WHEEL HULD

CITROËN					
	Año Ano   Year	Descripción Sistema Descrição   Descrição	Medidas Medidas   Measures	Código Código   Code	Imagen Imagen   Image
BERLINGO XANTIA XSARA XSARA PICASSO	1998/... 1993/01 1995/... 2001/...	MAZA DE RUEDA DELANTERA SIN RULEMAN	A 4 E 25 DI 42 mm DE 129 mm	MR452115	
XSARA PICASSO XSARA PICASSO	1999/11 2005/12	MAZA DE RUEDA DELANTERA CON RULEMAN	A 4 E DI 32 mm DE 129 mm	MR460917	
C3 AIRCROSS C3 PICASSO C4 PICASSO GRAND PICASSO ZX ZX	2010/... 2011/... 2007/... 2009/... 1993/99 2003/04	MAZA DE RUEDA DELANTERA	A 4 E 25 DI 42 mm DE 129 mm	MR471715	
BERLINGO XSARA PICASSO	2010/... 1999/12	MAZA DE RUEDA DELANTERA	A 4 E 25 DI 42 mm DE 129 mm	MR472317	
DAEWOO					
ESPERO	1992/99	MAZA DE RUEDA TRASERA CON RULEMAN CON ABS	A 4 E - DI - DE 136 mm	MR241817	
DODGE					
PICK UP RAM 2500	2009/...	MAZA DE RUEDA DELANTERA C/ABS	A 8 E 35 DI - DE 204.5 mm	MR521815	
JOURNEY	2008/...	MAZA DE RUEDA DELANTERA C/ABS	A 5 E 32 DI - DE 161 mm	MR523015	
JOURNEY	2008/...	MAZA DE RUEDA TRASERA C/ABS	A 5 E 32 DI - DE 161.7 mm	MR523017	



**MAZAS DE RUEDA**

CUBOS DE RODA / WHEEL HULD

FIAT					
	Año Ano   Year	Descripción Sistema Descrição   Descrição	Medidas Medidas   Measures	Código Código   Code	Imagen Imagem   Image
128 147 128 EUROPA SUPER EUROPA BRIO DUNA FIORINO IDEA REGATTA SPAZIO TEMPRA UNO VIVACE	1971/77 1982/97 1978/91 1978/91 1986/... 1988/00 1988/... 2006/... 1985/95 1985/97 1992/.. 1988/.. 1992/98	MAZA DE RUEDA TRASERA CON RULEMAN	A 4 E - DI 30 mm DE 117 mm	MR250417	
UNO UNO PREMIO PALIO PALIO WEEKEND DUNA FIORINO SIENA	1992/00 2002/04 1999/01 1999/05 1997/03 1988/95 1989/98 1997/11	MAZA DE RUEDA DELANTERA SIN RULEMAN	A 4 E DI 35 mm DE 116.5 mm	MR260315	
DUCATO DUCATO	1996/05 2006/...	MAZA DE RUEDA DELANTERA	A 5 E 35 DI 55 mm DE 156 mm	MR270315	
DUCATO	1992/01	MAZA DE RUEDA DELANTERA SIN RULEMAN	A 5 E 28 DI 50 mm DE 139 mm	MR270415	
PALIO PALIO ADVENTURE	2007/... 2005/...	MAZA DE RUEDA DELANTERA SIN RULEMAN	A 4 E 22 DI 35 mm DE 116 mm	MR271915	
BRAVA FIORINO MAREA PALIO PALIO ADVENTURE SIENA STILO TEMPRA TIPO UNO EVO	2000/03 1996/... 1998/06 1997/... 2005/... 1997/... 2003/... 1992/... 1993/... 2010/...	MAZA DE RUEDA DELANTERA	A 4 E - DI 30 mm DE 116 mm	MR272017	









**MAZAS DE RUEDA**

CUBOS DE RODA / WHEEL HULD

FIAT					
	Año Ano   Year	Descripción Sistema Descrição   Descrição	Medidas Medidas   Measures	Código Código   Code	Imagen Imagem   Image
500 - CINQUECENTO BARCHETTA BRAVA BRAVO BRAVO GRAND SIENA IDEA LINEA MAREA MAREA WEEKEND MOBI PALIO PALIO PALIO PALIO ADVENTURE PALIO WEEKEND PUNTO QUBO SIENA SIENA STILO STRADA UNO NUEVO UNO	2008/...	MAZA DE RUEDA DELANTERA	A 4	Mr272415	
	2001/...		E 25		
	2000/03		DI 37 mm		
	2012/...		DE 116.5 mm		
	1999/01				
	2012/...				
	2010/...				
	2009/...				
	1998/...				
	1998/...				
	2016/...				
	2001/...				
	2006/...				
	2012/15				
	2012/...				
	2001/...				
	2007/...				
	2011/...				
	2001/...				
	2014/22				
	2003/...				
	1999/...				
	2010/...				
	2010/17				
	500 - CINQUECENTO BARCHETTA BRAVA BRAVO BRAVO GRAND SIENA IDEA LINEA MAREA MAREA WEEKEND MOBI PALIO PALIO PALIO ADVENTURE PALIO WEEKEND PUNTO QUBO SIENA SIENA STILO STRADA NUEVO UNO		2008/...		
2001/...		E -			
2000/03		DI 30 mm			
2012/...		DE 117 mm			
1999/01					
2012/...					
2010/...					
2009/...					
1998/...					
1998/...					
2016/...					
2001/...					
2012/15					
2012/...					
2001/...					
2007/...					
2011/...					
2001/...					
2014/22					
2003/...					
1999/...					
2010/17					

## MAZAS DE RUEDA











CUBOS DE RODA / WHEEL HULD

FIAT					
	Año Ano   Year	Descripción Sistema Descrição   Descripción	Medidas Medidas   Measures	Código Código   Code	Imagen Imagem   Image
TORO	2016/19	MAZA DE RUEDA TRASERA	A 6 E 30 DI - DE 129.5 mm	MR273517	
FREEMONT	2017/...	MAZA DE RUEDA TRASERA CON ABS	A 5 E 32 DI - DE 161.7 mm	MR523017	
FORD					
GALAXY	1992/96	MAZA DE RUEDA DELANTERA SIN RULEMAN	A 4 E 22 DI 39 mm DE 120,5 mm	MR220615	
TRANSIT	2009/14	MAZA DE RUEDA DELANTERA CON RULEMAN	A 5 E DI 45 mm DE 112 mm	MR302015	
FOCUS MONDEO	2008/... 2008/...	MAZA DE RUEDA TRASERA CON RULEMAN CON ABS	A 5 E - DI - DE 136 mm	MR303417	
RANGER 4x4	2013/19	MAZA DE RUEDA DELANTERA	A 6 E 28 DI - DE 162 mm	MR303815	
FOCUS COURIER ECOSPORT ESCORT KA FIESTA FIESTA MAX	2000/10 1997/11 2003/13 1995/02 1997/14 2002/13 2002/13	MAZA DE RUEDA DELANTERA	A 4 E 25 DI 39 DE -	MR320915	
FOCUS	2008/14	MAZA DE RUEDA DELANTERA CON RULEMAN CON ABS	A 5 E 36 DI 28 mm DE 131 mm	MR321615	



**MAZAS DE RUEDA**











CUBOS DE RODA / WHEEL HULD

HONDA					
	Año Ano   Year	Descripción Sistema Descrição   Decripción	Medidas Medidas   Measures	Código Código   Code	Imagen Imagen   Image
ECOSPORT FIESTA KA	2013/18 2012/18 2012/18	MAZA DE RUEDA DELANTERA	A 4 E 25 DI 39 mm DE -	MR321715	
RANGER PICK UP 4x4	1990/98	MAZA DE RUEDA DELANTERA	A 5 E 42 DI - DE 149 mm	MR323715	
FOCUS	2013/19	MAZA DE RUEDA DELANTERA SIN RULEMAN	A 5 E 27 DI 55 mm DE 136.5 mm	MR324615	
ECOSPORT	2013/20	MAZA DE RUEDA TRASERA CON ABS	A 4 E - DI 55.8 mm DE 131 mm	MR325217	
FOCUS	2010/14	MAZA DE RUEDA TRASERA CON ABS	A 5 E - DI - DE 136 mm	MR340317	
EXPLORTER RANGER	1995/01 1997/12	MAZA DE RUEDA DELANTERA CON ABS	A 5 E 27 DI - DE 149.5 mm	MR340615	
F-100 4x4 F-250 F-4000	2006/11 2006/12 2006/...	MAZA DE RUEDA DELANTERA CON ABS	A 5 E 55 DI - DE 202 mm	MR870515	
HONDA					
CIVIC	1996/...	MAZA DE RUEDA TRASERA CON RULEMAN	A 4 E - DI 28 mm DE 134 mm	MR860217	
CR-V	2006/12	MAZA DE RUEDA TRASERA C/ABS	A 5 E 28 DI - DE 152 mm	MR861417	











**MAZAS DE RUEDA**

CUBOS DE RODA / WHEEL HULD

HONDA					
	Año Ano   Year	Descripción Sistema Descrição   Descripción	Medidas Medidas   Measures	Código Código   Code	Imagen Imagem   Image
CIVIC	2001/04	MAZA DE RUEDA TRASERA CON RULEMAN	A 4 E - DI 30 mm DE 139 mm	MR861617	
FIT	2002/08	MAZA DE RUEDA TRASERA CON RULEMAN	A 4 E - DI 28 mm DE 134 mm	MR862317	
FIT	2002/08	MAZA DE RUEDA TRASERA CON RULEMAN CON ABS	A 4 E - DI 28 mm DE 134 mm	MR862517	
CITY CIVIC FIT	2009/... 2006/... 2009/...	MAZA DE RUEDA TRASERA CON RULEMAN CON ABS	A 4 E - DI 30 mm DE 139 mm	MR862717	
CITY FIT	2009/20 2009/20	MAZA DE RUEDA TRASERA CON ABS	A 4 E - DI 30 mm DE 140 mm	MR862817	
CITY FIT	2009/... 2002/08	MAZA DE RUEDA DELANTERA SIN RULEMAN	A 4 E 26 DI 38 mm DE 121 mm	MR862915	
CITY FIT	2007/09 2009/16	MAZA DE RUEDA DELANTERA CON RULEMAN	A 4 E DI 30 mm DE 139 mm	MR863017	
CIVIC	2007/...	MAZA DE RUEDA DELANTERA SIN RULEMAN	A 5 E 26 DI 43 mm DE 139 mm	MR863315	
CIVIC	2007/...	MAZA DE RUEDA TRASERA CON RULEMAN CON ABS	A 5 E - DI - DE 139 mm	MR863317	

**MAZAS DE RUEDA**



CUBOS DE RODA / WHEEL HULD

HONDA					
	Año Ano   Year	Descripción Sistema Descrição   Descrição	Medidas Medidas   Measures	Código Código   Code	Imagen Imagen   Image
WR-V	2017/...	MAZA DE RUEDA TRASERA CON ABS	A 4 E - DI - DE 139 mm	MR863617	
HR-V	2016/19	MAZA DE RUEDA TRASERA	A 5 E - DI 73 mm DE 139.5 mm	MR863817	
CIVIC	1996/...	MAZA DE RUEDA TRASERA CON RULEMAN CON ABS	A 4 E - DI 28 mm DE 134 mm	MR864517	
CIVIC	2007/14	MAZA DE RUEDA TRASERA CON RULEMAN CON ABS	A 5 E - DI 52 mm DE 151,8 mm	MR864617	
ACCORD	1997/03	MAZA DE RUEDA DELANTERA SIN RULEMAN	A 4 E 28 DI 45 mm DE 139 mm	MR864815	
HYUNDAI					
H-1 CRDI	2008/14	MAZA DE RUEDA DELANTERA C/ABS	A 6 E 47 DI - DE 161.3 mm	MR910515	
LADA					
NIVA	1991/02	MAZA DE RUEDA DELANTERA	A 5 E 22 DI 40 mm DE 181 mm	MR970715	
MERCEDES BENZ					
SPRINTER	2006/13	MAZA DE RUEDA TRASERA CON ABS	A 65 E 29 DI - DE -	MR352017	





## MAZAS DE RUEDA

CUBOS DE RODA / WHEEL HULD

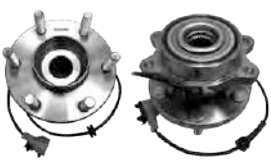

### MITSUBISHI

	Año Ano   Year	Descripción Sistema Descrição   Descrição	Medidas Medidas   Measures	Código Código   Code	Imagen Imagen   Image								
L200	2007/13	MAZA DE RUEDA DELANTERA	<table border="1"> <tr><td>A</td><td>6</td></tr> <tr><td>E</td><td>30</td></tr> <tr><td>DI</td><td>-</td></tr> <tr><td>DE</td><td>169 mm</td></tr> </table>	A	6	E	30	DI	-	DE	169 mm	MR962115	
A	6												
E	30												
DI	-												
DE	169 mm												

### NISSAN

MARCH	2012/13	MAZA DE RUEDA DELANTERA CON RULEMAN	<table border="1"> <tr><td>A</td><td>4</td></tr> <tr><td>E</td><td>25</td></tr> <tr><td>DI</td><td>37 mm</td></tr> <tr><td>DE</td><td>122 mm</td></tr> </table>	A	4	E	25	DI	37 mm	DE	122 mm	MR903215	
A	4												
E	25												
DI	37 mm												
DE	122 mm												
KICKS	2017/19	MAZA DE RUEDA TRASERA CON ABS	<table border="1"> <tr><td>A</td><td>4</td></tr> <tr><td>E</td><td>-</td></tr> <tr><td>DI</td><td>69 mm</td></tr> <tr><td>DE</td><td>122.5 mm</td></tr> </table>	A	4	E	-	DI	69 mm	DE	122.5 mm	MR903217	
A	4												
E	-												
DI	69 mm												
DE	122.5 mm												
TIIDA	2007/...	MAZA DE RUEDA TRASERA CON RULEMAN CON ABS	<table border="1"> <tr><td>A</td><td>4</td></tr> <tr><td>E</td><td>-</td></tr> <tr><td>DI</td><td>90 mm</td></tr> <tr><td>DE</td><td>146,4 mm</td></tr> </table>	A	4	E	-	DI	90 mm	DE	146,4 mm	MR903417	
A	4												
E	-												
DI	90 mm												
DE	146,4 mm												
FRONTIER	2008/12	MAZA DE RUEDA DELANTERA C/ABS	<table border="1"> <tr><td>A</td><td>6</td></tr> <tr><td>E</td><td>29</td></tr> <tr><td>DI</td><td>-</td></tr> <tr><td>DE</td><td>140 mm</td></tr> </table>	A	6	E	29	DI	-	DE	140 mm	MR904015	
A	6												
E	29												
DI	-												
DE	140 mm												
LIVIANA CUBE TIIDA	2009/14 2009/... 2004/12	MAZA DE RUEDA DELANTERA C/ABS	<table border="1"> <tr><td>A</td><td>4</td></tr> <tr><td>E</td><td>25</td></tr> <tr><td>DI</td><td>-</td></tr> <tr><td>DE</td><td>-</td></tr> </table>	A	4	E	25	DI	-	DE	-	MR908815	
A	4												
E	25												
DI	-												
DE	-												

### PEUGEOT

BOXER	1995/01	MAZA DE RUEDA DELANTERA SIN RULEMAN	<table border="1"> <tr><td>A</td><td>5</td></tr> <tr><td>E</td><td>28</td></tr> <tr><td>DI</td><td>50 mm</td></tr> <tr><td>DE</td><td>139 mm</td></tr> </table>	A	5	E	28	DI	50 mm	DE	139 mm	MR270415	
A	5												
E	28												
DI	50 mm												
DE	139 mm												
504 504 PICK UP 505	1970/00 1970/91 1982/...	MAZA DE RUEDA DELANTERA	<table border="1"> <tr><td>A</td><td>4</td></tr> <tr><td>E</td><td>-</td></tr> <tr><td>DI</td><td>60 mm</td></tr> <tr><td>DE</td><td>168 mm</td></tr> </table>	A	4	E	-	DI	60 mm	DE	168 mm	MR450115	
A	4												
E	-												
DI	60 mm												
DE	168 mm												

## MAZAS DE RUEDA







CUBOS DE RODA / WHEEL HULD

PEUGEOT					
	Año Ano   Year	Descripción Sistema Descrição   Descripción	Medidas Medidas   Measures	Código Código   Code	Imagen Imagem   Image
205	1988/00	MAZA DE RUEDA DELANTERA SIN RULEMAN	A 4 E 21 DI 35 mm DE 129 mm	MR450315	
205 405 405 FAMILIAR	1988/00 1991/98 1991/98	MAZA DE RUEDA TRASERA	A 4 E - DI 32 mm DE 128 mm	MR450317	
406 PARTNER	1996/04 1998/10	MAZA DE RUEDA TRASERA	A 4 E - DI 32 mm DE 129 mm	MR451617	
206 306 307 405 406 PARTNER	1998/... 1995/03 2001/12 1991/03 1996/05 1998/..	MAZA DE RUEDA DELANTERA SIN RULEMAN	A 4 E 25 DI 42 mm DE 129 mm	MR452115	
406 406 406 FAMILIAR 406 FAMILIAR 406 COUPE 406 COUPE	1991/01 2000/04 2000/04 1999/02 1998/02 2001/04	MAZA DE RUEDA DELANTERA CON RULEMAN	A 4 E DI 32 mm DE 129 mm	MR460917	
106 205 206	1999/03 1988/00 1998/...	MAZA DE RUEDA DELANTERA SIN RULEMAN	A 4 E 21 DI 37 mm DE 129 mm	MR472115	
HOGGAR PARTNER RCZ	2011/16 2010/... 2011/...	MAZA DE RUEDA TRASERA CON ABS	A 4 E 32 DI - DE 128.8 mm	MR472317	
RENAULT					
R21 ALIZE NEVADA	1986/97 1986/97 1986/97	MAZA DE RUEDA DELANTERA SIN RULEMAN	A 4 E 23 DI 40 mm DE 121 mm	MR550615	

## MAZAS DE RUEDA









CUBOS DE RODA / WHEEL HULD

### RENAULT

	Año Ano   Year	Descripción Sistema Descrição   Descrição	Medidas Medidas   Measures	Código Código   Code	Imagen Imagem   Image
R19	1989/01	MAZA DE RUEDA DELANTERA	A 4	MR560615	
R9	1989/03	SIN RULEMAN	E		
CLIO	1991/00		DI 37 mm		
CLIO	1993/98		DE 121 mm		
CLIO WILLAMS	1994/96				
EXPRESS	1995/02				
KANGOO	1999/09				
LAGUNA	1993/99				
LAGUNA II	1998/02				
LOGAN	2007/14				
MEGANE	1997/99				
MEGANE II	1999/09				
MEGANE II	2002/11				
SYMBOL	2009/14				
CLIO	1991/98	MAZA DE RUEDA DELANTERA	A 4	MR560815	
TWINGO	1992/03	SIN RULEMAN	E 21		
			DI 35 mm		
			DE 119 mm		
MEGANE III	2008/...	MAZA DE RUEDA DELANTERA	A 4	MR570915	
SCENIC III	2009/...		E 25		
GRANS SCENIC	2009/...		DI -		
FLUENCE	2010/...		DE 136.5 mm		
DUSTER	2011/...				
KWID	2017/21	MAZA DE RUEDA DELANTERA CON ABS SIN RULEMAN	A 3	MR571215	
			E 23		
			DI 27.7 mm		
			DE -		
LOGAN	2008/...	MAZA DE RUEDA DELANTERA	A 4	MR571315	
LOGAN	2010/18		E 23		
KANGOO	2007/17		DI 37 mm		
MEGANE	2006/11		DE 120.5 mm		
MEGANE GRAND TOUR	2007/13				
SANDERO	2007/18				
SCENIC	1999/11				
KANGOO	1997/...	MAZA DE RUEDA DELANTERA	A 4	MR580115	
MEGANE	1999/03		E 23		
SCENIC	2003/...		DI 50 mm		
CLIO	2000/16		DE 120 mm		
LOGAN	2004/...				
SANDERO	2009/..				

## MAZAS DE RUEDA







CUBOS DE RODA / WHEEL HULD

RENAULT					
	Año Ano   Year	Descripción Sistema Descrição   Descrição	Medidas Medidas   Measures	Código Código   Code	Imagen Imagem   Image
SPACE	1991/97	MAZA DE RUEDA TRASERA CON ABS	A 4	MR580117	
EXPRESS	1995/02		E 25		
KANGOO	2003/09		DI -		
MEGANE	1997/09		DE 132.8 mm		
R18	1983/91				
R21	1990/97				
SCENIC	1988/02				
MASTER	2002/14	MAZA DE RUEDA TRASERA	A 5	MR581817	
			E		
			DI 45 mm		
			DE -		
MASTER	2013/19	MAZA DE RUEDA DELANTERA	A 5	MR582415	
			E 31		
			DI 55 mm		
			DE 106.5 mm		
SEAT					
CORDOBA	1993/...	MAZA DE RUEDA DELANTERA SIN RULEMAN CON ABS	A 4	MR221015	
IBIZA	1992/...		E 22		
TOLEDO	1992/...		DI 40 mm		
			DE 121 mm		
CORDOBA	2003/...	MAZA DE RUEDA TRASERA CON RULEMAN CON ABS	A 5	MR221717	
IBIZA	2003/...		E -		
LEON	2001/06		DI 30 mm		
TOLEDO	2000/06		DE 120 mm		
IBIZA	2003/...	MAZA DE RUEDA TRASERA CON RULEMAN	A 5	MR224017	
TOLEDO	2007/...		E -		
			DI 28 mm		
			DE 120 mm		
IBIZA	2003/...	MAZA DE RUEDA TRASERA CON RULEMAN CON ABS	A 5	MR224217	
			E -		
			DI 28 mm		
			DE 120 mm		
CORDOBA	1993/03	MAZA DE RUEDA DELANTERA SIN RULEMAN	A 4	MR230915	
IBIZA	1992/03		E 22		
INCA	1992/03		DI 40 mm		
TOLEDO	1992/00		DE 121 mm		



**MAZAS DE RUEDA**









CUBOS DE RODA / WHEEL HULD

SEAT					
	Año Ano   Year	Descripción Sistema Descrição   Descrição	Medidas Medidas   Measures	Código Código   Code	Imagen Imagen   Image
ALTEA	2008/11	MAZA DE RUEDA DELANTERA C/ABS	A 5	MR232415	
LEON	2008/11		E 36		
TOLEDO	2008/09		DI 27 mm		
			DE 135.5 mm		
ALHAMBRA	2010/...	MAZA DE RUEDA DELANTERA C/ABS	A 5	MR233215	
ALTEA	2004/...		E 36		
LEON	2005/...		DI 40 mm		
TOLEDO	2004/09		DE 136 mm		
SKODA					
OCTAVIA	2004/13	MAZA DE RUEDA DELANTERA C/ABS	A 5	MR232415	
SUPERB	2008/15		E 36		
YETI	2009/...		DI 40 mm		
			DE 136 mm		
OCTAVIA	2010/13	MAZA DE RUEDA DELANTERA C/ABS	A 5	MR233215	
SUPERB	2010/15		E 36		
			DI 40 mm		
			DE 136 mm		
TOYOTA					
HILUX	2005/...	MAZA DE RUEDA DELANTERA CON RULEMAN	A 4	MR922415	
HILUX SW4	2005/...		E -		
LAND CRUISER PRADO	2005/...		DI 54 mm		
			DE 115 mm		
COROLLA	1997/...	MAZA DE RUEDA DELANTERA SIN RULEMAN	A 4	MR923315	
			E 26		
			DI 38 mm		
			DE 125 mm		
COROLLA	2002/08	MAZA DE RUEDA TRASERA	A 4	MR923417	
FELDER	2002/06		E 29		
			DI -		
			DE 140 mm		
COROLLA	2002/19	MAZA DE RUEDA DELANTERA SIN RULEMAN	A 4	MR924015	
			E 26		
			DI 40 mm		
			DE 1247.5 mm		



**MAZAS DE RUEDA**









CUBOS DE RODA / WHEEL HULD

TOYOTA					
	Año Ano   Year	Descripción Sistema Descrição   Descrição	Medidas Medidas   Measures	Código Código   Code	Imagen Imagem   Image
COROLLA	2003/08	MAZA DE RUEDA TRASERA CON RULEMAN CON ABS	A 4 E - DI - DE 135 mm	MR924017	
HILUX 4 x4	2016/...	MAZA DE RUEDA DELANTERA C/ABS	A 6 E 30 DI - DE 167 mm	MR925415	
ETIOS	2013/21	MAZA DE RUEDA DELANTERA DERECHA C/RULEMAN C/ABS	A 4 E 26 DI 46,4 mm DE 110 mm	MR926615D	
ETIOS	2013/21	MAZA DE RUEDA DELANTERA IZQUIERDA C/RULEMAN C/ABS	A 4 E 26 DI 46,4 mm DE 110 mm	MR926615I	
HILUX 4 x2	2016/...	MAZA DE RUEDA DELANTERA	A 6 E - DI - DE 167 mm	MR926815	
COROLLA	2008/...	MAZA DE RUEDA DELANTERA	A 5 E 26 DI - DE 125 mm	MR924915	
VOLVO					
S40 V50	2000/... 2000/...	MAZA DE RUEDA DELANTERA CON RULEMAN CON ABS	A 5 E 36 DI 28 mm DE 131 mm	MR321615	
VOLKSWAGEN					
GACEL GOL GOL TREND SAVEIRO SENDA VOYAGE	1983/... 1991/... 2009/... 1990/... 1989/... 2008/...	MAZA DE RUEDA DELANTERA SIN RULEMAN	A 4 E 22 DI 39 mm DE 121 mm	MR220615	

**MAZAS DE RUEDA**

CUBOS DE RODA / WHEEL HULD









**VOLKSWAGEN**

	<b>Año</b> Ano   Year	<b>Descripción Sistema</b> Descrição   Descripción	<b>Medidas</b> Medidas   Measures	<b>Código</b> Código   Code	<b>Imagen</b> Imagem   Image
GOLF CABRIOLET GOLF III PASSAT POLO	1993/99 1995/99 1995/99 1995/99	MAZA DE RUEDA DELANTERA SIN RULEMAN CON ABS	A 4 E 22 DI 40 mm DE 121 mm	<b>MR221015</b>	
BORA GOLF IV NEW BEETLE	2000/... 2000/07 1999/...	MAZA DE RUEDA DELANTERA SIN RULEMAN CON ABS	A 5 E 36 DI 40 mm DE 127 mm	<b>MR221715</b>	
BORA GOLF IV NEW BEETLE	2000/... 2000/07 1999/...	MAZA DE RUEDA TRASERA CON RULEMAN CON ABS	A 5 E - DI 30 mm DE 120 mm	<b>MR221717</b>	
CROSS FOX FOX SURAN	2005/... 2003/... 2006/...	MAZA DE RUEDA DELANTERA CON RULEMAN	A 5 E 36 DI 29 mm DE 72 / 127 mm	<b>MR224015</b>	
CROSS FOX FOX SURAN	2005/... 2003/... 2006/...	MAZA DE RUEDA TRASERA CON RULEMAN	A 5 E - DI 28 mm DE 120 mm	<b>MR224017</b>	
CROSS FOX FOX GOLF V SURAN	2005/... 2003/... 2007/... 2006/...	MAZA DE RUEDA TRASERA CON RULEMAN CON ABS	A 5 E - DI 28 mm DE 120 mm	<b>MR224217</b>	
GOLF IV	2000/07	MAZA DE RUEDA DELANTERA SIN RULEMAN	A 5 E 36 DI 40 mm DE 127 mm	<b>MR230315</b>	
CADDY GOL GOLF CABRIOLET GOLF III PASSAT POLO	1998/... 2003/.. 1993/99 1995/99 1990/... 1996/...	MAZA DE RUEDA DELANTERA SIN RULEMAN	A 4 E 22 DI 40 mm DE 121 mm	<b>MR230915</b>	

**MAZAS DE RUEDA**

CUBOS DE RODA / WHEEL HULD





**VOLKSWAGEN**

	<b>Año</b> Ano   Year	<b>Descripción Sistema</b> Descrição   Descripción	<b>Medidas</b> Medidas   Measures	<b>Código</b> Código   Code	<b>Imagen</b> Imagem   Image
NIVUS POLO T-CROSS VIRTUS	2020/20 2017/20 2019/20 2017/20	MAZA RULEMAN DELANTERO	A 5 E 36 DI - DE 125 mm	<b>MR231115</b>	
PASSAT	1997/...	MAZA DE RUEDA TRASERA CON RULEMAN CON ABS	A 5 E - DI 28 mm DE 131 mm	<b>MR231417</b>	
CROSSFOX FOX POLO FOX HATCHBACK SPACEFOX	2005/18 2003/18 2002/12 2003/14 2006/...	MAZA RULEMAN DELANTERO	A 5 E 22 DI - DE 120.5 mm	<b>MR232015</b>	
UP	2014/19	MAZA DE RUEDA DELANTERA	A 4 E 22 DI - DE 120 mm	<b>MR232017</b>	
GOLF TIGUAN	2015/... 2018/...	MAZA DE RUEDA DELANTERA C/ABS	A 5 E 36 DI 27 DE 135.5 mm	<b>MR232415</b>	
BEETLE CADDY III CC EOS GOLF IV GOLF V GOLF VI/ VII JETTA III JETTA IV PASSAT SCIROCCO SHARAN TIGUAN TOURAN	2011/... 2004/15 2008/15 2006/15 2008/13 2003/08 2011/... 2005/10 2010/... 2005/14 2008/... 2010/... 2007/... 2003/15	MAZA DE RUEDA DELANTERA C/ABS	A 5 E 36 DI 40 DE 136 mm	<b>MR233215</b>	
SAVEIRO VAN	2010/17 1997/06	MAZA DE RUEDA TRASERA C/ABS	A 4 E 43 DI 30 mm DE 120 mm	<b>MR233317</b>	



**HOMOCINETICAS**

HOMOCINETICAS / C.V. JOINTS

**CHEVROLET**

	Año Ano   Year	Descripción Sistema Descrição   Descrição	Medidas Medidas   Measures	Código Código   Code	Imagen Imagen   Image
AGILE	2009/22	HOMOCINETICA	EI 28 (interior)	<b>JH240400</b>	
CELTA	2011/17	LADO RUEDA	EE 22 (exterior)		
CLASSIC	2010/22		DR 20 (mm)		
CORSA	1996/07		DC 81.5 (mm)		
CORSA CLASSIC	2002/10		DAR 52.2 (mm)		
CORSA PICKUP	1995/07				
CORSA SEDAN	1995/07				
CORSA STATION WAGON	1995/07				
CORSA	2002/12	HOMOCINETICA	EI 23 (interior)	<b>JH242200</b>	
MERIVA	2003/10	LADO CAJA	EE 22 (exterior)		
			DR Deslizante		
			DC 94 (mm)		
			DAR 35 (mm)		
CORSA	1994/96	HOMOCINETICA	EI 28 (interior)	<b>JH282300</b>	
		LADO CAJA	EE 22 (exterior)		
			DR Deslizante		
			DC 79 (mm)		
			DAR 34.95 (mm)		

**CITROËN**

JUMPER FURGON	1999/02	HOMOCINETICA	EI 39 (interior)	<b>JH460900</b>	
JUMPER FURGON	2003/10	LADO RUEDA	EE 28 (exterior)		
			DR 28 (mm)		
			DC 99 (mm)		
			DAR 63 (mm)		
BERLINGO FURGON	2015/22	HOMOCINETICA	EI 22 (interior)	<b>JH461100</b>	
BERLINGO FURGON	2003/11	LADO RUEDA	EE 25 (exterior)		
BERLINGO MULTISPACE	2002/04	CON ABS (48 dientes)	DR 23.6 (mm)		
			DC 81 (mm)		
			DAR 60 (mm)		

**FIAT**

FIORINO FURGON 1994/03	1994/03	HOMOCINETICA	EI 20 (interior)	<b>JH250600</b>	
FIORINO WORKING 1997/00	1997/00	LADO RUEDA	EE 22 (exterior)		
FIORINO/PICKUP 1989/98	1989/98		DR 20 (mm)		
PALIO FASE II 2007/12	2007/12		DC 81 (mm)		
PALIO FASE III 2009/22	2009/22		DAR 48.1 (mm)		
PALIO WEEKEND 2006/10	2006/10				
PREMIO 1999/01	1999/01				
SIENA	2006/...				
STRADA WORKING	2004/05				
UNO	1988/94				
UNO	1994/01				
UNO WAY	2009/10				

**HOMOCINETICAS**

HOMOCINETICAS / C.V. JOINTS

FIAT					
	Año Ano   Year	Descripción Sistema Descrição   Descripción	Medidas Medidas   Measures	Código Código   Code	Imagen Imagen   Image
FIORINO	1996/06	HOMOCINETICA	EI 22 (interior)	JH270500	
PALIO	1997/08	LADO RUEDA	EE 22 (exterior)		
SIENA	2001/10		DR 22 (mm)		
			DC 80 (mm)		
			DAR 52 (mm)		
IDEA	2005/18	HOMOCINETICA	EI 22 (interior)	JH270700	
PALIO	2004/10	LADO RUEDA	EE 22 (exterior)		
PALIO ADVENTURE	2005/10		DR 22 (mm)		
PALIO WEEKEND	2005/10		DC 80 (mm)		
SIENA	2000/10		DAR 51 (mm)		
STRADA ADVENTURE	2005/11				
FIORINO FURGON	2002/15	HOMOCINETICA	EI 20 (interior)	JH271200	
FIORINO	1996/00	LADO RUEDA	EE 22 (exterior)		
IDEA	2005/18		DR 22 (mm)		
PALIO	1997/01		DC 80 (mm)		
SIENA	1997/03		DAR 52 (mm)		
STRADA ADVENTURE	2005/11				
UNO	2004/16				
NUEVO UNO / WAY /SPORTING	2010/17	HOMOCINETICA	EI 22 (interior)	JH271900	
PALIO	2012/22	LADO RUEDA	EE 22 (exterior)		
PALIO FASE III	2010/17		DR 22 (mm)		
PALIO WEEKEND	2011/11		DC 79 (mm)		
UNO WAY	2009/10		DAR 47 (mm)		
IDEA	2005/18	HOMOCINETICA	EI 24 (interior)	JH272000	
PALIO	2006/10	LADO RUEDA	EE 25 (exterior)		
PALIO ADVENTURE	2005/10		DR 24 (mm)		
PALIO WEEKEND	2005/10		DC 84.5 (mm)		
			DAR 51 (mm)		
DUCATO	1992/05	HOMOCINETICA	EI 39 (interior)	JH460900	
		LADO RUEDA	EE 28 (exterior)		
			DR 28 (mm)		
			DC 99 (mm)		
			DAR 63 (mm)		
FORD					
ESCORT	1988/96	HOMOCINETICA	EI 33 (interior)	JH230100	
		LADO CAJA	EE 0 (exterior)		
			DR		
			DC 94 (mm)		
			DAR 0 (mm)		

**HOMOCINETICAS**

HOMOCINETICAS / C.V. JOINTS

FORD					
	Año Ano   Year	Descripción Sistema Descrição   Descripción	Medidas Medidas   Measures	Código Código   Code	Imagen Imagen   Image
ECOSPORT	2003/13	HOMOCINETICA	EI 25 (interior)	JH302100	
FIESTA	2002/13	LADO RUEDA	EE 21 (exterior)		
FIESTA MAX	2002/13		DR 22 (mm)		
KA	2008/14		DC 75 (mm)		
			DAR 53.2 (mm)		
COURIER		HOMOCINETICA	EI 22 (interior)	JH320300	
ESCORT		LADO RUEDA	EE 25 (exterior)		
FIESTA			DR 22 (mm)		
FIESTA KINETIC			DC 79.5 (mm)		
			DAR 56.5 (mm)		
RANGER II	2012/17	HOMOCINETICA	EI 26 (interior)	JH324900	
		LADO RUEDA	EE 28 (exterior)		
			DR 24 (mm)		
			DC 92 (mm)		
			DAR 61 (mm)		
PEUGEOT					
306	1999/03	HOMOCINETICA	EI 35 (interior)	JH460600	
405	1991/03	LADO RUEDA	EE 25 (exterior)		
405/FAMILIAR	1991/97		DR 24 (mm)		
406	1996/04		DC 87.5 (mm)		
406 COUPE	1996/03		DAR 55.8 (mm)		
406 FAMILIAR	1999/02				
BOXER	1994/	HOMOCINETICA	EI 39 (interior)	JH460900	
		LADO RUEDA	EE 28 (exterior)		
			DR 28 (mm)		
			DC 99 (mm)		
			DAR 63 (mm)		
PARTNER FURGON	1998/03	HOMOCINETICA	EI 22 (interior)	JH461100	
PARTNER PATAGONICA	2003/05	LADO RUEDA	EE 25 (exterior)		
PARTNER URBANA/FURGON	2002/22	CON ABS (48 dientes)	DR 23.6 (mm)		
			DC 81 (mm)		
			DAR 60 (mm)		
RENAULT					
MASTER	1999/08	HOMOCINETICA	EI 36 (interior)	JH270300-1	
		LADO RUEDA	EE 28 (exterior)		
			DR 24 (mm)		
			DC 99.6 (mm)		
			DAR 65 (mm)		

**HOMOCINETICAS**

HOMOCINETICAS / C.V. JOINTS

RENAULT					
	Año Ano   Year	Descripción Sistema Descrição   Descrição	Medidas Medidas   Measures	Código Código   Code	Imagen Imagen   Image
19 BICUERPO	1993/01	HOMOCINETICA	EI 25 (interior)	JH560500	
19 TRICUERPO	1994/01	LADO RUEDA	EE 21 (exterior)		
CLIO	1991/00		DR 20 (mm)		
EXPRESS	1995/02		DC 90 (mm)		
			DAR 46.3 (mm)		
19 BICUERPO	1993/01	HOMOCINETICA	EI 30 (interior)	JH560600	
19 TRICUERPO	1994/01	LADO RUEDA	EE 21 (exterior)		
EXPRESS	1995/02		DR 20 (mm)		
			DC 85 (mm)		
			DAR 57 (mm)		
KANGOO	1998/01	HOMOCINETICA	EI 21 (interior)	JH560700	
KANGOO BREAK	1999/08	LADO RUEDA	EE 22 (exterior)		
KANGOO EXPRESS	1999/09		DR 20 (mm)		
KANGOO II EXPRESS	2003/14		DC 81 (mm)		
MEGANE	1997/99		DAR 51.5 (mm)		
MEGANE II	1997/03				
CLIO II	1999/08	HOMOCINETICA	EI 23 (interior)	JH560800	
CLIO II	2007/11	LADO RUEDA	EE 23 (exterior)		
CLIO III	2001/09	CON ABS (44 dientes)	DR 20 (mm)		
KANGOO	1998/08		DC 82 (mm)		
KANGOO	2008/12		DAR 59 (mm)		
KANGOO EXPRESS	1999/09				
KANGOO EXPRESS	2003/14				
SANDERO/STEPWAY	2008/15	HOMOCINETICA	EI 30 (interior)	JH570200	
		LADO RUEDA	EE 23 (exterior)		
			DR 20 (mm)		
			DC 84 (mm)		
			DAR 49 (mm)		
CLIO II	1999/08	HOMOCINETICA	EI 22 (interior)	JH570900	
CLIO II	2007/11	LADO RUEDA	EE 21 (exterior)		
CLIO III	2001/09		DR 20 (mm)		
KANGOO	1998/02		DC 83 (mm)		
KANGOO EXPRESS	1999/07		DAR 51.5 (mm)		
KANGOO EXPRESS	2003/14				
KANGOO LINEA NUEVA		HOMOCINETICA	EI 30 (interior)	JH571300	
		LADO RUEDA	EE 23 (exterior)		
			DR 20 (mm)		
			DC 84 (mm)		
			DAR 49 (mm)		



# HOMOCINETICAS

HOMOCINETICAS / C.V. JOINTS

## RENAULT



	Año Ano   Year	Descripción Sistema Descrição   Descrição	Medidas Medidas   Measures	Código Código   Code	Imagen Imagen   Image
KANGOO	1998/09	HOMOCINETICA	EI 21 (interior)	JH580100	
KANGOO EXPRESS	1999/09	LADO RUEDA	EE 23 (exterior)		
KANGOO II EXPRESS	2003/14		DR 20 (mm)		
			DC 76 (mm)		
			DAR 49(mm)		
9	1989/03	HOMOCINETICA	EI 30 (interior)	JH580700	
11	1986/99	LADO RUEDA	EE 21 (exterior)		
			DR 20 (mm)		
			DC 81 (mm)		
			DAR 46.3 (mm)		
KANGOO	1998/08	HOMOCINETICA	EI 28 (interior)	JH581000	
KANGOO	2003/14		EE 21 (exterior)		
KANGOO EXPRESS	1999/09		DR 20 (mm)		
KANGOO2 EXPRESS	2003/14		DC 75 (mm)		
			DAR 52 (mm)		
CLIO II	1999/05	HOMOCINETICA	EI 21 (interior)	JH581200	
CLIO II	2007/11	LADO RUEDA	EE 23 (exterior)		
CLIO III	2001/09		DR 20 (mm)		
			DC 76 (mm)		
			DAR 56.2 (mm)		
CLIO II	2007/11	HOMOCINETICA	EI 30 (interior)	JH581600	
CLIO III	2001/09	LADO RUEDA	EE 23 (exterior)		
KANGOO	1999/09	CON ABS (44 dientes)	DR 20 (mm)		
KANGOO EXPRESS	1999/09		DC 84 (mm)		
KANGOO II EXPRESS	2003/14		DAR 49 (mm)		

## SUZUKI





FUN	2004/12	HOMOCINETICA	EI 28 (interior)	JH240400	
		LADO RUEDA	EE 22 (exterior)		
			DR 20 (mm)		
			DC 81.5 (mm)		
			DAR 52.2 (mm)		

## TOYOTA

HILUX	2005/16	HOMOCINETICA	EI 29 (interior)	JH922100	
HILUX SW4 4X2	2013/16	LADO RUEDA	EE 30 (exterior)		
HILUX SW4 4X4	2015/16		DR 28 (mm)		
			DC 106 (mm)		
			DAR 72 (mm)		

**HOMOCINETICAS**

HOMOCINETICAS / C.V. JOINTS

VOLKSWAGEN					
	Año Ano   Year	Descripción Sistema Descrição   Descrição	Medidas Medidas   Measures	Código Código   Code	Imagen Imagem   Image
CARAT	1987/92	HOMOCINETICA	EI 30 (interior)	<b>JH220400</b>	
GACEL	1983/94	LADO RUEDA	EE 22 (exterior)		
GOL	2002/09		DR 20 (mm)		
GOL	1991/99		DC 81 (mm)		
QUANTUM	1992/98		DAR 51 (mm)		
SAVEIRO	1990/01				
SENDA	1989/97				
CADDY	1998/10	HOMOCINETICA	EI 33 (interior)	<b>JH230100</b>	
CARAT	1987/92	LADO CAJA	EE 0 (exterior)		
GACEL	1983/94		DR		
GOL	2002/09		DC 94 (mm)		
GOL	1991/99		DAR 0 (mm)		
GOL	1998/11				
GOL COUNTRY	1995/11				
SENDA	1989/97				
GOLF	2001/12	HOMOCINETICA	EI 33 (interior)	<b>JH230900</b>	
GOLF	1995/99	LADO CAJA	EE 0 (exterior)		
KOMBI/FURGON	1983/90		DR Deslizante		
PASSAT	1983/84		DC 100 (mm)		
PASSAT/VARIANT	1995/99		DAR 0 (mm)		

**PUNTA DE EJE**

PONTA DE EIXO / STUB AXLES

AUDI					
	Año Ano   Year	Descripción Sistema Descrição   Descrição	Medidas Medidas   Measures	Código Código   Code	Imagen Imagen   Image
A3	1996/03	PUNTA DE EJE	L (mm) DB (mm)	PE233217	
CHEVROLET					
KADETT	1989/98	PUNTA DE EJE TRASERO	L (mm)	PE240217	
MONZA	1982/96		DB (mm)		
CORSA		PUNTA DE EJE TRASERO	L (mm) DB (mm)	PE240417	
AGILE	2009/14	PUNTA DE EJE TRASERO	L (mm)	PE241017	
CELTA	1999/08		DB (mm)		
CELTA	2009/14				
CORSA	1994/12				
PRISMA	2006/15				
TIGRA	1997/98				
CORSA	1996/12	PUNTA DE EJE TRASERO	L (mm)	PE241417	
CORSA CLASSIC	2000/05		DB (mm)		
CITROEN					
BERLINGO	2001/11	PUNTA DE EJE TRASERO	L 135 (mm) DB 32 (mm)	PE461117	
FIAT					
DUNA	1994/95	PUNTA DE EJE TRASERO	L (mm)	PE250617	
ELBA	1985/94		DB (mm)		
FIORINO	1988/93				
PREMIO	1985/94				
UNO	1987/96				
UNO MILLE	1995/03				
UNO MPI	1993/95				
MOBI	2016/...	PUNTA DE EJE TRASERO DERECHO	L (mm)	PE270517D	
PALIO	2007/17		DB (mm)		
PALIO WEEKEND	2012/17				
UNO	208/16				

**PUNTA DE EJE**

PONTA DE EIXO / STUB AXLES

FIAT					
	Año Ano   Year	Descripción Sistema Descrição   Descrição	Medidas Medidas   Measures	Código Código   Code	Imagen Imagen   Image
MOBI	2016/...	PUNTA DE EJE TRASERO	L (mm)	PE270517I	
PALIO	2007/17	IZQUIERDA	DB (mm)		
PALIO WEEKEND	2012/17				
UNO	208/16				
FORD					
VERSAILLES	1991/96	PUNTA DE EJE TRASERO	L (mm)	PE230317	
ROYALE	1992/96		DB (mm)		
COURIER	1997/99	PUNTA DE EJE TRASERO	L (mm)	PE310815D	
FIESTA	1996/99	DERECHO	DB (mm)		
COURIER	1997/09	PUNTA DE EJE TRASERO	L (mm)	PE310817	
			DB (mm)		
ESCORT	1992/96	PUNTA DE EJE TRASERO	L (mm)	PE320317D	
VERONA	1993/96	DERECHO	DB (mm)		
ESCORT	1992/96	PUNTA DE EJE TRASERO	L (mm)	PE320317I	
VERONA	1993/96	IZQUIERDA	DB (mm)		
ECOSPORT 4WD	2008/12	PUNTA DE EJE TRASERO	L (mm)	PE325317	
ECOSPORT	2003/19		DB (mm)		
FIESTA	1999/15				
FOCUS	2000/08				
ECOSPORT 4WD	2008/12	PUNTA DE EJE TRASERO	L (mm)	PE340217	
ECOSPORT	2003/12		DB (mm)		
ESCORT	1996/02				
FIESTA	1996/14				
FOCUS	2003/10				
KA	1997/14				

**PUNTA DE EJE**

PONTA DE EIXO / STUB AXLES

NISSAN					
	Año Ano   Year	Descripción Sistema Descrição   Descrição	Medidas Medidas   Measures	Código Código   Code	Imagen Imagen   Image
MARCH VERSA	2011/19 2015/18	PUNTA DE EJE TRASERO	L (mm) DB (mm)	PE908817	
PEUGEOT					
207 2008	2012/15 2014/...	PUNTA DE EJE TRASERO	L (mm) DB (mm)	PE451717	
207 208 2008	2012/15 2012/15 2014/...	PUNTA DE EJE TRASERO	L (mm) DB (mm)	PE452117	
PARTNER PARTNER	1997/03 2007/11	PUNTA DE EJE TRASERO	L (mm) DB (mm)	PE461117	
RENAULT					
LOGAN SANDERO	2014 /... 2014 /...	PUNTA DE EJE TRASERO	L (mm) DB (mm)	PE571117	
KWID	2017/...	PUNTA DE EJE TRASERO	L (mm) DB (mm)	PE571217	
CLIO LOGAN SANDERO	1999/12 2007/13 2007/14	PUNTA DE EJE TRASERO	L (mm) DB (mm)	PE581017	
DUSTER LOGAN	2011/20 2013/18	PUNTA DE EJE TRASERO	L (mm) DB (mm)	PE582217	

**PUNTA DE EJE**

PONTA DE EIXO / STUB AXLES

SEAT					
	Año Ano   Year	Descripción Sistema Descrição   Descrição	Medidas Medidas   Measures	Código Código   Code	Imagen Imagem   Image
CORDOBA	1996/...	PUNTA DE EJE TRASERO	L (mm)	PE230317	
IBIZA	1996/...		DB (mm)		
SUZUKI					
FUN		PUNTA DE EJE TRASERO	L (mm)	PE240417	
			DB (mm)		
VOLKSWAGEN					
KOMBI FURGON	1959/97	PUNTA DE EJE TRASERO	L (mm)	PE220617	
KOMBI PICK-UP	1980/05		DB (mm)		
KOMBI	1997/12				
GOLF	1994/13	PUNTA DE EJE TRASERO DERECHA	L (mm)	PE221717D	
			DB (mm)		
GOLF	1994/13	PUNTA DE EJE TRASERO IZQUIERDA	L (mm)	PE221717I	
			DB (mm)		
CROSSFOX	2014/18	PUNTA DE EJE TRASERO	L (mm)	PE224017	
FOX	2003/18		DB (mm)		
GOL	2008/16				
POLO	2002/19				
SPACE FOX	2006/19				
UP!	2014/19				
GOL 2008/12	2008/12	PUNTA DE EJE TRASERO DERECHA	L (mm)	PE224017D	
VOYAGE 2008/12	2008/12		DB (mm)		
GOL 2008/12	2008/12	PUNTA DE EJE TRASERO IZQUIERDA	L (mm)	PE224017I	
VOYAGE 2008/12	2008/12		DB (mm)		

## PUNTA DE EJE

PONTA DE EIXO / STUB AXLES

### VOLKSWAGEN



	Año Ano   Year	Descripción Sistema Descrição   Descrição	Medidas Medidas   Measures	Código Código   Code	Imagen Imagem   Image
GOL	1997/...	PUNTA DE EJE TRASERO	L (mm)	PE230317	
VOYAGE	1997/...		DB (mm)		
PARATI	1997/...				
SAVEIRO	1997/...				
SANTANA	1997/...				
QUANTUM	1997/...				
PASSAT	1997/...				
POLO	1997/...				
FOX	2004/14				
GOLF	1995/98				
GOLF	1994/98	PUNTA DE EJE TRASERO DERECHA	L (mm)	PE230717D	
PASSAT VR6	1991/97		DB (mm)		
GOLF	1994/98	PUNTA DE EJE TRASERO IZQUIERDA	L (mm)	PE230717I	
PASSAT VR6	1991/97		DB (mm)		
GOL	2008/12	PUNTA DE EJE TRASERO	L (mm)	PE231217	
VOYAGE	2008/12		DB (mm)		
GOL	1999/05	PUNTA DE EJE TRASERO DERECHA	L (mm)	PE231317D	
PARATI	1996/05		DB (mm)		
QUANTUM	1985/93				
QUANTUM	1994/01				
SANTANA	1994/06				
GOL	1999/05	PUNTA DE EJE TRASERO IZQUIERDA	L (mm)	PE231317I	
PARATI	1996/05		DB (mm)		
QUANTUM	1985/93				
QUANTUM	1994/01				
SANTANA	1994/06				
BORA	2000/02	PUNTA DE EJE TRASERO	L (mm)	PE233217	
GOLF	2006/18		DB (mm)		
NEW BEETLE	2000/10				
SAVEIRO	2009/16				
NIVUS	2021/...	PUNTA DE EJE TRASERO	L (mm)	PE233417	
POLO	2018/...		DB (mm)		
T-CROSS	2020/...				
VIRTUS	2018/...				



**PUNTA DE EJE**

PONTA DE EIXO / STUB AXLES

**VOLKSWAGEN**

	<b>Año</b> Ano   Year	<b>Descripción Sistema</b> Descrição   Descrição	<b>Medidas</b> Medidas   Measures	<b>Código</b> Código   Code	<b>Imagen</b> Imagem   Image				
LOGUS POINTER	1992/96 1993/96	PUNTA DE EJE TRASERO DERECHA	<table border="1"> <tr> <td data-bbox="841 374 901 431">L</td> <td data-bbox="901 374 1065 431">(mm)</td> </tr> <tr> <td data-bbox="841 431 901 466">DB</td> <td data-bbox="901 431 1065 466">(mm)</td> </tr> </table>	L	(mm)	DB	(mm)	<b>PE320317D</b>	
L	(mm)								
DB	(mm)								
LOGUS POINTER	1992/96 1993/96	PUNTA DE EJE TRASERO IZQUIERDA	<table border="1"> <tr> <td data-bbox="841 619 901 654">L</td> <td data-bbox="901 619 1065 654">(mm)</td> </tr> <tr> <td data-bbox="841 654 901 688">DB</td> <td data-bbox="901 654 1065 688">(mm)</td> </tr> </table>	L	(mm)	DB	(mm)	<b>PE320317I</b>	
L	(mm)								
DB	(mm)								