



Catálogo de Aplicaciones
Bujías de Encendido

Nomenclatura de códigos

5

Detalles técnicos del producto

6

Cuidados en el montaje

8

Bujías de encendido
Aplicación por arca y vehículo

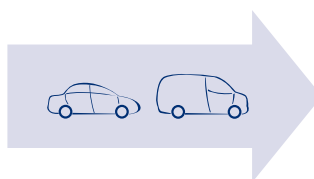

9

Bujías de encendido
Equivalencias por código



33

Bujías de encendido
Info Técnica - Luz de bujía sugerido



36

Kits de encendido
Aplicaciones e imágenes por código

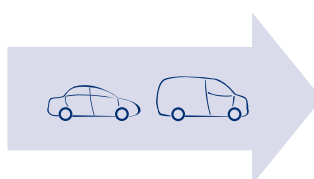

37

NOMENCLATURA PARA LECTURA DE CÓDIGOS

CT 5 F M R 1

B	Semi conductor
C	Electrodo de núcleo de cobre
D	Electrodo de masa doble
E	Punta proyectiva localizada de 3 MM
F	Electrodo de bujía especial ranurada
G	Electrodo de Iridium
H	Electrodo de masa redonda
I	Bujía de iridio
J	Electrodo Tri masa
K	Punta proyectiva localizada de 5 MM
L	Punta proyectiva localizada de 4 MM
P	Bujía de platinum individual
PP	Bujía de doble platinum
PPF	Doble platinum especial
Q	Bujía de cuatro electrodos
S	Electrodo de plata
T	Punta proyectiva localizada menos de 3 MM
U	Electrodo U-Groove
W	Aislador sin costilla
X	1.1 mm de brecha o más
Y	Brecha superficial
Z	Punta proyectiva localizada de 7 MM

AM	M10x1	12.7mm	KHM	M14x1.25	26.5mm
BM	M10x1	19mm	LM	M14x1.25	9.5mm
CM	M12x1.25	12.7mm	MM	Bantam M14x1.25	11mm
CHM	M12x1.25	26.5mm	NM	Bantam M14x1.25	7.8mm
CZM	M12x1.25	11.2mm	PM	M14x1.25	11.2mm
DM	M12x1.25	19mm	QM	M14x1.25	17.5mm
DEM	M12x1.25	12.7mm	QHM	M14x1.25	25mm
DFM	M12x1.25	19mm	RM	M18x1.5	12mm
DHM	M12x1.25	26.5mm	RFM	M18x1.5	19mm
DKM	M12x1.25	19mm	RHM	M18x1.5	26.5mm
DZM	M12x1.25	17.5mm	SM	M18x1.5	19mm
EM	M14x1.25	12.7mm	SEM	M18x1.5	12.7mm
FM	M14x1.25	19mm	SHM	M18x1.5	26.5mm
FHM	M14x1.25	26.5mm	TM	M18x1.5	10.9mm
GM	M14x1.25	9.5mm	TFM	M18x1.5	17.5mm
GLM	Bantam M14x1.25	9.5mm	THM	M18x1.5	25mm
HM	M14x1.25	11mm	UM	M14x1.25	12.3mm
JM	M8x1.0	19mm	VHM	M12x1.25	26.5mm
KM	M14x1.25	19mm	WM	M14x1.25	21mm
KEM	M14x1.25	12.7mm	ZM	M14x1.25	11mm

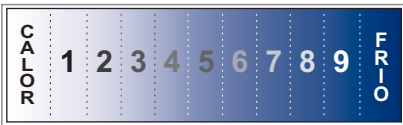

RESISTENCIA ANTIPARASITARIA

- 1** Distancia electrodos 1/1.1mm
- 3** Distancia electrodos 1/1.3mm
- 5** Distancia electrodos 1/1.5mm

Bujías de encendido Magneti Marelli

Una marca internacional, un espíritu dinámico y una historia significativa. Éstas han sido siempre las connotaciones de un desarrollo rápido y continuo, acompañando la evolución del automóvil.

Magneti Marelli ha proyectado y realizado una gama integrada y completa de bujías de encendido para satisfacer las más altas exigencias, capaz de responder a todo tipo de conducción en cualquier tipo de recorrido.

Modelos:

- **Evolution**
- **Evolution Platinum**
- **Evolution Iridium**

El diseño y tecnología aplicado en estas bujías incrementa el poder de ignición, sin fallos de encendido, mejorando la combustión y generando aumento de potencia del motor.

Claves para una alta confiabilidad

Avanzada Tecnología Laser de Soldadura

La experiencia en soldadura Laser aseguran la tecnología empleada para unir metales preciosos de aleación con Níquel, como el Iridio, Platino o aleación de Paladio.

Nuevas Cerámicas Dieléctricas

La Cerámica de grano más fino de última generación con una mayor densidad, generan las condiciones que impiden la avería eléctrica del aislador.

Resistor Monolítico altamente fiable

Garantiza alta fiabilidad para resistir altas presiones de combustión, incorporando un Resistor monolítico ultra resistente, que se adhiere al vidrio del Resistor en el horno de alta temperatura. Además elimina la interferencia que el ruido eléctrico de alta energía produce a los equipos electrónicos, presentes en los vehículos actuales.

Aleación de Níquel especial con mejor resistencia a la corrosión

El electrodo central está compuesto de una aleación binaria de níquel y cromo resistente al desgaste, con un núcleo de cobre de inserción profunda, lo que proporciona al electrodo central una alta resistencia al sobrecalentamiento y una mayor vida útil.

Bujías Evolution Iridium de Larga Vida

El último desarrollo de **Magneti Marelli** es una nueva generación revolucionaria de bujías con un **electrodo central** de una **aleación de iridio especial**.

Tras una experiencia de años con bujías doble platino, dimos un gran paso con este nuevo material innovador.

Las bujías **Evolution Iridium Magneti Marelli** han sido desarrolladas para la última generación de motores y pueden exceder fácilmente intervalos de prestación de 100.000 km. La aleación de iridio tiene una mayor resistencia que el platino, permitiendo una reducción del diámetro del electrodo central hasta 0.6 mm.

- **Tensión requerida muy baja durante la vida útil**
- **Alto rendimiento en combinación con una vida útil prolongada**
- **Control mejorado de emisión**

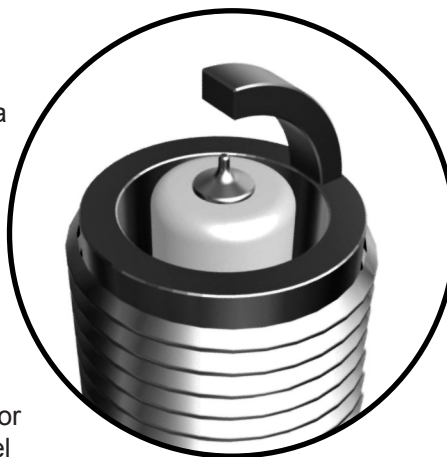

Diseños Especiales

V-Groove Electrodo central

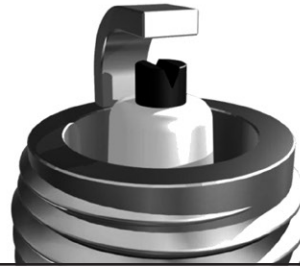

U-Groove Electrodo masa



Dos Electrodo de masa



Tres Electrodo de masa

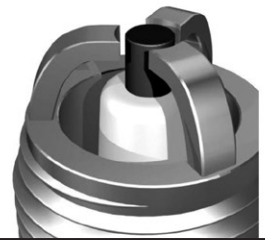

Cuatro Electrodo de masa



Cuidados en el montaje

Especificaciones del par de apriete para bujías.

La tabla a continuación indica las recomendaciones del par de ajuste para una buena instalación de las bujías. El no instalarlas como es debido puede redundar en daños del motor o en un rendimiento no satisfactorio, tanto si el apriete es menor o mayor al recomendado. Al apretar una bujía puede ocurrir que se pierda el aislador causando daños a la bujía y al motor del vehículo.

Diámetro de cabeza	Torque recomendado
18 mm	35 a 40 Nm (3,5 a 4 kgm)
14 mm	25 a 30 Nm (2,5 a 3 kgm)
12 mm	15 a 20 Nm (1,5 a 4 kgm)
10 mm	10 a 12 Nm (1 a 1,2 kgm)
8 mm	8 a 10 Nm (0,8 a 1 kgm)

Tipos de asientos cónicos para bujías sin juntas:

Torque recomendado
10 a 20 Nm (1 a 2 kgm)

Par de apriete recomendado

Tipos de bujías de encendido	Diámetro de la rosca	Culata del motor de hierro fundido	Culata del motor de aluminio
Asiento plano (Con empaquetadura)	18 mm	3.5 - 4.5 Kgf.m (25.3 - 32.5 lb-ft)	3.5 - 4.0 kgf.m (25.3 - 28.8 lb-ft)
	14 mm	2.5 - 3.5 Kgf.m (18.0 - 25.3 lb-ft)	2.5 - 3.0 kgf.m (18.0 - 21.6 lb-ft)
	12 mm	1.5 - 2.5 Kgf.m (10.8 - 18.0 lb-ft)	1.5 - 2.0 kgf.m (10.8 - 14.5 lb-ft)
	10 mm	1.0 - 1.5 Kgf.m (7.2 - 10.8 lb-ft)	1.0 - 1.2 kgf.m (7.2 - 8.7 lb-ft)
Asiento cónico (Sin empaquetadura)	18 mm	2.0 - 3.0 Kgf.m (14.5 - 21.6 lb-ft)	2.0 - 3.0 kgf.m (14.5 - 21.6 lb-ft)
	14 mm	1.5 - 2.5 Kgf.m (10.8 - 18.0 lb-ft)	1.0 - 2.0 kgf.m (7.2 - 14.5 lb-ft)

Bujía de asiento plano

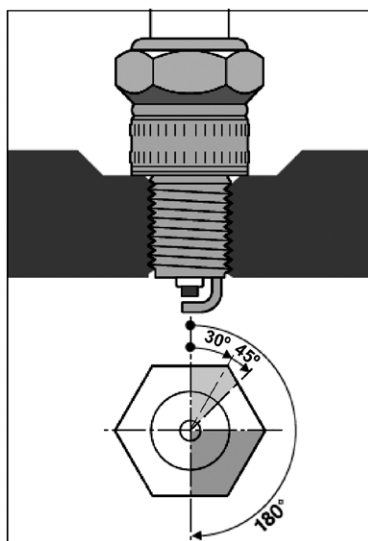

Bujías con asiento plano y diámetro de la rosca de 10, 12 14 y 18 mm.

Bujías nuevas 1/2 vuelta (180°).
Reutilizadas 1/12 a 1/8 vuelta (30° a 45°).

Bujía de asiento cónico.

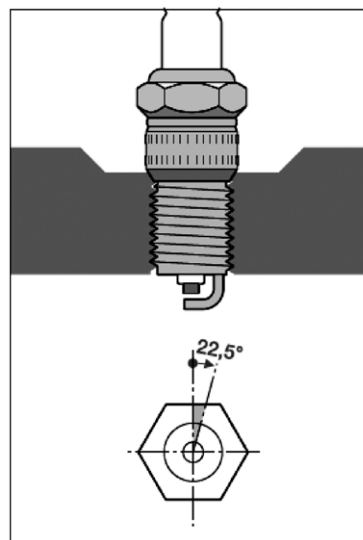

Bujías con asiento cónico.

Bujías nuevas o reutilizadas 1/16 vuelta (22,5°).

Bujías de encendido

Aplicación por marca y vehículo

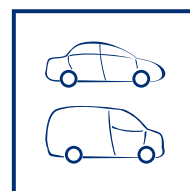

MOTOR

ALFA ROMEO

33	1.7 IE 16V (AR30746) M8	90->	CT6KMR
33 SW	1.7 IE16V 4X4 (AR30746) M8	90->	CT6KMR
146	1.8 IE 16VTS (AR32201) M11	98-99	CT6KMR
156 SW	2.0 TS 16V (AR32301 CF2) M3	00->	CT6KMR
GTV	3.0	96->	CT6FMR

AUDI

A3	1.6 (AVU)	00->	YD6KMR
A3	1.8 T	97-05	PPT6KMR
A3	2.0 FSI	08->	PIT7KMR
A3	2.0T FSI	08->	PIT7KMR
A3 Sportback	2.0 FSI	08->	PIT7KMR
A3 Sportback	2.0T FSI	08->	PIT7KMR
A4	1.8 T 20V	95-04	PPT6KMR
A4	2.0 FSI	07->	PIT7KMR
A4	2.0T FSI	09->	PIT7KMR
A4 AVANT	2.0T FSI	10->	PIT7KMR
A5 Sportback	2.0 T FSI	10->	PIT7KMR
A5 CABRIO	2.0 T FSI	10-12	PIT7KMR
A5 COUPE	2.0 T FSI	10->	PIT7KMR
ALLROAD	2.0 T FSI	09-11	PIT7KMR
Q3	2.0 T FSI	12->	PIT7KMR
Q5	2.0 T FSI	09->	PIT7KMR
S3	2.0 T FSI	08->	PIT7KMR
TT	2.0 T FSI	06->	PIT7KMR
TT Roadster	1.8 T	00-05	PPT6KMR

BMW

116i	N13 B16A	2013->	PIT7UHMR
118i	N13 B16A	2013->	PIT7UHMR
316 TI COMPACT	(N42B18A;NG4)	01-04	YD6KMR
316I	(164E 1;M40)	89-93	YD6KMR
316I	(16 4E2;M 43B16)	93-98	YD6KMR

MOTOR

316I	COMPACT (164E2;M 43B16)	94-00	YD6KMR
316I COUPE	(164E 2;M43B16)	93-99	YD6KMR
318I	(184E Z;M10 E18)	79-83	CT5FMR
318I	(18 4KA;M 10B18KAT)	83-87	CT5FMR
318I	(18 4E1;M 40B18)	87-91	YD6KMR
318I	(18 4E1;M 40B18)	91-94	YD6KMR
318I	(19 4E1;M 43B19	95-01	YD6KMR
318I CABRIO	(184S 1;M42B18)	93-96	YD6KMR
318IS	(18 4S1;M 42B18)	89-96	YD6KMR
318IS COUPE	(184S 1;M42B18)	92-96	YD6KMR
318TI COMPACT	(184S 1;M42B18)	94-96	YD6KMR
320I	(22 6S1;M54)	00-05	YD6KMR
320I	(20 6S1/2;M 50B20)	90-95	YD6KMR
320I COUPE	(206S 1/2;M50B20)	92-95	YD6KMR
323I	(25 6S4;M 52B25)	98-00	YD6KMR
323TI COMPACT	(256S 3;M52B25)	97-00	YD6KMR
325CI COUPE	(256S 5;M54)	00-06	YD6KMR
325I	(25 6S5;M54)	00-05	YD6KMR
325I CABRIO	(256S 2;M50B25)	93-95	YD6KMR
325I COUPE	(256S 2;M50B25)	92-93	YD6KMR
325I COUPE	(256S 2;M50B25)	93-95	YD6KMR
325TI COMPACT	(256S 5;M54)	04-04	YD6KMR
328CI COUPE	(286S 2;M52B28)	98-00	YD6KMR
328I	(28 6S1) (M52B28)	94-98	YD6KMR
328I	(28 6S2) (M52B28)	98-00	YD6KMR
328I CABRIO	(286S 1;M52B28)	95-99	YD6KMR
328I CABRIO	(286S 1;M52B28)	95-99	YD6KMR
328I TOURING	(286S 1;M52B28)	95-99	YD6KMR
330CI CABRIO	(306S 3;M54)	00-07	YD6KMR
330CI COUPE	(306S 3;M54)	00-06	YD6KMR
330I	(306S 3;M54)	00-05	YD6KMR
520I	(20 6S1/2;M 50B20)	89-95	YD6KMR
523I	(25 6S4)	98-00	YD6KMR
525I	(25 6S5;M 54)	00-03	YD6KMR

MOTOR

525I	(25 6S5;M 50B25)	90-93	YD6KMR
525I	(25 6S2;M 50B25)	93-96	YD6KMR
525I TOURING	(256S 1/2;M50B25)	91-96	YD6KMR
528I	(28 6S1;M 52B28)	96-98	YD6KMR
528I	(28 6S2;M 52B28)	98-00	YD6KMR
530I	(30 6S3;M 54)	00-03	YD6KMR
530I	(30 8S1;M 60B30)	92-95	YD6KMR
530I TOURING	(306S 1;M54)	00-04	YD6KMR
530I TOURING	(308S 1;M60B30)	92-96	YD6KMR
535I	(34 6EC;M 30B35)	84-87	CT5FMR
540I	(40 8S1/2;M 60B40)	92-03	YD6KMR
540I	(40 8S1;M 60B40)	92-95	YD6KMR
540I TOURING	(448S 1/2;M62B44)	97-04	YD6KMR
740I	(44 8S1/2;M 62B44)	96-01	YD6KMR
750I	(54 121/2;M 73B54)	94-01	YD6KMR

CHEVROLET

400	230/250	<-77	CT4FM
AGILE	1.4 (X14YX)	09->	CT6FMR
ASTRA	1.8 MPFI (C18NE)SOHC	98->	CT6FMR
ASTRA	2.0 16V MPFI	02-03	YD5KMR1
ASTRA	2.0 MPFI (C20NE;SOHC)	98->	CT6FMR
ASTRA	2.4 16V (X24SE)	05-10	YD6KMR
AVEO	1.6 (F16D)	08->	CT6KMR1
BLAZER	2.2 MPFI	97-00	CT5FMR
BLAZER	2.4 16V (X24SE)	06-07	YD6KMR
C-10	4.1 GM-OHV	88-93	CT4FM
C-20	4.1 GM-OHV	94-96	CT4FM
CAPTIVA	2.4 16V (Z24CED)	11->	YD5KMR1
CELTA	1.4 8V (C14SE)	11->	CT5FMR
CHEVY	230/250	<-79	CT4FM
CLASSIC	1.4 8V (X14Y)	09->	CT5FMR
COBALT	1.8 (BK)	13->	A6KMR1

MOTOR

CORSA	1.0 (C10NE) SOHC	00-03	CT6FMR
CORSA	1.4 EFI (C14NE) SOHC	96-02	CT6FMR
CORSA	1.6 16V MPFI (BE;POWERTECH)	96	YD6KMR
CORSA	1.6 8V (C16NE)	98->	CT6FMR
CORSA	1.6 MPFI (C16NE) POWERTECH	<-96	CT6FMR
CORSA II	1.8 MPFI (CE18NE)	05->	CT6FMR
CRUZE	1.8 16V Ecotec (Platino / Iridium)	10-17	PIT6KMR1
CRUZE	1.8 16V Ecotec	10-17	G6KMR
GRAND VITARA	1.6 16V(G16B)	00->	CT6KMR1
GRAND VITARA	2.0 16V(J20A)DOHC	98->	CT6KMR1
GRAND VITARA	2.5 24V(H25A)	00->	CT6KMR1
IPANEMA	1.8 8V (18SE)	93-97	CT5FMR
IPANEMA	1.8 8V (18SE) (carburardor)	93-97	CT5FMR1
KADETT	1.8 8V (18SE)	91-97	CT5FMR
KADETT	1.8 8V (18SE) (carburardor)	91-97	CT5FMR1
KADETT	2.0 8V (C20NE)	91-95	CT5FMR
LUV	2.3 Isuzu 4ZD1	92-99	CT5FMR
MERIVA	1.8 16V (C18SEL)	03-06	YD6KMR
MERIVA	1.8 MPFI	03-06	CT6FMR
MONTANA	1.8 8V EFI	11->	CT6FMR
MONZA	1.8 8V	94-98	CT5FMR
MONZA	1.8 8V (18SE) (carburardor)	94-98	CT5FMR1
MONZA	2.0 8V	94-98	CT5FMR
OMEGA	2.0 8V (C20NE)	93-95	CT5FMR
OMEGA	2.2 (C22NE)	94-97	CT5FMR
ONIX	1.4 8V (SPE-4)	13->	CT6FMR
PRISMA	1.4 8V (C14SE)	11-13	CT6FMR
PRISMA II	1.4 8V (SPE-4)	13->	CT6FMR
S10	2.2 MPFI (B22NZ)	95-99	CT5FMR
S10	2.4 16V		YD6KMR
SILVERADO	4.1 POWERTECH (C41GE)	96-01	CT6FMR
SONIC	1.6 16V (Platino / Iridium)	12-16	PIT6KMR1
SONIC	1.6 16V	12-16	G6KMR

MOTOR

SPARK	1.0 (S-TEC)	09->	CT6FMR
SPIN	1.8 8V	12->	CT6FMR
TIGRA	1.6 16V	98- 01	YD6KMR
TRACKER	1.8 16V Ecotec (Platino / Iridium)	13-20	PIT6KMR1
TRACKER	1.8 16V Ecotec	13-20	G6KMR
VECTRA	2.0 16V MPFI	08-12	YD5KMR1
VECTRA	2.0 MPFI (C20NE) SOHC	98->	CT6FMR
VECTRA	2.2 1.6V MPFI (JW/JX) DOHC	96-06	YD5KMR1
VECTRA	2.4 16V (Z24CED)	07	YD6KMR
ZAFIRA	2.0 16V MPFI	01-09	YD5KMR1
ZAFIRA	2.0 MPFI (C20NE)SOHC	98->	CT6FMR

CHRYSLER

NEON	1.8 16V (EBD)VIN-A	97-00	CT6KMR
NEON	2.0 16V (ECB)VIN-C	94-00	CT6KMR
STRATUS	2.0 16V (ECB; ECO)C MPI	97-00	CT6KMR

CITROËN

2CV	0.45		CT5EM
3CV	0.6		CT5EM
AMI 8	0.6		CT5EM
AX	1.1 (TU1MZ)		CT6KMR
AX	1.4 (TU3FJ2)		CT6KMR
BERLINGO	1.4 (TU3JP)	03->	CT6KMR
BERLINGO	1.6 16V (TU5JPA)	10->	MT5KMR
BERLINGO	1.8 (LFX;XU7JB)	02-04	CT6KMR
BX	1.9 (XU9J2)	90-93	CT6KMR
C-ELYSSE	1.6 16V VTI (EC5)	16->	MT5KMR
C3	1.5 (TU3)	12->	CT6KMR
C3	1.6 16V (NFU;TU5JP4)	05-02	MT5KMR
C3 AIRCROSS	1.5 (TU4)	16->	CT6KMR
C3 AIRCROSS	1.6 16V (NFU)(TU5JP4)	08-13	MT5KMR
C3 AIRCROSS	1.6 16V VTI (EC5)	16->	MT5KMR

MOTOR

C3 PICASSO	1.5 (TU4)	13-16	CT6KMR
C3 PICASSO	1.6 16V (NFU)(TU5JP4)	11-13	MT5KMR
C3 PICASSO	1.6 16V VTI (EC5)	13-16	MT5KMR
C4	1.6 16V (NFU;TU5JP4)	07-14	MT5KMR
C4	2.0 16V (RFN;EW10J4)	07-14	MT5KMR
C4 CACTUS	1.6 16V THP	18->	PIT7UHMR
C4 CACTUS	1.6 16V VTI (EC5)	18->	MT5KMR
C4 LOUNGE	1.6 THP 163cv	13->	PIT7UHMR
C4 LOUNGE	1.6 16V VTI (EC5)	17->	MT5KMR
C4 LOUNGE	1.6 16V THP	13->	PIT7UHMR
C4 LOUNGE	2.0 16V (EW10)	13->	MT5KMR
C4 PICASSO	1.6 THP (EP6CDT)	16->	PIT7UHMR
C4 PICASSO	2.0 16V(NFU;TU5JP4)	09-13	MT5KMR
C5	1.6 THP (EP6CDT)	11->	PIT7UHMR
DS3	1.6 THP (EP6CDT)	10->	PIT7UHMR
DS4	1.6 THP (EP6CDT)	12->	PIT7UHMR
DS5	1.6 THP (EP6CDT)	14->	PIT7UHMR
MEHARI	0.6	72-86	CT5EM
SAXO	1.1 (TU1M)	01-04	CT6KMR
SAXO	1.4 (TU3JP)	01-03	CT6KMR
SAXO	1.6 (TU5JP)		CT6KMR
SPACE TOURNER	1.6 THP (EP6CDT)	18->	PIT7UHMR
XANTIA	2.0 16V		YD6KMR1
XM	2.0	95-96	CT7KMR
XSARA	1.8 (LFZ;TU7JP/L3)	98-02	CT6KMR
XSARA	2.0 16V (RFN;EW10J4)	99-01	MT5KMR
XSARA PICASSO	1.6 16V (NFU;TU5JP4)	05-12	MT5KMR
XSARA PICASSO	2.0 16V (NFU;TU5JP4)	99-11	MT5KMR
XSARA VTS	2.0 16V (RFN;EW10J4)	01-04	MT5KMR
ZX	1.4 (TU3MC)	93-96	CT6KMR
ZX	1.8 (XU7JP)	93-98	CT6KMR
ZX	2.0 (XU10J2C)	93-95	CT6KMR
ZX	2.0 16V (XU10J4D)	93-99	CT7KMR



MOTOR



DAEWOO

LEGANZA	2.0	93-99	YD5KMR1
NUBIRA	2.0	97-98	YD5KMR1
TICO	0.8H800	95-97	CT5FMR1

DAHIATSU

APPLAUSE	1.6	91-01	CT6KMR1
CHARADE	1.3	93-97	CT6KMR1
CHARADE	1.5	94-96	CT5FMR
CUORE	0.5	91-01	CT6FMR
FEROZA	1.6	91-01	CT6KMR1
SIRION	1.0 12V	98-00	CT6KMR1
TERIOS	1.3 16V	97-99	CT6KMR1

DODGE

JOURNEY	2.4	18->	A6KMR1
---------	-----	------	--------

DS

DS3	1.6 16V THP		PIT7UHMR
DS4	1.6 16V THP		PIT7UHMR
DS4 CROSSBACK	1.6 16V THP		PIT7UHMR

FIAT

125	1.6 (BC 038)	71->	CT6FM
128	1.1	71->	CT5FM
128	1.3	<-89	CT5FM
128	1.5	85-91	CT5FM
133	0.9	<-80	CT5FM
147	1.1	83-86	CT5FM
500	1.4 FIRE EVO	12->	CT7DKMR3
500	1.4 16V FIRE	09->	CT7DKMR
500 L	1.4 16V FIRE	14->	CT7DKMR
600	0.85	75->	CT5FM
600	0.6	<-75	CT5EM

MOTOR

800	0.8	TODOS	CT5EM
ARGO	1.3 Firefly	17->	CT8BNMR*
ARGO	1.8 E-torque Evo	17->	IT7DKMR1*
BARCHETA	1.8 16V (183A1000)	95-02	YD6KMR
BARCHETA	2.0 16V	94-95	CT7FMR
BRAVA	1.6 16VV (182a4000)	00-03	YD6KMR
BRAVO	2.0 20v (155CV) (182B7000)	99-02	YD6KMR
BRIO	1.1 (128A011)	87-91	CT5FM
COUPE	2.0 16V (836A3000)	94-01	CT7FMR
COUPE	2.0 20v (182A1000)	94-01	YD6KMR
CRONOS	1.3 Firefly	17->	CT8BNMR*
CRONOS	1.8 E-torque Evo	17->	IT7DKMR1*
DOBLO	1.4 16V FIRE (843 A1)	12->	CT7DKMR
DOBLO CARGO	1.4 16V FIRE (843 A1)	12->	CT7DKMR
DUNA	1.3 Carburador	88-01	CT5FM
DUNA	1.3 Mpi (146A5000)	01-04	YD6KMR
DUNA	1.4 (M/TIPO)	94-01	CT5FMR
DUNA	1.5 Carburador	88-95	CT6FMR
DUNA	1.6 (M/TIPO)	91-00	CT5FMR
FIORINO	1.3	89-94	CT5FM
FIORINO	1.3 8V FIRE	01-04	CT6KMR
FIORINO	1.3 Mpi	95-03	CT6KMR
FIORINO	1.4 (M/TIPO)	89-98	CT5FMR
FIORINO NOVO	1.4 8V FIRE EVO	14->	CT7DKMR3
GRAND SIENA	1.4 8V FIRE EVO (327A055)	13->	CT7DKMR3
GRAND SIENA	1.6 16V E-TORQ (178F 4055)	13->	A6KMR
IDEA	1.4 (178F5038)FIRE	07- 13	CT6KMR
IDEA	1.4 FIRE EVO	13->	CT7DKMR3
IDEA	1.6 16V E-TORQUE	11->	A6KMR
IDEA	1.8 8V	<-11	CT6FMR
LINEA	1.8 16V E-TORQUE	11->	A6KMR
LINEA	1.9 16V TORQUE	09-11	YD6KMR
MAREA	1.6 16V	98-05	CT7KMR
MAREA	2.0 20v	98-04	YD6KMR

	MOTOR		
MOBI	1.0 8V FIRE	16->	CT6KMR
PALIO	1.3 16V FIRE	03-06	CT7DKMR
PALIO	1.3 MPI	00->	CT6KMR
PALIO	1.4 FIRE	08-09	CT6KMR
PALIO	1.4 FIRE EVO	13->	CT7DKMR3
PALIO	1.6 16V TORQUE	97-01	YD6KMR
PALIO	1.6 8V	97-01	YD5KMR1
PALIO	1.8 8V	07-12	CT6FMR
PALIO	1.6 16V E-TORQUE	11->	A6KMR
PUNTO	1.4 FIRE	07-12	CT6KMR
PUNTO	1.4 FIRE EVO	12->	CT7DKMR3
PUNTO	1.6 16V E-TORQUE	12->	A6KMR
PUNTO	1.8 8V	07-11	CT6FMR
QUBO	1.4	12->	CT6KMR
QUBO FIORINO	1.4	12->	CT6KMR
REGATTA 100S	1.6 TIPO	90-95	CT5FM
REGATTA 2000	2.0	89-96	CT6FM
REGATTA 85	1.5	85-91	CT5FM
SIENA	1.3 16V FIRE	02-07	CT7DKMR
SIENA	1.3 Mpi	00->	CT6KMR
SIENA	1.4 8V FIRE (178F5038)	07-12	CT6KMR
SIENA	1.4 8V FIRE EVO	13->	CT7DKMR3
SIENA	1.6 16V TORQUE	97-01	YD6KMR
SIENA	1.6 16V E-TORQUE	11->	A6KMR
SIENA	1.6 8V Spi	01-03	YD5KMR1
SIENA	1.8 8V	04-11	CT6FMR
SPAZIO	1.3	91-92	CT5FM
SPAZIO	1.4 (192 A4000) (M/TIPO)	91-97	CT5FM
STILO	1.8 16V	03-05	YD6KMR
STILO	1.8(M20)	04->	CT6FMR
STRADA	1.3 FIREFLY	20->	CT8BNMR*
STRADA	1.4 8V FIRE EVO	12->	CT7DKMR3
STRADA	1.4 FIRE 8V(178F5038)	<-12	CT6KMR

MOTOR

STRADA ADVENTURE	1.6 16V E TORQUE	10->	A6KMR
STRADA ADVENTURE	1.8 8V	<-11	CT6FMR
TEMPRA	2.0	93-98	CT5FMR
TEMPRA	2.0 16V	93-96	CT6FMR
TIPO	1.4 IE (149C 2046)M7	93-95	CT6FMR
TIPO	1.6 IE	93-96	CT6KMR
TIPO	1.6 Mpi	95-97	CT5FMR
TIPO	1.6 E-torque Evo	18->	IT7DKMR1*
TIPO	2.0 16V	93-95	CT7FMR
TORO	1.8 E-torque Evo	19->	IT7DKMR1*
UNO	1.3 FIRE 8V	05-13	CT6KMR
UNO	1.3MPI	02-05	CT6KMR
UNO	1.4 (MOTOR TIPO)	92->	CT5FM
UNO	1.5	88-94	CT6FMR
UNO	1.6 (MOTOR TIPO)	92->	CT5FMR
UNO NOVO	1.4 8V FIRE EVO	10->	CT7DKMR3
UNO WAY	1.3 Firefly	19->	CT8BNMR*
VIVACE	1.4 (MOTOR TIPO)	92-97	CT5FMR

FORD

BRONCO	4.0 V6		CT5QMR1
COURIER	1.4 16V ZETEC (FHA)	97-00	PPT6QHMR1
COURIER	1.6 8V Zetec Rocam SOHC (CLKB)	05-11	CT6QHMR1
ECOSPORT	1.6 8V Zetec Rocam SOHC (CLKB)	03-12	CT6QHMR1
ECOSPORT	1.6 16V Sigma (Bujía de cobre)	12-18	F7QHMR1
ECOSPORT	1.6 16V SIGMA TI-VCT	12->	PIT6QHMR
ECOSPORT	2.0 16V (CHT;DURATEC HE)	03-13	PPT6QMR3
ESCORT	1.6 (AE / CHT)	88-91	CT6KMR
ESCORT	1.6 (AP)	91-96	CT5FMR
ESCORT	1.6 16V (SIGMA TI-VCT)		PIT6QHMR
ESCORT	1.6 (ZETEC ROCAM)	01-03	CT6QHMR1
ESCORT	1.8 (AUDI)	92->	CT6FMR
ESCORT	1.8 16V (ZETEC)	97-03	PPT6QHMR1
ESCORT XR3	1.8 (AUDI)	94->	CT6FMR

	MOTOR		
ESCORT XR3	2.0 (AUDI)	94->	CT7FMR
EXPLORER	4.0 V6	93-01	CT5QMR1
F100	3.6	<-93	CT4TM
F100	3.6 MAX ECONO	<-97	CT6QM
F100	4.9i CJAD	85-99	CT5TMR2
F100	V8 FASE 2	75-82	CT4TM
F100	V8 FASE 1	<-75	CT6TM
F150	3.6	83-97	CT4TM
FAIRLANE	3.6 LTd 6Cilindros 6L		CT4TM
FAIRLANE	4.8 V8		CT4TM
FALCON	2.3		CT6QM
FALCON	3.0		CT4TM
FALCON	3.6	83-91	CT4TM
FALCON	3.6 MAX ECONO		CT6QM
FALCON RANCHERO	3.6 (J4)	83-91	CT4TM
FIESTA	1.3 iEndura-E	94-99	CT5QMR1
FIESTA	1.4 16V(ZETEC)	96-99	PPT6QHMR1
FIESTA	1.6 8V ZetecRocam 1.6SOHC(CDJA/C)	02->	CT6QHMR1
FIESTA	1.6 16V Sigma (Bujía de cobre)	10->	F7QHMR1
FIESTA KINETIC	1.6 16V Sigma TI- VCT	10->	PIT6QHMR
FOCUS	1.8 16V (EDDC;ZETEC)	98-05	PPT6QHMR1
FOCUS	2.0 16V (ZETEC)	05-10	PPT6QHMR1
FOCUS II	1.6 8V ROCAM	<-13	CT6QHMR1
FOCUS II	2.0 16VDuratec-HE (AODA)	08->	PPT6QMR3
FOCUS II	1.6 16V Sigma	10-13	PIT6QHMR
FOCUS II	1.6 16V Sigma (Bujía de cobre)	10-14	F7QHMR1
GALAXY	2.0 (AP 2000CARBURADO)	<-95	CT6FMR
GALAXY	2.0 (AP 2000INYECCION)	95->	CT7FMR
GRANADA	2.8	<-85	CT7FMR
KA	1.0 Zetec Rocam1.0 (C4C)	99-08	CT6QHMR1
KA	1.3 Endura-E 1.3(A9A)	97-99	CT5QMR1
KA	1.6 Zetec Rocam1.6 SOHC(CCB)	01-08	CT6QHMR1
KA	1.6 16V Sigma (Bujía de cobre)	16->	F7QHMR1
MONDEO	1.8 16V (NGC;ZETEC)	94-00	PPT6QHMR1

MOTOR

MONDEO	2.0 16V (CJB;ZETEC)	96-00	PPT6QHMR1
MONDEO	2.0 16V (SEAV6;DURATEC HESFI)	01-09	PPT6QMR3
MONDEO	3.0 ST 220		PPT6QMR3
ORION	1.6 (AUDI)	92->	CT6FMR
ORION	1.8 (AUDI)	92->	CT6FMR
ORION	2.0 (AUDI)	94->	CT7FMR
PUMA	1.7 16V Zetec		PPT6QHMR1
RANGER	2.5 (SOHC- 8 BUJIAS)	98-01	CT5QMR1
SIERRA	1.6 1.6 LEMAX	84-91	CT6TM
SIERRA	2.3	84-93	CT6QM
SIERRA	2.3 XR4	84-91	CT6QM
TAUNUS	2.0	<-84	CT6QM
TAUNUS	2.3	<-85	CT6QM
TAUNUS	2.3 SP	83-85	CT6QM

HONDA

CITY	1.5 16V	09->	CT6KMR1
CIVIC	1.5 16V (D15B2)	91-96	CT6KMR1
CIVIC	1.6 16V (B16A2)	91->	CT6KMR1
CIVIC	1.6 16V (D16Z6)	91->	CT6KMR1
CIVIC	1.6 16V COUPE (D16Y8)	96->	CT6KMR1
CIVIC	1.8 16V I-vetec (R18A2)	08->	PIB7LDKMR1
CIVIC	2.0 16V I-vetec (150CV)	10->	PIB7LDKMR1
CR-V	2.0 B20Z1	97-02	A6KMR1
CR-V	2.4 K24A1	06-12	A6KMR1
FIT	1.4 L13A1	03-08	A6KMR1
FIT	1.4 L13Z	09->	A6KMR1
FIT	1.5 L15A	09->	A6KMR1
HR-V	1.6 SOHC VTECD16W5	00-03	A6KMR1
HR-V	1.8 16V I-vetec	15->	PIB7LDKMR1
PRELUDE	2.2 F22A2 SOHC	96-00	A6KMR1

HYUNDAI

ACCENT	1.5 G4EK	94-99	CT6KMR1
ATOS	1.0 (G4HC) EPSILON	97-01	CT6KMR

MOTOR

COUPE	2.0 16V (G4GF)BETA	96->	CT6KMR1
COUPE	2.7 V6 (G6BA-G)	01->	CT6KMR1
ELANTRA	1.6 16V(G4DJ)NEWSIRIUS	90-95	CT6KMR1
ELANTRA	1.8 16V (G4GB)	00-06	CT6KMR
ELANTRA	2.0 16V(G4)	00->	CT6KMR1
GALLOPER	3.0 G6-T	99-01	CT5FMR1
i30	2.0	09->	CT6KMR1
SONATA	3.0 V6 G6-T	97-98	CT5FMR1
TUCSON	2.0 4X4 (G4GC)	04->	CT6KMR1

ISUZU

RODEO	2.6 4ZE1	92-95	CT5FMR1
RODEO	3.2 4WD (6VD1)SOHCKAT.VINW	92->	CT6KMR1
TROOPER	3.2 24V (6VDI)	92->	CT6KMR1

JEEP

CHEROKEE	3.7 (EKG;K)	01->	CT6KMR1
CHEROKEE	4.0 (ERH;VIN-S)	94->	CT6KMR1
COMPASS	2.4 16V	07-13	A6KMR1
RENEGADE	1.8 E-torque Evo	16->	IT7DKMR1*

KIA

AVELLA	1.5 B5	98-01	CT5FMR1
CARENS	1.8 (TB)	02	CT6KMR
CARENS	1.8 (TB;TED)	00-02	CT6KMR
CARNIVAL	2.5 D4EA	06-07	A6KMR1
PICANTO	1.1 (G4HG)	04->	CT6KMR1
PRIDE	1.3 (B3)	95-00	CT6FMR
RIO	1.6 (G4ED)	05	CT6KMR1

LAND ROVER

DISCOVERY	4.0 V8 EFI(OHV)	98->	CT6FMR
DISCOVERY	3.5		CT6FMR
RANGE ROVER	3.5		CT6FMR

MOTOR

RANGE ROVER	4.6	96-03	CT6FMR
RANGE ROVER	3.9		CT5FMR

MAZDA

121	1.3 (B3)	90-93	CT6KMR1
323	1.3 (B3)	98-00	CT6KMR1
323	1.6 (BPBE)	95-99	CT6KMR1
626	2.2 4WD WAGON(F2L1)KAT	92-97	CT6KMR1

MERCEDES BENZ

C180	(M 111.920)E18	93-95	CT6KMR
C230	M111.974) E23	97-98	CT6KMR
E320	(M 104.992)	93-95	CT6KMR
E320T	(M104.992)	93-96	CT6KMR
S320	(M104.990)	93-99	CT6KMR
SL600	(M 120.981)	93-02	CT6KMR

MINI

COOPER S PACEMAN	1.6 S (N18 B16A)	2013->	PIT7UHMR
COUNTRYMAN	1.6 S (N12 B16A, N14 B16A)	2013->	PIT7UHMR
COUNTRYMAN JCW	1.6 S (N18 B16A)	2013->	PIT7UHMR
COOPER CABRIO	1.6 (N12 B16A)	2013->	PIT7UHMR
COUPE JCW	1.6 S (N18 B16A)	2013->	PIT7UHMR
COUPE S	1.6 S (N14 B16A)	2013->	PIT7UHMR

MITSUBISHI

COLT	1.2		CT5FMR
COLT	1.4		CT5FMR
COLT	1.5 (4G15)	92-96	CT6FMR
COLT	1.6	95-02	CT6KMR1
COLT GTI	1.8	93-98	CT6KMR1
GALANT	1600 1.6		CT6FMR
GALANT	2.0	91-95	CT5FMR
GALANT	2.0	91-95	CT6KMR1

MOTOR

L300	1.6		CT5FMR
L300	2.0		CT6FMR
LANCER	1.5 (4G15)	91-96	CT6FMR
LANCER	1.6	01-07	CT6KMR1
LANCER	1.8	94-98	CT6KMR1
SPACEWAGON	1.8 (4G93)		CT6KMR1
SPACEWAGON	2.4	99-02	CT6KMR1

NISSAN

KICKS	1.6 16V (HR16DE)	17->	PIT6LDMR1
MARCH	1.6 16V (HR16DE)	14->	PIT6LDMR1
NOTE	1.6 16V (HR16DE)	15->	PIT6LDMR1
PATHFINDER	3.0I (VG30E)	87-99	CT6KMR1
PATHFINDER	3.3I (VG33E)	96-01	CT6KMR
PICK UP	2.0 Z20	92-95	CT4FM
SENTRA	1.6 (GA16DS)	91-99	CT6KMR
SENTRA	2.0 (SR20DE)	92-97	CT7KMR
SERENA	2.0 (SR20DE)	94-99	CT7KMR
TERRANO	3.3 (VG33E)	95-00	CT6KMR
TIIDA	1.8 16V (MR18DE)	07-15	PIT6LDMR1
VERSA	1.6 16V (HR16DE)	13->	PIT6LDMR1
X-TRAIL	2.5 X4 (QR25DE)	03-08	MT5KMR

PEUGEOT

106	1.1 (HFZ;TU1JP)	00-04	CT6KMR
106	1.4 (KFW;TU3JP/L4)	95-02	CT6KMR
106	1.6 16s		CT6KMR
205	1.4 (K2D;TU32)	91-94	CT6KMR
205	1.4 (KDY;TU3FM kat)	91-99	CT6KMR
205	1.6 (180a yB6A;XU5J)	85-87	CT6KMR
205	1.9 (DFZ;XU9J1kat.)	89-97	CT6KMR
206	1.4 (KFW;TU3JP/L4/FL5)	01-13	CT6KMR
206	1.6 16V (NFU;TU5JP4)	02-09	MT5KMR
206	1.6 (NFZ;TU5JP)	99-03	CT6KMR

MOTOR

206 CC	2.0 S16 (RFN;EW10J4)	01-09	MT5KMR
207	1.4		CT6KMR
207	1.6 (NFZ;TU5JP)	08-13	MT5KMR
207 GTI	1.6 16v THp	08-12	PIT7UHMR
207 CC	1.6 16v THp	08-12	PIT7UHMR
208	1.5		CT6KMR
306	1.6 (NFZ;TU5JP)	95-00	CT6KMR
208 XY	1.6 16v THp	13->	PIT7UHMR
208 GTI	1.6 16v THp	13->	PIT7UHMR
301	1.6 16V VTI (EC5)	17->	MT5KMR
306	1.8 (LFZ) (XU7JPKAT)	98-99	CT6KMR
306	1.816V (LFY;XU7JP4)	97-01	CT6KMR
306	2.0 16V		MT5KMR
306	2.0 (RXF;XU10J2kat)	95-97	CT6KMR
307	1.6 16V (NFU;TU5JP4)	01-12	MT5KMR
307	2.0 16V (RFN;EW10J4)	01-07	MT5KMR
308	2.0 16V		MT5KMR
308 SPORT	1.6 16v THp	13->	PIT7UHMR
308 CC	1.6 16v THp	13->	PIT7UHMR
308 GTI	1.6 16v THp	13->	PIT7UHMR
404			CT5FM
405	1.6 (BFZ;XU5JP)	92-97	CT6KMR
405	1.8 (LFZ;XU7JP kat)	93-03	CT6KMR
405	1.9 (D2H;XU92C)	91-97	CT6KMR
405	2.0 (RFX;XU10J2kat)	91-97	CT6KMR
406	1.8 16V (LFY;XU7JP4)	96-99	CT6KMR
406	2.0 16V (RFR;EW10J4)	99-02	MT5KMR
406	2.2 16V (3FZ;EW12J4)	01-04	MT5KMR
406	3.0 V6 ES9J4- XFZ 194cv	98-00	YD6KMR
407	2.0 16V		MT5KMR
407	2.2 16V (3FZ;EW12J4)	05-10	MT5KMR
408	2.0 16V		MT5KMR
408	1.6 16v THp	08.2011->	PIT7UHMR

MOTOR

504	2.0G (XN2)	83-00	CT5FMR
505	2.0 (106 E;XN1)	83-85	CT6FMR
508	1.6 16v THp	05.2012->	PIT7UHRM
605	2.0 16V (RFV;XU10J4Rkat)	92-97	CT6KMR
605	3.0 24v (XFZ;ES9J4)	92-00	CT6KMR
806	2.0 16V (RFN;EW10J4)	02-06	MT5KMR
806	2.0 8V(RFU;XU10J2)	93-98	CT6KMR
807	2.0 16V		MT5KMR
2008	1.6 16 VTI	16->	MT5KMR
2008	1.6 16V THp	16->	PIT7UHRM
3008	1.6 16v THp	10-13	PIT7UHRM
2008	1.6 16 VTI	16->	MT5KMR
2008	1.6 16V THp	16->	PIT7UHRM
5008	1.6 16V THp	01.2012->	PIT7UHRM
HOOGAR	1.6 16V		MT5KMR
PARTNER	1.4 (KFW;TU3JP)	02->	CT6KMR
PARTNER	1.6 16V (NFU;TU5JP4)	03-05	MT5KMR
PARTNER	1.8 (LFX;XU7JB)	98-03	CT6KMR
RCZ	1.6 16v THp	02.2013->	PIT7UHRM

RENAULT

4	1.0	<-86	CT5EM
5	1.1	<-84	CT5EM
6	1.1	<-82	CT5EM
9	1.4 (C2L)	87-92	CT5FM
9	1.6 C2L-700	93->	CT4FM
11	1.4 C2J-766	86-92	CT5FM
11	1.6 C2L-790	94-95	CT4FM
12	1.4	72-90	CT5EM
12	1.6	89-95	CT5FM
18	1.4	83-91	CT5FM
18	1.6	82-95	CT5FM
18	2.0	83-95	CT6QM

MOTOR

18	2.2	<-94	CT6QM
19	1.6 IC3L-794	93-01	CT4FM
19	1.6 INYECCION (BOBINASECA)	93-01	CT5FMR
19	1.7 INYECCION	94-98	CT6FMR
19	1.8 (F3P 710KAT) INYECCION	95-98	CT6FMR
19	1.8 16V (F7P700 Y704)INY.	93-98	CT7KMR
21	2.2	92-97	CT6QM
CAPTUR	2.0 16V (FAR-712)	16->	CT6KMR
CLIO	1.4 (E7J 756Y 757kat)	92-95	CT6KMR
CLIO	1.6 (C3L)	91-00	CT5FM
CLIO	1.8 (F3P 710KAT)	95-98	CT6FMR
CLIO II	1.2 16V(D4F)	99->	CT5LDMR
CLIO II	1.6 16V (K4M 748)	99-02	CT6KMR1
CLIO II SPORT	2.016V (F4R730Y736)	00-05	CT6KMR
CLIO MIO	1.2 16V (D4F)	99->	CT5LDMR
DUSTER	1.6 16V k4m	11->	CT6KMR1
DUSTER	2.0 16V F4R	11->	CT6KMR1
FLUENCE	1.6 16V k4m	10->	CT6KMR1
FLUENCE	2.0 16V (M4R)	14->	PIT6LDMR1
FUEGO	2.0 (J6R 714Y 715)	81-86	CT6QM
FUEGO	2.2	88-92	CT6QM
KANGOO	1.2 (D7F 720)	01-02	CT6KMR
KANGOO	1.4 (E7J)	98-01	CT6KMR
KANGOO	1.6 16V (K4M706)	03-09	CT6KMR1
KWID	1.0 (B4D-405)	17->	CT5LDMR
LAGUNA	2.0 (F3R 722Y 728)	94-99	CT6FMR
LAGUNA	2.0 16V (F4R780)	98-02	CT6KMR
LAGUNA II	1.8 16V(F4P 770)	98-02	CT6KMR
LATITUD	2.0 16V (M4R)	11-15	PIT6LDMR1
LOGAN	1.6 16V (K4M)	07-10	CT6KMR1
LOGAN	1.6 8V (K7M)	08->	CT6KMR
MEGANE	1.6 (K7M 720)	98-99	CT6KMR
MEGANE	2.0 (F3R 798Y750)	97-03	CT5FMR

MOTOR

MEGANE	2.0 COUPE(F3R 798)	97-03	CT5FMR
MEGANE II	1.6 16V (K4M 700)	00-02	CT6KMR1
MEGANE II	2.0 16V (F4R 770)	05-11	CT6KMR
MEGANE III	2.0 16V (M4R)	11->	PIT6LDMR1
MEGANE COUPE	1.6 16V (K4M700)	00-02	CT6KMR1
MEGANE CABRIO	2.0 16V (F4R770)	05-11	CT6KMR
OROCH	1.6 16V (K4M-842)	16->	CT6KMR1
OROCH	2.0 16V (FAR-712)	16->	CT6KMR
SANDERO	1.6 16V (K4M)	08->	CT6KMR1
SANDERO	1.6 8V (K7M)	09->	CT6KMR
SCENIC	1.6 16V (K4M700)	98-11	CT6KMR1
SCENIC	2.0 F3R 798	98-01	CT5FMR
SYMBOL	1.6 8V	09-14	CT6KMR
SYMBOL	1.6 16V	09-14	CT6KMR1
TRAFIC	1.4	86-97	CT5FM
TRAFIC	1.4 C1J-768	86-97	CT4FM
TRAFIC	2.0		CT6QM
TRAFIC	2.2	88-98	CT6QM
TWINGO	1.2 (D7F 700)	97-03	CT6KMR
TWINGO	1.2 C3G-700	92-00	CT5FMR

ROVER

214	1.4	92-99	CT6KMR
220	2.2	93-97	CT6KMR
420	2.0 TURBO	96-00	CT7KMR
620	2.0 16V TURBO	94-97	CT6KMR
620	2.0 F20Z1	94-97	A6KMR1
623	2.3 H23A3	97-00	A6KMR1
820	2.0 TURBO	92-99	CT7KMR
414 SL	1.4	92-97	CT6KMR
420 DI	2.0	96-00	CT6KMR
820 TI	2.0	92-99	CT6KMR
MAESTRO	1.6		CT7KMR

MOTOR

SAAB			
900	2.0	93-98	CT6FMR
900	2.3	93-99	CT6KMR1
9000	2.3 CD /CS16V	92-99	CT6KMR1
9000 CD	3.0	93-98	YD5KMR1

SEAT			
ALTEA	2.0 TFSI	08-11	PIT7KMR
CORDOBA	1.6(BAH)	00-03	YJT6KMR
CORDOBA	2.0	97-99	YD6KMR
IBIZA	1.6(AKL)	00-05	YD6KMR
LEON	1.6 16V (BSF)	09-13	YD6KMR
LEON	1.8 T 20v	03-06	PPT6KMR
LEON	1.8 TFSI	09-11	PIT7KMR
LEON	2.0 TFSI	08-10	PIT7KMR
MARBELLA	0,9 STD	92-95	CT6FMR
TOLEDO	1.6AEH/AKL	00-02	CJT5FMR1
TOLEDO	1.6ABU	97-00	CJT5FMR1

SUBARU			
IMPREZA	2.0	97-11	CT6KMR1

SUZUKI			
BALENO	1.6	96-02	CT6KMR
BALENO	1.8		CT6KMR1
FUN	1.0 (C10NE) SOHC	03-07	CT6FMR
FUN	1.4EFI (C14NE) SOHC	04-12	CT6FMR
SWIFT	1.3(SA)	92-97	CT5FMR
SWIFT	1.6(EU)	90-96	CT6KMR
VITARA	1.6(616 A)	90-99	CT5FMR
VITARA	1.616V	92-99	CT6KMR

TOYOTA			
CAMRY	3.0 24V	02-06	CT6KMR1
COROLLA	1.816V (1ZZFE)	02-12	CT7KMR

MOTOR

CORONA	2.0	02-03	CT5FMR
CRESSIDA	2.0	83-85	CT5FMR
HI LUX	2.5		CT5FMR
LAND CRUISER	4.0 (22R)		CT5FMR

VOLKSWAGEN

1500	1.5 5V	83-91	CT6FM
BORA	2.0 (APK)	00->	YD6KMR
BORA	1.8 T	2001->	PPT6KMR
CADDY	1.6MI EA827UVC	98-10	CJT5FMR1
CARAT	1.8	87-91	CT6FM
CARAT	2.0	89-92	CT6FM
CC	2.0 TSI	12->	PIT7KMR
CROSSFOX	1.6 (BAH)	05->	YJT6KMR
CROSS UP	1.0 12V (cwr)	17->	AT7DKMR
FOX	1.6 (BAH)	03->	YJT6KMR
FOX	1.6 16V msi	15->	AT7DKMR
GACEL	1.6	83-93	CT5FM
GACEL	1.8	87-94	CT6FMR
GOL	1.0 MIEA111 AFZ	99-03	CJT5FMR1
GOL	1.4	11->	CJT5FMR1
GOL	1.6 MIEA827 UNF	98-11	CJT5FMR1
GOL	1.6 (AP1600;505)	95-98	CT6FMR
GOL	1.8 MIEA827 UDH/UDD	98-03	CJT5FMR1
GOL	1.8 (AP) AUDI	93-95	CT6FMR
GOL	2.0 GTI MI8V (112AP)	91-94	CT7FMR
GOL TREND	1.6	08->	YJT6KMR
GOLF III	1.8 MIABS	96-98	S5KMR
GOLF III	2.0 EA113APK	96-99	S5KMR
GOLF III	2.8 VR6 (AAA)	96-99	CT6KMR
GOLF IV	1.6 (AKL;EA113)	99-02	YD6KMR
GOLF IV	2.0 8V(APK)	90-99	YD6KMR
GOLF IV	2.0 TSI (CCZA)	11.11->	PIT7KMR

MOTOR

GOLF VI GTI	2.0 TSI	12->	PIT7KMR
GOLF VII GTI	2.0 TSI	15->	PIT7KMR
KOMBI / FURGON	1.6	83-90	CT5EM
NEW BEETLE	2.0 (AQY)	03-05	YD6KMR
NEW BEETLE	1.8 T	10-12	PPT6KMR
PASSAT	1.8 (ADR/APT YARG)	98-01	YD6KMR
PASSAT	1.8 T	98-01	PPT6KMR
PASSAT	2.0i ABA	98-99	S5KMR
PASSAT	2.0 T FSI	07-11	PIT7KMR
POINTER	1.6 / 1.8	94-97	CT5FMR
POINTER GTI	2.0	94-97	CT5FMR
POLO	1.6 16V msi	18->	AT7DKMR
POLO CLASSIC	1.6 EA827UVC	01-09	CJT5FMR1
POLO CLASSIC	1.8 MiEA827 USF	01-09	CJT5FMR1
QUANTUM	1.8	<-97	CT5FMR
QUANTUM	2.0 (AUDI)	<-97	CT6FMR
SHARAN II	2.0 Tsi BlueMotion (CCZA)	11.11->	PIT7KMR
SANTANA	2.0	03->	CJT5FMR1
SAVEIRO	1.6 (BAH)	10->	YJT6KMR
SAVEIRO	1.6 (AP)	91-97	CT6FMR
SAVEIRO	1.6 MI EA827UNF	98-10	CJT5FMR1
SCIROCCO	2.0 TSI	11->	PIT7KMR
SENDA	1.6 (AUDI)	89-97	CT6FM
SHARAN	1.8 T	01-11	PPT6KMR
SHARAN	2.0 TSI	11->	PIT7KMR
SURAN	1.0 12V (CWRA)	06.14->	AT7DKMR
SURAN	1.6 16V msi	15->	AT7DKMR
SURAN CROSS	1.6 16V msi	15->	AT7DKMR
T-CROSS	1.6 16V msi	19->	AT7DKMR
THE BEETLE	2.0 TSI	14->	PIT7KMR
TIGUAN	2.0 TSI	08->	PIT7KMR
TOUREG	4.2 (AXQ)	02-09	YJT6KMR
UP	1.0	14->	AT7DKMR

MOTOR

VENTO	2.0 FSI	07->	PIT7KMR
VENTO II	2.0 TSI (CCZA)	04.11->	PIT7KMR
VIRTUS	1.6 16V msi	17->	AT7DKMR
VOYAGE	1.6	08->	YJT6KMR

VOLVO

C30	2.0 (B4204SE)	07->	PPT6QMR3
S40	2.0 (B420S)	97-02	PPT6QMR3
V40	2.0 (B420S)	97-02	PPT6QMR3

Bujías de encendido
Equivalencias por código









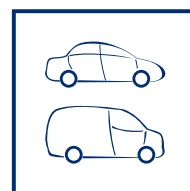

MAGNETI MARELLI	MARCA	DENSO	BOSCH	NGK
A6KMR	FIAT			ZFR6F
A6KMR1	HONDA / KIA / ROVER		FR7LCX +	ZFR5F-11
AT7DKMR	VOLKSWAGEN		Y7LER02	ZKER6A-10EG
CJT5FMR1	SEAT/VW		WR8LTC +	BUR5ETB10
CT4FM	CHEVROLET		W10DC	BP4ES
CT4TM	FORD		D10BC	AP5FS
CT5EM	FIAT/RANAULT		W8BC	BP5HS
CT5FM	FIAT / RANAULT / VW		W8DC	BP5ES
CT5FMR	BMW / CHEVROLET / DAIHATSU / FIAT / FORD		WR8DC	BPR5ES
CT5FMR1	HYUNDAI / ISUZU/KIA / MITSUBISHI / DAEWO / NISSAN		WR8DCX +	BPR5ES-11
CT5LDMR	RENAULT		VR8SC +	LZKAR7A
CT5QMR1	FORD		HR8DCX +	BPR6EFS-10
CT5TMR2	FORD		DR10GCO	APR5FS
CT6FM	FIAT/VW		W7DC	BP6ES
CT6FMR	ALFA ROMEO / CHEVROLET / DAIHATSU / FIAT		WR7DC +	BPR6ES
CT6KMR	ALFA ROMEO / CITROËN / FIAT / HYUNDAI		FR7DC +	BKR6E
CT6KMR1	CHEVROLET / DAIHATSU / HONDA / HYUNDAI		FR7DCX +	BKR6E-11
CT6QHMR1	FORD		HR8MCV +	TR6B10
CT6QM	RENAULT / FORD		H7DC	BP6EFS
CT6TM	FORD		D7BC	AP6FS
CT7DKMR	FIAT		YR7DC+	DCPR8E-N
CT7DKMR3	FIAT		YR7DE	ZKR7B-10
CT7FMR	VOLKSWAGEN		WR6DC +	BPR6ES
CT7KMR	NISSAN / RENAULT / ROVER / TOYOTA		FR6DC +	BKR6E



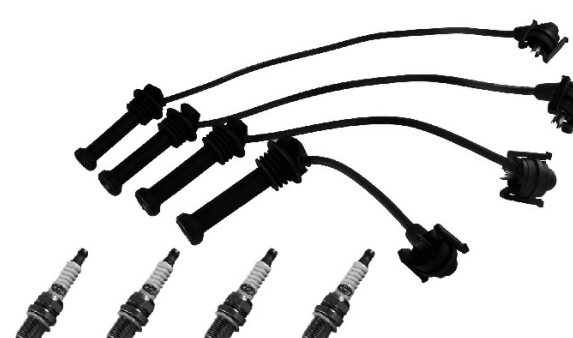

	MARCA	DENSO	BOSCH	NGK
CT8BNMR*	FIAT			LMAR8K-9S
F7QHMR1	FORD		F 000 KE0 P45	LTR7A-10
G6KMR	CHEVROLET		FR7DC+	ZFR6V-G
IT7DKMR1*	FIAT / JEEP			ZKR7BI-10
MT5KMR	CITROËN / NISSAN / PEUGEOT		FR8ME	LFR5B / LFR6B
PIB7LDKMR1	HONDA			SILZKR7C-11DS
PPT6KMR	VOLKSWAGEN		FR7KPP33+	PFR6Q
PIT6KMR1	CHEVROLET	KJ16CR-11		IFR6AD7-D6 / DIFR6B-11D
PIT6LDMR1	NISSAN / RENAULT		0 242 135 524	PLZKAR6A-11
PIT6QHMR	FORD		HR7NII332W	ILTR6H8G
PIT7KMR	AUDI / SEAT / VOLKSWAGEN		FR6KPP332S / FR5KPP332S	PFR7S8EG
PIT7UHMR	PSA		ZR7SI332S	PLZKBR7B8DG
PPT6QHMR1	FORD		HR7KPP33 +	PTR5A13
PPT6QMR3	FORD		HR7MPP302X	PTR6F13 / PTR6D-13G
S5KMR	VOLKSWAGEN		FR8DS	BKR5EKC
YD5KMR1	CHEVROLET / CITROËN / DAEWOO / FIAT / SAAB		FLR8LDCU +	BKR5EK
YD6KMR	AUDI / BMW / FIAT / SEAT / VW		FR7LDC +	BKR6EK
YJT6KMR	VOLKSWAGEN		FLR7HTCO	BKUR5ETC10
YJT6KMR	VOLKSWAGEN		FLR7HTCO	BKUR5ETC10

	MARCA	GAP (mm)
A6KMR	FIAT E-TORQUE	0.9-1.1
A6KMR1	HONDA / KIA / ROVER	0.9-1.1
AT7DKMR	VOLKSWAGEN	0.8-1.0
CJT5FMR1	SEAT / VW	0.9-1.1
CT4FM	CHEVROLETOLET	0.9-1.1
CT4TM	FORD	0.6-0.8
CT5EM	FIAT / RANAULT	0.6-0.8
CT5FM	FIAT / RANAULT / VW	0.6-0.8
CT5FMR	BMW / CHEVROLET / DAIHATSU / FIAT / FORD	0.6-0.8
CT5FMR1	HYUNDAI / ISUZU / KIA / MITSUBISHI / DAEWO / NISSAN	0.9-1.1
CT5LDMR	RENAULT	0.7-0.9
CT5QMR1	FORD	1.0-1.2
CT5TMR2	FORD	1.0-1.2
CT6FM	FIAT / VW	0.6-0.8
CT6FMR	A.ROMEO / CHEVROLET / DAIHATSU / FIAT	0.6-0.8
CT6KMR	A.ROMEO / CITROËN / FIAT / HYUNDAI	0.7-0.9
CT6KMR1	CHEVROLET / DAIHATSU / HONDA / HYUNDAI	0.9-1.1
CT6QHMR1	FORD	0.85-1.05
CT6QM	RENAULT / FORD	0.7-0.9
CT6TM	FORD	0.6-0.8
CT7DKMR	FIAT	0.7-0.9
CT7DKMR3	FIAT	0.85-1.05
CT7FMR	VOLKSWAGEN	0.6-0.8
CT7KMR	NISSAN / RENAULT / ROVER / TOY	0.6-0.8
MT5KMR	CITREN / NISSAN / PEUGEOT	0.75-0.95
PIT6QHMR	FORD	0.9-1.1
PIT7KMR	VOLKSWAGEN TSI	0.7-0.9
PIT7UHMR	PSA	0.7-0.8
PPT6KMR	VOLKSWAGEN	0.7-0.8
PPT6QHMR1	FORD	0.9-1.1
PPT6QMR3	FORD	1.1-1.3
S5KMR	VOLKSWAGEN	0.6-0.8
YD5KMR1	CHEVROLET / CITROËN / DAEWO / FIAT / SAAB	0.9-1.1
YD6KMR	AUDI / BMW / FIAT / SEAT / VW	0.8-1.0
YJT6KMR	VOLKSWAGEN	0.9-1.1

Kits de Encendido
Aplicaciones e imágenes
por Código

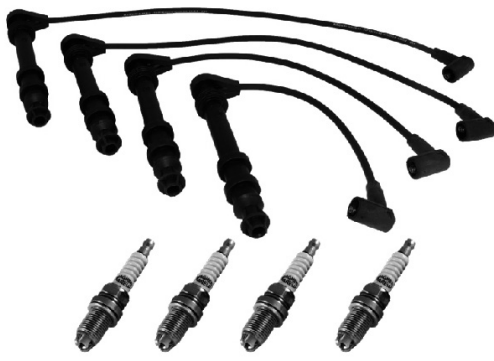
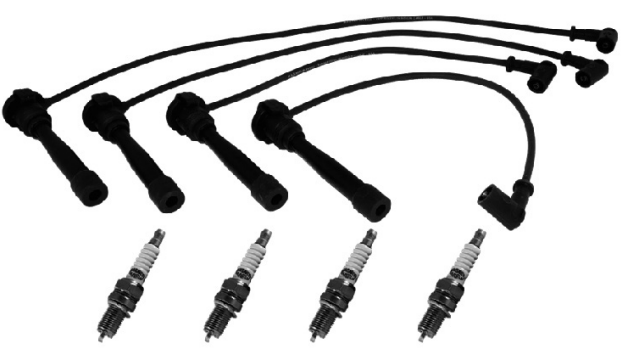

<p>KCB0001 CABLE CC1967MM BUJÍAS X4 YJT6KMR</p> <p>Gol Trend / Voyage / Fox / Suran 1.6 8v EA111 (Bujías de 3 Electrodos)</p> 	<p>KCB0002 CABLE CC1967MM BUJÍAS X4 CT6KMR</p> <p>Gol Trend / Voyage / Fox / Suran 1.6 8v EA111 (Bujías de 1 Electrodo)</p> 
<p>KCB0003 CABLE CC2012MM BUJÍAS X4 CT6FMR</p> <p>Corsa / Fun / Meriva / Montana / Spin 1.4 8V y 1.6 8v</p> 	<p>KCB0004 CABLE CC2019MM BUJÍAS X4 CT6FMR</p> <p>Gol AB9 ap1600 / AP1800 1.6 1999 -> 2006</p> 
<p>KCB0005 CABLE CC2019MM BUJÍAS X4 CT7FMR</p> <p>Gol AB9 ap1600 / AP1800 2.0 1999 -> 2006</p> 	<p>KCB0006 CABLE CC2033MM BUJÍAS X4 YJT6KMR</p> <p>Gol 1.6 8v / Saveiro 1.6 8v / Gol Power 1.4 8v (sin distribuidor) 2008 -></p> 
<p>KCB0007 CABLE CC2053MM BUJÍAS X4 CT6QHMR1</p> <p>Escort / Focus / Mondeo 1.8 16v Zetec</p> 	<p>KCB0008 CABLE CC2059MM BUJÍAS X4 CT6QHMR1</p> <p>Escort / Fiesta / Ecosport / Focus / Ka 1.6 8v Rocam</p> 

<p>KCB0009 CABLE CC2071MM BUJÍAS X4 YD6KMR</p> <p>Palio / Siena 1.6 16V Torque</p> 	<p>KCB0010 CABLE CC2079MM BUJÍAS X4 CT7DKMR</p> <p>Palio / Siena 1.3 16V Fire</p> 
<p>KCB0011 CABLE CC2082MM BUJÍAS X4 CT6KMR</p> <p>Uno / Palio / Siena / Punto 1.4 8V Y 1.3 8V Fire</p> 	<p>KCB0012 CABLE CC2101MM BUJÍAS X4 CT6KMR</p> <p>Kangoo / Clio/ Logan / Sandero 1.6 8v K7M</p> 
<p>KCB0013 CABLE CC2310MM BUJÍAS X4 CT6QHMR1</p> <p>Courier / Ecosport / Fiesta / Focus / Ka 1.6 8v / ZR</p> 	<p>KCB0014 CABLE CC2019MM / BUJÍAS X4 CJT5FMR1</p> <p>Gol 1.6 8v / Saveiro 1.6 8v (con distribuidor) <-2008</p> 



Magneti Marelli Repuestos S.A.
Hipólito Yrigoyen 571 - 8°Piso - B1638BGP
Vicente López - Provincia de Buenos Aires - República Argentina
0800 - 555 - MARELLI (6273554)
aftermarket.argentina@marelli.com
Facebook / Magneti Marelli Argentina
www.marelli-cofap.com.ar



www.marelli-cofap.com.ar

 Magneti Marelli Argentina